

Improving Load Transient Response of DC/DC Converters Powering Controlled Loads

Milos Acanski

ABSTRACT

Many modern systems contain heavy loads such as RF transmitters, LED lights, or time-of-flight cameras, where a DC/DC converter that supplies the system needs to handle heavy load transients when the load is turned on or off. These loads are often controlled, meaning there is a signal that turns them on and off. Keeping the voltage excursions low under such conditions is crucial for a proper operation of the system. However, the same systems often have size, cost, or functional limitations, which prevent some methods for improving the load transient response to be implemented. This application report shows one way of improving the load transient response that can be used when other methods are not effective or possible. This method can be used for a DC/DC converter that supplies a controlled load and uses an external voltage feedback divider.

Contents

1	Introduction	2
2	Feedforwarding the Load Drive Signal.....	3
3	Case Study	3
4	Component Selection	6
5	Conclusion	6
6	References	6

List of Figures

1	Typical Power Supply With a DC/DC Converter.....	2
2	Feedforward Pulse Injection Circuit	3
3	TPS63802 EVM with Added Components to Improve Load Transient Response	4
4	Load Transient Response of the TPS63802 EVM at $V_I = 3.7\text{ V}$, $V_O = 3.3\text{ V}$, $\Delta I_O = 2\text{ A}$	4
5	Load Transient Response of the TPS63802 EVM with Increased C_O	4
6	Load Transient Response of the TPS63802 EVM with Added C_{LEAD}	5
7	Load Transient Response of the TPS63802 EVM with Added Feedforward Pulse Injection.....	5
8	Comparison of Undershoots for the TPS63802 at $\Delta I_O = 2\text{ A}$	6
9	Comparison of Overshoots for the TPS63802 at $\Delta I_O = -2\text{ A}$	6

List of Tables

Trademarks

All trademarks are the property of their respective owners.

1 Introduction

Large load transients are present in a number of applications containing heavy loads such as the following:

- RF transmitters in wireless sensors
- High-brightness LEDs in lighting
- Laser diodes in time-of-flight cameras
- Motors and actuators in mechanical systems

The power supply must keep the voltage excursions small when heavy load transients occur. Otherwise, large voltage excursions can affect the operation of the load and other devices connected to the same voltage supply rail.

Figure 1 shows a typical power supply consisting of a power source, a voltage-feedback DC/DC converter with input and output capacitors, and a load. Consider a load transient and see how it propagates through the system. The first element in the way of the load transient is the output capacitor. DC/DC converters have limited bandwidth and it takes some time until they can react to the step load change. During that time, the output capacitor C_o provides the load current and the output voltage starts to decrease. After some time, the converter starts compensating for the voltage drop. However, the converter itself does not contain a power source, or at least a significant amount of stored energy. To support the load, it relies on the input capacitor C_i for the low impedance short-term supply and the input power source V_s for the continuous power supply.

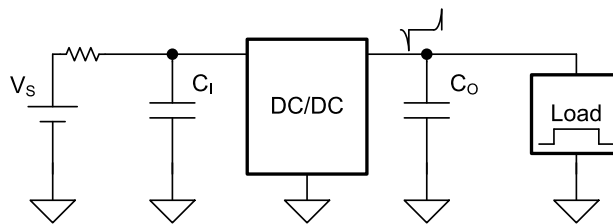

Figure 1. Typical Power Supply With a DC/DC Converter

Assuming that the power source is properly sized, the converter and the output capacitor are the critical parts for a good transient response. The following methods are often used to improve the transient response:

- Increasing the output capacitance – More capacitance on the output means more stored energy to support the load transient until the converter starts to react, leading to lower voltage excursions. It is important to use capacitors with low series resistance and inductance, especially when dealing with very fast load transients. The effect of these parasitic elements on the transient response is described in the [Understanding the Load-Transient Response of LDOs Technical Brief](#). However, adding output capacitance increases the cost and size of the power supply. Moreover, while this method decreases the voltage transients, it typically also reduces the bandwidth and the phase margin, which can lead to an oscillating response.
- Adding a lead-type compensator – A capacitor can be added to the feedback voltage divider to form a lead-type compensator which increases the bandwidth and phase margin. This increases the speed of the converter and decreases the voltage excursions under load transients. This method is described in more detail in the [Optimizing Transient Response of Internally Compensated DC/DC Converters With Feedforward Capacitor Application Report](#). This is a cheap and simple way to improve the transient response, however, there are some limitations. This method works better when the ratio of the resistors in the feedback divider is large, otherwise the effectiveness is limited. Moreover, the added lead compensation is fixed in frequency. The compensator can lose effect, or even cause instability, if the transfer function of the converter changes. An example being when the converter changes the mode of operation. This can happen with the non-inverting buck-boost converter as the battery is being discharged and the converter goes from buck to buck-boost or to boost operating mode.

Other methods can also be used to improve the load transient response, such as dynamic voltage positioning, implementing a load current feedback, or some other type of adaptive control. These are usually implemented internally in the device. The following section shows another method that can be added to almost any DC/DC converter with a voltage feedback input.

2 Feedforwarding the Load Drive Signal

In many cases, loads are controlled, meaning there is a signal used to turn them on or off. For these loads, it is known in advance when the load is going to be turned on or off and cause a load transient. The signal used to control the load can also be used to warn the converter that a load transient is coming. In this way, the converter does not need to wait for the output voltage to drop and can start compensating the voltage excursion in advance.

Typically, DC/DC converters have a resistor voltage divider to sense and regulate the output voltage. Using an external signal, a current can be injected into the feedback node in order to dynamically change the output voltage. The [Dynamically Adjustable Output Using TPS63000 Application Report](#) describes this in more detail. Using the same approach, a current pulse can be injected into the feedback node to compensate for the voltage excursions caused by the load transients. This feedforward pulse can be extracted from the signal that is used to control the load.

Figure 2 shows the added feedforward circuit consisting of a capacitor C_{FF} and resistor R_{FF} . Combined with the feedback resistor divider, C_{FF} and R_{FF} form a differentiator that generates a pulse from the signal V_L used to control the load. The polarity of the injected pulse has to be the same as the polarity of the voltage excursion caused by the load transient. If the load is turned on with a rising edge, causing a negative voltage excursion, the injected pulse must be negative, therefore, formed with a falling edge. In that case, an additional inverter is needed. Otherwise, if there is a spare output pin available in the controller that controls the load, the inverted V_L signal can be directly generated. The series resistor R_{FF} is used to set the amplitude of the injected pulse, whereas C_{FF} determines the pulse width. The exact values for C_{FF} and R_{FF} depend on the circuit parameters, and can be determined empirically. A guideline will be given to determine starting values.

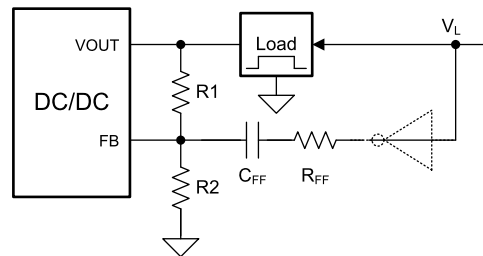

Figure 2. Feedforward Pulse Injection Circuit

3 Case Study

As an example, a non-inverting buck-boost converter TPS63802 will be evaluated for load transients using a Li-ion battery as the power source. The output voltage is set to $V_O = 3.3$ V, which is an often used supply voltage. The input voltage is set to $V_I = 3.7$ V, which is a typical nominal voltage for a Li-ion battery. Figure 3 shows a simplified schematic of the TPS63802 evaluation module (EVM) with added components to improve the transient response using different approaches:

- Increasing the output capacitance C_O
- Adding a lead capacitor C_{LEAD}
- Adding a feedforward circuit consisting of C_{FF} and R_{FF}

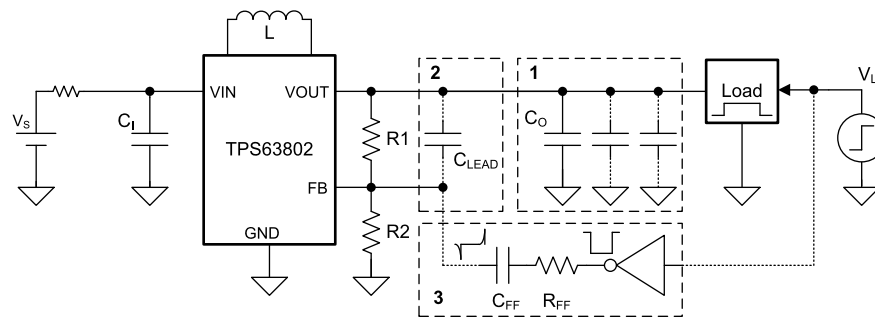

Figure 3. TPS63802 EVM with Added Components to Improve Load Transient Response

Figure 4 shows the load transient response for the unmodified TPS63802 EVM from Figure 3 for 2-A load step with rise time of 100 ns. It can be seen that the voltage undershoot is -410 mV.

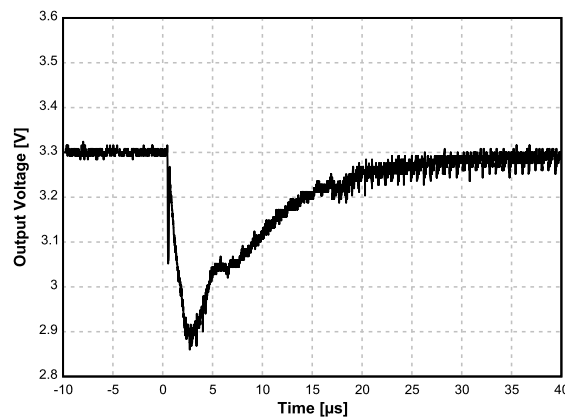

Figure 4. Load Transient Response of the TPS63802 EVM at $V_I = 3.7\text{ V}$, $V_O = 3.3\text{ V}$, $\Delta I_O = 2\text{ A}$

When the output capacitance C_O is increased, the voltage excursions are decreased, as shown in Figure 5. It can be seen that by quadrupling C_O , the undershoot is reduced from -410 mV to -260 mV, and that the response is slowed down when C_O is increased. Therefore, increasing C_O is an effective way to improve the transient response, but at the cost of increased price and solution size.

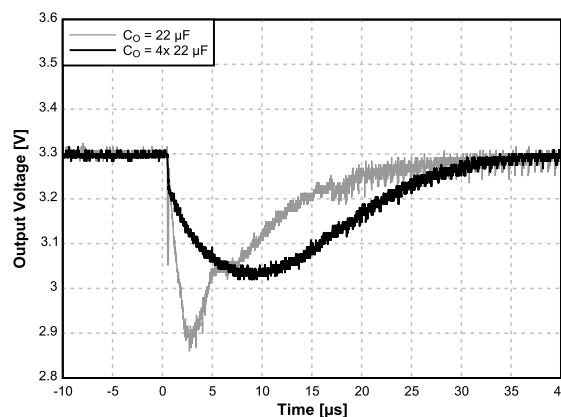

Figure 5. Load Transient Response of the TPS63802 EVM with Increased C_O

When adding C_{LEAD} in parallel to R1 to form a lead compensator, it can be seen that for $C_{LEAD} = 22$ pF, calculated according to the previously mentioned application note, the voltage undershoot is reduced from -400 mV to -340 mV. However, the converter becomes unstable if the input voltage is decreased below 3.7 V, which normally happens when you use a battery as the power source. In this case, the converter changes from buck to buck-boost mode, which changes the converter transfer function. Otherwise, the maximum C_{LEAD} value that keeps the operation stable under all input voltages is around 7 pF. In this case, the voltage undershoot is almost the same as the default response, as shown in Figure 6. Therefore, adding C_{LEAD} to the TPS63802 is not very effective here.

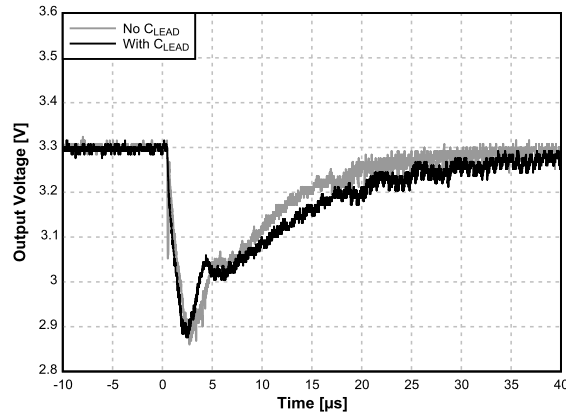

Figure 6. Load Transient Response of the TPS63802 EVM with Added C_{LEAD}

Finally, Figure 7 shows the load transient response of the TPS63802 when the feedforward pulse injection is used. The following values were used, referring to Figure 3: $R_{FF} = 2.2$ M Ω , $C_{FF} = 2.2$ pF, and $V_L = 3.3$ V. The dotted line shows the response when the load control signal V_L is only inverted to form the injection pulse with C_{FF} and R_{FF} . The achieved undershoot is improved and slightly higher, but significantly shorter, when compared to the case shown in Figure 5 where the output capacitance was quadrupled. By advancing the injected pulse in time in regard to the load control signal, which can be done by delaying the load turn-on, the transient response can be further fine-tuned. The solid line shown in Figure 7 shows the transient response when the load turn-on was delayed by 1 μ s behind the injected pulse. It can be seen that the undershoot is almost completely eliminated, leaving behind only a small overshoot.

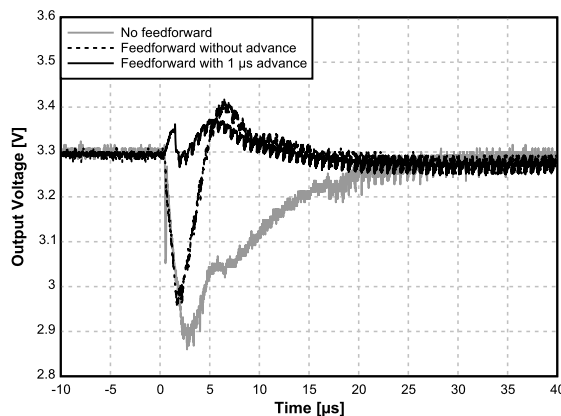

Figure 7. Load Transient Response of the TPS63802 EVM with Added Feedforward Pulse Injection

For the given case study conditions, the resulting voltage undershoots for 2-A load transient are compared in Figure 8. Using the feedforward method with time-shifted pulse injection, the stability of the converter was maintained under all conditions, and the voltage undershoot was decreased when compared to the other methods. Moreover, the same method remains effective when the load is turned off, decreasing the overshoot as shown in Figure 9. Usually, the overshoot when the load is turned off is not that critical for the load operation, as long as the voltage is kept within the recommended operating conditions.

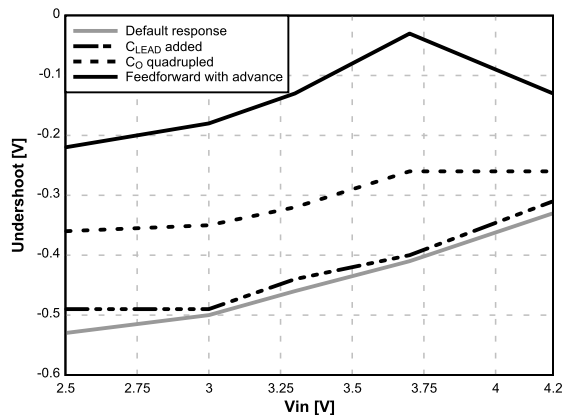

Figure 8. Comparison of Undershoots for the TPS63802 at $\Delta I_o = 2$ A

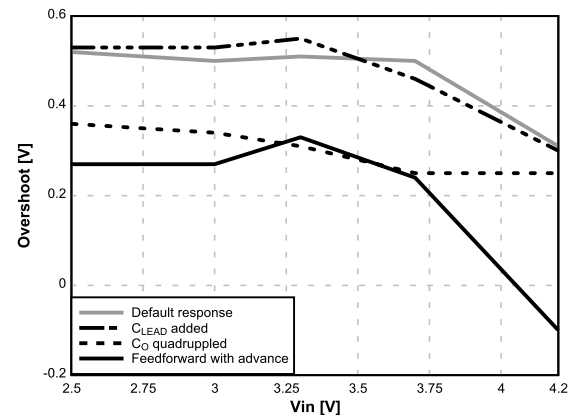

Figure 9. Comparison of Overshoots for the TPS63802 at $\Delta I_o = -2$ A

4 Component Selection

The values for C_{FF} and R_{FF} depend on the converter load transient response, and can be determined by trial and error. A good upper starting value for R_{FF} is:

$$R_{FF} = \frac{V_L}{\Delta V} R1$$

where

- V_L is the load drive signal voltage
- ΔV is the undershoot in the uncompensated load transient response
- $R1$ is the high side resistor of the voltage divider

(1)

Select C_{FF} so that the injected pulse length matches the length of the voltage undershoot. Decrease R_{FF} if necessary until the undershoot is suppressed the most, while changing the C_{FF} to adjust the injected pulse length. Depending on how fast the load current starts to rise after the load is turned off, the injected pulse might need to be advanced in time by delaying the load turn-on, as it was shown in [Figure 7](#).

Note that C_{FF} and R_{FF} form a lag-type compensator together with the resistive feedback divider. However, as long as R_{FF} is much larger than $R1||R2$, the introduced zero and pole will be very close. This has the minimum impact on the converter transfer function, which is not the case for the method when C_{LEAD} is used.

5 Conclusion

This application report shows one approach on how to deal with aggressive load transients when modifying the control loop of the converter or increasing the output capacitance is not an option. This method is limited to controlled loads, when the signal that turns the load on or off is available. The effect can be equal or better than multiplying the output capacitance, with significantly reduced voltage excursions and without affecting the stability of the converter.

6 References

- Texas Instruments, [TPS63802 2-A, High-Efficient, Low \$I_o\$ Buck-Boost Converter with Small Solution Size Data Sheet](#) (SLVSEU9)
- Texas Instruments, [TPS63802 Evaluation Module User's Guide](#) (SLVUBH9)
- Texas Instruments, [Understanding the load-transient response of LDOs Technical Brief](#) (SLYT151)
- Texas Instruments, [Optimizing Transient Response of Internally Compensated DC/DC Converters With Feedforward Capacitor Application Report](#) (SLVA289)

- Texas Instruments, [Dynamically Adjustable Output Using TPS63000 Application Report](#) (SLVA251)

IMPORTANT NOTICE AND DISCLAIMER

TI PROVIDES TECHNICAL AND RELIABILITY DATA (INCLUDING DATASHEETS), DESIGN RESOURCES (INCLUDING REFERENCE DESIGNS), APPLICATION OR OTHER DESIGN ADVICE, WEB TOOLS, SAFETY INFORMATION, AND OTHER RESOURCES "AS IS" AND WITH ALL FAULTS, AND DISCLAIMS ALL WARRANTIES, EXPRESS AND IMPLIED, INCLUDING WITHOUT LIMITATION ANY IMPLIED WARRANTIES OF MERCHANTABILITY, FITNESS FOR A PARTICULAR PURPOSE OR NON-INFRINGEMENT OF THIRD PARTY INTELLECTUAL PROPERTY RIGHTS.

These resources are intended for skilled developers designing with TI products. You are solely responsible for (1) selecting the appropriate TI products for your application, (2) designing, validating and testing your application, and (3) ensuring your application meets applicable standards, and any other safety, security, or other requirements. These resources are subject to change without notice. TI grants you permission to use these resources only for development of an application that uses the TI products described in the resource. Other reproduction and display of these resources is prohibited. No license is granted to any other TI intellectual property right or to any third party intellectual property right. TI disclaims responsibility for, and you will fully indemnify TI and its representatives against, any claims, damages, costs, losses, and liabilities arising out of your use of these resources.

TI's products are provided subject to TI's Terms of Sale (www.ti.com/legal/termsofsale.html) or other applicable terms available either on ti.com or provided in conjunction with such TI products. TI's provision of these resources does not expand or otherwise alter TI's applicable warranties or warranty disclaimers for TI products.

Mailing Address: Texas Instruments, Post Office Box 655303, Dallas, Texas 75265
Copyright © 2019, Texas Instruments Incorporated