

LMV751 Low Noise, Low Vos, Single Op Amp

Check for Samples: [LMV751](#)

FEATURES

- Low Noise $6.5\text{nV}/\sqrt{\text{Hz}}$
- Low V_{OS} (0.05mV typ.)
- Wideband 4.5MHz GBP typ.
- Low Supply Current 500uA typ.
- Low Supply Voltage 2.7V to 5.0V
- Ground-Referenced Inputs
- Unity Gain Stable
- Small Package

APPLICATIONS

- Cellular Phones
- Portable Equipment
- Radio Systems

Connection Diagram

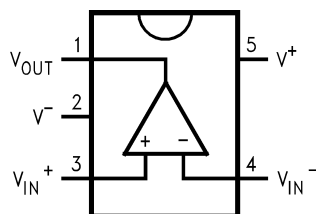
Figure 1. SOT-23-5 Top View

DESCRIPTION

The LMV751 is a high performance CMOS operational amplifier intended for applications requiring low noise and low input offset voltage. It offers modest bandwidth of 4.5MHz for very low supply current and is unity gain stable.

The output stage is able to drive high capacitance, up to 1000pF and source or sink 8mA output current.

It is supplied in the space saving SOT-23-5 Tiny package.

The LMV751 is designed to meet the demands of small size, low power, and high performance required by cellular phones and similar battery operated portable electronics.

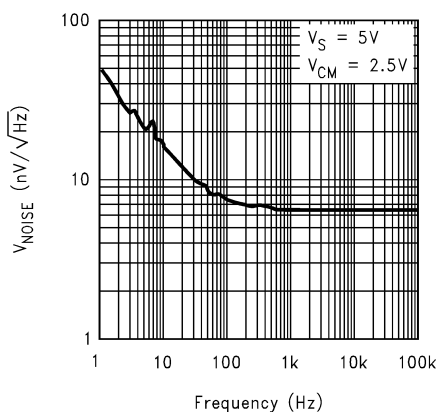
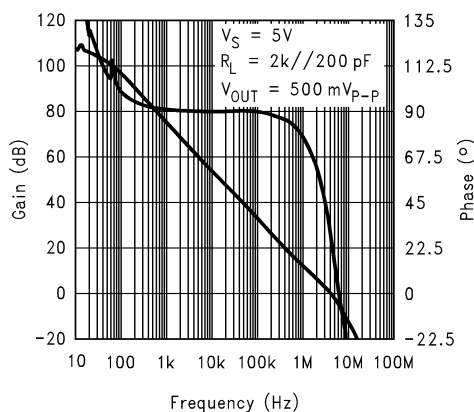
Figure 2. Voltage Noise

Figure 3. Gain/Phase

Please be aware that an important notice concerning availability, standard warranty, and use in critical applications of Texas Instruments semiconductor products and disclaimers thereto appears at the end of this data sheet.

All trademarks are the property of their respective owners.



These devices have limited built-in ESD protection. The leads should be shorted together or the device placed in conductive foam during storage or handling to prevent electrostatic damage to the MOS gates.

Absolute Maximum Ratings ⁽¹⁾⁽²⁾

ESD Tolerance ⁽³⁾	
Human Body Model	2000V
Machine Model	200V
Differential Input Voltage	±Supply Voltage
Supply Voltage ($V^+ - V^-$)	5.5V
Lead Temperature (Soldering, 10 sec.)	260°C
Storage Temperature Range	-65°C to 150°C
Junction Temperature (T_J) ⁽⁴⁾	150°C

- (1) Absolute Maximum Ratings indicate limits beyond which damage to the device may occur. Electrical specifications do not apply when operating the device beyond its rated operating conditions.
- (2) If Military/Aerospace specified devices are required, please contact the Texas Instruments Sales Office/ Distributors for availability and specifications.
- (3) Human body model, 1.5k Ω in series with 100pF. Machine model, 200 Ω in series with 1000pF.
- (4) The maximum power dissipation is a function of $T_{J(MAX)}$, θ_{JA} , and T_A . The maximum allowable power dissipation at any ambient temperature is $P_D = (T_{J(MAX)} - T_A)/\theta_{JA}$. All numbers apply for packages soldered directly into a PC board.

Recommended Operating Conditions

Supply Voltage	2.7V to 5.0V
Temperature Range	-40°C $\leq T_J \leq$ 85°C
Thermal Resistance (θ_{JA}) ⁽¹⁾	
DBV-5 Package, SOT-23-5	274°C/W

- (1) All numbers are typical, and apply to packages soldered directly onto PC board in still air.

2.7V Electrical Characteristics

$V^+ = 2.7V$, $V^- = 0V$, $V_{CM} = 1.35V$, $T_A = 25^\circ C$ unless otherwise stated. **Boldface limits** apply over the Temperature Range.

Symbol	Parameter	Condition	Typ ⁽¹⁾	Limit ⁽²⁾	Units
V_{OS}	Input Offset Voltage		0.05	1.0 1.5	mV max
V_{CM}	Input common-Mode Voltage Range	For CMRR \geq 50dB		0	V min
			1.4	1.3	V max
CMRR	Common Mode Rejection Ratio	$0V < V_{CM} < 1.3V$	100	85 70	dB min
PSRR	Power Supply Rejection Ratio	$V^+ = 2.7V$ to 5.0V	107	85 70	dB min
I_S	Supply Current		0.5	0.8 0.85	mA max
I_{IN}	Input Current		1.5	100	pA max
I_{OS}	Input Offset Current		0.2		pA
A_{VOL}	Voltage Gain	$R_L = 10k$ Connect to $V^+/2$ $V_O = 0.2V$ to 2.2V	120	110 95	dB min
		$R_L = 2k$ Connect to $V^+/2$ $V_O = 0.2V$ to 2.2V	120	100 85	

- (1) Typical values represent the most likely parametric norm.
- (2) All limits are ensured by testing or statistical analysis

2.7V Electrical Characteristics (continued)

$V^+ = 2.7V$, $V^- = 0V$, $V_{CM} = 1.35V$, $T_A = 25^\circ C$ unless otherwise stated. **Boldface limits** apply over the Temperature Range.

Symbol	Parameter	Condition	Typ (1)	Limit (2)	Units
V_O	Positive Voltage Swing	$R_L = 10k$ Connect to $V^+/2$	2.62	2.54 2.52	V min
		$R_L = 2k$ Connect to $V^+/2$	2.62	2.54 2.52	
V_O	Negative Voltage Swing	$R_L = 10k$ Connect to $V^+/2$	78	140 160	mV max
		$R_L = 2k$ Connect to $V^+/2$	78	160 180	
I_O	Output Current	Sourcing, $V_O = 0V$ $V_{IN}(\text{diff}) = \pm 0.5V$	12	6.0 1.5	mA min
		Sinking, $V_O = 2.7V$ $V_{IN}(\text{diff}) = \pm 0.5V$	11	6.0 1.5	
e_n (10Hz)	Input Referred Voltage Noise		15.5		nV/ \sqrt{Hz}
e_n (1kHz)	Input Referred Voltage Noise		7		nV/ \sqrt{Hz}
e_n (30kHz)	Input Referred Voltage Noise		7	10	nV/ \sqrt{Hz} max
I_N (1kHz)	Input Referred Current Noise		0.01		pA/ \sqrt{Hz}
GBW	Gain-Bandwidth Product		4.5	2	MHZ min
SR	Slew Rate		2		V/ μs

5.0V Electrical Characteristics

$V^+ = 5.0V$, $V^- = 0V$, $V_{CM} = 2.5V$, $T_A = 25^\circ C$ unless otherwise stated. **Boldface limits** apply over the Temperature Range.

Symbol	Parameter		Typ (1)	Limit (2)	Units
V_{OS}	Input Offset Voltage		0.05	1.0 1.5	mV max
CMRR	Common Mode Rejection Ratio	$0V < V_{CM} < 3.6V$	103	85 70	dB min
V_{CM}	Input Common-Mode Voltage Range	For CMRR $\geq 50dB$		0	V min
			3.7	3.6	V max
PSRR	Power Supply Rejection Ratio	$V^+ = 2.7V$ to $5.0V$	107	85 70	dB min
I_S	Supply Current		0.6	0.9 0.95	mA max
I_{IN}	Input Current		1.5	100	pA max
I_{OS}	Input offset Current		0.2		pA
A_{VOL}	Voltage Gain	$R_L = 10k$ Connect to $V^+/2$ $V_O = 0.2V$ to $4.5V$	120	110 95	db min
		$R_L = 2k$ Connect to $V^+/2$ $V_O = 0.2V$ to $4.5V$	120	100 85	
V_O	Positive Voltage Swing	$R_L = 10k$ Connect to $V^+/2$	4.89	4.82 4.80	V min
		$R_L = 2k$ Connect to $V^+/2$	4.89	4.82 4.80	
V_O	Negative Voltage Swing	$R_L = 10k$ Connect to $V^+/2$	86	160 180	mV max
		$R_L = 2k$ Connect to $V^+/2$	86	180 200	

(1) Typical values represent the most likely parametric norm.

(2) All limits are ensured by testing or statistical analysis

5.0V Electrical Characteristics (continued)

$V^+ = 5.0V$, $V^- = 0V$, $V_{CM} = 2.5V$, $T_A = 25^\circ C$ unless otherwise stated. **Boldface limits** apply over the Temperature Range.

Symbol	Parameter		Typ (1)	Limit (2)	Units
I_O	Output Current	Sourcing, $V_O = 0V$ $V_{IN} \text{ (diff)} = \pm 0.5V$	15	8.0 2.5	mA min
		Sinking, $V_O = 5V$ $V_{IN} \text{ (diff)} = \pm 0.5V$	20	8.0 2.5	
e_n (10Hz)	Input Referred Voltage Noise		15		nV/ \sqrt{Hz}
e_n (1kHz)	Input Referred Voltage Noise		6.5		nV/ \sqrt{Hz}
e_n (30kHz)	Input Referred Voltage Noise		6.5	10	nV/ \sqrt{Hz} max
I_N (1kHz)	Input Referred Current Noise		0.01		pA/ \sqrt{Hz}
GBW	Gain-Bandwidth Product		5	2	MHz min
SR	Slew Rate		2.3		V/ μ s

Typical Performance Characteristics

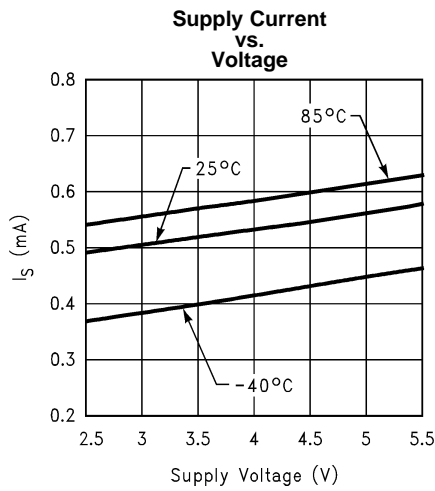

Figure 4.

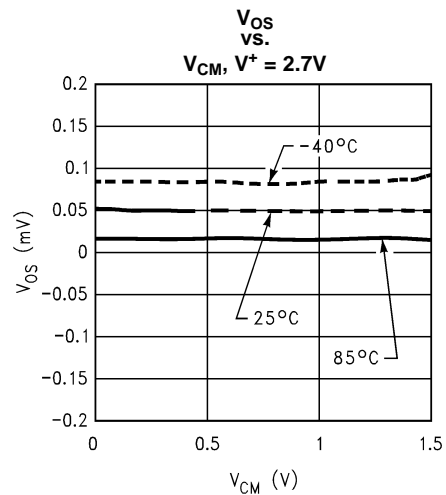

Figure 5.

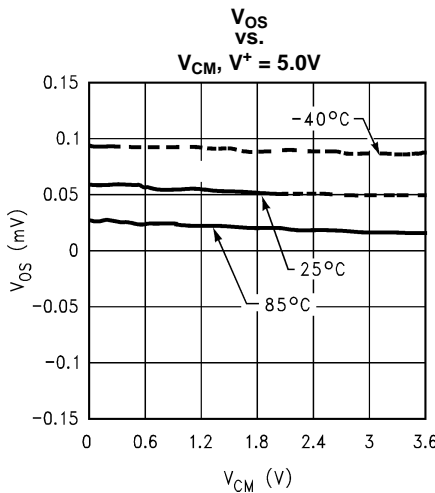

Figure 6.

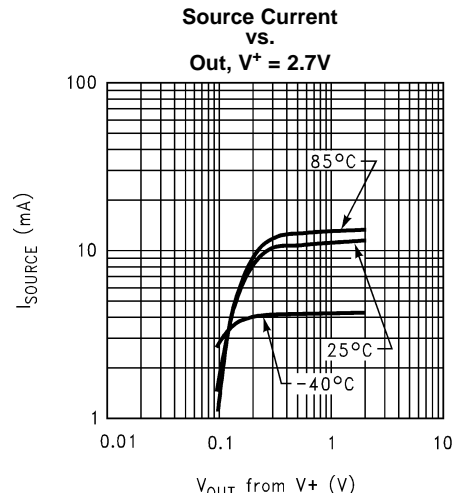

Figure 7.

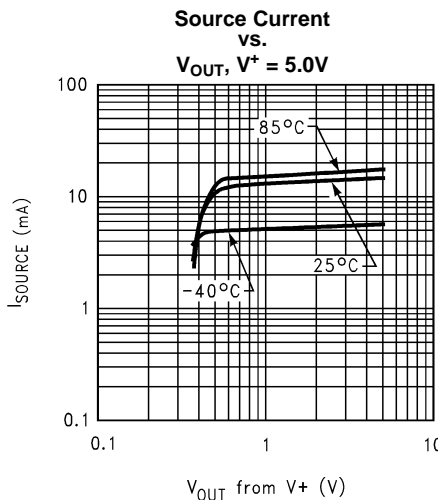

Figure 8.

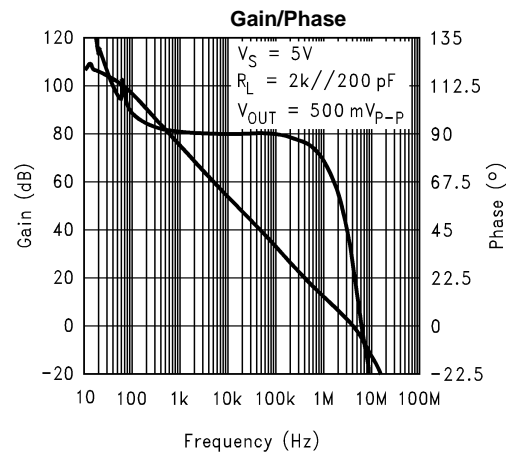
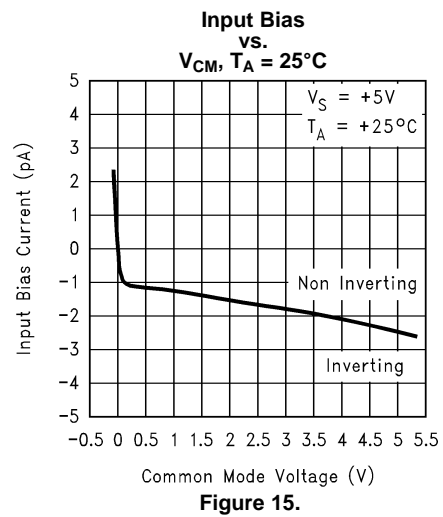
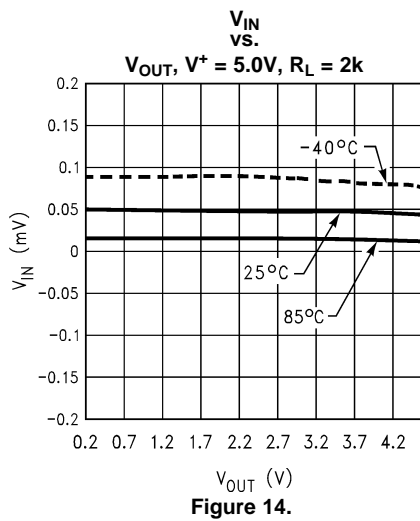
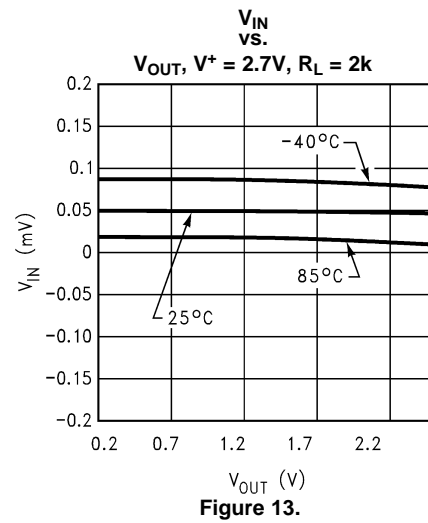
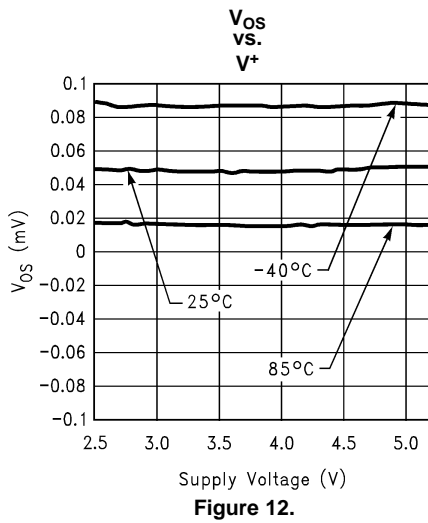
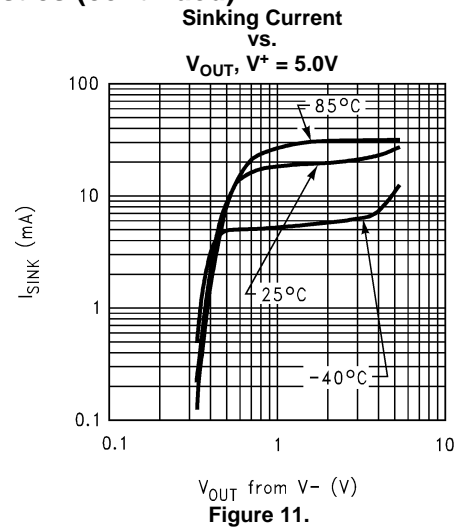
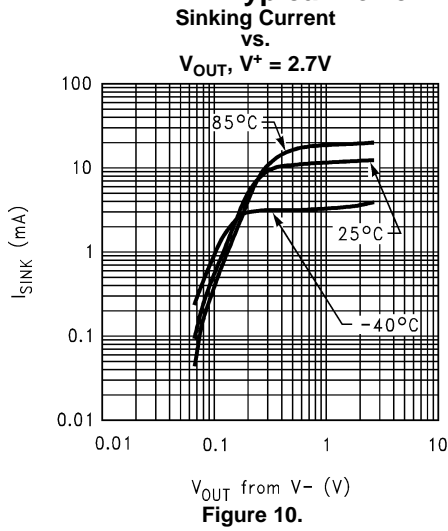

Figure 9.

Typical Performance Characteristics (continued)



Typical Performance Characteristics (continued)

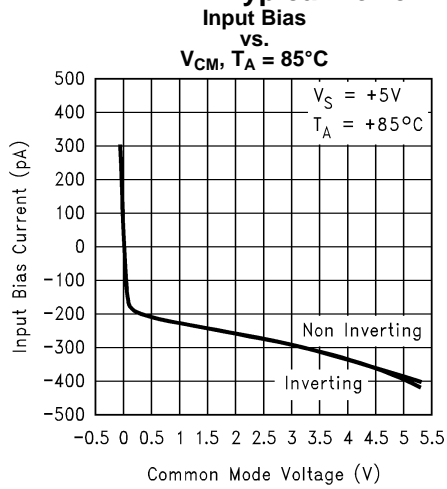

Figure 16.

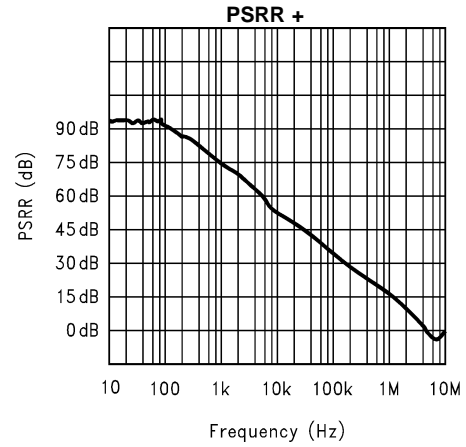

Figure 17.

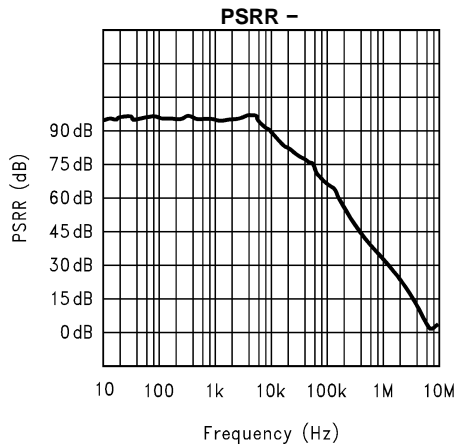

Figure 18.

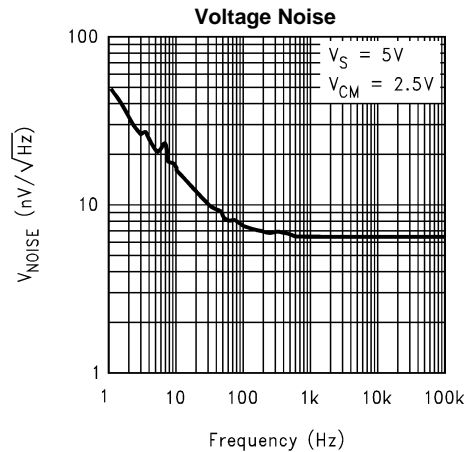

Figure 19.

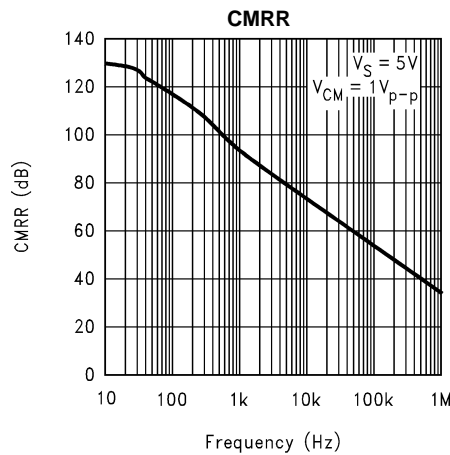

Figure 20.

APPLICATION HINTS

Noise

There are many sources of noise in a system: thermal noise, shot noise, $1/f$, popcorn noise, resistor noise, just to name a few. In addition to starting with a low noise op amp, such as the LMV751, careful attention to detail will result in the lowest overall noise for the system.

To invert or not invert?

Both inverting and non-inverting amplifiers employ feedback to stabilize the closed loop gain of the block being designed. The loop gain (in decibels) equals the algebraic difference between the open loop and closed loop gains. Feedback improves the Total Harmonic Distortion (THD) and the output impedance. The various noise sources, when input referred, are amplified, not by the closed loop gain, but by the noise gain. For a non-inverting amplifier, the noise gain is equal to the closed loop gain, but for an inverting amplifier, the noise gain is equal to the closed loop gain plus one. For large gains, e.g., 100, the difference is negligible, but for small gains, such as one, the noise gain for the inverting amplifier would be two. This implies that non-inverting blocks are preferred at low gains.

Source impedance

Because noise sources are uncorrelated, the system noise is calculated by taking the RMS sum of the various noise sources, that is, the square root of the sum of the squares. At very low source impedances, the voltage noise will dominate; at very high source impedances, the input noise current times the equivalent external resistance will dominate. For a detailed example calculation, refer to [Note 1](#).

Bias current compensation resistor

In CMOS input op amps, the input bias currents are very low, so there is no need to use R_{COMP} (see [Figure 21](#) and [Figure 22](#)) for bias current compensation that would normally be used with early generation bipolar op amps. In fact, inclusion of the resistor would act as another thermal noise source in the system, increasing the overall noise.

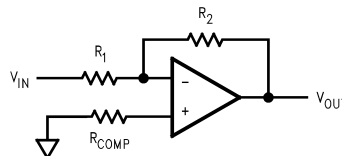

Figure 21. Bias Current Compensation Resistor

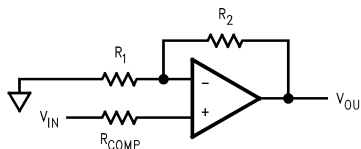

Figure 22. Bias Current Compensation Resistor

Resistor types

Thermal noise is generated by any passive resistive element. This noise is "white"; meaning it has a constant spectral density. Thermal noise can be represented by a mean-square voltage generator e_R^2 in series with a noiseless resistor, where e_R^2 is given by: Where:

$$e_R^2 = 4K TRB \text{ (volts)}^2$$

where

- T = temperature in °K
- R = resistor value in ohms
- B = noise bandwidth in Hz
- K = Boltzmann's constant (1.38×10^{-23} W-sec/°K)

(1)

Actual resistor noise measurements may have more noise than the calculated value. This additional noise component is known as excess noise. Excess noise has a 1/f spectral response, and is proportional to the voltage drop across the resistor. It is convenient to define a noise index when referring to excess noise in resistors. The noise index is the RMS value in μV of noise in the resistor per volt of DC drop across the resistor in a decade of frequency. Noise index expressed in dB is:

$$\text{NI} = 20 \log ((E_{\text{EX}}/V_{\text{DC}}) \times 10^6) \text{ db}$$

where

- E_{EX} = resistor excess noise in μV per frequency decade
 - V_{DC} = DC voltage drop across the resistor
- (2)

Excess noise in carbon composition resistors corresponds to a large noise index of +10 dB to -20 dB. Carbon film resistors have a noise index of -10 dB to -25 dB. Metal film and wire wound resistors show the least amount of excess noise, with a noise index figure of -15 dB to -40 dB.

Other noise sources:

As the op amp and resistor noise sources are decreased, other noise contributors will now be noticeable. Small air currents across thermocouples will result in low frequency variations. Any two dissimilar metals, such as the lead on the IC and the solder and copper foil of the pc board, will form a thermocouple. The source itself may also generate noise. An example would be a resistive bridge. All resistive sources generate thermal noise based on the same equation listed above under "resistor types". (2)

Putting it all together

To a first approximation, the total input referred noise of an op amp is:

$$E_t^2 = e_n^2 + e_{\text{req}}^2 + (i_n \cdot \text{Req})^2$$

where

- Req is the equivalent source resistance at the inputs
- (3)

At low impedances, voltage noise dominates. At high impedances, current noise dominates. With a typical noise current on most CMOS input op amps of $0.01 \text{ pA}/\sqrt{\text{Hz}}$, the current noise contribution will be smaller than the voltage noise for Req less than one megohm.

Other Considerations

Comparator operation

Occasionally operational amplifiers are used as comparators. This is not optimum for the LMV751 for several reasons. First, the LMV751 is compensated for unity gain stability, so the speed will be less than could be obtained on the same process with a circuit specifically designed for comparator operation. Second, op amp output stages are designed to be linear, and will not necessarily meet the logic levels required under all conditions. Lastly, the LMV751 has the newer PNP-NPN common emitter output stage, characteristic of many rail-to-rail output op amps. This means that when used in open loop applications, such as comparators, with very light loads, the output PNP will saturate, with the output current being diverted into the previous stage. As a result, the supply current will increase to the 20-30 mA. range. When used as a comparator, a resistive load between $2\text{k}\Omega$ and $10\text{k}\Omega$ should be used with a small amount of hysteresis to alleviate this problem. When used as an op amp, the closed loop gain will drive the inverting input to within a few millivolts of the non-inverting input. This will automatically reduce the output drive as the output settles to the correct value; thus it is only when used as a comparator that the current will increase to the tens of milliampere range.

Rail-to-Rail

Because of the output stage discussed above, the LMV751 will swing "rail-to-rail" on the output. This normally means within a few hundred millivolts of each rail with a reasonable load. Referring to the [Electrical Characteristics](#) table for 2.7V to 5.0V, it can be seen that this is true for resistive loads of $2\text{k}\Omega$ and $10\text{k}\Omega$. The input stage consists of cascoded P-channel MOSFETS, so the input common mode range includes ground, but typically requires 1.2V to 1.3V headroom from the positive rail. This is better than the industry standard LM324 and LM358 that have PNP input stages, and the LMV751 has the advantage of much lower input bias currents.

Loading

The LMV751 is a low noise, high speed op amp with excellent phase margin and stability. Capacitive loads up to 1000 pF can be handled, but larger capacitive loads should be isolated from the output. The most straightforward way to do this is to put a resistor in series with the output. This resistor will also prevent excess power dissipation if the output is accidentally shorted.

General Circuits

With the low noise and low input bias current, the LMV751 would be useful in active filters, integrators, current to voltage converters, low frequency sine wave generators, and instrumentation amplifiers. (3)

NOTE

1. Sherwin, Jim “Noise Specs Confusing?” AN-104 ([SNVA515](#)), Texas Instruments.
 2. Christensen, John, “Noise-figure curve ease the selection of low-noise op amps”, EDN, pp 81-84, Aug. 4, 1994.
 3. “Op Amp Circuit Collection”, AN-31 ([SNLA140](#)), Texas Instruments.
-

REVISION HISTORY

Changes from Revision D (March 2013) to Revision E	Page
<hr/> <ul style="list-style-type: none">• Changed layout of National Data Sheet to TI format	<hr/> 10

PACKAGING INFORMATION

Orderable Device	Status (1)	Package Type	Package Drawing	Pins	Package Qty	Eco Plan (2)	Lead/Ball Finish (6)	MSL Peak Temp (3)	Op Temp (°C)	Device Marking (4/5)	Samples
LMV751M5	NRND	SOT-23	DBV	5	1000	TBD	Call TI	Call TI	-40 to 85	A32A	
LMV751M5/NOPB	ACTIVE	SOT-23	DBV	5	1000	Green (RoHS & no Sb/Br)	CU SN	Level-1-260C-UNLIM	-40 to 85	A32A	Samples
LMV751M5X/NOPB	ACTIVE	SOT-23	DBV	5	3000	Green (RoHS & no Sb/Br)	CU SN	Level-1-260C-UNLIM	-40 to 85	A32A	Samples

(1) The marketing status values are defined as follows:

ACTIVE: Product device recommended for new designs.

LIFEBUY: TI has announced that the device will be discontinued, and a lifetime-buy period is in effect.

NRND: Not recommended for new designs. Device is in production to support existing customers, but TI does not recommend using this part in a new design.

PREVIEW: Device has been announced but is not in production. Samples may or may not be available.

OBSOLETE: TI has discontinued the production of the device.

(2) **RoHS:** TI defines "RoHS" to mean semiconductor products that are compliant with the current EU RoHS requirements for all 10 RoHS substances, including the requirement that RoHS substance do not exceed 0.1% by weight in homogeneous materials. Where designed to be soldered at high temperatures, "RoHS" products are suitable for use in specified lead-free processes. TI may reference these types of products as "Pb-Free".

RoHS Exempt: TI defines "RoHS Exempt" to mean products that contain lead but are compliant with EU RoHS pursuant to a specific EU RoHS exemption.

Green: TI defines "Green" to mean the content of Chlorine (Cl) and Bromine (Br) based flame retardants meet JS709B low halogen requirements of <=1000ppm threshold. Antimony trioxide based flame retardants must also meet the <=1000ppm threshold requirement.

(3) MSL, Peak Temp. - The Moisture Sensitivity Level rating according to the JEDEC industry standard classifications, and peak solder temperature.

(4) There may be additional marking, which relates to the logo, the lot trace code information, or the environmental category on the device.

(5) Multiple Device Markings will be inside parentheses. Only one Device Marking contained in parentheses and separated by a "~" will appear on a device. If a line is indented then it is a continuation of the previous line and the two combined represent the entire Device Marking for that device.

(6) Lead/Ball Finish - Orderable Devices may have multiple material finish options. Finish options are separated by a vertical ruled line. Lead/Ball Finish values may wrap to two lines if the finish value exceeds the maximum column width.

Important Information and Disclaimer:The information provided on this page represents TI's knowledge and belief as of the date that it is provided. TI bases its knowledge and belief on information provided by third parties, and makes no representation or warranty as to the accuracy of such information. Efforts are underway to better integrate information from third parties. TI has taken and continues to take reasonable steps to provide representative and accurate information but may not have conducted destructive testing or chemical analysis on incoming materials and chemicals. TI and TI suppliers consider certain information to be proprietary, and thus CAS numbers and other limited information may not be available for release.

In no event shall TI's liability arising out of such information exceed the total purchase price of the TI part(s) at issue in this document sold by TI to Customer on an annual basis.

TAPE AND REEL INFORMATION



QUADRANT ASSIGNMENTS FOR PIN 1 ORIENTATION IN TAPE



*All dimensions are nominal

Device	Package Type	Package Drawing	Pins	SPQ	Reel Diameter (mm)	Reel Width W1 (mm)	A0 (mm)	B0 (mm)	K0 (mm)	P1 (mm)	W (mm)	Pin1 Quadrant
LMV751M5	SOT-23	DBV	5	1000	178.0	8.4	3.2	3.2	1.4	4.0	8.0	Q3
LMV751M5/NOPB	SOT-23	DBV	5	1000	178.0	8.4	3.2	3.2	1.4	4.0	8.0	Q3
LMV751M5X/NOPB	SOT-23	DBV	5	3000	178.0	8.4	3.2	3.2	1.4	4.0	8.0	Q3

TAPE AND REEL BOX DIMENSIONS

*All dimensions are nominal

Device	Package Type	Package Drawing	Pins	SPQ	Length (mm)	Width (mm)	Height (mm)
LMV751M5	SOT-23	DBV	5	1000	210.0	185.0	35.0
LMV751M5/NOPB	SOT-23	DBV	5	1000	210.0	185.0	35.0
LMV751M5X/NOPB	SOT-23	DBV	5	3000	210.0	185.0	35.0



DBV0005A

PACKAGE OUTLINE

SOT-23 - 1.45 mm max height

SMALL OUTLINE TRANSISTOR

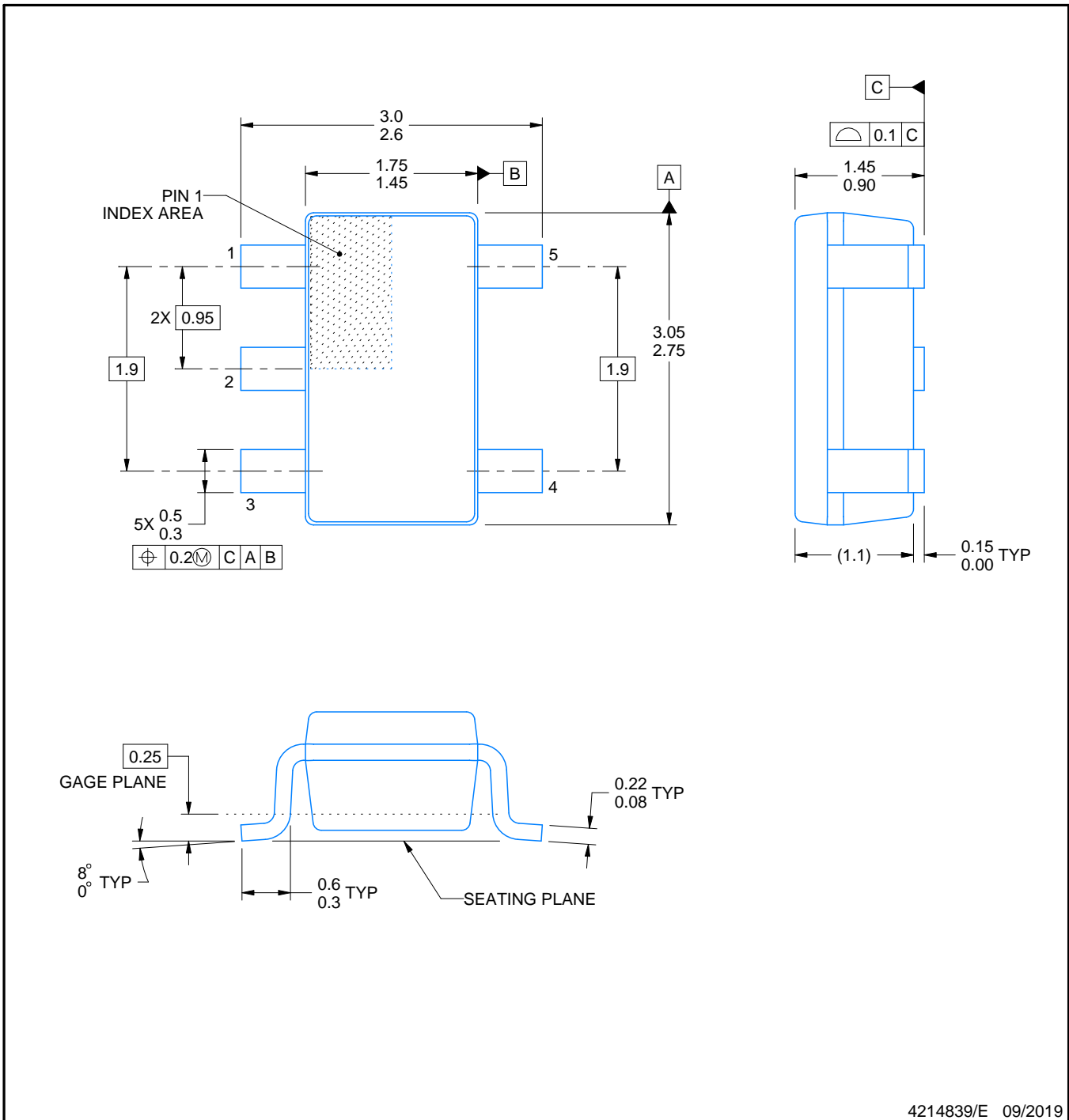

4214839/E 09/2019

NOTES:

1. All linear dimensions are in millimeters. Any dimensions in parenthesis are for reference only. Dimensioning and tolerancing per ASME Y14.5M.
2. This drawing is subject to change without notice.
3. Reference JEDEC MO-178.
4. Body dimensions do not include mold flash, protrusions, or gate burrs. Mold flash, protrusions, or gate burrs shall not exceed 0.15 mm per side.

EXAMPLE BOARD LAYOUT

DBV0005A

SOT-23 - 1.45 mm max height

SMALL OUTLINE TRANSISTOR



LAND PATTERN EXAMPLE
EXPOSED METAL SHOWN
SCALE:15X



SOLDER MASK DETAILS

4214839/E 09/2019

NOTES: (continued)

- 5. Publication IPC-7351 may have alternate designs.
- 6. Solder mask tolerances between and around signal pads can vary based on board fabrication site.

EXAMPLE STENCIL DESIGN

DBV0005A

SOT-23 - 1.45 mm max height

SMALL OUTLINE TRANSISTOR



SOLDER PASTE EXAMPLE
BASED ON 0.125 mm THICK STENCIL
SCALE:15X

4214839/E 09/2019

NOTES: (continued)

7. Laser cutting apertures with trapezoidal walls and rounded corners may offer better paste release. IPC-7525 may have alternate design recommendations.
8. Board assembly site may have different recommendations for stencil design.

IMPORTANT NOTICE AND DISCLAIMER

TI PROVIDES TECHNICAL AND RELIABILITY DATA (INCLUDING DATASHEETS), DESIGN RESOURCES (INCLUDING REFERENCE DESIGNS), APPLICATION OR OTHER DESIGN ADVICE, WEB TOOLS, SAFETY INFORMATION, AND OTHER RESOURCES "AS IS" AND WITH ALL FAULTS, AND DISCLAIMS ALL WARRANTIES, EXPRESS AND IMPLIED, INCLUDING WITHOUT LIMITATION ANY IMPLIED WARRANTIES OF MERCHANTABILITY, FITNESS FOR A PARTICULAR PURPOSE OR NON-INFRINGEMENT OF THIRD PARTY INTELLECTUAL PROPERTY RIGHTS.

These resources are intended for skilled developers designing with TI products. You are solely responsible for (1) selecting the appropriate TI products for your application, (2) designing, validating and testing your application, and (3) ensuring your application meets applicable standards, and any other safety, security, or other requirements. These resources are subject to change without notice. TI grants you permission to use these resources only for development of an application that uses the TI products described in the resource. Other reproduction and display of these resources is prohibited. No license is granted to any other TI intellectual property right or to any third party intellectual property right. TI disclaims responsibility for, and you will fully indemnify TI and its representatives against, any claims, damages, costs, losses, and liabilities arising out of your use of these resources.

TI's products are provided subject to TI's Terms of Sale (www.ti.com/legal/termsofsale.html) or other applicable terms available either on ti.com or provided in conjunction with such TI products. TI's provision of these resources does not expand or otherwise alter TI's applicable warranties or warranty disclaimers for TI products.

Mailing Address: Texas Instruments, Post Office Box 655303, Dallas, Texas 75265
Copyright © 2019, Texas Instruments Incorporated