

具有清零和预设功能的 SN74LVC2G74 单路上升沿触发式 D 类触发器

1 特性

- 采用德州仪器 (TI) NanoFree™ 封装
- 支持 5V V_{CC} 运行
- 输入电压高达 5.5V
- 3.3V 时 t_{pd} 最大值为 5.9ns
- 低功耗, I_{CC} 最大值为 10 μ A
- 3.3V 时的输出驱动为 ± 24 mA
- V_{OLP} (输出接地反弹) 典型值小于 0.8V ($V_{CC} = 3.3V$ 、 $T_A = 25^\circ C$ 时)
- V_{OHV} (输出 V_{OH} 下冲) 典型值大于 2V ($V_{CC} = 3.3V$ 、 $T_A = 25^\circ C$ 时)
- I_{off} 支持带电插入、局部关断模式和后驱动保护
- 闩锁性能超过 100mA, 符合 JESD 78 II 类规范的要求
- ESD 保护性能超过 JESD 22 规范要求
 - 2000V 人体放电模型
 - 200V 机器放电模型
 - 1000V 充电器件模型

2 应用

- 服务器
- LED 显示屏
- 网络交换机
- 电信基础设施
- 电机驱动器
- I/O 扩展器

3 说明

这款单路上升沿触发 D 类触发器需在 1.65V 至 5.5V V_{CC} 下运行。

NanoFree™ 封装技术是 IC 封装概念的一项重大突破, 它将硅晶片用作封装。

预设 (\overline{PRE}) 或清零 (\overline{CLR}) 输入端的低电平将会设置或重置输出, 而不受其他输入端的电平的影响。当 \overline{PRE} 和 \overline{CLR} 处于非活动状态 (高电平) 时, 数据 (D) 输入处满足设置时间要求的数据将传输到时钟脉冲正向缘上的输出端。时钟触发在一定电压电平下发生, 与时钟脉冲的上升时间没有直接关系。经过保持时间间隔后, 可以更改 D 输入端的数据而不影响输出端的电平。

该器件完全符合使用 I_{off} 的部分断电应用的规范要求。 I_{off} 电路禁用输出, 从而可防止其断电时破坏性电流从该器件回流。

器件信息⁽¹⁾

器件型号	封装	封装尺寸
SN74LVC2G74	SM8 (8)	2.95mm × 2.80mm
	VSSOP (8)	2.30mm × 2.00mm
	DSBGA (8)	1.91mm × 0.91mm

(1) 如需了解所有可用封装, 请参阅数据表末尾的可订购产品附录。

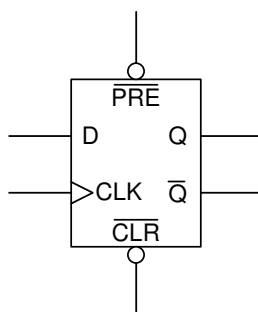

简化版原理图



Table of Contents

1 特性	1	8.1 Overview.....	10
2 应用	1	8.2 Functional Block Diagram.....	10
3 说明	1	8.3 Feature Description.....	10
4 Revision History	2	8.4 Device Functional Modes.....	10
5 Pin Configuration and Functions	3	9 Application and Implementation	11
6 Specifications	4	9.1 Application Information.....	11
6.1 Absolute Maximum Ratings.....	4	9.2 Typical Power Button Circuit.....	11
6.2 ESD Ratings.....	4	10 Power Supply Recommendations	12
6.3 Recommended Operating Conditions.....	5	11 Layout	13
6.4 Thermal Information.....	5	11.1 Layout Guidelines.....	13
6.5 Electrical Characteristics.....	6	11.2 Layout Example.....	13
6.6 Timing Requirements, -40°C to +85°C.....	6	12 Device and Documentation Support	14
6.7 Timing Requirements, -40°C to +125°C.....	6	12.1 接收文档更新通知.....	14
6.8 Switching Characteristics, -40°C to +85°C.....	7	12.2 支持资源.....	14
6.9 Switching Characteristics, -40°C to +125°C.....	7	12.3 Trademarks.....	14
6.10 Operating Characteristics.....	7	12.4 Electrostatic Discharge Caution.....	14
6.11 Typical Characteristics.....	8	12.5 术语表.....	14
7 Parameter Measurement Information	9	13 Mechanical, Packaging, and Orderable Information	14
8 Detailed Description	10		

4 Revision History

注：以前版本的页码可能与当前版本的页码不同

Changes from Revision P (July 2016) to Revision Q (September 2021)	Page
• 更新了整个文档中的表格、图和交叉参考的编号格式.....	1
• Updated the <i>Application and Information</i> section.....	11
• Updated the <i>Device Power Button Circuit</i> figure in the <i>Typical Power Button Circuit</i> section.....	11
Changes from Revision O (January 2015) to Revision P (July 2016)	Page
• 将器件信息表中的 SSOP 更改为 SM8.....	1
• Updated pinout images to new format.....	3
• Added pin number for DSBGA package in <i>Pin Functions</i> table.....	3
• Changed 6 PINS to 8 PINS in <i>Thermal Information</i> table.....	5
• Changed 23 to 2.3 for t_{su} data in <i>Timing Requirements, -40°C to +125°C</i>	6
Changes from Revision N (July 2013) to Revision O (January 2015)	Page
• 添加了应用、器件信息表、引脚功能表、ESD 等级表、热性能信息表、典型特性、特性说明部分、器件功能模式、应用和实施部分、电源相关建议部分、布局部分、器件和文档支持部分以及机械、封装和可订购信息部分.....	1
Changes from Revision M (February 2007) to Revision N (July 2013)	Page
• 更改了特性中的 I_{off} 说明.....	1
• Added parameter values for -40 to +125°C temperature ratings in <i>Electrical Characteristics</i> table.....	6
• Changed <i>Timing Requirements, -40°C to +85°C</i> table.....	6
• Added <i>Timing Requirements, -40°C to +125°C</i> table.....	6
• Changed <i>Switching Characteristics, -40°C to +85°C</i> table.....	7
• Added <i>Switching Characteristics, -40°C to +125°C</i> table.....	7

5 Pin Configuration and Functions

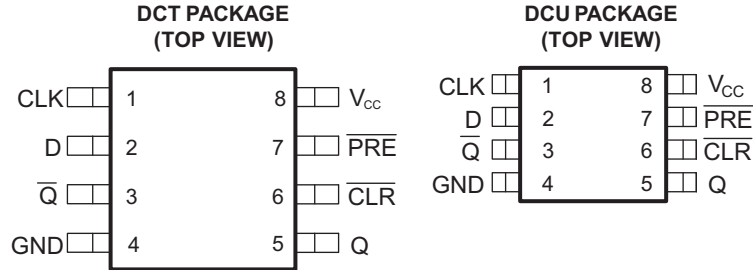

See mechanical drawings for dimensions.

图 5-1. DCT 8-Pin SM8 and DCU 8-Pin VSSOP Package Top View

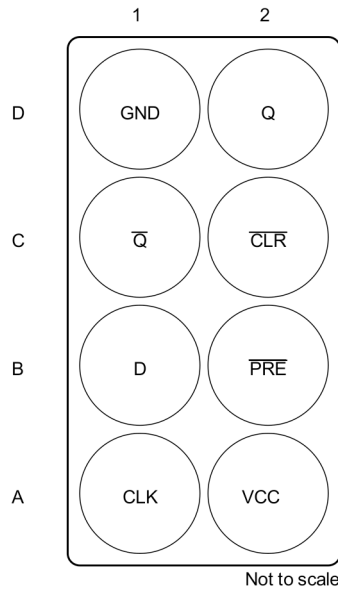

See mechanical drawings for dimensions.

图 5-2. YZP Package 8-Pin DSBGA Bottom View

表 5-1. Pin Functions

NAME	PIN		TYPE	DESCRIPTION
	VSSOP, SM8	DSBGA		
CLK	1	A1	I	Clock input
CLR	6	C2	I	Clear input - Pull low to set Q output low
D	2	B1	I	Input
GND	4	D1	—	Ground
PRE	7	B2	I	Preset input - Pull low to set Q output high
Q	5	D2	O	Output
Q̄	3	C1	O	Inverted output
V _{CC}	8	A2	—	Supply

6 Specifications

6.1 Absolute Maximum Ratings

over operating free-air temperature range (unless otherwise noted)⁽¹⁾

		MIN	MAX	UNIT
V _{CC}	Supply voltage	- 0.5	6.5	V
V _I	Input voltage ⁽²⁾	- 0.5	6.5	V
V _O	Voltage range applied to any output in the high-impedance or power-off state ⁽²⁾	- 0.5	6.5	V
V _O	Voltage range applied to any output in the high or low state ^{(2) (3)}	- 0.5	V _{CC} + 0.5	V
I _{IK}	Input clamp current	V _I < 0	- 50	mA
I _{OK}	Output clamp current	V _O < 0	- 50	mA
I _O	Continuous output current		±50	mA
	Continuous current through V _{CC} or GND		±100	mA
T _{stg}	Storage temperature	- 65	150	°C

- (1) Stresses beyond those listed under *Absolute Maximum Ratings* may cause permanent damage to the device. These are stress ratings only, and functional operation of the device at these or any other conditions beyond those indicated under [# 6.3](#) is not implied. Exposure to absolute-maximum-rated conditions for extended periods may affect device reliability.
- (2) The input negative-voltage and output voltage ratings may be exceeded if the input and output clamp-current ratings are observed.
- (3) The value of V_{CC} is provided in [# 6.3](#) table.

6.2 ESD Ratings

PARAMETER	DEFINITION	VALUE	UNIT	
V _(ESD)	Electrostatic discharge	Human body model (HBM), per ANSI/ESDA/JEDEC JS-001, all pins ⁽¹⁾	2000	V
		Charged device model (CDM), per JEDEC specification JESD22-C101, all pins ⁽²⁾	1000	

- (1) JEDEC document JEP155 states that 500-V HBM allows safe manufacturing with a standard ESD control process.
- (2) JEDEC document JEP157 states that 250-V CDM allows safe manufacturing with a standard ESD control process.

6.3 Recommended Operating Conditions

over operating free-air temperature range (unless otherwise noted)⁽¹⁾

			MIN	MAX	UNIT
V _{CC}	Supply voltage	Operating	1.65	5.5	V
		Data retention only	1.5		
V _{IH}	High-level input voltage	V _{CC} = 1.65 V to 1.95 V	0.65 × V _{CC}		V
		V _{CC} = 2.3 V to 2.7 V	1.7		
		V _{CC} = 3 V to 3.6 V	2		
		V _{CC} = 4.5 V to 5.5 V	0.7 × V _{CC}		
V _{IL}	Low-level input voltage	V _{CC} = 1.65 V to 1.95 V		0.35 × V _{CC}	V
		V _{CC} = 2.3 V to 2.7 V		0.7	
		V _{CC} = 3 V to 3.6 V		0.8	
		V _{CC} = 4.5 V to 5.5 V		0.3 × V _{CC}	
V _I	Input voltage		0	5.5	V
V _O	Output voltage		0	V _{CC}	V
I _{OH}	High-level output current	V _{CC} = 1.65 V		-4	mA
		V _{CC} = 2.3 V		-8	
		V _{CC} = 3 V		-16	
		V _{CC} = 4.5 V		-24	
I _{OL}	Low-level output current	V _{CC} = 1.65 V		4	mA
		V _{CC} = 2.3 V		8	
		V _{CC} = 3 V		16	
		V _{CC} = 4.5 V		24	
Δt/Δv	Input transition rise or fall rate	V _{CC} = 1.8 V ± 0.15 V, 2.5 V ± 0.2 V		20	ns/V
		V _{CC} = 3.3 V ± 0.3 V		10	
		V _{CC} = 5 V ± 0.5 V		5	
T _A	Operating free-air temperature		-40	125	°C

(1) All unused inputs of the device must be held at V_{CC} or GND to ensure proper device operation. See *Implications of Slow or Floating CMOS Inputs*, SCBA004.

6.4 Thermal Information

THERMAL METRIC ⁽¹⁾	SN74LVC2G74			UNIT	
	DCT	DCU	YZP		
	8 PINS				
R _{θJA}	Junction-to-ambient thermal resistance ⁽²⁾	220	227	102	°C/W

(1) For more information about traditional and new thermal metrics, see the *Semiconductor and IC Package Thermal Metrics* application report.

(2) The package thermal impedance is calculated in accordance with JESD 51-7.

6.5 Electrical Characteristics

over recommended operating free-air temperature range (unless otherwise noted)

PARAMETER	TEST CONDITIONS	V _{CC}	- 40°C to +85°C			- 40°C to +125°C			UNIT
						Recommended			
			MIN	TYP ⁽¹⁾	MAX	MIN	TYP	MAX	
V _{OH}	I _{OH} = - 100 μA	1.65 V to 5.5 V	V _{CC} - 0.1			V _{CC} - 0.1			V
	I _{OH} = - 4 mA	1.65 V	1.2			1.2			
	I _{OH} = - 8 mA	2.3 V	1.9			1.85			
	I _{OH} = - 16 mA	3 V	2.4			2.4			
	I _{OH} = - 24 mA		2.3			2.3			
	I _{OH} = - 32 mA	4.5 V	3.8			3.8			
V _{OL}	I _{OL} = 100 μA	1.65 V to 5.5 V				0.1			V
	I _{OL} = 4 mA	1.65 V				0.45			
	I _{OL} = 8 mA	2.3 V				0.3			
	I _{OL} = 16 mA	3 V				0.4			
	I _{OL} = 24 mA					0.55			
	I _{OL} = 32 mA	4.5 V				0.55			
I _I Data or control inputs	V _I = 5.5 V or GND	0 to 5.5 V				±5			μA
I _{off}	V _I or V _O = 5.5 V	0				±10			μA
I _{CC}	V _I = 5.5 V or GND, I _O = 0	1.65 V to 5.5 V				10			μA
Δ I _{CC}	One input at V _{CC} - 0.6 V, Other inputs at V _{CC} or GND	3 V to 5.5 V				500			μA
C _i	V _I = V _{CC} or GND	3.3 V				5			pF

(1) All typical values are at V_{CC} = 3.3 V, T_A = 25°C.

6.6 Timing Requirements, - 40°C to +85°C

over recommended operating free-air temperature range (unless otherwise noted) (see 图 7-1)

PARAMETER	FROM	TO	- 40°C to +85°C								UNIT
			V _{CC} = 1.8 V ± 0.15 V		V _{CC} = 2.5 V ± 0.2 V		V _{CC} = 3.3 V ± 0.3 V		V _{CC} = 5 V ± 0.5 V		
			MIN	MAX	MIN	MAX	MIN	MAX	MIN	MAX	
f _{clock}			80		175		175		200		MHz
t _w	CLK		6.2		2.7		2.7		2		ns
	PRE or CLR low		6.2		2.7		2.7		2		
t _{su}	Data		2.9		1.7		1.3		1.1		ns
	PRE or CLR inactive		1.9		1.4		1.2		1		
t _h			0		0.3		1.2		0.5		ns

6.7 Timing Requirements, - 40°C to +125°C

over recommended operating free-air temperature range (unless otherwise noted) (see 图 7-1)

PARAMETER	FROM	TO	- 40°C to +125°C								UNIT
			V _{CC} = 1.8 V ± 0.15 V		V _{CC} = 2.5 V ± 0.2 V		V _{CC} = 3.3 V ± 0.3 V		V _{CC} = 5 V ± 0.5 V		
			MIN	MAX	MIN	MAX	MIN	MAX	MIN	MAX	
f _{clock}			80		120		120		140		MHz
t _w	CLK		6.2		3.5		3.5		3.3		ns
	PRE or CLR low		6.2		3.5		3.5		3.3		
t _{su}	Data		2.9		2.3		1.9		1.7		ns
	PRE or CLR inactive		1.9		2		1.8		1.6		

over recommended operating free-air temperature range (unless otherwise noted) (see [图 7-1](#))

PARAMETER	FROM	TO	- 40°C to +125°C								UNIT
			V _{CC} = 1.8 V ± 0.15 V		V _{CC} = 2.5 V ± 0.2 V		V _{CC} = 3.3 V ± 0.3 V		V _{CC} = 5 V ± 0.5 V		
			MIN	MAX	MIN	MAX	MIN	MAX	MIN	MAX	
t _h			0		0.3		0.5		0.5		ns

6.8 Switching Characteristics, - 40°C to +85°C

over recommended operating free-air temperature range (unless otherwise noted) (see [图 7-1](#))

PARAMETER	FROM	TO	- 40°C to +85°C								UNIT
			V _{CC} = 1.8 V ± 0.15 V		V _{CC} = 2.5 V ± 0.2 V		V _{CC} = 3.3 V ± 0.3 V		V _{CC} = 5 V ± 0.5 V		
			MIN	MAX	MIN	MAX	MIN	MAX	MIN	MAX	
f _{max}			80		175		175		200		MHz
t _{pd}	CLK	Q	4.8	13.4	2.2	7.1	2.2	5.9	1.4	4.1	ns
		\bar{Q}	6	14.4	3	7.7	2.6	6.2	1.6	4.4	
	PRE or CLR low	Q or Q	4.4	12.9	2.3	7	1.7	5.9	1.6	4.1	

6.9 Switching Characteristics, - 40°C to +125°C

over recommended operating free-air temperature range (unless otherwise noted) (see [图 7-1](#))

PARAMETER	FROM	TO	- 40°C to +125°C								UNIT
			V _{CC} = 1.8 V ± 0.15 V		V _{CC} = 2.5 V ± 0.2 V		V _{CC} = 3.3 V ± 0.3 V		V _{CC} = 5 V ± 0.5 V		
			MIN	MAX	MIN	MAX	MIN	MAX	MIN	MAX	
f _{max}			80		120		120		140		MHz
t _{pd}	CLK	Q	4.8	14.4	2.2	8.1	2.2	6.9	1.4	5.1	ns
		\bar{Q}	6	16	3	9.7	2.6	7.2	1.6	5.4	
	PRE or CLR low	Q or Q	4.4	14.9	2.3	9.5	1.7	7.9	1.6	6.1	

6.10 Operating Characteristics

T_A = 25°C

PARAMETER	TEST CONDITIONS	V _{CC} = 1.8 V	V _{CC} = 2.5 V	V _{CC} = 3.3 V	V _{CC} = 5 V	UNIT	
		TYP	TYP	TYP	TYP		
C _{pd}	Power dissipation capacitance	f = 10 MHz	35	35	37	40	pF

6.11 Typical Characteristics

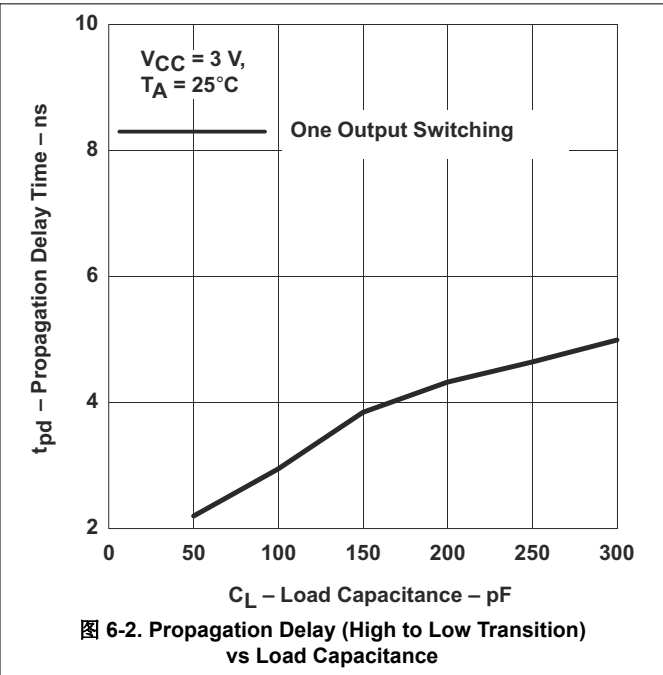
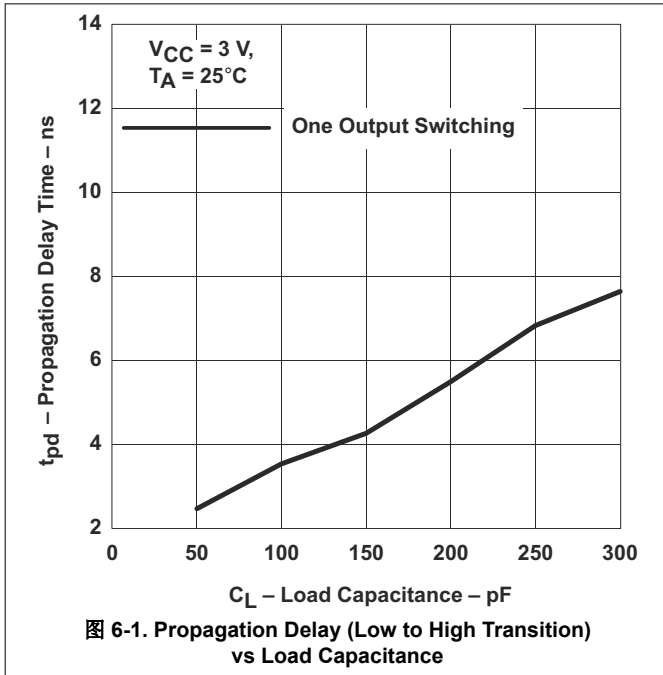

7 Parameter Measurement Information

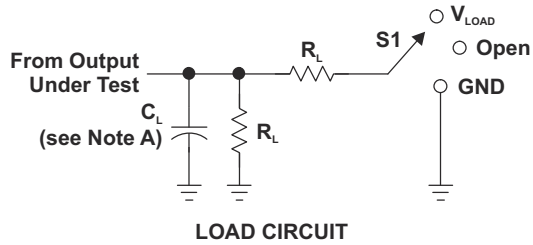

TEST	S1
t_{PLH}/t_{PHL}	Open
t_{PLZ}/t_{PZL}	V_{LOAD}
t_{PHZ}/t_{PZH}	GND

V_{CC}	INPUTS		V_M	V_{LOAD}	C_L	R_L	V_{Δ}
	V_I	t_r/t_f					
$1.8\text{ V} \pm 0.15\text{ V}$	V_{CC}	$\leq 2\text{ ns}$	$V_{CC}/2$	$2 \times V_{CC}$	30 pF	1 k Ω	0.15 V
$2.5\text{ V} \pm 0.2\text{ V}$	V_{CC}	$\leq 2\text{ ns}$	$V_{CC}/2$	$2 \times V_{CC}$	30 pF	500 Ω	0.15 V
$3.3\text{ V} \pm 0.3\text{ V}$	3 V	$\leq 2.5\text{ ns}$	1.5 V	6 V	50 pF	500 Ω	0.3 V
$5\text{ V} \pm 0.5\text{ V}$	V_{CC}	$\leq 2.5\text{ ns}$	$V_{CC}/2$	$2 \times V_{CC}$	50 pF	500 Ω	0.3 V

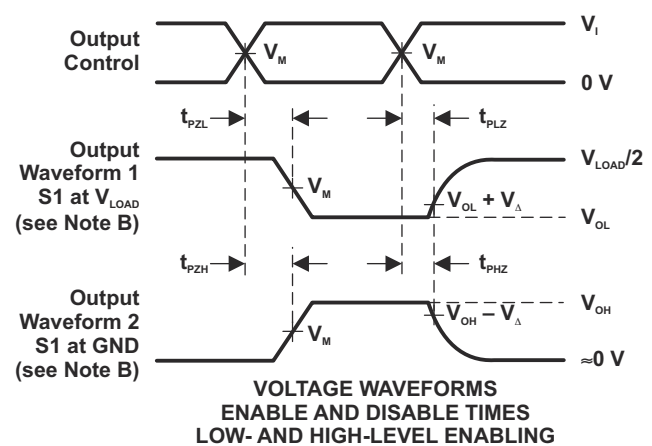
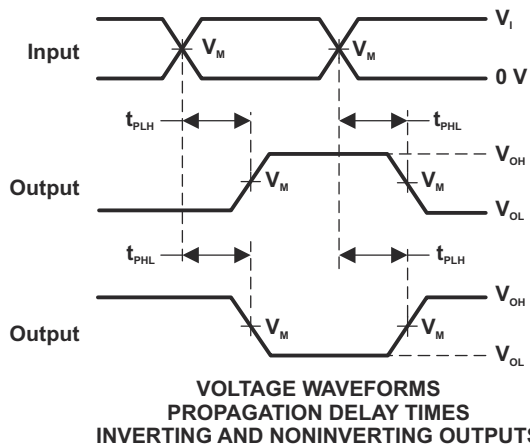
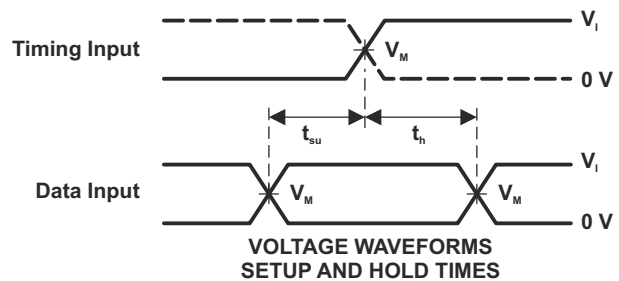
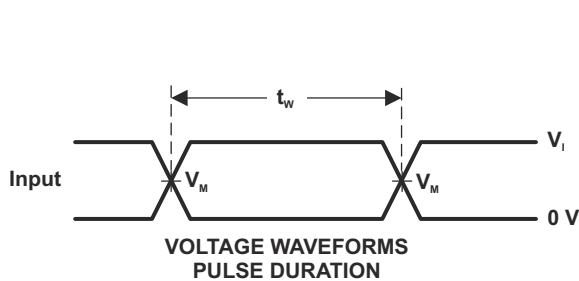

- NOTES: A. C_L includes probe and jig capacitance.
 B. Waveform 1 is for an output with internal conditions such that the output is low, except when disabled by the output control. Waveform 2 is for an output with internal conditions such that the output is high, except when disabled by the output control.
 C. All input pulses are supplied by generators having the following characteristics: $PRR \leq 10\text{ MHz}$, $Z_o = 50\ \Omega$.
 D. The outputs are measured one at a time, with one transition per measurement.
 E. t_{PLZ} and t_{PHZ} are the same as t_{dis} .
 F. t_{PZL} and t_{PZH} are the same as t_{en} .
 G. t_{PLH} and t_{PHL} are the same as t_{pd} .
 H. All parameters and waveforms are not applicable to all devices.

图 7-1. Load Circuit and Voltage Waveforms

8 Detailed Description

8.1 Overview

This device is fully specified for partial-power-down applications using I_{off} . The I_{off} circuitry disables the outputs, preventing damaging current backflow through the device when it is powered down.

8.2 Functional Block Diagram

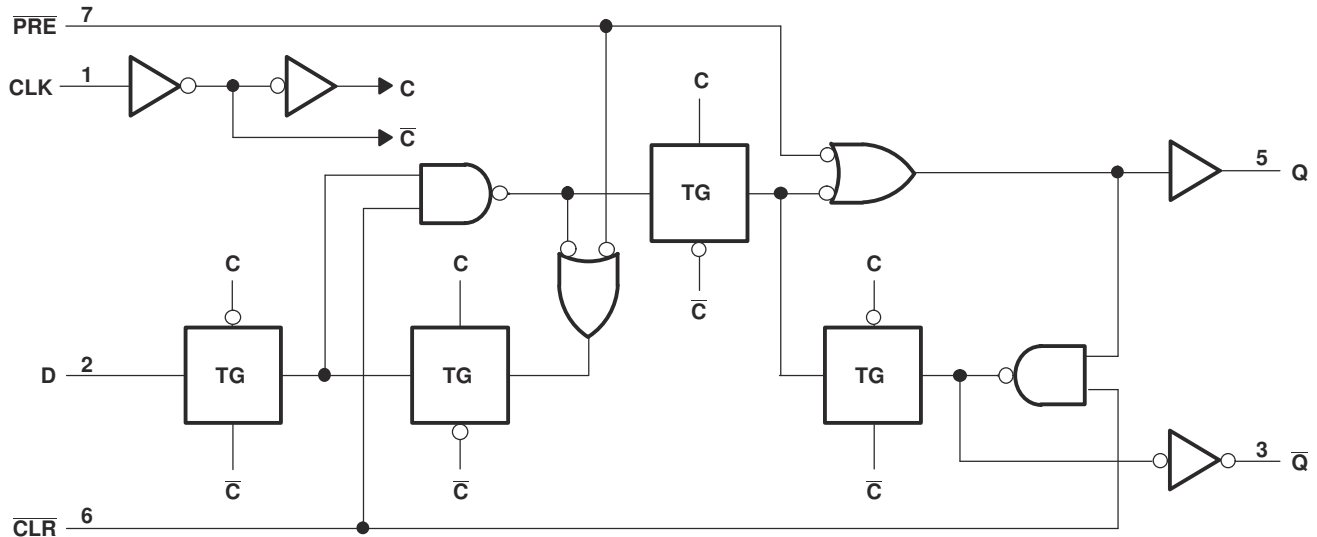

8.3 Feature Description

- Allows down voltage translation
 - 5 V to 3.3 V
 - 5 V or 3.3 V to 1.8 V
- Inputs accept voltage levels up to 5.5 V
- I_{off} Feature
 - Can prevent backflow current that can damage device when powered down.

8.4 Device Functional Modes

表 8-1 shows the functional modes of SN74LVC2G74.

表 8-1. Function Table

INPUTS				OUTPUTS	
PRE	CLR	CLK	D	Q	\bar{Q}
L	H	X	X	H	L
H	L	X	X	L	H
L	L	X	X	H ⁽¹⁾	H ⁽¹⁾
H	H	↑	H	H	L
H	H	↑	L	L	H
H	H	L	X	Q ₀	\bar{Q}_0

(1) This configuration is non-stable; that is, it does not persist when \overline{PRE} or \overline{CLR} returns to its inactive (high) level.

9 Application and Implementation

Note

以下应用部分中的信息不属于 TI 器件规格的范围，TI 不担保其准确性和完整性。TI 的客户应负责确定器件是否适用于其应用。客户应验证并测试其设计，以确保系统功能。

9.1 Application Information

A low level at the preset ($\overline{\text{PRE}}$) or clear ($\overline{\text{CLR}}$) input sets or resets the outputs, regardless of the levels of the other inputs. When $\overline{\text{PRE}}$ and $\overline{\text{CLR}}$ are inactive (high), data at the data (D) input meeting the setup time requirements is transferred to the outputs on the positive-going edge of the clock pulse. Clock triggering occurs at a voltage level and is not related directly to the rise time of the clock pulse. Following the hold-time interval, data at the D input can be changed without affecting the levels at the outputs.

The $330\ \Omega$ resistor and $22\ \text{pF}$ capacitor shown in 图 9-1 produce enough delay to meet the hold time requirement of the D input. To calculate the delay for a particular RC combination, use 方程式 1. The delay with this RC combination is $5.03\ \text{ns}$

$$t_{\text{delay}} = -RC \ln(0.5) \approx 0.693 RC \quad (1)$$

To ensure proper operation, check that the transition time of the RC circuit meets the transition time requirements of the device inputs listed in the Recommended Operating Conditions table. Transition time for an RC can be approximated with 方程式 2.

$$t_t \approx 2.2 RC \quad (2)$$

In this case, transition time is $18.15\ \text{ns}$, which equates to a $4.54\ \text{ns/V}$ input transition rate at $V_{\text{CC}} = 5\ \text{V}$, and is below the $5\ \text{ns/V}$ maximum requirement for recommended operation.

9.2 Typical Power Button Circuit



图 9-1. Device Power Button Circuit

9.2.1 Design Requirements

This device uses CMOS technology and has balanced output drive. Care should be taken to avoid bus contention because it can drive currents that would exceed maximum limits. Outputs can be combined to

produce higher drive but the high drive will also create faster edges into light loads so routing and load conditions should be considered to prevent ringing.

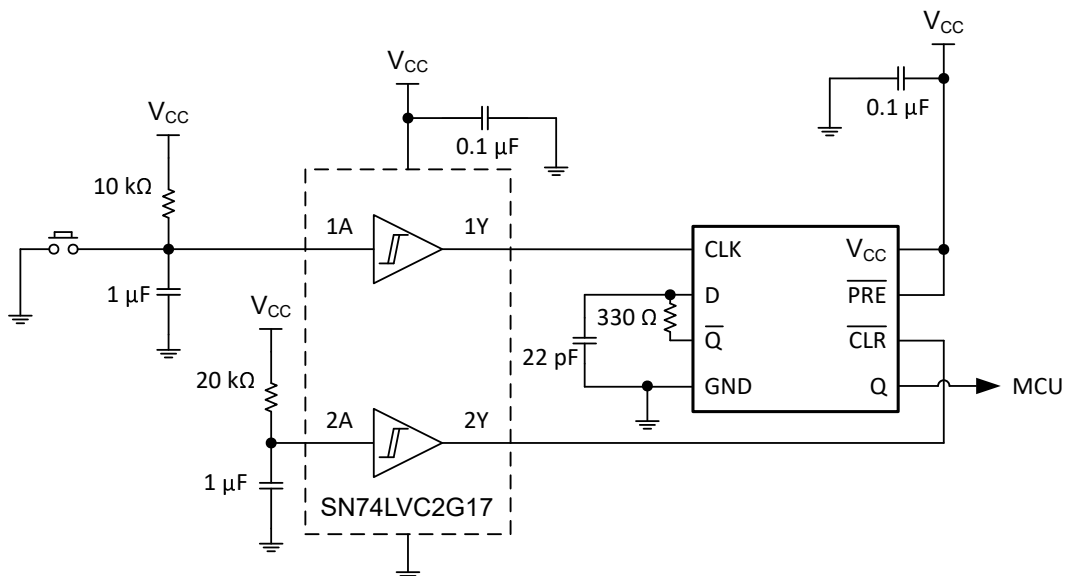
9.2.2 Detailed Design Procedure

1. Recommended Input Conditions:

- For rise time and fall time specifications, see ($\Delta t / \Delta V$) in the [Recommended Operating Conditions](#) table.
- For specified high and low levels, see (V_{IH} and V_{IL}) in the [Recommended Operating Conditions](#) table.
- Inputs are overvoltage tolerant allowing them to go as high as 5.5 V at any valid V_{CC}

2. Recommend Output Conditions:

- Load currents should not exceed 50 mA per output and 100 mA total for the part.
- Series resistors on the output may be used if the user desires to slow the output edge signal or limit the output current.

9.2.3 Application Curves

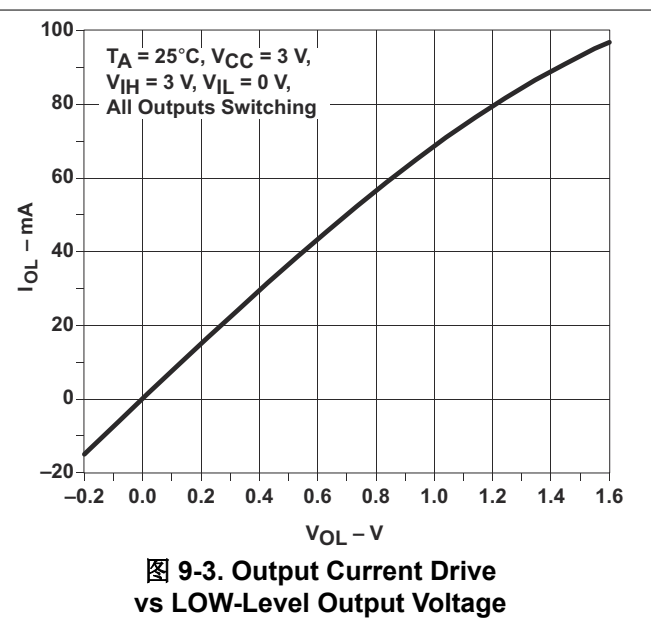
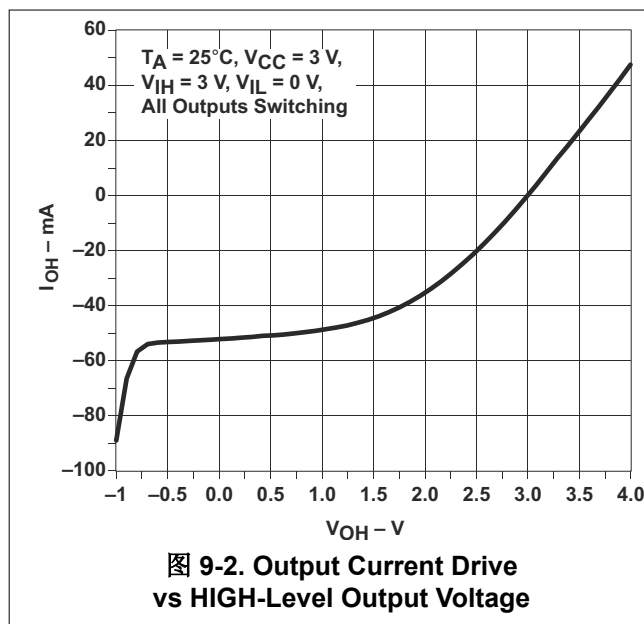

10 Power Supply Recommendations

The power supply can be any voltage between the minimum and maximum supply voltage rating located in the [Recommended Operating Conditions](#) table. Each V_{CC} terminal should have a good bypass capacitor to prevent power disturbance. For devices with a single supply, a 0.1- μ F capacitor is recommended and if there are multiple V_{CC} terminals then .01- μ F or .022- μ F capacitors are recommended for each power terminal. It is acceptable to parallel multiple bypass caps to reject different frequencies of noise. The 0.1- μ F and 1- μ F capacitors are commonly used in parallel. The bypass capacitor should be installed as close to the power terminal as possible for best results.

11 Layout

11.1 Layout Guidelines

When using multiple bit logic devices, inputs should not float. In many cases, functions or parts of functions of digital logic devices are unused. Some examples are when only two inputs of a triple-input AND gate are used, or when only 3 of the 4-buffer gates are used. Such input pins should not be left unconnected because the undefined voltages at the outside connections result in undefined operational states.

Specified in [图 11-1](#) are rules that must be observed under all circumstances. All unused inputs of digital logic devices must be connected to a high or low bias to prevent them from floating. The logic level that should be applied to any particular unused input depends on the function of the device. Generally they will be tied to GND or V_{CC} , whichever makes more sense or is more convenient. It is acceptable to float outputs unless the part is a transceiver. If the transceiver has an output enable pin, it will disable the outputs section of the part when asserted. This will not disable the input section of the I/Os so they also cannot float when disabled.

11.2 Layout Example



图 11-1. Layout Diagram

12 Device and Documentation Support

12.1 接收文档更新通知

要接收文档更新通知，请导航至 ti.com 上的器件产品文件夹。点击 [订阅更新](#) 进行注册，即可每周接收产品信息更改摘要。有关更改的详细信息，请查看任何已修订文档中包含的修订历史记录。

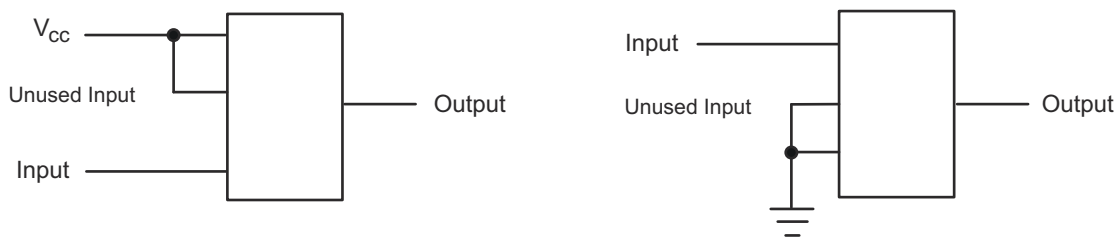
12.2 支持资源

TI E2E™ 支持论坛 是工程师的重要参考资料，可直接从专家获得快速、经过验证的解答和设计帮助。搜索现有解答或提出自己的问题可获得所需的快速设计帮助。

链接的内容由各个贡献者“按原样”提供。这些内容并不构成 TI 技术规范，并且不一定反映 TI 的观点；请参阅 TI 的《[使用条款](#)》。

12.3 Trademarks

NanoFree™ is a trademark of Texas Instruments.

TI E2E™ is a trademark of Texas Instruments.

所有商标均为其各自所有者的财产。

12.4 Electrostatic Discharge Caution



This integrated circuit can be damaged by ESD. Texas Instruments recommends that all integrated circuits be handled with appropriate precautions. Failure to observe proper handling and installation procedures can cause damage.

ESD damage can range from subtle performance degradation to complete device failure. Precision integrated circuits may be more susceptible to damage because very small parametric changes could cause the device not to meet its published specifications.

12.5 术语表

TI 术语表 本术语表列出并解释了术语、首字母缩略词和定义。

13 Mechanical, Packaging, and Orderable Information

The following pages include mechanical packaging and orderable information. This information is the most current data available for the designated devices. This data is subject to change without notice and revision of this document. For browser based versions of this data sheet, refer to the left hand navigation.

重要声明和免责声明

TI 提供技术和可靠性数据 (包括数据表)、设计资源 (包括参考设计)、应用或其他设计建议、网络工具、安全信息和其他资源, 不保证没有瑕疵且不做任何明示或暗示的担保, 包括但不限于对适销性、某特定用途方面的适用性或不侵犯任何第三方知识产权的暗示担保。

这些资源可供使用 TI 产品进行设计的熟练开发人员使用。您将自行承担以下全部责任: (1) 针对您的应用选择合适的 TI 产品, (2) 设计、验证并测试您的应用, (3) 确保您的应用满足相应标准以及任何其他安全、安保或其他要求。这些资源如有变更, 恕不另行通知。TI 授权您仅可将这些资源用于研发本资源所述的 TI 产品的应用。严禁对这些资源进行其他复制或展示。您无权使用任何其他 TI 知识产权或任何第三方知识产权。您应全额赔偿因在这些资源的使用中对 TI 及其代表造成的任何索赔、损害、成本、损失和债务, TI 对此概不负责。

TI 提供的产品受 TI 的销售条款 (<https://www.ti.com/legal/termsofsale.html>) 或 [ti.com](https://www.ti.com) 上其他适用条款/TI 产品随附的其他适用条款的约束。TI 提供这些资源并不会扩展或以其他方式更改 TI 针对 TI 产品发布的适用的担保或担保免责声明。

邮寄地址: Texas Instruments, Post Office Box 655303, Dallas, Texas 75265
Copyright © 2021, 德州仪器 (TI) 公司

PACKAGING INFORMATION

Orderable Device	Status (1)	Package Type	Package Drawing	Pins	Package Qty	Eco Plan (2)	Lead finish/ Ball material (6)	MSL Peak Temp (3)	Op Temp (°C)	Device Marking (4/5)	Samples
SN74LVC2G74DCT3	ACTIVE	SM8	DCT	8	3000	RoHS & Non-Green	SNBI	Level-1-260C-UNLIM	-40 to 125	C74 Z	Samples
SN74LVC2G74DCTR	ACTIVE	SM8	DCT	8	3000	RoHS & Green	NIPDAU SN	Level-1-260C-UNLIM	-40 to 125	(2WS5, C74) Z	Samples
SN74LVC2G74DCTRE4	ACTIVE	SM8	DCT	8	3000	RoHS & Green	NIPDAU	Level-1-260C-UNLIM	-40 to 125	(2WS5, C74) Z	Samples
SN74LVC2G74DCTRE6	ACTIVE	SM8	DCT	8	3000	RoHS & Non-Green	SNBI	Level-1-260C-UNLIM	-40 to 125	C74 Z	Samples
SN74LVC2G74DCTRG4	ACTIVE	SM8	DCT	8	3000	RoHS & Green	NIPDAU	Level-1-260C-UNLIM	-40 to 125	(2WS5, C74) Z	Samples
SN74LVC2G74DCUR	ACTIVE	VSSOP	DCU	8	3000	RoHS & Green	NIPDAU SN	Level-1-260C-UNLIM	-40 to 125	(74, C74J, C74Q, C74R) CZ	Samples
SN74LVC2G74DCURE4	ACTIVE	VSSOP	DCU	8	3000	RoHS & Green	NIPDAU	Level-1-260C-UNLIM	-40 to 125	C74R	Samples
SN74LVC2G74DCURG4	ACTIVE	VSSOP	DCU	8	3000	RoHS & Green	NIPDAU	Level-1-260C-UNLIM	-40 to 125	C74R	Samples
SN74LVC2G74DCUT	ACTIVE	VSSOP	DCU	8	250	RoHS & Green	NIPDAU SN	Level-1-260C-UNLIM	-40 to 125	(C74J, C74Q, C74R)	Samples
SN74LVC2G74DCUTE4	ACTIVE	VSSOP	DCU	8	250	RoHS & Green	NIPDAU	Level-1-260C-UNLIM	-40 to 125	C74R	Samples
SN74LVC2G74DCUTG4	ACTIVE	VSSOP	DCU	8	250	RoHS & Green	NIPDAU	Level-1-260C-UNLIM	-40 to 125	C74R	Samples
SN74LVC2G74YZPR	ACTIVE	DSBGA	YZP	8	3000	RoHS & Green	SNAGCU	Level-1-260C-UNLIM	-40 to 85	CPN	Samples

(1) The marketing status values are defined as follows:

ACTIVE: Product device recommended for new designs.

LIFEBUY: TI has announced that the device will be discontinued, and a lifetime-buy period is in effect.

NRND: Not recommended for new designs. Device is in production to support existing customers, but TI does not recommend using this part in a new design.

PREVIEW: Device has been announced but is not in production. Samples may or may not be available.

OBSOLETE: TI has discontinued the production of the device.

(2) **RoHS:** TI defines "RoHS" to mean semiconductor products that are compliant with the current EU RoHS requirements for all 10 RoHS substances, including the requirement that RoHS substance do not exceed 0.1% by weight in homogeneous materials. Where designed to be soldered at high temperatures, "RoHS" products are suitable for use in specified lead-free processes. TI may reference these types of products as "Pb-Free".

RoHS Exempt: TI defines "RoHS Exempt" to mean products that contain lead but are compliant with EU RoHS pursuant to a specific EU RoHS exemption.

Green: TI defines "Green" to mean the content of Chlorine (Cl) and Bromine (Br) based flame retardants meet JS709B low halogen requirements of ≤ 1000 ppm threshold. Antimony trioxide based flame retardants must also meet the ≤ 1000 ppm threshold requirement.

- (3) MSL, Peak Temp. - The Moisture Sensitivity Level rating according to the JEDEC industry standard classifications, and peak solder temperature.
- (4) There may be additional marking, which relates to the logo, the lot trace code information, or the environmental category on the device.
- (5) Multiple Device Markings will be inside parentheses. Only one Device Marking contained in parentheses and separated by a "~" will appear on a device. If a line is indented then it is a continuation of the previous line and the two combined represent the entire Device Marking for that device.
- (6) Lead finish/Ball material - Orderable Devices may have multiple material finish options. Finish options are separated by a vertical ruled line. Lead finish/Ball material values may wrap to two lines if the finish value exceeds the maximum column width.

Important Information and Disclaimer: The information provided on this page represents TI's knowledge and belief as of the date that it is provided. TI bases its knowledge and belief on information provided by third parties, and makes no representation or warranty as to the accuracy of such information. Efforts are underway to better integrate information from third parties. TI has taken and continues to take reasonable steps to provide representative and accurate information but may not have conducted destructive testing or chemical analysis on incoming materials and chemicals. TI and TI suppliers consider certain information to be proprietary, and thus CAS numbers and other limited information may not be available for release.

In no event shall TI's liability arising out of such information exceed the total purchase price of the TI part(s) at issue in this document sold by TI to Customer on an annual basis.

OTHER QUALIFIED VERSIONS OF SN74LVC2G74 :

- Automotive : [SN74LVC2G74-Q1](#)
- Enhanced Product : [SN74LVC2G74-EP](#)

NOTE: Qualified Version Definitions:

- Automotive - Q100 devices qualified for high-reliability automotive applications targeting zero defects
- Enhanced Product - Supports Defense, Aerospace and Medical Applications

TAPE AND REEL INFORMATION

QUADRANT ASSIGNMENTS FOR PIN 1 ORIENTATION IN TAPE

*All dimensions are nominal

Device	Package Type	Package Drawing	Pins	SPQ	Reel Diameter (mm)	Reel Width W1 (mm)	A0 (mm)	B0 (mm)	K0 (mm)	P1 (mm)	W (mm)	Pin1 Quadrant
SN74LVC2G74DCT3	SM8	DCT	8	3000	180.0	13.0	3.35	4.5	1.55	4.0	12.0	Q3
SN74LVC2G74DCTR	SM8	DCT	8	3000	180.0	12.4	3.15	4.35	1.55	4.0	12.0	Q3
SN74LVC2G74DCTRE6	SM8	DCT	8	3000	180.0	13.0	3.35	4.5	1.55	4.0	12.0	Q3
SN74LVC2G74DCUR	VSSOP	DCU	8	3000	178.0	9.0	2.25	3.35	1.05	4.0	8.0	Q3
SN74LVC2G74DCURG4	VSSOP	DCU	8	3000	180.0	8.4	2.25	3.35	1.05	4.0	8.0	Q3
SN74LVC2G74DCUT	VSSOP	DCU	8	250	178.0	9.0	2.25	3.35	1.05	4.0	8.0	Q3
SN74LVC2G74DCUTG4	VSSOP	DCU	8	250	180.0	8.4	2.25	3.35	1.05	4.0	8.0	Q3
SN74LVC2G74YZPR	DSBGA	YZP	8	3000	178.0	9.2	1.02	2.02	0.63	4.0	8.0	Q1

TAPE AND REEL BOX DIMENSIONS

*All dimensions are nominal

Device	Package Type	Package Drawing	Pins	SPQ	Length (mm)	Width (mm)	Height (mm)
SN74LVC2G74DCT3	SM8	DCT	8	3000	182.0	182.0	20.0
SN74LVC2G74DCTR	SM8	DCT	8	3000	190.0	190.0	30.0
SN74LVC2G74DCTRE6	SM8	DCT	8	3000	182.0	182.0	20.0
SN74LVC2G74DCUR	VSSOP	DCU	8	3000	180.0	180.0	18.0
SN74LVC2G74DCURG4	VSSOP	DCU	8	3000	202.0	201.0	28.0
SN74LVC2G74DCUT	VSSOP	DCU	8	250	180.0	180.0	18.0
SN74LVC2G74DCUTG4	VSSOP	DCU	8	250	202.0	201.0	28.0
SN74LVC2G74YZPR	DSBGA	YZP	8	3000	220.0	220.0	35.0

EXAMPLE BOARD LAYOUT

DCU0008A

VSSOP - 0.9 mm max height

SMALL OUTLINE PACKAGE

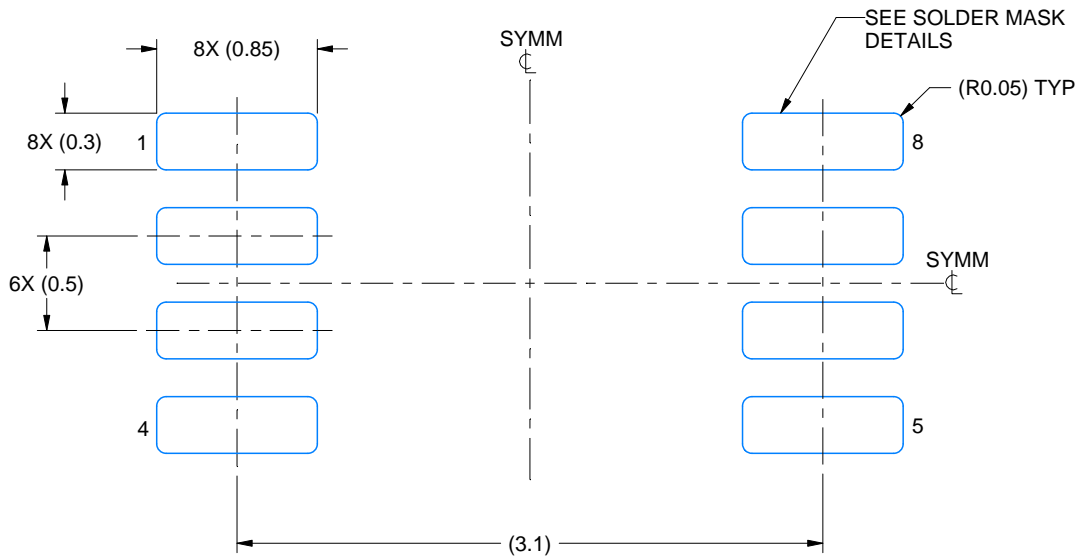

LAND PATTERN EXAMPLE
EXPOSED METAL SHOWN
SCALE: 25X

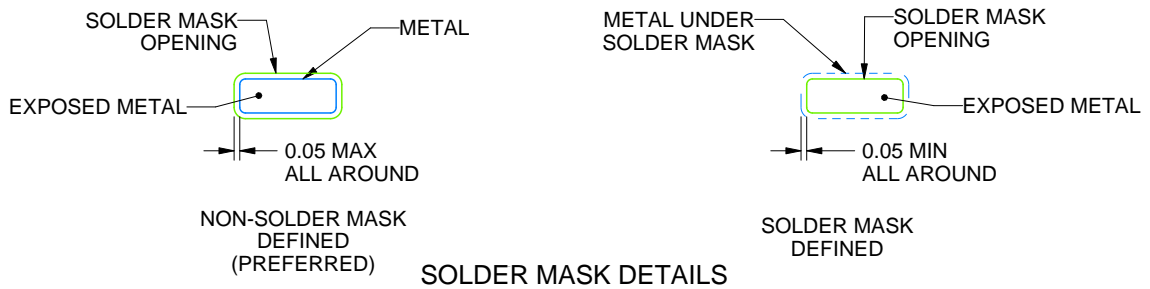

4225266/A 09/2014

NOTES: (continued)

- 5. Publication IPC-7351 may have alternate designs.
- 6. Solder mask tolerances between and around signal pads can vary based on board fabrication site.

EXAMPLE STENCIL DESIGN

DCU0008A

VSSOP - 0.9 mm max height

SMALL OUTLINE PACKAGE

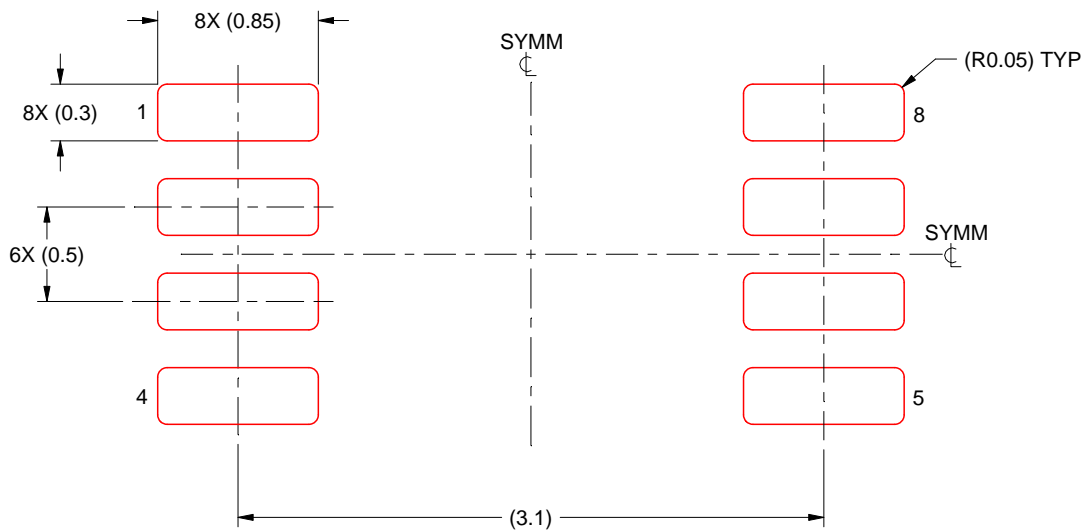

SOLDER PASTE EXAMPLE
BASED ON 0.125 mm THICK STENCIL
SCALE: 25X

4225266/A 09/2014

NOTES: (continued)

7. Laser cutting apertures with trapezoidal walls and rounded corners may offer better paste release. IPC-7525 may have alternate design recommendations.
8. Board assembly site may have different recommendations for stencil design.

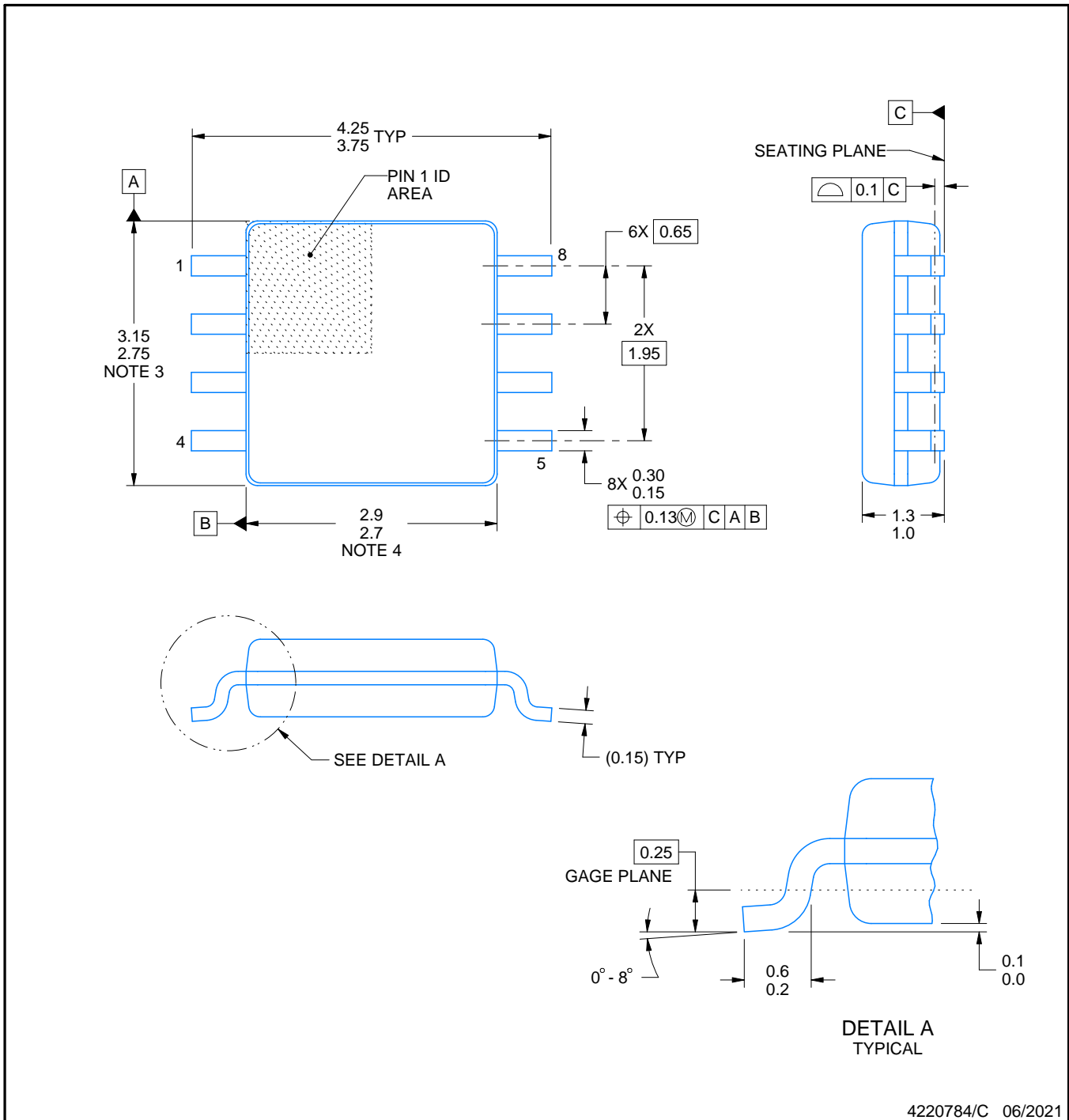
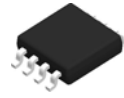

4220784/C 06/2021

NOTES:

1. All linear dimensions are in millimeters. Dimensions in parenthesis are for reference only. Dimensioning and tolerancing per ASME Y14.5M.
2. This drawing is subject to change without notice.
3. This dimension does not include mold flash, protrusions, or gate burrs. Mold flash, protrusions, or gate burrs shall not exceed 0.15 mm per side.
4. This dimension does not include interlead flash. Interlead flash shall not exceed 0.25 mm per side.

EXAMPLE BOARD LAYOUT

DCT0008A

SSOP - 1.3 mm max height

SMALL OUTLINE PACKAGE

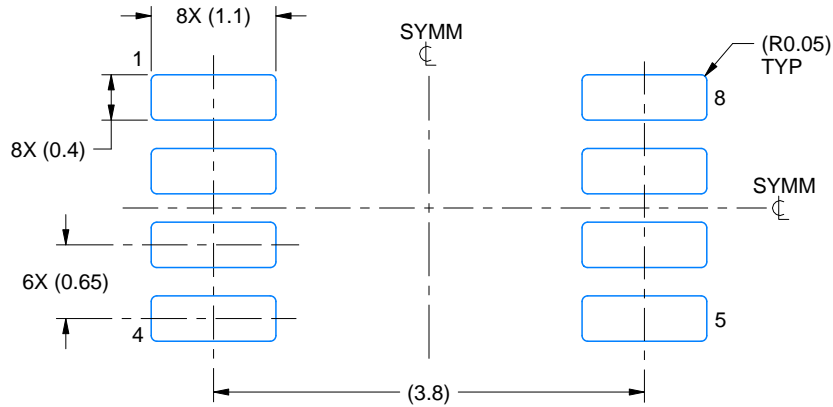

LAND PATTERN EXAMPLE
EXPOSED METAL SHOWN
SCALE:15X

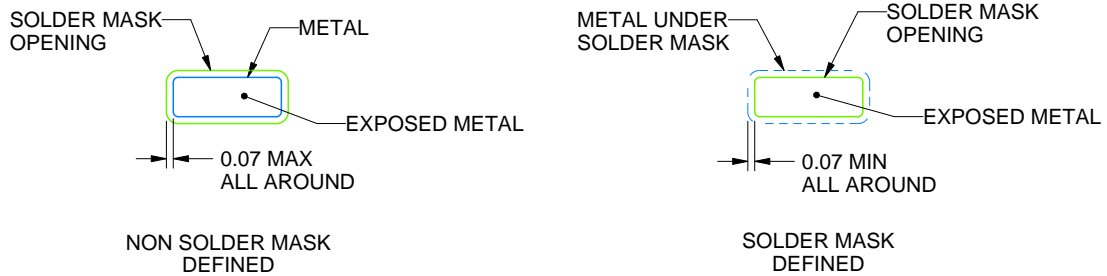

SOLDER MASK DETAILS

4220784/C 06/2021

NOTES: (continued)

- 5. Publication IPC-7351 may have alternate designs.
- 6. Solder mask tolerances between and around signal pads can vary based on board fabrication site.

EXAMPLE STENCIL DESIGN

DCT0008A

SSOP - 1.3 mm max height

SMALL OUTLINE PACKAGE

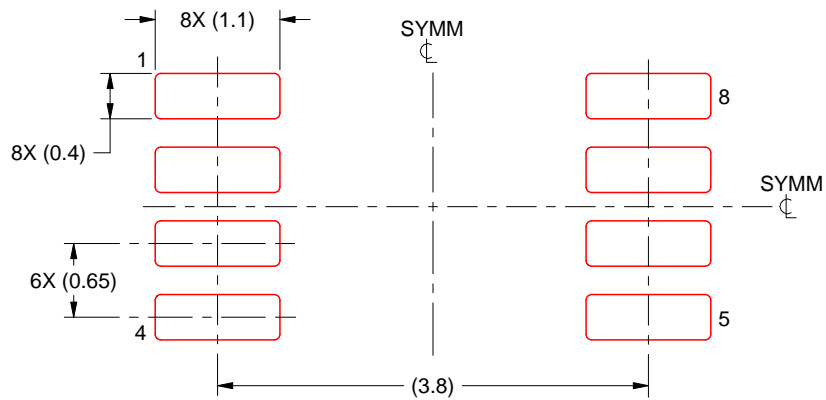

SOLDER PASTE EXAMPLE
BASED ON 0.125 mm THICK STENCIL
SCALE:15X

4220784/C 06/2021

NOTES: (continued)

7. Laser cutting apertures with trapezoidal walls and rounded corners may offer better paste release. IPC-7525 may have alternate design recommendations.
8. Board assembly site may have different recommendations for stencil design.

YZP0008

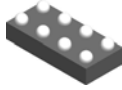

PACKAGE OUTLINE

DSBGA - 0.5 mm max height

DIE SIZE BALL GRID ARRAY

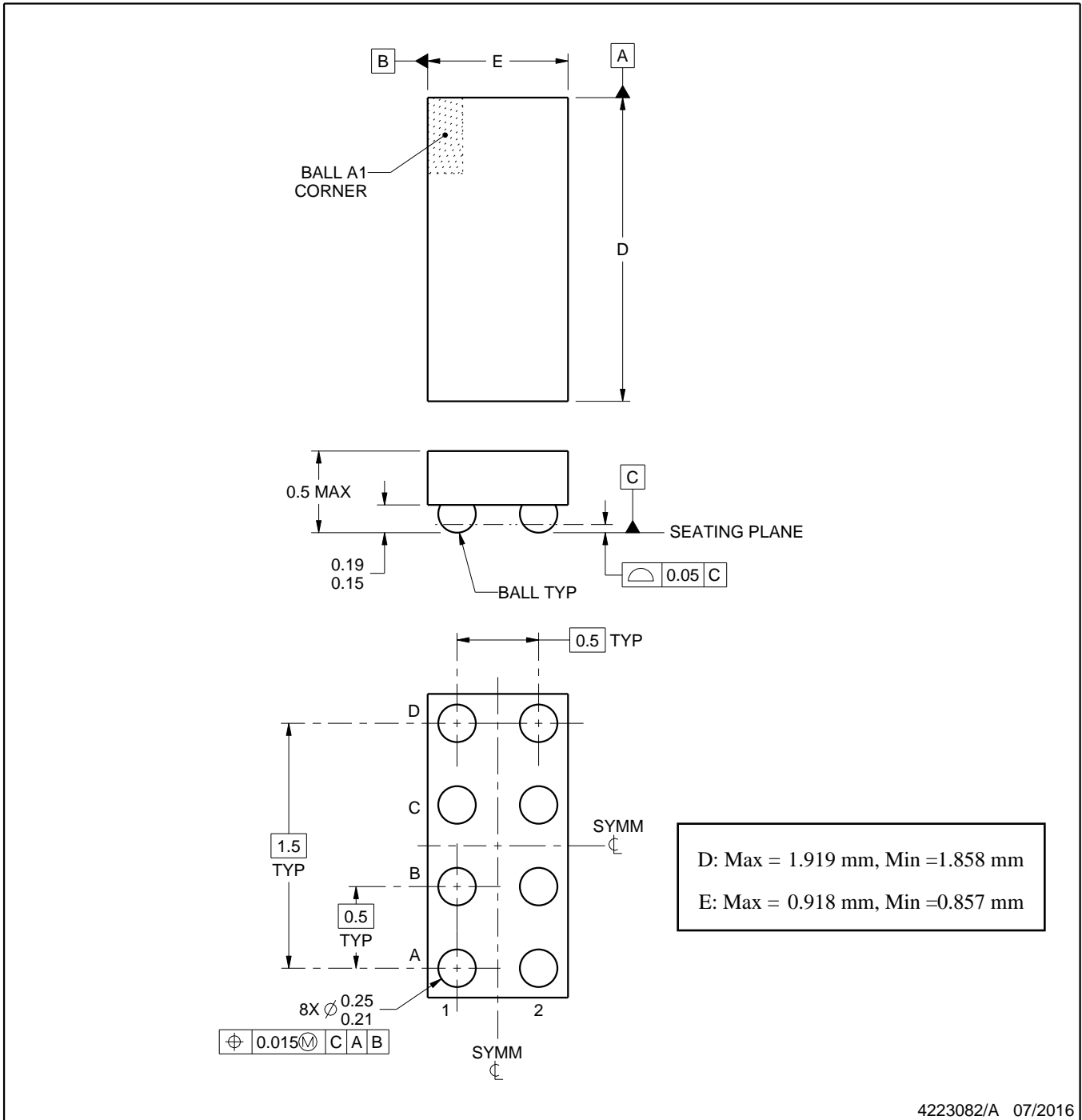

4223082/A 07/2016

NOTES:

1. All linear dimensions are in millimeters. Any dimensions in parenthesis are for reference only. Dimensioning and tolerancing per ASME Y14.5M.
2. This drawing is subject to change without notice.

EXAMPLE BOARD LAYOUT

YZP0008

DSBGA - 0.5 mm max height

DIE SIZE BALL GRID ARRAY

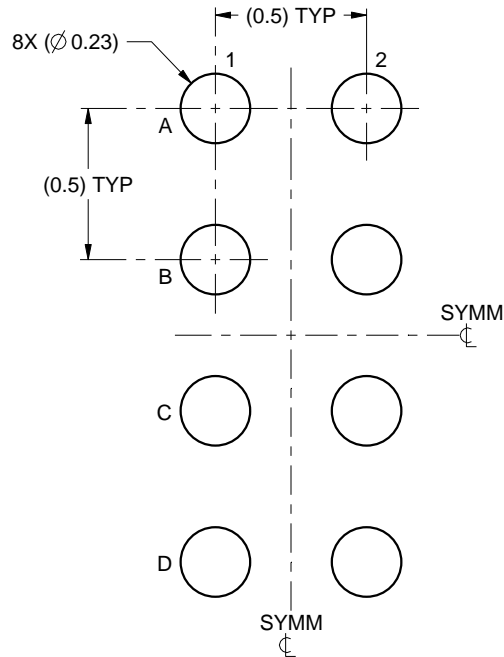

LAND PATTERN EXAMPLE
SCALE:40X

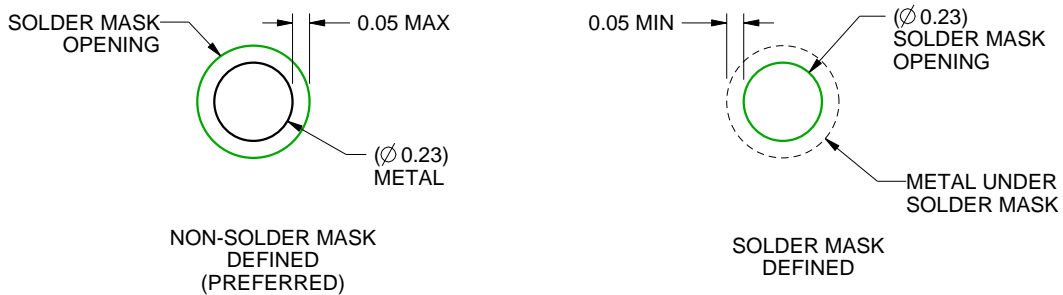

SOLDER MASK DETAILS
NOT TO SCALE

4223082/A 07/2016

NOTES: (continued)

- Final dimensions may vary due to manufacturing tolerance considerations and also routing constraints. For more information, see Texas Instruments literature number SNVA009 (www.ti.com/lit/snva009).

EXAMPLE STENCIL DESIGN

YZP0008

DSBGA - 0.5 mm max height

DIE SIZE BALL GRID ARRAY

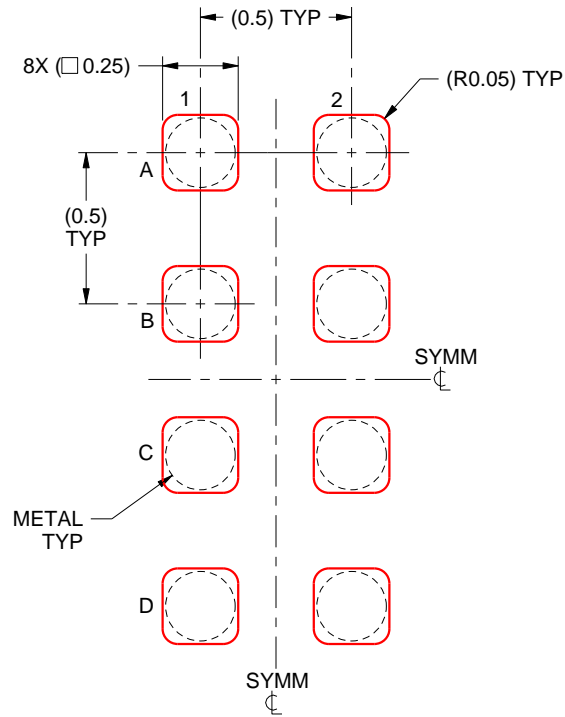

SOLDER PASTE EXAMPLE
BASED ON 0.1 mm THICK STENCIL
SCALE:40X

4223082/A 07/2016

NOTES: (continued)

4. Laser cutting apertures with trapezoidal walls and rounded corners may offer better paste release.

重要声明和免责声明

TI“按原样”提供技术和可靠性数据（包括数据表）、设计资源（包括参考设计）、应用或其他设计建议、网络工具、安全信息和其他资源，不保证没有瑕疵且不做任何明示或暗示的担保，包括但不限于对适销性、某特定用途方面的适用性或不侵犯任何第三方知识产权的暗示担保。

这些资源可供使用 TI 产品进行设计的熟练开发人员使用。您将自行承担以下全部责任：(1) 针对您的应用选择合适的 TI 产品，(2) 设计、验证并测试您的应用，(3) 确保您的应用满足相应标准以及任何其他功能安全、信息安全、监管或其他要求。

这些资源如有变更，恕不另行通知。TI 授权您仅可将这些资源用于研发本资源所述的 TI 产品的应用。严禁对这些资源进行其他复制或展示。您无权使用任何其他 TI 知识产权或任何第三方知识产权。您应全额赔偿因在这些资源的使用中对 TI 及其代表造成的任何索赔、损害、成本、损失和债务，TI 对此概不负责。

TI 提供的产品受 [TI 的销售条款](#) 或 [ti.com](#) 上其他适用条款/TI 产品随附的其他适用条款的约束。TI 提供这些资源并不会扩展或以其他方式更改 TI 针对 TI 产品发布的适用的担保或担保免责声明。

TI 反对并拒绝您可能提出的任何其他或不同的条款。

邮寄地址：Texas Instruments, Post Office Box 655303, Dallas, Texas 75265

Copyright © 2024，德州仪器 (TI) 公司