

FEATURES

- Operating Voltage... ± 2 V to ± 18 V
- Low Offset Voltage...1 mV Max at 25°C, TL5580A
- Wide GBW...12 MHz Typ
- Slew Rate...5 V/ μ s Typ
- Low THD...0.0005% Typ
- Low-Noise Voltage...7 nV/ $\sqrt{\text{Hz}}$ at 1 kHz Typ

APPLICATIONS

- Audio
- Test Equipment
- Industrial Process Controls
- Data-Acquisition Systems
- Active Filters
- Power-Supply Regulation

D, P, OR PW PACKAGE
(TOP VIEW)

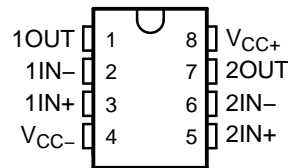

DESCRIPTION/ORDERING INFORMATION

The TL5580 is a dual bipolar operational amplifier that combines both high dc and ac performance with its low offset voltage, high-gain bandwidth, low harmonic distortion, and low-noise characteristics. In addition, its output is capable of driving 600- Ω loads. All these characteristics make the device ideally suited for use in audio, active filtering, and industrial measurement applications.

ORDERING INFORMATION

T_A	V_{IO} (25°C, MAX)	PACKAGE ⁽¹⁾		ORDERABLE PART NUMBER	TOP-SIDE MARKING
-40°C to 85°C	Standard grade 1.5 mV	PDIP – P	Tube of 50	TL5580IP	TL5580IP
		SOIC – D	Tube of 75	TL5580ID	Z5580
			Reel of 2500	TL5580IDR	
	A grade 1 mV	TSSOP – PW	Tube of 150	TL5580IPW	Z5580
			Reel of 2000	TL5580IPWR	
		PDIP – P	Tube of 50	TL5580AIP	TL5580AIP
SOIC – D	Tube of 75		TL5580AID	Z5580A	
	Reel of 2500		TL5580AIDR		
TSSOP – PW	Tube of 150	TL5580AIPW	Z5580A		
	Reel of 2000	TL5580AIPWR			

(1) Package drawings, standard packing quantities, thermal data, symbolization, and PCB design guidelines are available at www.ti.com/sc/package.



Please be aware that an important notice concerning availability, standard warranty, and use in critical applications of Texas Instruments semiconductor products and disclaimers thereto appears at the end of this data sheet.

TL5580, TL5580A DUAL LOW-NOISE WIDE-BANDWIDTH PRECISION AMPLIFIER

SLOS477A—JUNE 2005—REVISED JULY 2005

EQUIVALENT SCHEMATIC

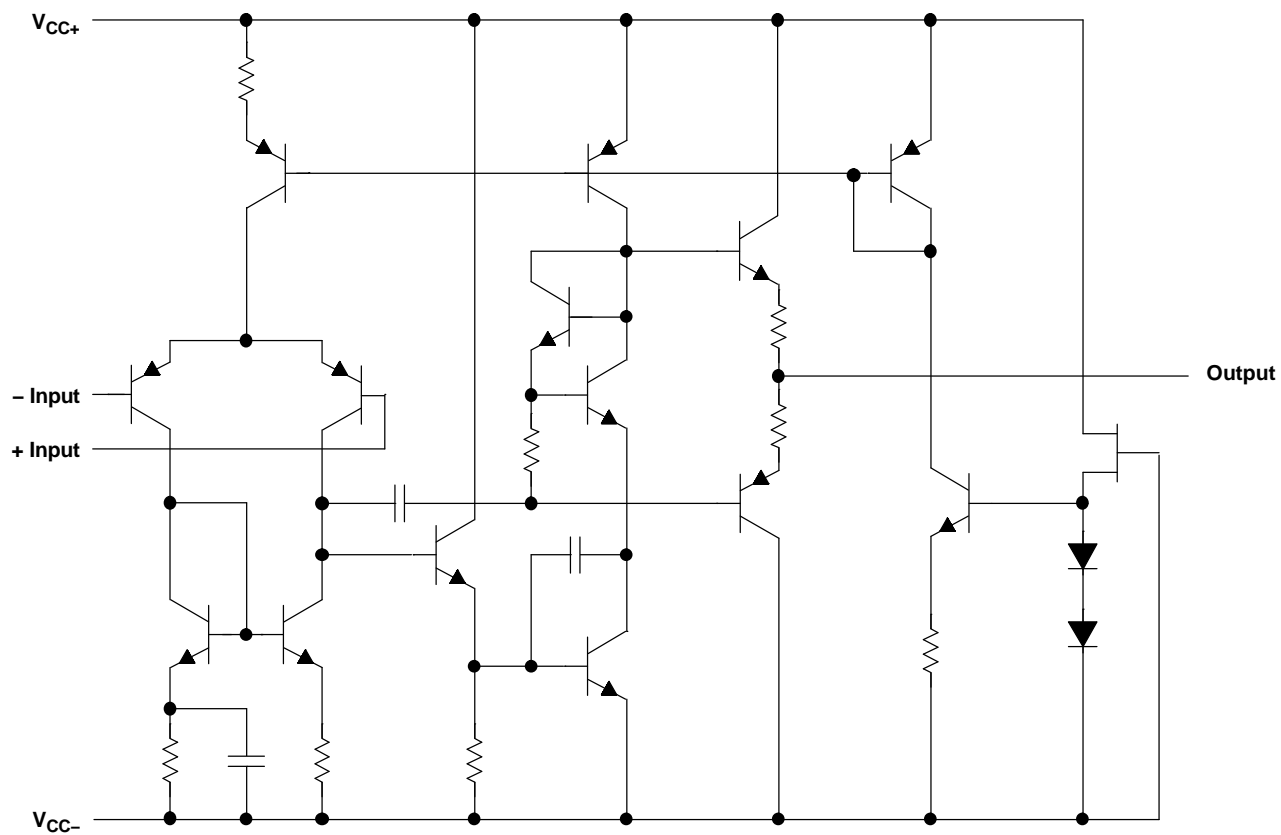

Absolute Maximum Ratings⁽¹⁾

over operating free-air temperature range (unless otherwise noted)

		MIN	MAX	UNIT
$V_{CC\pm}$	Supply voltage		±18	V
V_I	Input voltage (any input)		±15	V
V_{ID}	Differential input voltage		±30	V
I_O	Output current		±50	mA
θ_{JA}	Package thermal impedance ⁽²⁾⁽³⁾	D package	97	°C/W
		P package	85	
		PW package	149	
T_J	Operating virtual junction temperature		150	°C
T_{stg}	Storage temperature range	–60	125	°C

- (1) Stresses beyond those listed under “absolute maximum ratings” may cause permanent damage to the device. These are stress ratings only, and functional operation of the device at these or any other conditions beyond those indicated under “recommended operating conditions” is not implied. Exposure to absolute-maximum-rated conditions for extended periods may affect device reliability.
- (2) Maximum power dissipation is a function of $T_J(\text{max})$, θ_{JA} , and T_A . The maximum allowable power dissipation at any allowable ambient temperature is $P_D = (T_J(\text{max}) - T_A)/\theta_{JA}$. Operating at the absolute maximum T_J of 150°C can affect reliability.
- (3) The package thermal impedance is calculated in accordance with JESD 51-7.

Recommended Operating Conditions

		MIN	MAX	UNIT
V_{CC+}	Supply voltage	2	16	V
V_{CC-}		–2	–16	
T_A	Operating free-air temperature	–40	85	°C

TL5580, TL5580A DUAL LOW-NOISE WIDE-BANDWIDTH PRECISION AMPLIFIER

SLOS477A–JUNE 2005–REVISED JULY 2005

Electrical Characteristics

$V_{CC\pm} = \pm 15\text{ V}$ (unless otherwise noted)

PARAMETER		TEST CONDITIONS	T_A	MIN	TYP	MAX	UNIT
V_{IO}	Input offset voltage	$R_S \leq 10\text{ k}\Omega$	25°C		0.3	1	mV
			-40°C to 85°C			1.35	
			25°C		0.3	1.5	
			-40°C to 85°C			2	
αV_{IO}	Average temperature coefficient of input offset voltage		-40°C to 85°C		1.8	5	$\mu\text{V}/^\circ\text{C}$
I_{IO}	Input offset current		25°C		5	75	nA
			-40°C to 85°C			100	
I_{IB}	Input bias current		25°C		100	500	nA
			-40°C to 85°C			800	
A_{VD}	Large-signal differential-voltage amplification	$R_L \geq 2\text{ k}\Omega$, $V_O = \pm 10\text{ V}$	25°C		90	110	dB
			-40°C to 85°C			87	
V_{OM}	Output voltage swing	$R_L \geq 2\text{ k}\Omega$	25°C		12.75 – 12.25	± 13.5	V
			-40°C to 85°C			12.5 – 12	
V_{ICR}	Common-mode input voltage range		25°C		± 13	± 13.5	V
			-40°C to 85°C			± 12	
CMRR	Common-mode rejection ratio	$R_S \leq 10\text{ k}\Omega$, $V_{ICR} = -12\text{ V to } 12\text{ V}$	25°C		90	110	dB
			-40°C to 85°C			85	
$k_{SVR}^{(1)}$	Supply-voltage rejection ratio	$R_S \leq 10\text{ k}\Omega$	25°C		85	110	dB
			-40°C to 85°C			83	
I_{CC}	Supply current (all amplifiers)		25°C		6	9	mA
			-40°C to 85°C				

(1) Measured with $V_{CC\pm}$ varied simultaneously

Operating Characteristics

$V_{CC\pm} = \pm 15\text{ V}$, $T_A = 25^\circ\text{C}$ (unless otherwise noted)

PARAMETER		TEST CONDITIONS	TYP	UNIT
SR	Slew rate at unity gain	$R_L \geq 2\text{ k}\Omega$	5	$\text{V}/\mu\text{s}$
GBW	Gain bandwidth product	$f = 10\text{ kHz}$	12	MHz
THD	Total harmonic distortion	$V_O = 5\text{ V}$, $R_L = 2\text{ k}\Omega$, $f = 1\text{ kHz}$, $A_{VD} = 20\text{ dB}$	0.0005	%
V_n	Equivalent input noise voltage	$f = 1\text{ kHz}$	7	$\text{nV}/\sqrt{\text{Hz}}$

TYPICAL CHARACTERISTICS

MAXIMUM OUTPUT VOLTAGE SWING
VS
LOAD RESISTANCE

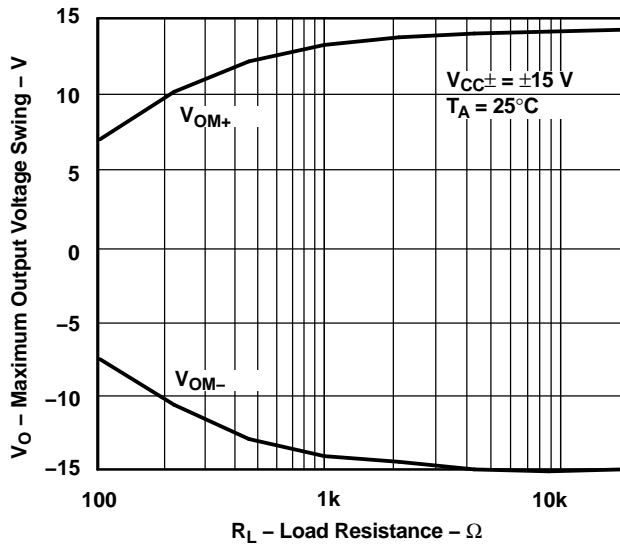

Figure 1.

MAXIMUM OUTPUT VOLTAGE SWING
VS
FREQUENCY

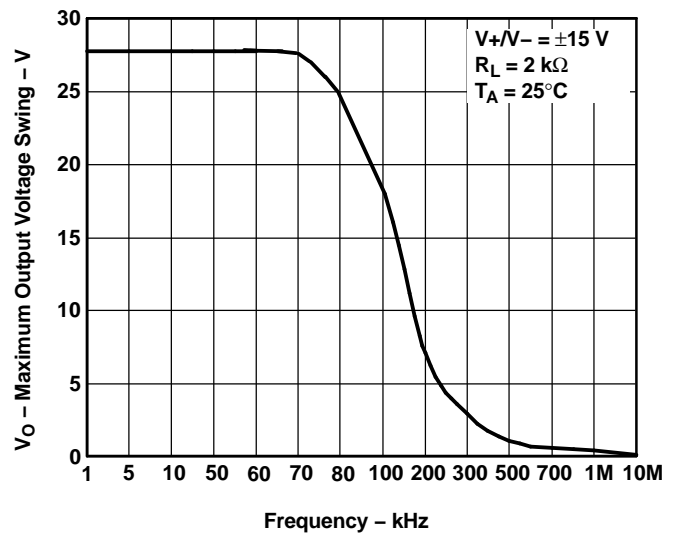

Figure 2.

OUTPUT VOLTAGE SWING
VS
OUTPUT CURRENT

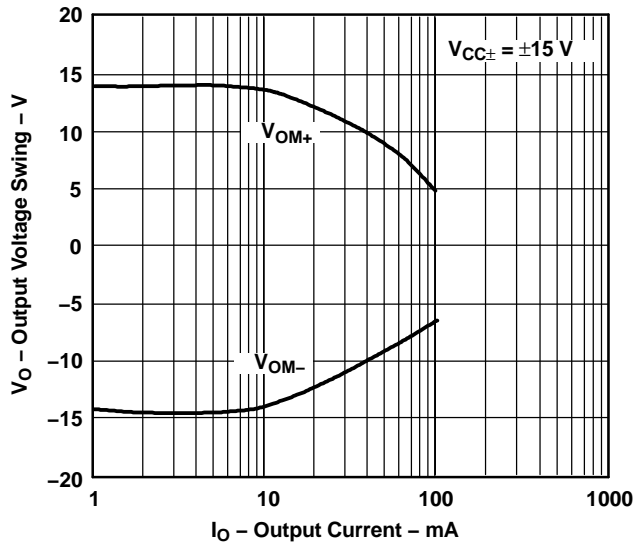

Figure 3.

EQUIVALENT INPUT NOISE VOLTAGE
VS
FREQUENCY

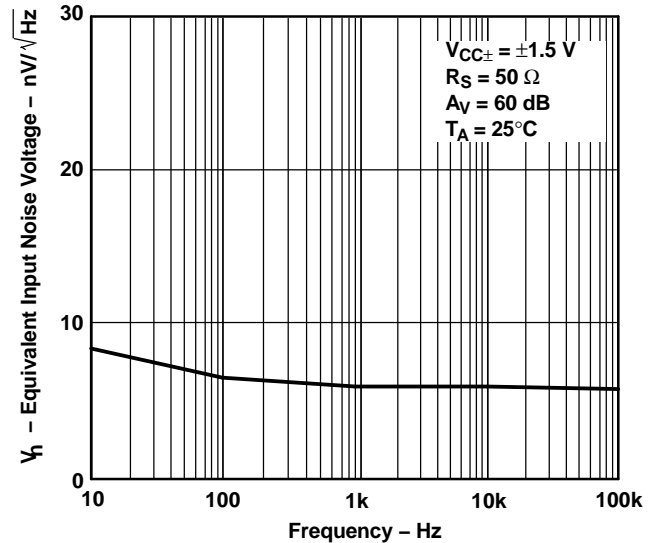

Figure 4.

TYPICAL CHARACTERISTICS (continued)

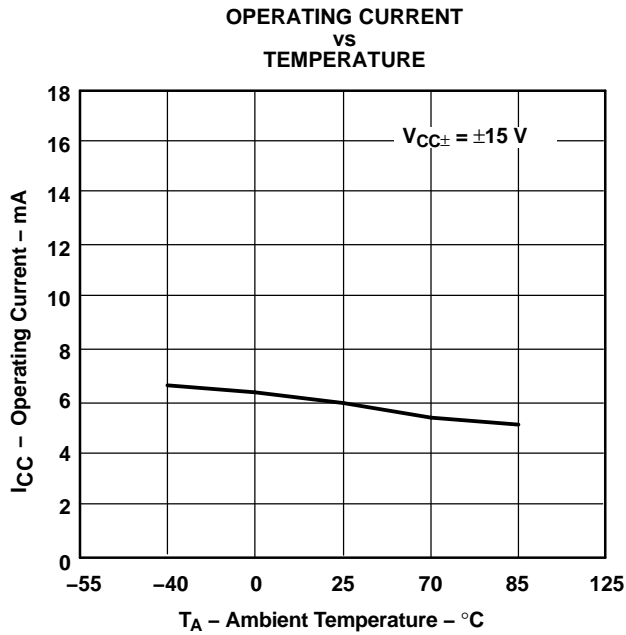

Figure 5.

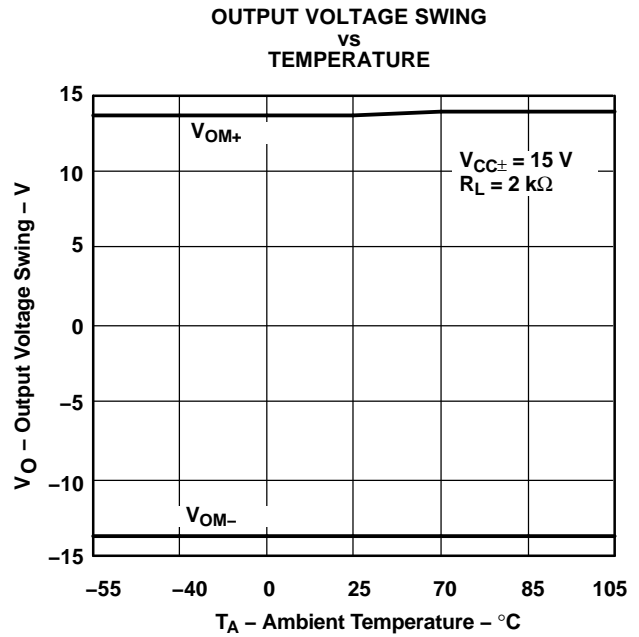

Figure 6.

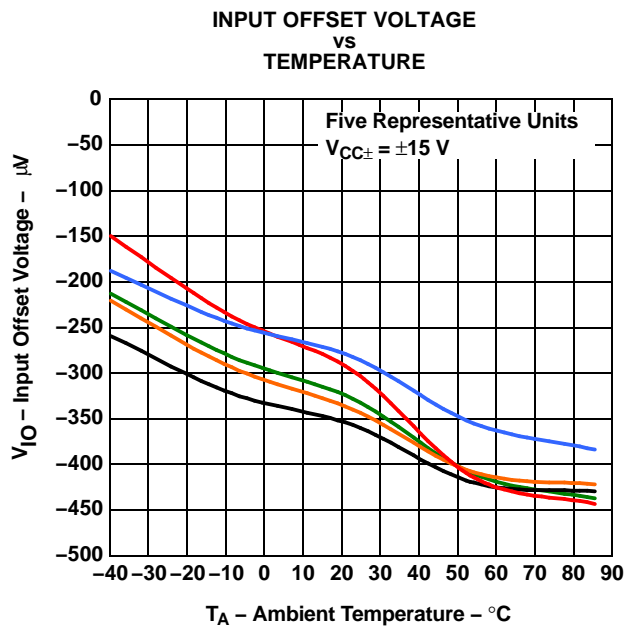

Figure 7.

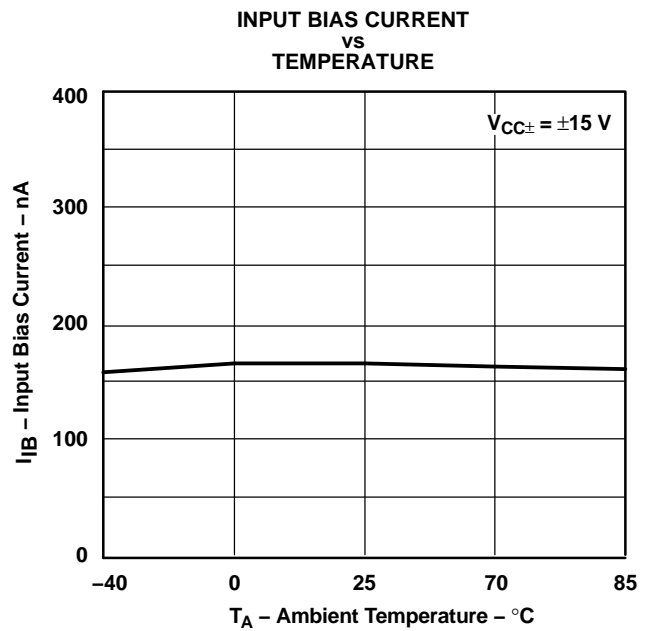

Figure 8.

TYPICAL CHARACTERISTICS (continued)

MAXIMUM OUTPUT VOLTAGE SWING
vs
OPERATING VOLTAGE

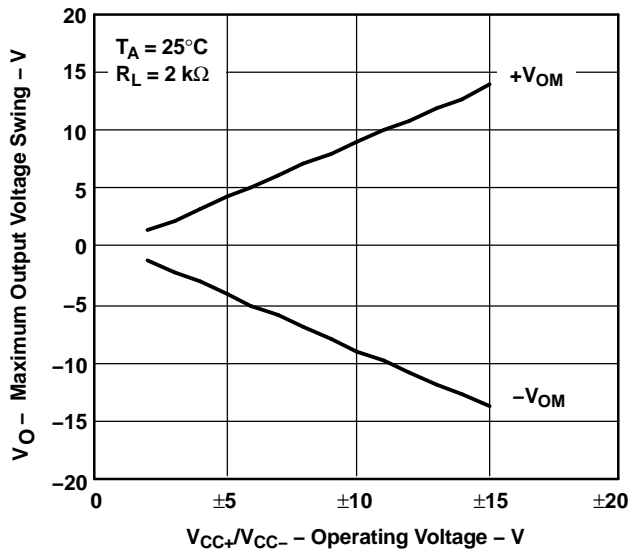

Figure 9.

OPERATING CURRENT
vs
OPERATING VOLTAGE

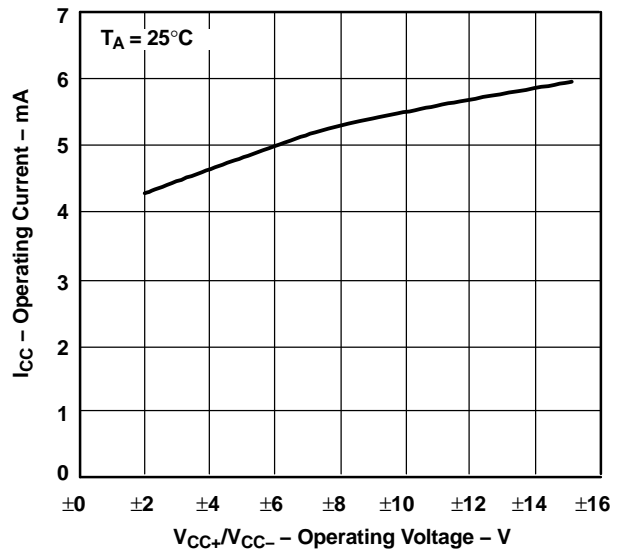

Figure 10.

TOTAL HARMONIC DISTORTION
vs
OUTPUT VOLTAGE

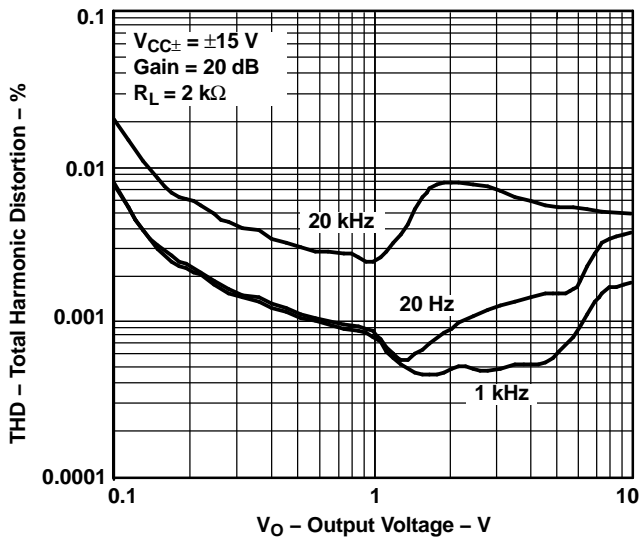

Figure 11.

VOLTAGE GAIN, PHASE
vs
FREQUENCY

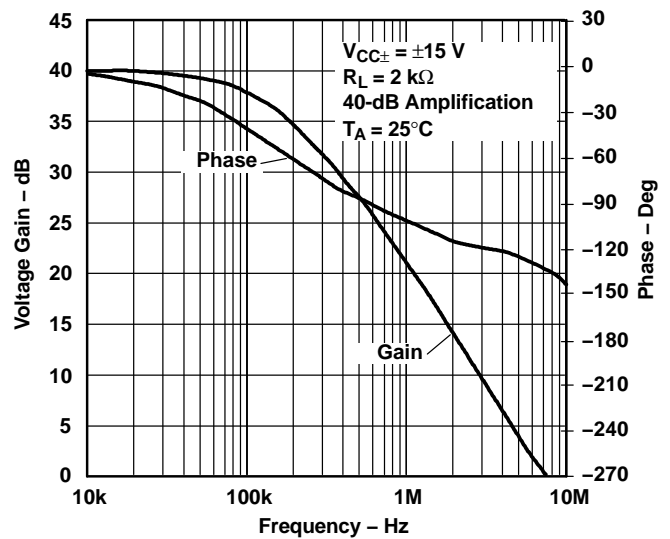

Figure 12.

PACKAGING INFORMATION

Orderable Device	Status (1)	Package Type	Package Drawing	Pins	Package Qty	Eco Plan (2)	Lead finish/ Ball material (6)	MSL Peak Temp (3)	Op Temp (°C)	Device Marking (4/5)	Samples
TL5580AID	OBSOLETE	SOIC	D	8		TBD	Call TI	Call TI	-40 to 85	Z5580A	
TL5580AIDR	ACTIVE	SOIC	D	8	2500	RoHS & Green	NIPDAU	Level-1-260C-UNLIM	-40 to 85	Z5580A	Samples
TL5580AIP	ACTIVE	PDIP	P	8	50	RoHS & Green	NIPDAU	N / A for Pkg Type	-40 to 85	TL5580AIP	Samples
TL5580AIPWR	ACTIVE	TSSOP	PW	8	2000	RoHS & Green	NIPDAU	Level-1-260C-UNLIM	-40 to 85	Z5580A	Samples
TL5580IDR	ACTIVE	SOIC	D	8	2500	RoHS & Green	NIPDAU	Level-1-260C-UNLIM	-40 to 85	Z5580	Samples
TL5580IP	ACTIVE	PDIP	P	8	50	RoHS & Green	NIPDAU	N / A for Pkg Type	-40 to 85	TL5580IP	Samples
TL5580IPWR	ACTIVE	TSSOP	PW	8	2000	RoHS & Green	NIPDAU	Level-1-260C-UNLIM	-40 to 85	Z5580	Samples

(1) The marketing status values are defined as follows:

ACTIVE: Product device recommended for new designs.

LIFEBUY: TI has announced that the device will be discontinued, and a lifetime-buy period is in effect.

NRND: Not recommended for new designs. Device is in production to support existing customers, but TI does not recommend using this part in a new design.

PREVIEW: Device has been announced but is not in production. Samples may or may not be available.

OBSOLETE: TI has discontinued the production of the device.

(2) **RoHS:** TI defines "RoHS" to mean semiconductor products that are compliant with the current EU RoHS requirements for all 10 RoHS substances, including the requirement that RoHS substance do not exceed 0.1% by weight in homogeneous materials. Where designed to be soldered at high temperatures, "RoHS" products are suitable for use in specified lead-free processes. TI may reference these types of products as "Pb-Free".

RoHS Exempt: TI defines "RoHS Exempt" to mean products that contain lead but are compliant with EU RoHS pursuant to a specific EU RoHS exemption.

Green: TI defines "Green" to mean the content of Chlorine (Cl) and Bromine (Br) based flame retardants meet JS709B low halogen requirements of <=1000ppm threshold. Antimony trioxide based flame retardants must also meet the <=1000ppm threshold requirement.

(3) MSL, Peak Temp. - The Moisture Sensitivity Level rating according to the JEDEC industry standard classifications, and peak solder temperature.

(4) There may be additional marking, which relates to the logo, the lot trace code information, or the environmental category on the device.

(5) Multiple Device Markings will be inside parentheses. Only one Device Marking contained in parentheses and separated by a "~" will appear on a device. If a line is indented then it is a continuation of the previous line and the two combined represent the entire Device Marking for that device.

⁽⁶⁾ Lead finish/Ball material - Orderable Devices may have multiple material finish options. Finish options are separated by a vertical ruled line. Lead finish/Ball material values may wrap to two lines if the finish value exceeds the maximum column width.

Important Information and Disclaimer:The information provided on this page represents TI's knowledge and belief as of the date that it is provided. TI bases its knowledge and belief on information provided by third parties, and makes no representation or warranty as to the accuracy of such information. Efforts are underway to better integrate information from third parties. TI has taken and continues to take reasonable steps to provide representative and accurate information but may not have conducted destructive testing or chemical analysis on incoming materials and chemicals. TI and TI suppliers consider certain information to be proprietary, and thus CAS numbers and other limited information may not be available for release.

In no event shall TI's liability arising out of such information exceed the total purchase price of the TI part(s) at issue in this document sold by TI to Customer on an annual basis.

TAPE AND REEL INFORMATION

QUADRANT ASSIGNMENTS FOR PIN 1 ORIENTATION IN TAPE

*All dimensions are nominal

Device	Package Type	Package Drawing	Pins	SPQ	Reel Diameter (mm)	Reel Width W1 (mm)	A0 (mm)	B0 (mm)	K0 (mm)	P1 (mm)	W (mm)	Pin1 Quadrant
TL5580AIDR	SOIC	D	8	2500	330.0	12.4	6.4	5.2	2.1	8.0	12.0	Q1
TL5580AIPWR	TSSOP	PW	8	2000	330.0	12.4	7.0	3.6	1.6	8.0	12.0	Q1
TL5580IDR	SOIC	D	8	2500	330.0	12.4	6.4	5.2	2.1	8.0	12.0	Q1
TL5580IPWR	TSSOP	PW	8	2000	330.0	12.4	7.0	3.6	1.6	8.0	12.0	Q1
TL5580IPWR	TSSOP	PW	8	2000	330.0	12.4	7.0	3.6	1.6	8.0	12.0	Q1

TAPE AND REEL BOX DIMENSIONS



*All dimensions are nominal

Device	Package Type	Package Drawing	Pins	SPQ	Length (mm)	Width (mm)	Height (mm)
TL5580AIDR	SOIC	D	8	2500	340.5	338.1	20.6
TL5580AIPWR	TSSOP	PW	8	2000	356.0	356.0	35.0
TL5580IDR	SOIC	D	8	2500	340.5	338.1	20.6
TL5580IPWR	TSSOP	PW	8	2000	356.0	356.0	35.0
TL5580IPWR	TSSOP	PW	8	2000	353.0	353.0	32.0

TUBE

*All dimensions are nominal

Device	Package Name	Package Type	Pins	SPQ	L (mm)	W (mm)	T (μm)	B (mm)
TL5580AIP	P	PDIP	8	50	506	13.97	11230	4.32
TL5580IP	P	PDIP	8	50	506	13.97	11230	4.32

P (R-PDIP-T8)

PLASTIC DUAL-IN-LINE PACKAGE



- NOTES:
- A. All linear dimensions are in inches (millimeters).
 - B. This drawing is subject to change without notice.
 - C. Falls within JEDEC MS-001 variation BA.

PW0008A



PACKAGE OUTLINE

TSSOP - 1.2 mm max height

SMALL OUTLINE PACKAGE



4221848/A 02/2015

NOTES:

1. All linear dimensions are in millimeters. Any dimensions in parenthesis are for reference only. Dimensioning and tolerancing per ASME Y14.5M.
2. This drawing is subject to change without notice.
3. This dimension does not include mold flash, protrusions, or gate burrs. Mold flash, protrusions, or gate burrs shall not exceed 0.15 mm per side.
4. This dimension does not include interlead flash. Interlead flash shall not exceed 0.25 mm per side.
5. Reference JEDEC registration MO-153, variation AA.

EXAMPLE BOARD LAYOUT

PW0008A

TSSOP - 1.2 mm max height

SMALL OUTLINE PACKAGE



LAND PATTERN EXAMPLE
SCALE:10X



SOLDER MASK DETAILS
NOT TO SCALE

4221848/A 02/2015

NOTES: (continued)

- 6. Publication IPC-7351 may have alternate designs.
- 7. Solder mask tolerances between and around signal pads can vary based on board fabrication site.

EXAMPLE STENCIL DESIGN

PW0008A

TSSOP - 1.2 mm max height

SMALL OUTLINE PACKAGE



SOLDER PASTE EXAMPLE
BASED ON 0.125 mm THICK STENCIL
SCALE:10X

4221848/A 02/2015

NOTES: (continued)

8. Laser cutting apertures with trapezoidal walls and rounded corners may offer better paste release. IPC-7525 may have alternate design recommendations.
9. Board assembly site may have different recommendations for stencil design.



D0008A

PACKAGE OUTLINE

SOIC - 1.75 mm max height

SMALL OUTLINE INTEGRATED CIRCUIT



4214825/C 02/2019

NOTES:

1. Linear dimensions are in inches [millimeters]. Dimensions in parenthesis are for reference only. Controlling dimensions are in inches. Dimensioning and tolerancing per ASME Y14.5M.
2. This drawing is subject to change without notice.
3. This dimension does not include mold flash, protrusions, or gate burrs. Mold flash, protrusions, or gate burrs shall not exceed .006 [0.15] per side.
4. This dimension does not include interlead flash.
5. Reference JEDEC registration MS-012, variation AA.

EXAMPLE BOARD LAYOUT

D0008A

SOIC - 1.75 mm max height

SMALL OUTLINE INTEGRATED CIRCUIT



LAND PATTERN EXAMPLE
 EXPOSED METAL SHOWN
 SCALE:8X



SOLDER MASK DETAILS

4214825/C 02/2019

NOTES: (continued)

- 6. Publication IPC-7351 may have alternate designs.
- 7. Solder mask tolerances between and around signal pads can vary based on board fabrication site.

EXAMPLE STENCIL DESIGN

D0008A

SOIC - 1.75 mm max height

SMALL OUTLINE INTEGRATED CIRCUIT



SOLDER PASTE EXAMPLE
BASED ON .005 INCH [0.125 MM] THICK STENCIL
SCALE:8X

4214825/C 02/2019

NOTES: (continued)

8. Laser cutting apertures with trapezoidal walls and rounded corners may offer better paste release. IPC-7525 may have alternate design recommendations.
9. Board assembly site may have different recommendations for stencil design.

IMPORTANT NOTICE AND DISCLAIMER

TI PROVIDES TECHNICAL AND RELIABILITY DATA (INCLUDING DATA SHEETS), DESIGN RESOURCES (INCLUDING REFERENCE DESIGNS), APPLICATION OR OTHER DESIGN ADVICE, WEB TOOLS, SAFETY INFORMATION, AND OTHER RESOURCES "AS IS" AND WITH ALL FAULTS, AND DISCLAIMS ALL WARRANTIES, EXPRESS AND IMPLIED, INCLUDING WITHOUT LIMITATION ANY IMPLIED WARRANTIES OF MERCHANTABILITY, FITNESS FOR A PARTICULAR PURPOSE OR NON-INFRINGEMENT OF THIRD PARTY INTELLECTUAL PROPERTY RIGHTS.

These resources are intended for skilled developers designing with TI products. You are solely responsible for (1) selecting the appropriate TI products for your application, (2) designing, validating and testing your application, and (3) ensuring your application meets applicable standards, and any other safety, security, regulatory or other requirements.

These resources are subject to change without notice. TI grants you permission to use these resources only for development of an application that uses the TI products described in the resource. Other reproduction and display of these resources is prohibited. No license is granted to any other TI intellectual property right or to any third party intellectual property right. TI disclaims responsibility for, and you will fully indemnify TI and its representatives against, any claims, damages, costs, losses, and liabilities arising out of your use of these resources.

TI's products are provided subject to [TI's Terms of Sale](#) or other applicable terms available either on [ti.com](https://www.ti.com) or provided in conjunction with such TI products. TI's provision of these resources does not expand or otherwise alter TI's applicable warranties or warranty disclaimers for TI products.

TI objects to and rejects any additional or different terms you may have proposed.

Mailing Address: Texas Instruments, Post Office Box 655303, Dallas, Texas 75265
Copyright © 2024, Texas Instruments Incorporated