

支持高达 50mA/200mA 输出电流的可编程输出电压超低功耗降压转换器

 查询样品: [TPS62736](#), [TPS62737](#)

特性

- 低输出电流方面行业最高效率: $I_{\text{输出}} = 15\mu\text{A}$ 时大于 **90%**
- 超低功耗降压转换器
 - **TPS62736** 针对 **50mA** 输出电流进行了优化
 - **TPS62737** 针对 **200mA** 输出电流进行了优化
 - **1.3V-5V** 电阻器可编程输出电压范围
 - **2V-5.5V** 输入工作范围
 - 对于 **TPS62736/TPS62737**, 有源运行期间, **380nA/375nA** 的静态电流
 - 出厂模式运行期间, **10nA** 静态电流
 - **2%** 电压调节精度
- **100%** 占空比 (直通模式)
- **EN1** 和 **EN2** 控制
 - 两个断电状态:
 - **1)** 出厂模式 (完全断电状态)
 - **2)** 包括 **VIN_OK** 指示在内的待机模式
- 输入电源正常指示 (**VIN_OK**)
 - 推挽驱动器
 - 电阻器可编程阈值电平

应用范围

- 超低功耗应用
- **2** 节和 **3** 节碱性电池供电类应用
- 能量采集
- 太阳能充电器
- 热电发电机 (**TEG**) 能量采集
- 无线传感器网络 (**WSN**)
- 低功耗无线监测
- 环境监测
- 桥梁和结构健康监测 (**SHM**)
- 智能楼宇控制
- 便携式和可佩戴式健康器件
- 娱乐系统遥控

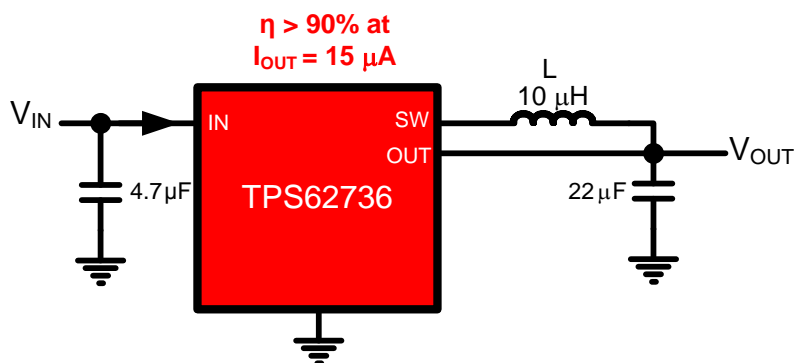
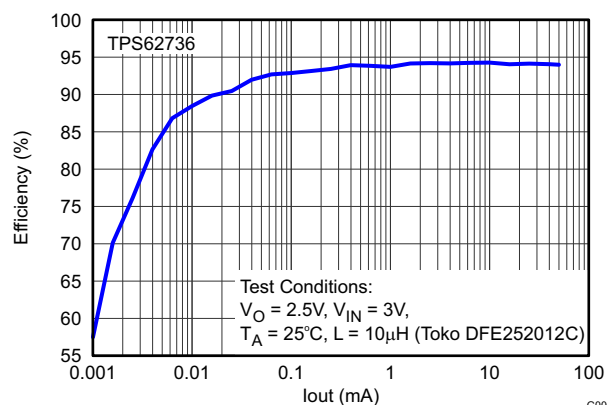

Please be aware that an important notice concerning availability, standard warranty, and use in critical applications of Texas Instruments semiconductor products and disclaimers thereto appears at the end of this data sheet.



These devices have limited built-in ESD protection. The leads should be shorted together or the device placed in conductive foam during storage or handling to prevent electrostatic damage to the MOS gates.

说明

TPS6273X 系列提供了一个高度集成的超低功耗降压转换器解决方案，此解决方案非常适合于满足诸如能量采集等超低功耗应用的特殊需要。为了保持与一个线性降压转换器相对电源管理级的总体效率，TPS6273X 提供具有一个外部可编程经稳压电源的系统。为了给低压电子器件供电，这个稳压器用于来自诸如电池或者超大电容器等储能元件的电压降低。为了在整个低输出电流 (<10 μ A) 到高电流 (200mA) 的转换过程中提供高效率，已经对经稳压的输出进行了优化。

TPS6273X 集成了一个针对低功耗应用的已优化的滞后控制器。为了减少平均静态电流，内部电路采用一个基于时间的采样系统。

为了帮助用户进一步严格管理他们的能耗预算，当输入电源上的电压已经下降到低于一个预先设定的关键电平以下时，TPS6273X 切换输入正常指示器，向一个已连接的微控制器发出一个信号。这个信号用于触发负载电流衰减，以防止系统进入一个欠压条件。还有独立使能信号来使系统能够控制转换器是否调节输出，还是只监视输入电压，或者在超低静态睡眠状态中关断。

输入正常阈值和输出稳压器电平是由外部电阻器独立设定的。

TPS6273X 的全部功能被封装在一个小封装尺寸 14 接线 3.5mm x 3.5mm 四方扁平无引线 (QFN) 封装。

ORDERING INFORMATION

T _A	PART NO.	OUTPUT VOLTAGE	MAX OUTPUT CURRENT	INPUT UVLO	ORDERING NUMBER (TAPE AND REEL)	PACKAGE MARKING	QUANTITY
-40°C to 85°C	TPS62736 ⁽¹⁾	Resistor Programmable	50 mA	2 V	TPS62736RGYR	TPS62736	3000
					TPS62736RGYT		250
-20°C to 85°C	TPS62737 ⁽¹⁾	Resistor Programmable	200 mA	2V	TPS62737RGYR	TPS62737	3000
					TPS62737RGYT		250

(1) The RGY package is available in tape on reel. Add R suffix to order quantities of 3000 parts per reel, T suffix for 250 parts per reel.

ABSOLUTE MAXIMUM RATINGS⁽¹⁾

over operating free-air temperature range (unless otherwise noted)

			VALUE ⁽²⁾		UNIT	
			MIN	MAX		
	Pin voltage	Input voltage range on IN, EN1, EN2, VRDIV, VIN_OK_SET, VOUT_SET, VIN_OK, OUT, SW,NC		-0.3	5.5	V
TPS62736	Peak currents	IN, OUT			100	mA
TPS62737	Peak currents	IN, OUT			370	mA
T _J	Temperature range	Operating junction temperature range		-40	125	°C
T _{STG}		Storage temperature range		-65	150	°C
ESD ⁽³⁾	Human Body Model - (HBM)				1	kV
	Machine Model (MM)				150	V
	Charge Device Model - (CDM)				500	V

(1) Stresses beyond those listed under “absolute maximum ratings” may cause permanent damage to the device. These are stress ratings only and functional operation of the device at these or any other conditions beyond those indicated under “recommended operating conditions” is not implied. Exposure to absolute-maximum-rated conditions for extended periods may affect device reliability.

(2) All voltage values are with respect to VSS/ground terminal

(3) ESD testing is performed according to the respective JEDEC standard.

THERMAL INFORMATION

THERMAL METRIC ⁽¹⁾		RGY	UNITS
		14-Pins	
θ_{JA}	Junction-to-ambient thermal resistance	33.7	°C/W
θ_{JcTop}	Junction-to-case (top) thermal resistance	37.6	
θ_{JB}	Junction-to-board thermal resistance	10.1	
Ψ_{JT}	Junction-to-top characterization parameter	0.4	
Ψ_{JB}	Junction-to-board characterization parameter	10.3	
θ_{JcBot}	Junction-to-case (bottom) thermal resistance	2.9	

(1) For more information about traditional and new thermal metrics, see the *IC Package Thermal Metrics* application report, [SPRA953](#).

RECOMMENDED OPERATING CONDITIONS

		MIN	NOM	MAX	UNIT
IN	IN voltage range	2		5.5	V
C_{IN}	TPS62736 Input Capacitance	4.7			μF
	TPS62737 Input Capacitance	22			
C_{OUT}	Output Capacitance	10	22		μF
$R_1 + R_2 + R_3$	Total Resistance for setting reference voltage		13		MΩ
L_{BUCK}	TPS62736 Inductance	4.7	10		μH
	TPS62737 Inductance	10			
T_A	TPS62736 Operating free air ambient temperature	-40		85	°C
	TPS62737 Operating free air ambient temperature	-20		85	
T_J	Operating junction temperature	-40		105	°C

ELECTRICAL CHARACTERISTICS

Over recommended ambient temperature range, typical values are at $T_A = 25^\circ\text{C}$. Unless otherwise noted, specifications apply for conditions of $V_{IN} = 4.2\text{ V}$, $V_{OUT} = 1.8\text{ V}$ External components, $C_{IN} = 4.7\text{ }\mu\text{F}$ for TPS62736 and $22\text{ }\mu\text{F}$ for TPS62737, $L_{BUCK} = 10\text{ }\mu\text{H}$, $C_{OUT} = 22\text{ }\mu\text{F}$

PARAMETER		TEST CONDITIONS	MIN	TYP	MAX	UNIT	
QUIESCENT CURRENTS							
I_Q	TPS62736 Buck enabled state (EN1 = 0, EN2 = 1)	$V_{IN} = 2\text{ V}$, No load on V_{OUT}		380	550	nA	
	TPS62736 Buck disabled VIN_OK active state (EN1 = 0, EN2 = 0)			340	520		
	TPS62736 Ship mode state (EN1 = 1, EN2 = x)			10	65		
	TPS62737 Buck enabled state (EN1 = 0, EN2 = 1)				375	600	nA
	TPS62737 Buck disabled VIN_OK active state (EN1 = 0, EN2 = 0)				345	560	
	TPS62737 Ship mode state (EN1 = 1, EN2 = x)				11	45	

ELECTRICAL CHARACTERISTICS (continued)

Over recommended ambient temperature range, typical values are at $T_A = 25^\circ\text{C}$. Unless otherwise noted, specifications apply for conditions of $V_{IN} = 4.2\text{ V}$, $V_{OUT} = 1.8\text{ V}$ External components, $C_{IN} = 4.7\ \mu\text{F}$ for TPS62736 and $22\ \mu\text{F}$ for TPS62737, $L_{BUCK} = 10\ \mu\text{H}$, $C_{OUT} = 22\ \mu\text{F}$

PARAMETER		TEST CONDITIONS	MIN	TYP	MAX	UNIT
OUTPUT						
V_{BIAS}	Output regulation reference		1.205	1.21	1.217	V
V_{OUT}	TPS62736 Output regulation (<i>Spec does not include the resistor accuracy error</i>)	$I_{OUT} = 10\text{ mA}$; $1.3\text{ V} < V_{OUT} < 3.3\text{ V}$	-2%	0%	2%	
	TPS62737 Output regulation (<i>Spec does not include the resistor accuracy error</i>)	$I_{OUT} = 100\text{ mA}$; $1.3\text{ V} < V_{OUT} < 3.3\text{ V}$;	-2%	0%	2%	
	TPS62736 Output line regulation	$I_{OUT} = 100\ \mu\text{A}$; $V_{IN} = 2.4\text{ V}$ to 5.5 V		0.01		%V
	TPS62737 Output line regulation	$I_{OUT} = 10\text{ mA}$; $V_{IN} = 2.3\text{ V}$ to 5.5 V		0.31		
	TPS62736 Output load regulation	$I_{OUT} = 100\ \mu\text{A}$ to 50 mA , $V_{IN} = 2.2\text{ V}$		0.01		%mA
	TPS62737 Output load regulation	$I_{OUT} = 100\ \mu\text{A}$ to 200 mA , $V_{IN} = 2.2\text{ V}$; $-20^\circ\text{C} < T_A < 85^\circ\text{C}$		0.01		%mA
	TPS62736 Output ripple	$V_{IN} = 4.2\text{ V}$, $I_{OUT} = 1\text{ mA}$, $C_{OUT} = 22\ \mu\text{F}$		20		mVpp
	TPS62737 Output ripple	$V_{IN} = 4.2\text{ V}$, $I_{OUT} = 1\text{ mA}$, $C_{OUT} = 22\ \mu\text{F}$		40		mVpp
	Programmable voltage range for output voltage threshold	$I_{OUT} = 10\text{ mA}$	1.3		$V_{IN} - 0.2$	V
V_{DO}	TPS62736 Drop-out-voltage when V_{IN} is less than $V_{OUT(SET)}$	$V_{IN} = 2.1\text{ V}$, $V_{OUT(SET)} = 2.5\text{ V}$, $I_{OUT} = 10\text{ mA}$, 100% duty cycle		24	30	mV
	TPS62737 Drop-out-voltage when V_{IN} is less than $V_{OUT(SET)}$	$V_{IN} = 2.1\text{ V}$, $V_{OUT(SET)} = 2.5\text{ V}$, $I_{OUT} = 100\text{ mA}$, 100% duty cycle		180	220	mV
$t_{START-STBY}$	Startup time with EN1 low and EN2 transition to high (Standby Mode)	TPS62736, $C_{OUT} = 22\ \mu\text{F}$		400		μs
		TPS62737, $C_{OUT} = 22\ \mu\text{F}$		300		μs
$t_{START-SHIP}$	Startup time with EN2 high and EN1 transition from high to low (Ship Mode)	$C_{OUT} = 22\ \mu\text{F}$		100		ms
POWER SWITCH						
$R_{DS(on)}$	TPS62736 High side switch ON resistance	$V_{IN} = 3\text{ V}$		2.4	3	Ω
	TPS62736 Low side switch ON resistance	$V_{IN} = 3\text{ V}$		1.1	1.5	Ω
	TPS62737 High side switch ON resistance	$V_{IN} = 2.1\text{ V}$		1.8	2.2	Ω
	TPS62737 Low side switch ON resistance	$V_{IN} = 2.1\text{ V}$		0.9	1.3	Ω
I_{LIM}	TPS62736 Cycle-by-cycle current limit	$2.4\text{ V} < V_{IN} < 5.25\text{ V}$; $1.3\text{ V} < V_{OUT} < 3.3\text{ V}$	68	86	100	mA
	TPS62737 Cycle-by-cycle current limit	$2.4\text{ V} < V_{IN} < 5.25\text{ V}$; $1.3\text{ V} < V_{OUT} < 3.3\text{ V}$; $-20^\circ\text{C} < T_A < 85^\circ\text{C}$	295	340	370	mA
f_{SW}	Max switching frequency			2		MHz
INPUT						
$V_{IN-UVLO}$	Input under voltage protection	V_{IN} falling	1.91	1.95	2	V
V_{IN-OK}	Input power good programmable voltage range		2		5.5	V
$V_{IN-OK-ACC}$	TPS62736 Accuracy of V_{IN-OK} setting	V_{IN} increasing	-2		2	%
	TPS62737 Accuracy of V_{IN-OK} setting		-3		3	
$V_{IN-OK-HYS}$	Fixed hysteresis on V_{IN_OK} threshold, OK_HYST	V_{IN} increasing		40		mV
V_{IN_OK-OH}	V_{IN_OK} output high threshold voltage	Load = $10\ \mu\text{A}$		$V_{IN} - 0.2$		V
V_{IN_OK-OL}	V_{IN_OK} output low threshold voltage				0.1	V
EN1 and EN2						
V_{IH}	Voltage for EN High setting. Relative to V_{IN}	$V_{IN} = 4.2\text{ V}$		$V_{IN} - 0.2$		V
V_{IL}	Voltage for EN Low setting.				0.2	V

PIN ASSIGNMENTS

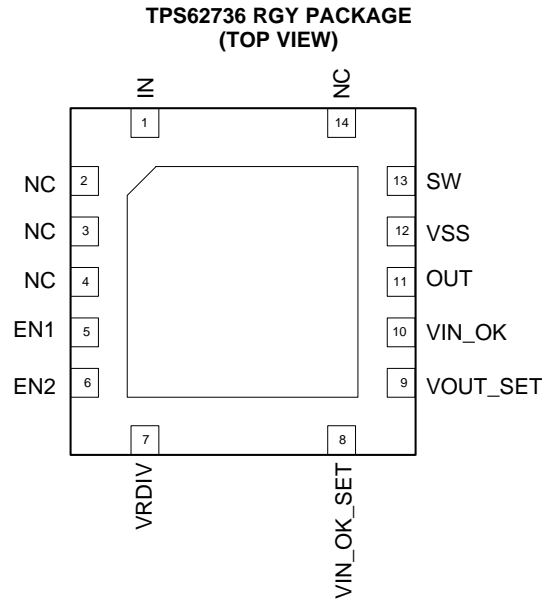

PIN DESCRIPTION

PIN			
NO.	NAME	I/O Type	Description
1	IN	Input	Input supply to the buck regulator
2	NC	Input	Connect to VSS
3	NC	Input	Connect to VSS
4	NC	Input	Connect to VSS
5	EN1	Input	Digital input for chip enable, standby, and ship-mode. EN1 = 1 sets ship mode independent of EN2. EN1=0, EN2 = 0 disables the buck converter and sets standby mode. EN1=0, EN2=1 enables the buck converter. Do not leave either pin floating.
6	EN2	Input	
7	VRDIV	Output	Resistor divider biasing voltage
8	VIN_OK_SET	Input	Resistor divider input for VIN_OK threshold. Pull to VIN to disable. Do not leave pin floating.
9	VOUT_SET	Input	Resistor divider input for VOUT regulation level
10	VIN_OK	Output	Push-pull digital output for power good indicator for the input voltage. Pulled up to VIN pin.
11	OUT	Output	Step down (buck) regulator output
12	VSS	Input	Ground connection for the device
13	SW	Input	Inductor connection to switching node
14	NC	Input	Connect to VSS
15	Thermal Pad	Input	Connect to VSS

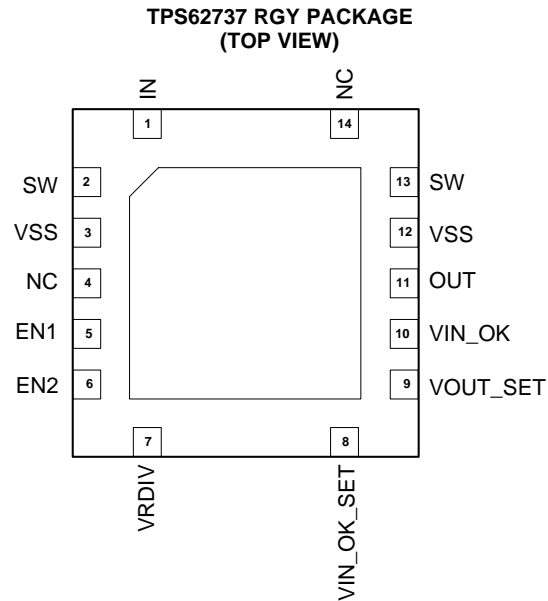

PIN DESCRIPTION

PIN			
NO.	NAME	I/O Type	Description
1	IN	Input	Input supply to the buck regulator
2, 13	SW	Input	Inductor connection to switching node
3, 12	VSS	Input	Ground connection for the device
4, 14	NC	Input	Connect to VSS
5	EN1	Input	Digital input for chip enable, standby, and ship-mode. EN1 = 1 sets ship mode independent of EN2. EN1=0, EN2 = 0 disables the buck converter and sets standby mode. EN1=0, EN2=1 enables the buck converter. Do not leave either pin floating.
6	EN2	Input	
7	VRDIV	Output	Resistor divider biasing voltage
8	VIN_OK_SET	Input	Resistor divider input for VIN_OK threshold. Pull to VIN to disable. Do not leave pin floating.
9	VOUT_SET	Input	Resistor divider input for VOUT regulation level
10	VIN_OK	Output	Push-pull digital output for power good indicator for the input voltage. Pulled up to VIN pin.
11	OUT	Output	Step down (buck) regulator output
15	Thermal Pad	Input	Connect to VSS

FUNCTIONAL BLOCK DIAGRAM

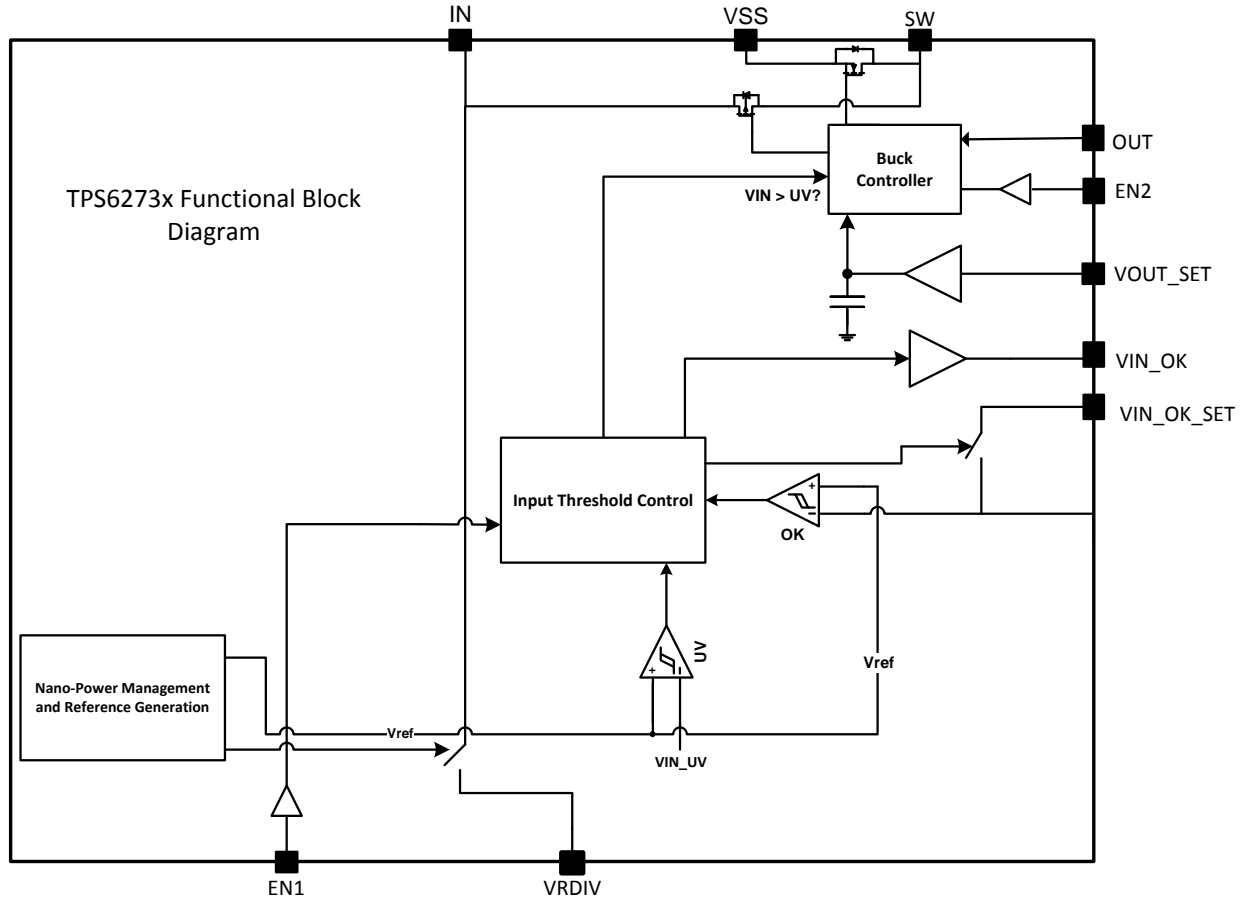

TYPICAL APPLICATION SCHEMATIC

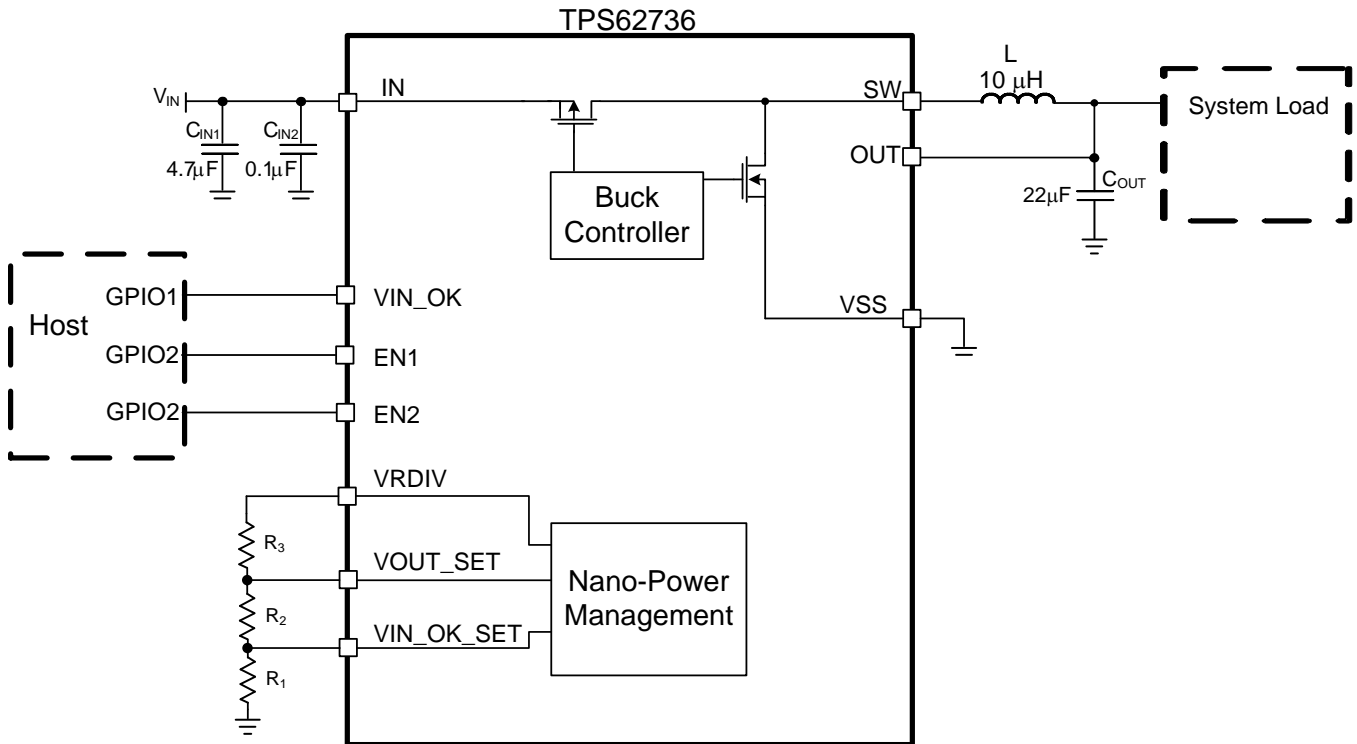

Figure 1. Typical Application Circuit for a 3-resistor String

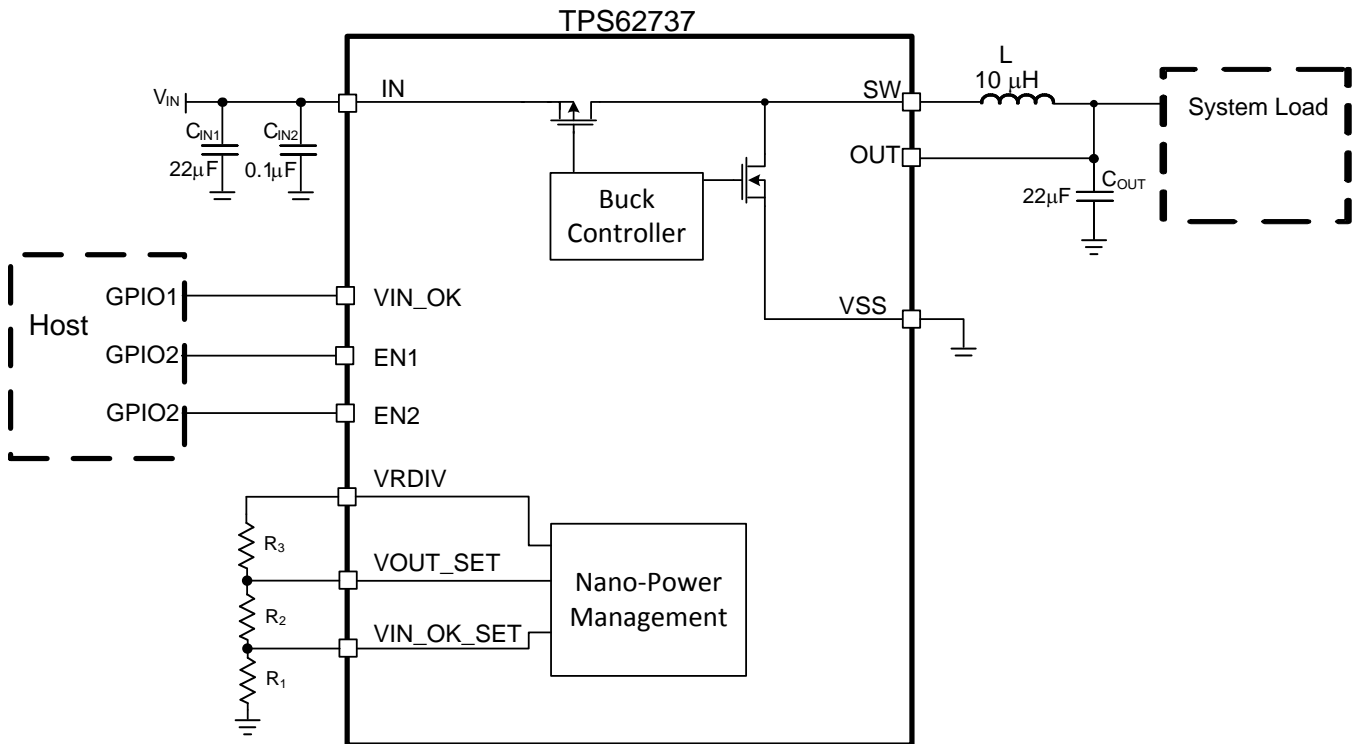

Figure 2. Typical Application Circuit

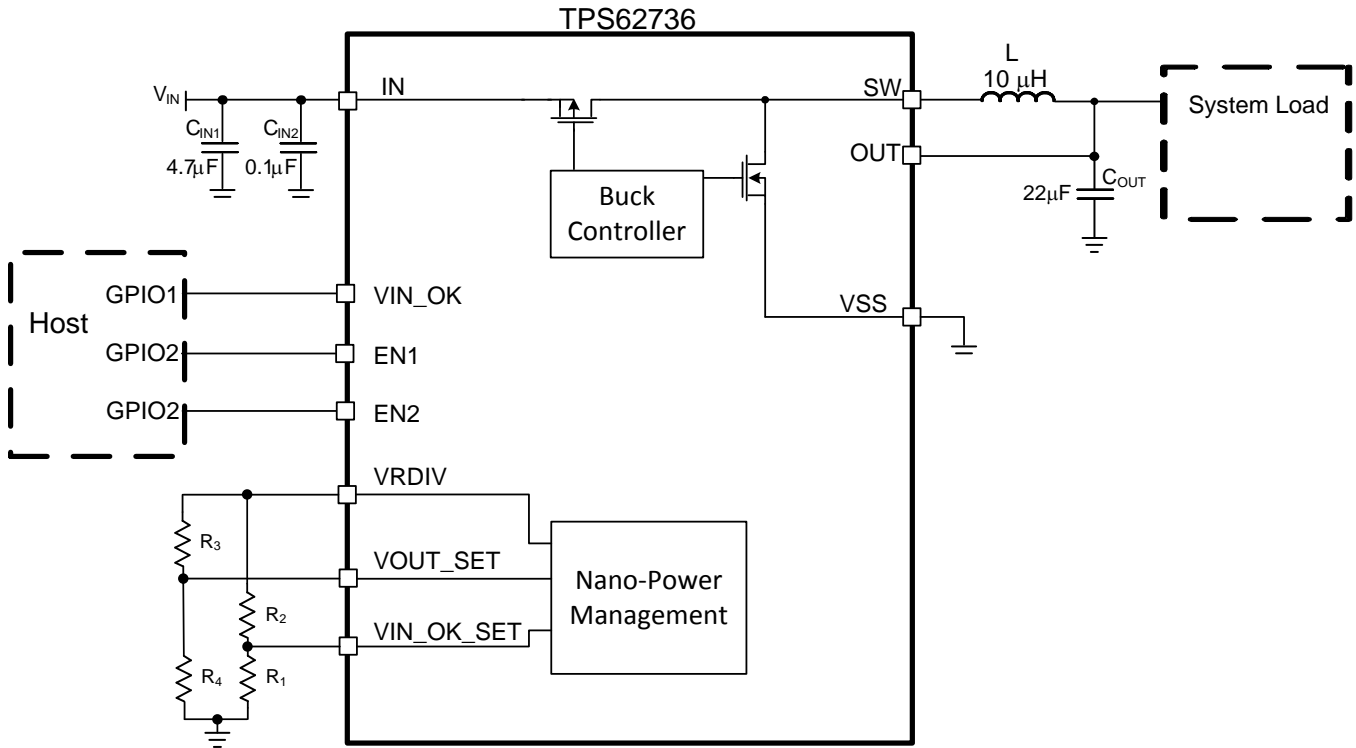

Figure 3. Typical Application Circuit for a 4-resistor String

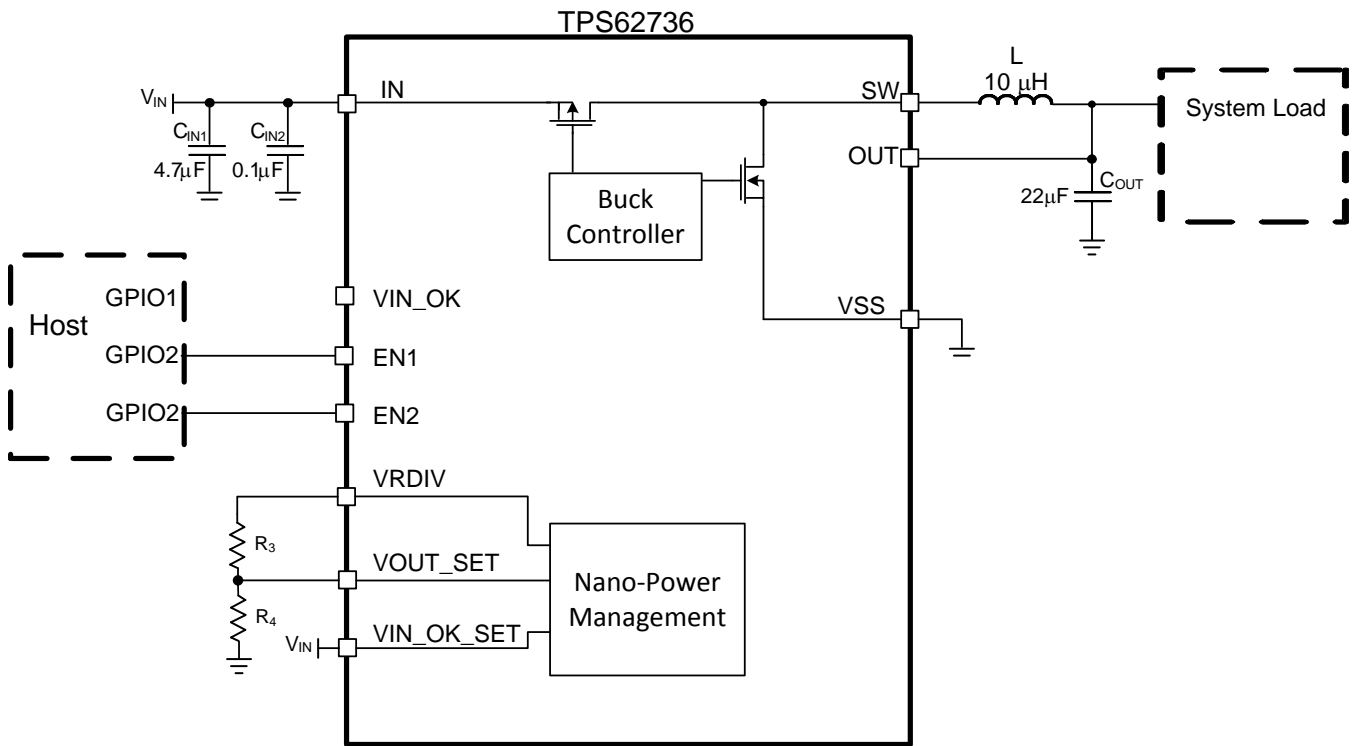

Figure 4. Typical Application Circuit for Disabling VIN_OK

TYPICAL CHARACTERISTICS

Table of Graphs for TPS62736

Unless otherwise noted, graphs were taken using Figure 1 with L = Toko 10 μ H DFE252012C			FIGURE
η	$V_O = 2.5$ V Efficiency	vs. Output Current	Figure 5
		vs. Input Voltage	Figure 6
	$V_O = 1.8$ V Efficiency	vs. Output Current	Figure 7
		vs. Input Voltage	Figure 8
	$V_O = 1.3$ V Efficiency	vs. Output Current	Figure 9
		vs. Input Voltage	Figure 10
V_{OUT} (DC)	$V_O = 2.5$ V	vs. Output Current	Figure 11
		vs. Input Voltage	Figure 12
		vs. Temperature	Figure 13
	$V_O = 1.8$ V	vs. Output Current	Figure 14
		vs. Input Voltage	Figure 15
		vs. Temperature	Figure 16
	$V_O = 1.3$ V	vs. Output Current	Figure 17
		vs. Input Voltage	Figure 18
		vs. Temperature	Figure 19
I_{OUT} MAX (DC)	$V_O = 2.5$ V	vs. Input Voltage	Figure 20
	$V_O = 1.8$ V		Figure 21
	$V_O = 1.3$ V		Figure 22
Input IQ	EN1 = 1, EN2 = 0 (Ship Mode)	vs. Input Voltage	Figure 23
	EN1 = 0, EN2 = 0 (Standby Mode)		Figure 24
	EN1 = 0, EN2 = 1 (Active Mode)		Figure 25
Switching Frequency	$V_O = 2.5$ V	vs. Output Current	Figure 27
		vs. Input Voltage	Figure 28
Output Ripple	$V_O = 2.5$ V	vs. Output Current	Figure 29
		vs. Input Voltage	Figure 30
Steady State Operation	$V_{IN} = 3$ V, $V_O = 2.5$ V	$R_O = 50 \Omega$	Figure 31
		$R_O = 100$ k Ω	Figure 32
	$V_{IN} = 3$ V, $V_O = 1.8$ V, L = 4.7 μ H	$R_O = 50 \Omega$	Figure 33
Power Management Response	VRDIV Behavior	$V_O = 2.5$ V	Figure 34
Transient Response	$V_O = 2.5$ V	Line Transient, $V_{IN} = 3.0$ V -> 5.0V, $R_{OUT} = 50 \Omega$	Figure 35
		Load Transient, $V_{IN} = 4.0$ V, $R_{OUT} =$ none -> 50 Ω	Figure 36
		IR Pulse Transient, $V_{IN} = 4.0$ V, 200mA transient every 1us	Figure 37
Startup Behavior	$V_{IN} = 4.0$ V, $V_O = 1.8$ V	EN1 1 to 0, EN2=1 - Ship mode startup	Figure 38
		EN1 = 0, EN2 0 to 1 - Standby mode startup	Figure 39

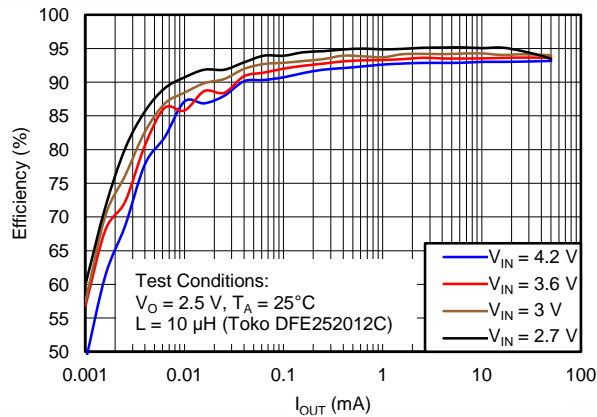

Figure 5. Efficiency Vs Output Current, $V_{OUT} = 2.5 V$

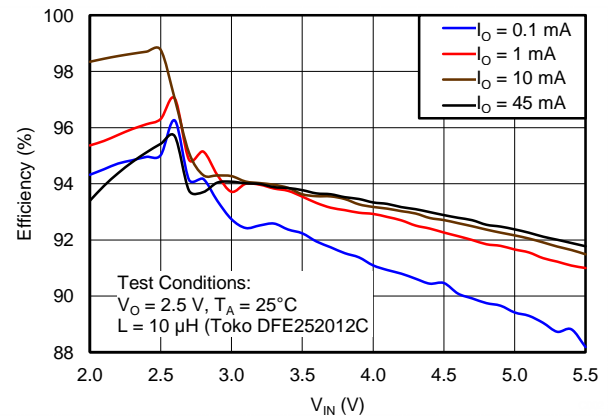

Figure 6. Efficiency vs Input Voltage, $V_{OUT} = 2.5 V$

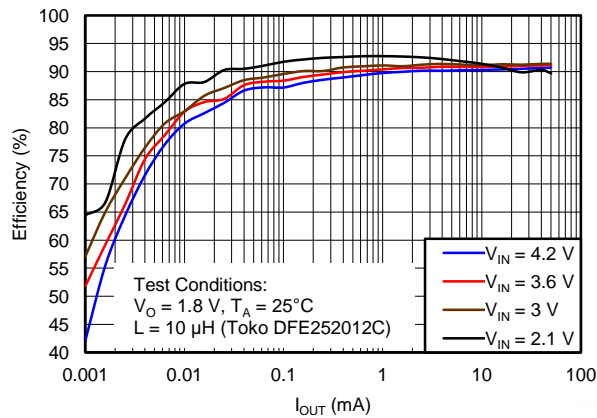

Figure 7. Efficiency Vs Output Current, $V_{OUT} = 1.8 V$

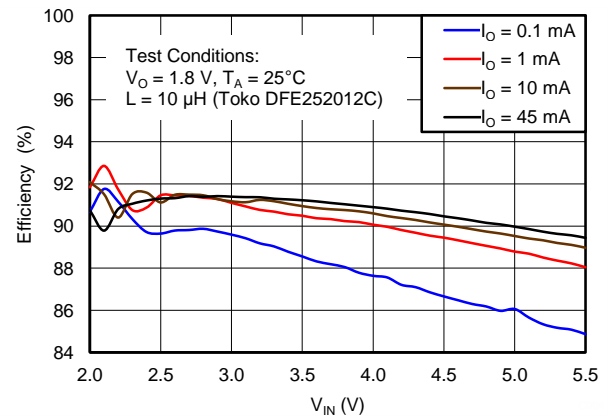

Figure 8. Efficiency vs Input Voltage, $V_{OUT} = 1.8 V$

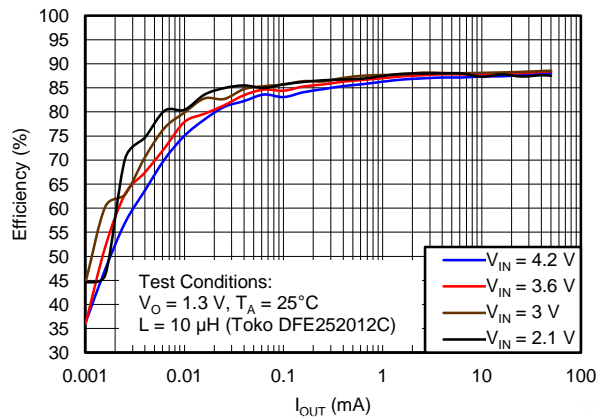

Figure 9. Efficiency Vs Output Current, $V_{OUT} = 1.3 V$

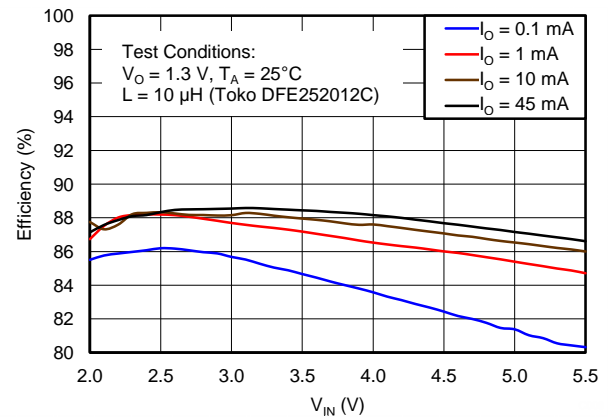

Figure 10. Efficiency vs Input Voltage, $V_{OUT} = 1.3 V$

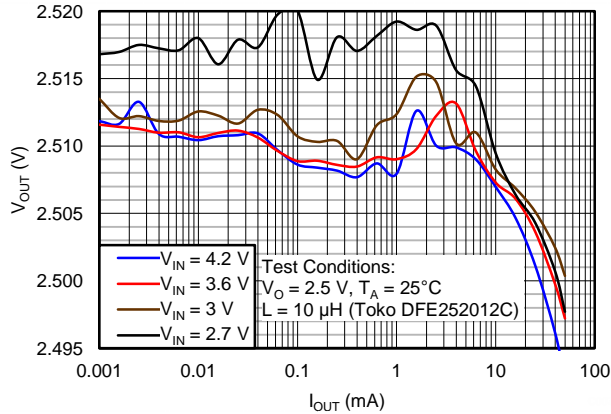

Figure 11. Output Voltage vs Output Current, $V_{OUT} = 2.5$ V

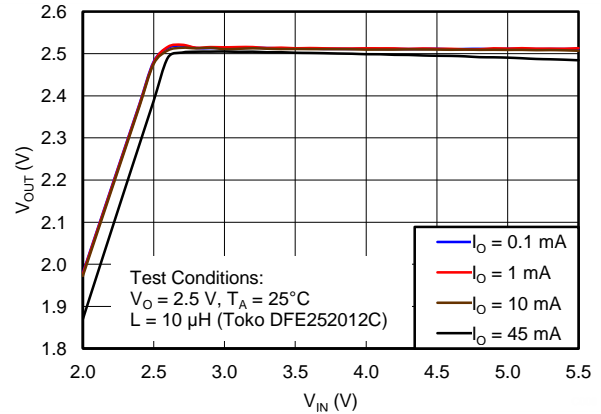

Figure 12. Output Voltage vs Input Voltage, $V_{OUT} = 2.5$ V

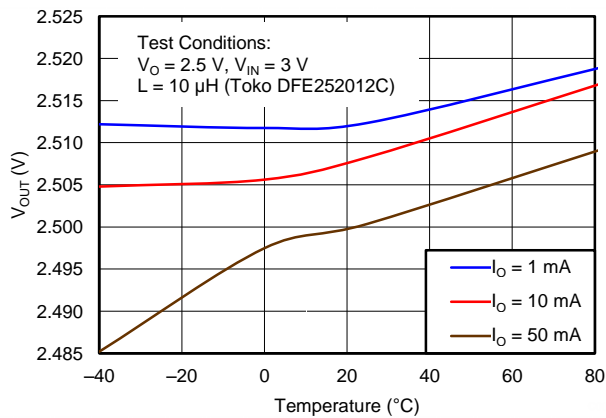

Figure 13. Output Voltage vs Temperature, $V_{OUT} = 2.5$ V

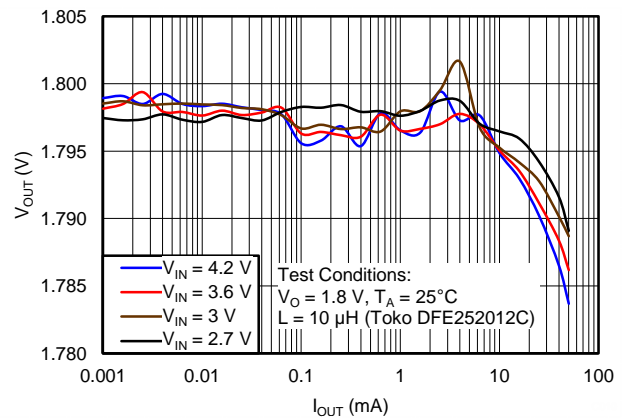

Figure 14. Output Voltage vs Output Current, $V_{OUT} = 1.8$ V

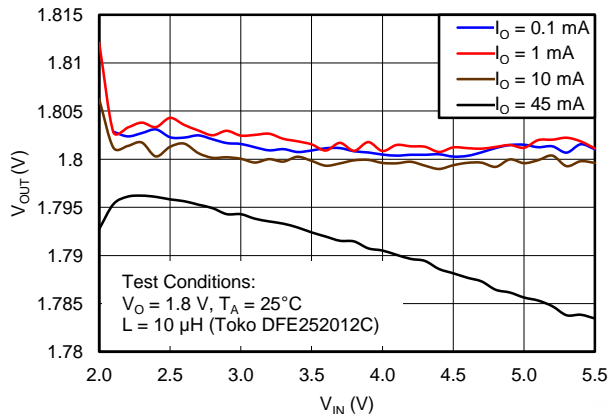

Figure 15. Output Voltage vs Input Voltage, $V_{OUT} = 1.8$ V

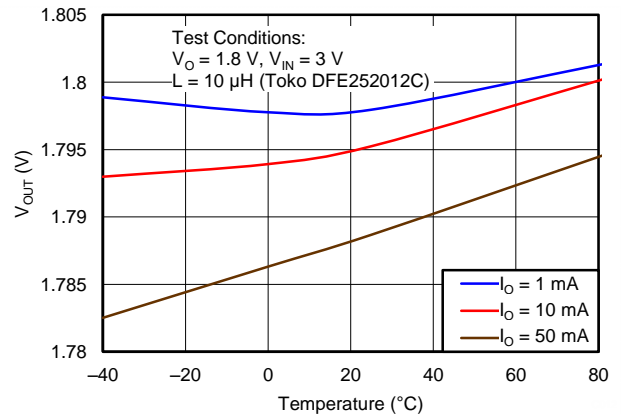

Figure 16. Output Voltage vs Temperature, $V_{OUT} = 1.8$ V

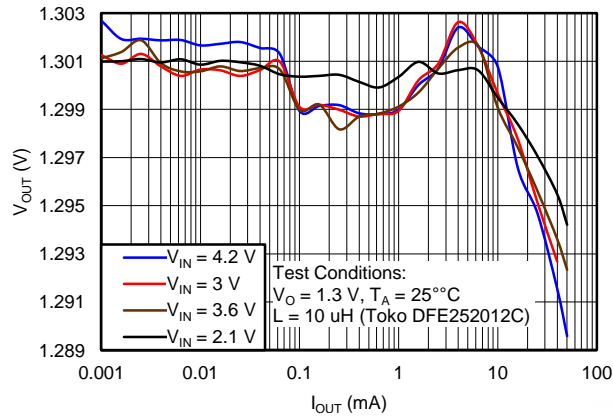

Figure 17. Output Voltage vs Output Current, $V_{OUT} = 1.3\text{ V}$

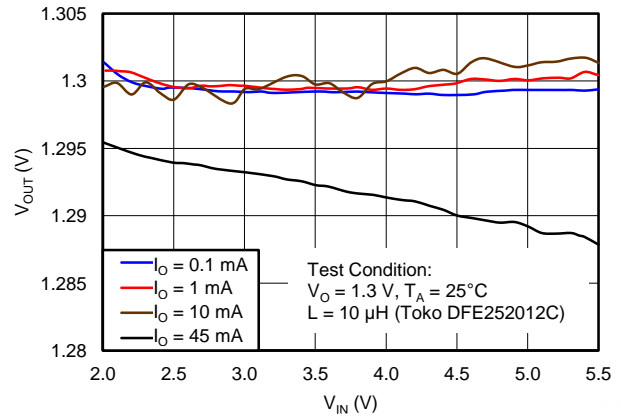

Figure 18. Output Voltage vs Input Voltage, $V_{OUT} = 1.3\text{ V}$

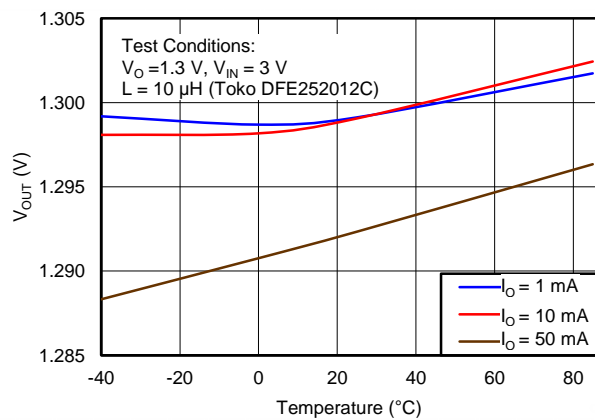

Figure 19. Output Voltage vs Temperature, $V_{OUT} = 1.3\text{ V}$

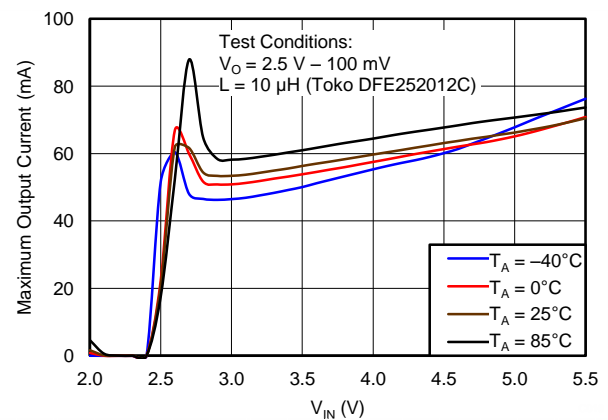

Figure 20. Maximum Output Current vs. Input Voltage
 $V_{OUT} = 2.5\text{ V}$

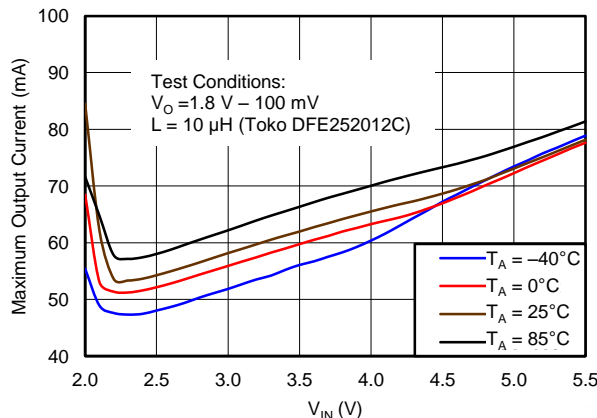

Figure 21. Maximum Output Current vs. Input Voltage,
 $V_{OUT} = 1.8\text{ V}$

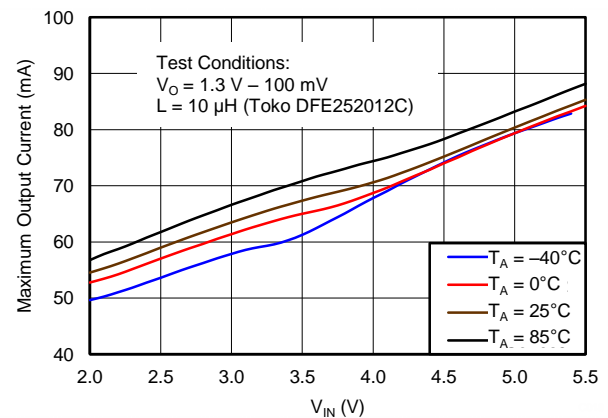

Figure 22. Maximum Output Current vs. Input Voltage,
 $V_{OUT} = 1.3\text{ V}$

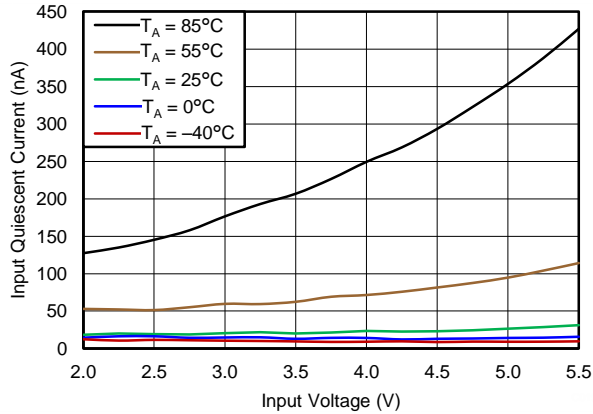

Figure 23. Input Quiescent Current vs. Input Voltage Ship Mode

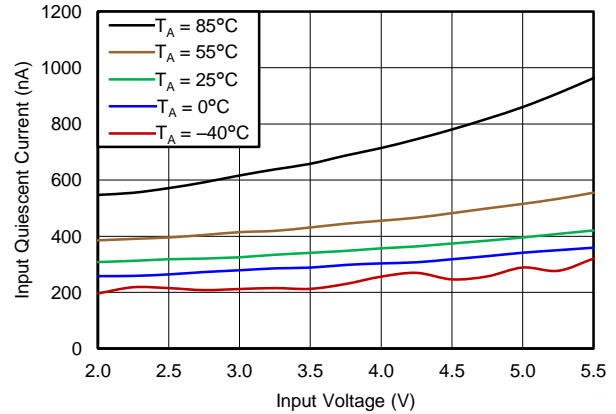

Figure 24. Input Quiescent Current vs. Input Voltage Standby Mode

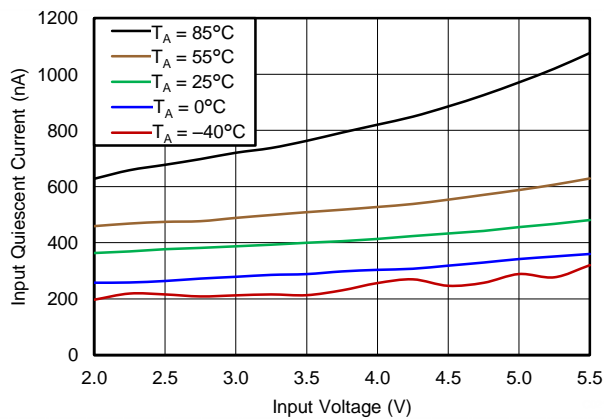

Figure 25. Input Quiescent Current vs. Input Voltage Active Mode

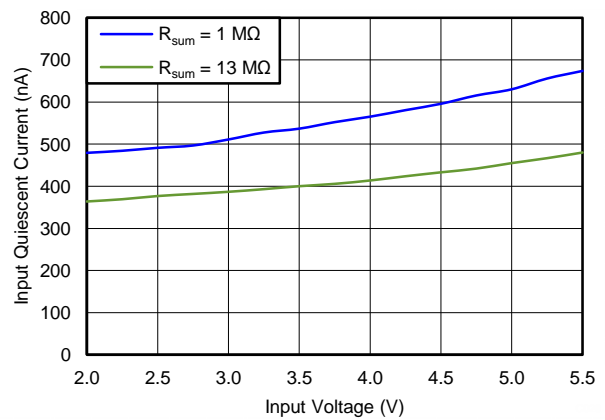

Figure 26. Input Quiescent Current vs. Input Voltage Active Mode where $R_{SUM} = R_1 + R_2 + R_3$

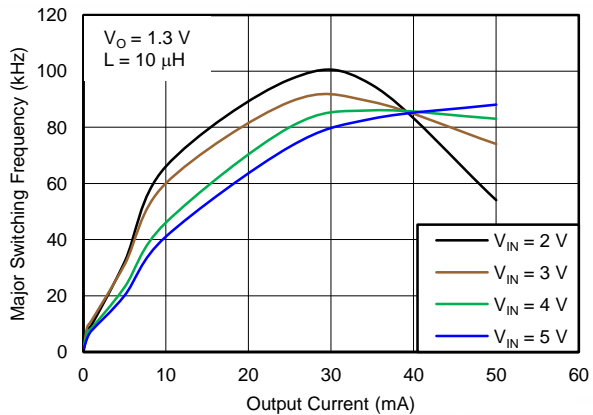

Figure 27. Major Switching Frequency vs Output Current

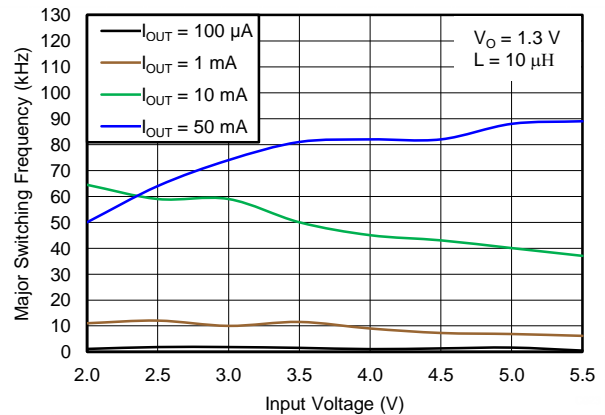

Figure 28. Major Switching Frequency vs Input Voltage

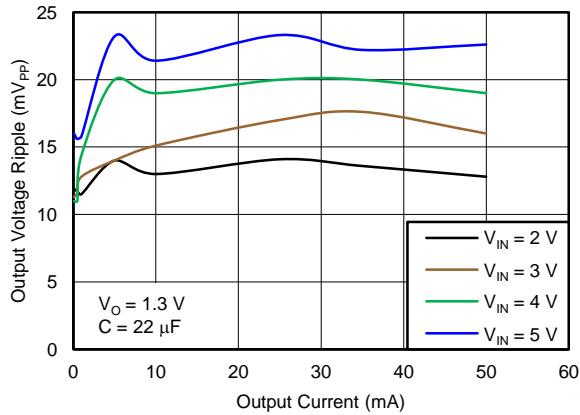

Figure 29. Output Voltage Ripple vs Output Current

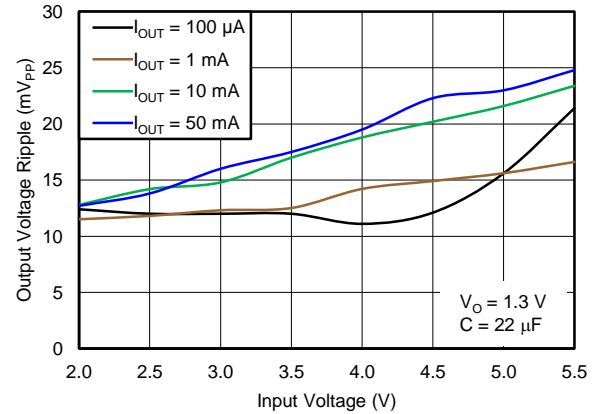

Figure 30. Output Voltage Ripple vs Input Voltage

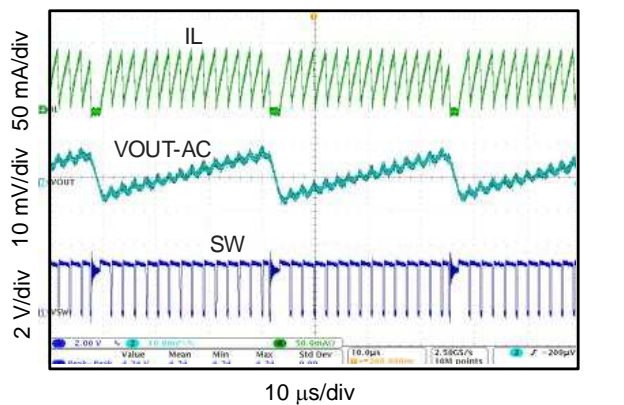

Figure 31. Steady State Operation with $R_O = 50 \Omega$, $L = 10 \mu\text{H}$

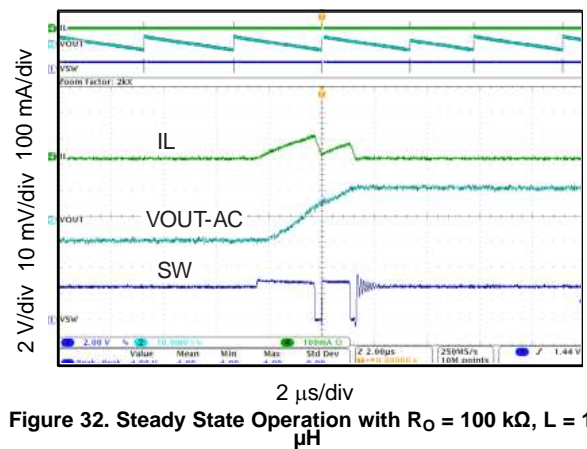

Figure 32. Steady State Operation with $R_O = 100 \text{ k}\Omega$, $L = 10 \mu\text{H}$

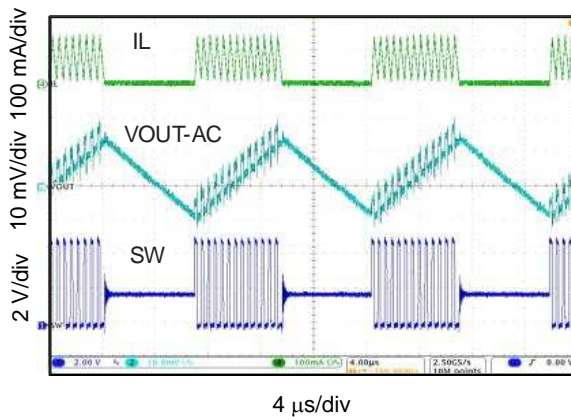

Figure 33. Steady State Operation with $R_O = 50 \Omega$ and $L = 4.7 \mu\text{H}$

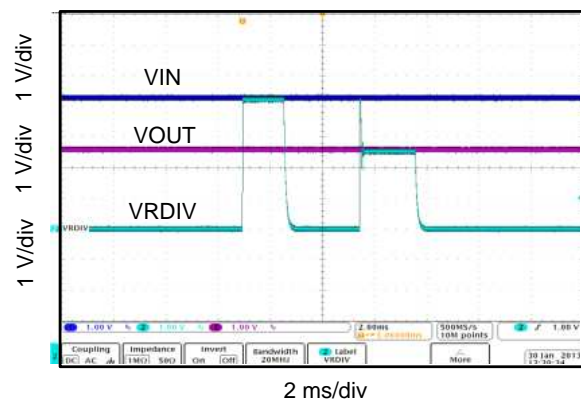

Figure 34. Sampling Waveform

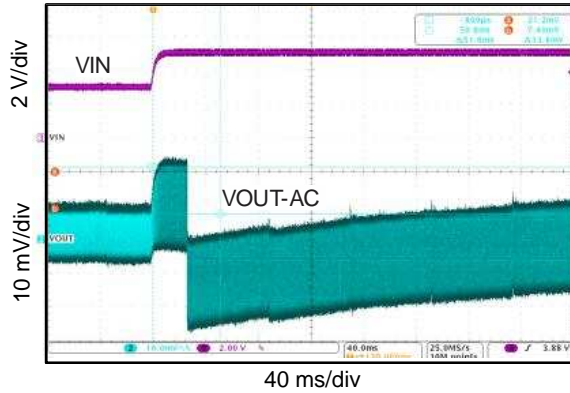

Figure 35. Line Transient Response

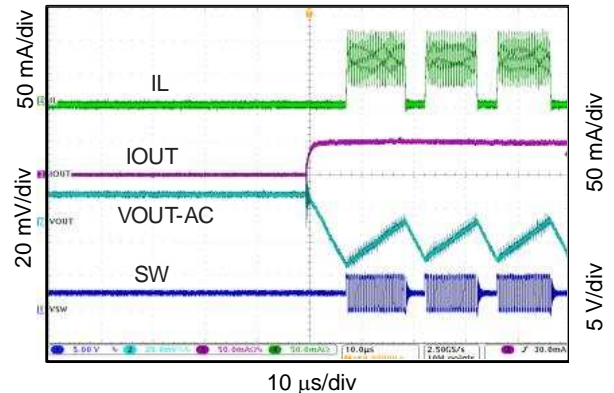

Figure 36. Load Transient Response

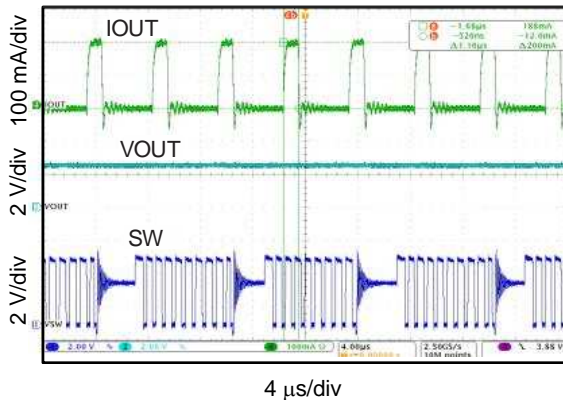

Figure 37. IR Pulse Transient Response

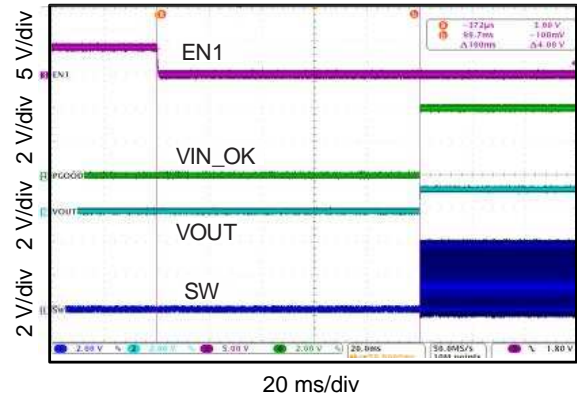

Figure 38. Ship-Mode Startup Behavior

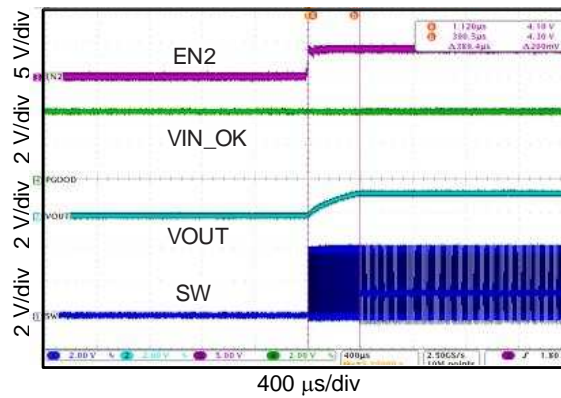

Figure 39. Standby-Mode Startup Behavior

Table of Graphs for TPS62737

Unless otherwise noted, graphs were taken using Figure 2 with L = Toko 10 μ H DFE252012C			FIGURE
η	$V_O = 2.5$ V Efficiency	vs. Output Current	Figure 40
		vs. Input Voltage	Figure 41
	$V_O = 1.8$ V Efficiency	vs. Output Current	Figure 42
		vs. Input Voltage	Figure 43
	$V_O = 1.3$ V Efficiency	vs. Output Current	Figure 44
		vs. Input Voltage	Figure 45
V_{OUT} (DC)	$V_O = 2.5$ V	vs. Output Current	Figure 46
		vs. Input Voltage	Figure 46
		vs. Temperature	Figure 48
	$V_O = 1.8$ V	vs. Output Current	Figure 49
		vs. Input Voltage	Figure 50
		vs. Temperature	Figure 51
	$V_O = 1.3$ V	vs. Output Current	Figure 52
		vs. Input Voltage	Figure 53
		vs. Temperature	Figure 54
I_{OUT} MAX (DC)	$V_O = 2.5$ V	vs. Input Voltage	Figure 55
	$V_O = 1.8$ V		Figure 56
	$V_O = 1.3$ V		Figure 57
Input IQ	EN1 = 1, EN2 = 0 (Ship Mode)	vs. Input Voltage	Figure 58
	EN1 = 0, EN2 = 0 (Standby Mode)		Figure 59
	EN1 = 0, EN2 = 1 (Active Mode)		Figure 60
Switching Frequency	$V_O = 1.8$ V	vs. Output Current	Figure 61
		vs. Input Voltage	Figure 62
Output Ripple	$V_O = 1.8$ V	vs. Output Current	Figure 64
		vs. Input Voltage	Figure 64
Steady State Operation	$V_{IN} = 3.6$ V, $V_O = 1.8$ V	$R_O = 100$ k Ω	Figure 65
		$R_O = 9$ Ω	Figure 66
Power Management Response	VRDIV Behavior	$V_O = 2.5$ V	Figure 67
Transient Response	$V_O = 1.8$ V	Load Transient, $V_{IN} = 3.6$ V, $R_{OUT} =$ none $\rightarrow 9$ Ω	Figure 68
		Line Transient, $V_{IN} = 3.6$ V $\rightarrow 4.6$ V, $R_{OUT} = 9$ Ω	Figure 69
	$V_O = 2.5$ V	IR Pulse Transient, $V_{IN} = 4.0$ V, 200mA transient every 1 μ s	Figure 70
Startup Behavior	$V_{IN} = 0$ V to 5 V to 0 V, $V_O = 1.8$ V	EN1 = 0, EN2=1	Figure 71
	$V_{IN} = 3.6$ V, $V_O = 1.8$ V	EN1 = 1 to 0, EN2=1 - Ship mode startup	Figure 72
		EN1 = 0, EN2 0 to 1 - Standy mode startup	Figure 73

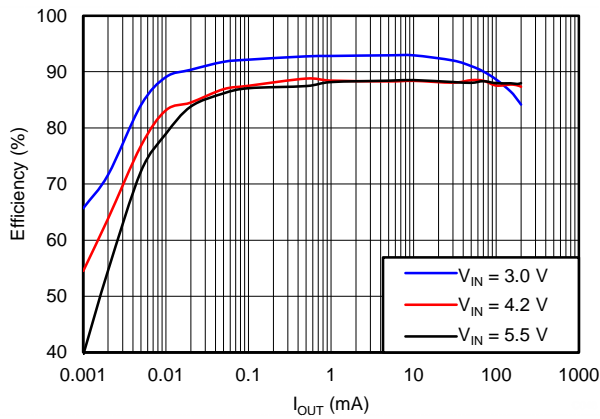

Figure 40. Efficiency Vs Output Current, $V_{OUT} = 2.5\text{ V}$

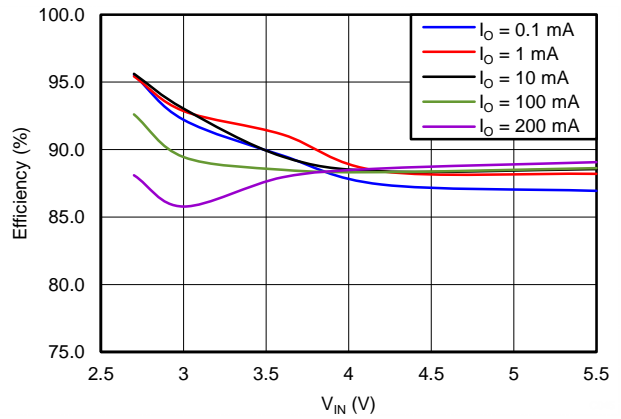

Figure 41. Efficiency vs Input Voltage, $V_{OUT} = 2.5\text{ V}$

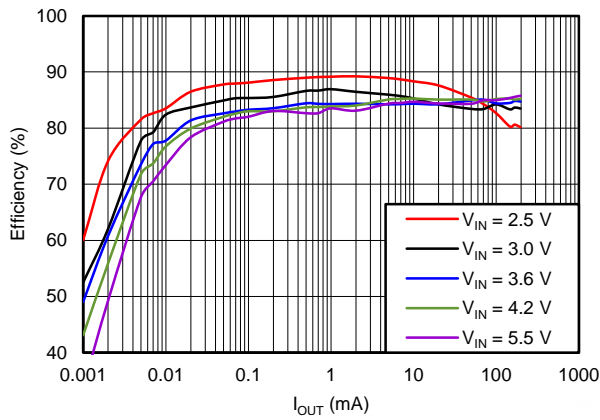

Figure 42. Efficiency Vs Output Current, $V_{OUT} = 1.8\text{ V}$

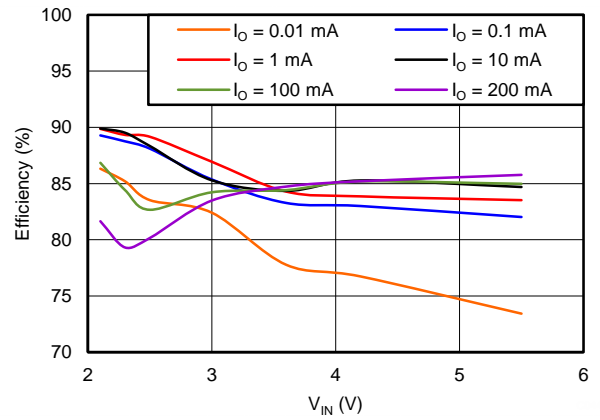

Figure 43. Efficiency vs Input Voltage, $V_{OUT} = 1.8\text{ V}$

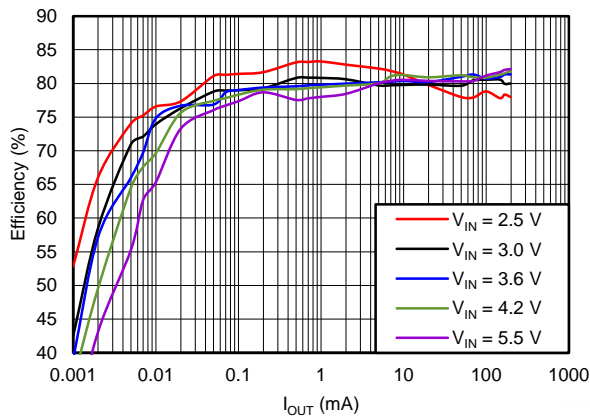

Figure 44. Efficiency Vs Output Current, $V_{OUT} = 1.3\text{ V}$

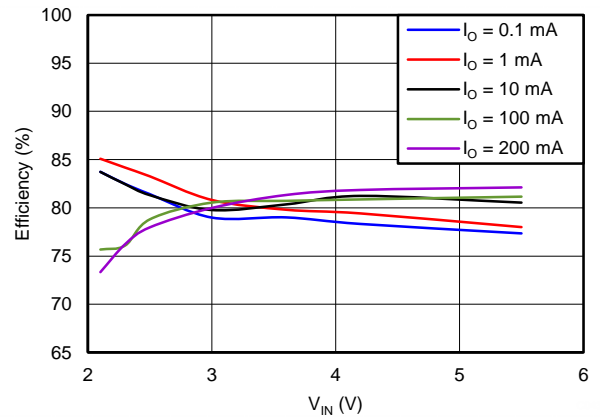

Figure 45. Efficiency vs Input Voltage, $V_{OUT} = 1.3\text{ V}$

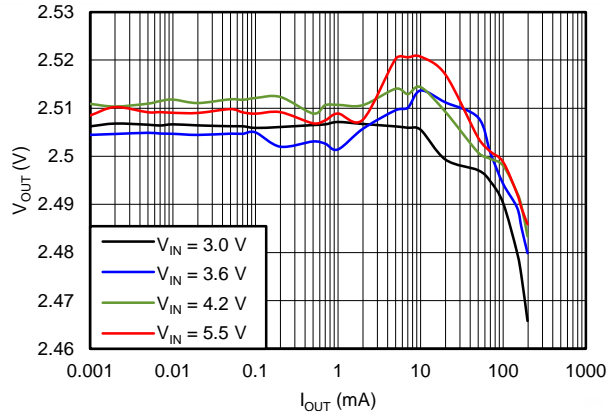

Figure 46. Output Voltage vs Output Current, $V_{OUT} = 2.5\text{ V}$

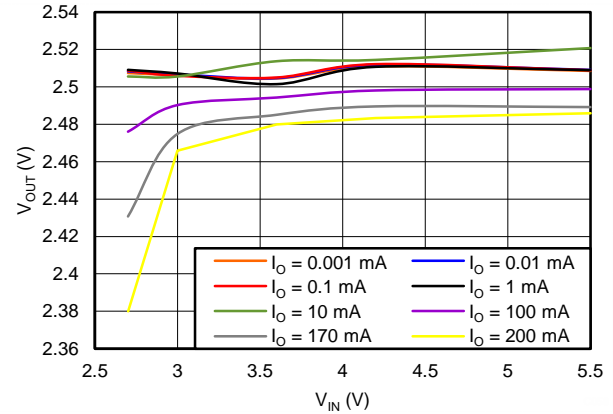

Figure 47. Output Voltage vs Input Voltage, $V_{OUT} = 2.5\text{ V}$

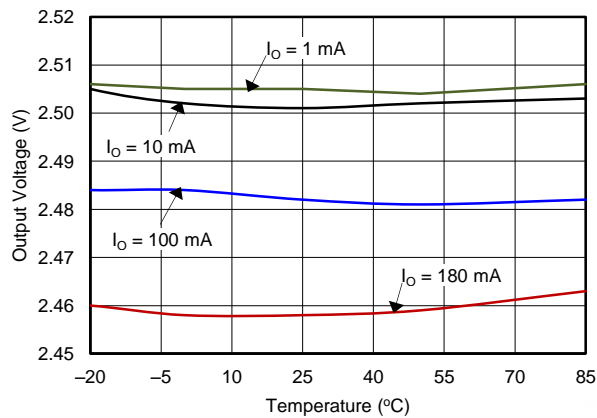

Figure 48. Output Voltage vs Temperature, $V_{OUT} = 2.5\text{ V}$

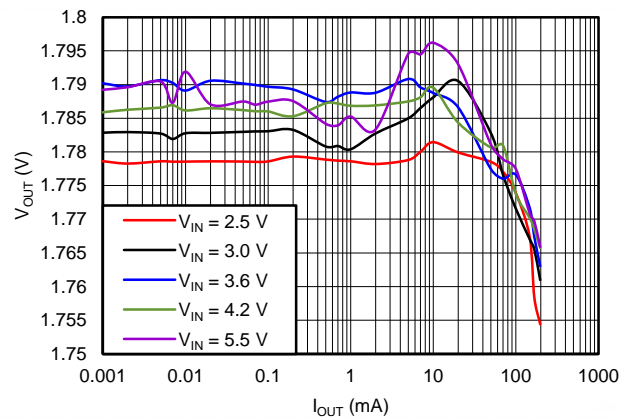

Figure 49. Output Voltage vs Output Current, $V_{OUT} = 1.8\text{ V}$

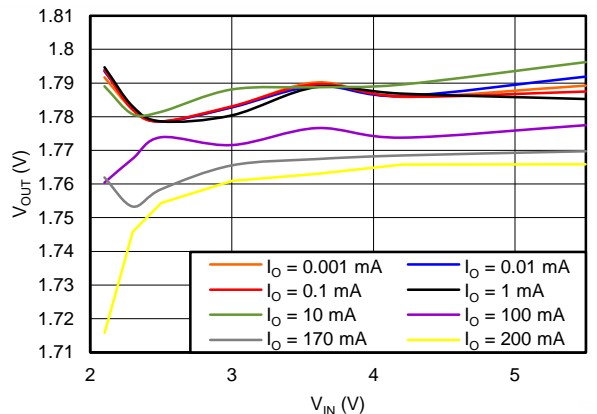

Figure 50. Output Voltage vs Input Voltage, $V_{OUT} = 1.8\text{ V}$

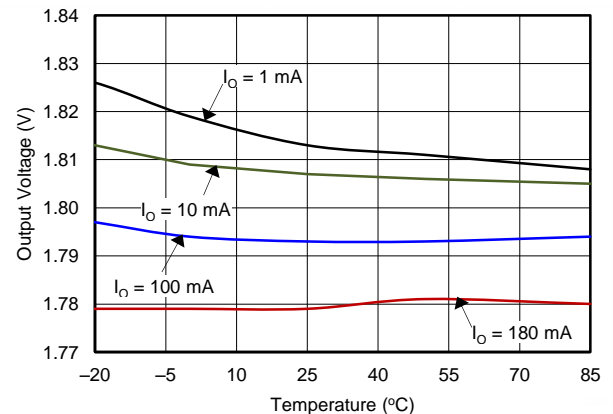

Figure 51. Output Voltage vs Temperature, $V_{OUT} = 1.8\text{ V}$

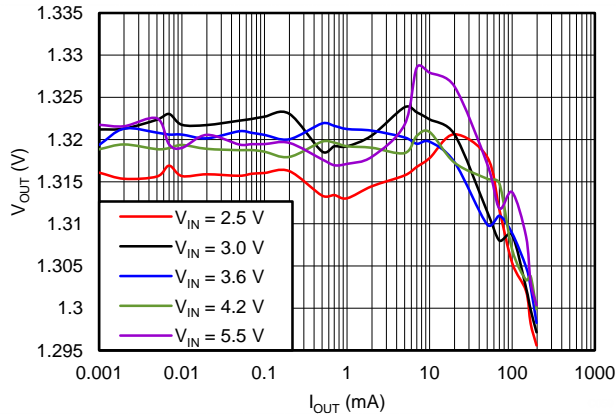

Figure 52. Output Voltage vs Output Current, $V_{OUT} = 1.3\text{ V}$

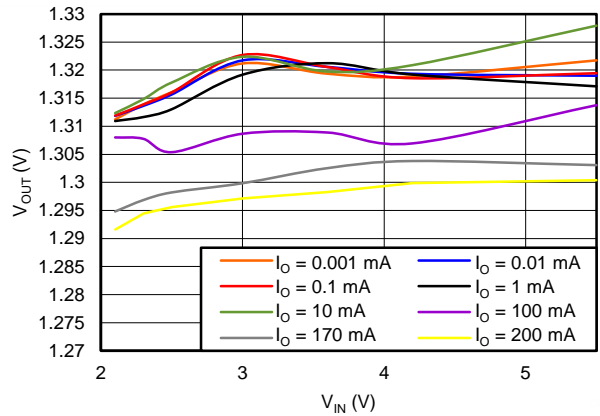

Figure 53. Output Voltage vs Input Voltage, $V_{OUT} = 1.3\text{ V}$

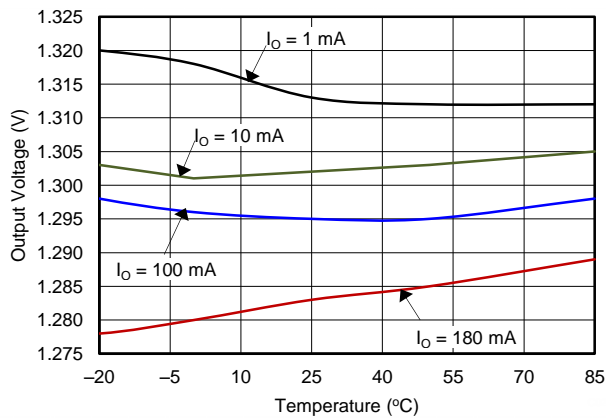

Figure 54. Output Voltage vs Temperature, $V_{OUT} = 1.3\text{ V}$

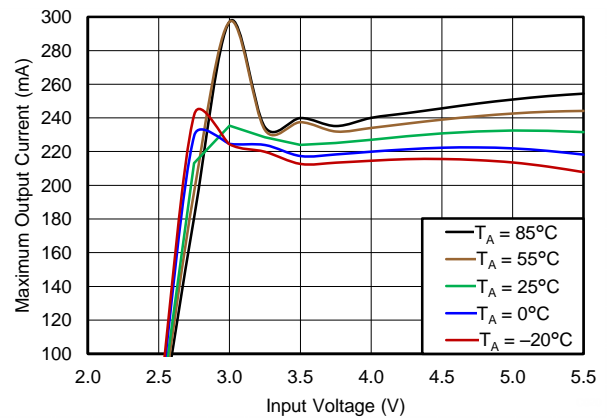

Figure 55. Maximum Output Current vs. Input Voltage, $V_{OUT} = 2.5\text{ V}$

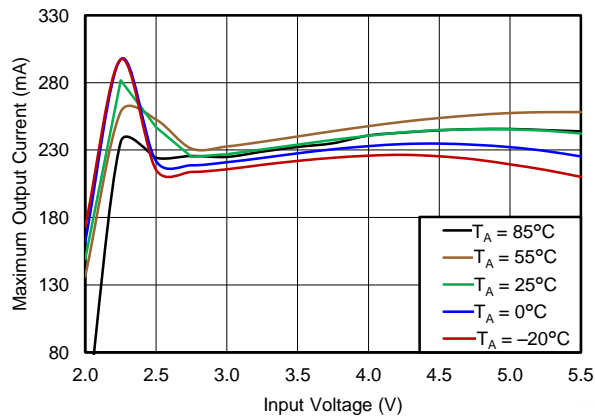

Figure 56. Maximum Output Current vs. Input Voltage, $V_{OUT} = 1.8\text{ V}$

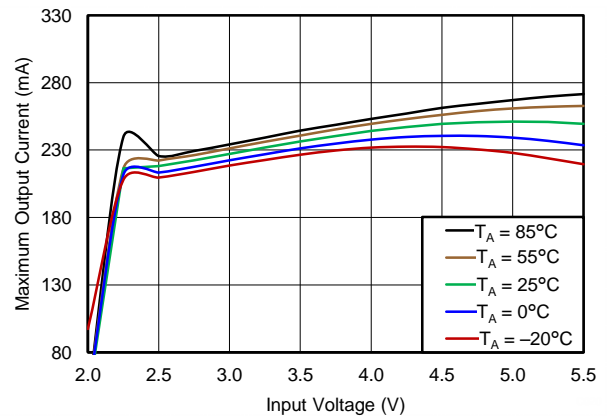

Figure 57. Maximum Output Current vs. Input Voltage, $V_{OUT} = 1.3\text{ V}$

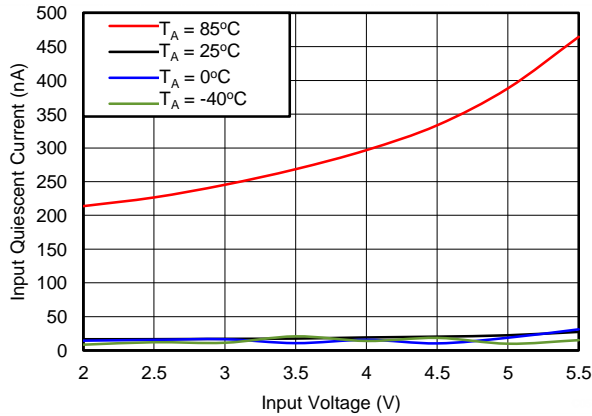

Figure 58. Input Quiescent Current vs. Input Voltage Ship Mode

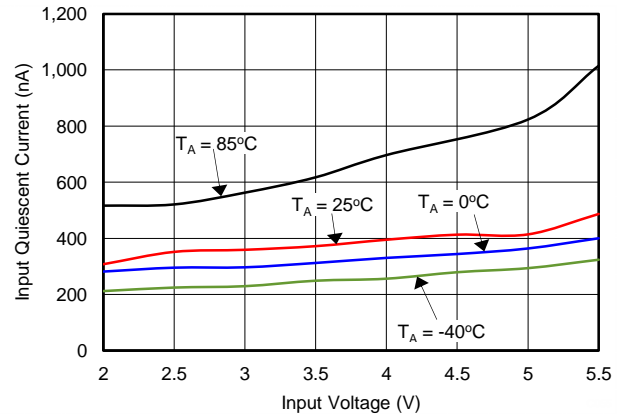

Figure 59. Input Quiescent Current vs. Input Voltage Standby Mode

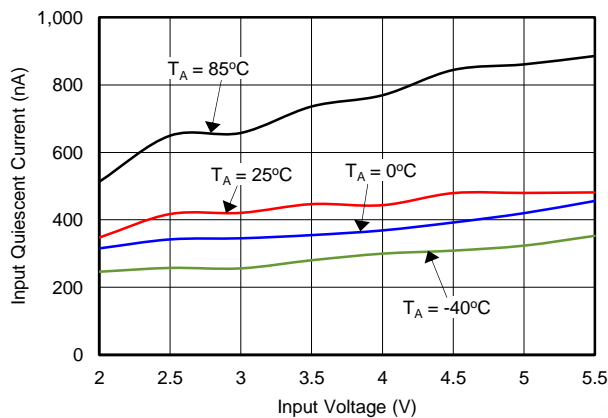

Figure 60. Input Quiescent Current vs. Input Voltage Active Mode

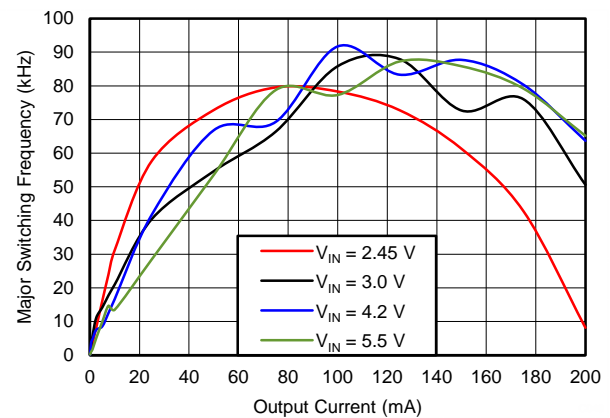

Figure 61. Major Switching Frequency vs. Output Current

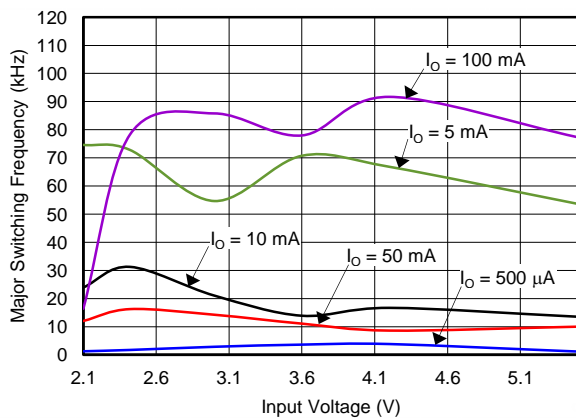

Figure 62. Major Switching Frequency vs. Input Voltage

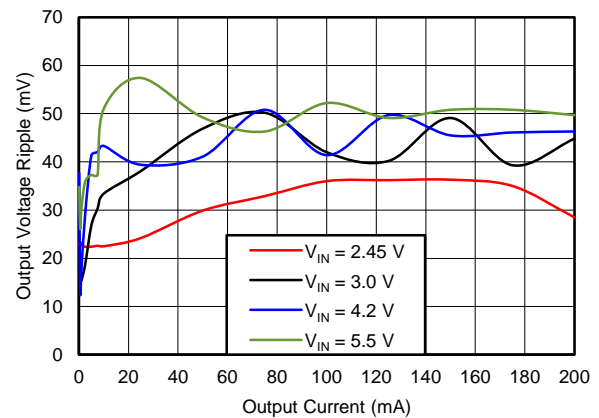

Figure 63. Output Voltage Ripple vs. Output Current

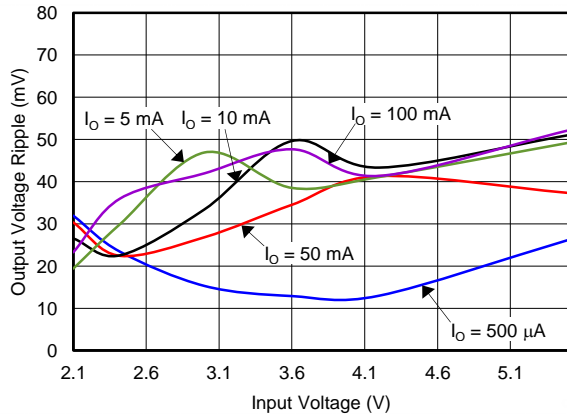

Figure 64. Output Voltage Ripple vs Input Voltage

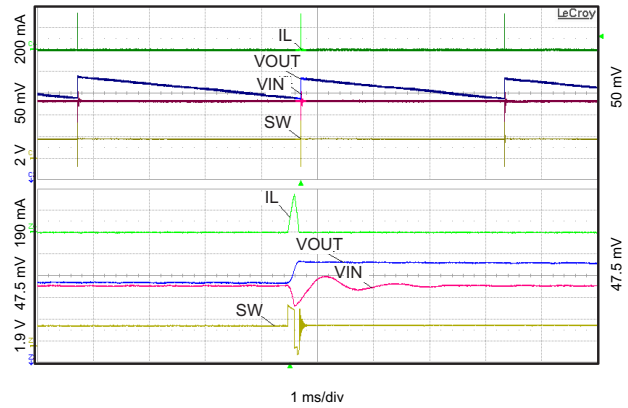

Figure 65. Steady State Operation with $R_O = 100\text{ k}\Omega$

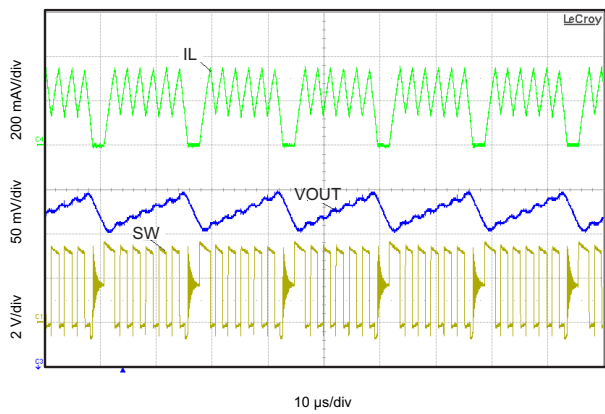

Figure 66. Steady State Operation with $R_O = 9\ \Omega$

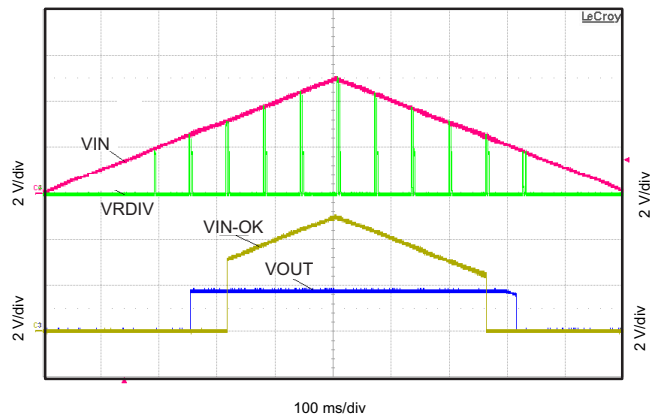

Figure 67. Power Management Response

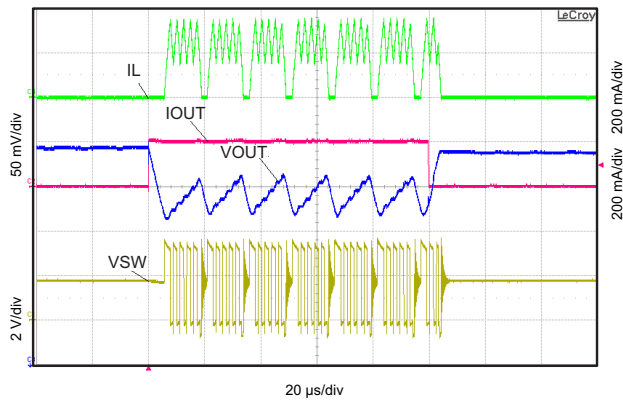

Figure 68. Load Transient Response

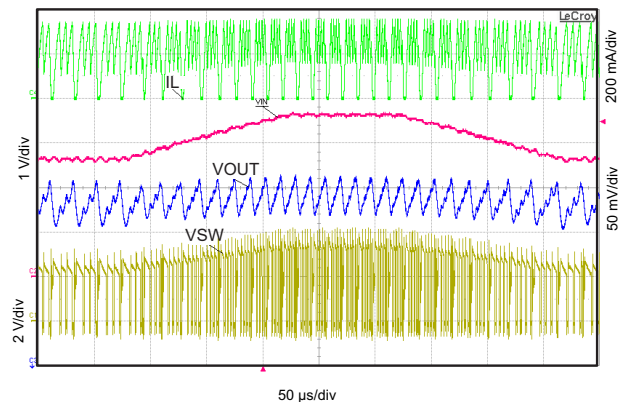

Figure 69. Line Transient Response

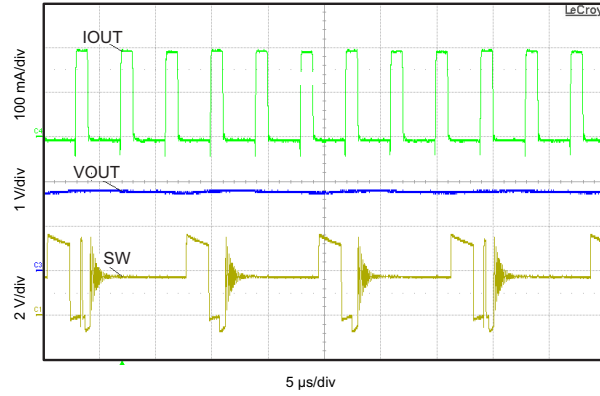

Figure 70. IR Pulse Transient Response

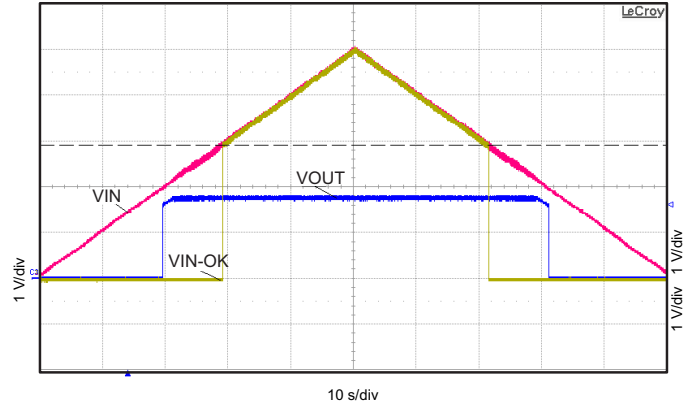

Figure 71. Startup Behavior with Slow Ramping VIN, EN1=0, EN2=1

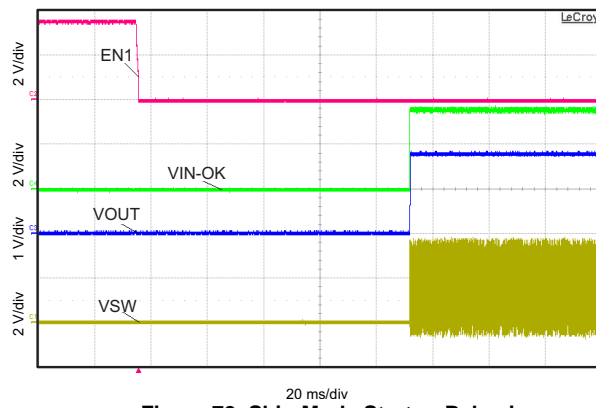

Figure 72. Ship-Mode Startup Behavior

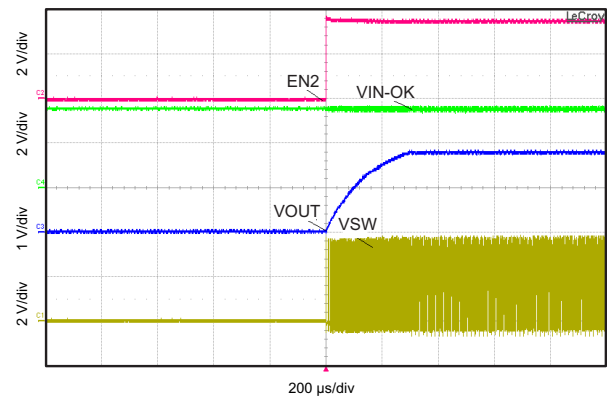

Figure 73. Standby-Mode Startup Behavior

DETAILED PRINCIPLE OF OPERATION

Step Down (Buck) Converter Operation

The buck regulator in the TPS6273X takes input power from VIN, steps it down and provides a regulated voltage at the OUT pin. It employs pulse frequency modulation (PFM) control to regulate the voltage close to the desired reference voltage. The reference voltage is set by the user programmed resistor divider. The current through the inductor is controlled through internal current sense circuitry. The peak current in the inductor is controlled to maintain high efficiency of the converter across a wide input current range. The TPS62736 converter delivers an average output current of 50mA with a peak inductor current of 100 mA. The TPS62737 converter delivers an average output current of 200 mA with a peak inductor current of 370 mA. The buck regulator is disabled when the voltage on VIN reaches the UVLO condition. The UVLO level is continuously monitored. The buck regulator continues to operate in pass (100% duty cycle) mode, passing the input voltage to the output, as long as VIN is greater than UVLO and less than VIN minus I_{OUT} times R_{DS(on)} of the high-side FET (i.e., VIN - I_{OUT} × R_{DS(on)-HS}). In order to save power from being dissipated through other IC's on this supply rail while allowing for a faster wake up time, the buck regulator can be enabled and disabled via the EN2 pin for systems that desire to completely turn off the regulated output.

Nano-Power Management and Efficiency

The high efficiency of the TPS6273X is achieved via the proprietary Nano-Power management circuitry and algorithm. This feature essentially samples and holds all references in order to reduce the average quiescent current. That is, the internal circuitry is only active for a short period of time and then off for the remaining period of time at the lowest feasible duty cycle. A portion of this feature can be observed in [Figure 34](#) where the VRDIV node is monitored. Here the VRDIV node provides a connection to the input (larger voltage level) and generates the output reference (lower voltage level) for a short period of time. The divided down value of input voltage is compared to VBIAS and the output voltage reference is sampled and held to get the VOUT_SET point. Since this biases a resistor string, the current through these resistors is only active when the Nano-Power management circuitry makes the connection—hence reducing the overall quiescent current due to the resistors. This process repeats every 64 ms. Similarly, the VIN_OK level is monitored every 64ms, as shown in [Figure 67](#).

The efficiency versus output current and versus input voltage are plotted for three different output voltages for both the TPS62736 and TPS62737 in the Typical Characteristics section. All data points were captured by averaging the overall input current. This must be done due to the periodic biasing scheme implemented via the Nano-Power management circuitry. The input current efficiency data was gathered using a source meter set to average over at least 25 samples and at the highest accuracy sampling rate. Each data point takes a long period of time to gather in order to properly measure the resulting input current when calculating the efficiency.

Programming OUT Regulation Voltage and VIN_OK

To set the proper output regulation voltage and input voltage power good comparator, the external resistors must be carefully selected. [Figure 1](#) illustrates an application diagram which uses the minimal resistor count for setting both VOUT and VIN_OK. Note that VBIAS is nominally 1.21V per the electrical specification table. Referring to [Figure 1](#), the OUT dc set point is given by:

$$V_{OUT} = V_{BIAS} \left(\frac{R_1 + R_2 + R_3}{R_1 + R_2} \right) \quad (1)$$

The VIN_OK setting is given by:

$$VIN_OK = V_{BIAS} \left(\frac{R_1 + R_2 + R_3}{R_1} \right) \quad (2)$$

The sum of the resistors is recommended to be no greater than 13 MΩ, that is, R_{SUM} = R₁ + R₂ + R₃ = 13 MΩ. Due to the sampling operation of the output resistors, lowering R_{SUM} only increases quiescent current slightly as can be seen in [Figure 26](#). Higher resistors may result in poor output voltage regulation and/or input voltage power good threshold accuracies due to noise pickup via the high impedance pins or reduction of effective resistance due to parasitic resistances created from board assembly residue. See Layout Considerations section for more details.

If it is preferred to separate the VOUT and VIN_OK resistor strings, two separate strings of resistors could be used as shown in [Figure 3](#). The OUT dc set point is then given by [Equation 3](#):

$$V_{OUT} = V_{BIAS} \left(\frac{R_3 + R_4}{R_4} \right) \quad (3)$$

The VIN_OK setting is then given by [Equation 4](#):

$$VIN_OK = V_{BIAS} \left(\frac{R_1 + R_2}{R_1} \right) \quad (4)$$

If it is preferred to disable the VIN_OK setting, the VIN_OK_SET pin can be tied to VIN as shown in [Figure 4](#). To set VOUT in this configuration, use [Equation 3](#). To tighten the dc set point accuracy, use external resistors with better than 1% resistor tolerance. Since output voltage ripple has a large effect on input line regulation and the output load regulation, using a larger output capacitor will improve both line and load regulation.

Enable Controls

There are two enable pins implemented in the TPS6273X in order to maximize the flexibility of control for the system. The EN1 pin is considered to be the chip enable. If EN1 is set to a 1 then the entire chip is placed into ship mode. If EN1 is 0 then the chip is enabled. EN2 enables and disables the switching of the buck converter. When EN2 is low, the internal circuitry remains ON and the VIN_OK indicator still functions. This can be used to disable down-stream electronics in case of a low input supply condition. When EN2 is 1, the buck converter operates normally.

Table 1. Enable Functionality Table

EN1 PIN	EN2 PIN	FUNCTIONAL STATE
0	0	Partial standby mode. Buck switching converter is off, but VIN_OK indication is on
0	1	Buck mode and VIN_OK enabled
1	x	Full standby mode. Switching converter and VIN_OK indication is off (ship mode)

Startup Behavior

The TPS6273X has two startup responses: 1) from the ship-mode state (EN1 transitions from high to low), and 2) from the standby state (EN2 transitions from low to high). The first startup response out of the ship-mode state has the longest time duration due to the internal circuitry being disabled. This response is shown in [Figure 38](#) for the TPS62736 and [Figure 72](#) for the TPS62737. The startup time takes approximately 100ms due to the internal Nano-Power management circuitry needing to complete the 64 ms sample and hold cycle.

Startup from the standby state is shown in [Figure 39](#) for the TPS62736 and [Figure 73](#) for the TPS62737. This response is much faster due to the internal circuitry being pre-enabled. The startup time from this state is entirely dependent on the size of the output capacitor. The larger the capacitor, the longer it will take to charge during startup. The TPS6273X can startup into a pre-biased output voltage.

Steady State Operation and Cycle by Cycle Behavior

The steady state operation at full load is shown in [Figure 31](#) for the TPS62736 and [Figure 66](#) for TPS62737. This plot highlights the inductor current waveform, the output voltage ripple, and the switching node. The output voltage is maintained by charging and discharging the output capacitor at a primary duty cycle (major frequency) which in turn dictates the output voltage ripple frequency. When VOUT is increasing in value, the output capacitor is charged by the hysteretic buck controller. This is achieved by controlling the peak cycle-by-cycle inductor current to I_{LIM} . The cycle-by-cycle current is maintained by turning on and off the high side FET at a secondary duty cycle (minor frequency). When VOUT reaches a peak value, all hysteretic control is disabled until a minimum value is reached. The rate at which the converter stays off is dictated by the load and the size of the output capacitor. At heavier output loads (larger output current), the time the converter is off is smaller when compared to light load conditions. The light load condition is shown in [Figure 32](#) for the TPS62736 and [Figure 65](#) for the TPS62737. Note that the converter is inactive for a longer period of time when compared to the active time.

The minor switching frequency is of concern when choosing the inductor. This maximum switching frequency is 1 MHz. The major switching frequency dictates the voltage ripple frequency. Figure 27 and Figure 28 show the major switching frequency versus load current and input voltage for the TPS62736, respectively. Figure 61 and Figure 62 show the major switching frequency versus load current and input voltage for the TPS62737, respectively.

Inductor Selection

The internal control circuitry is designed to control the switching behavior with a nominal inductance of 10 $\mu\text{H} \pm 20\%$. The inductor's saturation current should be at least 25% higher than the maximum cycle-by-cycle current limit per the electrical specs table (I_{LIM}) in order to account for load transients. Since this device is a hysteretic controller, it is a naturally stable system (single order transfer function). However, the smaller the inductor value is, the faster the switching currents are. The speed of the peak current detect circuit sets the TPS62736 inductor's lower bound to 4.7 μH . When using a 4.7 μH , the peak inductor current will increase when compared to that of a 10 μH inductor. The steady-state operation with a 4.7 μH inductor with a 50 mA load for the TPS62736 is shown in Figure 33.

A list of inductors recommended for this device is shown in Table 2.

Table 2.

Inductance (μH)	Dimensions (mm)	Part Number	Manufacturer
10	2.0 x 2.5 x 1.2	DFE252012C-H-100M	Toko
10	4.0x4.0x1.7	LPS4018-103M	Coilcraft
4.7 (TPS62736 only)	2.0 x 2.5 x 1.2	DFE252012R-H-4R7M	Toko

Output Capacitor Selection

The output capacitor is chosen based on transient response behavior and ripple magnitude. The lower the capacitor value, the larger the ripple will become and the larger the droop will be in the case of a transient response. It is recommended to use at least a 22 μF output capacitor for most applications.

Input Capacitor Selection

The bulk input capacitance is recommended to be a minimum of 4.7 $\mu\text{F} \pm 20\%$ for the TPS62736 and 22 $\mu\text{F} \pm 20\%$ for the TPS62737. This bulk capacitance is used to suppress the lower frequency transients produced by the switching converter. There is no upper bound to the input bulk capacitance. In addition, a high frequency bypass capacitor of 0.1 μF is recommended in parallel with the bulk capacitor. The high frequency bypass is used to suppress the high frequency transients produced by the switching converter.

Layout and PCB Assembly Considerations

To minimize switching noise generation, the step-down converter (buck) power stage external components must be carefully placed. The most critical external component for a buck power stage is its input capacitor. The bulk input capacitor (C_{IN1}) and high frequency decoupling capacitor (C_{IN2}) must be placed as close as possible between the power stage input (IN pin 1) and ground (VSS pin 12). Next, the inductor (L1) must be placed as close as possible between the switching node (SW pin 13) and the output voltage (OUT pin 11). Finally, the output capacitor (C_{OUT}) should be placed as close as possible between the output voltage (OUT pin 11) and GND (VSS pin 12). In the diagram below, the input and output capacitor grounds are connected to VSS pin 12 through vias to the PCB's bottom layer ground plane.

To minimize noise pickup by the high impedance voltage setting nodes (VIN_OK_SET pin 8 and VOUT_SET pin 9), the external resistors (R1, R2 and R3) should be placed so that the traces connecting the midpoints of the string are as short as possible. In the diagram below, the connection to VOUT_SET is by a bottom layer trace.

The remaining pins are either NC pins, that should be connected to the PowerPAD™ as shown below, or digital signals with minimal layout restrictions.

In order to maximize efficiency at light load, the use of voltage level setting resistors > 1MΩ is recommended. However, during board assembly, contaminants such as solder flux and even some board cleaning agents can leave residue that may form parasitic resistors across the physical resistors and/or from one end of a resistor to ground, especially in humid, fast airflow environments. This can result in the voltage regulation and threshold levels changing significantly from those expected per the installed resistor values. Therefore, it is highly recommended that no ground planes be poured near the voltage setting resistors. In addition, the boards must be carefully cleaned, possibly rotated at least once during cleaning, and then rinsed with de-ionized water until the ionic contamination of that water is well above 50 MOhm. If this is not feasible, then it is recommended that the sum of the voltage setting resistors be reduced to at least 5X below the measured ionic contamination.

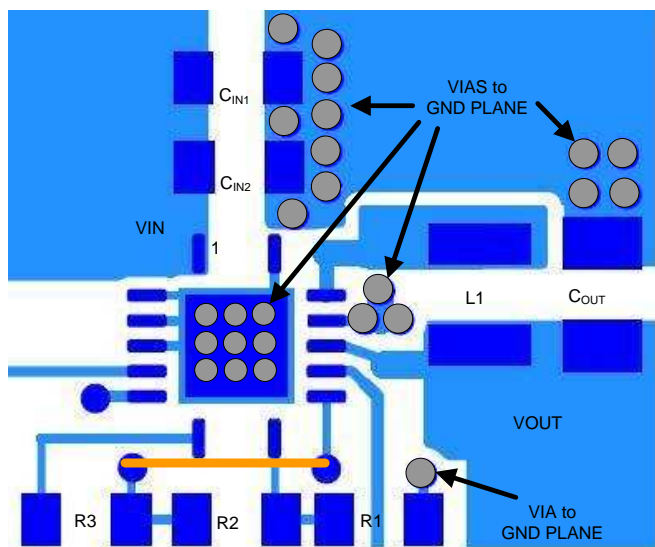

Figure 74. Recommended Layout, TPS62736

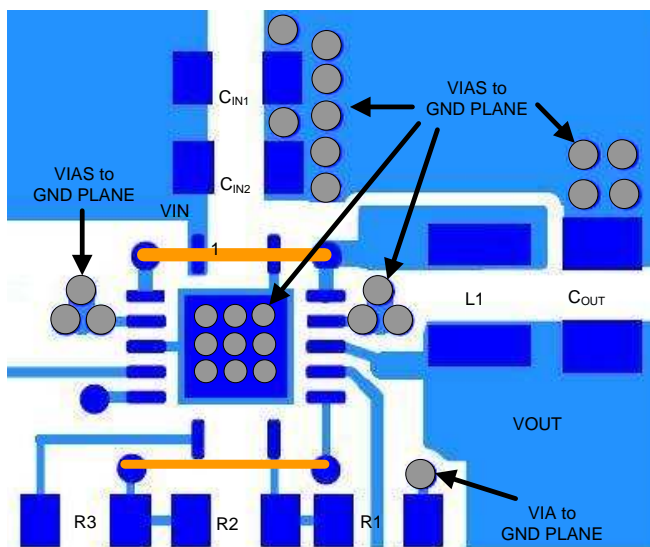

Figure 75. Recommended Layout, TPS62737

REVISION HISTORY

Changes from Original (October 2012) to Revision A

Page

- 将器件从：预览改为了：激活 1

Changes from Revision A (March 2013) to Revision B

Page

- Added the TPS62737 Pinout information 6
- Added the TPS62737 Application Circuit, Figure 2 9
- Added graphs for TPS62737 to the Typical Characteristics 17
- Changed Figure 74 27
- Added Figure 75 27

PACKAGING INFORMATION

Orderable Device	Status (1)	Package Type	Package Drawing	Pins	Package Qty	Eco Plan (2)	Lead finish/ Ball material (6)	MSL Peak Temp (3)	Op Temp (°C)	Device Marking (4/5)	Samples
TPS62736RGYR	ACTIVE	VQFN	RGY	14	3000	RoHS & Green	NIPDAU	Level-2-260C-1 YEAR	-40 to 85	62736	Samples
TPS62736RGYT	ACTIVE	VQFN	RGY	14	250	RoHS & Green	NIPDAU	Level-2-260C-1 YEAR	-40 to 85	62736	Samples
TPS62737RGYR	ACTIVE	VQFN	RGY	14	3000	RoHS & Green	NIPDAU	Level-2-260C-1 YEAR	-40 to 105	62737	Samples
TPS62737RGYT	ACTIVE	VQFN	RGY	14	250	RoHS & Green	NIPDAU	Level-2-260C-1 YEAR	-40 to 105	62737	Samples

(1) The marketing status values are defined as follows:

ACTIVE: Product device recommended for new designs.

LIFEBUY: TI has announced that the device will be discontinued, and a lifetime-buy period is in effect.

NRND: Not recommended for new designs. Device is in production to support existing customers, but TI does not recommend using this part in a new design.

PREVIEW: Device has been announced but is not in production. Samples may or may not be available.

OBSELETE: TI has discontinued the production of the device.

(2) **RoHS:** TI defines "RoHS" to mean semiconductor products that are compliant with the current EU RoHS requirements for all 10 RoHS substances, including the requirement that RoHS substance do not exceed 0.1% by weight in homogeneous materials. Where designed to be soldered at high temperatures, "RoHS" products are suitable for use in specified lead-free processes. TI may reference these types of products as "Pb-Free".

RoHS Exempt: TI defines "RoHS Exempt" to mean products that contain lead but are compliant with EU RoHS pursuant to a specific EU RoHS exemption.

Green: TI defines "Green" to mean the content of Chlorine (Cl) and Bromine (Br) based flame retardants meet JS709B low halogen requirements of <=1000ppm threshold. Antimony trioxide based flame retardants must also meet the <=1000ppm threshold requirement.

(3) MSL, Peak Temp. - The Moisture Sensitivity Level rating according to the JEDEC industry standard classifications, and peak solder temperature.

(4) There may be additional marking, which relates to the logo, the lot trace code information, or the environmental category on the device.

(5) Multiple Device Markings will be inside parentheses. Only one Device Marking contained in parentheses and separated by a "-" will appear on a device. If a line is indented then it is a continuation of the previous line and the two combined represent the entire Device Marking for that device.

(6) Lead finish/Ball material - Orderable Devices may have multiple material finish options. Finish options are separated by a vertical ruled line. Lead finish/Ball material values may wrap to two lines if the finish value exceeds the maximum column width.

Important Information and Disclaimer:The information provided on this page represents TI's knowledge and belief as of the date that it is provided. TI bases its knowledge and belief on information provided by third parties, and makes no representation or warranty as to the accuracy of such information. Efforts are underway to better integrate information from third parties. TI has taken and

continues to take reasonable steps to provide representative and accurate information but may not have conducted destructive testing or chemical analysis on incoming materials and chemicals. TI and TI suppliers consider certain information to be proprietary, and thus CAS numbers and other limited information may not be available for release.

In no event shall TI's liability arising out of such information exceed the total purchase price of the TI part(s) at issue in this document sold by TI to Customer on an annual basis.

TAPE AND REEL INFORMATION

QUADRANT ASSIGNMENTS FOR PIN 1 ORIENTATION IN TAPE

*All dimensions are nominal

Device	Package Type	Package Drawing	Pins	SPQ	Reel Diameter (mm)	Reel Width W1 (mm)	A0 (mm)	B0 (mm)	K0 (mm)	P1 (mm)	W (mm)	Pin1 Quadrant
TPS62736RGYR	VQFN	RGY	14	3000	330.0	12.4	3.75	3.75	1.15	8.0	12.0	Q2
TPS62736RGYT	VQFN	RGY	14	250	180.0	12.4	3.75	3.75	1.15	8.0	12.0	Q2
TPS62737RGYR	VQFN	RGY	14	3000	330.0	12.4	3.75	3.75	1.15	8.0	12.0	Q2
TPS62737RGYT	VQFN	RGY	14	250	180.0	12.4	3.75	3.75	1.15	8.0	12.0	Q2

TAPE AND REEL BOX DIMENSIONS

*All dimensions are nominal

Device	Package Type	Package Drawing	Pins	SPQ	Length (mm)	Width (mm)	Height (mm)
TPS62736RGYR	VQFN	RGY	14	3000	346.0	346.0	33.0
TPS62736RGYT	VQFN	RGY	14	250	210.0	185.0	35.0
TPS62737RGYR	VQFN	RGY	14	3000	346.0	346.0	33.0
TPS62737RGYT	VQFN	RGY	14	250	210.0	185.0	35.0

RGY (S-PVQFN-N14)

PLASTIC QUAD FLATPACK NO-LEAD



- NOTES:
- All linear dimensions are in millimeters. Dimensioning and tolerancing per ASME Y14.5M-1994.
 - This drawing is subject to change without notice.
 - QFN (Quad Flatpack No-Lead) package configuration.
 - The package thermal pad must be soldered to the board for thermal and mechanical performance.
 - See the additional figure in the Product Data Sheet for details regarding the exposed thermal pad features and dimensions.
 - Pin 1 identifiers are located on both top and bottom of the package and within the zone indicated. The Pin 1 identifiers are either a molded, marked, or metal feature.
 - Package complies to JEDEC MO-241 variation BA.

RGY (S-PVQFN-N14)

PLASTIC QUAD FLATPACK NO-LEAD

THERMAL INFORMATION

This package incorporates an exposed thermal pad that is designed to be attached directly to an external heatsink. The thermal pad must be soldered directly to the printed circuit board (PCB). After soldering, the PCB can be used as a heatsink. In addition, through the use of thermal vias, the thermal pad can be attached directly to the appropriate copper plane shown in the electrical schematic for the device, or alternatively, can be attached to a special heatsink structure designed into the PCB. This design optimizes the heat transfer from the integrated circuit (IC).

For information on the Quad Flatpack No-Lead (QFN) package and its advantages, refer to Application Report, QFN/SON PCB Attachment, Texas Instruments Literature No. SLUA271. This document is available at www.ti.com.

The exposed thermal pad dimensions for this package are shown in the following illustration.



Bottom View

Exposed Thermal Pad Dimensions

4206353-2/P 03/14

NOTE: All linear dimensions are in millimeters

RGY (S-PVQFN-N14)

PLASTIC QUAD FLATPACK NO-LEAD



4208122-2/P 03/14

- NOTES:
- All linear dimensions are in millimeters.
 - This drawing is subject to change without notice.
 - Publication IPC-7351 is recommended for alternate designs.
 - This package is designed to be soldered to a thermal pad on the board. Refer to Application Note, Quad Flat-Pack QFN/SON PCB Attachment, Texas Instruments Literature No. SLUA271, and also the Product Data Sheets for specific thermal information, via requirements, and recommended board layout. These documents are available at www.ti.com <<http://www.ti.com>>.
 - Laser cutting apertures with trapezoidal walls and also rounding corners will offer better paste release. Customers should contact their board assembly site for stencil design recommendations. Refer to IPC 7525 for stencil design considerations.
 - Customers should contact their board fabrication site for minimum solder mask web tolerances between signal pads.

重要声明和免责声明

TI“按原样”提供技术和可靠性数据（包括数据表）、设计资源（包括参考设计）、应用或其他设计建议、网络工具、安全信息和其他资源，不保证没有瑕疵且不做任何明示或暗示的担保，包括但不限于对适销性、某特定用途方面的适用性或不侵犯任何第三方知识产权的暗示担保。

这些资源可供使用 TI 产品进行设计的熟练开发人员使用。您将自行承担以下全部责任：(1) 针对您的应用选择合适的 TI 产品，(2) 设计、验证并测试您的应用，(3) 确保您的应用满足相应标准以及任何其他功能安全、信息安全、监管或其他要求。

这些资源如有变更，恕不另行通知。TI 授权您仅可将这些资源用于研发本资源所述的 TI 产品的应用。严禁对这些资源进行其他复制或展示。您无权使用任何其他 TI 知识产权或任何第三方知识产权。您应全额赔偿因在这些资源的使用中对 TI 及其代表造成的任何索赔、损害、成本、损失和债务，TI 对此概不负责。

TI 提供的产品受 [TI 的销售条款](#) 或 [ti.com](#) 上其他适用条款/TI 产品随附的其他适用条款的约束。TI 提供这些资源并不会扩展或以其他方式更改 TI 针对 TI 产品发布的适用的担保或担保免责声明。

TI 反对并拒绝您可能提出的任何其他或不同的条款。

邮寄地址：Texas Instruments, Post Office Box 655303, Dallas, Texas 75265

Copyright © 2023，德州仪器 (TI) 公司