

TI 设计: TIDA-01021

适用于 DSO、雷达和 5G 无线测试仪的多通道 JESD204B 15GHz 时钟参考设计



说明

TIDA-01021 设计利用拥有集成式 VCO 的 TI LMX2594 宽带 PLL，生成适用于 JESD204B 接口的 10MHz 到 15GHz 的时钟和 SYSREF，从而能够在单独的电路板上支持两个高速通道。时钟频率为 15GHz 时，10kHz 偏移相位噪声低于 -104dBc/Hz 。此 TI 设计使用 TI 的 ADC12DJ3200 高速转换器 EVM，可在 5.25GHz 的输入信号下实现小于 10ps 的板对板时钟偏斜以及 49.6dB 的 SNR。本文对所有重要设计理论都进行了阐释说明，可指导用户完成器件选择流程和设计优化。最后，此参考设计介绍了原理图、板布局、硬件测试和结果。

资源

TIDA-01021	设计文件夹
ADC12DJ3200EVM	工具文件夹
ADC12DJ3200	产品文件夹
LMX2594	产品文件夹
LMK04828	产品文件夹
LMK61E2	产品文件夹
TSW14J56EVM	工具文件夹

特性

- 高达 15GHz 的采样时钟生成
- 符合 JESD204B 标准的多通道时钟解决方案
- 适用于射频采样 ADC 和 DAC 的低相位噪声时钟
- 可配置相位同步，可在多通道系统中实现低偏斜
- 支持 TI 的高速转换器和采集卡
(ADC12DJ3200EVM、TSW14J56 和 TSW14J57)

应用

- [高性能示波器](#)
- [相控阵雷达](#)
- [无线通信测试仪](#)
- [直接采样软件定义的无线电](#)



咨询我们的 E2E 专家

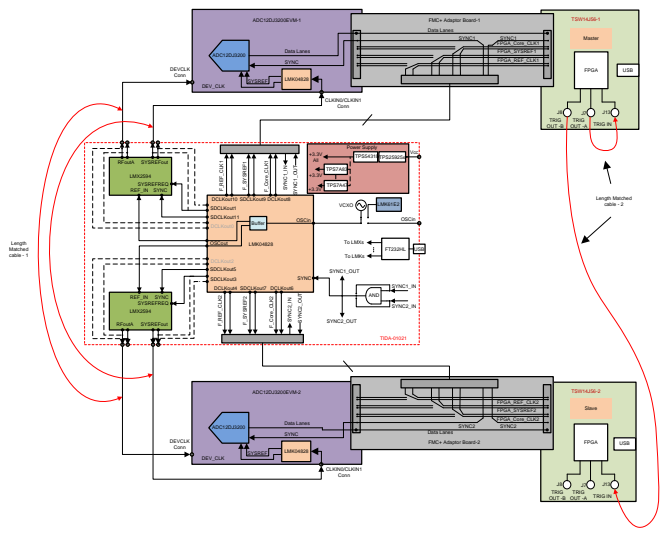
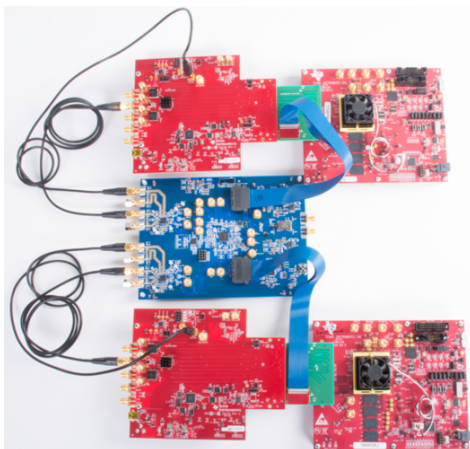

Copyright © 2017, Texas Instruments Incorporated



该 TI 参考设计末尾的重要声明表述了授权使用、知识产权问题和其他重要的免责声明和信息。

1 System Description

Clocking solutions for high-speed GPS direct RF sampling signal chains are critical to achieve high SNR and low channel-to-channel skew. This reference design demonstrates a multichannel phase-synchronized clocking platform that can be used in applications such as DSO, phased array radars, and 5G wireless testers. Using the LMX2594 frequency synthesizer for DEVCLK and SYSREF generation, this TI Design can clock JESD204B data converters. Furthermore, by using the LMK04828 to generate the FPGA clocks and SYSREF signals, multiple channels can be supported.

In this solution, two LMX2594 devices receive a 100-MHz VCXO reference signal through the LMK04828 and generate phase synchronized DEVCLK (sampling clock) and SYSREF for two high-speed signal chains. The LMK04828 clock jitter cleaner generates independent SYSREFREQ signal and SYNC signal to both LMX2594 devices for SYSREF generation. The LMK04828 generates FPGA device clocks for each channel that are synchronized to the respective SYSREFREQ outputs.

High-performance multichannel digital storage oscilloscopes require a signal chain with a wideband analog front end, high SNR, and low channel-to-channel skew. The ADC12DJ3200 ADC is well suited for these requirements. The clocking solution described in this TI Design provides an optimum solution for clocking the ADC12DJ3200 ADCs to achieve high SNR and low channel-to-channel skew.

Wireless tester equipment use multichannel receivers for testing cellular and MIMO devices. Wireless testers require high dynamic range and wideband receivers to test 3G and later wireless standards compliant equipment. The ADC12DJ3200 is well suited for the multichannel receiver requirements of the wireless testers. The clocking solution described in this TI Design supplements a high-performance signal chain solution based on multiple ADC12DJ3200 ADCs to achieve a low time skew between channels providing both high dynamic range and wide receiver.

Phased array radar applications need a high dynamic range, wide receiver bandwidth, low latency, and good synchronization between the channels. The signal chain solution based on the LMX2594, ADC12DJ3200, and LMK04828 devices are able to achieve optimum performance for phased array radar applications.

Direct RF-sampling software-defined radio (SDR) technology needs multiple channels, high dynamic range, highly re-configurable receiver bandwidth, and wide input frequency range. This TI Design can meet the requirements of the high-performance SDRs in terms of multichannel, dynamic range, and reconfigurability.

1.1 Key System Specifications

The objective of the TI Design is to demonstrate a high-speed clocking solution for a multichannel signal chain. Phase noise and jitter performance of the LMX2594 along with an onboard crystal or LMK61E2 reference is shown in 表 1. The TIDA-01021 design focuses on measuring the SNR at the ADC12DJ3200 signal chain and configurable phase delay to align multichannel clocks. The data capture is done by the TSW14J56, which is interfaced with the ADC12DJ3200EVM using an FMC adapter card. 表 1 lists the key system level specifications for the signal chain from the clocking solution perspective.

表 1. Key System Specifications

PARAMETER	SPECIFICATIONS	CONDITIONS
Dev_Clk phase noise	-117.0 dBc/Hz at 10-kHz offset -119.7 dBc/Hz at 100-kHz offset -130.5 dBc/Hz at 1-MHz offset -149.5 dBc/Hz at 10-MHz offset	at 3.5 GHz
	-108.8 dBc/Hz at 10-kHz offset -111.4 dBc/Hz at 100-kHz offset -123.1 dBc/Hz at 1-MHz offset -147.4 dBc/Hz at 10-MHz offset	at 9 GHz
	-104.7 dBc/Hz at 10-kHz offset -107.5 dBc/Hz at 100-kHz offset -114.7 dBc/Hz at 1-MHz offset -141.7 dBc/Hz at 10-MHz offset	at 15 GHz
SNR (dBFS) (dual channel mode)	56.3	at a 997-MHz ADC input signal
	55.2	at a 2482-MHz ADC input signal
	52.6	at a 5250-MHz ADC input signal
Multichannel clock time skew	< 10 ps	at a 3-GHz clock output
Channel-to-channel time skew	< 50 ps	at a 997-MHz ADC input signal
		at a 2482-MHz ADC input signal

2 System Overview

2.1 Block Diagram

图 1 shows the block diagram of the high-speed multichannel clock solution interface with the ADC12DJ3200 EVM and TSW14J56 capture cards. The ADC12DJ3200 EVM is interfaced with the TSW14J56 data capture board through an FMC+ adapter board. The ADC DCLK and SYSREF are provided from the TIDA-01021 clocking board using the length matched cables.

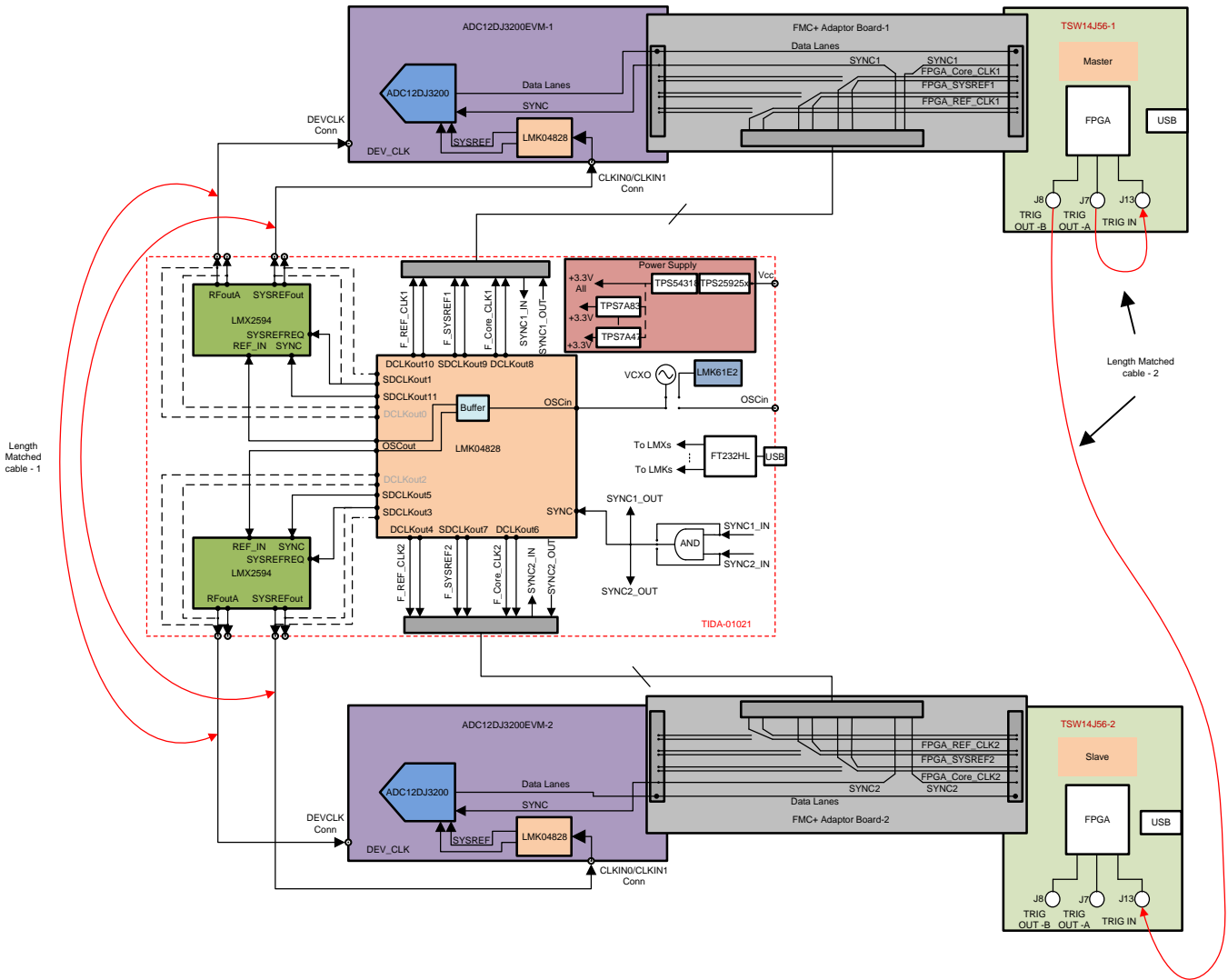

Copyright © 2017, Texas Instruments Incorporated

图 1. Block Diagram of Interface Between Clocking Board, ADC12DJ3200 EVM, FMC+ Adaptor Board, and TSW14J56 Board

2.2 Highlighted Products

2.2.1 LMX2594

The LMX2594 is a high-performance, wideband RF PLL with integrated VCO that supports a frequency range from 10 MHz to 15 GHz without using an internal doubler. The device supports both fractional-N and integer-N modes, with a 32-bit fractional divider allowing fine frequency selection. The high-performance PLL with a figure of merit of -236 dBc/Hz and high phase detector frequency can attain very low in-band noise and integrated jitter. Its integrated noise of 45 fs for a 7.5-GHz output makes the device an ideal low-noise source. The device accepts an input reference frequency up to 1.4 GHz, which combines with frequency dividers and programmable low-noise multiplier to allow for flexible frequency planning. The high-speed N-divider has no pre-divider, thus significantly reducing the amplitude and number of spurs. The additional programmable low-noise multiplier allows users mitigate the impact of integer boundary spurs. In fractional-N mode, the device can adjust the output phase by a 32-bit resolution. For applications that need fast frequency changes, the device supports a fast calibration option, which takes less than 20 μ s. The LMX2594 adds support for generating or repeating SYSREF (compliant to JESD204B standard), making it an ideal low-noise clock source for high-speed data converters. Fine delay adjustment (9-ps resolution) is provided in this configuration to account for delay differences of board traces. This device uses a single 3.3-V supply and it has integrated LDOs that eliminate the need for onboard low-noise LDOs.

2.2.2 ADC12DJ3200

The ADC12DJ3200 is a RF-sampling GSPS ADC with a -3 -dB input bandwidth up to 6 GHz. The 12-bit ADC12DJ3200 can sample up to 3200-MSPS in dual mode and up to 6400-MSPS in single channel mode. The ADC12DJ3200 can be used to sample signals in the first, second, and higher Nyquist zones. The ADC12DJ3200 use a high-speed JESD204B output interface with up to 16 serialized lanes and supporting subclass-1 for deterministic latency and multi-device synchronization. The serial output lanes support up to 12.8 Gbps and can be configured to trade off bit rate versus number of lanes. In dual channel mode, optional digital down converters can tune and decimate a band from RF to a complex baseband signal to reduce the interface data rate in bandwidth limited applications.

2.2.3 LMK04828

The LMK04828 is a dual-PLL jitter cleaner and clock generator for JESD204B systems. The LMK04828 has 14 clock outputs from PLL2 those can be configured drive seven JESD204B converters or other logic devices using device and SYSREF clocks. The LMK04828 supports two ranges of VCOs, from 2370 to 2630 MHz and 2920 to 3080 MHz.

2.2.4 LMK61E2

The LMK61E2 is an ultra-low jitter PLLatinum™ programmable oscillator with a fractional-N frequency synthesizer with an integrated VCO that generates commonly used reference clocks. The outputs can be configured as LVPECL, LVDS, or HCSL. The device features self-startup from an on-chip EEPROM that is factory programmed to generate a 100-MHz LVDS output. The device registers and EEPROM settings are fully programmable in-system through an I²C serial interface. Internal power conditioning provides excellent PSRR, reducing the cost and complexity of the power delivery network. The device operates from a single 3.3-V \pm 5% supply. The device provides fine and coarse frequency margining options through I²C serial interface to support system design verification tests (DVT) such as standard compliance and system timing margin testing.

2.3 System Design Theory

The multichannel clock design is based on two design goals: low-phase noise DEVCLK generation and scalable multichannel clock solution with provision for phase alignment trimming. This section describes the design details of various functional blocks that help to achieve these system design goals.

2.3.1 LMX2594 Improved Phase Noise

The TIDA-01021 block diagram is shown in 图 2. In order to achieve phase synchronization, the two LMX2594 synthesizers are given a common reference frequency input, SYNC and SysRefReq signal from the LMK04828. To adjust slight mismatches in phase of the two generated clocks, the LMX2594 provides the feature of programming the clock phase using the MASH_SEED value. From the LMK device, the OSCout signal provides the reference frequency to the LMX2594. The SDCLKout signal is used for generating sync and sysref for the LMX2594. Because the LMX2594 devices are being used in master mode, SysRefReq signal needs to be at logic high. To ensure this, the respective SDCLKout pins are made conditionally low. Prior to feeding this signal to a balun, the positive and negative signals of the differential pair are exchanged. This exchange gives a continuous high logic at the balun output and serves as the SysRefReq signal.

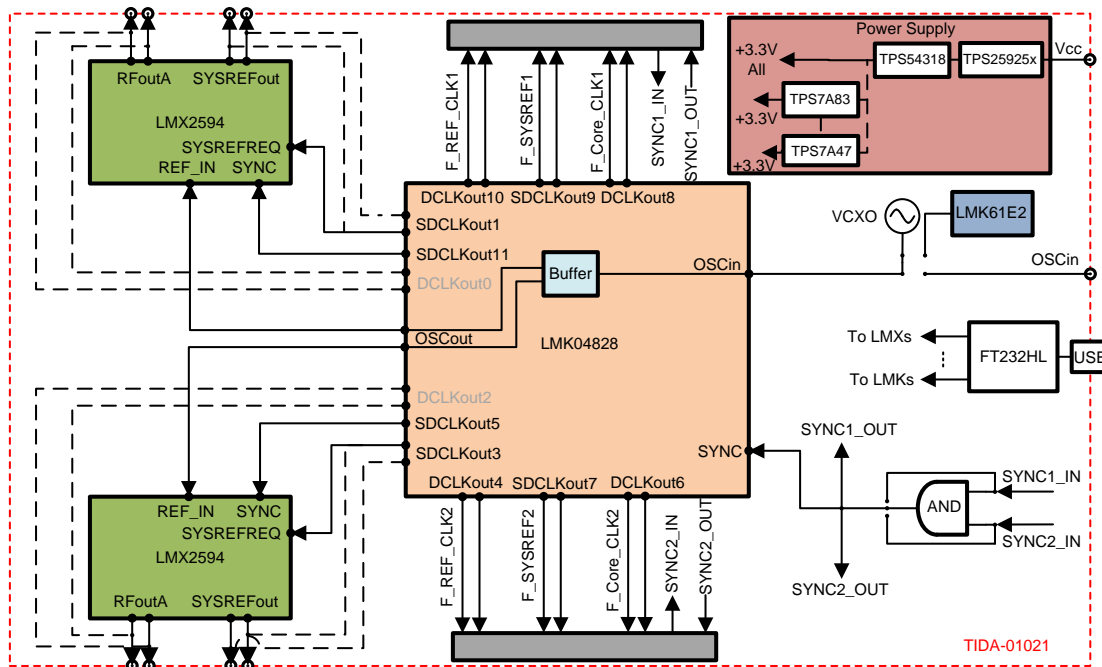

Copyright © 2017, Texas Instruments Incorporated

图 2. Clocking Board

A positive edge is required at the sync input to force the LMX2594 devices in sync mode. By toggling the SYNC_POL bit, the LMX2594 device is brought into the sync mode first. This process also enables the SDCLKout outputs and starts sending pulses to the sync pin. Because the SDCLKout pins used for sysref are conditionally low always, they are not affected by this operation. Once a pulse has been provided to the sync pins of the LMX devices, the respective SDCLKout pins are powered down.

The LMK04828 provides a clock of 100 MHz from OSCout to the LMX devices, which is then converted to 200 MHz inside the device and used as the phase detector frequency. Higher phase detector frequency improves the phase noise and also avoids spurs. As a result, loop filters are designed for a 200-MHz phase detector frequency. For this TI Design, the phase noise of the output clock is the critical performance parameter. Its measurement results are given in 4 节.

2.3.2 Multichannel Configured Phase Synchronized Clocks

When clocking multiple channels, channel-to-channel skew becomes an important design consideration. Clock jitter and phase mismatch leads to deviation from the ideal sampling instant of a channel and thereby, results in channel-to-channel skew. The LMX2594 synthesizers used in this TI Design have an excellent phase noise performance at high frequencies, which brings down the clock jitter to around 45 fs. Additionally, because of the phase synchronization feature of the LMX2594, it helps in improving the channel-to-channel skew.

A 100-MHz reference frequency is provided to the LMX synthesizers by the LMK61E2 and then divided to a 25-MHz phase detector frequency, which is limited by the sync feature of the LMX2594. The DEVCLK and SYSREF signals generated by the two LMX synthesizers are at 3 GHz and 25 MHz, respectively.

2.3.3 SYSREF Selection for ADC12DJ3200 at Operating Sampling Frequency

For measuring the impact of the TIDA-01021 clocking solution, it is validated with ADC12DJ3200 EVM. The JESD204B compliant clock output from the board is given to ADC12DJ3200. Because SNR of the ADC is directly affected by clock jitter, it is used to analyze the performance of the clocking board. The ADC12DJ3200 can go up to a 3.2-GHz clock frequency, but the TSW14J56 capture card is limited at a 12-Gsps data rate, which limits the clocking frequency of ADC. Hence, the ADC clock frequency is set at 2.7 GHz. The LMK04828 is configured in 0-delay SYSREF mode to phase synchronized as OSCin and remaining generated clocks. The LMK04828 on the TIDA-01021 design is used to provide a FPGA reference clock, a core clock, and SYSREF to the TSW14J56 capture card through the FMC+ adapter board. The reference and core clock frequency are 270 MHz and the SYSREF frequency is 33.75 MHz. The adapter board also provides the interface between the ADC EVM and the capture card as it connects the ADC lanes to the FPGA.

The ADC12DJ3200 operates in dual channel mode (JMODE2) where input to only one channel is provided and output from the corresponding ADC core is captured. Moreover, an input reference frequency of 33.75 MHz is provided to the LMX device by the LMK61E2, and the LMK04828 is used as a buffer. The phase detector frequency is also changed to 33.75 MHz and the new loop filter configuration is given in 表 2. Various input signals are given at the ADC input for SNR measurement and results are shown in 4 节.

表 2. Loop Filter Component

PARAMETER	VALUE
VCO gain	110 MHz/V
Loop bandwidth	90.35 KHz
Phase margin	51.42 deg
C1_LF	1.5 nF
C2_LF	56 nF
C3_LF	Open
C4_LF	1.8 nF
R2	120 Ω

表 2. Loop Filter Component (continued)

PARAMETER	VALUE
R3_LF	0 Ω
R4_LF	270 Ω
Charge pump gain	15 mA
Phase detector frequency	33.75 MHz
VCO frequency	Designed for 10.8 GHz, but works over the whole frequency range

3 Getting Started Hardware and Software

3.1 Hardware Configuration

3.1.1 Clocking Board Setup

图 1 shows the block diagram for the setup of the TIDA-01021 clocking board for skew measurement. The connection configuration as shown in 图 3 is as follows:



图 3. Test Setup

- Power:
 - Power supply connector J25: This connector is used to connect the power supply. Set the power supply to 5 V with a 2-A current limit.
- Input signals:
 - Option 1: The onboard VCXO Y1 is powered on using the jumper J8 and outputs a 100-MHz signal to the LMK04828 OSCin* pin input. While using Y1, disconnect the clock inputs from LMK61E2 (U2) and external reference by removing R36 and R38. At the same time, isolate the power supply to U2 by removing the jumper J16.
 - Option 2: The onboard reference LMK61E2 (U2) is powered on using the jumper J16 and factory programmed to generate a 100-MHz LVDS output. U2 can be programmed to generate different clock frequencies using the I²C interface. While using U2, disconnect the clock inputs from Y1 and external reference by removing C179, R37, and R39 then place R36 and R38. Isolate the power supply to Y1 by removing the J8.
 - Option 3: Connect the external reference to external OSCinP and OSCinN connectors. While connecting external reference, disconnect the Y1 and U2 connection by removing C179, R45, and R46 and place R36 and R38. Disconnect the power supply of Y1 and U2 by removing jumpers J8 and J16.

- Output signals:
 - RFoutAP1, RFoutAM1, RFoutAP2, and RFoutAM2 connectors generate the DCLK and are connected to the phase noise analyzer to measure phase noise and are connected to ADC EVMs for to measure SNR.
 - RFoutBP1, RFoutBM1, RFoutBP2, and RFoutBM2 connectors generate the low-frequency SYSREF signals.
 - Connectors J2 and J5 generates the FPGA CLKs and SYSREFs for both channels.
- Programming interface:
 - Connect the USB mini cable to the onboard USB connector U7 and test PC to program the clocking board devices using the High Speed Data Converter (HSDC) Pro Software GUI.

3.1.2 FMC+ to FMC Adapter Board Setup

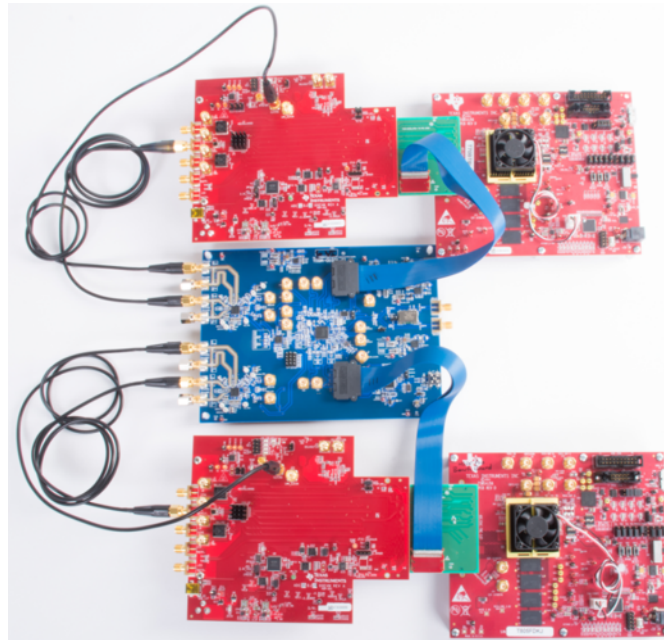
The FMC+ to FMC adapter board has connections to take FPGA clocks from the TIDA-01021 clocking or ADC12DJ3200 EVM. Follow the schematic to connect the FPGA clocks and SYSREFs from the clocking board.

3.1.3 ADC12DJ3200 EVM Setup

Follow the ADC12DJ3200 EVM user's guide[1] for the ADC12DJ3200 EVM hardware setup procedure. The ADC12DJ3200 EVM has both internal as well as external options for clocking the ADC. Selecting the DEVCLK is based on the placement of capacitors on the shared pads. Connect C49 and C50 for the external DEVCLK. Connect the external SYSREF for the ADC at connector J38 from the TIDA-01021 clocking board.

3.1.4 TSW14J56 Setup

Follow the TSW14J56 EVM user's guide[2] for TSW14J56 EVM hardware setup procedure.

3.2 Software

3.2.1 Clocking Board Programming

- Clocking board devices are programmed by HSDC TID GUI, as shown in [图 4](#).
- All devices are configured by loading the configuration files in low level view page.
- To measure phase noise, configure the following:
 - The LMK61E2 is programmed at 100 MHz. Configure the file in low-level view page.
 - The LMK04828 is taking a reference from the LMK61E2 and generates a reference to the LMX2594 through the OSCout pin. Load the config file for OSCout enable.
 - The LMX2594 is programmed for a 100-MHz reference and 200-MHz phase detector frequency at various frequencies to measure the phase noise.
- To measure clock skew, configure the following:
 - The LMK61E2 is programmed at 100 MHz. Configure the file in low-level view page.
 - The LMK04828 is programmed in 0-dalay PLL mode at a 25-MHz SYSREF frequency and provides the SYSREFREQ and SYNC signals along with this 100-MHz OSCout as reference to both LMX2594 devices.
 - Both LMX2594 devices are programmed with the common configuration file at a 25-MHz phase detector frequency and generate a 3-GHz RFoutA and 25-MHz SYSREFout (RFoutB) from both devices.
- To measure the ADC12DJ3200 SNR, configure the following:
 - The LMK61E2 is programmed at 33.75 MHz. Configure the file in low-level view page.
 - The LMK04828 is programmed in 0-dalay PLL mode at a 33.75-MHz SYSREF frequency and provides the SYSREFREQ and SYNC signals along with this 33.75-MHz OSCout as a reference to the LMX2594. The LMK04828 also generates the device clock and SYSREF for FPGA capture card.
 - The LMX2594_A is programmed for a 2.7-GHz RFoutA and 33.75-MHz SYSREF at a 33.75-MHz phase detector frequency.



图 4. Clocking Board Programming

3.2.2 ADC12DJ3200 EVM Programming

Download the [ADC12DJxx00 GUI](#) from [TI.com](#) to program the ADC12DJ3200 EVM: <http://www.ti.com/lit/zip/slac745>. The ADC12DJ3200 and LMK04828 are devices configured for SNR measurement in the ADC12DJ3200 EVM, as shown in [图 5](#). The LMK04828 is programmed in distribution mode for the CLKin0 drive to configure SYSREF directly. The ADC12DJ3200 EVM is put into JMODE2 mode to use in dual channel mode at full Nyquist zone of the device. The EVM is setup in external clock source selection mode, with a sampling frequency 2700 Msps and load configuration files in the low-level view page of the ADC12DJ3200 GUI.

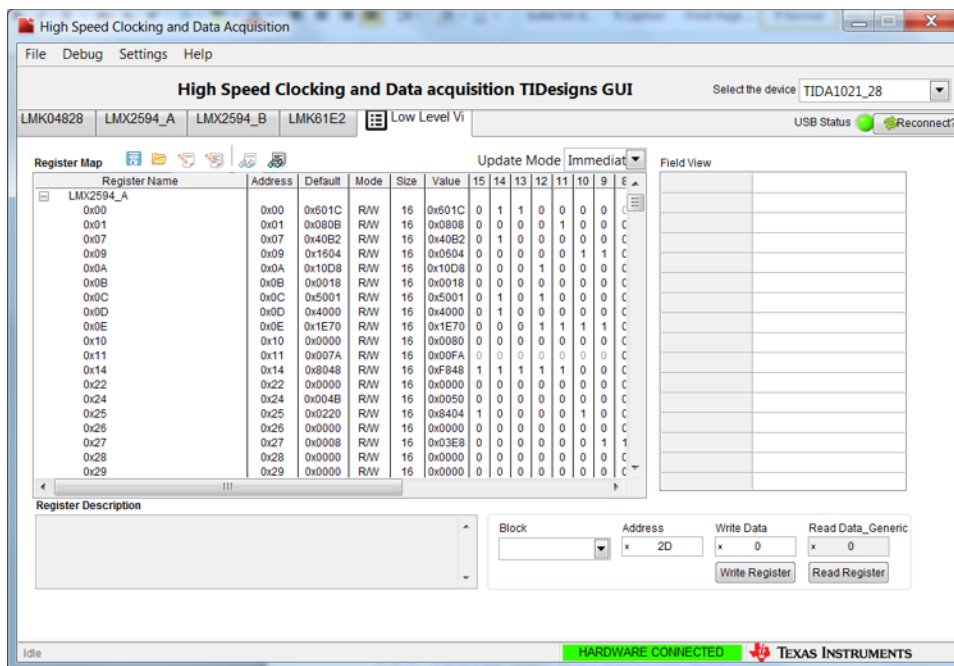

图 5. ADC12DJ3200 EVM Programming

3.2.3 HSDC Pro Setup

The HSDC Pro software interfaces with the TSW14J56 to capture and analyze the digital data from the ADC12DJ3200 in SNR measurement. Follow the TSW14J56 EVM user's guide[\[2\]](#) for HSDC Pro setup and to capture and analyze the data.

4 Testing and Results

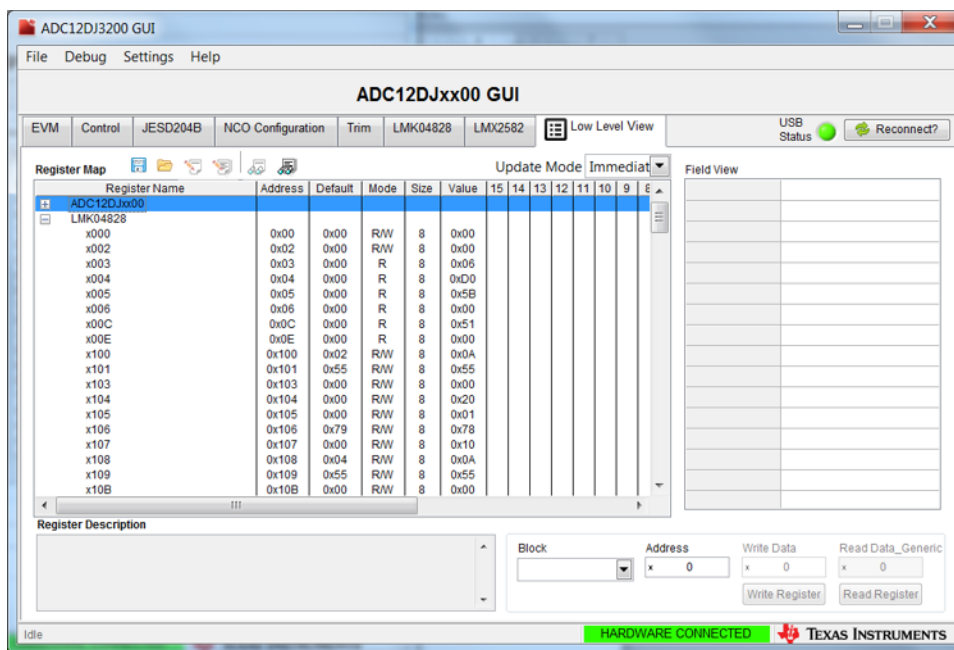
4.1 Test Setup

图 6, 图 7, 图 8, 和 图 9 显示 LMX2594 相位噪声、时钟 skew、SNR 测量, 和 channel-to-channel skew 测量, 分别。

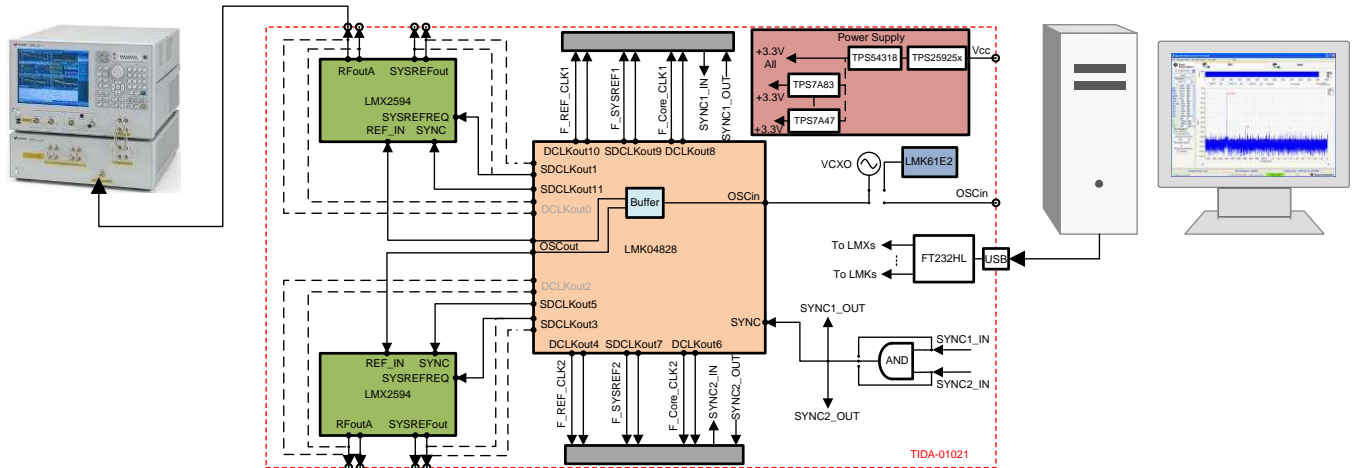

Copyright © 2017, Texas Instruments Incorporated

图 6. Test Setup for Phase Noise Measurement

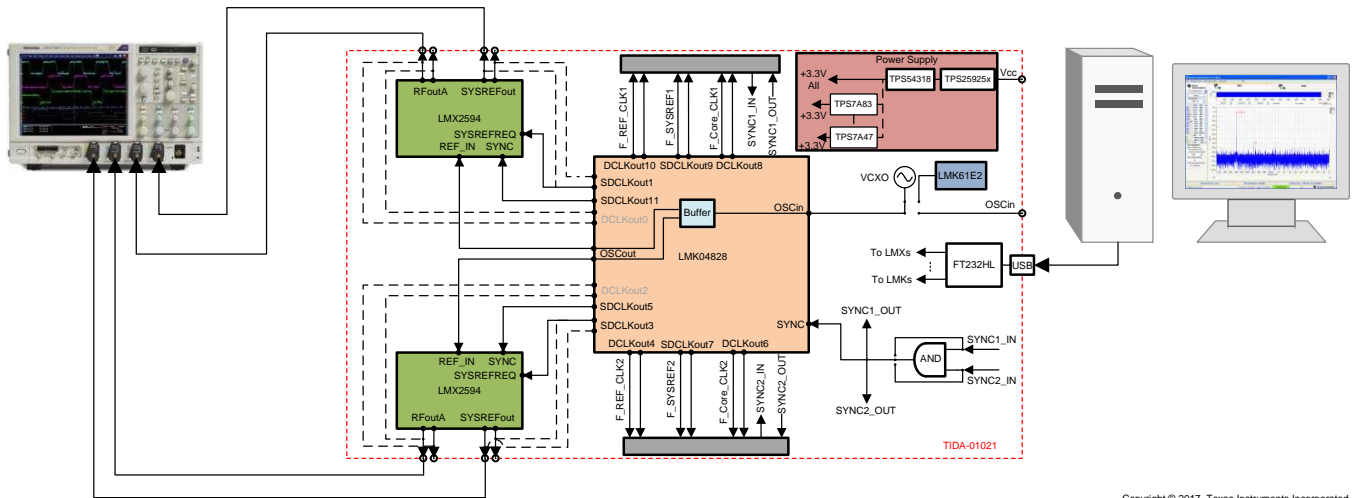

Copyright © 2017, Texas Instruments Incorporated

图 7. Test Setup for Multichannel Clock Skew Measurement

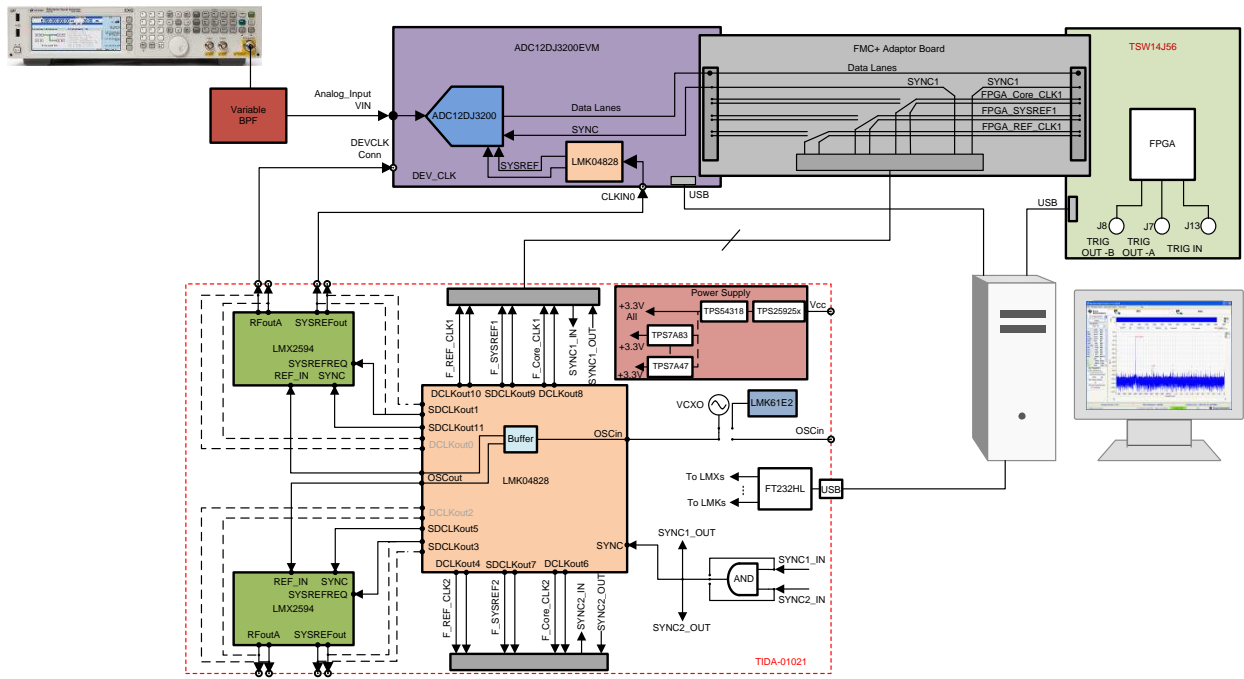

Copyright © 2017, Texas Instruments Incorporated

图 8. Test Setup for SNR Measurement

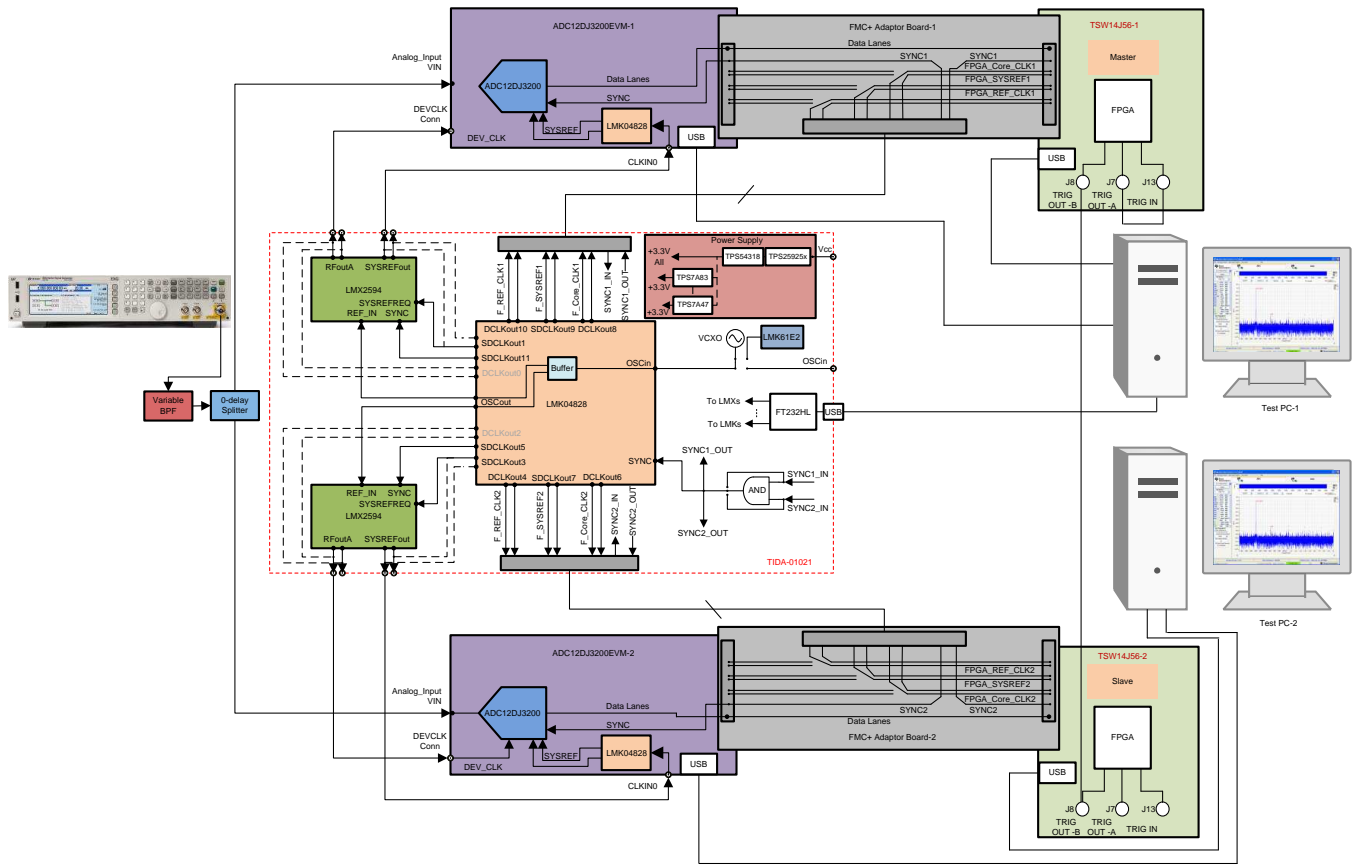

Copyright © 2017, Texas Instruments Incorporated

图 9. Test Setup for Channel-to-Channel Skew Measurement

4.2 Results

4.2.1 Phase Noise Performance

Both LMX2594 devices show almost the same results as both are identical on board. 表 3 shows the measured phase noise performance of the LMX2594-A at various clock frequencies in clock board.

Measured phase noise plots are shown in 图 10, 图 11, and 图 12.

表 3. Measured Phase Noise

OUTPUT FREQUENCY (GHz)	CONDITION	EXPECTED PHASE NOISE (dBc/Hz)	MEASURED PHASE NOISE (dBc/Hz)
3.5	10-kHz offset	-117.0	-116.0
	100-kHz offset	-119.7	-118.3
	1-MHz offset	-130.5	-128.7
	10-MHz offset	-149.5	-151.5
9.0	10-kHz offset	-108.8	-108.1
	100-kHz offset	-111.4	-110.1
	1-MHz offset	-123.1	-122.9
	10-MHz offset	-147.4	-147.5
15.0	10-kHz offset	-104.7	-103.8
	100-kHz offset	-107.5	-105.9
	1-MHz offset	-114.7	-115.1
	10-MHz offset	-141.7	-140.8



图 10. Phase Noise at 3.5 GHz



图 11. Phase Noise at 9 GHz

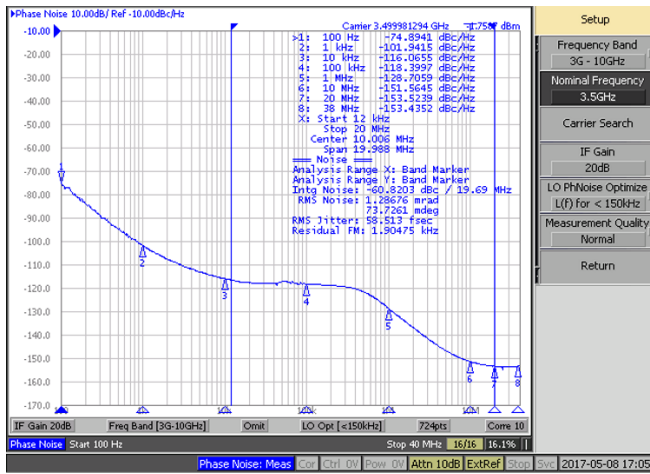

图 12. Phase Noise at 15 GHz

4.2.2 Multichannel Clock Phase Alignment

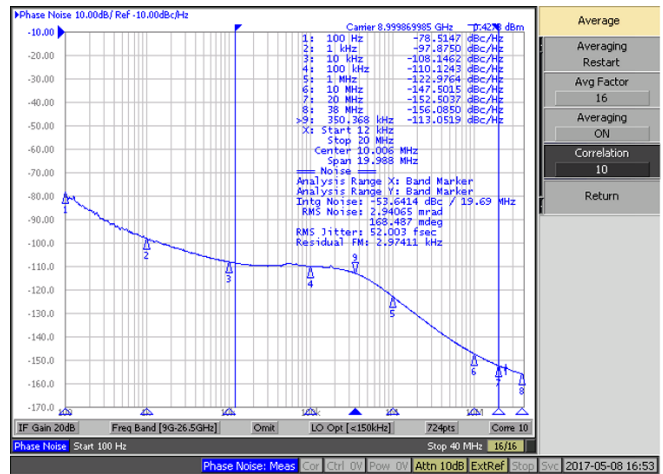
As explained in 节 2.3.2, synchronized clocks are critical for multichannel systems. This section shows the measured phase aligned clocks and SYSREFs that are generated from both LMX2594 devices at a 3-GHz device clock and 25-MHz SYSREF. The minimum skew have between the clocks, reflects the minimum channel-to-channel skew in multichannel systems. In this test, the TIDA-01021 clock board shows the clock skew less than 10 ps. As a result, it can reduce the channel-to-channel skew in multichannel systems. 图 13 shows the multichannel clock skew measured results from two LMX2594 devices at the device clocks and SYSREF signals.

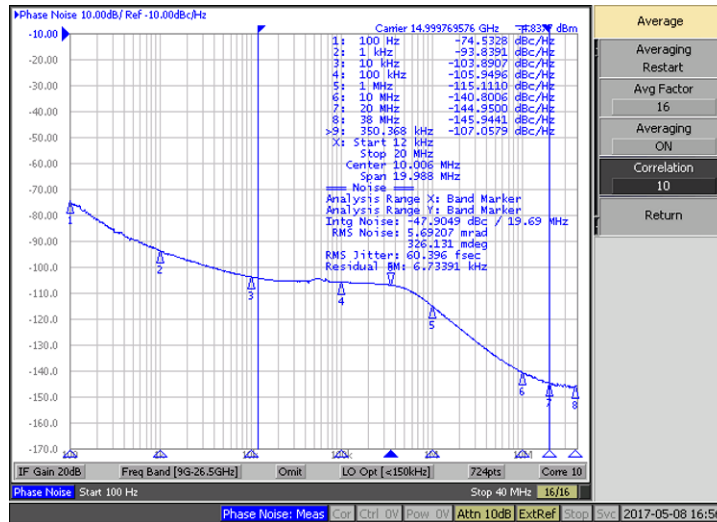

图 13. Multichannel Clock Skew Measurement

4.2.3 Signal Chain Performance

表 4 显示了 ADC12DJ3200 在各种频率下 -1-dBFS 差分输入和双通道模式 (JMODE2) 的测量 SNR 性能。将测量的 SNR 与 ADC12DJ3200EVM 板上时钟和 TIDA-01021 时钟的测量 SNR 进行比较，显示了 SNR 的微小差异，这是由于 TIDA-01021 时钟合成器 (LMX2594) 中使用的较低 PFD 频率所致。较低的 PFD 频率被选中，以允许多通道同步化的 DEVCLK 和 SYSREF 生成。图 14、图 15，和图 16 显示了在 2700-MHz 采样频率下的双通道模式中的频谱结果。

表 4. SNR Measurement

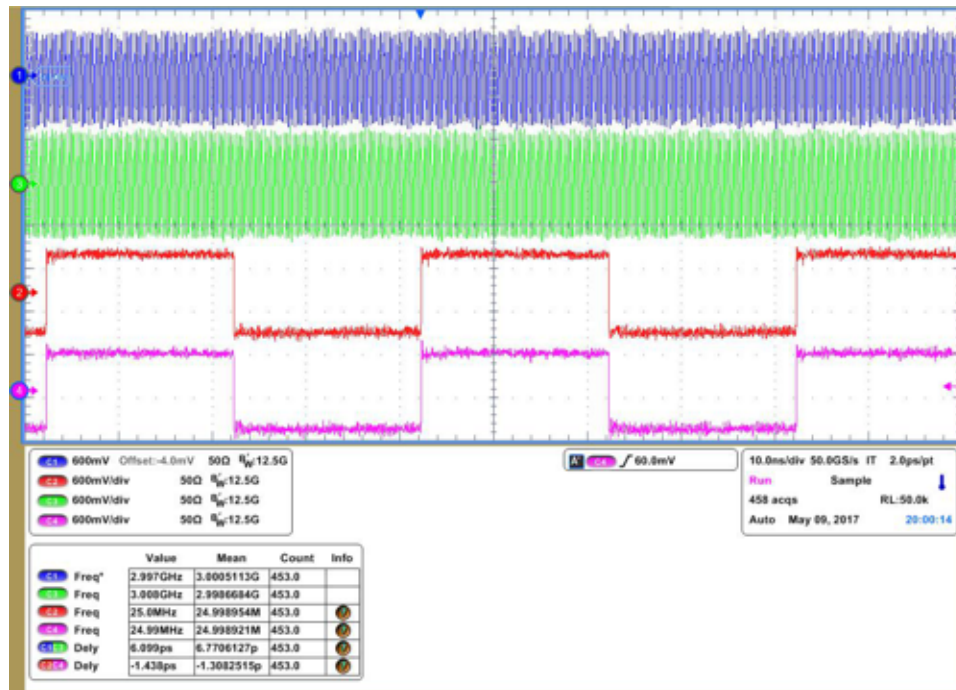
INPUT FREQ (MHz)	ADC DATASHEET SNR (dBFS)	MEASURED SNR ON ADC12DJ3200EVM WITH ONBOARD CLOCK (dBFS)	MEASURED SNR ON ADC12DJ3200EVM WITH TIDA-01021 CLOCKS (dBFS)
997	56.3	55.25	54.4
2483	55.2	52.71	51.9
5250	52.6	50.34	49.6



图 14. Spectrum at 997-MHz Input



图 15. Spectrum at 2482-MHz Input

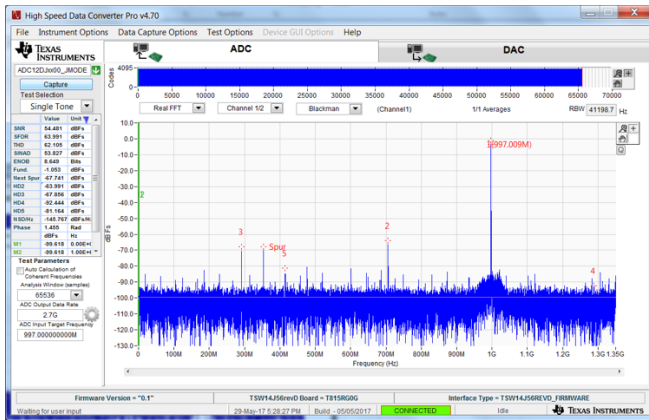

图 16. Spectrum at 5250-MHz Input

4.2.4 Channel-to-Channel Skew Measurement

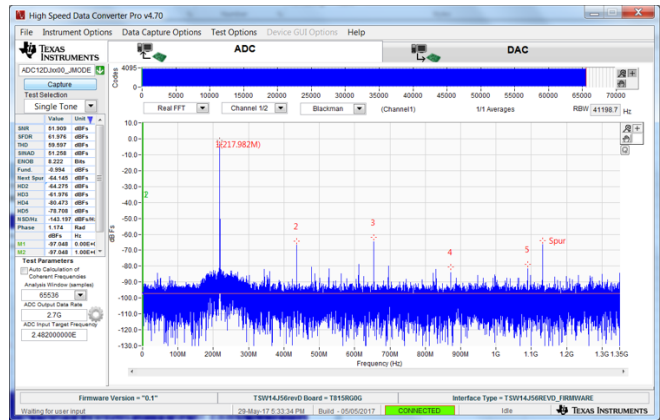
表 5 shows the time skew between two ADC12DJ3200 EVM channels at different input frequencies. This skew is evaluated by calculating the phase difference between signals captured from each ADC. These measurements taken at a 2.7-GHz sampling frequency and measured time skew was < 50 ps for each input frequencies.

表 5. Measured Channel-to-Channel Skew

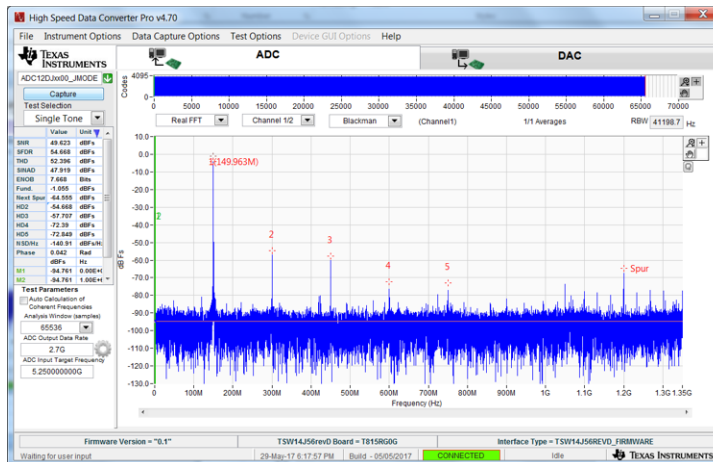
INPUT FREQUENCY (MHz)	MEASURED TIME SKEW (ps)
997	9.23
2482	9.35

图 17 is a plot of the output samples of the two ADCs for a 997-MHz input, which is in first Nyquist zone for a 2700-MHz sampling clock. 图 18 is the plot of the output samples for a 2482-MHz input, which is in second Nyquist zone for a 2700-MHz sampling clock. The 2482-MHz input signal aliases to 218 MHz and a phase difference of 8.35 degrees is measured, which translates to a channel-to-channel skew of 9.35 ps for the 2482-MHz input.

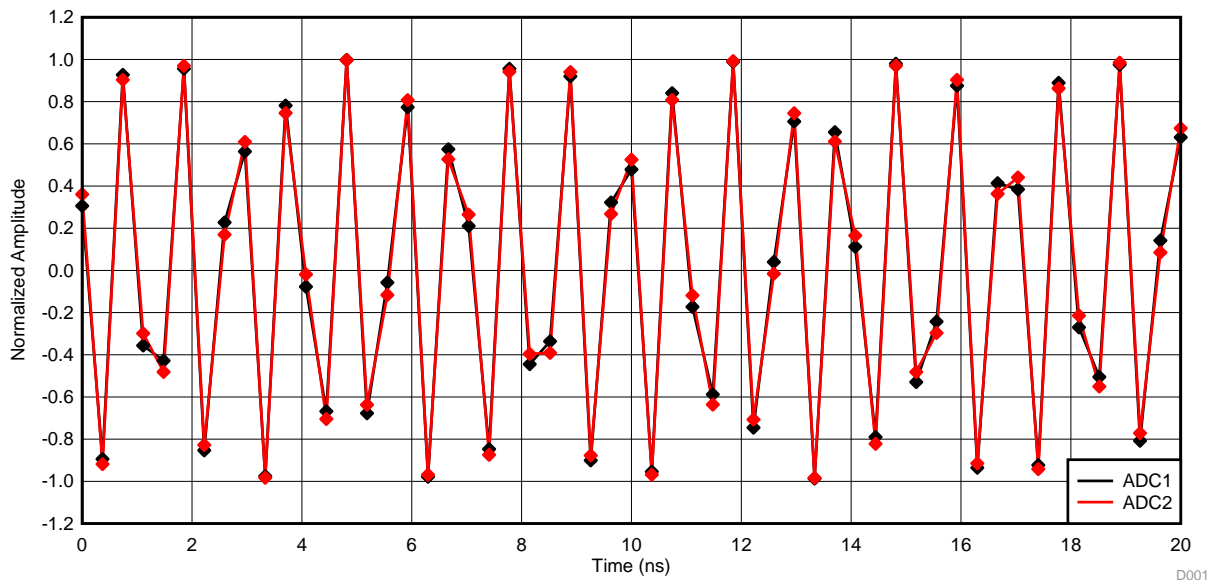

ADC2 lags ADC1 by 3.31 degrees or 9.23 ps.

图 17. Sampled Signals at 997-MHz Input

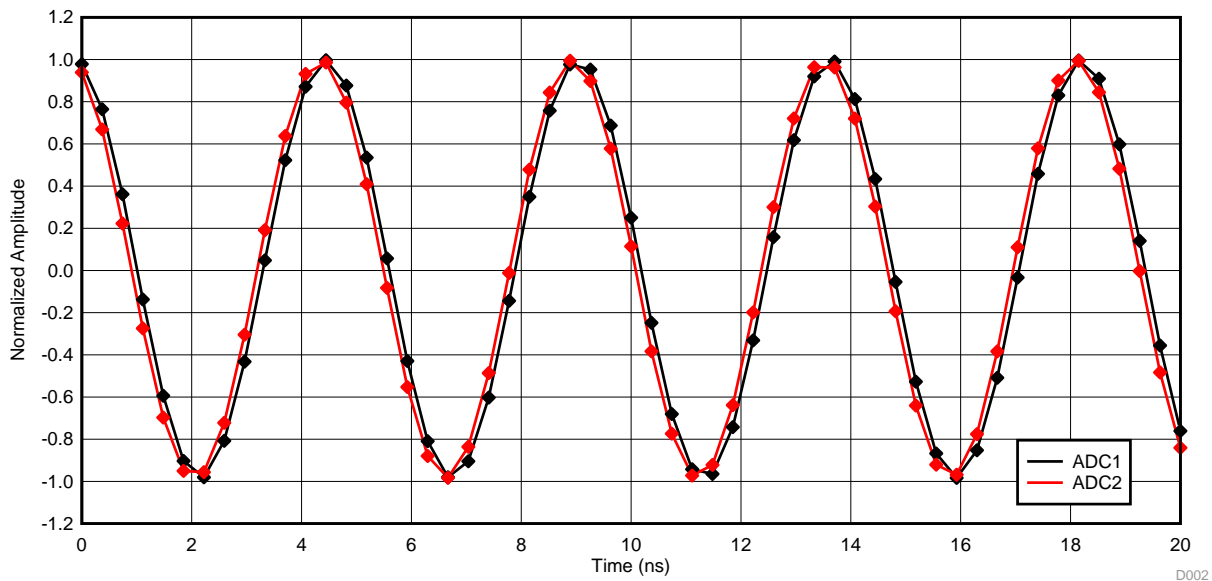

ADC1 lags ADC2 by 8.35 degrees or 9.35 ps.

图 18. Sampled Signals at 2482-MHz Input

4.3 Summary and Conclusion

The TIDA-01021 design is a multichannel JESD204B compliant clocking reference design that can be used for DSO, radar, and 5G wireless testers. This TI Design demonstrates a high-performance (low-phase noise) clock generation, using the LMX2594, LMK61E2 and LMK04828 devices. This design also demonstrates the multichannel configurable phase synchronized clocks with skew of less than 10 ps. Finally, the ADC12DJ3200 EVM onboard clock is replaced with TIDA-01021 outputs to demonstrate the impact on system performance. The system SNR is close to the ADC12DJ3200EVM performance and clock skew at less than 10 ps. The system shows deterministic latency behavior for every power ON cycle with the analog input channel-to-channel skew at less than 50 ps.

5 Design Files

5.1 Schematics

To download the schematics, see the design files at [TIDA-01021](#).

5.2 Bill of Materials

To download the bill of materials (BOM), see the design files at [TIDA-01021](#).

5.3 PCB Layout Recommendations

5.3.1 Layout Prints

To download the layer plots, see the design files at [TIDA-01021](#).

5.4 Altium Project

To download the Altium project files, see the design files at [TIDA-01021](#).

5.5 Gerber Files

To download the Gerber files, see the design files at [TIDA-01021](#).

5.6 Assembly Drawings

To download the assembly drawings, see the design files at [TIDA-01021](#).

6 References

1. Texas Instruments, [ADC12DJ3200 Evaluation Module User's Guide](#) (SLAU701)
2. Texas Instruments, [TSW14J56 JESD204B High-Speed Data Capture and Pattern Generator Card User's Guide](#) (SLWU086)

6.1 商标

PLLatinum is a trademark of Texas Instruments.
All other trademarks are the property of their respective owners.

7 About the Authors

AJEET PAL is a systems engineer at Texas Instruments where he is responsible for developing reference design solutions for the Test and Measurement sector. Ajeet has six years of experience in RF and wireless subsystem design for cellular and wireless systems. Ajeet earned his bachelor of engineering in electronics and communication engineering from the Institute of Technology & Management (ITM) University at Gwalior and his masters of technology in RF and microwave engineering from the Indian Institute of Technology (IIT) Kharagpur, India.

SANKAR SADASIVAM is a system architect at Texas Instruments where he is responsible for architecting and developing reference design solutions for the industrial systems with a focus on Test and Measurement for the Industrial Systems Engineering team. Sankar brings to this role his extensive experience in analog, RF, wireless, signal processing, high-speed digital, and power electronics. Sankar earned his master of science (MS) in electrical engineering from the Indian Institute of Technology, Madras.

7.1 Acknowledgments

The authors would like to thank their colleagues Timothy Toroni, Jim Brinkhurst, Dean Banerjee, Ken Chan, Bryan Bloodworth, Anbu Mani, and Sudeep Mishra for their unconditional support and critical feedback during this design.

修订历史记录

注：之前版本的页码可能与当前版本有所不同。

Changes from Original (June 2017) to A Revision	Page
• 已更改 图 3: Test Setup	9
• 已添加 图 9: Test Setup for Channel-to-Channel Skew Measurement	15
• 已添加 节 4.2.4: Channel-to-Channel Skew Measurement	20
• 已添加 7.1 节: Acknowledgments	23

有关 TI 设计信息和资源的重要通知

德州仪器 (TI) 公司提供的技术、应用或其他设计建议、服务或信息，包括但不限于与评估模块有关的参考设计和材料（总称“TI 资源”），旨在帮助设计人员开发整合了 TI 产品的应用；如果您（个人，或如果是代表贵公司，则为贵公司）以任何方式下载、访问或使用了任何特定的 TI 资源，即表示贵方同意仅为该等目标，按照本通知的条款进行使用。

TI 所提供的 TI 资源，并未扩大或以其他方式修改 TI 对 TI 产品的公开适用的质保及质保免责声明；也未导致 TI 承担任何额外的义务或责任。TI 有权对其 TI 资源进行纠正、增强、改进和其他修改。

您理解并同意，在设计应用时应自行实施独立的分析、评价和判断，且应全权负责并确保应用的安全性，以及您的应用（包括应用中使用的 TI 产品）应符合所有适用的法律法规及其他相关要求。您就您的应用声明，您具备制订和实施下列保障措施所需的一切必要专业知识，能够 (1) 预见故障的危险后果，(2) 监视故障及其后果，以及 (3) 降低可能导致危险的故障几率并采取适当措施。您同意，在使用或分发包含 TI 产品的任何应用前，您将彻底测试该等应用和该等应用所用 TI 产品的功能。除特定 TI 资源的公开文档中明确列出的测试外，TI 未进行任何其他测试。

您只有在为开发包含该等 TI 资源所列 TI 产品的应用时，才被授权使用、复制和修改任何相关单项 TI 资源。但并未依据禁止反言原则或其他法律授予您任何 TI 知识产权的任何其他明示或默示的许可，也未授予您 TI 或第三方的任何技术或知识产权的许可，该等产权包括但不限于任何专利权、版权、屏蔽作品权或与使用 TI 产品或服务的任何整合、机器制作、流程相关的其他知识产权。涉及或参考了第三方产品或服务的信息不构成使用此类产品或服务的许可或与其相关的保证或认可。使用 TI 资源可能需要您向第三方获得对该等第三方专利或其他知识产权的许可。

TI 资源系“按原样”提供。TI 兹免除对 TI 资源及其使用作出所有其他明确或默示的保证或陈述，包括但不限于对准确性或完整性、产权保证、无复发故障保证，以及适销性、适合特定用途和不侵犯任何第三方知识产权的任何默认保证。

TI 不负责任何申索，包括但不限于因组合产品所致或与之有关的申索，也不为您辩护或赔偿，即使该等产品组合已列于 TI 资源或其他地方。对因 TI 资源或其使用引起或与之有关的任何实际的、直接的、特殊的、附带的、间接的、惩罚性的、偶发的、从属或惩戒性损害赔偿，不管 TI 是否获悉可能会产生上述损害赔偿，TI 概不负责。

您同意向 TI 及其代表全额赔偿因您不遵守本通知条款和条件而引起的任何损害、费用、损失和/或责任。

本通知适用于 TI 资源。另有其他条款适用于某些类型的材料、TI 产品和服务的使用和采购。这些条款包括但不限于适用于 TI 的半导体产品 (<http://www.ti.com/sc/docs/stdterms.htm>)、[评估模块](http://www.ti.com/sc/docs/sampters.htm)和样品 (<http://www.ti.com/sc/docs/sampters.htm>) 的标准条款。

邮寄地址：上海市浦东新区世纪大道 1568 号中建大厦 32 楼，邮政编码：200122
Copyright © 2017 德州仪器半导体技术（上海）有限公司