

TI Designs: TIDA-01412

网关和车身控制模块中的汽车微控制器电源参考设计



说明

该分立式电源参考设计展示了适用于 Freescale™MPC5748G 微控制器的完整的电源解决方案。这个简单的解决方案仅使用 5 个直流/直流转换器，提供比电源管理集成电路 (PMIC) 具有更高灵活性、扩展性和成本效益的解决方案。该设计支持多种汽车应用，如网关和中央车身控制模块。

资源

TIDA-01412	设计文件夹
TPS6213013A-Q1	产品文件夹
TPS62130A-Q1	产品文件夹
TPS62133A-Q1	产品文件夹
LM53603-Q1	产品文件夹
TPS40210-Q1	产品文件夹

特性

- 支持 2.7V 至 16V 输入电压，32V 峰值输入电压
- 在负载和可扩展性方面可灵活地适应未来几代的微控制器
- MCU 的 LV 内核电源电压精度小于 1%
- 效率高达 80%
- 只需要五个直流/直流转换器即可实现具有成本效益且简单的电源解决方案
- 符合 AEC-Q100 标准

应用

- 车身控制模块 (BCM)
- 汽车网关



咨询我们的 E2E 专家

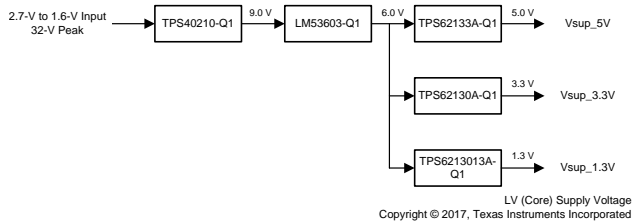

该 TI 参考设计末尾的重要声明表述了授权使用、知识产权问题和其他重要的免责声明和信息。

1 System Description

The MPC5748G Microcontroller (MCU) is used in a wide variety of automotive applications, such as high-end gateway, combined body controller and gateway, central body, vehicle body controllers, smart junction box, and front module applications. These applications require a small, highly-efficient power supply. Compared to a PMIC solution, this power solution is more flexible in terms of load requirements for different end applications. Additionally, it has the advantage of being easily scalable to future generations of the MCU. The MPC5748G device has multiple supply pins for the core, input and output (I/O), flash, and analog supplies. This reference design provides a power solution to supply all of these components in different power configurations of the MCU. The design has three output rails: 1.3 V ($V_{\text{sup}_1.3\text{V}}$), 5 V ($V_{\text{sup}_5\text{V}}$), and 3.3 V ($V_{\text{sup}_3.3\text{V}}$).

- $V_{\text{sup}_1.3\text{V}}$ is used to supply the core logic (V_{DD_LV}).
- $V_{\text{sup}_5\text{V}}$ can be used to supply the I/O pins ($V_{\text{DD}_\text{HV}_\text{A}}$, $V_{\text{DD}_\text{HV}_\text{B}}$, and $V_{\text{DD}_\text{HV}_\text{C}}$) and analog pins ($V_{\text{DD}_\text{HV}_\text{ADC0}}$, $V_{\text{DD}_\text{HV}_\text{ADC1}}$, and $V_{\text{DD}_\text{HV}_\text{ADC1}_\text{REF}}$), which are also called analog-to-digital converter (ADC) pins depending on the power configuration of the MCU.
- $V_{\text{sup}_3.3\text{V}}$ can be used to supply the I/O pins ($V_{\text{DD}_\text{HV}_\text{A}}$, $V_{\text{DD}_\text{HV}_\text{B}}$, and $V_{\text{DD}_\text{HV}_\text{C}}$), the flash ($V_{\text{DD}_\text{HV}_\text{FLA}}$), and analog pins ($V_{\text{DD}_\text{HV}_\text{ADC0}}$, $V_{\text{DD}_\text{HV}_\text{ADC1}}$, $V_{\text{DD}_\text{HV}_\text{ADC1}_\text{REF}}$, and $V_{\text{IN1}_\text{CMP}_\text{REF}}$), depending on the power configuration of the MCU.

For more details on how to choose the power configuration for each pin, see [MPC5748G Data Sheet](#) and [MPC5748G Hardware Design Guidelines](#).

This reference design provides a tested and documented power solution that is suitable for the MPC5748G MCU. The solution achieves high efficiency by using integrated DC/DC converters and no low dropout (LDO) linear regulators. High efficiency results in a low self-temperature rise and higher reliability.

1.1 Key System Specifications

表 1. Key System Specifications

PARAMETERS		SPECIFICATIONS	DETAILS
Input voltage range		2.7-V to 16-V, 32-V peak input voltage	—
OUTPUTS PROVIDED			
V_{sup_5V}	Voltage setpoint	5.0 V	4.1 节
	Ripple	< 25 mV	
	Transient response	< 3%	
	Load regulation	< 1.5%	
$V_{sup_3.3V}$	Voltage setpoint	3.3 V	4.2 节
	Ripple	< 25 mV	
	Transient response	< 3%	
	Load regulation	< 1.5%	
$V_{sup_1.3V}$	Voltage setpoint	1.3 V	4.3 节
	Ripple	< 20 mV	
	Transient response	< 3%	
	Load regulation	< 1 %	

MPC5748G power requirements:

- $V_{DD_HV_ADC0}$: 3.3-V / 5.0-V ADC supply voltage
- $V_{DD_HV_ADC1}$: 3.3-V / 5.0-V ADC supply voltage
- $V_{DD_HV_ADC1_REF}$: 3.3-V / 5.0-V ADC1 high reference voltage
- $V_{DD_HV_A}$: 3.3-V / 5.0-V input/output supply voltage
- $V_{DD_HV_B}$: 3.3-V / 5.0-V input/output supply voltage
- $V_{DD_HV_C}$: 3.3-V / 5.0-V input/output supply voltage
- $V_{DD_HV_FLA}$: 3.3-V flash supply voltage (generated internally)
- V_{DD_LV} : 1.3-V internal core supply voltage

The I/O and HV ADCx supply voltages can be either in the 5-V range or in the 3.3-V range. When operating in the 3.3-V range, the HV flash supply voltage ($V_{DD_HV_FLA}$) must be externally supplied using a 3.3-V source. The 3.3-V flash supply is internally generated when the device operates in the 5-V range. The I/O voltages are all independent supplies that can be set to 3.3 V or 5 V. The core supply voltage (V_{DD_LV}) is set to a fixed voltage of 1.3 V. For more details, see [MPC5748G Data Sheet](#).

2 System Overview

2.1 Block Diagram



图 1. Block Diagram

2.2 Highlighted Products

2.2.1 TPS6213XA-Q1

The [TPS6213XA-Q1](#) devices are easy-to-use, synchronous, step-down DC/DC converters optimized for applications with high power density. A high switching frequency of typically 2.5 MHz allows the use of small inductors and provides fast transient response, as well as high output-voltage accuracy through the use of the DCS-Control™ topology (Direct Control with Seamless Transition into Power Save Mode). With a wide operating input-voltage range of 3 V to 17 V, the devices are ideally suited for systems that draw power from intermediate bus power rails. The devices support up to a 3-A continuous output current at output voltages between 0.9 V and 6 V (with 100% duty cycle mode). The output-voltage start-up ramp is controlled by the soft-start pin, which allows operation as either a standalone power supply or in tracking configurations. Power sequencing is also possible by configuring the enable and open-drain power-good pins. In power save mode, the devices show quiescent current of approximately 17 μ A from V_{IN} . Power save mode, which is entered automatically and seamlessly if the load is small, maintains high efficiency over the entire load range. In shutdown mode, the devices are turned off and shutdown current consumption is less than 2 μ A. The devices are packaged in a 16-pin VQFN package measuring 3 mm x 3 mm.

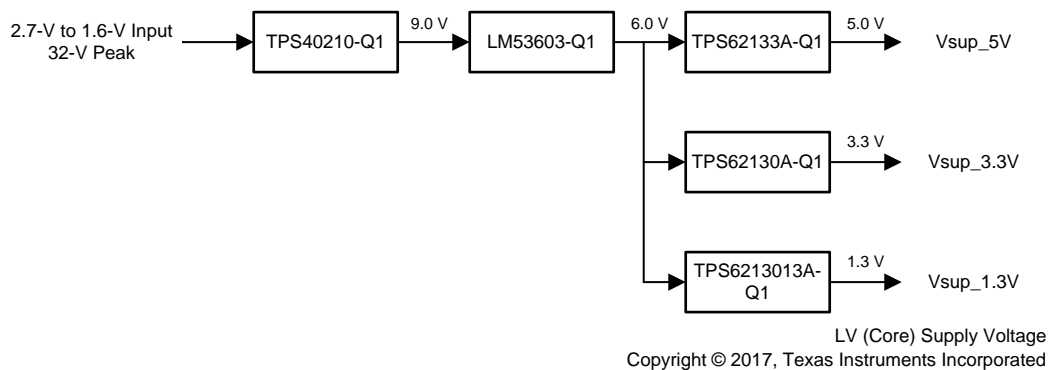
The TPS6213013A-Q1 has a higher precision and provides a precise supply to the core rail of the MCU.

表 2. Device Comparison Table

PART NUMBER	OUTPUT VOLTAGE	PACKAGE MARKING
TPS62130A-Q1	Adjustable	PA6IQ
TPS62133A-Q1	5 V	PA6JQ
TPS6213013A-Q1	1.3 V	13013Q

2.2.2 TPS40210-Q1

The [TPS40210-Q1](#) is a wide-input voltage (4.5 V to 52 V), nonsynchronous boost controller. This controller is suitable for topologies that require a grounded source N-channel field-effect transistor (FET) including boost, flyback, single-ended primary-inductor converter (SEPIC), and various light-emitting-diode (LED) driver applications. The device features include programmable soft-start, overcurrent protection with automatic retry, and programmable oscillator frequency. Current mode control provides improved transient response and simplified loop compensation.

2.2.3 LM53603-Q1

The [LM53603-Q1](#) buck regulator is specifically designed for automotive applications, providing an output voltage of 5 V or 3.3 V (with ADJ option) at 3 A or 2 A, from an input voltage of up to 36 V. Advanced high-speed circuitry allows the device to regulate from an input of up to 20 V, while providing an output of 5 V at a switching frequency of 2.1 MHz. The innovative architecture allows the device to regulate a 3.3-V output from an input voltage of only 3.5 V. All aspects of this product are optimized for the automotive customer. An input voltage range up to 36 V, with transient tolerance up to 42 V, eases input surge protection design. An open-drain reset output, with filtering and delay, provides an accurate indication of system status. This feature negates the requirement for an additional supervisory component, saving cost and board space. Seamless transition between PWM and PFM modes, along with a no-load operating current of only 24 μ A, ensures high efficiency and superior transient response at all loads.

2.3 System Design Theory

The power requirements of the microcontroller are a function of the specific functionality used in a given application. In most cases, the current drawn and the accuracy needed by each rail is not known precisely during the design phase. Only gross estimates are available when the power supply is designed. Therefore the TIDA-01412 reference design uses DC/DC converters to provide flexibility to the designer and scalability for future generations of the microcontroller. Additionally, this design has the advantage of providing high-precision voltage rails compared to the PMIC solution.

This reference design uses five DC/DC converters and provides three output rails to generate appropriate supply voltages for the MCU. Because of the large input range from 2.7 to 16 V, the TPS40210-Q1 was chosen to get a constant voltage of 9 V. The TPS40210-Q1 is capable of a wide input operating voltage range, and is qualified for automotive applications. The voltage is further decreased with a synchronous 2.1-MHz step down converter (LM53603-Q1) to 6 V. The TPS6213x-Q1 step down converters are then used to obtain the suitable I/O and high-voltage (HV) ADC supply voltage of 5 V or 3.3 V and the core supply voltage of 1.3 V. Due to the high switching frequency of the TPS6213x, small inductors can be used and the design can be kept small and efficient. In this design, the TPS6213x-Q1 DC/DC converter provides a precise output regulation; the TPS6213013A-Q1 provides an output load regulation accuracy less than 1% for the low-voltage (LV) core supply.

3 Getting Started Hardware

To test this reference design, apply an input voltage between 2.7 V and 16 V to the J1 input connector. Then, set the enable pins of connector J8 to ON by using a jumper. All DC/DC converters will start working; check the expected output-voltages at the appropriate connectors. J4 should provide a 5-V output, J5 the 3.3-V output, and J6 the 1.3-V output-voltage. To test the design sufficiently, apply certain loads to observe the behavior of the output voltage.

4 Testing and Results

This section includes the relevant test results to power the MPC5748G MCU. Unless otherwise noted, all testing was conducted at room temperature with 14 V for V_{IN} simulating the main supply from the car battery.

Conducted tests:

- Efficiency
- Load regulation
- Load transient
- Output ripple

4.1 V_{sup_5V}

Measurements were performed on the 5-V rail (J4). A load of 300 mA was continuously applied at J6 ($V_{sup_1.3V}$) to measure a real case behavior of the circuit. 表 3 lists the test conditions.

表 3. Test Conditions

VOLTAGE RAIL	OUTPUT VOLTAGE	LOAD
V_{sup_5V}	5 V	—
$V_{sup_3.3V}$	3.3 V	0 mA
$V_{sup_1.3V}$	1.3 V	300 mA



图 2. V_{sup_5V} Efficiency (14 V_{IN} , Measured at J4)



图 3. V_{sup_5V} Load Regulation (14 V_{IN} , Measured at J4)

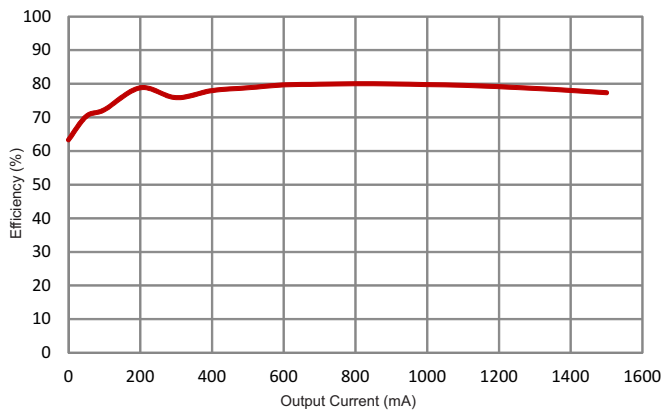

图 4. V_{sup_5V} Transient Response ($14 V_{IN}$, 400-mA to 800-mA Load Step, Measured at J4)

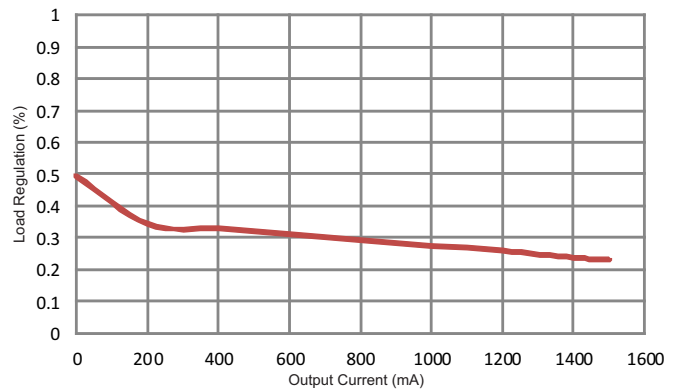

图 5. V_{sup_5V} Ripple ($14 V_{IN}$, 500-mA load at V_{sup_5V} , 300-mA load at $V_{sup_1.3V}$, Measured at J4)

4.2 $V_{sup_3.3V}$

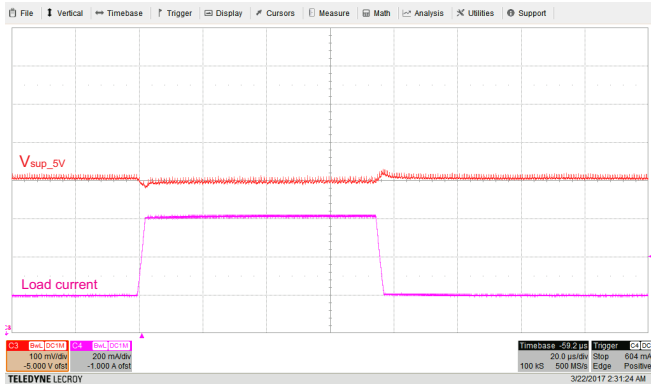
The same measurements were performed on the 3.3-V rail (J5). A load of 300 mA was continuously applied at J6 ($V_{sup_1.3V}$) to measure a real case behavior of the circuit.

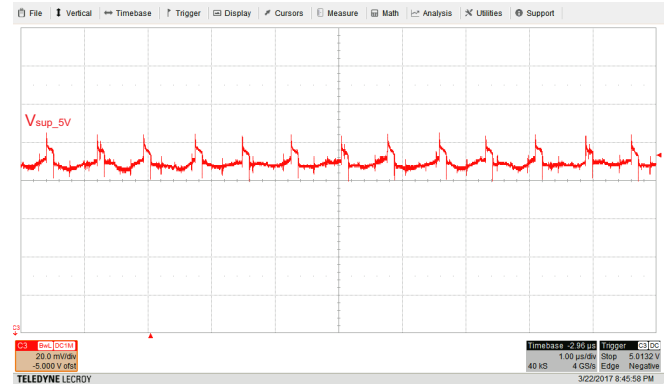

图 6. $V_{sup_3.3V}$ Efficiency ($14 V_{IN}$, Measured at J5)



图 7. $V_{sup_3.3V}$ Load Regulation ($14 V_{IN}$, Measured at J5)

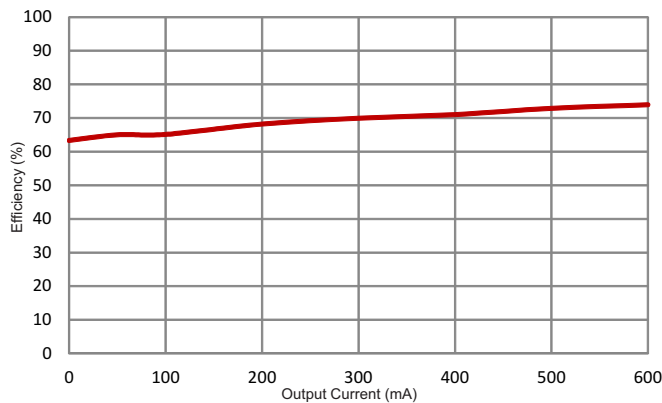

图 8. $V_{sup_3.3V}$ Transient Response ($14 V_{IN}$, 100-mA to 500-mA Load Step, Measured at J5)

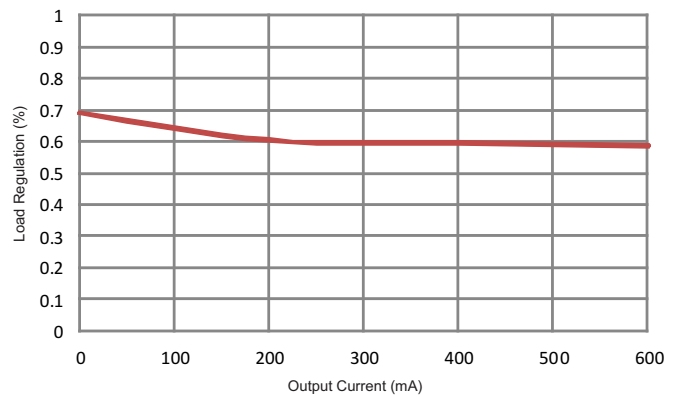

图 9. $V_{sup_3.3V}$ Ripple ($14 V_{IN}$, 500-mA load on $V_{sup_3.3V}$, 300-mA load on $V_{sup_1.3V}$, Measured at J5)

4.3 $V_{sup_1.3V}$

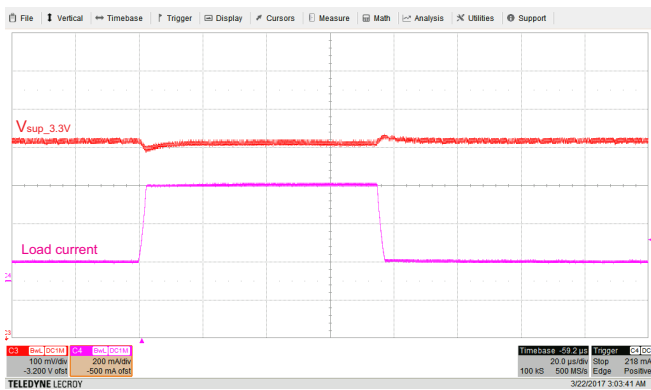
The same measurements were performed for the 1.3-V rail (J6). A load of 500 mA was continuously applied at J5 ($V_{sup_3.3V}$) to measure a real case behavior of the circuit.

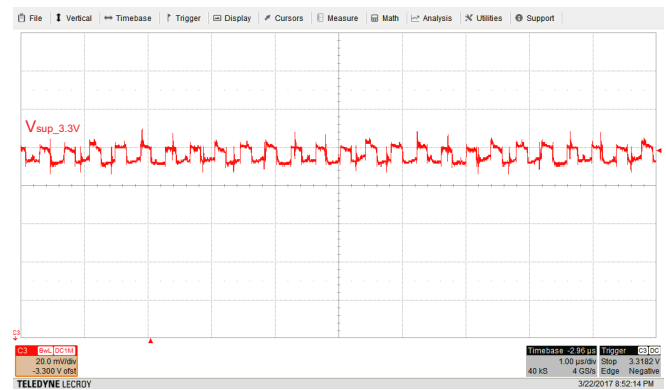

图 10. $V_{sup_1.3V}$ Efficiency (14 V_{IN} , Measured at J6)



图 11. $V_{sup_1.3V}$ Load Regulation (14 V_{IN} , Measured at J6)

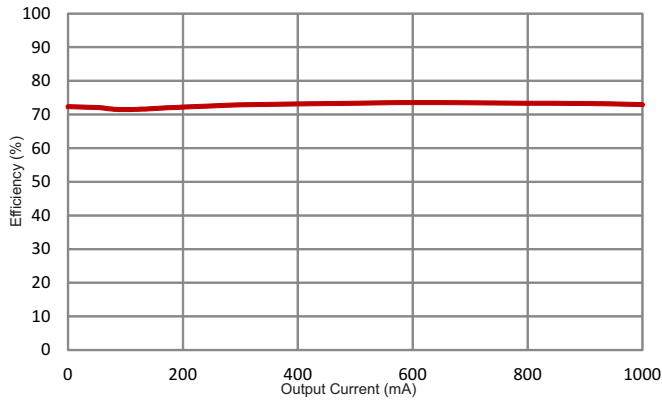

图 12. $V_{sup_1.3V}$ Transient Response (14 V_{IN} , 400- to 800-mA Load Step, Measured at J6)

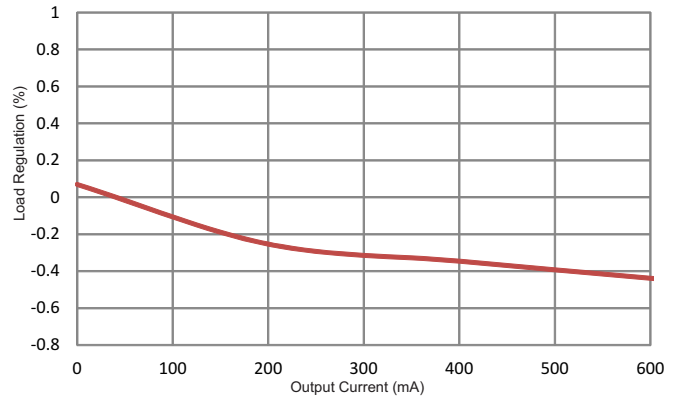

图 13. $V_{sup_1.3V}$ Ripple (14 V_{IN} , 500-mA load on $V_{sup_1.3V}$, 500-mA load on V_{sup_5V} , Measured at J6)

5 Design Files

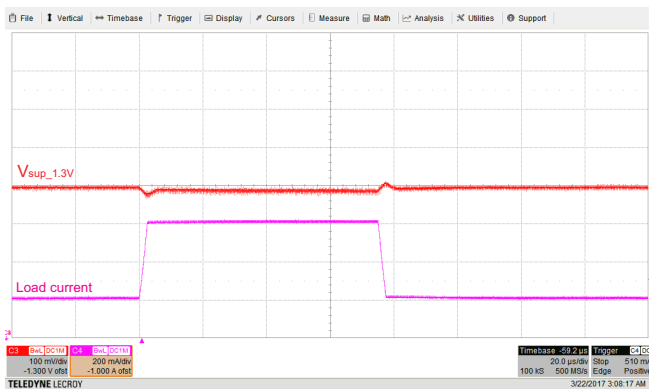
5.1 Schematics

To download the schematics, see the design files at [TIDA-01412](#).

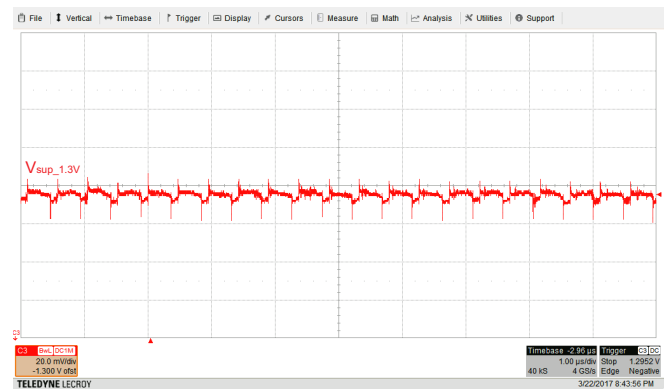
5.2 Bill of Materials

To download the bill of materials (BOM), see the design files at [TIDA-01412](#).

5.3 PCB Layout Recommendations

5.3.1 Layout Prints

To download the layer plots, see the design files at [TIDA-01412](#).

5.4 Gerber Files

To download the Gerber files, see the design files at [TIDA-01412](#).

5.5 Assembly Drawings

To download the assembly drawings, see the design files at [TIDA-01412](#).

6 Related Documentation

1. Texas Instruments, [TPS6213xA-Q1 3-V to 17-V 3-A Step-Down Converter with DCS-Control™](#)
2. Texas Instruments, [TPS4021x-Q1 4.5-V to 52-V Input, Current-Mode Boost Controllers](#)
3. Texas Instruments, [LM53603-Q1 \(3 A\), LM53602-Q1 \(2 A\) 3.5 V to 36 V Wide-V_{IN} Synchronous 2.1 MHz Step- Down Converters for Automotive Applications](#)
4. NXP Semiconductors, [MPC5748G One Pager](#)
5. NXP Semiconductors, [MPC5748G Data Sheet](#)
6. NXP Semiconductors, [MPC5748G Hardware Design Guidelines](#)

6.1 商标

DCS-Control is a trademark of Texas Instruments.
Freescale is a trademark of Freescale Semiconductor, Inc..
All other trademarks are the property of their respective owners.

有关 TI 设计信息和资源的重要通知

德州仪器 (TI) 公司提供的技术、应用或其他设计建议、服务或信息，包括但不限于与评估模块有关的参考设计和材料（总称“TI 资源”），旨在帮助设计人员开发整合了 TI 产品的应用；如果您（个人，或如果是代表贵公司，则为贵公司）以任何方式下载、访问或使用了任何特定的 TI 资源，即表示贵方同意仅为该等目标，按照本通知的条款进行使用。

TI 所提供的 TI 资源，并未扩大或以其他方式修改 TI 对 TI 产品的公开适用的质保及质保免责声明；也未导致 TI 承担任何额外的义务或责任。TI 有权对其 TI 资源进行纠正、增强、改进和其他修改。

您理解并同意，在设计应用时应自行实施独立的分析、评价和判断，且应全权负责并确保应用的安全性，以及您的应用（包括应用中使用的 TI 产品）应符合所有适用的法律法规及其他相关要求。就您的应用声明，您具备制订和实施下列保障措施所需的一切必要专业知识，能够 (1) 预见故障的危险后果，(2) 监视故障及其后果，以及 (3) 降低可能导致危险的故障几率并采取适当措施。您同意，在使用或分发包含 TI 产品的任何应用前，您将彻底测试该等应用和该等应用所用 TI 产品的功能而设计。除特定 TI 资源的公开文档中明确列出的测试外，TI 未进行任何其他测试。

您只有在为开发包含该等 TI 资源所列 TI 产品的应用时，才被授权使用、复制和修改任何相关单项 TI 资源。但并未依据禁止反言原则或其他法律授予您任何 TI 知识产权的任何其他明示或默示的许可，也未授予您 TI 或第三方的任何技术或知识产权的许可，该等许可包括但不限于任何专利权、版权、屏蔽作品权或与使用 TI 产品或服务的任何整合、机器制作、流程相关的其他知识产权。涉及或参考了第三方产品或服务的信息不构成使用此类产品或服务的许可或与其相关的保证或认可。使用 TI 资源可能需要您向第三方获得对该等第三方专利或其他知识产权的许可。

TI 资源系“按原样”提供。TI 兹免除对 TI 资源及其使用作出所有其他明确或默示的保证或陈述，包括但不限于对准确性或完整性、产权保证、无屡发故障保证，以及适销性、适合特定用途和不侵犯任何第三方知识产权的任何默认保证。

TI 不负责任何申索，包括但不限于因组合产品所致或与之有关的申索，也不为您辩护或赔偿，即使该等产品组合已列于 TI 资源或其他地方。对因 TI 资源或其使用引起或与之有关的任何实际的、直接的、特殊的、附带的、间接的、惩罚性的、偶发的、从属或惩戒性损害赔偿，不管 TI 是否获悉可能会产生上述损害赔偿，TI 概不负责。

您同意向 TI 及其代表全额赔偿因您不遵守本通知条款和条件而引起的任何损害、费用、损失和/或责任。

本通知适用于 TI 资源。另有其他条款适用于某些类型的材料、TI 产品和服务的使用和采购。这些条款包括但不限于适用于 TI 的半导体产品 (<http://www.ti.com/sc/docs/stdterms.htm>)、[评估模块](http://www.ti.com/sc/docs/sampters.htm)和样品 (<http://www.ti.com/sc/docs/sampters.htm>) 的标准条款。

邮寄地址：上海市浦东新区世纪大道 1568 号中建大厦 32 楼，邮政编码：200122
Copyright © 2018 德州仪器半导体技术（上海）有限公司