

# LM3203,LM3204,LM3205

??????/????????????????????



Literature Number: ZHCA401

# POWER | *designer*

Expert tips, tricks, and techniques for powerful designs

No. 110

Feature Article.....1-7

Step-Down Switching  
Regulators.....2

150 mA CMOS LDO .....4

RF Detector Family.....6

Power Design Tools.....8

## Optimizing RF Power Amplifier System Efficiency Using DC-DC Converters

— By Mathew Jacob, Applications Engineering Manager

### Old Method

#### Standard PA

- Output power controlled by  $RF_{IN}$
- $V_{CC}$  directly connected to battery

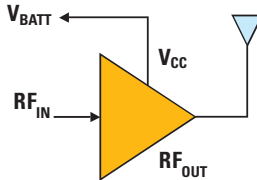

### New Method

#### PA with Supply Regulator

- Output power controlled by  $RF_{IN}$
- $V_{CC}$  connected to DC-DC converter
- $V_{OUT}$  is optimized for given  $P_{OUT}$

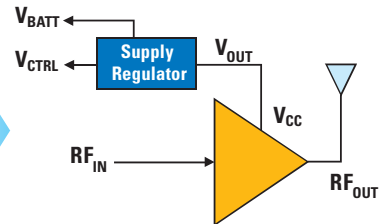

Figure 1. Old Method vs New Method

**RF** power amplifiers used in CDMA / WCDMA cellular standards have been traditionally powered directly from the battery. This makes system implementation easy but the requirement for linear power amplifiers in such standards have intrinsic inefficiencies throughout the transmit power spectrum.

Cellular standards have been evolving with transmission speeds that started from 14.4 kbps in CDMA-1 to 2 Mbps in CDMA2000/WCDMA. Apart from this, cellular providers have increased the services bundled with the 3G phones in order to increase the average revenue per subscriber. At the same time, the talk time and battery life is expected to be improved with the same or slightly higher capacity batteries. This makes system design challenging. System designers have to be very cautious and perform a power survey of each and every component on the phone board. The RF Power Amplifier (RF PA) powered directly from the battery is a major concern from the power budget perspective.

The modulation schemes used in CDMA and WCDMA result in an amplitude-modulated signal that exhibits a non-constant amplitude envelope. In order to preserve signal integrity and further spectral re-growth, a linear

**NEXT ISSUE:**

**Emulated Current Mode Control**

 **National  
Semiconductor**



# Dynamic Power Management of RF Power Amplifiers

## Feature-Rich LM320x Family Enhances Battery Life in Portable Applications

### Family Features

- Dynamically adjustable output voltage optimizes RF PA power levels for increased battery life
- Bypass mode maintains maximum output power regardless of battery voltage
- 2 MHz Switching frequency minimizes external components and complies with spectral emission requirements

Ideal for powering RF power amplifiers in cell phones, smart PDA phones, GPS systems, two-way radios, and portable communications systems

### Family Highlight:

DC-DC converters deliver up to 5X transmit time in RF PAs

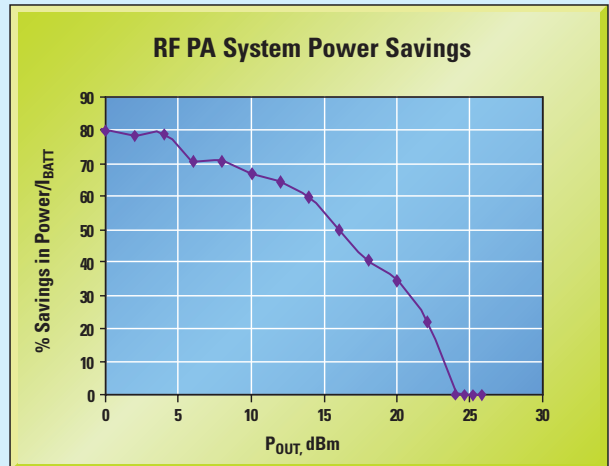
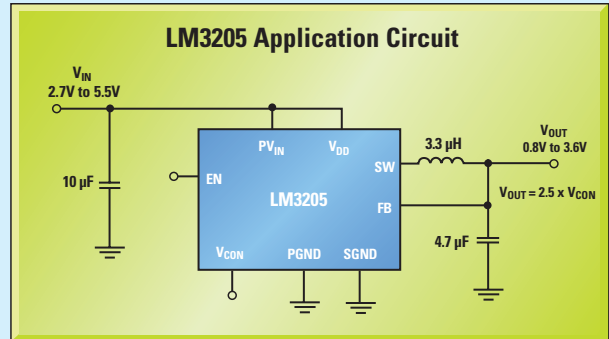

## Step-Down Switching Regulators for RF Power Amplifiers

Product ID	Description	$V_{IN}$		$V_{OUT}$	$I_{OUT}$ (mA)	Bypass Modes	Packaging
		Min	Max				
LM3200	Dynamically adjustable output voltages, 2.2 $\mu H$ inductor	2.7	5.5	Adj (0.8 to 3.6V)	500	Forced and automatic	micro SMD-10
LM3202	Miniature, adjustable, step-down DC-DC converter	2.7	5.5	Adj (1.3 to 3.16)	650	None	micro SMD-8
LM3203	Miniature, adjustable, step-down DC-DC converter	2.7	5.5	Adj (0.8 to 3.6)	500	Forced	micro SMD-10
LM3204	Miniature, adjustable, step-down DC-DC converter	2.7	5.5	Adj (0.8 to 3.6)	355/500	Forced and automatic	micro SMD-10
LM3205	Miniature, adjustable, step-down DC-DC converter	2.7	5.5	Adj (0.8 to 3.6)	650	None	micro SMD-8

## Optimizing RF Power Amplifier System Efficiency

power amplifier is necessary. However, power efficiency is traded off because power amplifiers operate efficiently when operated in gain compression. To meet the required linearity, the operating transmit power is backed off from the power amplifier's compression point that causes an overall reduction in efficiency. When the handset is operating in transmit mode, the RF power section consumes up to 65% of the overall power budget as a result of the PA's intrinsic inefficiencies.

For this reason, linear PAs are ideal candidates to be powered with a magnetic buck converter which will dramatically increase efficiency of the system.

Power-Added Efficiency (PAE) is a key performance metric of a power amplifier.

$$PAE (\%) = (P_{OUT} - P_{IN}) / P_{dc}$$

The key in using a DC-DC converter (PA supply regulator) is to reduce the Pdc factor in the denominator. When the PA is connected directly to the battery,  $P_{dc} = V_{batt} \cdot I_{batt}$  and, when it is powered by a PA supply regulator,  $P_{dc} = V_o \cdot I_o$ . Now it can be seen that for increasing the PAE we have to have a low  $V_o$  and  $I_o$  compared to  $V_{batt}$  and  $I_{batt}$ . This is achieved by lowering the output voltage of the PA supply regulator at lower transmitted RF power levels. This in turn reduces  $I_o$  (current drawn by the PA) and results in a much lower input current drawn from the battery due to the inherent high efficiency of the DC-DC converter.

It is important to consider the power probability

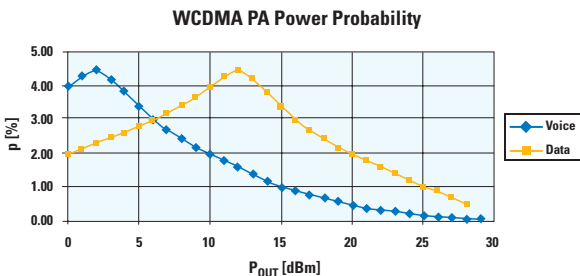

**Figure 2. PA transmits low power levels for a high percentage of time in a typical cellular phone which reinforces the savings possible with a PA supply regulator**

profile (see *Figure 2*) for the modulation methods to really understand the impact of savings in powering a PA with a supply regulator. The profiles are different for urban and rural regions.

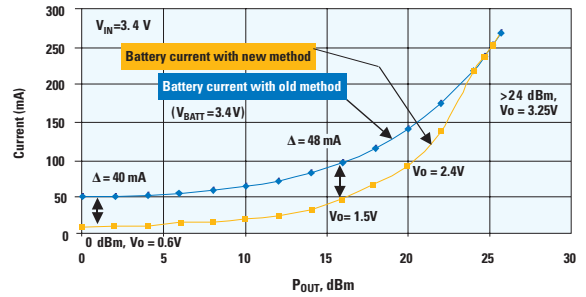

**Figure 3. Savings in battery current when the DC-DC converter is used for powering the PA**

As shown in *Figure 3*, the output voltage of the DC-DC converter has to be varied as the transmitted power levels are changed to maintain the Adjacent Channel Power/leakage Ratio (ACPR) specifications. The savings in battery current can be as high as 50 mA in the 0 dBm to 20 dBm power levels. *Figure 2* shows that the PA is operating in this band of power levels for a majority of its time.

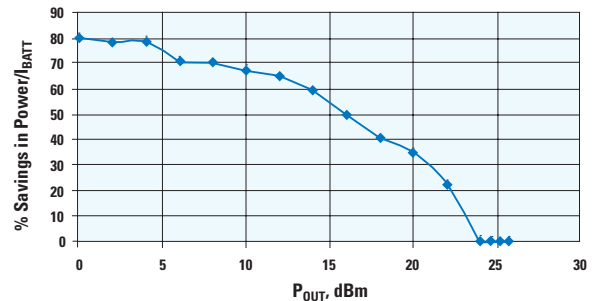

**Figure 4. Percentage savings in power when the PA is powered by a PA supply regulator**

So why do we have to change the voltage of the DC-DC converter as the transmitted power level is increased? The answer is that this change is needed to maintain the ACPR ratios. ACPR is used to characterize the distortion of power amplifiers and other subsystems for their tendency to cause interference with neighboring radio channels or

# Industry's Lowest Noise 150 mA CMOS LDO

## LP5900 Low Dropout Regulator Requires No Bypass Capacitor

### Features

- Industry's lowest noise combined with 85 dB of Power Supply Ripple Rejection guarantees signal integrity
- 25  $\mu\text{A}$   $I_Q$  minimizes current drain when system operates in low-power mode
- Elimination of bypass capacitor reduces BOM to only two ceramic 0.47  $\mu\text{F}$  capacitors
- Low 80 mV dropout voltage (typ.)
- Virtually zero ( $<1\mu\text{A}$ )  $I_q$  when disabled
- Available in a micro SMD-4 package
- LLP® packaging available soon

AVAILABLE  
LEAD-FREE

Ideal for powering analog and RF signal path ICs, including low-noise amplifiers, voltage controlled oscillators, and RF receivers

### Product Highlight:

Unique 150 mA RF LDO eliminates bypass capacitor and achieves low 6.5  $\mu\text{V}_{\text{RMS}}$  noise

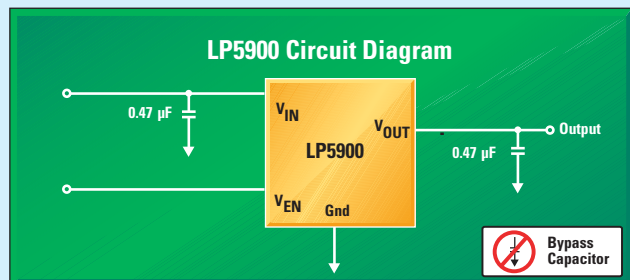
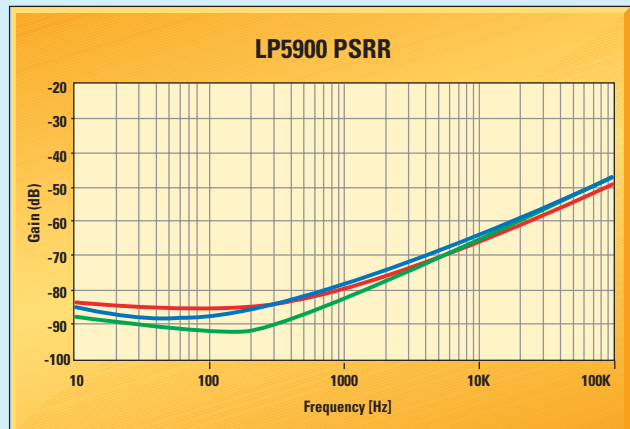
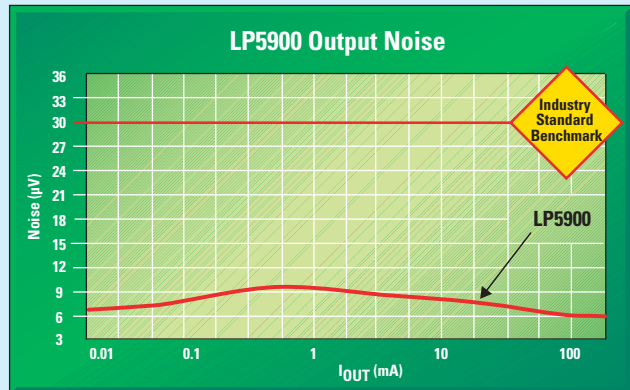

## Optimizing RF Power Amplifier System Efficiency

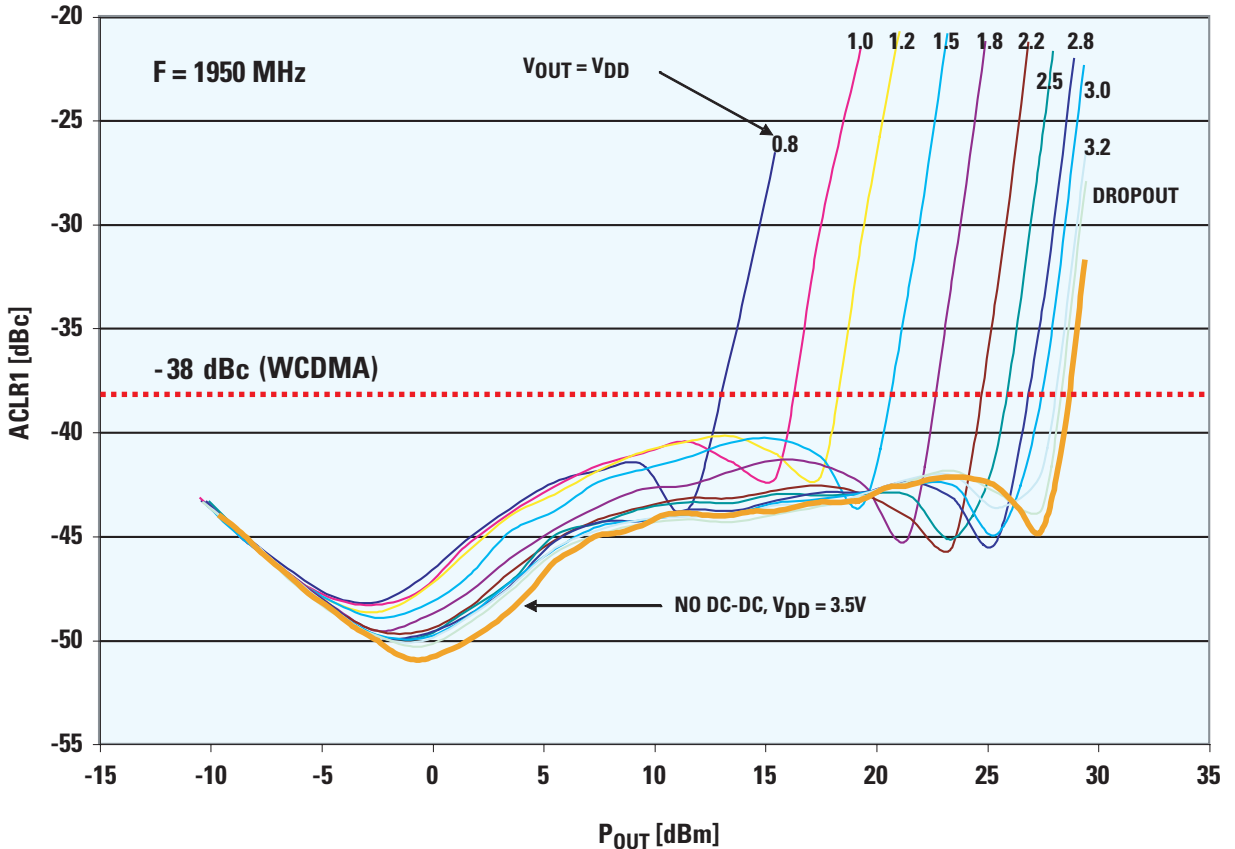

Figure 5. How ACLR is affected with respect to supply voltage to the PA and P<sub>OUT</sub>

systems. It is specified as the ratio of the Power-Spectral Density (PSD) of the main channel to the PSD measured at several offset frequencies.

In *Figure 5* it can be seen that if the supply voltage to the PA is not increased as P<sub>OUT</sub> is increased, the ACLR specifications cannot be met.

The system-level specification (3 GPP) for WCDMA is -34 dBc and, in order to preserve sufficient margin caused by temperature and device variances, the ACLR value of -38 dBc is used.

### Key Requirements of Buck Converters for Powering RF Power Amplifiers

Buck converters that power RF PAs have specialized functions and are quite different from buck converters that power digital core processors. These differences arise in operating characteristics and parameters

such as switching FET ON-resistances, current limit, transient response, modes of operation such as PFM/PWM, startup time, quiescent current, and dropout behavior. The following examples illustrate these differences:

- High efficiency over wide output voltage and load range

*Example:* LM3205 has efficiency of 96% at V<sub>IN</sub> = 4.2V, V<sub>O</sub> = 3.4V, I<sub>O</sub> = 400 mA (high RF power) and 87% at V<sub>IN</sub>=3.9V, V<sub>O</sub>=1.5V, I<sub>O</sub> = 100 mA (low RF power).

- Dynamic output voltage adjustment

*Example:* In LM3205 the output voltage can be adjusted between 0.8V to 3.6V using a Vcon pin. The voltage gain from Vcon to V<sub>O</sub> is 2.5.

# Simplify System Calibration with RF Detector Family

## Accurate and Stable RF Power Detectors for Portable Devices

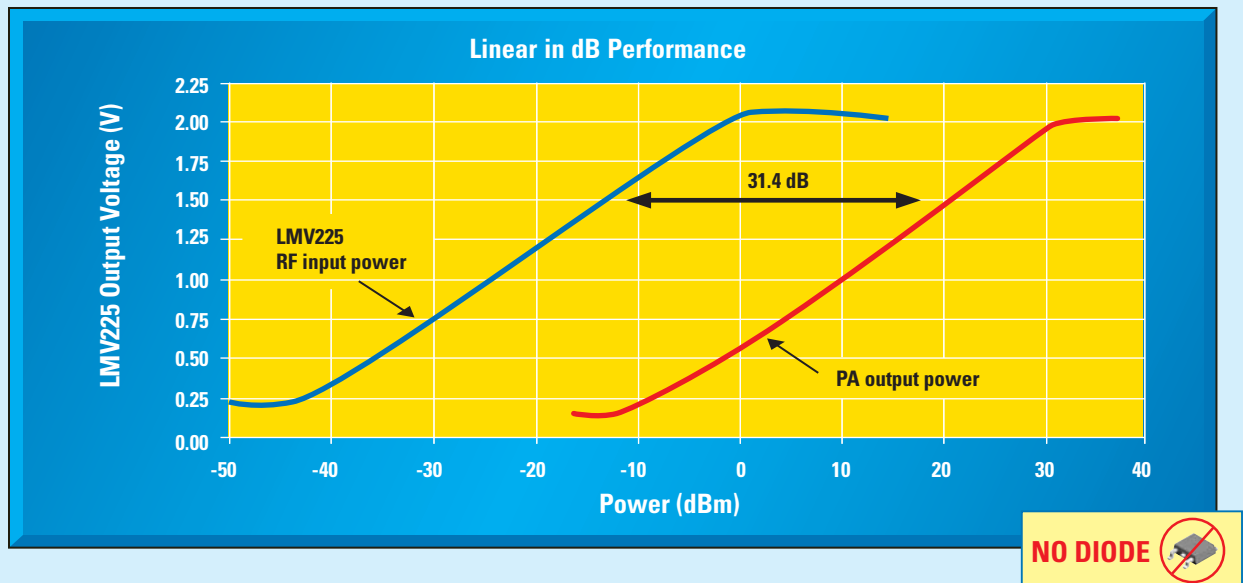

### Family Features

- LMV227 100% RF tested for accuracy
- 30 dB Linear-in-dB power detection range
- Multi-band operation from 450 MHz to 2 GHz
- Accurate temperature compensation
- Logarithmic amplifier and mean square RF detector technology

Ideal for use in handsets, wireless LAN, WiFi, PC and PDA module cards, and GPS navigation modules

### Family Highlight:

Real-time transmitter power adjustments simplify system calibration in communications systems

AVAILABLE  
LEAD-FREE

Product ID	Application	Detector	Channel	Range	Package
LMV227	CDMA 2000, WCDMA, UMTS	Log amp	1	40 dB, 2.1 GHz	Micro SMD, LLP®
LMV225/226/228	CDMA, WCDMA, UMTS	Log amp	1	40 dB, 2.1 GHz	Micro SMD, LLP
LMV232	3G Mobile communications	Mean square	2	20 dB, 2.2 GHz	Micro SMD

## Optimizing RF Power Amplifier System Efficiency

- 30  $\mu\text{s}$  Output slew rate and settling (50  $\mu\text{s}$  window in beginning of every 667  $\mu\text{s}$  transmit cycle in which the Vcon adjustments must be completed)  
In WCDMA architecture, transmit power is adjusted by  $\pm 1$  dB in every 667  $\mu\text{s}$  as requested by the basestation.
- Low dropout and low ripple near 100% duty cycle  
*Example:* Low  $R_{\text{DS(ON)}}$  PFET 140 m $\Omega$  (LM3205) or Bypass FET (LM3204) gives low dropout voltage and pulse-skipping schemes gives low ripple near 100% duty cycle.
- Low duty cycle operation for low output voltages  
*Example:* Minimum on time, 50 ns facilitates 10% duty cycle operation for output voltages of 0.8V and lower depending on the  $V_{\text{IN}}$  range.
- High switching frequency  
*Example:* 2 MHz switching frequency helps the use of smaller sized external components and meet spectral emission requirements.
- Fast turn on time to meet time mask for transmit ON/OFF  
*Example:* LM3203 has turn-on time of 50  $\mu\text{s}$  for  $V_{\text{O}} = 3.4\text{V}$  from EN = low to high.

### 100% Duty Cycle vs Bypass Mode

When the buck converter is operating at 100% duty cycle the dropout voltage is

$$\text{Dropout Voltage} = (R_{\text{ON,P}} + R_{\text{L}}) \cdot I_{\text{o}}$$

where  $R_{\text{ON,P}}$  is the  $R_{\text{DS(ON)}}$  of the PFET and  $R_{\text{L}}$  is the inductor DCR. For a PA supply regulator that has a bypass FET the dropout voltage in bypass mode is,

$$\text{Dropout Voltage} = (R_{\text{ON,BYP}}) \cdot I_{\text{o}}$$

where  $R_{\text{ON,BYP}}$  is the  $R_{\text{DS(ON)}}$  of the bypass FET. The bypass FET can be turned on automatically or manually. As shown, the key advantage in having a bypass mode is lower dropout voltages; which translates to longer talk times and lowering the low battery shutdown point for the phone. The alternative is to use low DCR inductors and a low  $R_{\text{DS(ON)}}$  PFET.

### Example Application Circuits

In this example, the baseband will have a lookup table scheme where it sets the output voltage depending on the output power levels required.

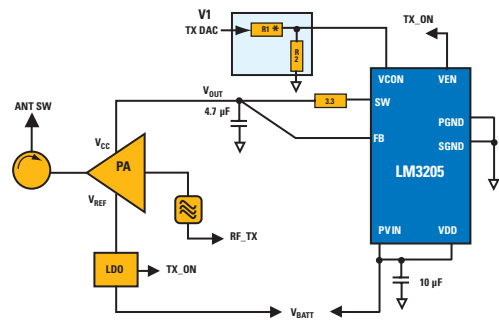

\*R1, R2 only required if V1 to  $V_{\text{OUT}}$  gain needs to be modified

Figure 6. Baseband Controls Vo Directly

In this case, the power detector is part of a closed loop and sets the output voltage.

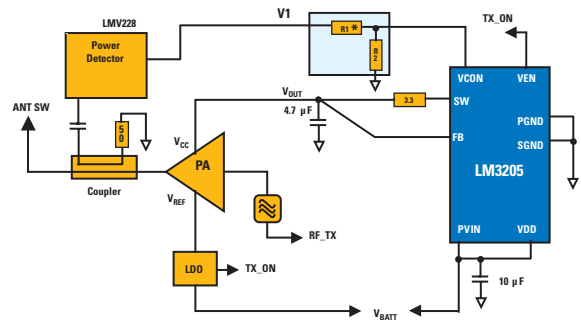

\*R1, R2 only required if V1 to  $V_{\text{OUT}}$  gain needs to be modified

Figure 7. Using a Power Detector to Set Vo

### Conclusion

DC-DC converters enhance the RF PA system efficiency in portable communication devices and support the addition of more features or functions by improving battery life. ■

For more information on Powering RF Power Amplifiers, visit [www.national.com/online seminars](http://www.national.com/online seminars) to watch Mathew Jacobs' online seminar!



# Power Design Tools

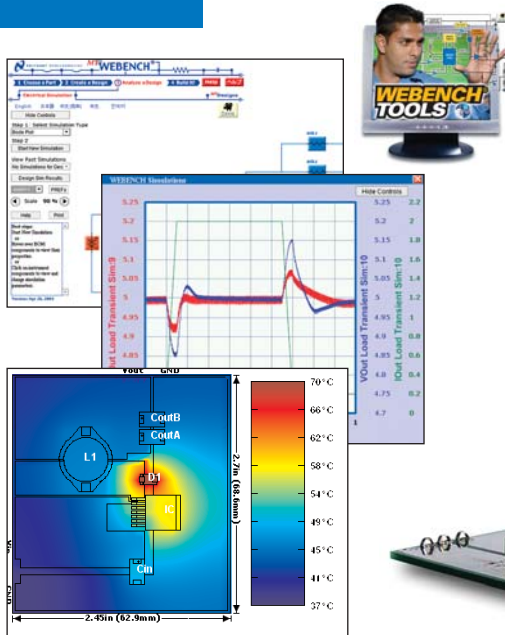

## WEBENCH® Online Design Environment

Our design and prototyping environment simplifies and expedites the entire design process.

1. Choose a part
2. Create a design
3. Analyze a power supply design
  - Perform electrical simulation
  - Simulate thermal behavior
4. Build it
  - Receive your custom prototype kit 24 hours later

[webench.national.com](http://webench.national.com)

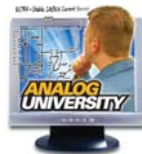
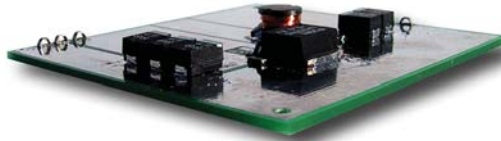

## Analog University®

Expand your knowledge and understanding of analog with our free online educational training tool.

[analogU.national.com](http://analogU.national.com)

### National Semiconductor

2900 Semiconductor Drive  
PO Box 58090  
Santa Clara, CA 95052  
1 800 272 9959

Visit our website at:  
[power.national.com](http://power.national.com)

For more information,  
send email to:  
[new.feedback@nsc.com](mailto:new.feedback@nsc.com)

*Don't miss a single issue!*

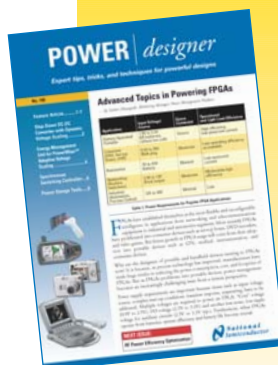

Subscribe now to receive email alerts when new issues of Power Designer are available:

[power.national.com/designer](http://power.national.com/designer)

Introducing our new Signal Path Designer<sup>SM</sup>! View online today at:

[signalpath.national.com/designer](http://signalpath.national.com/designer)

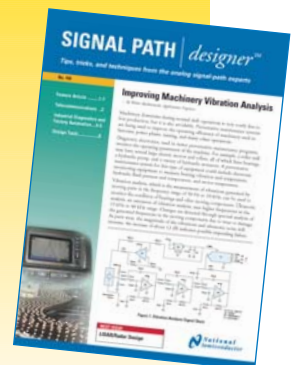

## 重要声明

德州仪器(TI) 及其下属子公司有权在不事先通知的情况下, 随时对所提供的产品和服务进行更正、修改、增强、改进或其它更改, 并有权随时中止提供任何产品和服务。客户在下订单前应获取最新的相关信息, 并验证这些信息是否完整且是最新的。所有产品的销售都遵循在订单确认时所提供的TI 销售条款与条件。

TI 保证其所销售的硬件产品的性能符合TI 标准保修的适用规范。仅在TI 保证的范围内, 且TI 认为有必要时才会使用测试或其它质量控制技术。除非政府做出了硬性规定, 否则没有必要对每种产品的所有参数进行测试。

TI 对应用帮助或客户产品设计不承担任何义务。客户应对其使用TI 组件的产品和应用自行负责。为尽量减小与客户产品和应用相关的风险, 客户应提供充分的设计与操作安全措施。

TI 不对任何TI 专利权、版权、屏蔽作品权或其它与使用了TI 产品或服务的组合设备、机器、流程相关的TI 知识产权中授予的直接或隐含权限作出任何保证或解释。TI 所发布的与第三方产品或服务有关的信息, 不能构成从TI 获得使用这些产品或服务的许可、授权、或认可。使用此类信息可能需要获得第三方的专利权或其它知识产权方面的许可, 或是TI 的专利权或其它知识产权方面的许可。

对于TI 的产品手册或数据表, 仅在没有对内容进行任何篡改且带有相关授权、条件、限制和声明的情况下才允许进行复制。在复制信息的过程中对内容的篡改属于非法的、欺诈性商业行为。TI 对此类篡改过的文件不承担任何责任。

在转售TI 产品或服务时, 如果存在对产品或服务参数的虚假陈述, 则会失去相关TI 产品或服务的明示或暗示授权, 且这是非法的、欺诈性商业行为。TI 对此类虚假陈述不承担任何责任。

TI 产品未获得用于关键的安全应用中的授权, 例如生命支持应用(在该类应用中一旦TI 产品故障将预计造成重大的人员伤亡), 除非各方官员已经达成了专门管控此类使用的协议。购买者的购买行为即表示, 他们具备有关其应用安全以及规章衍生所需的所有专业技术和知识, 并且认可和同意, 尽管任何应用相关信息或支持仍可能由TI 提供, 但他们将独力负责满足在关键安全应用中使用其产品及TI 产品所需的所有法律、法规和安全相关要求。此外, 购买者必须全额赔偿因在此类关键安全应用中使用TI 产品而对TI 及其代表造成的损失。

TI 产品并非设计或专门用于军事/航空应用, 以及环境方面的产品, 除非TI 特别注明该产品属于“军用”或“增强型塑料”产品。只有TI 指定的军用产品才满足军用规格。购买者认可并同意, 对TI 未指定军用的产品进行军事方面的应用, 风险由购买者单独承担, 并且独力负责在此类相关使用中满足所有法律和法规要求。

TI 产品并非设计或专门用于汽车应用以及环境方面的产品, 除非TI 特别注明该产品符合ISO/TS 16949 要求。购买者认可并同意, 如果他们在汽车应用中使用任何未被指定的产品, TI 对未能满足应用所需要求不承担任何责任。

可访问以下URL 地址以获取有关其它TI 产品和应用解决方案的信息:

	产品		应用
数字音频	<a href="http://www.ti.com.cn/audio">www.ti.com.cn/audio</a>	通信与电信	<a href="http://www.ti.com.cn/telecom">www.ti.com.cn/telecom</a>
放大器和线性器件	<a href="http://www.ti.com.cn/amplifiers">www.ti.com.cn/amplifiers</a>	计算机及周边	<a href="http://www.ti.com.cn/computer">www.ti.com.cn/computer</a>
数据转换器	<a href="http://www.ti.com.cn/dataconverters">www.ti.com.cn/dataconverters</a>	消费电子	<a href="http://www.ti.com/consumer-apps">www.ti.com/consumer-apps</a>
DLP® 产品	<a href="http://www.dlp.com">www.dlp.com</a>	能源	<a href="http://www.ti.com/energy">www.ti.com/energy</a>
DSP - 数字信号处理器	<a href="http://www.ti.com.cn/dsp">www.ti.com.cn/dsp</a>	工业应用	<a href="http://www.ti.com.cn/industrial">www.ti.com.cn/industrial</a>
时钟和计时器	<a href="http://www.ti.com.cn/clockandtimers">www.ti.com.cn/clockandtimers</a>	医疗电子	<a href="http://www.ti.com.cn/medical">www.ti.com.cn/medical</a>
接口	<a href="http://www.ti.com.cn/interface">www.ti.com.cn/interface</a>	安防应用	<a href="http://www.ti.com.cn/security">www.ti.com.cn/security</a>
逻辑	<a href="http://www.ti.com.cn/logic">www.ti.com.cn/logic</a>	汽车电子	<a href="http://www.ti.com.cn/automotive">www.ti.com.cn/automotive</a>
电源管理	<a href="http://www.ti.com.cn/power">www.ti.com.cn/power</a>	视频和影像	<a href="http://www.ti.com.cn/video">www.ti.com.cn/video</a>
微控制器 (MCU)	<a href="http://www.ti.com.cn/microcontrollers">www.ti.com.cn/microcontrollers</a>		
RFID 系统	<a href="http://www.ti.com.cn/rfidsys">www.ti.com.cn/rfidsys</a>		
OMAP 机动性处理器	<a href="http://www.ti.com/omap">www.ti.com/omap</a>		
无线连通性	<a href="http://www.ti.com.cn/wirelessconnectivity">www.ti.com.cn/wirelessconnectivity</a>		
	德州仪器在线技术支持社区		<a href="http://www.deyisupport.com">www.deyisupport.com</a>

邮寄地址: 上海市浦东新区世纪大道 1568 号, 中建大厦 32 楼 邮政编码: 200122  
Copyright © 2011 德州仪器 半导体技术(上海)有限公司