

TPS25740EVM-741 and TPS25740AEVM-741 Evaluation Module User Guide

This user's guide describes the TPS25740 and TPS25740A evaluation module (TPS25740EVM-741 and TPS25740AEVM-741). The TPS25740EVM-741 and TPS25740AEVM-741 contain evaluation and reference circuitry for the TPS25740 and TPS25740A, which are dedicated USB Type-C™ Power Delivery (PD) downstream facing port (DFP) controllers. The TPS25740 and TPS25740A rely on an upstream converter to output 5 V, 12 V, and 20 V (TPS25740) or 5 V, 9 V, and 15 V (TPS25740A). These EVMs use an LM5175-based buck boost converter as the power supply for TPS25740 and TPS25740A. The TPS25740 and TPS25740A portion of the circuit will be very similar in an adapter application where an AC/DC input power stage is used. Note that this EVM does not support BC1.2 charging. A TPS2514A can be added to DP and DM lines of the type C connector for BC1.2 charging support. In addition this EVM features a barrel jack input to allow for easy demonstration. The recommended adapter is listed in the features section.

Contents

1	Introduction	3
2	Description	4
3	Schematic	5
4	Configuring the EVM	7
5	Operation	9
6	Test Results	9
7	EVM Assembly Drawings and Layout Guidelines.....	15
8	Component Placement and Routing Guidelines	18
9	Bill of Materials	19

List of Figures

1	Block Diagram.....	3
2	LM5175 Buck-Boost Power Supply	5
3	TPS25740 DFP	6
4	Power Select Header – J7	8
5	Voltage and Current Select Header – J8	8
6	UFP Plug-In (5 V).....	9
7	UFP Unplug (5 V).....	9
8	UFP Unplug (12 V)	9
9	UFP Unplug (20 V)	9
10	5-V to 12-V Transition.....	9
11	5-V to 20-V Transition.....	9
12	12-V to 20-V Transition.....	10
13	12-V to 5-V Transition	10
14	20-V to 5-V Transition	10
15	20-V to 12-V Transition.....	10
16	Start Into Short on Output.....	10
17	Start Into Short on Output (Extra 1000 μ F Between DCDC_out and GND).....	10
18	Load Step From 0 A to 3 A (12 V)	11

USB Type-C is a trademark of USB Implementers Forum, Inc.

19	Load Step From 0 A to 3 A (20 V)	11
20	Load Step From 0 A to 3 A (5 V).....	11
21	Raise V_{IN} With UFP Already Plugged In.....	11
22	5-V Hot Short on UFP Side	11
23	12-V Hot Short on UFP Side	11
24	20-V Hot Short on UFP Side	12
25	Overvoltage at 5-V Contract (With External Supply)	12
26	Overvoltage at 12-V Contract (With External Supply).....	12
27	Overvoltage at 20-V Contract (With External Supply).....	12
28	Remove Input Power	12
29	Unplug Then Replug in Quickly	12
30	5.5-A Load Step Triggers OCP (5 V)	13
31	5.5-A Load Step Triggers OCP (12 V)	13
32	5.5-A Load Step Triggers OCP (20 V)	13
33	Plug In to MacBook (5-V, 12-V, 20-V Advertised)	13
34	Plug In to MacBook (5-V and 12-V Advertised)	13
35	Unplug MacBook (5-V, 12-V, 20-V Advertised)	13
36	Unplug MacBook (5-V and 12-V Advertised)	14
37	Power Cycle MacBook Plugged In (5-V, 12-V, 20-V Advertised)	14
38	Power Cycle With MacBook (5-V and 12-V Advertised)	14
39	Top Side Placement	15
40	Top Side Routing.....	16
41	Layer Two Routing	16
42	Layer Three Routing	17
43	Bottom Side Routing.....	17

List of Tables

1	TPS25740 and TPS25740A EVM Electrical and Performance Specifications at 25°C	3
2	Connector and LED Functionality	7
3	Jumpers Functionality	7
4	Test Points.....	8
5	TPS25740EVM-741 Bill of Materials	19

1 Introduction

The TPS25740EVM-741 and TPS25740AEVM-741 allows the user to evaluate performance of the TPS25740 and TPS25740A in an adapter-like application. Note that the TPS25740 and TPS25740A are powered from the output of the DC/DC converter and do not require an external LDO. The upstream converter remains ON at all times to ensure that the TPS25740 and TPS25740A remain powered and can detect the UFP connection.

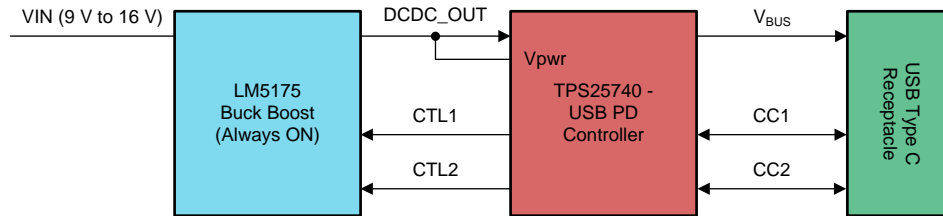

Figure 1. Block Diagram

1.1 Features

The TPS25740x features include:

- Type C PD communication protocol via CC1 and CC2 pins.
- Variable output voltage depending on request.
 - 5 V, 12 V, and 20 V for TPS25740EVM-741
 - 5 V, 9 V, and 15 V for TPS25740AEVM-741
- Up to 5-A output current for all voltage levels. Default is 3 A.
- Smooth voltage transitions per USB PD specification.
- Barrel jack input. (The [ETSA190342UDC-P5P-SZ adapter](#) has been tested with the EVM.)

1.2 Applications

The TPS25740x can be used in the following applications:

- Automotive USB ports
- Power banks
- USB power delivery adaptors

1.3 Electrical Specifications

[Table 1](#) lists the EVM electrical specifications.

Table 1. TPS25740 and TPS25740A EVM Electrical and Performance Specifications at 25°C

Characteristic	TPS25740EVM-741	TPS25740AEVM-741
Input voltage range (Recommended)	9 V to 16 V	9 V to 16 V
Input voltage range (Absolute Maximum)	0 V to 40 V	0 V to 40 V
Operating output current	Default: 3 A	Default: 3 A
	Configurable to 5 A	Configurable to 5 A
Overcurrent protection	Default: 4.2 A	Default: 4.2 A
	Configurable to 6.3 A	Configurable to 6.3 A
Output voltages	5 V, 12 V, 20 V	5 V, 9 V, 15 V
UVLO rising on input	7.75 V	7.75 V
UVLO falling on input	7.25 V	7.25 V
Advertised voltages	5 V, 12 V, 20 V	5 V, 9 V, 15 V
Advertised current	3 A (default)	3 A (default)

2 Description

Referring to the schematic in [Figure 2](#) and [Figure 3](#), a 12-V DC input is applied at the J1/J3 terminals or J4 connector. The voltage at the DCDC_OUT node is regulated by the LM5175PWP buck-boost regulator (U1) and associated circuitry. This provides a nominal 5-V, 5-A output for the TPS25740/TPS25740A (U2) and associated output load.

A type C upstream facing port (UFP) is plugged in at J9. When TPS25740/TPS25740A detects the UFP via CC1 or CC2 then it will activate Q6/Q10 with the GDNG signal. This will apply the default VBUS voltage of 5 V at J9 to the UFP. A USB PD capable device can now request the power delivery capabilities from the TPS25740/TPS25740A which are programmed by J7 and J8. Once the UFP knows the voltage capabilities of the DFP then it can now request a different VBUS voltage.

The voltage change request gets processed by the TPS25740/TPS25740A and is relayed to the LM5175 regulator through the CTL1 and CTL2 pins. R21 and R24 program the default 5-V output at DCDC_OUT. R22 and R19 are switched in by CTL1 and CTL2 respectively and are placed in parallel with R24 to change the feedback voltage regulation point. Capacitors C31 and C32 provide slew rate control in order to comply with the USB PD specification.

For more information and detailed design information, refer to the TPS25740/TPS25740A datasheet, ([SLVSDG8](#)).

3 Schematic

Figure 2 and Figure 3 illustrate the EVM schematic.

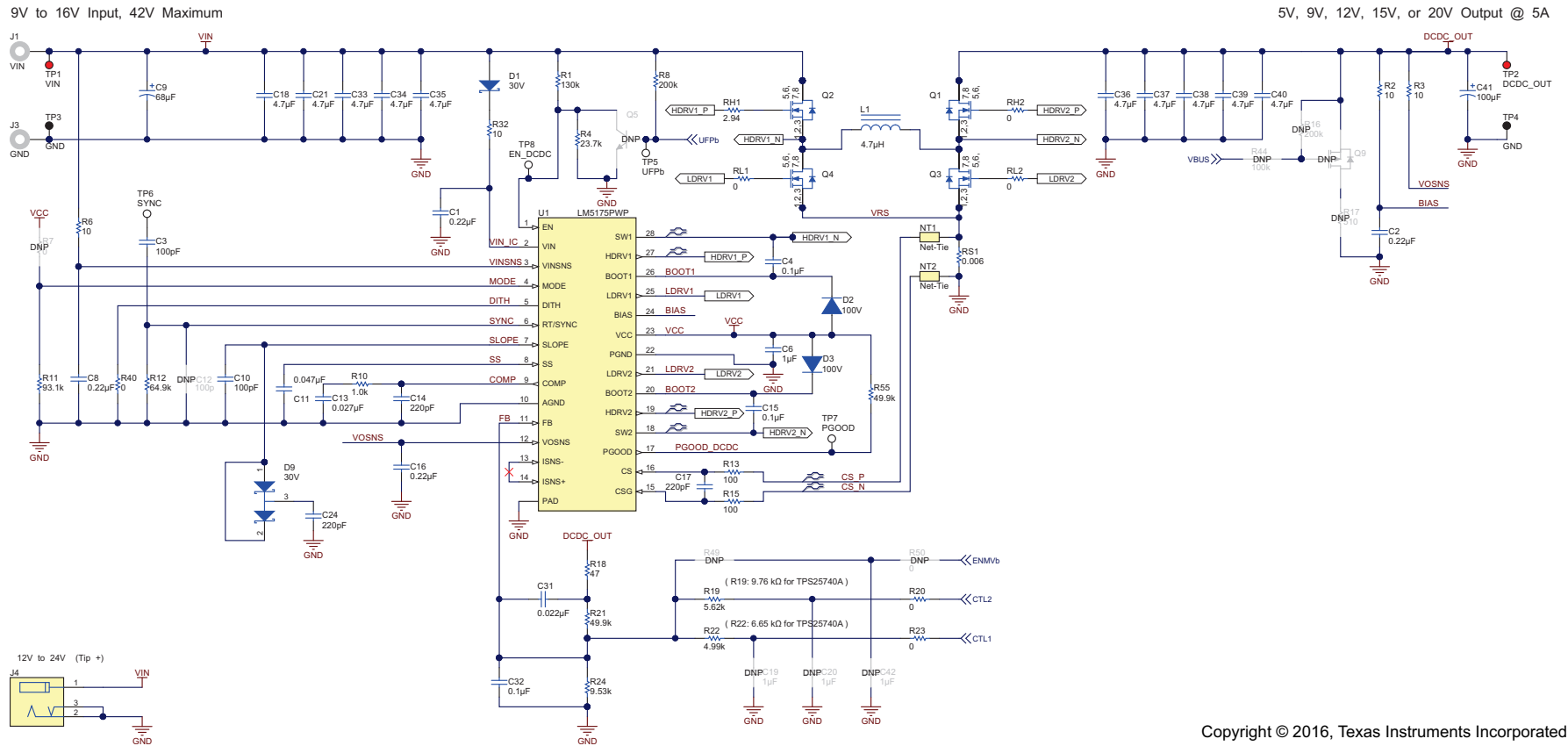
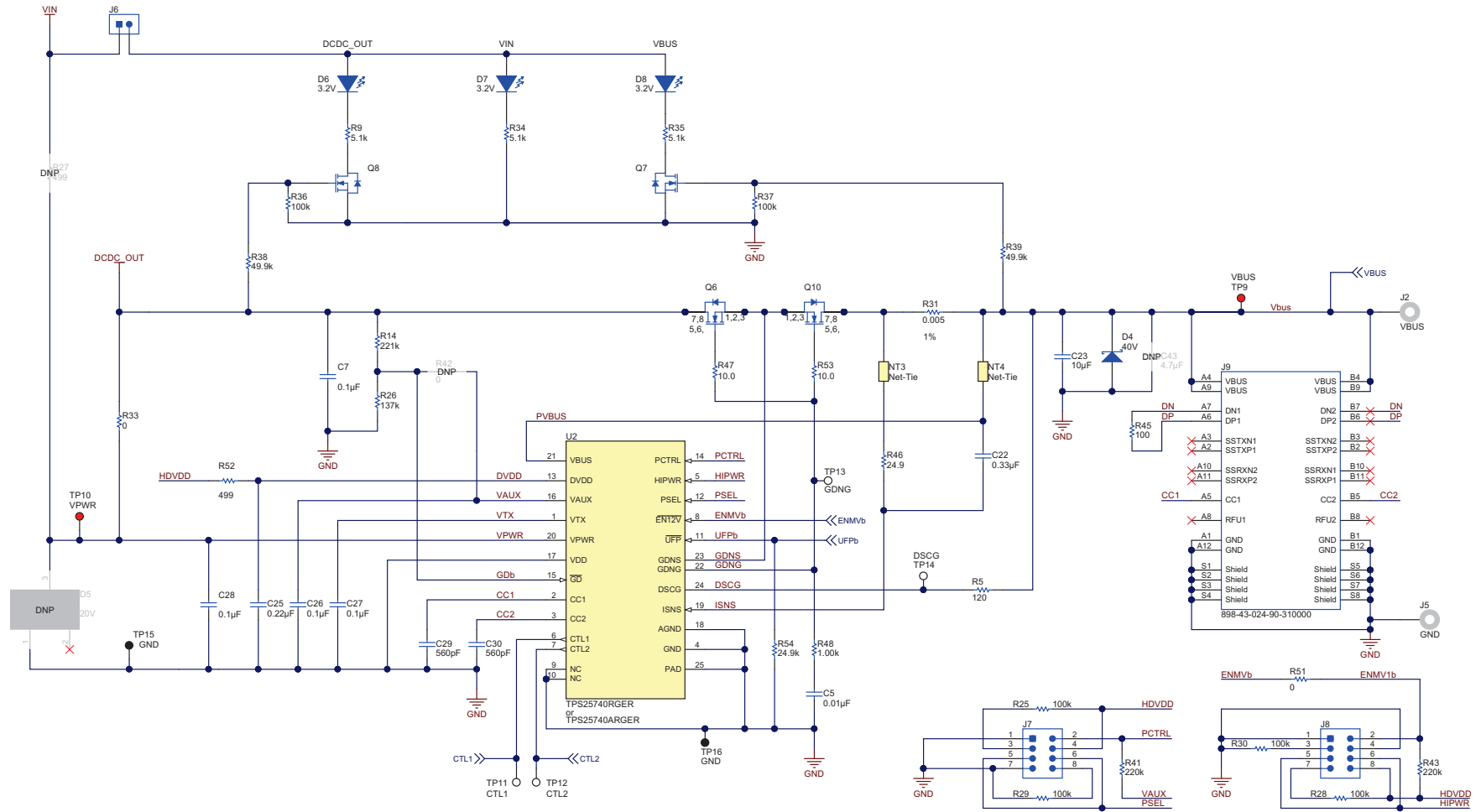

Figure 2. LM5175 Buck-Boost Power Supply



Copyright © 2016, Texas Instruments Incorporated

Figure 3. TPS25740 DFP

4 Configuring the EVM

4.1 Physical Access

Table 2 lists the TPS25740EVM-741 connector and LED functionality, Table 3 describes jumper functionality, and Table 4 describes the test point availability.

Table 2. Connector and LED Functionality

Connector	Label	Description
J1	VIN	Power bus input. Apply bus input voltage between J1 and J3.
J2	VBUS	Output voltage that is applied to the VBUS of the USB type C cable. J2 along with J5 can be used to apply an external load.
J3	GND	Power bus input return connector. Apply bus input voltage between J1 and J3.
J4	J4	Barrel jack input from an AC to DC power supply. The center tip is positive.
J5	GND	Switch bus output return connector. Apply the load between J2 and J5
J9	J9	Type C receptacle.
D6	DCDC_OUT	This Green LED indicates when the output of the DC/DC converter is above approximately 3 V.
D7	D7	This Green LED indicates when an input voltage is present at J1/J3 or J4.
D8	D8	This Green LED indicates when VBUS is above approximately 3 V.

Table 3. Jumpers Functionality

Jumper	Label	Description
J7	PSEL/PCTRL	Used to program the PSEL and PCTRL pins of the TPS25740 and TPS25740A. This advertises the power level to the UFP. Install a single shunt in the P1, P2, P3, or P4 position. Optionally, a second shunt can be installed in the PCTRL position. The position locations are shown in Figure 4 and also on the PCB silkscreen near J7. P1 position: PSEL = 93 W P2 position (default): PSEL = 65 W P3 position: PSEL = 45 W P4 position: PSEL = 36 W PCTRL position (shunt installed): P _{MAX} = PSEL/2 PCTRL position (no shunt installed-default): P _{MAX} = PSEL
J8	HIPWR/ENMVb	Used to program the HIPWR and EN12Vb/EN9Vb pins of the TPS25740 and TPS25740A. This advertises maximum voltage and maximum current to the UFP. Install a single shunt in the H1, H2, H3, or H4 position. Optionally, a second shunt can be installed in the ENMVb position. The position locations are shown in Figure 5 and also on the PCB silkscreen near J8. V1 = 5 V, V2 = 9 V or 12 V, V3 = 15 V or 20 V ENMVb position (shunt installed-default): V1 and V2 ENMVb position (no shunt installed): No V2 H1 position: V3 and I _{MAX} = 5A (OCP = 6.3 A) H2 position (default): V3 and I _{MAX} = 3A (OCP = 4.2A) H3 position: No V3 and I _{MAX} = 5A (OCP = 6.3A) H4 position: No V3 and I _{MAX} = 3A (OCP = 4.2A) Advertised current at V _x : I _x = min (P _{MAX} /V _x , I _{MAX})
J6	LED Power	Used to disconnect the LED power. This allows for more accurate measurement of the board's efficiency especially at light loads or when UFP is disconnected.

Table 4. Test Points

J7	J8	Description		
TP1	VIN	Input voltage		
TP2	DCDC_OUT	Output of the Buck Boost and input to the TPS25740 and TPS25740A circuitry.		
TP3/TP4	GND	Input ground test points.		
TP15/TP16	GND	Output ground test points.		
TP6	SYNC	Capacitive coupled measurement of SYNC pin.		
TP7	PGOOD	Power good output of the DC/DC. High = power good		
TP5	UFPb	Active low signal which is asserted when a UFP is connected on the other side of the cable.		
TP11, TP12	CTL1, CTL2	Control signals coming from the TPSP25740 and TPS25740A that adjust the output voltage of the buck boost converter based on the following table:		
		Voltage contained in PDO requested by UFP	CTL2 State	CTL1 State
		5 V	High-Z	High-Z
		12 V or 9 V	Low	High-Z
	20 V or 15 V	Low	Low	
TP13	GDNG	NFET gate drive signal		
TP9	VBUS	Voltage that is applied to the Vbus of the type C receptacle and cable.		
TP10	VPWR	Voltage tied to VPWR, which is used to power the TPS2574x chip.		
TP14	DSCG	The TPS25740 and TPS25740A discharge VBUS with this pin.		
TP8	EN_DCDC	Tied to the enable pin of the DC DC.		

4.2 Setting Advertisement Levels with J7 and J8

The advertised power, voltages, and currents can be configured using J7 and J8 as shown in [Figure 4](#) and [Figure 5](#).

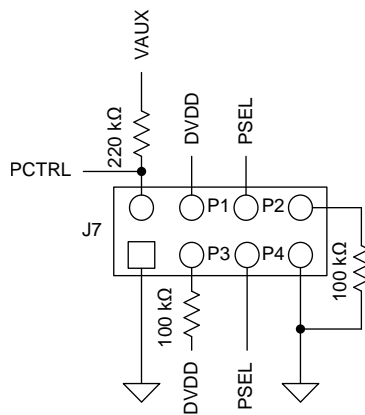

Figure 4. Power Select Header – J7

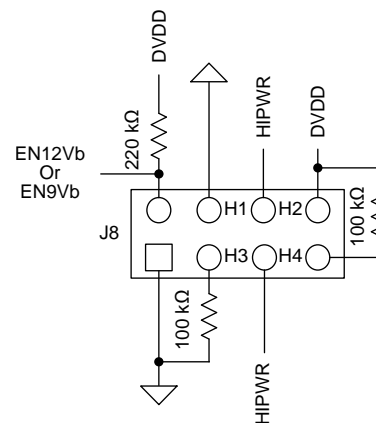

Figure 5. Voltage and Current Select Header – J8

4.3 Equipment Setup

The following equipment is required to set up the EVM:

- Power supply capable of 12 V and preferably 10 A (120 W)
- Resistive or electronic load
- PD capable UFP to negotiate voltages, in this case the TPS25720 EVM was used
- Type C cable

5 Operation

Use the following steps for EVM operation:

1. Turn on the input power supply to 12 V.
2. Connect the UFP to the TPS25740 and TPS25740A EVM through a type C cable.
3. Make desired voltage requests from the UFP to TPS25740 and TPS25740A EVM.
4. Connect load between J2 and J5 as desired to test efficiency and other performance.

6 Test Results

This section provides typical performance waveforms for the TPS25740EVM-741 and TPS25740AEVM-741 with $V_{IN} = 12\text{ V}$ at no load (unless otherwise specified). Actual performance data is affected by measurement techniques and environmental variables; therefore, these curves are presented for reference and may differ from actual results obtained.

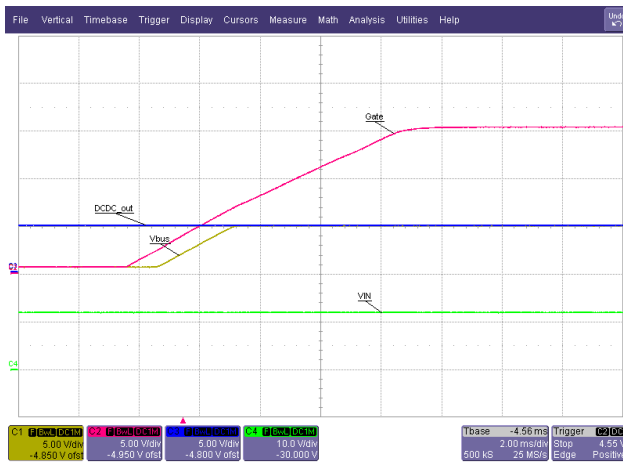

Figure 6. UFP Plug-In (5 V)

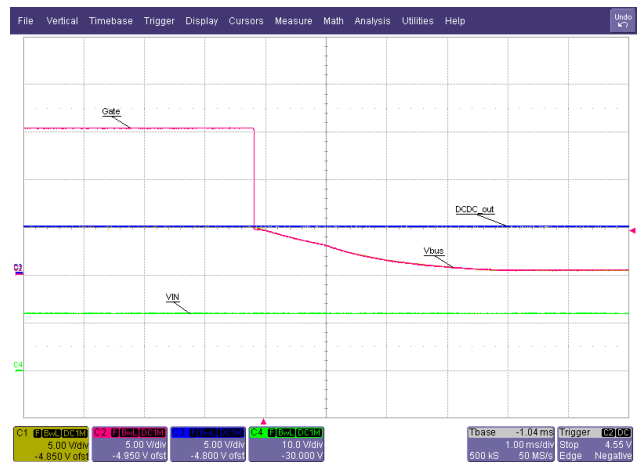

Figure 7. UFP Unplug (5 V)



Figure 8. UFP Unplug (12 V)



Figure 9. UFP Unplug (20 V)

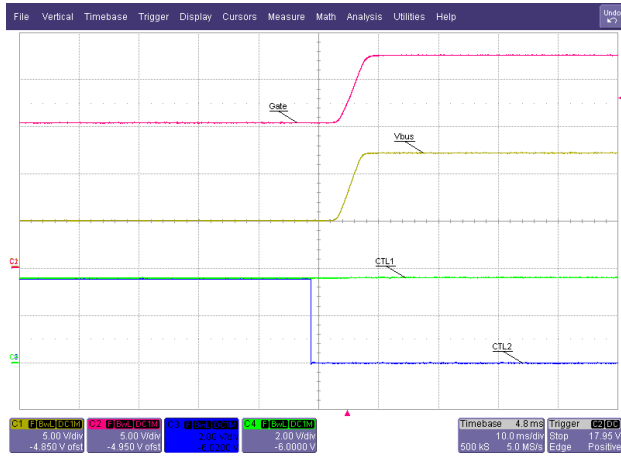

Figure 10. 5-V to 12-V Transition



Figure 11. 5-V to 20-V Transition



Figure 12. 12-V to 20-V Transition

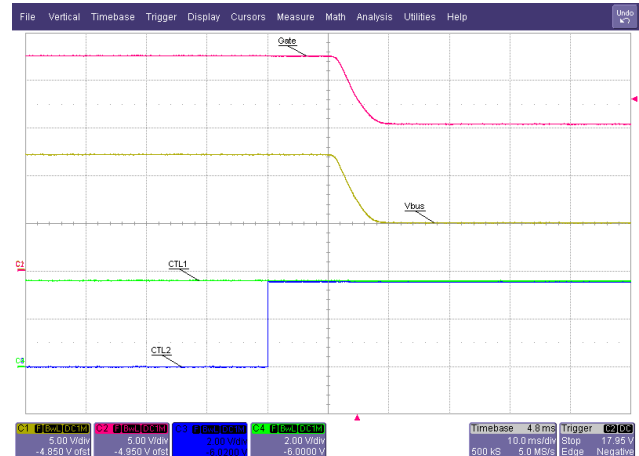

Figure 13. 12-V to 5-V Transition



Figure 14. 20-V to 5-V Transition



Figure 15. 20-V to 12-V Transition

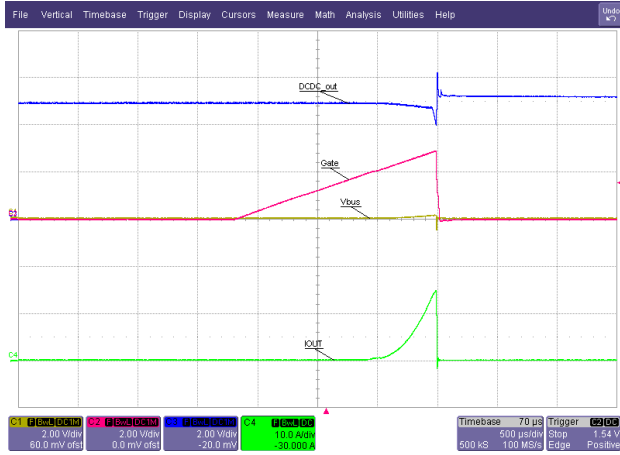

Figure 16. Start Into Short on Output

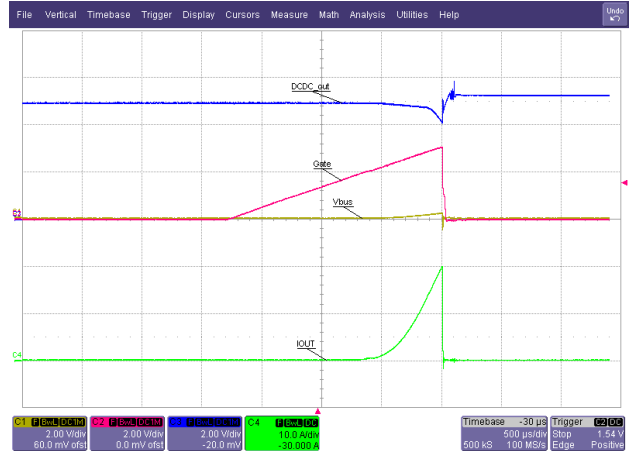

Figure 17. Start Into Short on Output (Extra 1000 µF Between DCDC_out and GND)

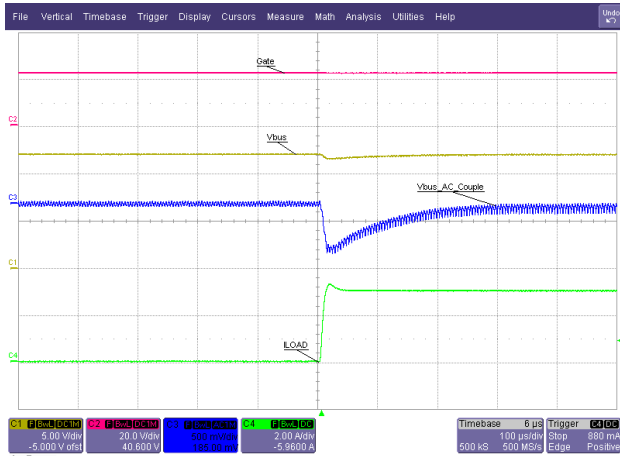

Figure 18. Load Step From 0 A to 3 A (12 V)

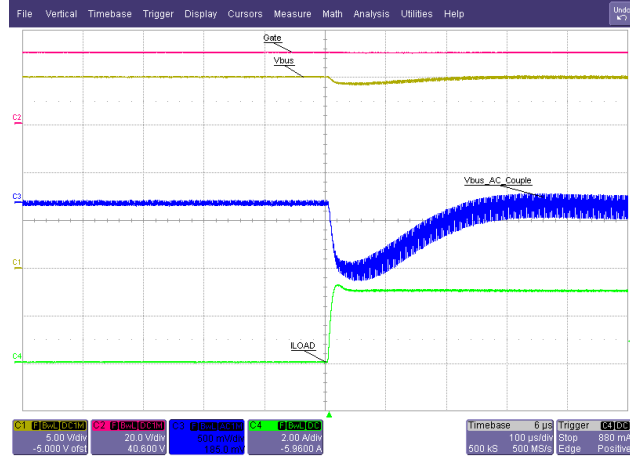

Figure 19. Load Step From 0 A to 3 A (20 V)

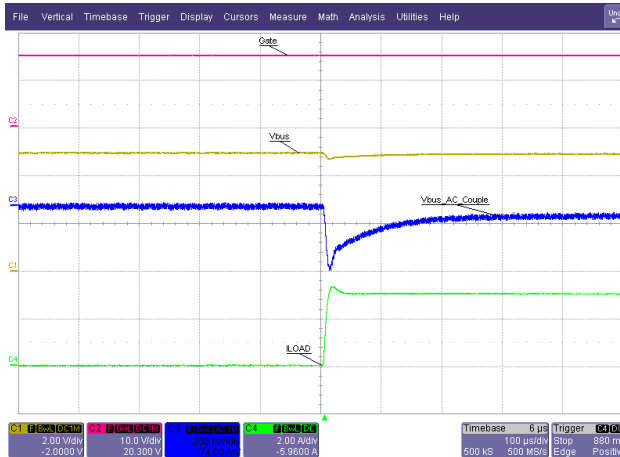

Figure 20. Load Step From 0 A to 3 A (5 V)



Figure 21. Raise V_{IN} With UFP Already Plugged In

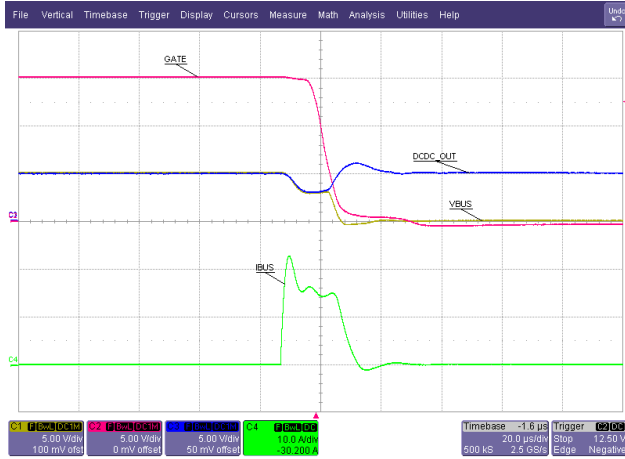

Figure 22. 5-V Hot Short on UFP Side

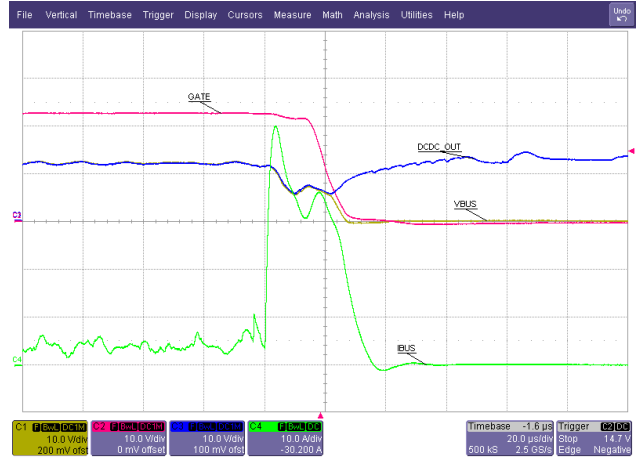

Figure 23. 12-V Hot Short on UFP Side

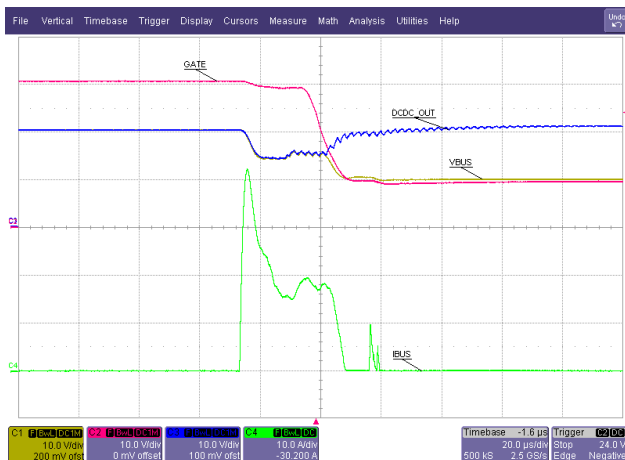

Figure 24. 20-V Hot Short on UFP Side

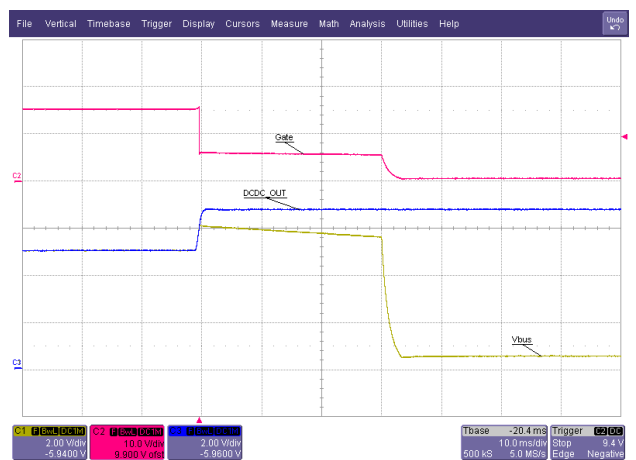

Figure 25. Overvoltage at 5-V Contract (With External Supply)

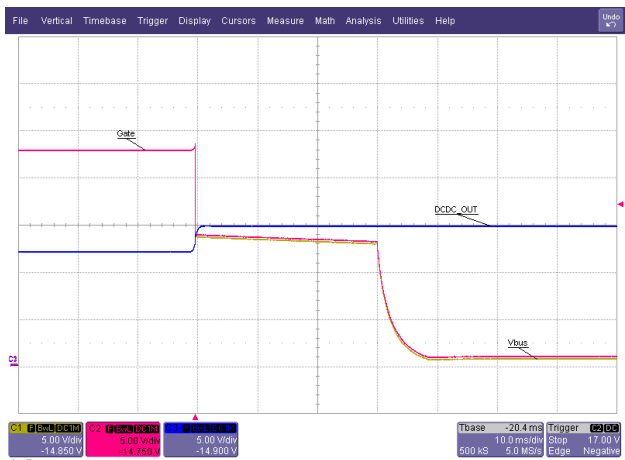

Figure 26. Overvoltage at 12-V Contract (With External Supply)

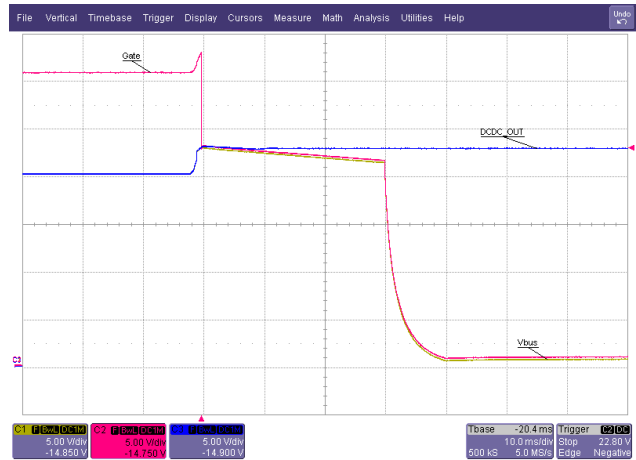

Figure 27. Overvoltage at 20-V Contract (With External Supply)

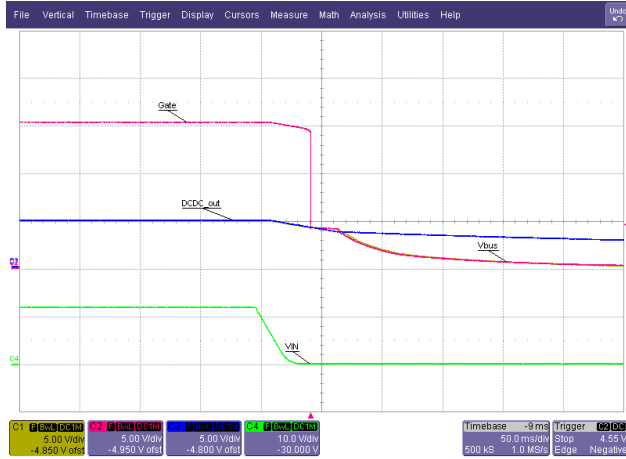

Figure 28. Remove Input Power

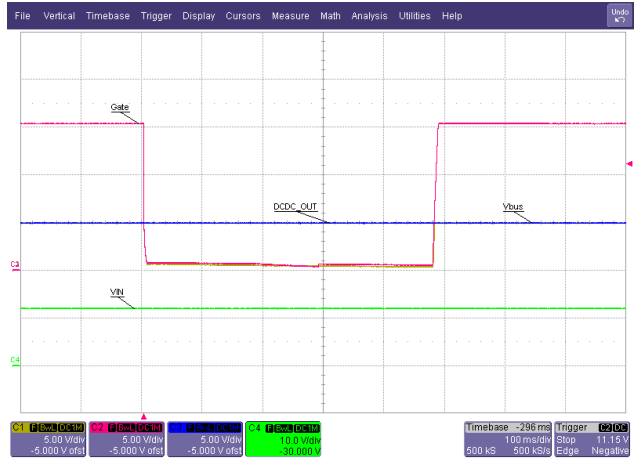

Figure 29. Unplug Then Replug in Quickly

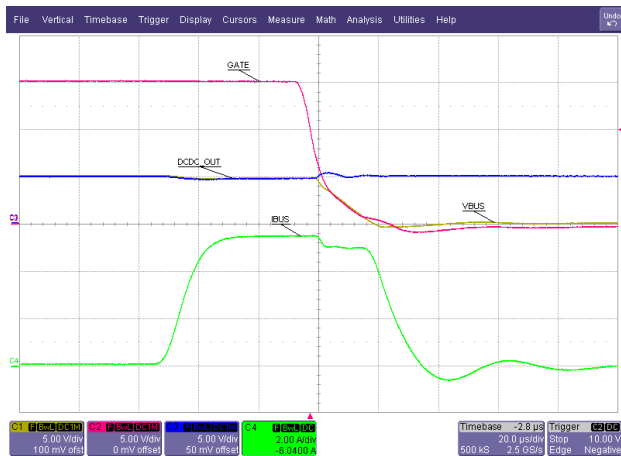

Figure 30. 5.5-A Load Step Triggers OCP (5 V)

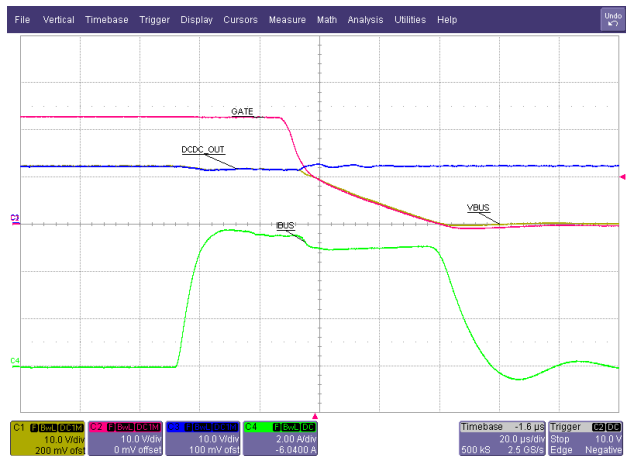

Figure 31. 5.5-A Load Step Triggers OCP (12 V)

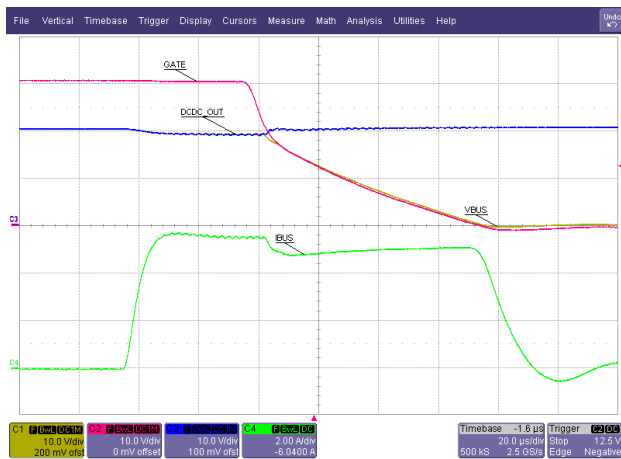

Figure 32. 5.5-A Load Step Triggers OCP (20 V)

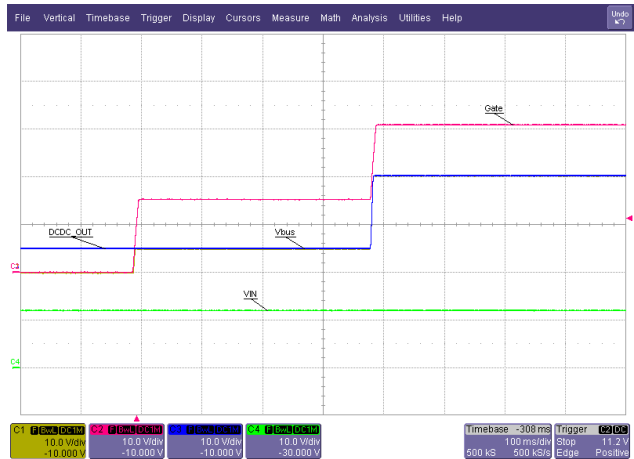

Figure 33. Plug In to MacBook (5-V, 12-V, 20-V Advertised)

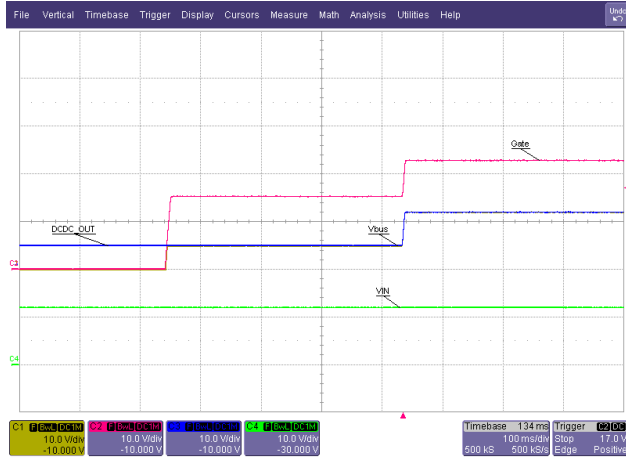

Figure 34. Plug In to MacBook (5-V and 12-V Advertised)

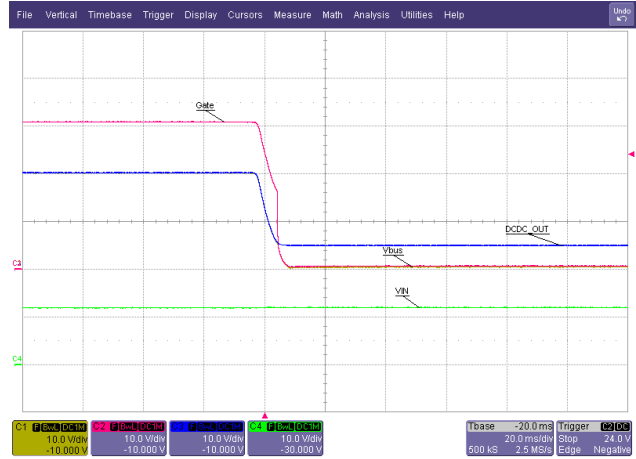

Figure 35. Unplug MacBook (5-V, 12-V, 20-V Advertised)



Figure 36. Unplug MacBook (5-V and 12-V Advertised)

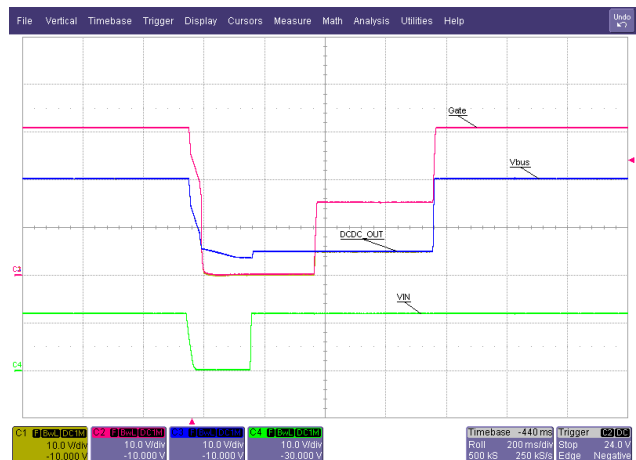

Figure 37. Power Cycle MacBook Plugged In (5-V, 12-V, 20-V Advertised)

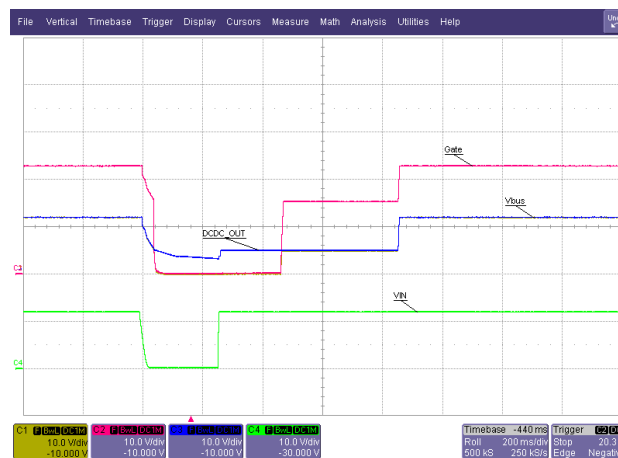

Figure 38. Power Cycle With MacBook (5-V and 12-V Advertised)

7 EVM Assembly Drawings and Layout Guidelines

Figure 39 through Figure 43 show component placement and layout of the EVM.

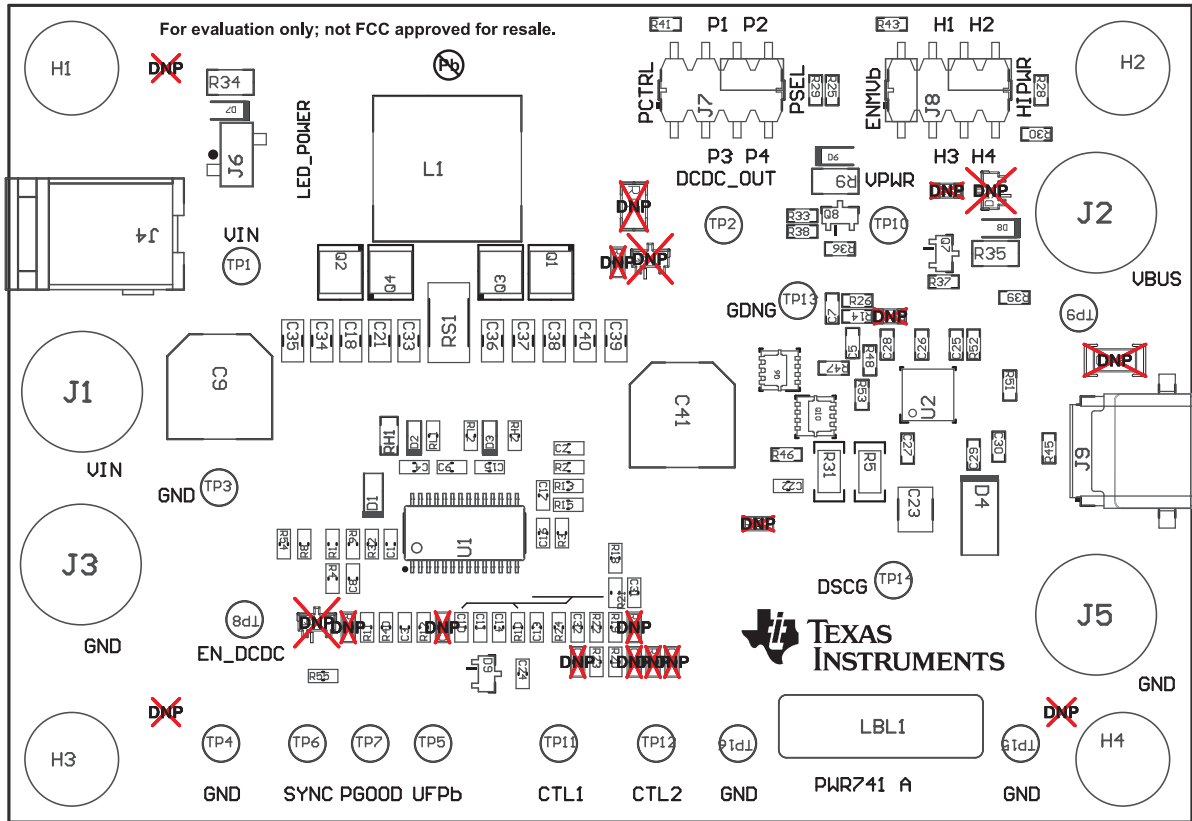

Figure 39. Top Side Placement

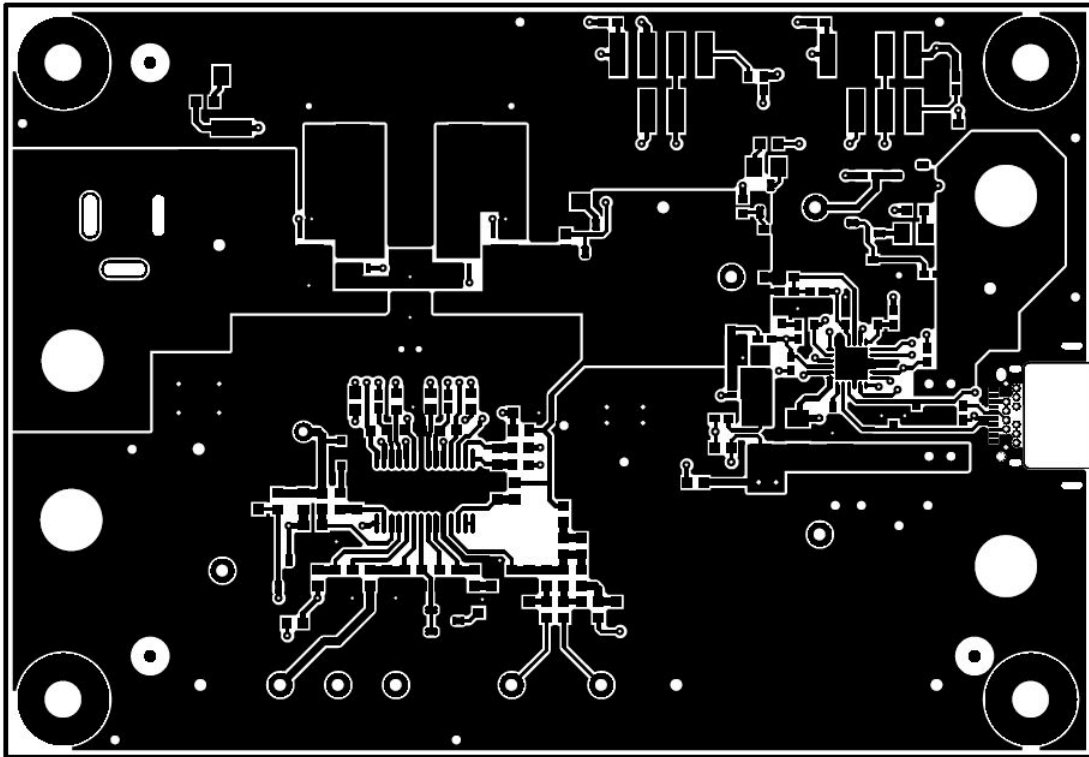

Figure 40. Top Side Routing

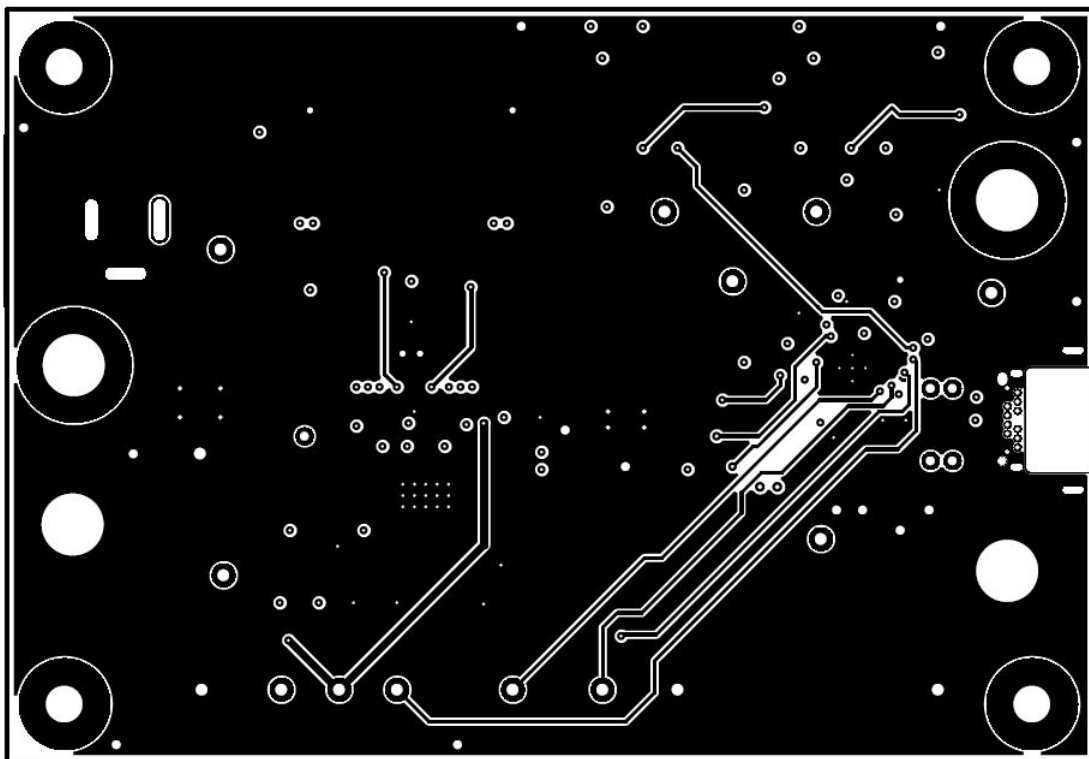

Figure 41. Layer Two Routing

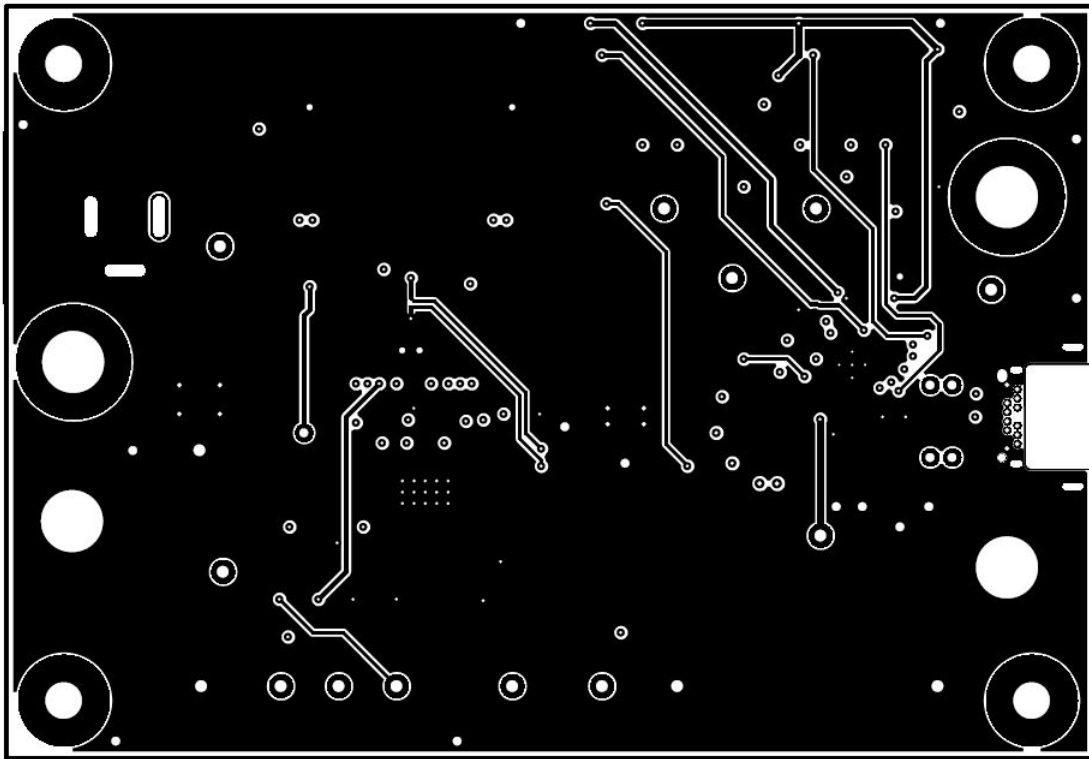

Figure 42. Layer Three Routing

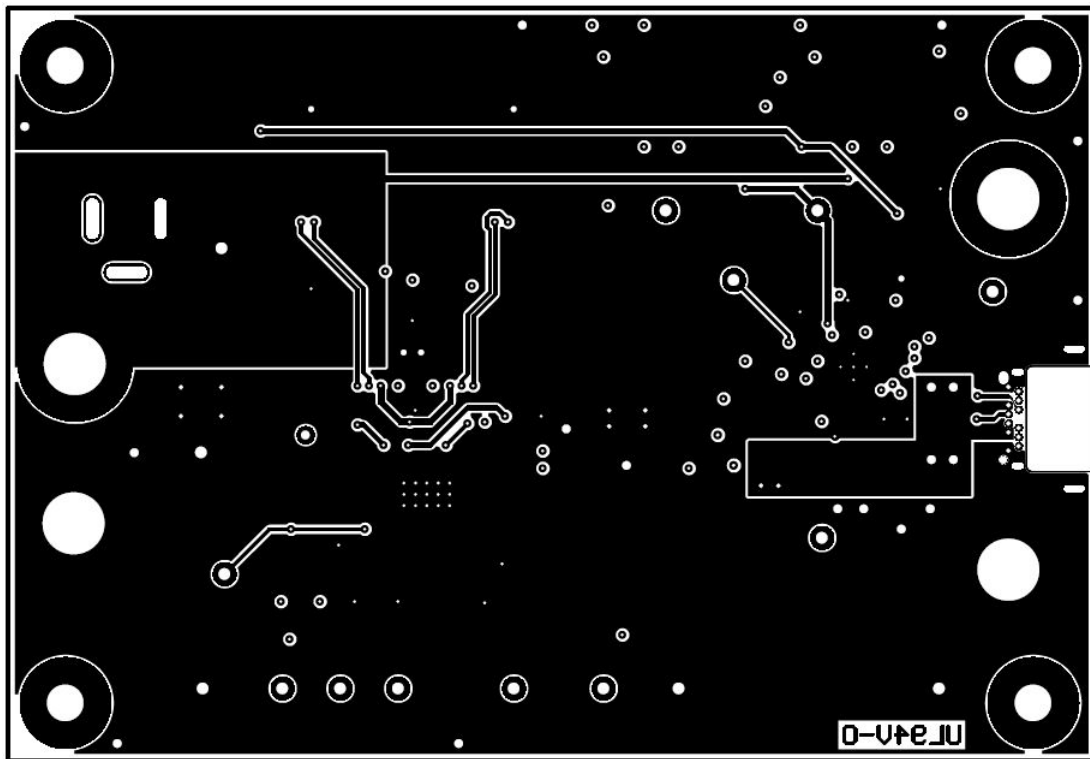

Figure 43. Bottom Side Routing

8 Component Placement and Routing Guidelines

This section contains component placement instructions and EVM layout guidelines.

8.1 Power Pin Bypass Capacitors

Place the power pin bypass capacitors as instructed in the following:

- **C28:** Place close to pin 20 (VPWR) and connect with low inductance traces and vias according to [Figure 39](#).
- **C25:** Place close to pin 13 (DVDD) and connect with low inductance traces and vias according to [Figure 39](#).
- **C26:** Place close to pin 16 (VAUX) and connect with low inductance traces and vias according to [Figure 39](#).
- **C27:** Place close to pin 1 (VTX) and connect with low inductance traces and vias according to [Figure 39](#).

8.2 Supporting Components

The following list provides instructions for installing the other components:

- **CRX:** Place C29 and C30 inline with the CC1 and CC2 traces as shown in [Figure 39](#). These should be placed within one inch from the Type C connector. Minimize stubs and tees from on the trace routes.
- **Q1:** Place Q6/Q10 in a manner such that power flows uninterrupted from Q6/Q10 drain to the Type C connector VBUS connections. Provide adequate copper plane from Q6/Q10 drain and source to the interconnecting circuits.
- **RS:** Place R31, as shown in [Figure 39](#), to facilitate uninterrupted power flow to the Type C connector. Orient RS for optimal Kelvin sense connection/routing back to the TPS25740/TPS25740A. In high current applications where the power dissipation is over 250 mW, provide an adequate copper feed to the pads of R31.
- **RG:** Place R47 and R53 near Q6 and Q10 as shown in [Figure 39](#). Minimize stray leakage paths as the GDNG sourcing current could be affected.
- **RSLEW/CSLEW:** Place R48 and C5 near R47/R53 as shown in [Figure 39](#).
- **R5:** Place on top of the VBUS copper route and connect to the DSCG pin with a 15-mil trace.
- **RF/CF:** When required, place R46 and C22 as shown in [Figure 39](#) to facilitate the Kelvin sense connection back to the TPS25740/TPS25740A.
- **CVBUS/DVBUS:** Place C23 and D4 within one inch of the Type C connector and connect them to VBUS and GND using adequate copper shapes.

9 Bill of Materials

Table 5 lists the EVM BOM.

Table 5. TPS25740EVM-741 Bill of Materials

Designator	Quantity (TPS25740)	Quantity (TPS25740A)	Value	Description	Package Reference	Part Number	Manufacturer	Alternate Part Number	Alternate Manufacturer
C1, C2	2	2	0.22uF	CAP, CERM, 0.22uF, 50V, +/-10%, X7R, 0603	0603	C1608X7R1H224K080AB	TDK		
C3, C10	2	2	100pF	CAP, CERM, 100 pF, 50 V, +/- 5%, C0G/NP0, 0603	0603	GRM1885C1H101JA01D	Murata		
C4, C15	2	2	0.1uF	CAP, CERM, 0.1 uF, 25 V, +/- 5%, X7R, 0603	0603	06033C104JAT2A	AVX		
C5	1	1	0.01uF	CAP, CERM, 0.01 uF, 50 V, +/- 10%, X7R, AEC-Q200 Grade 1, 0402	0402	CGA2B3X7R1H103K050BB	TDK		
C6	1	1	1uF	CAP, CERM, 1uF, 16V, +/-10%, X7R, 0603	0603	GRM188R71C105KA12D	Murata		
C7, C26, C27, C28	4	4	0.1uF	CAP, CERM, 0.1 uF, 50 V, +/- 10%, X7R, 0402	0402	C1005X7R1H104K	TDK		
C8, C16	2	2	0.22uF	CAP, CERM, 0.22 uF, 50 V, +/- 10%, X7R, 0603	0603	C1608X7R1H224K080AB	TDK		
C9	1	1	68uF	CAP, AL, 68 uF, 63 V, +/- 20%, 0.65 ohm, SMD	SMT Radial F	EEE-FK1J680UP	Panasonic		
C11	1	1	0.047uF	CAP, CERM, 0.047 uF, 25 V, +/- 10%, X7R, 0603	0603	C1608X7R1E473K	TDK		
C13	1	1	0.022uF	CAP, CERM, 0.022 uF, 50 V, +/- 10%, X7R, 0603	0603	GRM188R71H223KA01D	Murata		
C14, C17	2	2	220pF	CAP, CERM, 220 pF, 50 V, +/- 5%, C0G/NP0, 0603	0603	GRM1885C1H221JA01D	Murata		
C18, C21, C33, C34, C35, C36, C37, C38, C39, C40	10	10	4.7uF	CAP, CERM, 4.7 uF, 50 V, +/- 10%, X7R, 1206	1206	GRM31CR71H475KA12L	Murata		
C22	1	1	0.33uF	CAP, CERM, 0.33 uF, 16 V, +/- 10%, X7R, 0603	0603	GRM188R71C334KA01D	Murata		
C23	1	1	10uF	CAP, CERM, 10 uF, 25 V, +/- 10%, X7R, 1210	1210	12103C106KAT2A	AVX		
C24	1	1	220pF	CAP, CERM, 220 pF, 100 V, +/- 10%, X7R, 0603	0603	06031C221KAT2A	AVX		
C25	1	1	0.22uF	CAP, CERM, 0.22 uF, 6.3 V, +/- 20%, X5R, 0402	0402	C1005X5R0J224M	TDK		
C29, C30	2	2	560pF	CAP, CERM, 560 pF, 50 V, +/- 5%, C0G/NP0, 0402	0402	GRM1555C1H561JA01D	Murata		
C31	1	1	0.022uF	CAP, CERM, 0.022 uF, 50 V, +/- 10%, X7R, 0603	0603	C0603C223K5RACTU	Kemet		
C32	1	1	0.1uF	CAP, CERM, 0.1 uF, 25 V, +/- 10%, X5R, 0603	0603	06033D104KAT2A	AVX		
C41	1	1	100uF	CAP, AL, 100 uF, 50 V, +/- 20%, 0.34 ohm, SMD	SMT Radial F	EEE-FK1H101P	Panasonic		
D1	1	1	30V	Diode, Schottky, 30V, 0.2A, SOD-323	SOD-323	BAT54HT1G	ON Semiconductor		
D2, D3	2	2	100V	Diode, Switching, 100V, 0.25A, SOD-523	SOD-523	BAS516,115	NXP Semiconductor		
D4	1	1	40V	Diode, Schottky, 40 V, 3 A, SMA	SMA	B340A-13-F	Diodes Inc.		
D6	1	1	DCDC_OUT	LED, Green, SMD	LED_0603	150060GS75000	Würth Elektronik		
D7	1	1	VIN	LED, Green, SMD	LED_0603	150060GS75000	Würth Elektronik		
D8	1	1	VBUS	LED, Green, SMD	LED_0603	150060GS75000	Würth Elektronik		
D9	1	1	30V	Diode, Schottky, 30 V, 0.2 A, SOT-23	SOT-23	BAT54SLT1G	ON Semiconductor		
H1, H2, H3, H4	4	4		Machine Screw, Round, #4-40 x 1/4, Nylon, Philips panhead	Screw	NY PMS 440 0025 PH	B&F Fastener Supply		
H5, H6, H7, H8	4	4		Standoff, Hex, 0.5"L #4-40 Nylon	Standoff	1902C	Keystone	-	-
J1, J2, J3, J5	4	4		Standard Banana Jack, Uninsulated, 5.5mm	Keystone_575-4	575-4	Keystone		
J4	1	1		Connector, DC Jack 2.1X5.5 mm, TH	Conn, DC Jack, pin 2mm Dia.	PJ-202AH	CUI Inc.		

Table 5. TPS25740EVM-741 Bill of Materials (continued)

Designator	Quantity (TPS25740)	Quantity (TPS25740A)	Value	Description	Package Reference	Part Number	Manufacturer	Alternate Part Number	Alternate Manufacturer
J6	1	1		Header, 100mil, 2x1, Gold with Tin Tail, SMT	2x1 Header	TSM-102-01-L-SV	Samtec		
J7, J8	2	2		Header, 2.54mm, 4x2, Gold, SMT	Header, 2.54mm, 4x2, SMT	TSM-104-01-L-DV	Samtec		
J9	1	1		Connector, Receptacle, USB Type C, R/A, TH	Connector, Receptacle, USB Type C, R/A, TH	898-43-024-90-310000	Mill-Max		
L1	1	1	4.7uH	Inductor, Shielded Drum Core, Ferrite, 4.7 μ H, 15.5 A, 0.0064 ohm, SMD	12.1x9.5x11.4mm	7443320470	Würth Elektronik		
LBL1	1	1		Thermal Transfer Printable Labels, 0.650" W x 0.200" H - 10,000 per roll	PCB Label 0.650"H x 0.200"W	THT-14-423-10	Brady	-	-
Q1, Q2, Q3, Q4	4	4	60V	MOSFET, N-CH, 60 V, 17 A, PG-TSDSON-8	PG-TSDSON-8	BSZ042N06NS	Infineon Technologies		None
Q6, Q10	2	2	30V	MOSFET, N-CH, 30 V, 14 A, SON 3.3x3.3mm	SON 3.3x3.3mm	CSD17578Q3A	Texas Instruments		None
Q7, Q8	2	2	60V	MOSFET, N-CH, 60 V, 0.17 A, SOT-23	SOT-23	2N7002-7-F	Diodes Inc.		None
R1	1	1	130k	RES, 130 k, 5%, 0.1 W, 0603	0603	CRCW0603130KJNEA	Vishay-Dale		
R2, R3, R6, R32	4	4	10	RES, 10, 5%, 0.1 W, 0603	0603	CRCW060310R0JNEA	Vishay-Dale		
R4	1	1	23.7k	RES, 23.7 k, 1%, 0.1 W, 0603	0603	CRCW060323K7FKEA	Vishay-Dale		
R5	1	1	120	RES, 120 ohm, 5%, 0.25W, 1206	1206	CRCW1206120RJNEA	Vishay-Dale		
R8	1	1	200k	RES, 200 k, 1%, 0.1 W, 0603	0603	CRCW0603200KFKEA	Vishay-Dale		
R9, R34, R35	3	3	5.1k	RES, 5.1 k, 5%, 0.125 W, 0805	0805	CRCW08055K10JNEA	Vishay-Dale		
R10	1	1	3.3k	RES, 3.3 k, 5%, 0.1 W, 0603	0603	CRCW06033K30JNEA	Vishay-Dale		
R11	1	1	93.1k	RES, 93.1 k, 1%, 0.1 W, 0603	0603	CRCW060393K1FKEA	Vishay-Dale		
R12	1	1	64.9k	RES, 64.9 k, 1%, 0.1 W, 0603	0603	CRCW060364K9FKEA	Vishay-Dale		
R13, R15	2	2	100	RES, 100, 1%, 0.1 W, 0603	0603	CRCW0603100RFKEA	Vishay-Dale		
R14	1	1	221k	RES, 221 k, 1%, 0.063 W, 0402	0402	CRCW0402221KFKED	Vishay-Dale		
R18	1	1	47	RES, 47, 5%, 0.1 W, 0603	0603	CRCW060347R0JNEA	Vishay-Dale		
R19	1	0	5.62k	RES, 5.62 k, 1%, 0.1 W, 0603	0603	CRCW06035K62FKEA	Vishay-Dale		
R19	0	1	9.76k	RES, 9.76 k, 1%, 0.1 W, 0603	0603	CRCW06039K76FKEA	Vishay-Dale		
R20, R23, R40	3	3	0	RES, 0, 5%, 0.1 W, 0603	0603	CRCW0603000Z0EA	Vishay-Dale		
R21, R55	2	2	49.9k	RES, 49.9 k, 1%, 0.1 W, 0603	0603	CRCW060349K9FKEA	Vishay-Dale		
R22	1	0	4.99k	RES, 4.99 k, 1%, 0.1 W, 0603	0603	CRCW06034K99FKEA	Vishay-Dale		
R22	0	1	6.65k	RES, 6.65 k, 1%, 0.1 W, 0603	0603	CRCW06036K65FKEA	Vishay-Dale		
R24	1	1	9.53k	RES, 9.53 k, 1%, 0.1 W, 0603	0603	CRCW06039K53FKEA	Vishay-Dale		
R25, R28, R29, R30, R36, R37	6	6	100k	RES, 100 k, 5%, 0.063 W, 0402	0402	CRCW0402100KJNED	Vishay-Dale		
R26	1	1	137k	RES, 137 k, 1%, 0.063 W, 0402	0402	CRCW0402137KFKED	Vishay-Dale		
R31	1	1	0.005	RES, 0.005, 1%, 0.5 W, 1206	1206	WSL12065L000FEA18	Vishay-Dale		
R33, R51	2	2	0	RES, 0, 5%, 0.063 W, 0402	0402	RC0402JR-070RL	Yageo America		
R38, R39	2	2	49.9k	RES, 49.9 k, 1%, 0.063 W, 0402	0402	CRCW040249K9FKED	Vishay-Dale		
R41, R43	2	2	220k	RES, 220 k, 5%, 0.063 W, 0402	0402	CRCW0402220KJNED	Vishay-Dale		
R45	1	1	100	RES, 100, 5%, 0.063 W, 0402	0402	CRCW0402100RJNED	Vishay-Dale		

Table 5. TPS25740EVM-741 Bill of Materials (continued)

Designator	Quantity (TPS25740)	Quantity (TPS25740A)	Value	Description	Package Reference	Part Number	Manufacturer	Alternate Part Number	Alternate Manufacturer
R46	1	1	24.9	RES, 24.9, 1%, 0.063 W, 0402	0402	CRCW040224R9FKED	Vishay-Dale		
R47, R53	2	2	10.0	RES, 10.0, 1%, 0.063 W, 0402	0402	CRCW040210R0FKED	Vishay-Dale		
R48	1	1	1.00k	RES, 1.00 k, 1%, 0.063 W, 0402	0402	CRCW04021K00FKED	Vishay-Dale		
R52	1	1	499	RES, 499, 1%, 0.063 W, 0402	0402	CRCW0402499RFKED	Vishay-Dale		
R54	1	1	24.9k	RES, 24.9 k, 1%, 0.1 W, 0603	0603	CRCW060324K9FKEA	Vishay-Dale		
RH1	1	1	2.94	RES, 2.94, 1%, 0.1 W, 0603	0603	CRCW06032R94FKEA	Vishay-Dale		
RH2, RL1, RL2	3	3	0	RES, 0 ohm, 5%, 0.1W, 0603	0603	CRCW06030000Z0EA	Vishay-Dale		
RS1	1	1	0.006	RES, 0.006, 1%, 1 W, 2512	2512	ERJ-M1WSF6M0U	Panasonic		
SH-J1, SH-J2, SH-J3, SH-J4	4	4	1x2	Shunt, 100mil, Gold plated, Black	Shunt	969102-0000-DA	3M	SNT-100-BK-G	Samtec
TP1, TP2, TP9, TP10	4	4	Red	Test Point, TH, Miniature, Red	Keystone5000	5000	Keystone	-	-
TP3, TP4, TP15, TP16	4	4	Black	Test Point, TH, Miniature, Black	Keystone5001	5001	Keystone	-	-
TP5, TP6, TP7, TP8, TP11, TP12, TP13, TP14	8	8	White	Test Point, Miniature, White, TH	White Miniature Testpoint	5002	Keystone		
U1	1	1		42V Wide VIN 4-Switch Synchronous Buck-Boost Controller, PWP0028F	PWP0028F	LM5175PWP	Texas Instruments		None
U2	1	0		USB Power Delivery (PD) Provider-Only and Type-C Downward Facing Port (DFP) Port Controller, RGE0024F	RGE0024F	TPS25740RGER	Texas Instruments	TPS25740RGET	Texas Instruments
U2	0	1		USB Power Delivery (PD) Provider-Only and Type-C Downward Facing Port (DFP) Port Controller, RGE0024F	RGE0024F	TPS25740ARGER	Texas Instruments	TPS25740ARGET	Texas Instruments
C12	0	0	100pF	CAP, CERM, 100pF, 50V, +/-5%, C0G/NP0, 0603	0603	GRM1885C1H101JA01D	Murata		
C19, C20, C42	0	0	1uF	CAP, CERM, 1 uF, 16 V, +/- 10%, X7R, 0603	0603	C1608X7R1C105K	TDK		
C43	0	0	4.7uF	CAP, CERM, 4.7 uF, 25 V, +/- 10%, X5R, 1206	1206	12063D475KAT2A	AVX		
D5	0	0	20V	Diode, Zener, 20 V, 225 mW, SOT-23	SOT-23	MMBZ5250BLT1G	ON Semiconductor		
FID1, FID2, FID3	0	0		Fiducial mark. There is nothing to buy or mount.	Fiducial	N/A	N/A		
Q5	0	0	40 V	Transistor, NPN, 40 V, 0.2 A, SOT-23	SOT-23	MMBT3904-7-F	Diodes Inc.		
Q9	0	0	-50V	MOSFET, P-CH, -50 V, -0.13 A, SOT-23	SOT-23	BSS84-7-F	Diodes Inc.		None
R7, R50	0	0	0	RES, 0, 5%, 0.1 W, 0603	0603	CRCW06030000Z0EA	Vishay-Dale		
R16	0	0	200k	RES, 200 k, 1%, 0.1 W, 0603	0603	CRCW0603200KFKEA	Vishay-Dale		
R17	0	0	510	RES, 510, 5%, 0.125 W, 0805	0805	ERJ-6GEYJ511V	Panasonic		
R27	0	0	499	RES, 499, 1%, 0.063 W, 0402	0402	CRCW0402499RFKED	Vishay-Dale		
R42	0	0	0	RES, 0, 5%, 0.063 W, 0402	0402	RC0402JR-070RL	Yageo America		
R44	0	0	100k	RES, 100 k, 1%, 0.1 W, 0603	0603	CRCW0603100KFKEA	Vishay-Dale		
R49	0	0	5.62k	RES, 5.62 k, 1%, 0.1 W, 0603	0603	CRCW06035K62FKEA	Vishay-Dale		
Notes: Unless otherwise noted in the Alternate Part Number or Alternate Manufacturer columns, all parts may be substituted with equivalents.									

Revision History

NOTE: Page numbers for previous revisions may differ from page numbers in the current version.

Changes from Original (April 2016) to A Revision	Page
• Deleted "for AC Adapters" from the title.	1
• Changed TPS2514 to TPS2514A in the BC1.2 charging support sentence in the Abstract.	1
• Added and changed content in the <i>Jumpers Functionality</i> table.	7
• Changed <i>Setting Advertisement Levels with J7 and J8</i> section. Removed red text references	8

STANDARD TERMS AND CONDITIONS FOR EVALUATION MODULES

1. *Delivery:* TI delivers TI evaluation boards, kits, or modules, including any accompanying demonstration software, components, or documentation (collectively, an "EVM" or "EVMs") to the User ("User") in accordance with the terms and conditions set forth herein. Acceptance of the EVM is expressly subject to the following terms and conditions.
 - 1.1 EVMs are intended solely for product or software developers for use in a research and development setting to facilitate feasibility evaluation, experimentation, or scientific analysis of TI semiconductors products. EVMs have no direct function and are not finished products. EVMs shall not be directly or indirectly assembled as a part or subassembly in any finished product. For clarification, any software or software tools provided with the EVM ("Software") shall not be subject to the terms and conditions set forth herein but rather shall be subject to the applicable terms and conditions that accompany such Software
 - 1.2 EVMs are not intended for consumer or household use. EVMs may not be sold, sublicensed, leased, rented, loaned, assigned, or otherwise distributed for commercial purposes by Users, in whole or in part, or used in any finished product or production system.
2. *Limited Warranty and Related Remedies/Disclaimers:*
 - 2.1 These terms and conditions do not apply to Software. The warranty, if any, for Software is covered in the applicable Software License Agreement.
 - 2.2 TI warrants that the TI EVM will conform to TI's published specifications for ninety (90) days after the date TI delivers such EVM to User. Notwithstanding the foregoing, TI shall not be liable for any defects that are caused by neglect, misuse or mistreatment by an entity other than TI, including improper installation or testing, or for any EVMs that have been altered or modified in any way by an entity other than TI. Moreover, TI shall not be liable for any defects that result from User's design, specifications or instructions for such EVMs. Testing and other quality control techniques are used to the extent TI deems necessary or as mandated by government requirements. TI does not test all parameters of each EVM.
 - 2.3 If any EVM fails to conform to the warranty set forth above, TI's sole liability shall be at its option to repair or replace such EVM, or credit User's account for such EVM. TI's liability under this warranty shall be limited to EVMs that are returned during the warranty period to the address designated by TI and that are determined by TI not to conform to such warranty. If TI elects to repair or replace such EVM, TI shall have a reasonable time to repair such EVM or provide replacements. Repaired EVMs shall be warranted for the remainder of the original warranty period. Replaced EVMs shall be warranted for a new full ninety (90) day warranty period.
3. *Regulatory Notices:*
 - 3.1 *United States*
 - 3.1.1 *Notice applicable to EVMs not FCC-Approved:*

This kit is designed to allow product developers to evaluate electronic components, circuitry, or software associated with the kit to determine whether to incorporate such items in a finished product and software developers to write software applications for use with the end product. This kit is not a finished product and when assembled may not be resold or otherwise marketed unless all required FCC equipment authorizations are first obtained. Operation is subject to the condition that this product not cause harmful interference to licensed radio stations and that this product accept harmful interference. Unless the assembled kit is designed to operate under part 15, part 18 or part 95 of this chapter, the operator of the kit must operate under the authority of an FCC license holder or must secure an experimental authorization under part 5 of this chapter.
 - 3.1.2 *For EVMs annotated as FCC – FEDERAL COMMUNICATIONS COMMISSION Part 15 Compliant:*

CAUTION

This device complies with part 15 of the FCC Rules. Operation is subject to the following two conditions: (1) This device may not cause harmful interference, and (2) this device must accept any interference received, including interference that may cause undesired operation.

Changes or modifications not expressly approved by the party responsible for compliance could void the user's authority to operate the equipment.

FCC Interference Statement for Class A EVM devices

NOTE: This equipment has been tested and found to comply with the limits for a Class A digital device, pursuant to part 15 of the FCC Rules. These limits are designed to provide reasonable protection against harmful interference when the equipment is operated in a commercial environment. This equipment generates, uses, and can radiate radio frequency energy and, if not installed and used in accordance with the instruction manual, may cause harmful interference to radio communications. Operation of this equipment in a residential area is likely to cause harmful interference in which case the user will be required to correct the interference at his own expense.

FCC Interference Statement for Class B EVM devices

NOTE: This equipment has been tested and found to comply with the limits for a Class B digital device, pursuant to part 15 of the FCC Rules. These limits are designed to provide reasonable protection against harmful interference in a residential installation. This equipment generates, uses and can radiate radio frequency energy and, if not installed and used in accordance with the instructions, may cause harmful interference to radio communications. However, there is no guarantee that interference will not occur in a particular installation. If this equipment does cause harmful interference to radio or television reception, which can be determined by turning the equipment off and on, the user is encouraged to try to correct the interference by one or more of the following measures:

- Reorient or relocate the receiving antenna.
- Increase the separation between the equipment and receiver.
- Connect the equipment into an outlet on a circuit different from that to which the receiver is connected.
- Consult the dealer or an experienced radio/TV technician for help.

3.2 Canada

3.2.1 For EVMs issued with an Industry Canada Certificate of Conformance to RSS-210

Concerning EVMs Including Radio Transmitters:

This device complies with Industry Canada license-exempt RSS standard(s). Operation is subject to the following two conditions: (1) this device may not cause interference, and (2) this device must accept any interference, including interference that may cause undesired operation of the device.

Concernant les EVMs avec appareils radio:

Le présent appareil est conforme aux CNR d'Industrie Canada applicables aux appareils radio exempts de licence. L'exploitation est autorisée aux deux conditions suivantes: (1) l'appareil ne doit pas produire de brouillage, et (2) l'utilisateur de l'appareil doit accepter tout brouillage radioélectrique subi, même si le brouillage est susceptible d'en compromettre le fonctionnement.

Concerning EVMs Including Detachable Antennas:

Under Industry Canada regulations, this radio transmitter may only operate using an antenna of a type and maximum (or lesser) gain approved for the transmitter by Industry Canada. To reduce potential radio interference to other users, the antenna type and its gain should be so chosen that the equivalent isotropically radiated power (e.i.r.p.) is not more than that necessary for successful communication. This radio transmitter has been approved by Industry Canada to operate with the antenna types listed in the user guide with the maximum permissible gain and required antenna impedance for each antenna type indicated. Antenna types not included in this list, having a gain greater than the maximum gain indicated for that type, are strictly prohibited for use with this device.

Concernant les EVMs avec antennes détachables

Conformément à la réglementation d'Industrie Canada, le présent émetteur radio peut fonctionner avec une antenne d'un type et d'un gain maximal (ou inférieur) approuvé pour l'émetteur par Industrie Canada. Dans le but de réduire les risques de brouillage radioélectrique à l'intention des autres utilisateurs, il faut choisir le type d'antenne et son gain de sorte que la puissance isotrope rayonnée équivalente (p.i.r.e.) ne dépasse pas l'intensité nécessaire à l'établissement d'une communication satisfaisante. Le présent émetteur radio a été approuvé par Industrie Canada pour fonctionner avec les types d'antenne énumérés dans le manuel d'usage et ayant un gain admissible maximal et l'impédance requise pour chaque type d'antenne. Les types d'antenne non inclus dans cette liste, ou dont le gain est supérieur au gain maximal indiqué, sont strictement interdits pour l'exploitation de l'émetteur.

3.3 Japan

3.3.1 *Notice for EVMs delivered in Japan:* Please see http://www.tij.co.jp/lstds/ti_ja/general/eStore/notice_01.page 日本国内に輸入される評価用キット、ボードについては、次のところをご覧ください。
http://www.tij.co.jp/lstds/ti_ja/general/eStore/notice_01.page

3.3.2 *Notice for Users of EVMs Considered "Radio Frequency Products" in Japan:* EVMs entering Japan may not be certified by TI as conforming to Technical Regulations of Radio Law of Japan.

If User uses EVMs in Japan, not certified to Technical Regulations of Radio Law of Japan, User is required by Radio Law of Japan to follow the instructions below with respect to EVMs:

1. Use EVMs in a shielded room or any other test facility as defined in the notification #173 issued by Ministry of Internal Affairs and Communications on March 28, 2006, based on Sub-section 1.1 of Article 6 of the Ministry's Rule for Enforcement of Radio Law of Japan,
2. Use EVMs only after User obtains the license of Test Radio Station as provided in Radio Law of Japan with respect to EVMs, or
3. Use of EVMs only after User obtains the Technical Regulations Conformity Certification as provided in Radio Law of Japan with respect to EVMs. Also, do not transfer EVMs, unless User gives the same notice above to the transferee. Please note that if User does not follow the instructions above, User will be subject to penalties of Radio Law of Japan.

【無線電波を送信する製品の開発キットをお使いになる際の注意事項】 開発キットの中には技術基準適合証明を受けていないものがあります。技術適合証明を受けていないものご使用に際しては、電波法遵守のため、以下のいずれかの措置を取っていただく必要がありますのでご注意ください。

1. 電波法施行規則第6条第1項第1号に基づく平成18年3月28日総務省告示第173号で定められた電波暗室等の試験設備でご使用いただく。
2. 実験局の免許を取得後ご使用いただく。
3. 技術基準適合証明を取得後ご使用いただく。

なお、本製品は、上記の「ご使用にあたっての注意」を譲渡先、移転先に通知しない限り、譲渡、移転できないものとします。

上記を遵守頂けない場合は、電波法の罰則が適用される可能性があることをご留意ください。日本テキサス・インスツルメンツ株式会社

東京都新宿区西新宿 6 丁目 2 4 番 1 号

西新宿三井ビル

3.3.3 *Notice for EVMs for Power Line Communication:* Please see http://www.tij.co.jp/llds/ti_ja/general/eStore/notice_02.page

電力線搬送波通信についての開発キットをお使いになる際の注意事項については、次のところをご覧ください。http://www.tij.co.jp/llds/ti_ja/general/eStore/notice_02.page

4 *EVM Use Restrictions and Warnings:*

4.1 EVMS ARE NOT FOR USE IN FUNCTIONAL SAFETY AND/OR SAFETY CRITICAL EVALUATIONS, INCLUDING BUT NOT LIMITED TO EVALUATIONS OF LIFE SUPPORT APPLICATIONS.

4.2 User must read and apply the user guide and other available documentation provided by TI regarding the EVM prior to handling or using the EVM, including without limitation any warning or restriction notices. The notices contain important safety information related to, for example, temperatures and voltages.

4.3 *Safety-Related Warnings and Restrictions:*

4.3.1 User shall operate the EVM within TI's recommended specifications and environmental considerations stated in the user guide, other available documentation provided by TI, and any other applicable requirements and employ reasonable and customary safeguards. Exceeding the specified performance ratings and specifications (including but not limited to input and output voltage, current, power, and environmental ranges) for the EVM may cause personal injury or death, or property damage. If there are questions concerning performance ratings and specifications, User should contact a TI field representative prior to connecting interface electronics including input power and intended loads. Any loads applied outside of the specified output range may also result in unintended and/or inaccurate operation and/or possible permanent damage to the EVM and/or interface electronics. Please consult the EVM user guide prior to connecting any load to the EVM output. If there is uncertainty as to the load specification, please contact a TI field representative. During normal operation, even with the inputs and outputs kept within the specified allowable ranges, some circuit components may have elevated case temperatures. These components include but are not limited to linear regulators, switching transistors, pass transistors, current sense resistors, and heat sinks, which can be identified using the information in the associated documentation. When working with the EVM, please be aware that the EVM may become very warm.

4.3.2 EVMs are intended solely for use by technically qualified, professional electronics experts who are familiar with the dangers and application risks associated with handling electrical mechanical components, systems, and subsystems. User assumes all responsibility and liability for proper and safe handling and use of the EVM by User or its employees, affiliates, contractors or designees. User assumes all responsibility and liability to ensure that any interfaces (electronic and/or mechanical) between the EVM and any human body are designed with suitable isolation and means to safely limit accessible leakage currents to minimize the risk of electrical shock hazard. User assumes all responsibility and liability for any improper or unsafe handling or use of the EVM by User or its employees, affiliates, contractors or designees.

4.4 User assumes all responsibility and liability to determine whether the EVM is subject to any applicable international, federal, state, or local laws and regulations related to User's handling and use of the EVM and, if applicable, User assumes all responsibility and liability for compliance in all respects with such laws and regulations. User assumes all responsibility and liability for proper disposal and recycling of the EVM consistent with all applicable international, federal, state, and local requirements.

5. *Accuracy of Information:* To the extent TI provides information on the availability and function of EVMs, TI attempts to be as accurate as possible. However, TI does not warrant the accuracy of EVM descriptions, EVM availability or other information on its websites as accurate, complete, reliable, current, or error-free.

6. *Disclaimers:*
- 6.1 EXCEPT AS SET FORTH ABOVE, EVMS AND ANY WRITTEN DESIGN MATERIALS PROVIDED WITH THE EVM (AND THE DESIGN OF THE EVM ITSELF) ARE PROVIDED "AS IS" AND "WITH ALL FAULTS." TI DISCLAIMS ALL OTHER WARRANTIES, EXPRESS OR IMPLIED, REGARDING SUCH ITEMS, INCLUDING BUT NOT LIMITED TO ANY IMPLIED WARRANTIES OF MERCHANTABILITY OR FITNESS FOR A PARTICULAR PURPOSE OR NON-INFRINGEMENT OF ANY THIRD PARTY PATENTS, COPYRIGHTS, TRADE SECRETS OR OTHER INTELLECTUAL PROPERTY RIGHTS.
- 6.2 EXCEPT FOR THE LIMITED RIGHT TO USE THE EVM SET FORTH HEREIN, NOTHING IN THESE TERMS AND CONDITIONS SHALL BE CONSTRUED AS GRANTING OR CONFERRING ANY RIGHTS BY LICENSE, PATENT, OR ANY OTHER INDUSTRIAL OR INTELLECTUAL PROPERTY RIGHT OF TI, ITS SUPPLIERS/LICENSORS OR ANY OTHER THIRD PARTY, TO USE THE EVM IN ANY FINISHED END-USER OR READY-TO-USE FINAL PRODUCT, OR FOR ANY INVENTION, DISCOVERY OR IMPROVEMENT MADE, CONCEIVED OR ACQUIRED PRIOR TO OR AFTER DELIVERY OF THE EVM.
7. *USER'S INDEMNITY OBLIGATIONS AND REPRESENTATIONS.* USER WILL DEFEND, INDEMNIFY AND HOLD TI, ITS LICENSORS AND THEIR REPRESENTATIVES HARMLESS FROM AND AGAINST ANY AND ALL CLAIMS, DAMAGES, LOSSES, EXPENSES, COSTS AND LIABILITIES (COLLECTIVELY, "CLAIMS") ARISING OUT OF OR IN CONNECTION WITH ANY HANDLING OR USE OF THE EVM THAT IS NOT IN ACCORDANCE WITH THESE TERMS AND CONDITIONS. THIS OBLIGATION SHALL APPLY WHETHER CLAIMS ARISE UNDER STATUTE, REGULATION, OR THE LAW OF TORT, CONTRACT OR ANY OTHER LEGAL THEORY, AND EVEN IF THE EVM FAILS TO PERFORM AS DESCRIBED OR EXPECTED.
8. *Limitations on Damages and Liability:*
- 8.1 *General Limitations.* IN NO EVENT SHALL TI BE LIABLE FOR ANY SPECIAL, COLLATERAL, INDIRECT, PUNITIVE, INCIDENTAL, CONSEQUENTIAL, OR EXEMPLARY DAMAGES IN CONNECTION WITH OR ARISING OUT OF THESE TERMS AND CONDITIONS OR THE USE OF THE EVMS PROVIDED HEREUNDER, REGARDLESS OF WHETHER TI HAS BEEN ADVISED OF THE POSSIBILITY OF SUCH DAMAGES. EXCLUDED DAMAGES INCLUDE, BUT ARE NOT LIMITED TO, COST OF REMOVAL OR REINSTALLATION, ANCILLARY COSTS TO THE PROCUREMENT OF SUBSTITUTE GOODS OR SERVICES, RETESTING, OUTSIDE COMPUTER TIME, LABOR COSTS, LOSS OF GOODWILL, LOSS OF PROFITS, LOSS OF SAVINGS, LOSS OF USE, LOSS OF DATA, OR BUSINESS INTERRUPTION. NO CLAIM, SUIT OR ACTION SHALL BE BROUGHT AGAINST TI MORE THAN ONE YEAR AFTER THE RELATED CAUSE OF ACTION HAS OCCURRED.
- 8.2 *Specific Limitations.* IN NO EVENT SHALL TI'S AGGREGATE LIABILITY FROM ANY WARRANTY OR OTHER OBLIGATION ARISING OUT OF OR IN CONNECTION WITH THESE TERMS AND CONDITIONS, OR ANY USE OF ANY TI EVM PROVIDED HEREUNDER, EXCEED THE TOTAL AMOUNT PAID TO TI FOR THE PARTICULAR UNITS SOLD UNDER THESE TERMS AND CONDITIONS WITH RESPECT TO WHICH LOSSES OR DAMAGES ARE CLAIMED. THE EXISTENCE OF MORE THAN ONE CLAIM AGAINST THE PARTICULAR UNITS SOLD TO USER UNDER THESE TERMS AND CONDITIONS SHALL NOT ENLARGE OR EXTEND THIS LIMIT.
9. *Return Policy.* Except as otherwise provided, TI does not offer any refunds, returns, or exchanges. Furthermore, no return of EVM(s) will be accepted if the package has been opened and no return of the EVM(s) will be accepted if they are damaged or otherwise not in a resalable condition. If User feels it has been incorrectly charged for the EVM(s) it ordered or that delivery violates the applicable order, User should contact TI. All refunds will be made in full within thirty (30) working days from the return of the components(s), excluding any postage or packaging costs.
10. *Governing Law:* These terms and conditions shall be governed by and interpreted in accordance with the laws of the State of Texas, without reference to conflict-of-laws principles. User agrees that non-exclusive jurisdiction for any dispute arising out of or relating to these terms and conditions lies within courts located in the State of Texas and consents to venue in Dallas County, Texas. Notwithstanding the foregoing, any judgment may be enforced in any United States or foreign court, and TI may seek injunctive relief in any United States or foreign court.

Mailing Address: Texas Instruments, Post Office Box 655303, Dallas, Texas 75265
Copyright © 2015, Texas Instruments Incorporated

STANDARD TERMS AND CONDITIONS FOR EVALUATION MODULES

1. *Delivery:* TI delivers TI evaluation boards, kits, or modules, including demonstration software, components, and/or documentation which may be provided together or separately (collectively, an "EVM" or "EVMs") to the User ("User") in accordance with the terms and conditions set forth herein. Acceptance of the EVM is expressly subject to the following terms and conditions.
 - 1.1 EVMs are intended solely for product or software developers for use in a research and development setting to facilitate feasibility evaluation, experimentation, or scientific analysis of TI semiconductors products. EVMs have no direct function and are not finished products. EVMs shall not be directly or indirectly assembled as a part or subassembly in any finished product. For clarification, any software or software tools provided with the EVM ("Software") shall not be subject to the terms and conditions set forth herein but rather shall be subject to the applicable terms and conditions that accompany such Software
 - 1.2 EVMs are not intended for consumer or household use. EVMs may not be sold, sublicensed, leased, rented, loaned, assigned, or otherwise distributed for commercial purposes by Users, in whole or in part, or used in any finished product or production system.
2. *Limited Warranty and Related Remedies/Disclaimers:*
 - 2.1 These terms and conditions do not apply to Software. The warranty, if any, for Software is covered in the applicable Software License Agreement.
 - 2.2 TI warrants that the TI EVM will conform to TI's published specifications for ninety (90) days after the date TI delivers such EVM to User. Notwithstanding the foregoing, TI shall not be liable for any defects that are caused by neglect, misuse or mistreatment by an entity other than TI, including improper installation or testing, or for any EVMs that have been altered or modified in any way by an entity other than TI. Moreover, TI shall not be liable for any defects that result from User's design, specifications or instructions for such EVMs. Testing and other quality control techniques are used to the extent TI deems necessary or as mandated by government requirements. TI does not test all parameters of each EVM.
 - 2.3 If any EVM fails to conform to the warranty set forth above, TI's sole liability shall be at its option to repair or replace such EVM, or credit User's account for such EVM. TI's liability under this warranty shall be limited to EVMs that are returned during the warranty period to the address designated by TI and that are determined by TI not to conform to such warranty. If TI elects to repair or replace such EVM, TI shall have a reasonable time to repair such EVM or provide replacements. Repaired EVMs shall be warranted for the remainder of the original warranty period. Replaced EVMs shall be warranted for a new full ninety (90) day warranty period.
3. *Regulatory Notices:*
 - 3.1 *United States*
 - 3.1.1 *Notice applicable to EVMs not FCC-Approved:*

This kit is designed to allow product developers to evaluate electronic components, circuitry, or software associated with the kit to determine whether to incorporate such items in a finished product and software developers to write software applications for use with the end product. This kit is not a finished product and when assembled may not be resold or otherwise marketed unless all required FCC equipment authorizations are first obtained. Operation is subject to the condition that this product not cause harmful interference to licensed radio stations and that this product accept harmful interference. Unless the assembled kit is designed to operate under part 15, part 18 or part 95 of this chapter, the operator of the kit must operate under the authority of an FCC license holder or must secure an experimental authorization under part 5 of this chapter.
 - 3.1.2 *For EVMs annotated as FCC – FEDERAL COMMUNICATIONS COMMISSION Part 15 Compliant:*

CAUTION

This device complies with part 15 of the FCC Rules. Operation is subject to the following two conditions: (1) This device may not cause harmful interference, and (2) this device must accept any interference received, including interference that may cause undesired operation.

Changes or modifications not expressly approved by the party responsible for compliance could void the user's authority to operate the equipment.

FCC Interference Statement for Class A EVM devices

NOTE: This equipment has been tested and found to comply with the limits for a Class A digital device, pursuant to part 15 of the FCC Rules. These limits are designed to provide reasonable protection against harmful interference when the equipment is operated in a commercial environment. This equipment generates, uses, and can radiate radio frequency energy and, if not installed and used in accordance with the instruction manual, may cause harmful interference to radio communications. Operation of this equipment in a residential area is likely to cause harmful interference in which case the user will be required to correct the interference at his own expense.

FCC Interference Statement for Class B EVM devices

NOTE: This equipment has been tested and found to comply with the limits for a Class B digital device, pursuant to part 15 of the FCC Rules. These limits are designed to provide reasonable protection against harmful interference in a residential installation. This equipment generates, uses and can radiate radio frequency energy and, if not installed and used in accordance with the instructions, may cause harmful interference to radio communications. However, there is no guarantee that interference will not occur in a particular installation. If this equipment does cause harmful interference to radio or television reception, which can be determined by turning the equipment off and on, the user is encouraged to try to correct the interference by one or more of the following measures:

- Reorient or relocate the receiving antenna.
- Increase the separation between the equipment and receiver.
- Connect the equipment into an outlet on a circuit different from that to which the receiver is connected.
- Consult the dealer or an experienced radio/TV technician for help.

3.2 Canada

3.2.1 For EVMs issued with an Industry Canada Certificate of Conformance to RSS-210

Concerning EVMs Including Radio Transmitters:

This device complies with Industry Canada license-exempt RSS standard(s). Operation is subject to the following two conditions: (1) this device may not cause interference, and (2) this device must accept any interference, including interference that may cause undesired operation of the device.

Concernant les EVMs avec appareils radio:

Le présent appareil est conforme aux CNR d'Industrie Canada applicables aux appareils radio exempts de licence. L'exploitation est autorisée aux deux conditions suivantes: (1) l'appareil ne doit pas produire de brouillage, et (2) l'utilisateur de l'appareil doit accepter tout brouillage radioélectrique subi, même si le brouillage est susceptible d'en compromettre le fonctionnement.

Concerning EVMs Including Detachable Antennas:

Under Industry Canada regulations, this radio transmitter may only operate using an antenna of a type and maximum (or lesser) gain approved for the transmitter by Industry Canada. To reduce potential radio interference to other users, the antenna type and its gain should be so chosen that the equivalent isotropically radiated power (e.i.r.p.) is not more than that necessary for successful communication. This radio transmitter has been approved by Industry Canada to operate with the antenna types listed in the user guide with the maximum permissible gain and required antenna impedance for each antenna type indicated. Antenna types not included in this list, having a gain greater than the maximum gain indicated for that type, are strictly prohibited for use with this device.

Concernant les EVMs avec antennes détachables

Conformément à la réglementation d'Industrie Canada, le présent émetteur radio peut fonctionner avec une antenne d'un type et d'un gain maximal (ou inférieur) approuvé pour l'émetteur par Industrie Canada. Dans le but de réduire les risques de brouillage radioélectrique à l'intention des autres utilisateurs, il faut choisir le type d'antenne et son gain de sorte que la puissance isotrope rayonnée équivalente (p.i.r.e.) ne dépasse pas l'intensité nécessaire à l'établissement d'une communication satisfaisante. Le présent émetteur radio a été approuvé par Industrie Canada pour fonctionner avec les types d'antenne énumérés dans le manuel d'usage et ayant un gain admissible maximal et l'impédance requise pour chaque type d'antenne. Les types d'antenne non inclus dans cette liste, ou dont le gain est supérieur au gain maximal indiqué, sont strictement interdits pour l'exploitation de l'émetteur.

3.3 Japan

3.3.1 *Notice for EVMs delivered in Japan:* Please see http://www.tij.co.jp/lstds/ti_ja/general/eStore/notice_01.page 日本国内に輸入される評価用キット、ボードについては、次のところをご覧ください。
http://www.tij.co.jp/lstds/ti_ja/general/eStore/notice_01.page

3.3.2 *Notice for Users of EVMs Considered "Radio Frequency Products" in Japan:* EVMs entering Japan may not be certified by TI as conforming to Technical Regulations of Radio Law of Japan.

If User uses EVMs in Japan, not certified to Technical Regulations of Radio Law of Japan, User is required by Radio Law of Japan to follow the instructions below with respect to EVMs:

1. Use EVMs in a shielded room or any other test facility as defined in the notification #173 issued by Ministry of Internal Affairs and Communications on March 28, 2006, based on Sub-section 1.1 of Article 6 of the Ministry's Rule for Enforcement of Radio Law of Japan,
2. Use EVMs only after User obtains the license of Test Radio Station as provided in Radio Law of Japan with respect to EVMs, or
3. Use of EVMs only after User obtains the Technical Regulations Conformity Certification as provided in Radio Law of Japan with respect to EVMs. Also, do not transfer EVMs, unless User gives the same notice above to the transferee. Please note that if User does not follow the instructions above, User will be subject to penalties of Radio Law of Japan.

【無線電波を送信する製品の開発キットをお使いになる際の注意事項】 開発キットの中には技術基準適合証明を受けていないものがあります。技術適合証明を受けていないものご使用に際しては、電波法遵守のため、以下のいずれかの措置を取っていただく必要がありますのでご注意ください。

1. 電波法施行規則第6条第1項第1号に基づく平成18年3月28日総務省告示第173号で定められた電波暗室等の試験設備でご使用いただく。
2. 実験局の免許を取得後ご使用いただく。
3. 技術基準適合証明を取得後ご使用いただく。

なお、本製品は、上記の「ご使用にあたっての注意」を譲渡先、移転先に通知しない限り、譲渡、移転できないものとします。

上記を遵守頂けない場合は、電波法の罰則が適用される可能性があることをご留意ください。日本テキサス・インスツルメンツ株式会社
東京都新宿区西新宿 6 丁目 2 4 番 1 号
西新宿三井ビル

3.3.3 *Notice for EVMs for Power Line Communication:* Please see http://www.tij.co.jp/lstds/ti_ja/general/eStore/notice_02.page
電力線搬送波通信についての開発キットをお使いになる際の注意事項については、次のところをご覧ください。 http://www.tij.co.jp/lstds/ti_ja/general/eStore/notice_02.page

4 *EVM Use Restrictions and Warnings:*

4.1 EVMS ARE NOT FOR USE IN FUNCTIONAL SAFETY AND/OR SAFETY CRITICAL EVALUATIONS, INCLUDING BUT NOT LIMITED TO EVALUATIONS OF LIFE SUPPORT APPLICATIONS.

4.2 User must read and apply the user guide and other available documentation provided by TI regarding the EVM prior to handling or using the EVM, including without limitation any warning or restriction notices. The notices contain important safety information related to, for example, temperatures and voltages.

4.3 *Safety-Related Warnings and Restrictions:*

4.3.1 User shall operate the EVM within TI's recommended specifications and environmental considerations stated in the user guide, other available documentation provided by TI, and any other applicable requirements and employ reasonable and customary safeguards. Exceeding the specified performance ratings and specifications (including but not limited to input and output voltage, current, power, and environmental ranges) for the EVM may cause personal injury or death, or property damage. If there are questions concerning performance ratings and specifications, User should contact a TI field representative prior to connecting interface electronics including input power and intended loads. Any loads applied outside of the specified output range may also result in unintended and/or inaccurate operation and/or possible permanent damage to the EVM and/or interface electronics. Please consult the EVM user guide prior to connecting any load to the EVM output. If there is uncertainty as to the load specification, please contact a TI field representative. During normal operation, even with the inputs and outputs kept within the specified allowable ranges, some circuit components may have elevated case temperatures. These components include but are not limited to linear regulators, switching transistors, pass transistors, current sense resistors, and heat sinks, which can be identified using the information in the associated documentation. When working with the EVM, please be aware that the EVM may become very warm.

4.3.2 EVMs are intended solely for use by technically qualified, professional electronics experts who are familiar with the dangers and application risks associated with handling electrical mechanical components, systems, and subsystems. User assumes all responsibility and liability for proper and safe handling and use of the EVM by User or its employees, affiliates, contractors or designees. User assumes all responsibility and liability to ensure that any interfaces (electronic and/or mechanical) between the EVM and any human body are designed with suitable isolation and means to safely limit accessible leakage currents to minimize the risk of electrical shock hazard. User assumes all responsibility and liability for any improper or unsafe handling or use of the EVM by User or its employees, affiliates, contractors or designees.

4.4 User assumes all responsibility and liability to determine whether the EVM is subject to any applicable international, federal, state, or local laws and regulations related to User's handling and use of the EVM and, if applicable, User assumes all responsibility and liability for compliance in all respects with such laws and regulations. User assumes all responsibility and liability for proper disposal and recycling of the EVM consistent with all applicable international, federal, state, and local requirements.

5. *Accuracy of Information:* To the extent TI provides information on the availability and function of EVMs, TI attempts to be as accurate as possible. However, TI does not warrant the accuracy of EVM descriptions, EVM availability or other information on its websites as accurate, complete, reliable, current, or error-free.

6. *Disclaimers:*

6.1 EXCEPT AS SET FORTH ABOVE, EVMS AND ANY WRITTEN DESIGN MATERIALS PROVIDED WITH THE EVM (AND THE DESIGN OF THE EVM ITSELF) ARE PROVIDED "AS IS" AND "WITH ALL FAULTS." TI DISCLAIMS ALL OTHER WARRANTIES, EXPRESS OR IMPLIED, REGARDING SUCH ITEMS, INCLUDING BUT NOT LIMITED TO ANY IMPLIED WARRANTIES OF MERCHANTABILITY OR FITNESS FOR A PARTICULAR PURPOSE OR NON-INFRINGEMENT OF ANY THIRD PARTY PATENTS, COPYRIGHTS, TRADE SECRETS OR OTHER INTELLECTUAL PROPERTY RIGHTS.

6.2 EXCEPT FOR THE LIMITED RIGHT TO USE THE EVM SET FORTH HEREIN, NOTHING IN THESE TERMS AND CONDITIONS SHALL BE CONSTRUED AS GRANTING OR CONFERRING ANY RIGHTS BY LICENSE, PATENT, OR ANY OTHER INDUSTRIAL OR INTELLECTUAL PROPERTY RIGHT OF TI, ITS SUPPLIERS/LICENSORS OR ANY OTHER THIRD PARTY, TO USE THE EVM IN ANY FINISHED END-USER OR READY-TO-USE FINAL PRODUCT, OR FOR ANY INVENTION, DISCOVERY OR IMPROVEMENT MADE, CONCEIVED OR ACQUIRED PRIOR TO OR AFTER DELIVERY OF THE EVM.

7. *USER'S INDEMNITY OBLIGATIONS AND REPRESENTATIONS.* USER WILL DEFEND, INDEMNIFY AND HOLD TI, ITS LICENSORS AND THEIR REPRESENTATIVES HARMLESS FROM AND AGAINST ANY AND ALL CLAIMS, DAMAGES, LOSSES, EXPENSES, COSTS AND LIABILITIES (COLLECTIVELY, "CLAIMS") ARISING OUT OF OR IN CONNECTION WITH ANY HANDLING OR USE OF THE EVM THAT IS NOT IN ACCORDANCE WITH THESE TERMS AND CONDITIONS. THIS OBLIGATION SHALL APPLY WHETHER CLAIMS ARISE UNDER STATUTE, REGULATION, OR THE LAW OF TORT, CONTRACT OR ANY OTHER LEGAL THEORY, AND EVEN IF THE EVM FAILS TO PERFORM AS DESCRIBED OR EXPECTED.

8. *Limitations on Damages and Liability:*

8.1 *General Limitations.* IN NO EVENT SHALL TI BE LIABLE FOR ANY SPECIAL, COLLATERAL, INDIRECT, PUNITIVE, INCIDENTAL, CONSEQUENTIAL, OR EXEMPLARY DAMAGES IN CONNECTION WITH OR ARISING OUT OF THESE TERMS AND CONDITIONS OR THE USE OF THE EVMS PROVIDED HEREUNDER, REGARDLESS OF WHETHER TI HAS BEEN ADVISED OF THE POSSIBILITY OF SUCH DAMAGES. EXCLUDED DAMAGES INCLUDE, BUT ARE NOT LIMITED TO, COST OF REMOVAL OR REINSTALLATION, ANCILLARY COSTS TO THE PROCUREMENT OF SUBSTITUTE GOODS OR SERVICES, RETESTING, OUTSIDE COMPUTER TIME, LABOR COSTS, LOSS OF GOODWILL, LOSS OF PROFITS, LOSS OF SAVINGS, LOSS OF USE, LOSS OF DATA, OR BUSINESS INTERRUPTION. NO CLAIM, SUIT OR ACTION SHALL BE BROUGHT AGAINST TI MORE THAN ONE YEAR AFTER THE RELATED CAUSE OF ACTION HAS OCCURRED.

8.2 *Specific Limitations.* IN NO EVENT SHALL TI'S AGGREGATE LIABILITY FROM ANY WARRANTY OR OTHER OBLIGATION ARISING OUT OF OR IN CONNECTION WITH THESE TERMS AND CONDITIONS, OR ANY USE OF ANY TI EVM PROVIDED HEREUNDER, EXCEED THE TOTAL AMOUNT PAID TO TI FOR THE PARTICULAR UNITS SOLD UNDER THESE TERMS AND CONDITIONS WITH RESPECT TO WHICH LOSSES OR DAMAGES ARE CLAIMED. THE EXISTENCE OF MORE THAN ONE CLAIM AGAINST THE PARTICULAR UNITS SOLD TO USER UNDER THESE TERMS AND CONDITIONS SHALL NOT ENLARGE OR EXTEND THIS LIMIT.

9. *Return Policy.* Except as otherwise provided, TI does not offer any refunds, returns, or exchanges. Furthermore, no return of EVM(s) will be accepted if the package has been opened and no return of the EVM(s) will be accepted if they are damaged or otherwise not in a resalable condition. If User feels it has been incorrectly charged for the EVM(s) it ordered or that delivery violates the applicable order, User should contact TI. All refunds will be made in full within thirty (30) working days from the return of the components(s), excluding any postage or packaging costs.

10. *Governing Law:* These terms and conditions shall be governed by and interpreted in accordance with the laws of the State of Texas, without reference to conflict-of-laws principles. User agrees that non-exclusive jurisdiction for any dispute arising out of or relating to these terms and conditions lies within courts located in the State of Texas and consents to venue in Dallas County, Texas. Notwithstanding the foregoing, any judgment may be enforced in any United States or foreign court, and TI may seek injunctive relief in any United States or foreign court.

Mailing Address: Texas Instruments, Post Office Box 655303, Dallas, Texas 75265
Copyright © 2016, Texas Instruments Incorporated

IMPORTANT NOTICE

Texas Instruments Incorporated and its subsidiaries (TI) reserve the right to make corrections, enhancements, improvements and other changes to its semiconductor products and services per JESD46, latest issue, and to discontinue any product or service per JESD48, latest issue. Buyers should obtain the latest relevant information before placing orders and should verify that such information is current and complete. All semiconductor products (also referred to herein as "components") are sold subject to TI's terms and conditions of sale supplied at the time of order acknowledgment.

TI warrants performance of its components to the specifications applicable at the time of sale, in accordance with the warranty in TI's terms and conditions of sale of semiconductor products. Testing and other quality control techniques are used to the extent TI deems necessary to support this warranty. Except where mandated by applicable law, testing of all parameters of each component is not necessarily performed.

TI assumes no liability for applications assistance or the design of Buyers' products. Buyers are responsible for their products and applications using TI components. To minimize the risks associated with Buyers' products and applications, Buyers should provide adequate design and operating safeguards.

TI does not warrant or represent that any license, either express or implied, is granted under any patent right, copyright, mask work right, or other intellectual property right relating to any combination, machine, or process in which TI components or services are used. Information published by TI regarding third-party products or services does not constitute a license to use such products or services or a warranty or endorsement thereof. Use of such information may require a license from a third party under the patents or other intellectual property of the third party, or a license from TI under the patents or other intellectual property of TI.

Reproduction of significant portions of TI information in TI data books or data sheets is permissible only if reproduction is without alteration and is accompanied by all associated warranties, conditions, limitations, and notices. TI is not responsible or liable for such altered documentation. Information of third parties may be subject to additional restrictions.

Resale of TI components or services with statements different from or beyond the parameters stated by TI for that component or service voids all express and any implied warranties for the associated TI component or service and is an unfair and deceptive business practice. TI is not responsible or liable for any such statements.

Buyer acknowledges and agrees that it is solely responsible for compliance with all legal, regulatory and safety-related requirements concerning its products, and any use of TI components in its applications, notwithstanding any applications-related information or support that may be provided by TI. Buyer represents and agrees that it has all the necessary expertise to create and implement safeguards which anticipate dangerous consequences of failures, monitor failures and their consequences, lessen the likelihood of failures that might cause harm and take appropriate remedial actions. Buyer will fully indemnify TI and its representatives against any damages arising out of the use of any TI components in safety-critical applications.

In some cases, TI components may be promoted specifically to facilitate safety-related applications. With such components, TI's goal is to help enable customers to design and create their own end-product solutions that meet applicable functional safety standards and requirements. Nonetheless, such components are subject to these terms.

No TI components are authorized for use in FDA Class III (or similar life-critical medical equipment) unless authorized officers of the parties have executed a special agreement specifically governing such use.

Only those TI components which TI has specifically designated as military grade or "enhanced plastic" are designed and intended for use in military/aerospace applications or environments. Buyer acknowledges and agrees that any military or aerospace use of TI components which have **not** been so designated is solely at the Buyer's risk, and that Buyer is solely responsible for compliance with all legal and regulatory requirements in connection with such use.

TI has specifically designated certain components as meeting ISO/TS16949 requirements, mainly for automotive use. In any case of use of non-designated products, TI will not be responsible for any failure to meet ISO/TS16949.

Products

Audio	www.ti.com/audio
Amplifiers	amplifier.ti.com
Data Converters	dataconverter.ti.com
DLP® Products	www.dlp.com
DSP	dsp.ti.com
Clocks and Timers	www.ti.com/clocks
Interface	interface.ti.com
Logic	logic.ti.com
Power Mgmt	power.ti.com
Microcontrollers	microcontroller.ti.com
RFID	www.ti-rfid.com
OMAP Applications Processors	www.ti.com/omap
Wireless Connectivity	www.ti.com/wirelessconnectivity

Applications

Automotive and Transportation	www.ti.com/automotive
Communications and Telecom	www.ti.com/communications
Computers and Peripherals	www.ti.com/computers
Consumer Electronics	www.ti.com/consumer-apps
Energy and Lighting	www.ti.com/energy
Industrial	www.ti.com/industrial
Medical	www.ti.com/medical
Security	www.ti.com/security
Space, Avionics and Defense	www.ti.com/space-avionics-defense
Video and Imaging	www.ti.com/video

TI E2E Community

e2e.ti.com