

## CSD17552Q3A 30 V N-Channel NexFET™ Power MOSFETs

### 1 Features

- Ultra-Low  $Q_g$  and  $Q_{gd}$
- Low Thermal Resistance
- Avalanche Rated
- Pb Free
- RoHS Compliant
- Halogen Free
- SON 3.3 mm × 3.3 mm Plastic Package

### 2 Applications

- Point-of-Load Synchronous Buck in Networking, Telecom, and Computing Systems
- Optimized for Control FET Applications

### 3 Description

This 30 V, 5.5 mΩ, 3.3 mm × 3.3 mm SON NexFET™ power MOSFET is designed to minimize losses in power conversion applications.

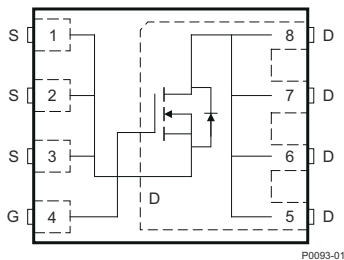

Top View

### Product Summary

$T_A = 25^\circ\text{C}$		TYPICAL VALUE		UNIT
$V_{DS}$	Drain-to-Source Voltage	30		V
$Q_g$	Gate Charge Total (4.5 V)	9.0		nC
$Q_{gd}$	Gate Charge Gate-to-Drain	2.3		nC
$R_{DS(on)}$	Drain-to-Source On Resistance	$V_{GS} = 4.5\text{ V}$	6.5	mΩ
		$V_{GS} = 10\text{ V}$	5.5	mΩ
$V_{GS(th)}$	Threshold Voltage	1.5		V

### Ordering Information<sup>(1)</sup>

DEVICE	QTY	MEDIA	PACKAGE	SHIP
CSD17552Q3A	2500	13-Inch Reel	SON 3.3 mm × 3.3 mm Plastic Package	Tape and Reel
CSD17552Q3AT	250	7-Inch Reel		

- (1) For all available packages, see the orderable addendum at the end of the data sheet.

### Absolute Maximum Ratings

$T_A = 25^\circ\text{C}$ unless otherwise stated		VALUE	UNIT
$V_{DS}$	Drain-to-Source Voltage	30	V
$V_{GS}$	Gate-to-Source Voltage	±20	V
$I_D$	Continuous Drain Current, $T_C = 25^\circ\text{C}$	60	A
	Continuous Drain Current, Silicon Limited	74	A
	Continuous Drain Current, $T_A = 25^\circ\text{C}$ <sup>(1)</sup>	15	A
$I_{DM}$	Pulsed Drain Current, $T_A = 25^\circ\text{C}$ <sup>(2)</sup>	84	A
$P_D$	Power Dissipation <sup>(1)</sup>	2.6	W
$T_J$ , $T_{stg}$	Operating Junction Temperature, Storage Temperature	–55 to 150	°C
$E_{AS}$	Avalanche Energy, single pulse $I_D = 30\text{ A}$ , $L = 0.1\text{ mH}$ , $R_G = 25\ \Omega$	45	mJ

- (1) Typical  $R_{\theta JA} = 48^\circ\text{C/W}$  on a 1 inch<sup>2</sup> (6.45 cm<sup>2</sup>), 2 oz. (0.071 mm thick) Cu pad on a 0.06 inch (1.52 mm) thick FR4 PCB.
- (2) Pulse duration ≤300 μs, duty cycle ≤2%

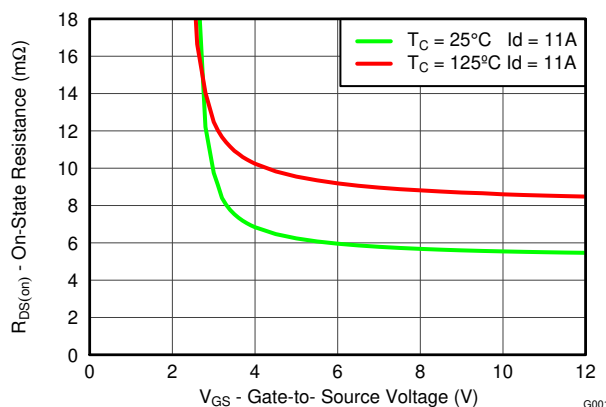

$R_{DS(on)}$  vs  $V_{GS}$

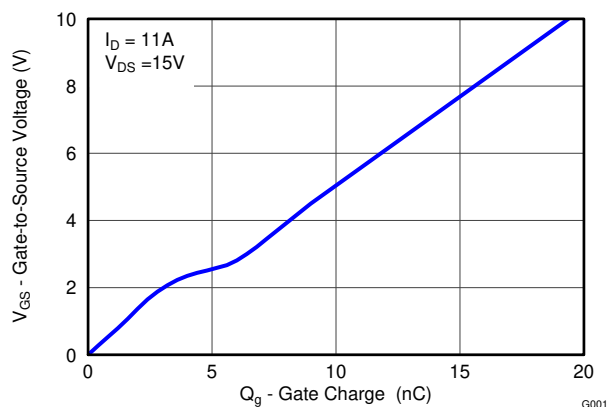

Gate Charge



## Table of Contents

<b>1 Features</b> .....	<b>1</b>	<b>5 Device and Documentation Support</b> .....	<b>7</b>
<b>2 Applications</b> .....	<b>1</b>	5.1 Support Resources.....	7
<b>3 Description</b> .....	<b>1</b>	5.2 Trademarks.....	7
<b>4 Specifications</b> .....	<b>3</b>	5.3 Electrostatic Discharge Caution.....	7
4.1 Electrical Characteristics.....	3	5.4 Glossary.....	7
4.2 Thermal Information.....	3	<b>6 Revision History</b> .....	<b>7</b>
4.3 Typical MOSFET Characteristics.....	4	<b>7 Mechanical, Packaging, and Orderable Information</b> ....	<b>7</b>

---

## 4 Specifications

### 4.1 Electrical Characteristics

(T<sub>A</sub> = 25°C unless otherwise stated)

PARAMETER		TEST CONDITIONS	MIN	TYP	MAX	UNIT
<b>STATIC CHARACTERISTICS</b>						
BV <sub>DSS</sub>	Drain-to-source voltage	V <sub>GS</sub> = 0 V, I <sub>D</sub> = 250 μA	30			V
I <sub>DSS</sub>	Drain-to-source leakage current	V <sub>GS</sub> = 0 V, V <sub>DS</sub> = 24 V			1	μA
I <sub>GSS</sub>	Gate-to-source leakage current	V <sub>DS</sub> = 0 V, V <sub>GS</sub> = 20 V			100	nA
V <sub>GS(th)</sub>	Gate-to-source threshold voltage	V <sub>DS</sub> = V <sub>GS</sub> , I <sub>D</sub> = 250 μA	1.1	1.5	1.9	V
R <sub>DS(on)</sub>	Drain-to-source on resistance	V <sub>GS</sub> = 4.5 V, I <sub>D</sub> = 11 A		6.5	8.1	mΩ
		V <sub>GS</sub> = 10 V, I <sub>D</sub> = 11 A		5.5	6.0	mΩ
g <sub>fs</sub>	Transconductance	V <sub>DS</sub> = 15 V, I <sub>D</sub> = 11 A		106		S
<b>DYNAMIC CHARACTERISTICS</b>						
C <sub>iss</sub>	Input capacitance	V <sub>GS</sub> = 0 V, V <sub>DS</sub> = 15 V, f = 1 MHz		1580	2050	pF
C <sub>oss</sub>	Output capacitance			385	500	pF
C <sub>rss</sub>	Reverse transfer capacitance			28	36	pF
R <sub>G</sub>	Series gate resistance			.9	1.8	Ω
Q <sub>g</sub>	Gate charge total (4.5 V)	V <sub>DS</sub> = 15 V, I <sub>D</sub> = 11 A		9	12	nC
Q <sub>gd</sub>	Gate charge gate to drain			2.3		nC
Q <sub>gs</sub>	Gate charge gate to source			3.6		nC
Q <sub>g(th)</sub>	Gate charge at V <sub>th</sub>			1.8		nC
Q <sub>oss</sub>	Output charge	V <sub>DS</sub> = 15 V, V <sub>GS</sub> = 0 V		11		nC
t <sub>d(on)</sub>	Turn on delay time	V <sub>DS</sub> = 15 V, V <sub>GS</sub> = 4.5 V, I <sub>DS</sub> = 11 A, R <sub>G</sub> = 2 Ω		7.2		ns
t <sub>r</sub>	Rise time			7.4		ns
t <sub>d(off)</sub>	Turn off delay time			11.0		ns
t <sub>f</sub>	Fall time			3.4		ns
<b>DIODE CHARACTERISTICS</b>						
V <sub>SD</sub>	Diode forward voltage	I <sub>SD</sub> = 11 A, V <sub>GS</sub> = 0 V		0.8	1	V
Q <sub>rr</sub>	Reverse recovery charge	V <sub>DS</sub> = 13.5 V, I <sub>F</sub> = 11 A, di/dt = 300 A/μs		17		nC
t <sub>rr</sub>	Reverse recovery time			15		ns

### 4.2 Thermal Information

(T<sub>A</sub> = 25°C unless otherwise stated)

THERMAL METRIC		MIN	TYP	MAX	UNIT
R <sub>θJC</sub>	Junction-to-case thermal resistance <sup>(1)</sup>			2.3	°C/W
R <sub>θJA</sub>	Junction-to-ambient thermal resistance <sup>(1) (2)</sup>			60	°C/W

- (1) R<sub>θJC</sub> is determined with the device mounted on a 1 inch<sup>2</sup> (6.45 cm<sup>2</sup>), 2 oz. (0.071 mm thick) Cu pad on a 1.5 inches × 1.5 inches (3.81 cm × 3.81 cm), 0.06 inch (1.52 mm) thick FR4 PCB. R<sub>θJC</sub> is specified by design, whereas R<sub>θJA</sub> is determined by the user's board design.
- (2) Device mounted on FR4 material with 1 inch<sup>2</sup> (6.45 cm<sup>2</sup>), 2 oz. (0.071 mm thick) Cu.

**CSD17552Q3A**

SLPS387C – JANUARY 2016 – REVISED NOVEMBER 2023

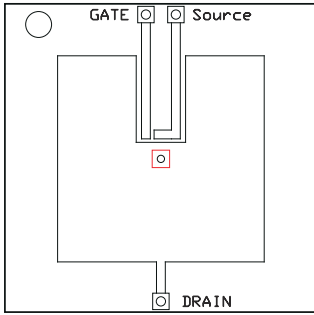

M0161-01

Max  $R_{\theta JA} = 60^{\circ}\text{C/W}$  when mounted on 1 inch<sup>2</sup> (6.45 cm<sup>2</sup>) of 2 oz. (0.071 mm thick) Cu.

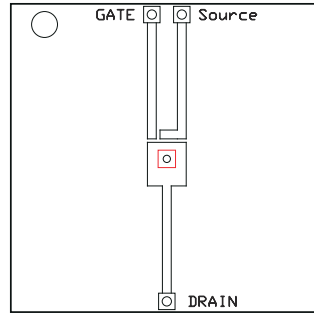

M0161-02

Max  $R_{\theta JA} = 146^{\circ}\text{C/W}$  when mounted on a minimum pad area of 2 oz. (0.071 mm thick) Cu.

**4.3 Typical MOSFET Characteristics**

( $T_A = 25^{\circ}\text{C}$  unless otherwise stated)

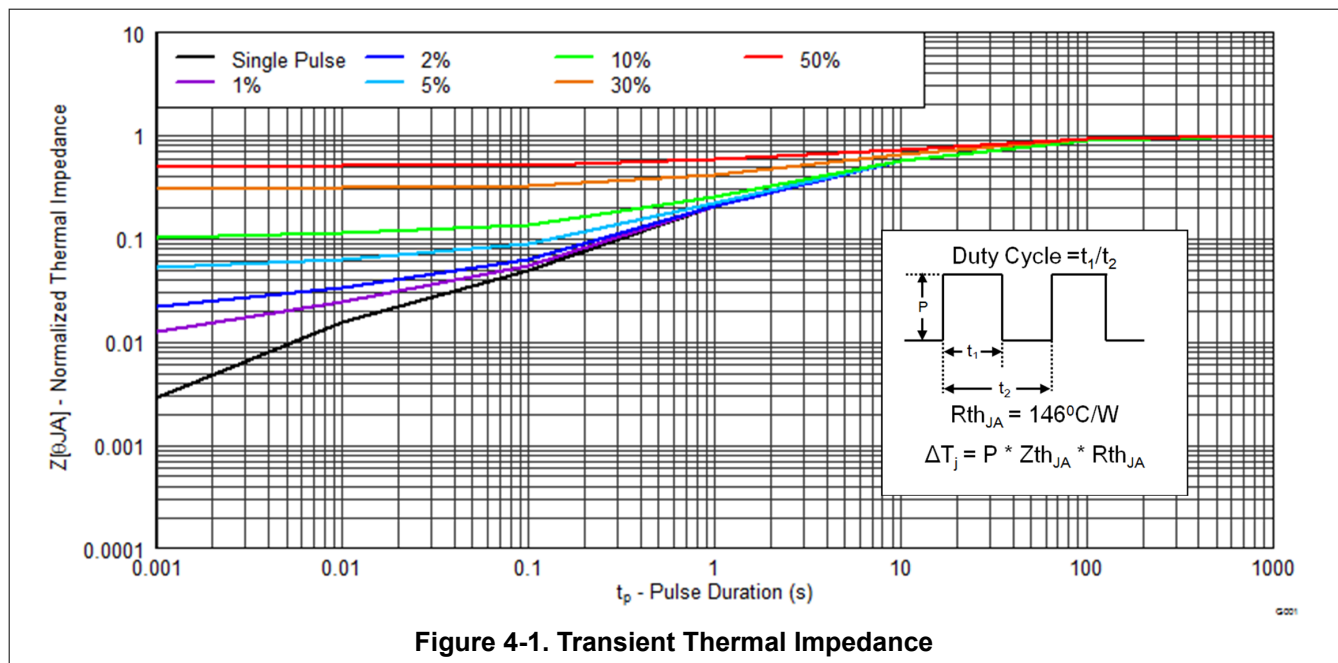

**Figure 4-1. Transient Thermal Impedance**

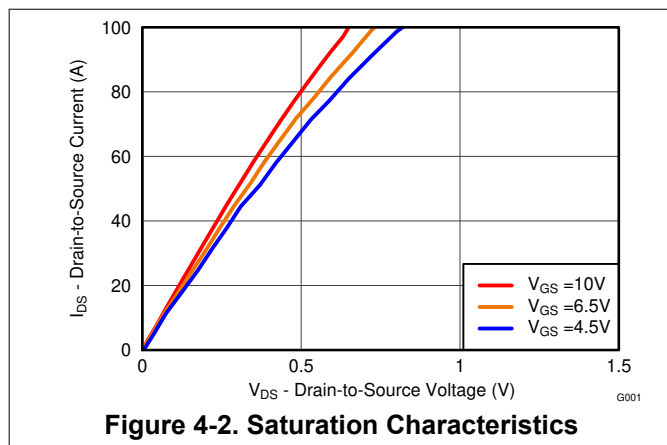

**Figure 4-2. Saturation Characteristics**

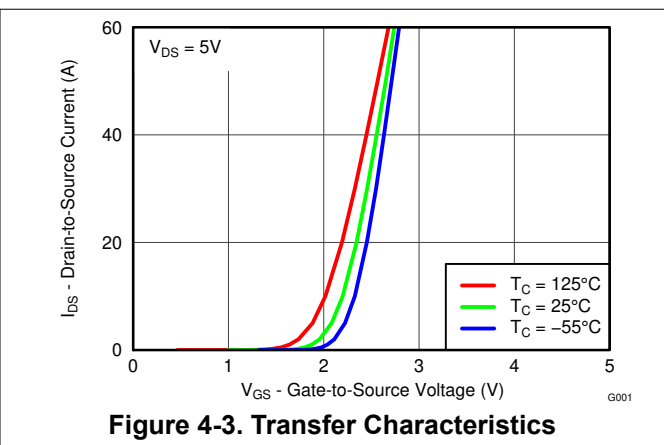

**Figure 4-3. Transfer Characteristics**

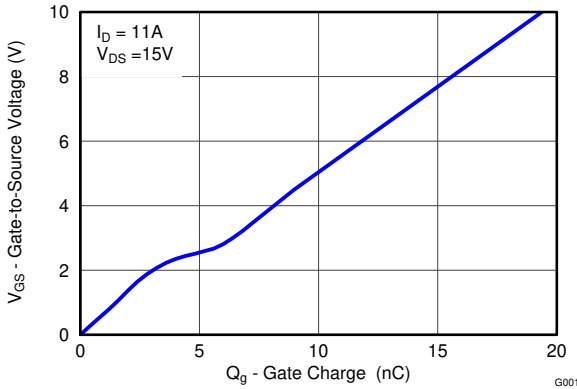

**Figure 4-4. Gate Charge**

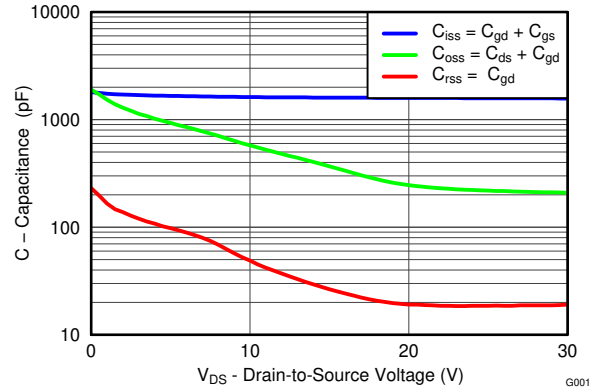

**Figure 4-5. Capacitance**

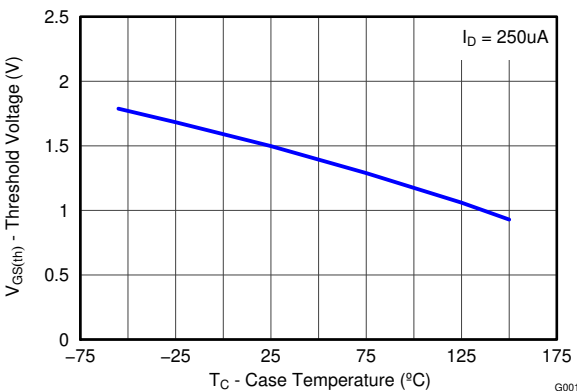

**Figure 4-6. Threshold Voltage vs Temperature**

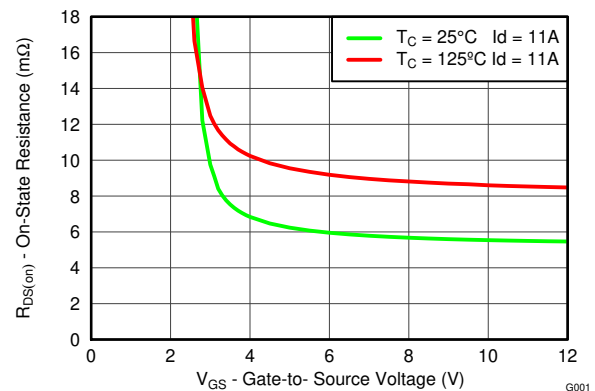

**Figure 4-7. On-State Resistance vs Gate-to-Source Voltage**

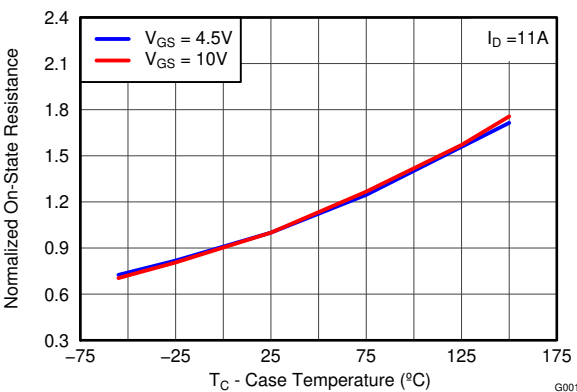

**Figure 4-8. Normalized On-State Resistance vs Temperature**

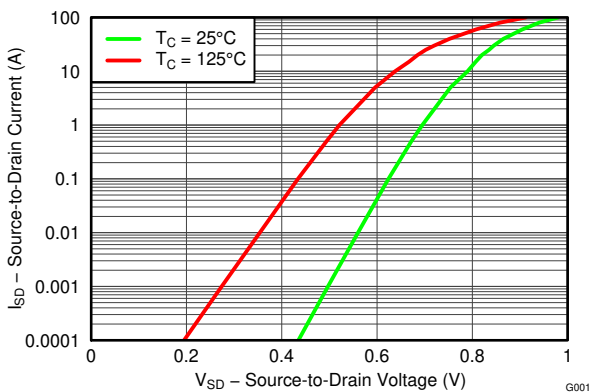

**Figure 4-9. Typical Diode Forward Voltage**

**CSD17552Q3A**

SLPS387C – JANUARY 2016 – REVISED NOVEMBER 2023

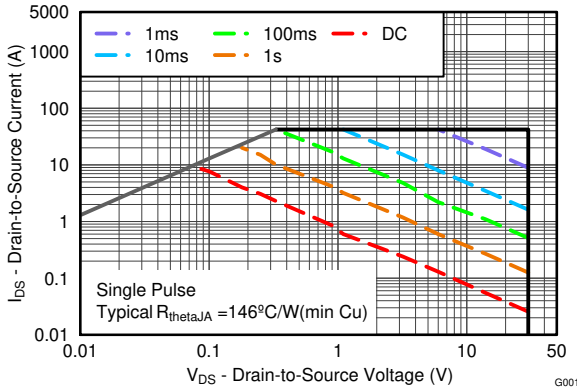

**Figure 4-10. Maximum Safe Operating Area**

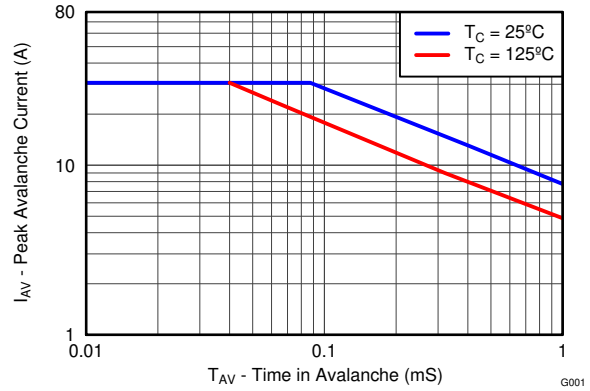

**Figure 4-11. Single Pulse Unclamped Inductive Switching**

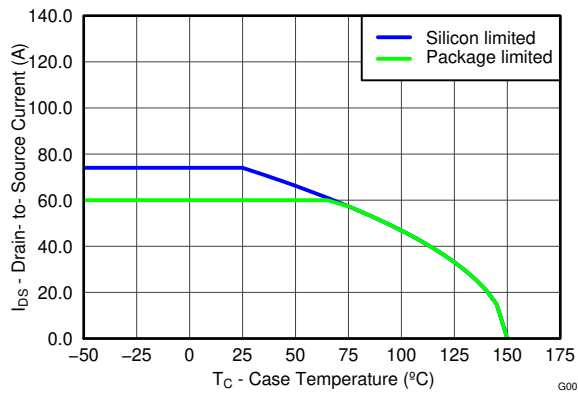

**Figure 4-12. Maximum Drain Current vs Temperature**

## 5 Device and Documentation Support

### 5.1 Support Resources

[TI E2E™ support forums](#) are an engineer's go-to source for fast, verified answers and design help — straight from the experts. Search existing answers or ask your own question to get the quick design help you need.

Linked content is provided "AS IS" by the respective contributors. They do not constitute TI specifications and do not necessarily reflect TI's views; see TI's [Terms of Use](#).

### 5.2 Trademarks

NexFET™ and TI E2E™ are trademarks of Texas Instruments.  
All trademarks are the property of their respective owners.

### 5.3 Electrostatic Discharge Caution



This integrated circuit can be damaged by ESD. Texas Instruments recommends that all integrated circuits be handled with appropriate precautions. Failure to observe proper handling and installation procedures can cause damage.

ESD damage can range from subtle performance degradation to complete device failure. Precision integrated circuits may be more susceptible to damage because very small parametric changes could cause the device not to meet its published specifications.

### 5.4 Glossary

[TI Glossary](#) This glossary lists and explains terms, acronyms, and definitions.

## 6 Revision History

NOTE: Page numbers for previous revisions may differ from page numbers in the current version.

<b>Changes from Revision B (January 2016) to Revision C (November 2023)</b>	<b>Page</b>
• Updated formatting for tables, figures, and cross-references throughout the document .....	<b>1</b>
<b>Changes from Revision A (June 2014) to Revision B (January 2016)</b>	<b>Page</b>
• Enhanced <a href="#">Section 3</a> text .....	<b>1</b>
<b>Changes from Revision * (September 2012) to Revision A (June 2014)</b>	<b>Page</b>
• Changed "Pb-Free terminal plating" feature to state "Pb Free" .....	<b>1</b>

## 7 Mechanical, Packaging, and Orderable Information

The following pages include mechanical packaging and orderable information. This information is the most current data available for the designated devices. This data is subject to change without notice and revision of this document. For browser-based versions of this data sheet, refer to the left-hand navigation.

**PACKAGING INFORMATION**

Orderable Device	Status (1)	Package Type	Package Drawing	Pins	Package Qty	Eco Plan (2)	Lead finish/ Ball material (6)	MSL Peak Temp (3)	Op Temp (°C)	Device Marking (4/5)	Samples
CSD17552Q3A	ACTIVE	VSONP	DNH	8	2500	RoHS & Green	SN	Level-1-260C-UNLIM	-55 to 150	17552	Samples

(1) The marketing status values are defined as follows:

**ACTIVE:** Product device recommended for new designs.

**LIFEBUY:** TI has announced that the device will be discontinued, and a lifetime-buy period is in effect.

**NRND:** Not recommended for new designs. Device is in production to support existing customers, but TI does not recommend using this part in a new design.

**PREVIEW:** Device has been announced but is not in production. Samples may or may not be available.

**OBSOLETE:** TI has discontinued the production of the device.

(2) **RoHS:** TI defines "RoHS" to mean semiconductor products that are compliant with the current EU RoHS requirements for all 10 RoHS substances, including the requirement that RoHS substance do not exceed 0.1% by weight in homogeneous materials. Where designed to be soldered at high temperatures, "RoHS" products are suitable for use in specified lead-free processes. TI may reference these types of products as "Pb-Free".

**RoHS Exempt:** TI defines "RoHS Exempt" to mean products that contain lead but are compliant with EU RoHS pursuant to a specific EU RoHS exemption.

**Green:** TI defines "Green" to mean the content of Chlorine (Cl) and Bromine (Br) based flame retardants meet JS709B low halogen requirements of <=1000ppm threshold. Antimony trioxide based flame retardants must also meet the <=1000ppm threshold requirement.

(3) MSL, Peak Temp. - The Moisture Sensitivity Level rating according to the JEDEC industry standard classifications, and peak solder temperature.

(4) There may be additional marking, which relates to the logo, the lot trace code information, or the environmental category on the device.

(5) Multiple Device Markings will be inside parentheses. Only one Device Marking contained in parentheses and separated by a "~" will appear on a device. If a line is indented then it is a continuation of the previous line and the two combined represent the entire Device Marking for that device.

(6) Lead finish/Ball material - Orderable Devices may have multiple material finish options. Finish options are separated by a vertical ruled line. Lead finish/Ball material values may wrap to two lines if the finish value exceeds the maximum column width.

**Important Information and Disclaimer:** The information provided on this page represents TI's knowledge and belief as of the date that it is provided. TI bases its knowledge and belief on information provided by third parties, and makes no representation or warranty as to the accuracy of such information. Efforts are underway to better integrate information from third parties. TI has taken and continues to take reasonable steps to provide representative and accurate information but may not have conducted destructive testing or chemical analysis on incoming materials and chemicals. TI and TI suppliers consider certain information to be proprietary, and thus CAS numbers and other limited information may not be available for release.

In no event shall TI's liability arising out of such information exceed the total purchase price of the TI part(s) at issue in this document sold by TI to Customer on an annual basis.



**TAPE AND REEL INFORMATION**

**QUADRANT ASSIGNMENTS FOR PIN 1 ORIENTATION IN TAPE**

\*All dimensions are nominal

Device	Package Type	Package Drawing	Pins	SPQ	Reel Diameter (mm)	Reel Width W1 (mm)	A0 (mm)	B0 (mm)	K0 (mm)	P1 (mm)	W (mm)	Pin1 Quadrant
CSD17552Q3A	VSONP	DNH	8	2500	330.0	12.4	3.6	3.6	1.1	8.0	12.0	Q1

**TAPE AND REEL BOX DIMENSIONS**

\*All dimensions are nominal

Device	Package Type	Package Drawing	Pins	SPQ	Length (mm)	Width (mm)	Height (mm)
CSD1752Q3A	VSONP	DNH	8	2500	340.0	340.0	38.0

# DNH0008A



# PACKAGE OUTLINE

## VSONP - 0.9 mm max height

PLASTIC SMALL OUTLINE - NO LEAD

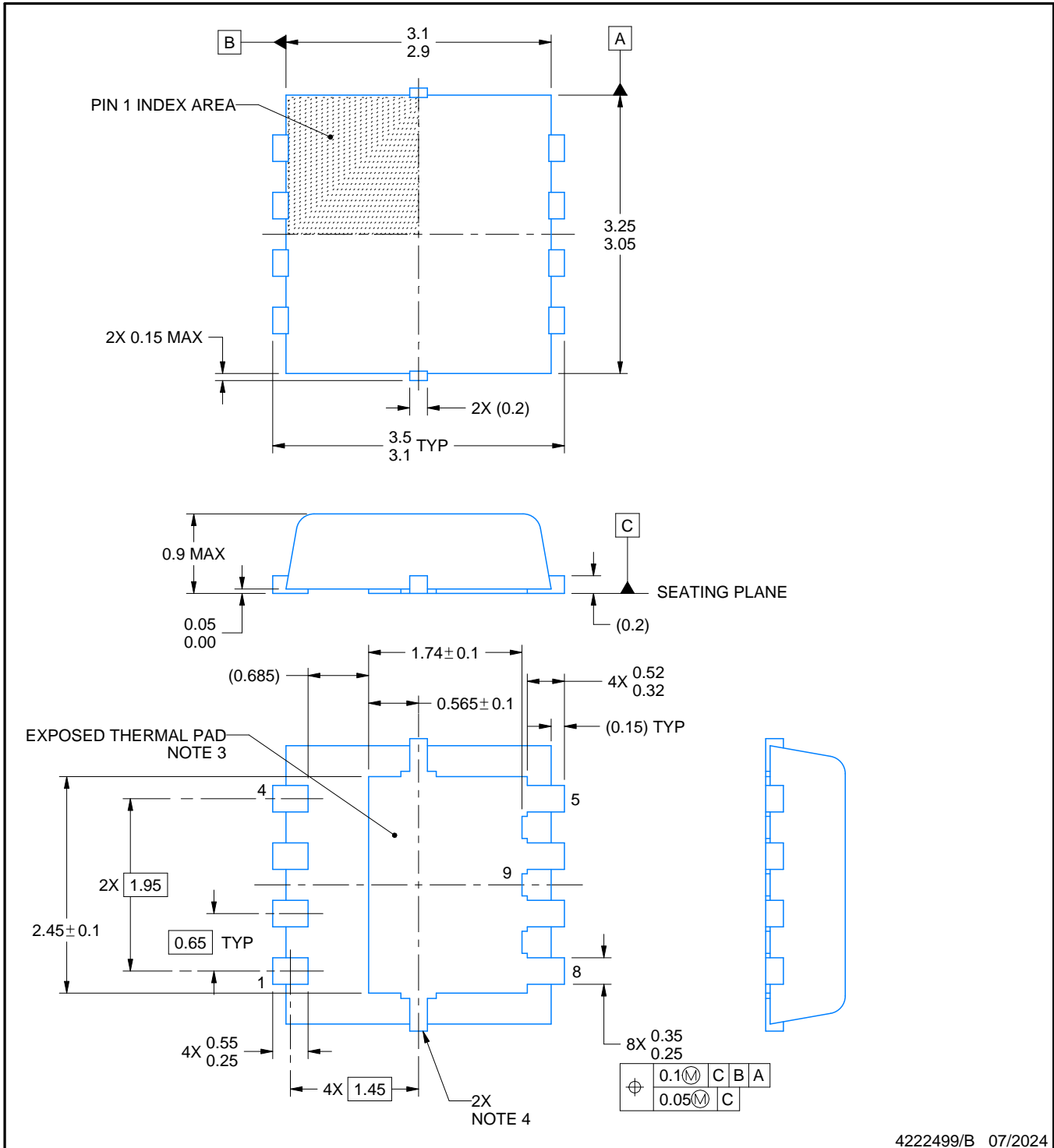

4222499/B 07/2024

### NOTES:

1. All linear dimensions are in millimeters. Any dimensions in parenthesis are for reference only. Dimensioning and tolerancing per ASME Y14.5M.
2. This drawing is subject to change without notice.
3. The package thermal pad must be soldered to the printed circuit board for thermal and mechanical performance.
4. Metalized features are supplier options and may not be on the package.
5. All dimensions do not include mold flash or protrusions.



# EXAMPLE STENCIL DESIGN

DNH0008A

VSONP - 0.9 mm max height

PLASTIC SMALL OUTLINE - NO LEAD

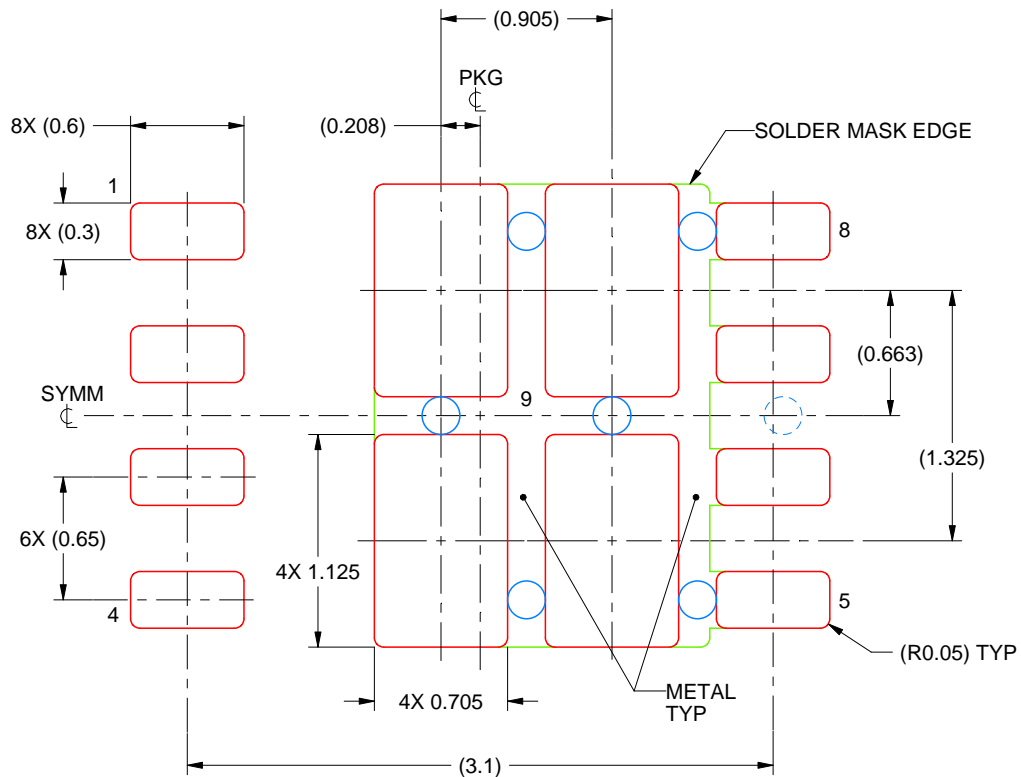

SOLDER PASTE EXAMPLE  
BASED ON 0.125 mm THICK STENCIL

EXPOSED PAD 9:  
76% PRINTED SOLDER COVERAGE BY AREA UNDER PACKAGE  
SCALE: 25X

4222499/B 07/2024

NOTES: (continued)

8. Laser cutting apertures with trapezoidal walls and rounded corners may offer better paste release. IPC-7525 may have alternate design recommendations.

## IMPORTANT NOTICE AND DISCLAIMER

TI PROVIDES TECHNICAL AND RELIABILITY DATA (INCLUDING DATA SHEETS), DESIGN RESOURCES (INCLUDING REFERENCE DESIGNS), APPLICATION OR OTHER DESIGN ADVICE, WEB TOOLS, SAFETY INFORMATION, AND OTHER RESOURCES "AS IS" AND WITH ALL FAULTS, AND DISCLAIMS ALL WARRANTIES, EXPRESS AND IMPLIED, INCLUDING WITHOUT LIMITATION ANY IMPLIED WARRANTIES OF MERCHANTABILITY, FITNESS FOR A PARTICULAR PURPOSE OR NON-INFRINGEMENT OF THIRD PARTY INTELLECTUAL PROPERTY RIGHTS.

These resources are intended for skilled developers designing with TI products. You are solely responsible for (1) selecting the appropriate TI products for your application, (2) designing, validating and testing your application, and (3) ensuring your application meets applicable standards, and any other safety, security, regulatory or other requirements.

These resources are subject to change without notice. TI grants you permission to use these resources only for development of an application that uses the TI products described in the resource. Other reproduction and display of these resources is prohibited. No license is granted to any other TI intellectual property right or to any third party intellectual property right. TI disclaims responsibility for, and you will fully indemnify TI and its representatives against, any claims, damages, costs, losses, and liabilities arising out of your use of these resources.

TI's products are provided subject to [TI's Terms of Sale](#) or other applicable terms available either on [ti.com](https://www.ti.com) or provided in conjunction with such TI products. TI's provision of these resources does not expand or otherwise alter TI's applicable warranties or warranty disclaimers for TI products.

TI objects to and rejects any additional or different terms you may have proposed.

Mailing Address: Texas Instruments, Post Office Box 655303, Dallas, Texas 75265  
Copyright © 2024, Texas Instruments Incorporated