

DS10BR150 1.0 Gbps LVDS Buffer / Repeater

Check for Samples: [DS10BR150](#)

FEATURES

- DC - 1.0 Gbps Low Jitter, High Noise Immunity, Low Power Operation
- On-chip 100Ω Input and Output Termination Minimizes Insertion and Return Losses, Reduces Component Count and Minimizes Board Space
- 7 kV ESD on LVDS I/O Pins Protects Adjoining Components
- Small 3 mm x 3 mm 8-WSO Space Saving Package

APPLICATIONS

- Clock and Data Buffering
- OC-12 / STM-4
- FireWire 800

Typical Application

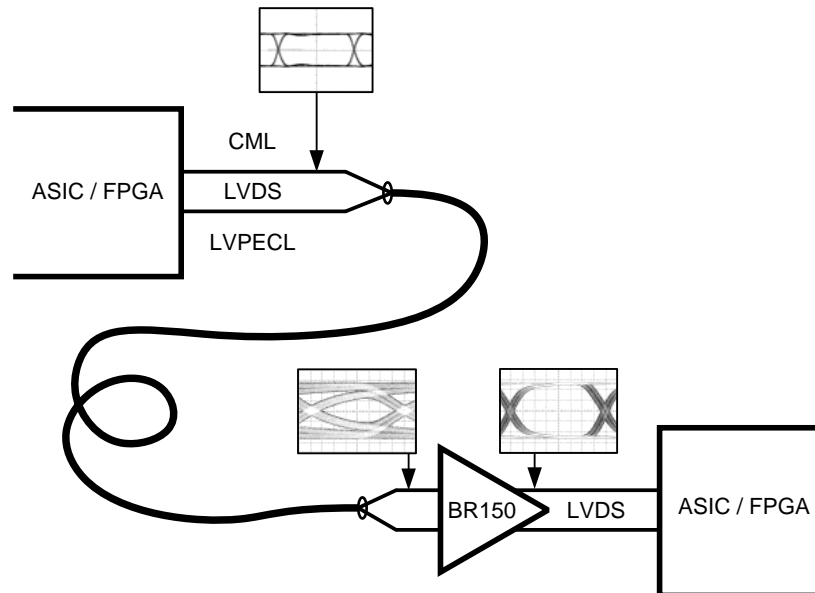

DESCRIPTION

The DS10BR150 is a single channel 1.0 Gbps LVDS buffer optimized for high-speed signal transmission over lossy FR-4 printed circuit board backplanes and balanced cables. Fully differential signal paths ensure exceptional signal integrity and noise immunity.

Wide input common mode range allows the receiver to accept signals with LVDS, CML and LVPECL levels; the output levels are LVDS. A very small package footprint requires a minimal space on the board while the flow-through pinout allows easy board layout. The differential inputs and outputs are internally terminated with a 100Ω resistor to lower device input and output return losses, reduce component count and further minimize board space.



Please be aware that an important notice concerning availability, standard warranty, and use in critical applications of Texas Instruments semiconductor products and disclaimers thereto appears at the end of this data sheet.

All trademarks are the property of their respective owners.

Block Diagram

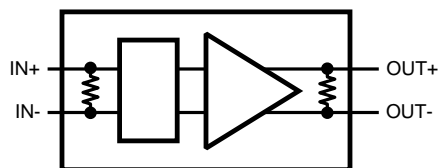

Pin Diagram

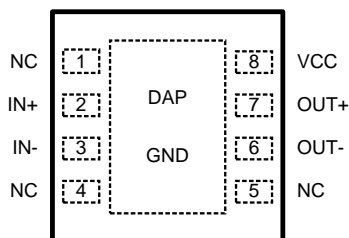

DS10BR150
See Package Number NGQ0008A

PIN DESCRIPTIONS

Pin Name	Pin Name	Pin Type	Pin Description
NC	1	NA	"NO CONNECT" pin.
IN+	2	Input	Non-inverting LVDS input pin.
IN-	3	Input	Inverting LVDS input pin.
NC	4	NA	"NO CONNECT" pin.
NC	5	NA	"NO CONNECT" pin.
OUT-	6	Output	Inverting LVDS output pin.
OUT+	7	Output	Non-inverting LVDS Output pin.
VCC	8	Power	Power supply pin.
GND	DAP	Power	Ground pad (DAP - die attach pad)



These devices have limited built-in ESD protection. The leads should be shorted together or the device placed in conductive foam during storage or handling to prevent electrostatic damage to the MOS gates.

Absolute Maximum Ratings ⁽¹⁾⁽²⁾

Supply Voltage (V_{CC})	-0.3V to +4V
LVDS Input Voltage (IN+, IN-)	-0.3V to +4V
Differential Input Voltage VID	1V
LVDS Output Voltage (OUT+, OUT-)	-0.3V to ($V_{CC} + 0.3V$)
LVDS Differential Output Voltage ((OUT+) - (OUT-))	0V to 1V
LVDS Output Short Circuit Current Duration	5 ms
Junction Temperature	+150°C
Storage Temperature Range	-65°C to +150°C
Lead Temperature Range	
Soldering (4 sec.)	+260°C
Maximum Package Power Dissipation at 25°C	
NGQ Package	2.08W
Derate NGQ Package	16.7 mW/°C above +25°C
Package Thermal Resistance	
θ_{JA}	+60.0°C/W
θ_{JC}	+12.3°C/W
ESD Susceptibility	
HBM ⁽³⁾	≥7 kV
MM ⁽⁴⁾	≥250V
CDM ⁽⁵⁾	≥1250V

- (1) Absolute Maximum Ratings indicate limits beyond which damage to the device may occur, including inoperability and degradation of device reliability and/or performance. Functional operation of the device and/or non-degradation at the Absolute Maximum Ratings or other conditions beyond those indicated in the Recommended Operating Conditions is not implied. The Recommended Operating Conditions indicate conditions at which the device is functional and the device should not be operated beyond such conditions.
- (2) If Military/Aerospace specified devices are required, please contact the Texas Instruments Sales Office/ Distributors for availability and specifications.
- (3) Human Body Model, applicable std. JESD22-A114C
- (4) Machine Model, applicable std. JESD22-A115-A
- (5) Field Induced Charge Device Model, applicable std. JESD22-C101-C

Recommended Operating Conditions

	Min	Typ	Max	Units
Supply Voltage (V_{CC})	3.0	3.3	3.6	V
Receiver Differential Input Voltage (V_{ID})	0		1	V
Operating Free Air Temperature (T_A)	-40	+25	+85	°C

DC Electrical Characteristics

Over recommended operating supply and temperature ranges unless otherwise specified. ⁽¹⁾⁽²⁾⁽³⁾

Symbol	Parameter	Conditions	Min	Typ	Max	Units	
LVDS OUTPUT DC SPECIFICATIONS (OUT+, OUT-)							
V_{OD}	Differential Output Voltage	$R_L = 100\Omega$	250	350	450	mV	
ΔV_{OD}	Change in Magnitude of V_{OD} for Complimentary Output States		-35		35	mV	
V_{OS}	Offset Voltage	$R_L = 100\Omega$	1.05	1.2	1.375	V	
ΔV_{OS}	Change in Magnitude of V_{OS} for Complimentary Output States		-35		35	mV	
I_{OS}	Output Short Circuit Current ⁽⁴⁾	OUT to GND		-30	-50	mA	
		OUT to V_{CC}		7.5	50	mA	
C_{OUT}	Output Capacitance	Any LVDS Output Pin to GND		1.2		pF	
R_{OUT}	Output Termination Resistor	Between OUT+ and OUT- Pins		100		Ω	
LVDS INPUT DC SPECIFICATIONS (IN+, IN-)							
V_{ID}	Input Differential Voltage	$V_{CM} = +0.05V$ or $V_{CC}-0.05V$	0		1	V	
V_{TH}	Differential Input High Threshold				0	+100	mV
V_{TL}	Differential Input Low Threshold			-100	0		mV
V_{CMR}	Common Mode Voltage Range	$V_{ID} = 100$ mV	0.05		$V_{CC} - 0.05$	V	
I_{IN}	Input Current	$V_{IN} = 3.6V$ or $0V$ $V_{CC} = 3.6V$ or $0V$		± 1	± 10	μA	
C_{IN}	Input Capacitance			1.7		pF	
R_{IN}	Input Termination Resistor	Between IN+ and IN- Pins		100		Ω	
SUPPLY CURRENT							
I_{CCD}	Total Supply Current			16	21	mA	

- (1) The [Electrical Characteristics](#) tables list ensured specifications under the listed Recommended Operating Conditions except as otherwise modified or specified by the Electrical Characteristics Conditions and/or Notes. Typical specifications are estimations only and are not ensured.
- (2) Current into device pins is defined as positive. Current out of device pins is defined as negative. All voltages are referenced to ground except V_{OD} and ΔV_{OD} .
- (3) Typical values represent most likely parametric norms for $V_{CC} = +3.3V$ and $T_A = +25^\circ C$, and at the Recommended Operation Conditions at the time of product characterization and are not ensured.
- (4) Output short circuit current (I_{OS}) is specified as magnitude only, minus sign indicates direction only.

AC Electrical Characteristics ⁽¹⁾

Over recommended operating supply and temperature ranges unless otherwise specified. ⁽²⁾⁽³⁾

Symbol	Parameter	Conditions	Min	Typ	Max	Units	
LVDS OUTPUT AC SPECIFICATIONS (OUT+, OUT-)							
t_{PHLD2}	Differential Propagation Delay High to Low	$R_L = 100\Omega$		380	600	ps	
t_{PLHD2}	Differential Propagation Delay Low to High			410	600	ps	
t_{SKD1}	Pulse Skew $ t_{PLHD} - t_{PHLD} $ ⁽⁴⁾			30	150	ps	
t_{SKD2}	Part to Part Skew ⁽⁵⁾			45	160	ps	
t_{LHT}	Rise Time	$R_L = 100\Omega$		165	400	ps	
t_{HLT}	Fall Time			155	400	ps	
JITTER PERFORMANCE Figure 5							
t_{DJ}	Deterministic Jitter (Peak-to-Peak Value) (See ⁽⁶⁾)	$V_{ID} = 350\text{ mV}$ $V_{CM} = 1.2\text{V}$ K28.5 (NRZ)	622 Mbps		12	39	ps
			1.06 Gbps		15	42	ps
t_{RJ}	Random Jitter (RMS Value) ⁽⁷⁾	$V_{ID} = 350\text{ mV}$ $V_{CM} = 1.2\text{V}$ Clock (NRZ)	311 MHz		0.6	1.3	ps
			503 MHz		0.6	1.1	ps
t_{TJ}	Total Jitter (Peak to Peak Value) ⁽⁸⁾	$V_{ID} = 350\text{ mV}$ $V_{CM} = 1.2\text{V}$ PRBS-23 (NRZ)	622 Mbps		0.02	0.04	UI _{p-p}
			1.06 Gbps		0.02	0.05	UI _{p-p}

- (1) Specification is ensured by characterization and is not tested in production.
- (2) The [Electrical Characteristics](#) tables list ensured specifications under the listed Recommended Operating Conditions except as otherwise modified or specified by the Electrical Characteristics Conditions and/or Notes. Typical specifications are estimations only and are not ensured.
- (3) Typical values represent most likely parametric norms for $V_{CC} = +3.3\text{V}$ and $T_A = +25^\circ\text{C}$, and at the Recommended Operation Conditions at the time of product characterization and are not ensured.
- (4) t_{SKD1} , $|t_{PLHD} - t_{PHLD}|$, is the magnitude difference in differential propagation delay time between the positive going edge and the negative going edge of the same channel.
- (5) t_{SKD2} , Part to Part Skew, is defined as the difference between the minimum and maximum specified differential propagation delays. This specification applies to devices at the same V_{CC} and within 5°C of each other within the operating temperature range.
- (6) Tested with a combination of the 1100000101 (K28.5+ character) and 0011111010 (K28.5- character) patterns. Input stimulus jitter is subtracted algebraically.
- (7) Measured on a clock edge with a histogram and an accumulation of 1500 histogram hits. Input stimulus jitter is subtracted geometrically.
- (8) Measured on an eye diagram with a histogram and an accumulation of 3500 histogram hits. Input stimulus jitter is subtracted.

DC Test Circuits

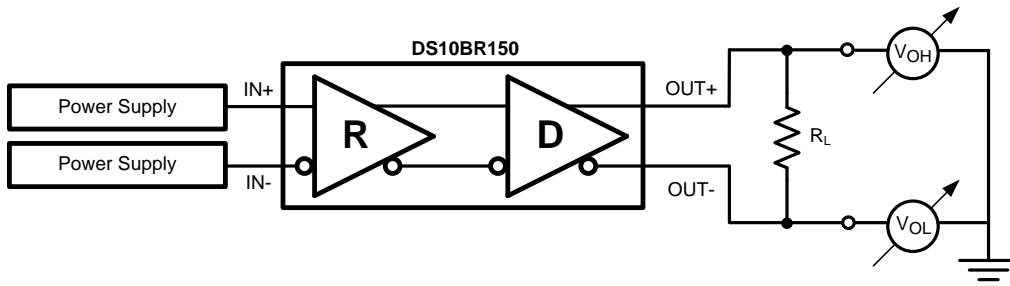

Figure 1. Differential Driver DC Test Circuit

AC Test Circuits and Timing Diagrams

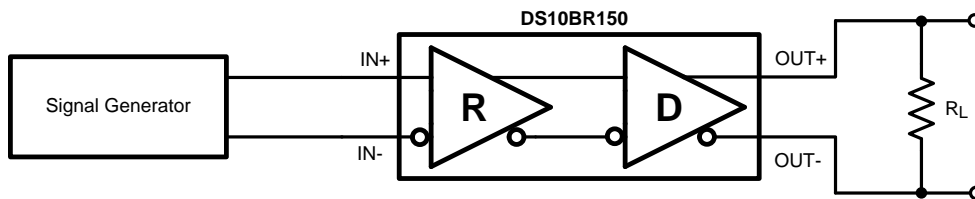

Figure 2. Differential Driver AC Test Circuit

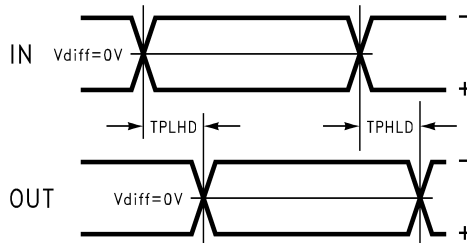

Figure 3. Propagation Delay Timing Diagram

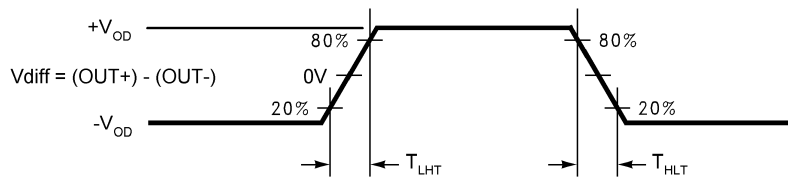

Figure 4. LVDS Output Transition Times

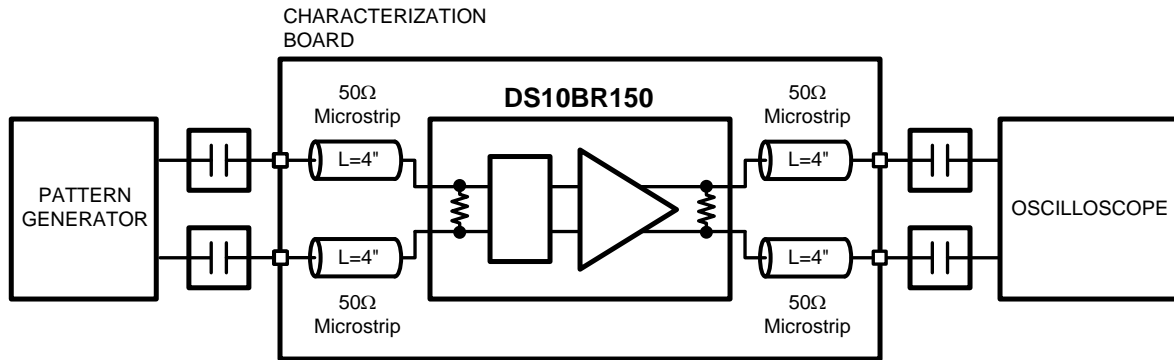

Figure 5. Jitter Measurements Test Circuit

DEVICE OPERATION

INPUT INTERFACING

The DS10BR150 accepts differential signals and allows simple AC or DC coupling. With a wide common mode range, the DS10BR150 can be DC-coupled with all common differential drivers (i.e. LVPECL, LVDS, CML). The following three figures illustrate typical DC-coupled interface to common differential drivers. Note that the DS10BR150 inputs are internally terminated with a 100Ω resistor.

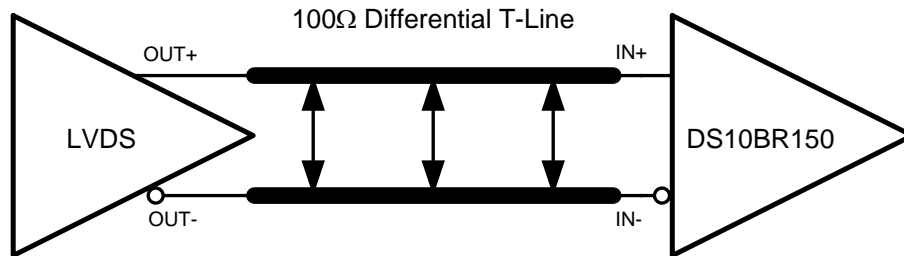

Figure 6. Typical LVDS Driver DC-Coupled Interface to DS10BR150 Input

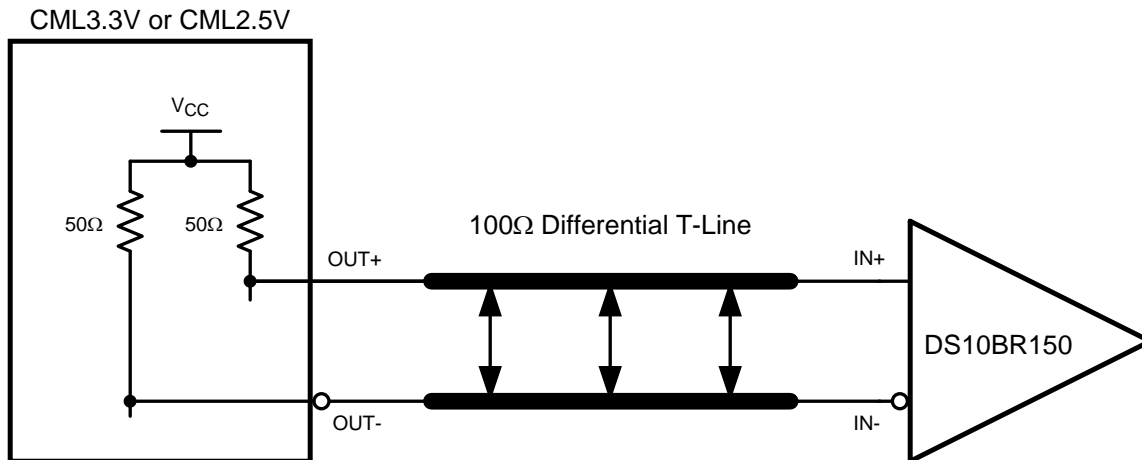

Figure 7. Typical CML Driver DC-Coupled Interface to DS10BR150 Input

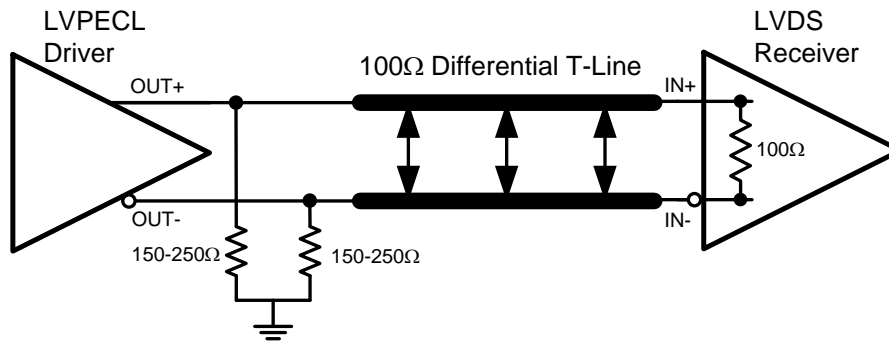

Figure 8. Typical LVPECL Driver DC-Coupled Interface to DS10BR150 Input

OUTPUT INTERFACING

The DS10BR150 outputs signals are compliant to the LVDS standard. It can be DC-coupled to most common differential receivers. The following figure illustrates typical DC-coupled interface to common differential receivers and assumes that the receivers have high impedance inputs. While most differential receivers have a common mode input range that can accommodate LVDS compliant signals, it is recommended to check respective receiver's data sheet prior to implementing the suggested interface implementation.

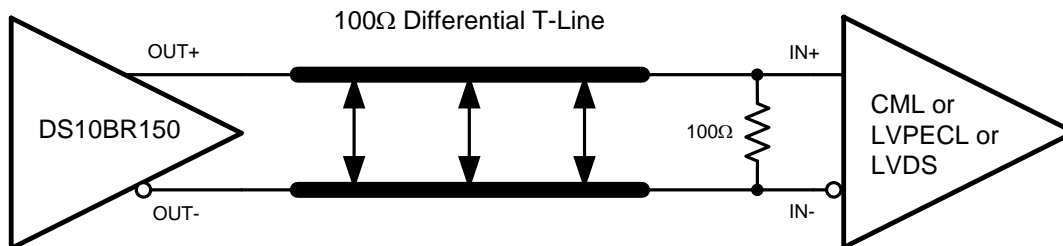

Figure 9. Typical DS10BR150 Output DC-Coupled Interface to an LVDS, CML or LVPECL Receiver

Typical Performance

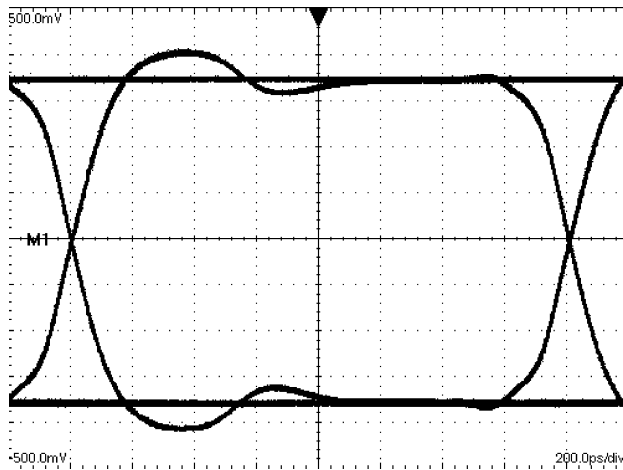

Figure 10. A 622 Mbps NRZ PRBS-7 Output Eye Diagram
V:100 mV / DIV, H:200 ps / DIV

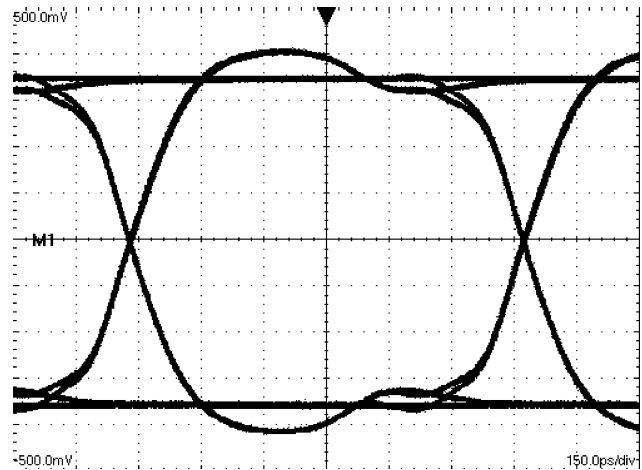

Figure 11. A 1062.5 Mbps NRZ PRBS-7 Output Eye Diagram
V:100 mV / DIV, H:150 ps / DIV

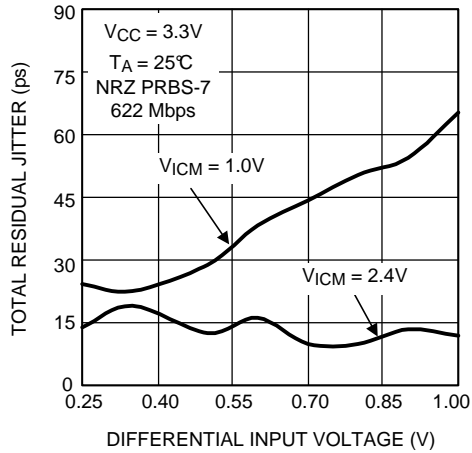

Figure 12. Total Jitter as a Function of Input Amplitude

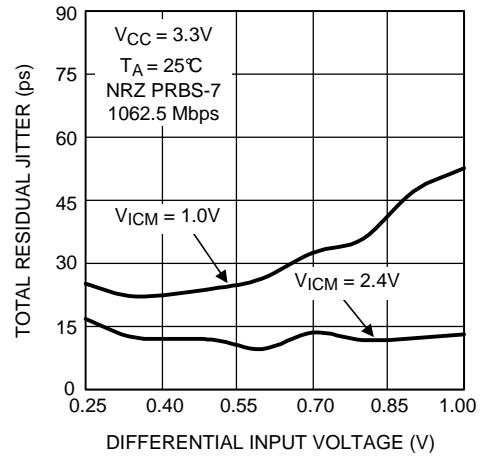

Figure 13. Total Jitter as a Function of Input Amplitude

REVISION HISTORY

Changes from Revision C (April 2013) to Revision D	Page
• Changed layout of National Data Sheet to TI format	9

PACKAGING INFORMATION

Orderable Device	Status (1)	Package Type	Package Drawing	Pins	Package Qty	Eco Plan (2)	Lead finish/ Ball material (6)	MSL Peak Temp (3)	Op Temp (°C)	Device Marking (4/5)	Samples
DS10BR150TSD/NOPB	ACTIVE	WSON	NGQ	8	1000	RoHS & Green	SN	Level-3-260C-168 HR	-40 to 85	1R150	Samples

(1) The marketing status values are defined as follows:

ACTIVE: Product device recommended for new designs.

LIFEBUY: TI has announced that the device will be discontinued, and a lifetime-buy period is in effect.

NRND: Not recommended for new designs. Device is in production to support existing customers, but TI does not recommend using this part in a new design.

PREVIEW: Device has been announced but is not in production. Samples may or may not be available.

OBSOLETE: TI has discontinued the production of the device.

(2) **RoHS:** TI defines "RoHS" to mean semiconductor products that are compliant with the current EU RoHS requirements for all 10 RoHS substances, including the requirement that RoHS substance do not exceed 0.1% by weight in homogeneous materials. Where designed to be soldered at high temperatures, "RoHS" products are suitable for use in specified lead-free processes. TI may reference these types of products as "Pb-Free".

RoHS Exempt: TI defines "RoHS Exempt" to mean products that contain lead but are compliant with EU RoHS pursuant to a specific EU RoHS exemption.

Green: TI defines "Green" to mean the content of Chlorine (Cl) and Bromine (Br) based flame retardants meet JS709B low halogen requirements of <=1000ppm threshold. Antimony trioxide based flame retardants must also meet the <=1000ppm threshold requirement.

(3) MSL, Peak Temp. - The Moisture Sensitivity Level rating according to the JEDEC industry standard classifications, and peak solder temperature.

(4) There may be additional marking, which relates to the logo, the lot trace code information, or the environmental category on the device.

(5) Multiple Device Markings will be inside parentheses. Only one Device Marking contained in parentheses and separated by a "-" will appear on a device. If a line is indented then it is a continuation of the previous line and the two combined represent the entire Device Marking for that device.

(6) Lead finish/Ball material - Orderable Devices may have multiple material finish options. Finish options are separated by a vertical ruled line. Lead finish/Ball material values may wrap to two lines if the finish value exceeds the maximum column width.

Important Information and Disclaimer:The information provided on this page represents TI's knowledge and belief as of the date that it is provided. TI bases its knowledge and belief on information provided by third parties, and makes no representation or warranty as to the accuracy of such information. Efforts are underway to better integrate information from third parties. TI has taken and continues to take reasonable steps to provide representative and accurate information but may not have conducted destructive testing or chemical analysis on incoming materials and chemicals. TI and TI suppliers consider certain information to be proprietary, and thus CAS numbers and other limited information may not be available for release.

In no event shall TI's liability arising out of such information exceed the total purchase price of the TI part(s) at issue in this document sold by TI to Customer on an annual basis.

TAPE AND REEL INFORMATION

QUADRANT ASSIGNMENTS FOR PIN 1 ORIENTATION IN TAPE



*All dimensions are nominal

Device	Package Type	Package Drawing	Pins	SPQ	Reel Diameter (mm)	Reel Width W1 (mm)	A0 (mm)	B0 (mm)	K0 (mm)	P1 (mm)	W (mm)	Pin1 Quadrant
DS10BR150TSD/NOPB	WSO8	NGQ	8	1000	178.0	12.4	3.3	3.3	1.0	8.0	12.0	Q1

TAPE AND REEL BOX DIMENSIONS

*All dimensions are nominal

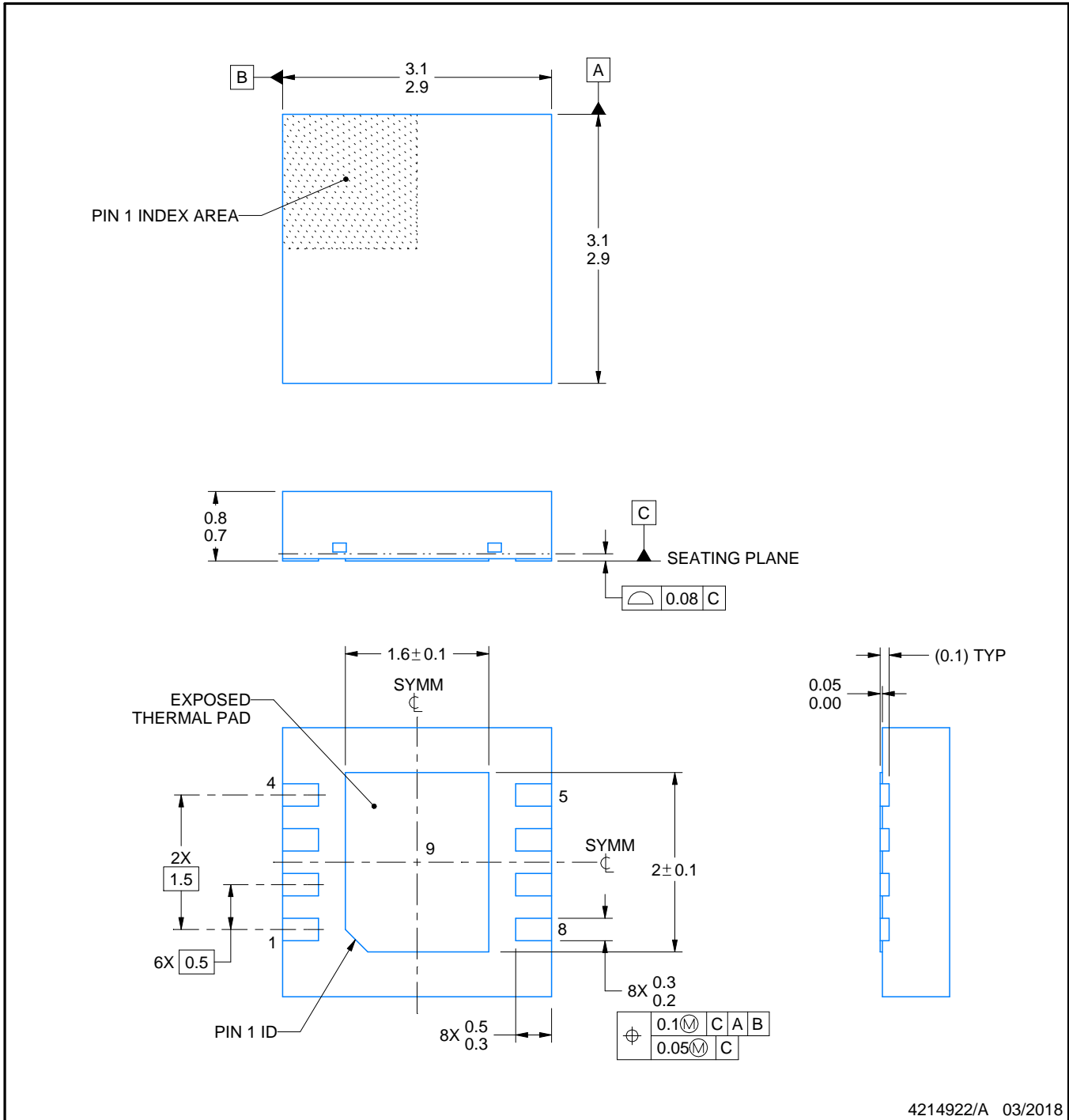
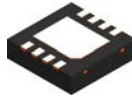
Device	Package Type	Package Drawing	Pins	SPQ	Length (mm)	Width (mm)	Height (mm)
DS10BR150TSD/NOPB	WSON	NGQ	8	1000	208.0	191.0	35.0



4214922/A 03/2018

NOTES:

1. All linear dimensions are in millimeters. Any dimensions in parenthesis are for reference only. Dimensioning and tolerancing per ASME Y14.5M.
2. This drawing is subject to change without notice.
3. The package thermal pad must be soldered to the printed circuit board for thermal and mechanical performance.

EXAMPLE BOARD LAYOUT

NGQ0008A

WSON - 0.8 mm max height

PLASTIC SMALL OUTLINE - NO LEAD

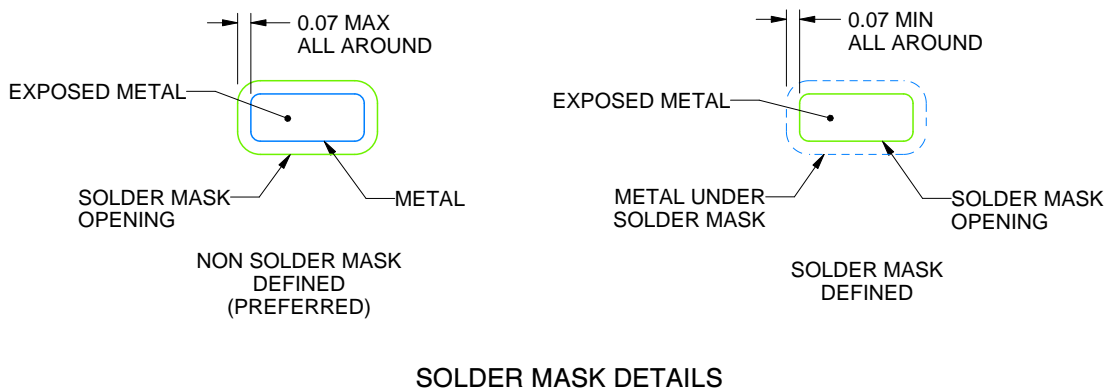
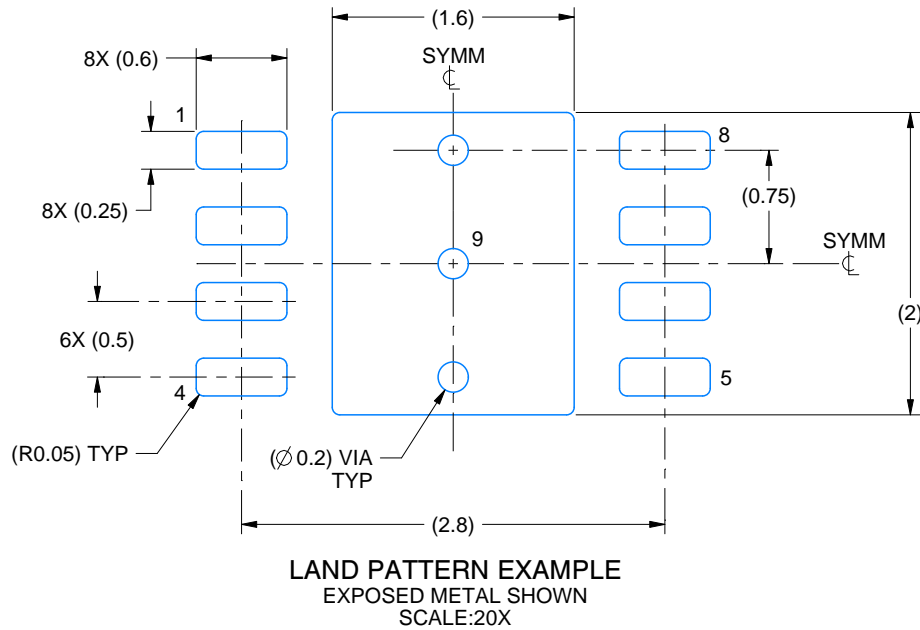

4214922/A 03/2018

NOTES: (continued)

4. This package is designed to be soldered to a thermal pad on the board. For more information, see Texas Instruments literature number SLUA271 (www.ti.com/lit/sluea271).
5. Vias are optional depending on application, refer to device data sheet. If any vias are implemented, refer to their locations shown on this view. It is recommended that vias under paste be filled, plugged or tented.

EXAMPLE STENCIL DESIGN

NGQ0008A

WSON - 0.8 mm max height

PLASTIC SMALL OUTLINE - NO LEAD

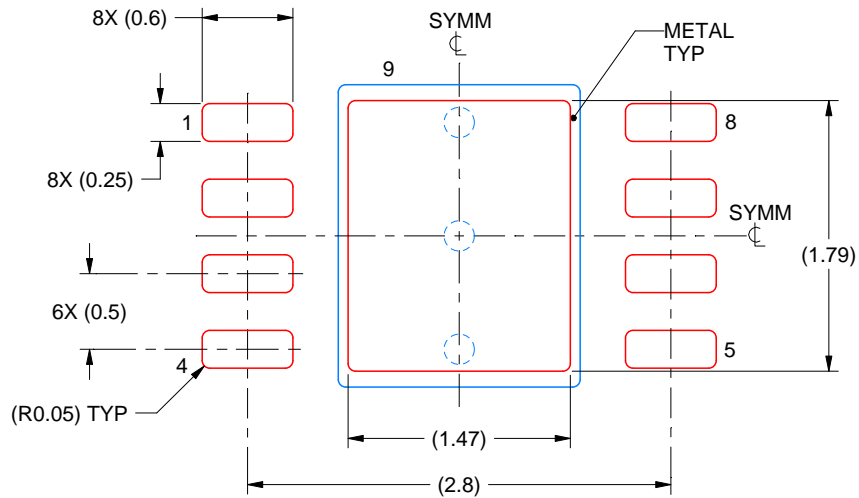

SOLDER PASTE EXAMPLE
BASED ON 0.1 mm THICK STENCIL

EXPOSED PAD 9:
82% PRINTED SOLDER COVERAGE BY AREA UNDER PACKAGE
SCALE:20X

4214922/A 03/2018

NOTES: (continued)

6. Laser cutting apertures with trapezoidal walls and rounded corners may offer better paste release. IPC-7525 may have alternate design recommendations.

IMPORTANT NOTICE AND DISCLAIMER

TI PROVIDES TECHNICAL AND RELIABILITY DATA (INCLUDING DATA SHEETS), DESIGN RESOURCES (INCLUDING REFERENCE DESIGNS), APPLICATION OR OTHER DESIGN ADVICE, WEB TOOLS, SAFETY INFORMATION, AND OTHER RESOURCES "AS IS" AND WITH ALL FAULTS, AND DISCLAIMS ALL WARRANTIES, EXPRESS AND IMPLIED, INCLUDING WITHOUT LIMITATION ANY IMPLIED WARRANTIES OF MERCHANTABILITY, FITNESS FOR A PARTICULAR PURPOSE OR NON-INFRINGEMENT OF THIRD PARTY INTELLECTUAL PROPERTY RIGHTS.

These resources are intended for skilled developers designing with TI products. You are solely responsible for (1) selecting the appropriate TI products for your application, (2) designing, validating and testing your application, and (3) ensuring your application meets applicable standards, and any other safety, security, regulatory or other requirements.

These resources are subject to change without notice. TI grants you permission to use these resources only for development of an application that uses the TI products described in the resource. Other reproduction and display of these resources is prohibited. No license is granted to any other TI intellectual property right or to any third party intellectual property right. TI disclaims responsibility for, and you will fully indemnify TI and its representatives against, any claims, damages, costs, losses, and liabilities arising out of your use of these resources.

TI's products are provided subject to [TI's Terms of Sale](#) or other applicable terms available either on ti.com or provided in conjunction with such TI products. TI's provision of these resources does not expand or otherwise alter TI's applicable warranties or warranty disclaimers for TI products.

TI objects to and rejects any additional or different terms you may have proposed.

Mailing Address: Texas Instruments, Post Office Box 655303, Dallas, Texas 75265
Copyright © 2022, Texas Instruments Incorporated