

LMC7101, LMC7101Q-Q1 Tiny Low-Power Operational Amplifier With Rail-to-Rail Input and Output

1 Features

- Tiny 5-Pin SOT-23 Package Saves Space—Typical Circuit Layouts Take Half the Space of 8-Pin SOIC Designs
- Ensured Specifications at 2.7-V, 3-V, 5-V, 15-V Supplies
- Typical Supply Current 0.5 mA at 5 V
- Typical Total Harmonic Distortion of 0.01% at 5 V
- 1-MHz Gain Bandwidth
- Similar to Popular LMC6482 and LMC6484
- Rail-to-Rail Input and Output
- Temperature Range -40°C to 125°C (LMC7101Q-Q1)

2 Applications

- Mobile Communications
- Notebooks and PDAs
- Battery Powered Products
- Sensor Interface
- Automotive Applications (LMC7101Q-Q1)

3 Description

The LMC7101 device is a high-performance CMOS operational amplifier available in the space-saving 5-pin SOT-23 tiny package. This makes the LMC7101 ideal for space- and weight-critical designs. The performance is similar to a single amplifier of the LMC6482 and LMC6484 types, with rail-to-rail input and output, high open-loop gain, low distortion, and low-supply currents.

The main benefits of the tiny package are most apparent in small portable electronic devices, such as mobile phones, pagers, notebook computers, personal digital assistants, and PCMCIA cards. The tiny amplifiers can be placed on a board where they are needed, thus simplifying board layout.

Device Information⁽¹⁾

| PART NUMBER | PACKAGE | BODY SIZE (NOM) |
|-------------------------|------------|-------------------|
| LMC7101, LMC7101Q-Q1 | SOT-23 (5) | 2.90 mm x 1.60 mm |

(1) For all available packages, see the orderable addendum at the end of the data sheet.

Example Application

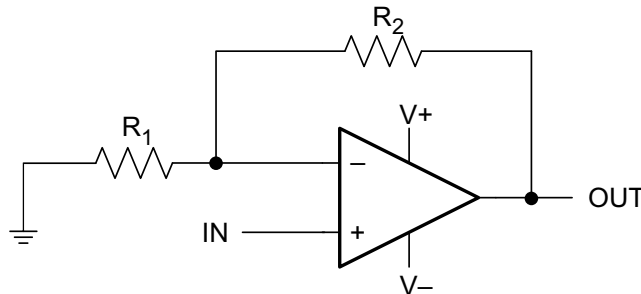

Table of Contents

| | |
|---|---|
| 1 Features 1 2 Applications 1 3 Description 1 4 Revision History 2 5 Pin Configuration and Functions 3 6 Specifications 4 6.1 Absolute Maximum Ratings 4 6.2 ESD Ratings: LMC7101 4 6.3 ESD Ratings: LMC7101Q-Q1 4 6.4 Recommended Operating Conditions 4 6.5 Thermal Information 5 6.6 Electrical Characteristics: 2.7 V 5 6.7 DC Electrical Characteristics: 3 V 6 6.8 DC Electrical Characteristics: 5 V 7 6.9 DC Electrical Characteristics: 15 V 8 6.10 AC Electrical Characteristics: 5 V 9 6.11 AC Electrical Characteristics: 15 V 9 6.12 Typical Characteristics 10 7 Detailed Description 20 | 7.1 Overview 20 7.2 Functional Block Diagram 20 7.3 Feature Description 20 7.4 Device Functional Modes 21 8 Application and Implementation 22 8.1 Application Information 22 8.2 Typical Application 23 9 Power Supply Recommendations 25 10 Layout 25 10.1 Layout Guidelines 25 10.2 Layout Example 25 11 Device and Documentation Support 26 11.1 Documentation Support 26 11.2 Related Links 26 11.3 Community Resource 26 11.4 Trademarks 26 11.5 Electrostatic Discharge Caution 26 11.6 Glossary 26 12 Mechanical, Packaging, and Orderable Information 26 |
|---|---|

4 Revision History

NOTE: Page numbers for previous revisions may differ from page numbers in the current version.

| Changes from Revision F (March 2013) to Revision G | Page |
|---|------|
| <ul style="list-style-type: none"> • Added <i>Pin Configuration and Functions</i> section, <i>ESD Ratings</i> table, <i>Feature Description</i> section, <i>Device Functional Modes</i>, <i>Application and Implementation</i> section, <i>Power Supply Recommendations</i> section, <i>Layout</i> section, <i>Device and Documentation Support</i> section, and <i>Mechanical, Packaging, and Orderable Information</i> section 1 | 1 |
| Changes from Revision E (March 2013) to Revision F | Page |
| <ul style="list-style-type: none"> • Changed layout of National Data Sheet to TI format 22 | 22 |

5 Pin Configuration and Functions

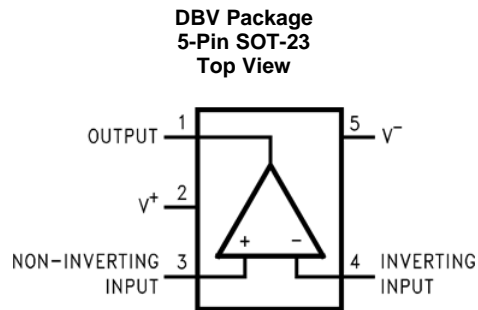

Pin Functions

| PIN | | TYPE | DESCRIPTION |
|-----|----------------|------|--------------------|
| NO. | NAME | | |
| 1 | OUTPUT | O | Output |
| 2 | V ⁺ | P | Positive Supply |
| 3 | INPUT+ | I | Noninverting Input |
| 4 | INPUT- | I | Inverting Input |
| 5 | V ⁻ | P | Negative Supply |

6 Specifications

6.1 Absolute Maximum Ratings

 over operating free-air temperature range (unless otherwise noted)⁽¹⁾⁽²⁾

| | MIN | MAX | UNIT |
|---|--|-----|------|
| Difference input voltage | ±Supply Voltage | | |
| Voltage at input and output pins | (V ⁺) + 0.3, (V ⁻) – 0.3 | | V |
| Supply voltage (V ⁺ – V ⁻) | 16 | | V |
| Current at input pin | –5 | 5 | mA |
| Current at output pin ⁽³⁾ | –35 | 35 | mA |
| Current at power supply pin | 35 | | mA |
| Lead temperature (soldering, 10 sec.) | 260 | | °C |
| Junction temperature ⁽⁴⁾ | 150 | | °C |
| Storage temperature | –65 | 150 | °C |

- (1) Stresses beyond those listed under *Absolute Maximum Ratings* may cause permanent damage to the device. These are stress ratings only, which do not imply functional operation of the device at these or any other conditions beyond those indicated under *Recommended Operating Conditions*. Exposure to absolute-maximum-rated conditions for extended periods may affect device reliability.
- (2) If Military/Aerospace specified devices are required, contact the TI Sales Office or Distributors for availability and specifications.
- (3) Applies to both single-supply and split-supply operation. Continuous short operation at elevated ambient temperature can result in exceeding the maximum allowed junction temperature at 150°C.
- (4) The maximum power dissipation is a function of T_{J(MAX)}, R_{θJA} and T_A. The maximum allowable power dissipation at any ambient temperature is P_D = (T_{J(MAX)} – T_A) / R_{θJA}. All numbers apply for packages soldered directly into a PC board.

6.2 ESD Ratings: LMC7101

| | | VALUE | UNIT |
|--|--|-------|------|
| V _(ESD) Electrostatic discharge | Human body model (HBM), per ANSI/ESDA/JEDEC JS-001 ⁽¹⁾ | ±1000 | V |
| | Charged-device model (CDM), per JEDEC specification JESD22-C101 ⁽²⁾ | ±1000 | |
| | Machine model (MM) | ±200 | |

- (1) JEDEC document JEP155 states that 500-V HBM allows safe manufacturing with a standard ESD control process.
- (2) JEDEC document JEP157 states that 250-V CDM allows safe manufacturing with a standard ESD control process.

6.3 ESD Ratings: LMC7101Q-Q1

| | | VALUE | UNIT |
|--|---|-------|------|
| V _(ESD) Electrostatic discharge | Human body model (HBM), per ANSI/ESDA/JEDEC JS-001 ⁽¹⁾ | ±1000 | V |
| | Charged-device model (CDM), per JEDEC specification JESD22-C101 | ±1000 | |
| | Machine model (MM) | ±200 | |

- (1) AEC Q100-002 indicates that HBM stressing shall be in accordance with the ANSI/ESDA/JEDEC JS-001 specification.

6.4 Recommended Operating Conditions

 over operating free-air temperature range (unless otherwise noted).⁽¹⁾

| | | MIN | MAX | UNIT |
|--------------------------------------|----------------------|-----|------|------|
| Supply voltage, V ⁺ | | 2.7 | 15.5 | V |
| Junction Temperature, T _J | LMC7101AI, LMC7101BI | –40 | 85 | °C |
| | LMC7101Q-Q1 | –40 | 125 | °C |

- (1) Stresses beyond those listed under *Absolute Maximum Ratings* may cause permanent damage to the device. These are stress ratings only, which do not imply functional operation of the device at these or any other conditions beyond those indicated under *Recommended Operating Conditions*. Exposure to absolute-maximum-rated conditions for extended periods may affect device reliability.

6.5 Thermal Information

| THERMAL METRIC ⁽¹⁾ | | LMC7101 | UNIT |
|-------------------------------|--|--------------|------|
| | | DBV (SOT-23) | |
| | | 5 PINS | |
| R _{θJA} | Junction-to-ambient thermal resistance | 170.9 | °C/W |
| R _{θJC(top)} | Junction-to-case (top) thermal resistance | 124.7 | °C/W |
| R _{θJB} | Junction-to-board thermal resistance | 30.8 | °C/W |
| ψ _{JT} | Junction-to-top characterization parameter | 17.7 | °C/W |
| ψ _{JB} | Junction-to-board characterization parameter | 30.2 | °C/W |
| R _{θJC(bot)} | Junction-to-case (bottom) thermal resistance | n/a | °C/W |

(1) For more information about traditional and new thermal metrics, see the *Semiconductor and IC Package Thermal Metrics* application report, [SPRA953](#).

6.6 Electrical Characteristics: 2.7 V

Unless otherwise specified, all limits specified for T_J = 25°C, V⁺ = 2.7 V, V⁻ = 0 V, V_{CM} = V_O = V⁺ / 2 and R_L > 1 MΩ.

| PARAMETER | TEST CONDITIONS | TYP ⁽¹⁾ | LMC7101AI | | LMC7101BI | | LMC7101Q-Q1 ⁽²⁾ | | UNIT |
|-------------------|------------------------------------|---|-----------|------|-----------|------|----------------------------|-----|--------|
| | | | MIN | MAX | MIN | MAX | MIN | MAX | |
| V _{OS} | Input offset voltage average drift | V ⁺ = 2.7 V | 6 | | 9 | | 9 | | mV |
| TCV _{OS} | Input offset voltage | | 1 | | | | | | μV/°C |
| I _B | Input bias current | -40°C ≤ T _J ≤ 125°C | 64 | | 64 | | 1000 | | pA |
| I _{OS} | Input offset current | -40°C ≤ T _J ≤ 125°C | 32 | | 32 | | 2000 | | pA |
| R _{IN} | Input resistance | | >1 | | | | | | Tera Ω |
| CMRR | Common-mode rejection ratio | 0 V ≤ V _{CM} ≤ 2.7 V V ⁺ = 2.7 V | 70 | 55 | 50 | 50 | 50 | | dB |
| V _{CM} | Input common mode voltage range | For CMRR ≥ 50 dB | 0 | 0 | 0 | 0 | 0 | | V |
| | | | 3 | 2.7 | 2.7 | 2.7 | 2.7 | | V |
| PSRR | Power supply rejection ratio | V ⁺ = 1.35 V to 1.65 V V ⁻ = -1.35 V to -1.65 V V _{CM} = 0 | 60 | 50 | 45 | 45 | 45 | | dB |
| C _{IN} | Common-mode input capacitance | | 3 | | | | | | pF |
| V _O | Output swing, min | R _L = 2 kΩ | 2.45 | 2.15 | 2.15 | 2.15 | 2.15 | | V |
| | | R _L = 10 kΩ | 2.68 | 2.64 | 2.64 | 2.64 | 2.64 | | V |
| V _O | Output swing, max | R _L = 2 kΩ | 0.25 | 0.5 | 0.5 | 0.5 | 0.5 | | V |
| | | R _L = 10 kΩ | 0.025 | 0.06 | 0.06 | 0.06 | 0.06 | | V |
| I _S | Supply current | | 0.5 | 0.81 | 0.81 | 0.81 | 0.81 | | mA |
| | | -40°C ≤ T _J ≤ 125°C | 0.5 | 0.95 | 0.95 | 0.95 | 0.95 | | mA |
| SR | Slew rate ⁽³⁾ | | 0.7 | | | | | | V/μs |
| GBW | Gain-bandwidth product | | 0.6 | | | | | | MHz |

(1) Typical values represent the most likely parametric normal.

(2) When operated at temperature between -40°C and 85°C, the LMC7101Q-Q1 will meet LMC7101BI specifications.

(3) V⁺ = 15 V. Connected as a voltage follower with a 10-V step input. Number specified is the slower of the positive and negative slew rates. R_L = 100 kΩ connected to 7.5 V. Amplifier excited with 1 kHz to produce V_O = 10 V_{PP}.

LMC7101, LMC7101Q-Q1

SNOS719G – SEPTEMBER 1999 – REVISED SEPTEMBER 2015

www.ti.com

6.7 DC Electrical Characteristics: 3 V

Unless otherwise specified, all limits specified for $T_J = 25^\circ\text{C}$, $V^+ = 3\text{ V}$, $V^- = 0\text{ V}$, $V_{\text{CM}} = 1.5\text{ V}$, $V_O = V^+ / 2$ and $R_L = 1\text{ M}\Omega$.

| PARAMETER | TEST CONDITIONS | TYP ⁽¹⁾ | LMC7101AI | | LMC7101BI | | LMC7101Q-Q1 ⁽²⁾ | | UNIT |
|---|---|--------------------|-----------|------|-----------|------|----------------------------|------|------------------------------|
| | | | MIN | MAX | MIN | MAX | MIN | MAX | |
| V_{OS} Input offset voltage | | | | 4 | | 7 | | 7 | mV |
| | $-40^\circ\text{C} \leq T_J \leq 125^\circ\text{C}$ | 0.11 | | 6 | | 9 | | | |
| TCV_{OS} Input offset voltage average drift | | 1 | | | | | | | $\mu\text{V}/^\circ\text{C}$ |
| I_B Input current | $-40^\circ\text{C} \leq T_J \leq 125^\circ\text{C}$ | 1 | | 64 | | 64 | | 1000 | pA |
| I_{OS} Input offset current | $-40^\circ\text{C} \leq T_J \leq 125^\circ\text{C}$ | 0.5 | | 32 | | 32 | | 2000 | pA |
| R_{IN} Input resistance | | >1 | | | | | | | Tera Ω |
| CMRR Common-mode rejection ratio | $0\text{ V} \leq V_{\text{CM}} \leq 3\text{ V}$ $V^+ = 3\text{ V}$ | 74 | 64 | | 60 | | 60 | | dB |
| V_{CM} Input common-mode voltage range | For CMRR $\geq 50\text{ dB}$ | 0 | 0 | | 0 | | 0 | | V |
| | | 3.3 | 3 | | 3 | | 3 | | |
| PSRR Power supply rejection ratio | $V^+ = 1.5\text{ V to } 7.5\text{ V}$ $V^- = -1.5\text{ V to } -7.5\text{ V}$ $V_O = V_{\text{CM}} = 0$ | 80 | 68 | | 60 | | 60 | | dB |
| C_{IN} Common-mode input capacitance | | 3 | | | | | | | pF |
| V_O Output swing, min | $R_L = 2\text{ k}\Omega$ | 2.8 | 2.6 | | 2.6 | | 2.6 | | V |
| | $R_L = 600\ \Omega$ | 0.2 | 0.4 | | 0.4 | | 0.4 | | |
| V_O Output swing, max | $R_L = 2\text{ k}\Omega$ | 2.7 | 2.5 | | 2.5 | | 2.5 | | V |
| | $R_L = 600\ \Omega$ | 0.37 | 0.6 | | 0.6 | | 0.6 | | |
| I_S Supply current | | | | 0.81 | | 0.81 | | 0.81 | mA |
| | $-40^\circ\text{C} \leq T_J \leq 125^\circ\text{C}$ | 0.5 | | 0.95 | | 0.95 | | 0.95 | |

(1) Typical values represent the most likely parametric normal.

(2) When operated at temperature between -40°C and 85°C , the LMC7101Q-Q1 will meet LMC7101BI specifications.

6.8 DC Electrical Characteristics: 5 V

Unless otherwise specified, all limits specified for $T_J = 25^\circ\text{C}$, $V^+ = 5\text{ V}$, $V^- = 0\text{ V}$, $V_{\text{CM}} = 1.5\text{ V}$, $V_O = V^+/2$ and $R_L = 1\text{ M}\Omega$.

| PARAMETER | TEST CONDITIONS | TYP ⁽¹⁾ | LMC7101AI | | LMC7101BI | | LMC7101Q-Q1 ⁽²⁾ | | UNIT | |
|---|---|--|-----------|-----|-----------|-----|----------------------------|-----|------------------------------|----|
| | | | MIN | MAX | MIN | MAX | MIN | MAX | | |
| V_{OS} Input offset voltage | $V^+ = 5\text{ V}$ | 0.11 | 3 | | 7 | | 7 | | mV | |
| | $V^+ = 5\text{ V}$, $-40^\circ\text{C} \leq T_J \leq 125^\circ\text{C}$ | 0.11 | 5 | | 9 | | 9 | | | |
| TCV_{OS} Input offset voltage average drift | | 1 | | | | | | | $\mu\text{V}/^\circ\text{C}$ | |
| I_B Input current | $-40^\circ\text{C} \leq T_J \leq 125^\circ\text{C}$ | 1 | 64 | | 64 | | 1000 | | pA | |
| I_{OS} Input offset current | $-40^\circ\text{C} \leq T_J \leq 125^\circ\text{C}$ | 0.5 | 32 | | 32 | | 2000 | | pA | |
| R_{IN} Input resistance | | >1 | | | | | | | Tera Ω | |
| CMRR Common-mode rejection ratio | $0\text{ V} \leq V_{\text{CM}} \leq 5\text{ V}$ LMC7101Q-Q1 at 125°C $0.2\text{ V} \leq V_{\text{CM}} \leq 4.8\text{ V}$ | 82 | 65 | | 60 | | 60 | | dB | |
| | $0\text{ V} \leq V_{\text{CM}} \leq 5\text{ V}$ LMC7101Q-Q1 at 125°C $0.2\text{ V} \leq V_{\text{CM}} \leq 4.8\text{ V}$ $-40^\circ\text{C} \leq T_J \leq 125^\circ\text{C}$ | 82 | 60 | | 55 | | 55 | | | |
| +PSRR Positive power supply rejection ratio | $V^+ = 5\text{ V to }15\text{ V}$ $V^- = 0\text{ V}$, $V_O = 1.5\text{ V}$ | 82 | 70 | | 65 | | 65 | | dB | |
| | $V^+ = 5\text{ V to }15\text{ V}$ $V^- = 0\text{ V}$, $V_O = 1.5\text{ V}$ $-40^\circ\text{C} \leq T_J \leq 125^\circ\text{C}$ | 82 | 65 | | 62 | | 62 | | | |
| -PSRR Negative power supply rejection ratio | $V^- = -5\text{ V to }-15\text{ V}$ $V^+ = 0\text{ V}$, $V_O = -1.5\text{ V}$ | 82 | 70 | | 65 | | 65 | | dB | |
| | $V^- = -5\text{ V to }-15\text{ V}$ $V^+ = 0\text{ V}$, $V_O = -1.5\text{ V}$ $-40^\circ\text{C} \leq T_J \leq 125^\circ\text{C}$ | 82 | 65 | | 62 | | 62 | | | |
| V_{CM} Input common-mode voltage range | For CMRR $\geq 50\text{ dB}$ | -0.3 | -0.2 | | -0.2 | | -0.2 | | V | |
| | For CMRR $\geq 50\text{ dB}$ $-40^\circ\text{C} \leq T_J \leq 125^\circ\text{C}$ | -0.3 | 0 | | 0 | | 0.2 | | | |
| | | 5.3 | 5.2 | | 5.2 | | 5.2 | | V | |
| | $-40^\circ\text{C} \leq T_J \leq 125^\circ\text{C}$ | 5.3 | 5 | | 5 | | 4.8 | | | |
| C_{IN} Common-mode input capacitance | | 3 | | | | | | | pF | |
| V_O Output swing | $R_L = 2\text{ k}\Omega$ | 4.9 | 4.7 | | 4.7 | | 4.7 | | V | |
| | $R_L = 2\text{ k}\Omega$, $-40^\circ\text{C} \leq T_J \leq 125^\circ\text{C}$ | 4.9 | 4.6 | | 4.6 | | 4.54 | | | |
| | | 0.1 | 0.18 | | 0.18 | | 0.18 | | V | |
| | $-40^\circ\text{C} \leq T_J \leq 125^\circ\text{C}$ | 0.1 | 0.24 | | 0.24 | | 0.28 | | | |
| | $R_L = 600\ \Omega$ | 4.7 | 4.5 | | 4.5 | | 4.5 | | V | |
| | $R_L = 600\ \Omega$, $-40^\circ\text{C} \leq T_J \leq 125^\circ\text{C}$ | 4.7 | 4.24 | | 4.24 | | 4.28 | | | |
| | | 0.3 | 0.5 | | 0.5 | | 0.5 | | V | |
| | $-40^\circ\text{C} \leq T_J \leq 125^\circ\text{C}$ | 0.3 | 0.65 | | 0.65 | | 0.8 | | | |
| I_{SC} Output short circuit current | Sourcing | $V_O = 0\text{ V}$ 24 | 24 | 16 | | 16 | | 16 | | mA |
| | | $V_O = 0\text{ V}$ 24 $-40^\circ\text{C} \leq T_J \leq 125^\circ\text{C}$ | 24 | 11 | | 11 | | 9 | | |
| | Sinking | $V_O = 5\text{ V}$ | 19 | 11 | | 11 | | 11 | | mA |
| | | $V_O = 5\text{ V}$ $-40^\circ\text{C} \leq T_J \leq 125^\circ\text{C}$ | 19 | 7.5 | | 7.5 | | 5.8 | | |
| I_S Supply current | | 0.5 | 0.85 | | 0.85 | | 0.85 | | mA | |
| | $-40^\circ\text{C} \leq T_J \leq 125^\circ\text{C}$ | 0.5 | 1 | | 1 | | 1 | | | |

(1) Typical values represent the most likely parametric normal.

(2) When operated at temperature between -40°C and 85°C , the LMC7101Q-Q1 will meet LMC7101BI specifications.

LMC7101, LMC7101Q-Q1

SNOS719G – SEPTEMBER 1999 – REVISED SEPTEMBER 2015

www.ti.com

6.9 DC Electrical Characteristics: 15 V

Unless otherwise specified, all limits specified for $T_J = 25^\circ\text{C}$, $V^+ = 15\text{ V}$, $V^- = 0\text{ V}$, $V_{CM} = 1.5\text{ V}$, $V_O = V^+ / 2$ and $R_L = 1\text{ M}\Omega$.

| PARAMETER | TEST CONDITIONS | TYP ⁽¹⁾ | LMC7101AI | | LMC7101BI | | LMC7101Q-Q1 ⁽²⁾ | | UNIT |
|------------|--|---|---|------|-----------|-------|----------------------------|------|------------------------------|
| | | | MIN | MAX | MIN | MAX | MIN | MAX | |
| V_{OS} | Input offset voltage | 0.11 | | | | | | | mV |
| TCV_{OS} | Input offset voltage average drift | 1 | | | | | | | $\mu\text{V}/^\circ\text{C}$ |
| I_B | Input current | 1 | | 64 | | 64 | | 1000 | pA |
| I_{OS} | Input offset current | 0.5 | | 32 | | 32 | | 2000 | pA |
| R_{IN} | Input resistance | >1 | | | | | | | Tera Ω |
| CMRR | Common-mode rejection ratio | $0\text{ V} \leq V_{CM} \leq 15\text{ V}$ LMC7101Q-Q1 at 125°C $0.2\text{ V} \leq V_{CM} \leq 14.8\text{ V}$ | 82 | 70 | 65 | 65 | 65 | | dB |
| | | $0\text{ V} \leq V_{CM} \leq 15\text{ V}$ LMC7101Q-Q1 at 125°C $0.2\text{ V} \leq V_{CM} \leq 14.8\text{ V}$ $-40^\circ\text{C} \leq T_J \leq 125^\circ\text{C}$ | 82 | 65 | 60 | 60 | 60 | | |
| +PSRR | Positive power supply rejection ratio | $V^+ = 5\text{ V to }15\text{ V}$ $V^- = 0\text{ V}$, $V_O = 1.5\text{ V}$ | 82 | 70 | 65 | 65 | 65 | | dB |
| | | $V^+ = 5\text{ V to }15\text{ V}$ $V^- = 0\text{ V}$, $V_O = 1.5\text{ V}$ $-40^\circ\text{C} \leq T_J \leq 125^\circ\text{C}$ | 82 | 65 | 62 | 62 | 62 | | |
| -PSRR | Negative power supply rejection ratio | $V^- = -5\text{ V to }-15\text{ V}$ $V^+ = 0\text{ V}$, $V_O = -1.5\text{ V}$ | 82 | 70 | 65 | 65 | 65 | | dB |
| | | $V^- = -5\text{ V to }-15\text{ V}$ $V^+ = 0\text{ V}$, $V_O = -1.5\text{ V}$ $-40^\circ\text{C} \leq T_J \leq 125^\circ\text{C}$ | 82 | 65 | 62 | 62 | 62 | | |
| V_{CM} | Input common-mode voltage range | $V^+ = 5\text{ V}$ For CMRR $\geq 50\text{ dB}$ | -0.3 | -0.2 | -0.2 | -0.2 | -0.2 | | V |
| | | $V^+ = 5\text{ V}$ For CMRR $\geq 50\text{ dB}$ $-40^\circ\text{C} \leq T_J \leq 125^\circ\text{C}$ | -0.3 | 0 | 0 | 0.2 | 0.2 | | |
| | | | 15.3 | 15.2 | 15.2 | 15.2 | 15.2 | | V max |
| | | $-40^\circ\text{C} \leq T_J \leq 125^\circ\text{C}$ | 15.3 | 15 | 15 | 14.8 | 14.8 | | |
| A_V | Large signal voltage gain ⁽³⁾ | Sourcing | $R_L = 2\text{ k}\Omega$ | 340 | 80 | 80 | 80 | | V/mV |
| | | | $R_L = 2\text{ k}\Omega$ $-40^\circ\text{C} \leq T_J \leq 125^\circ\text{C}$ | 340 | 40 | 40 | 30 | | |
| | | Sinking | $R_L = 2\text{ k}\Omega$ | 24 | 15 | 15 | 15 | | |
| | | | $R_L = 2\text{ k}\Omega$ $-40^\circ\text{C} \leq T_J \leq 125^\circ\text{C}$ | 24 | 10 | 10 | 4 | | |
| | | Sourcing | $R_L = 600\ \Omega$ | 300 | 34 | 34 | 34 | | V/mV |
| | | Sinking | $R_L = 600\ \Omega$ | 15 | 6 | 6 | 6 | | |
| C_{IN} | Input capacitance | 3 | | | | | | pF | |
| V_O | Output swing | $V^+ = 15\text{ V}$ $R_L = 2\text{ k}\Omega$ | 14.7 | 14.4 | 14.4 | 14.4 | 14.4 | | V |
| | | $V^+ = 15\text{ V}$ $R_L = 2\text{ k}\Omega$ $-40^\circ\text{C} \leq T_J \leq 125^\circ\text{C}$ | 14.7 | 14.2 | 14.2 | 14.2 | 14.2 | | |
| | | | 0.16 | 0.32 | 0.32 | 0.32 | 0.32 | | V |
| | | $-40^\circ\text{C} \leq T_J \leq 125^\circ\text{C}$ | 0.16 | 0.45 | 0.45 | 0.45 | 0.45 | | |
| | | $V^+ = 15\text{ V}$ $R_L = 600\ \Omega$ | 14.1 | 13.4 | 13.4 | 13.4 | 13.4 | | V |
| | | $V^+ = 15\text{ V}$ $R_L = 600\ \Omega$ $-40^\circ\text{C} \leq T_J \leq 125^\circ\text{C}$ | 14.1 | 13 | 13 | 12.85 | 12.85 | | |
| | | | 0.5 | 1 | 1 | 1 | 1 | | V |
| | | $-40^\circ\text{C} \leq T_J \leq 125^\circ\text{C}$ | 0.5 | 1.3 | 1.3 | 1.5 | 1.5 | | |

(1) Typical values represent the most likely parametric normal.

(2) When operated at temperature between -40°C and 85°C , the LMC7101Q-Q1 will meet LMC7101BI specifications.

(3) $V^+ = 15\text{ V}$, $V_{CM} = 1.5\text{ V}$ and R_L connect to 7.5 V . For sourcing tests, $7.5\text{ V} \leq V_O \leq 12.5\text{ V}$. For sinking tests, $2.5\text{ V} \leq V_O \leq 7.5\text{ V}$.

DC Electrical Characteristics: 15 V (continued)

Unless otherwise specified, all limits specified for $T_J = 25^\circ\text{C}$, $V^+ = 15\text{ V}$, $V^- = 0\text{ V}$, $V_{CM} = 1.5\text{ V}$, $V_O = V^+ / 2$ and $R_L = 1\text{ M}\Omega$.

| PARAMETER | TEST CONDITIONS | | TYP ⁽¹⁾ | LMC7101AI | | LMC7101BI | | LMC7101Q-Q1 ⁽²⁾ | | UNIT |
|--|---|--|--------------------|-----------|-----|-----------|-----|----------------------------|-----|------|
| | | | | MIN | MAX | MIN | MAX | MIN | MAX | |
| I_{SC} Output short circuit current ⁽⁴⁾ | Sourcing | $V_O = 0\text{ V}$ | 50 | 30 | | 30 | | 30 | mA | |
| | | $V_O = 0\text{ V}$ $-40^\circ\text{C} \leq T_J \leq 125^\circ\text{C}$ | 50 | 20 | | 20 | | 20 | | |
| | Sinking | $V_O = 12\text{ V}$ | 50 | 30 | | 30 | | 30 | | |
| | | $V_O = 12\text{ V}$ $-40^\circ\text{C} \leq T_J \leq 125^\circ\text{C}$ | 50 | 20 | | 20 | | 20 | | |
| I_S Supply current | | | 0.8 | 1.5 | | 1.5 | | 1.5 | | mA |
| | $-40^\circ\text{C} \leq T_J \leq 125^\circ\text{C}$ | | | 1.71 | | 1.71 | | 1.75 | | |

(4) Do not short circuit output to V^+ when V^+ is greater than 12 V or reliability will be adversely affected.

6.10 AC Electrical Characteristics: 5 V

Unless otherwise specified, all limits specified for $T_J = 25^\circ\text{C}$, $V^+ = 5\text{ V}$, $V^- = 0\text{ V}$, $V_{CM} = 1.5\text{ V}$, $V_O = V^+ / 2$ and $R_L = 1\text{ M}\Omega$.

| PARAMETER | TEST CONDITIONS | TYP ⁽¹⁾ | LMC7101AI LIMIT ⁽²⁾ | LMC7101BI LIMIT ⁽²⁾ | UNIT |
|-------------------------------|---|--------------------|--------------------------------|--------------------------------|------------------|
| THD Total harmonic distortion | $f = 10\text{ kHz}$, $A_V = -2$ $R_L = 10\text{ k}\Omega$, $V_O = 4\text{ V}_{PP}$ | 0.01% | | | |
| SR Slew rate | | 1 | | | V/ μs |
| GBW Gain bandwidth product | | 1 | | | MHz |

(1) Typical values represent the most likely parametric normal.

(2) All limits are specified by testing or statistical analysis.

6.11 AC Electrical Characteristics: 15 V

Unless otherwise specified, all limits specified for $T_J = 25^\circ\text{C}$, $V^+ = 15\text{ V}$, $V^- = 0\text{ V}$, $V_{CM} = 1.5\text{ V}$, $V_O = V^+ / 2$ and $R_L = 1\text{ M}\Omega$.

| PARAMETER | TEST CONDITIONS | TYP ⁽¹⁾ | LMC7101AI | | LMC7101BI | | LMC7101Q-Q1 ⁽²⁾ | | UNIT |
|------------------------------------|--|--------------------|-----------|-----|-----------|-----|----------------------------|--------------------------------------|-------------------------|
| | | | MIN | MAX | MIN | MAX | MIN | MAX | |
| SR Slew rate ⁽³⁾ | $V^+ = 15\text{ V}$ | 1.1 | 0.5 | | 0.5 | | 0.5 | | V/ μs min |
| | $V^+ = 15\text{ V}$, $-40^\circ\text{C} \leq T_J \leq 125^\circ\text{C}$ | | 0.4 | | 0.4 | | 0.4 | | |
| GBW Gain-bandwidth product | $V^+ = 15\text{ V}$ | 1.1 | | | | | | MHz | |
| ϕ_m Phase margin | | 45 | | | | | | deg | |
| G_m Gain margin | | 10 | | | | | | dB | |
| e_n Input-referred voltage noise | $f = 1\text{ kHz}$, $V_{CM} = 1\text{ V}$ | 37 | | | | | | $\frac{\text{nV}}{\sqrt{\text{Hz}}}$ | |
| I_n Input-referred current noise | $f = 1\text{ kHz}$ | 1.5 | | | | | | $\frac{\text{fA}}{\sqrt{\text{Hz}}}$ | |
| THD Total harmonic distortion | $f = 10\text{ kHz}$, $A_V = -2$ $R_L = 10\text{ k}\Omega$ $V_O = 8.5\text{ V}_{PP}$ | 0.01% | | | | | | | |

(1) Typical values represent the most likely parametric normal.

(2) When operated at temperature between -40°C and 85°C , the LMC7101Q-Q1 will meet LMC7101BI specifications.

(3) $V^+ = 15\text{ V}$. Connected as a voltage follower with a 10-V step input. Number specified is the slower of the positive and negative slew rates. $R_L = 100\text{ k}\Omega$ connected to 7.5 V. Amplifier excited with 1 kHz to produce $V_O = 10\text{ V}_{PP}$.

6.12 Typical Characteristics

6.12.1 Typical Characteristics: 2.7 V

$V^+ = 2.7\text{ V}$, $V^- = 0\text{ V}$, $T_A = 25^\circ\text{C}$, unless otherwise specified.

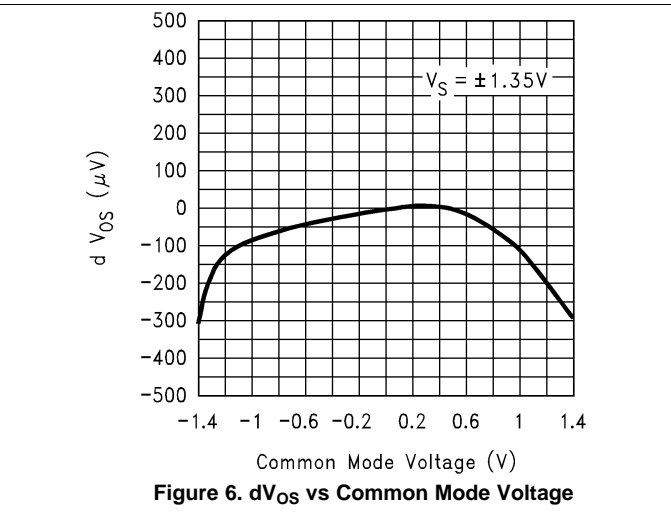
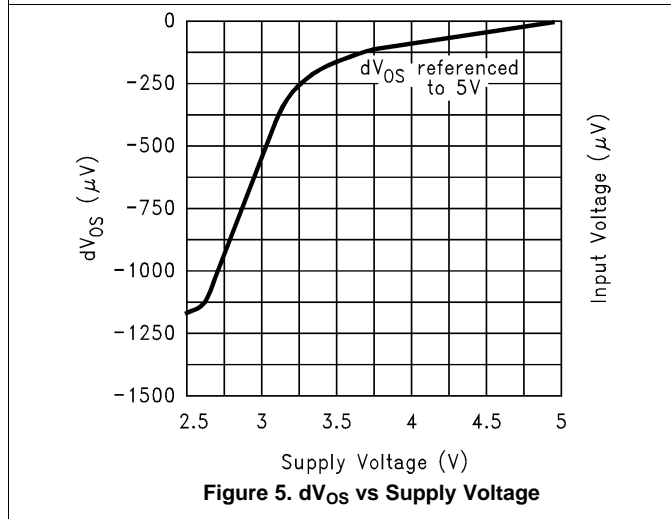
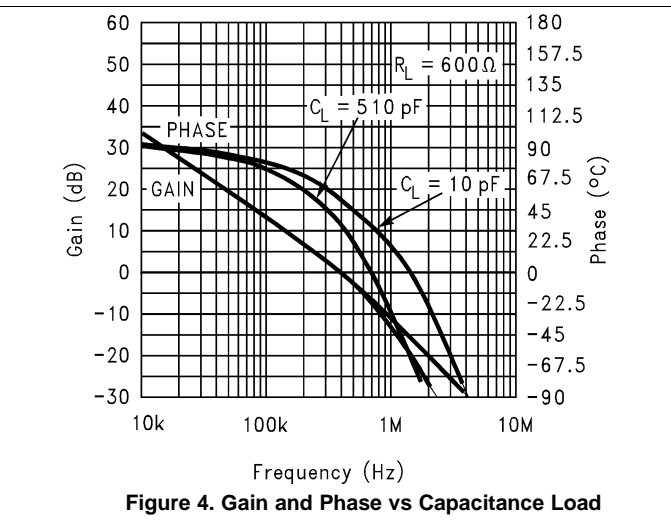
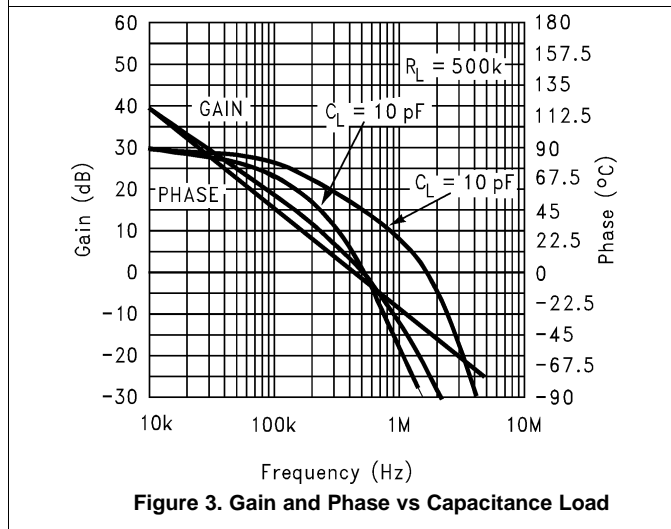
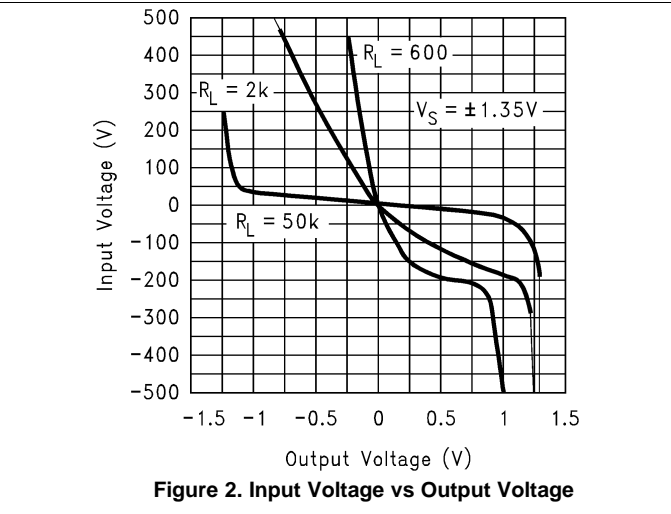
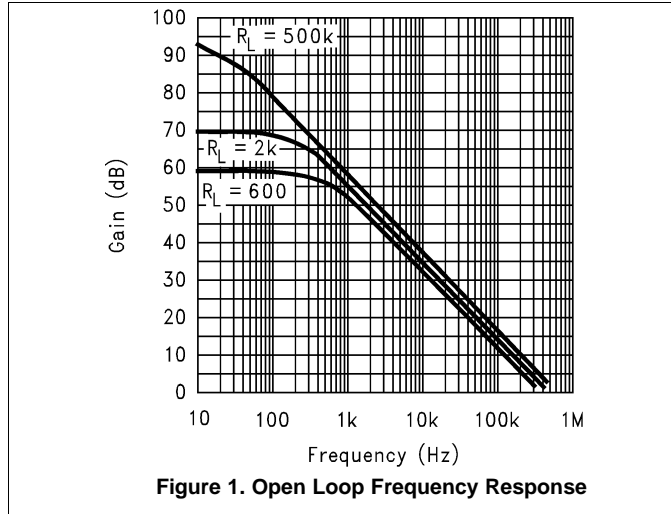

Typical Characteristics: 2.7 V (continued)

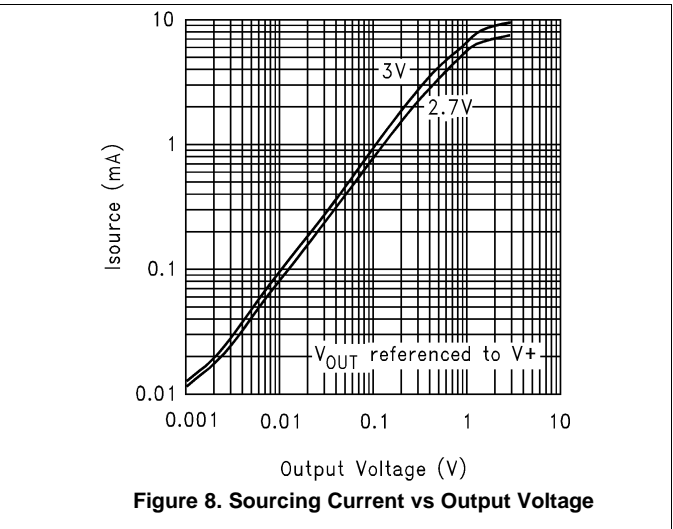
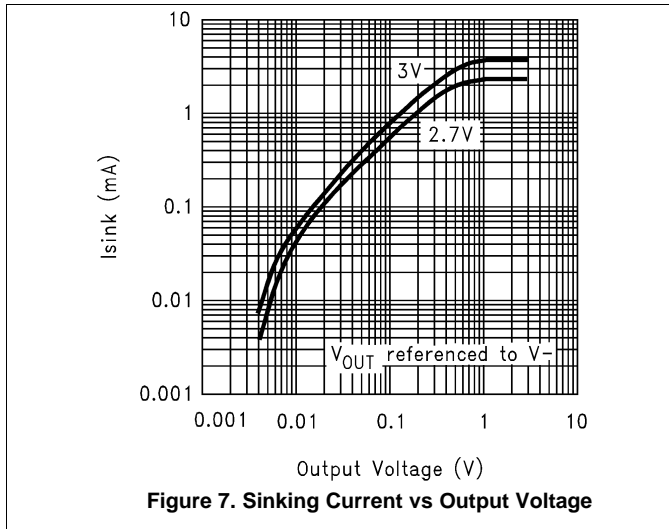

6.12.2 Typical Characteristics: 3 V

$V^+ = 3\text{ V}$, $V^- = 0\text{ V}$, $T_A = 25^\circ\text{C}$, unless otherwise specified.

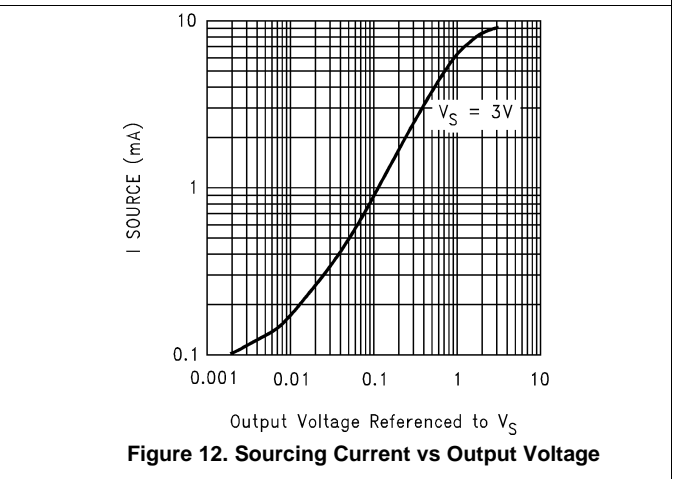
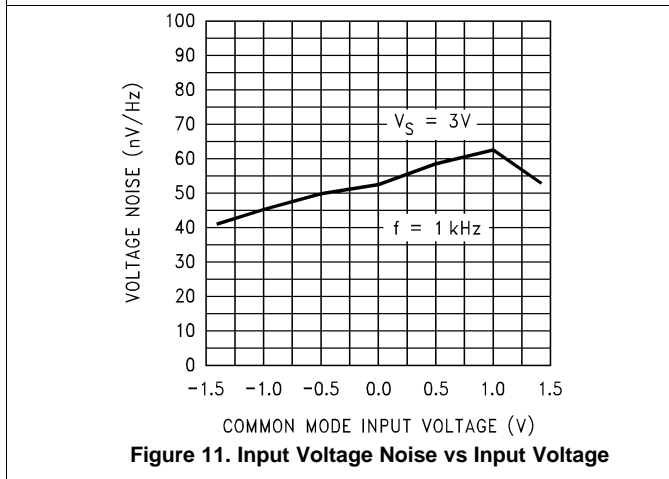
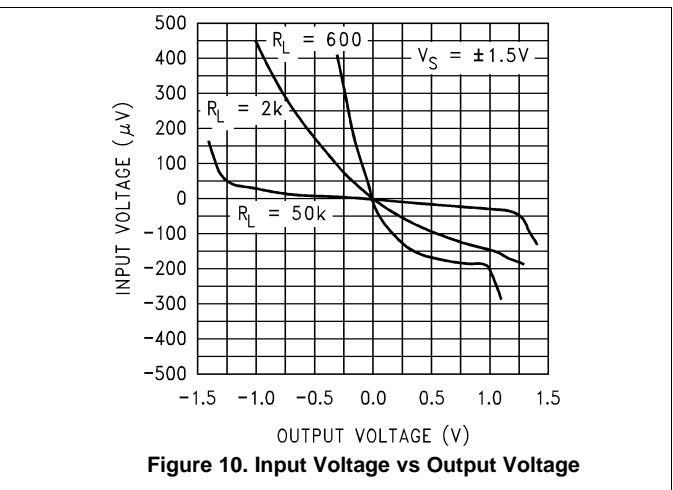
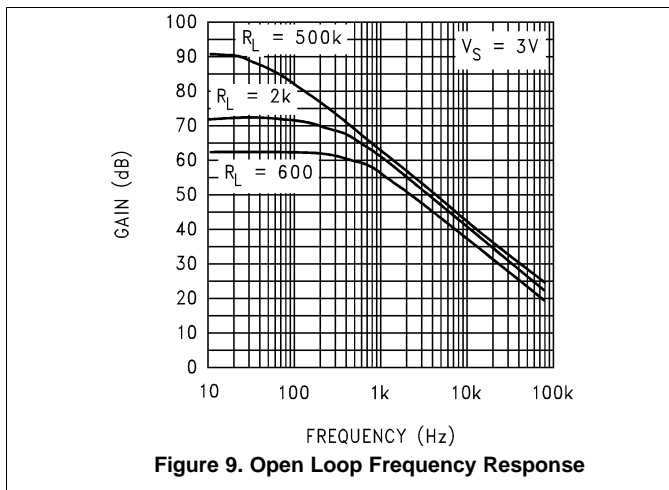

Typical Characteristics: 3 V (continued)

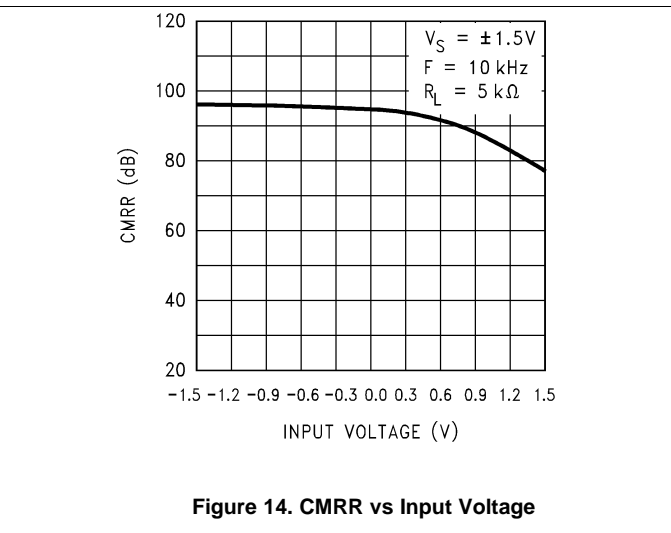
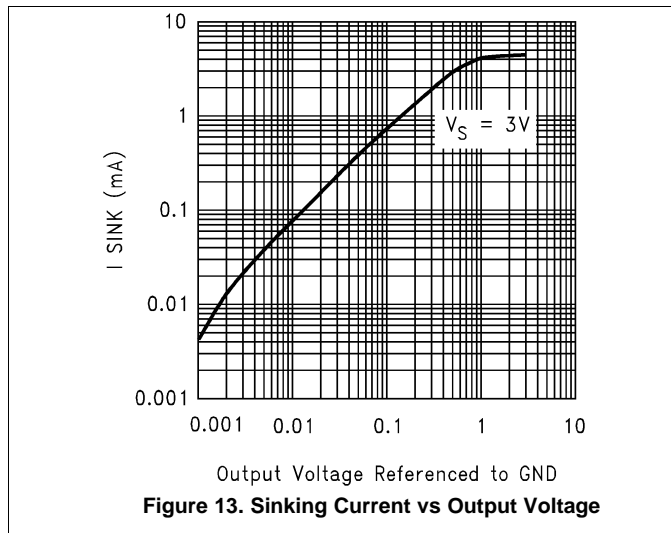

6.12.3 Typical Characteristics: 5 V

$V^+ = 5\text{ V}$, $V^- = 0\text{ V}$, $T_A = 25^\circ\text{C}$, unless otherwise specified.

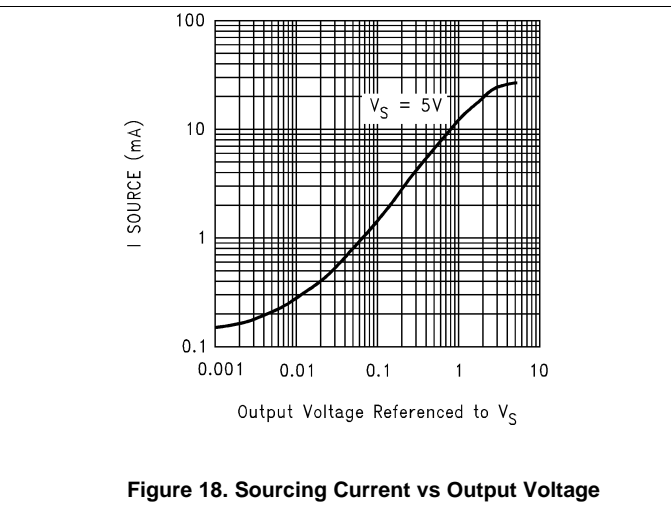
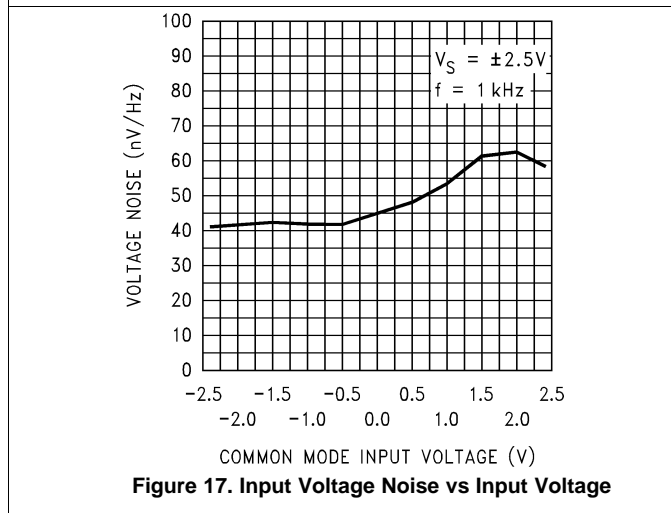
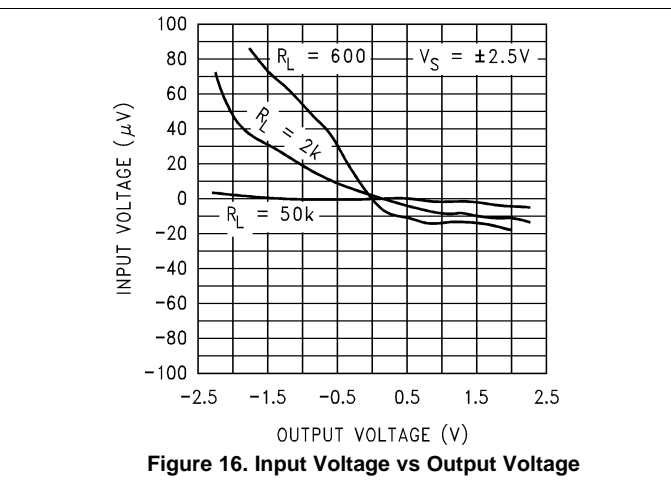
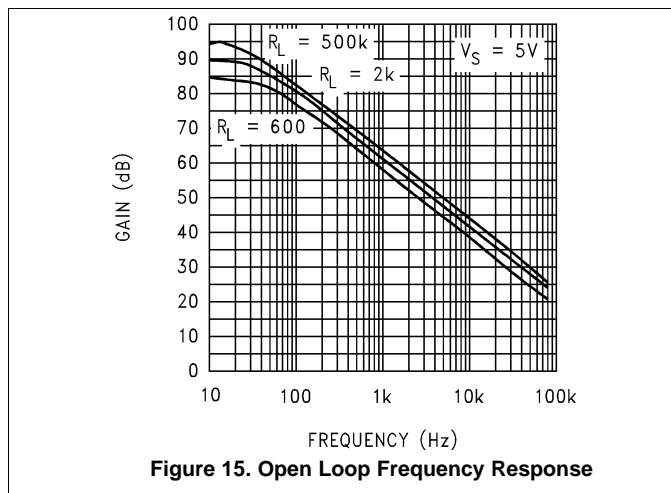

Typical Characteristics: 5 V (continued)

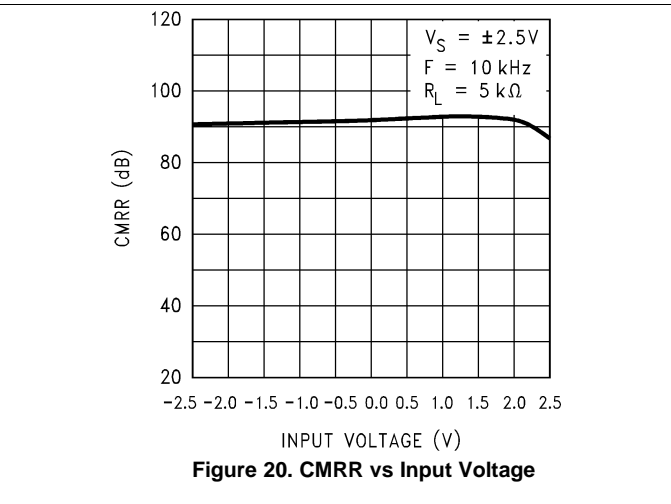
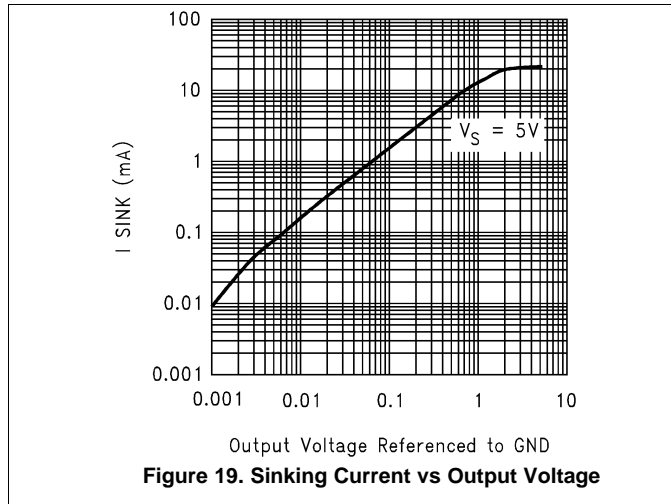

6.12.4 Typical Characteristics: 15 V

$V^+ = +15\text{ V}$, $V^- = 0\text{ V}$, $T_A = 25^\circ\text{C}$, unless otherwise specified.

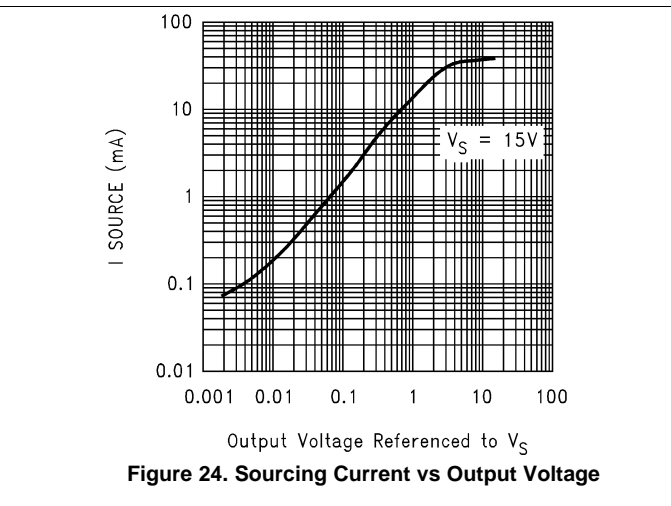
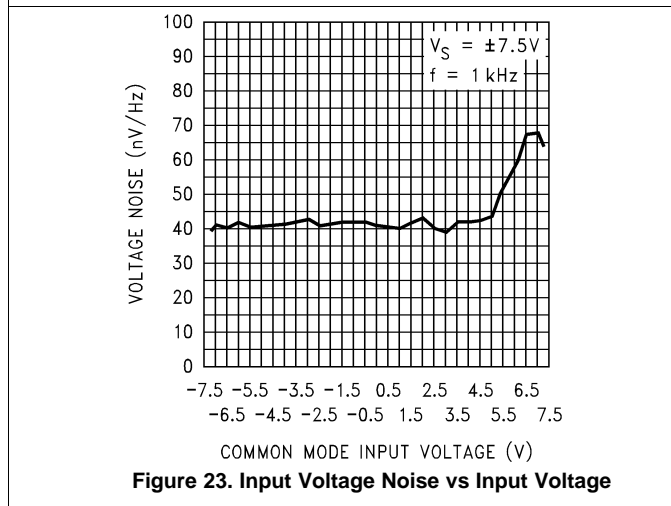
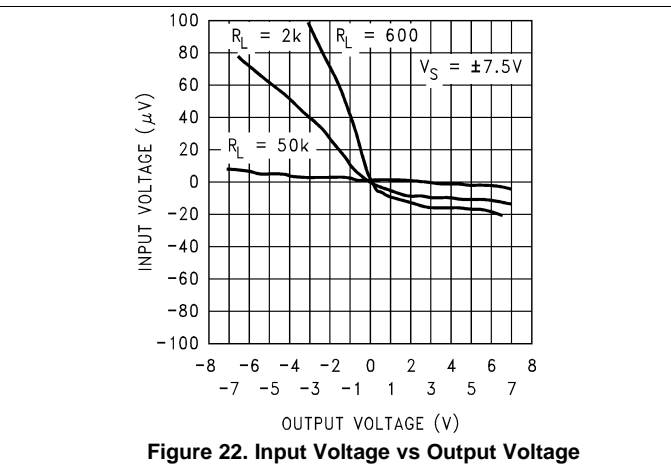
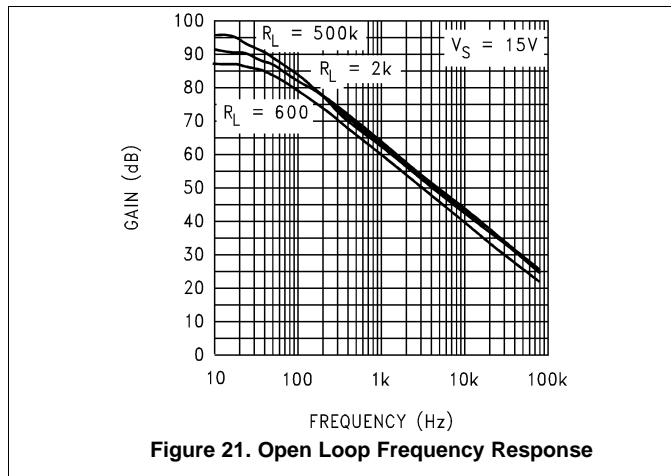

Typical Characteristics: 15 V (continued)

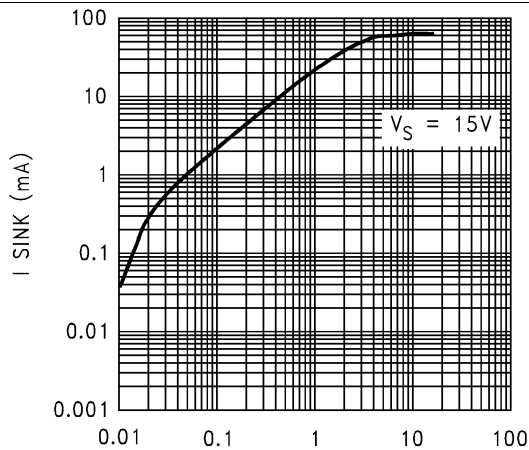

Output Voltage Referenced to GND
Figure 25. Sinking Current vs Output Voltage

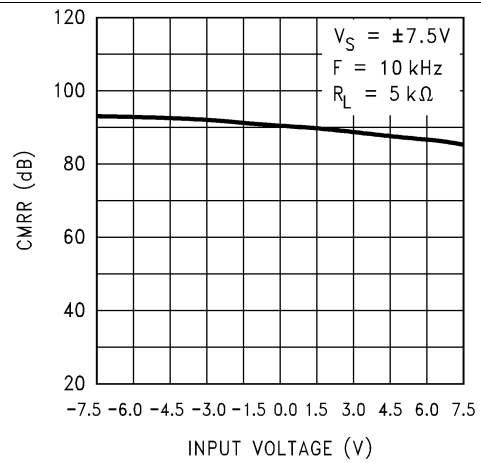

Figure 26. CMRR vs Input Voltage

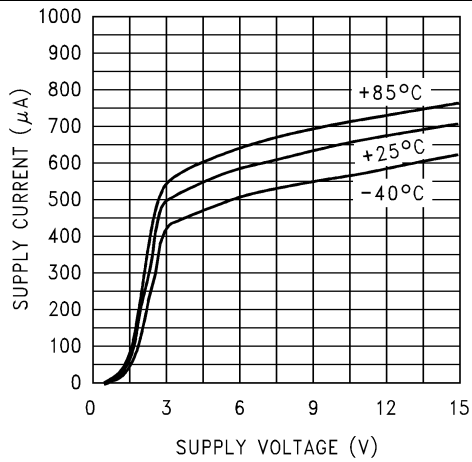

Figure 27. Supply Current vs Supply Voltage

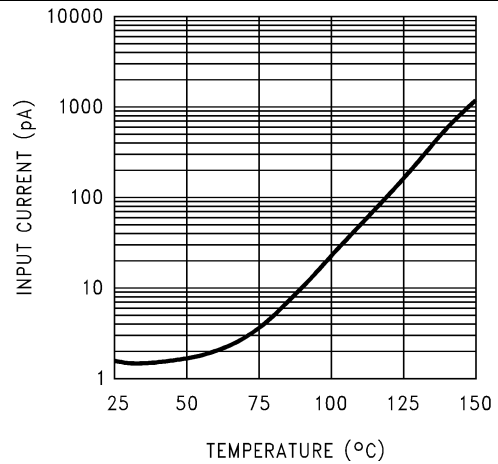

Figure 28. Input Current vs Temperature

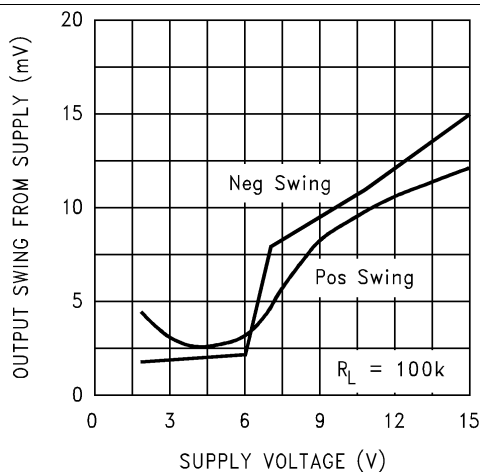

Figure 29. Output Voltage Swing vs Supply Voltage

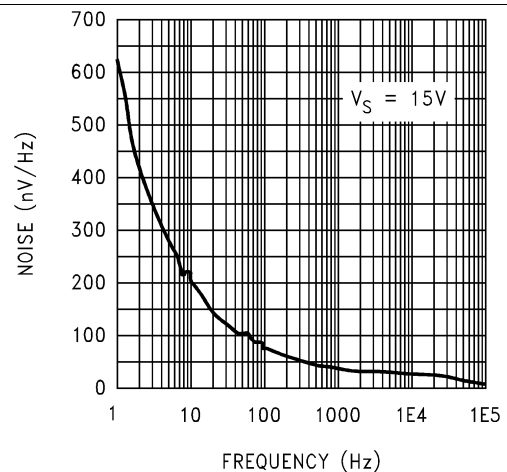

Figure 30. Input Voltage Noise vs Frequency

Typical Characteristics: 15 V (continued)

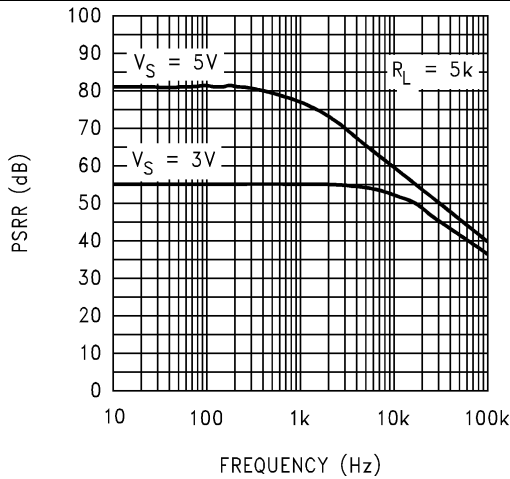

Figure 31. Positive PSRR vs Frequency

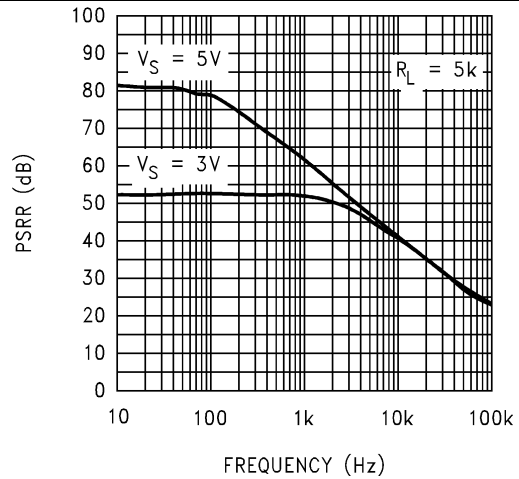

Figure 32. Negative PSRR vs Frequency

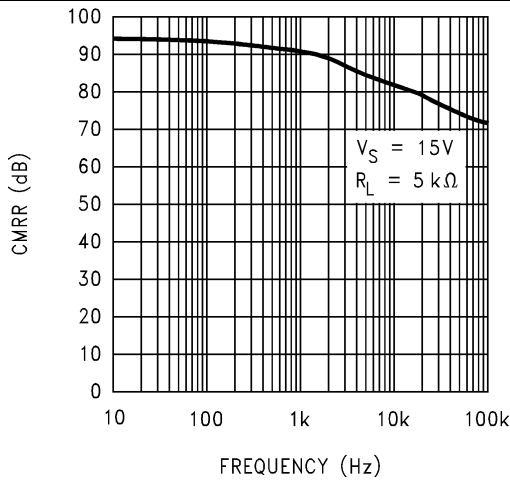

Figure 33. CMRR vs Frequency

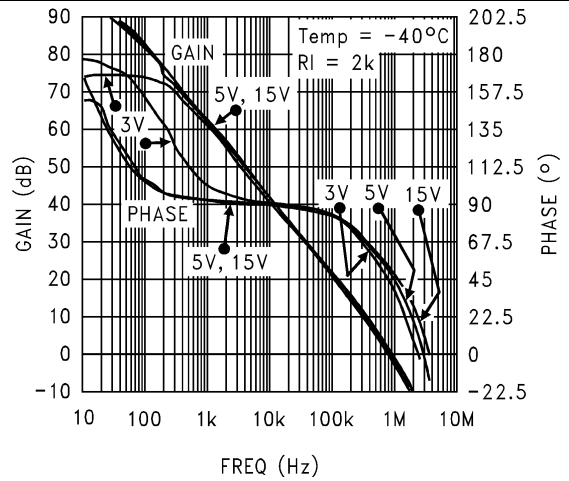

Figure 34. Open Loop Frequency Response at -40°C

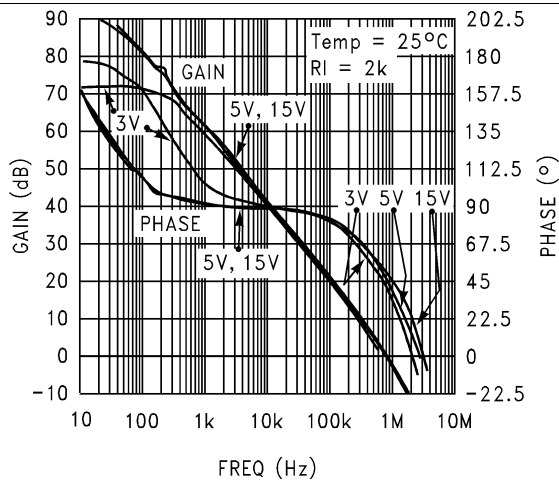

Figure 35. Open Loop Frequency Response at 25°C

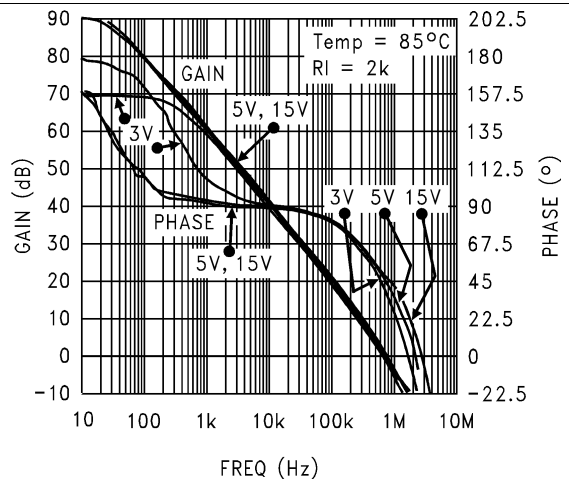

Figure 36. Open Loop Frequency Response at 85°C

Typical Characteristics: 15 V (continued)

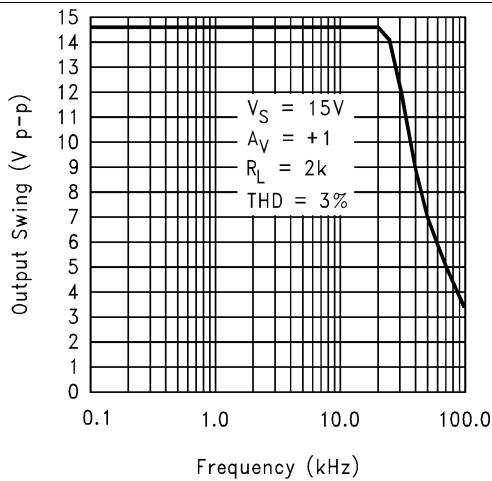

Figure 37. Maximum Output Swing vs Frequency

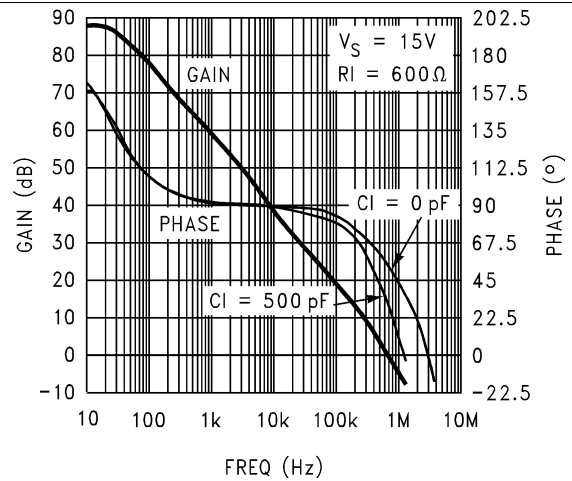

Figure 38. Gain and Phase vs Capacitive Load

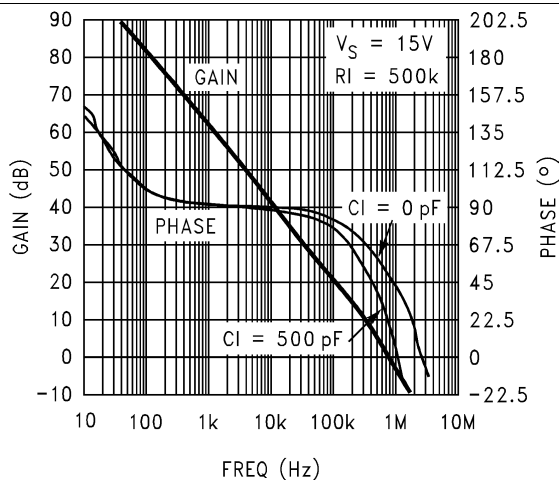

Figure 39. Gain and Phase vs Capacitive Load

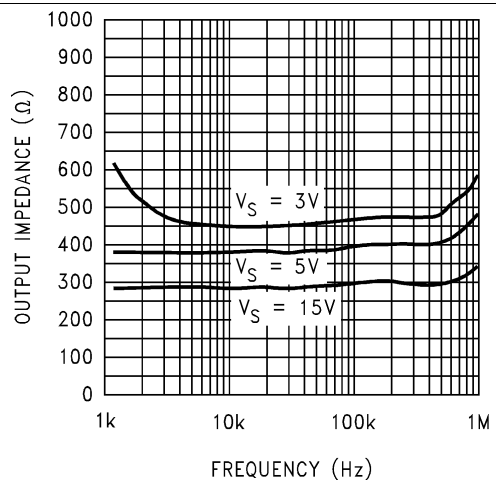

Figure 40. Output Impedance vs Frequency

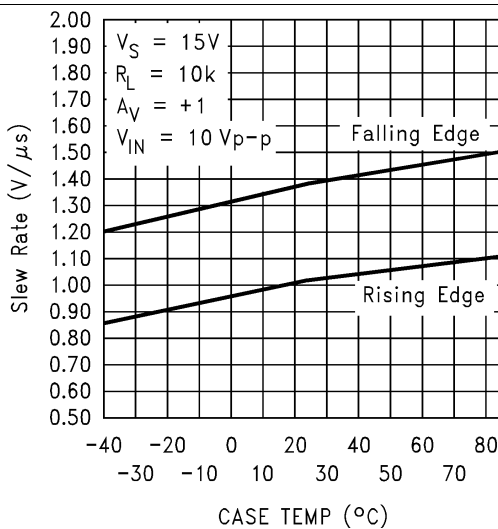

Figure 41. Slew Rate vs Temperature

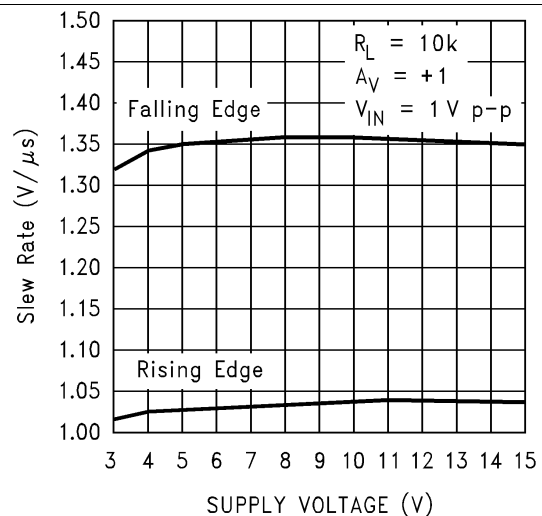

Figure 42. Slew Rate vs Supply Voltage

Typical Characteristics: 15 V (continued)

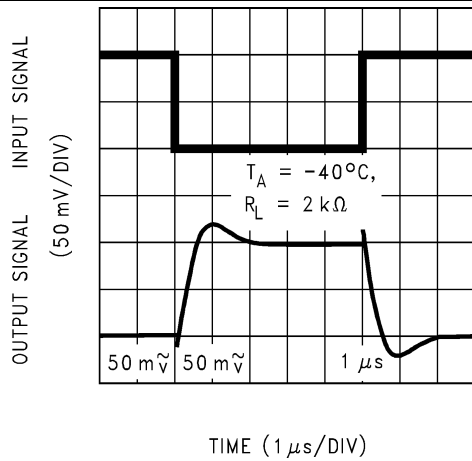

Figure 43. Inverting Small Signal Pulse Response

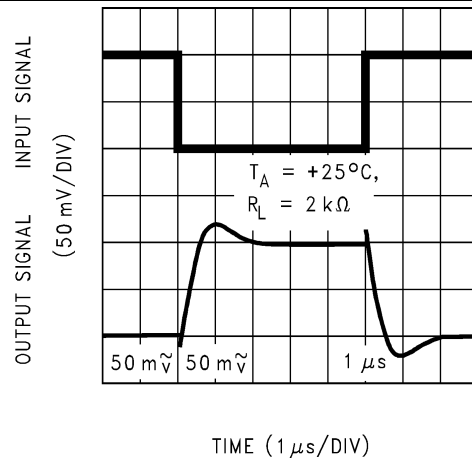

Figure 44. Inverting Small Signal Pulse Response

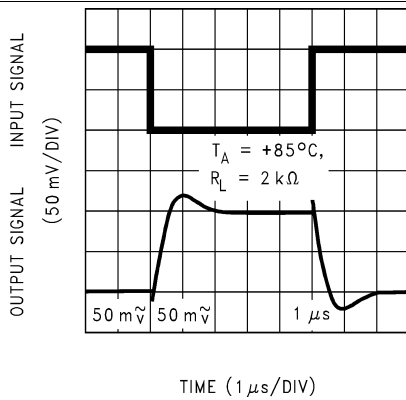

Figure 45. Inverting Small Signal Pulse Response

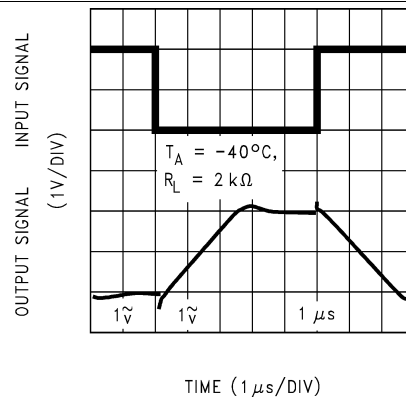

Figure 46. Inverting Large Signal Pulse Response

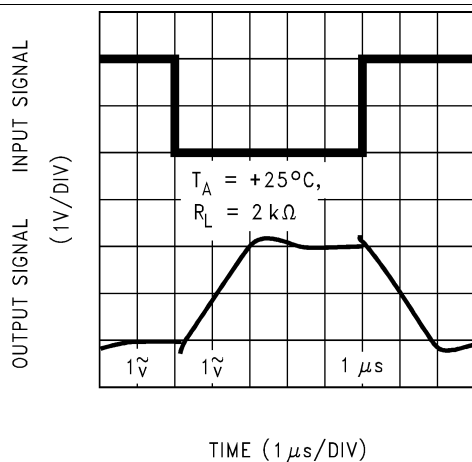

Figure 47. Inverting Large Signal Pulse Response

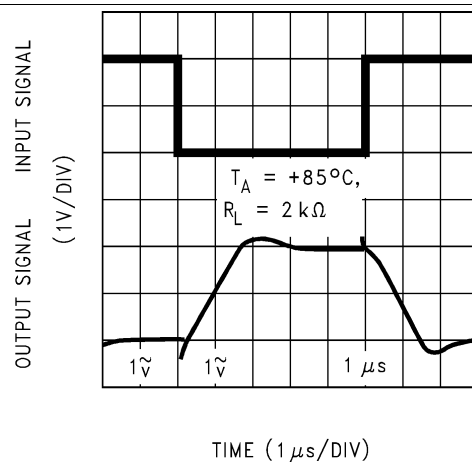
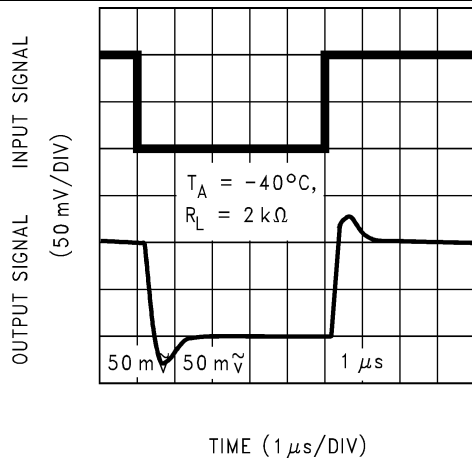
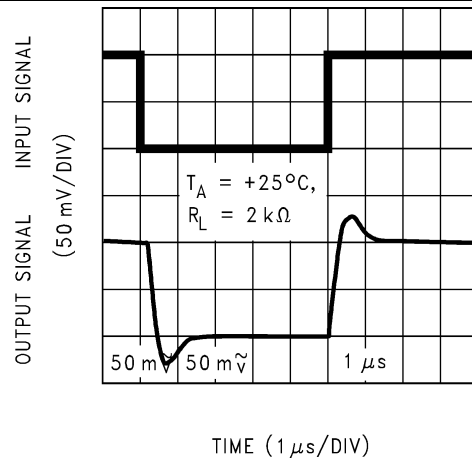
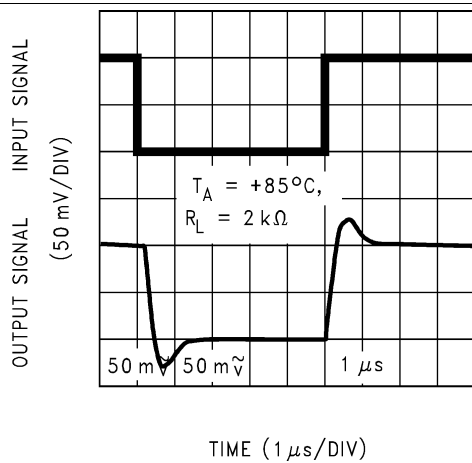
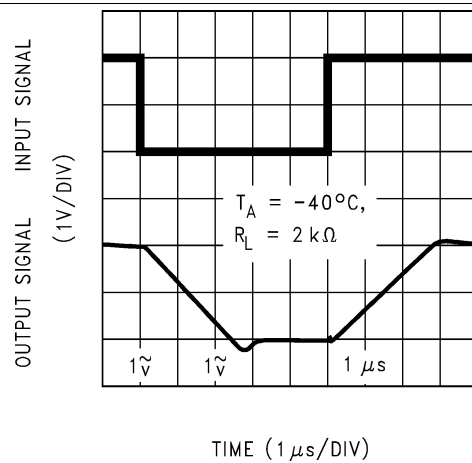
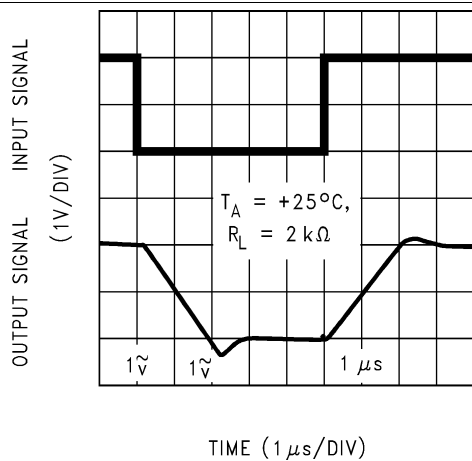
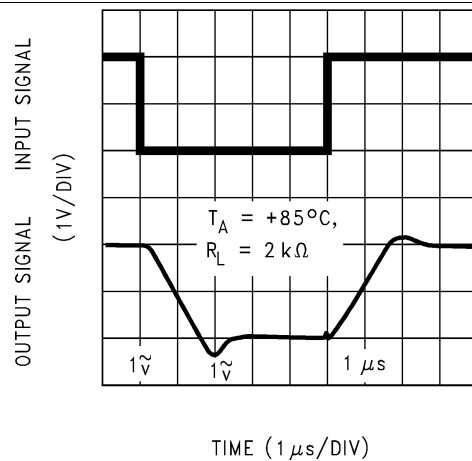

Figure 48. Inverting Large Signal Pulse Response

Typical Characteristics: 15 V (continued)

Figure 49. Noninverting Small Signal Pulse Response

Figure 50. Noninverting Small Signal Pulse Response

Figure 51. Noninverting Small Signal Pulse Response

Figure 52. Noninverting Large Signal Pulse Response

Figure 53. Noninverting Large Signal Pulse Response

Figure 54. Noninverting Large Signal Pulse Response

Typical Characteristics: 15 V (continued)

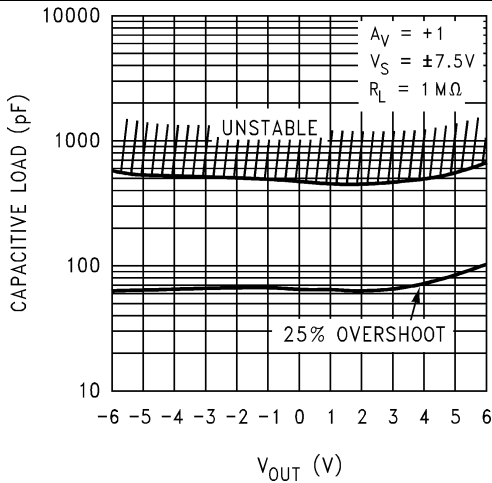

Figure 55. Stability vs Capacitive Load

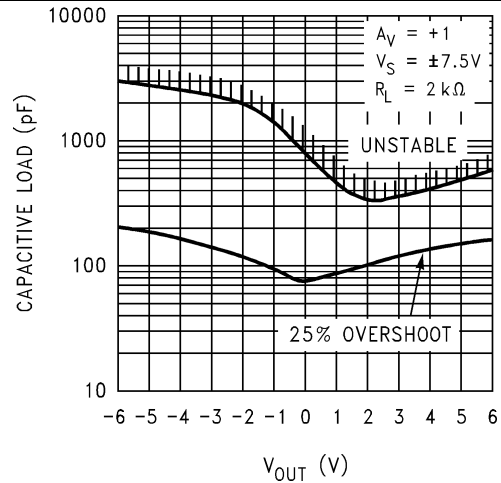

Figure 56. Stability vs Capacitive Load

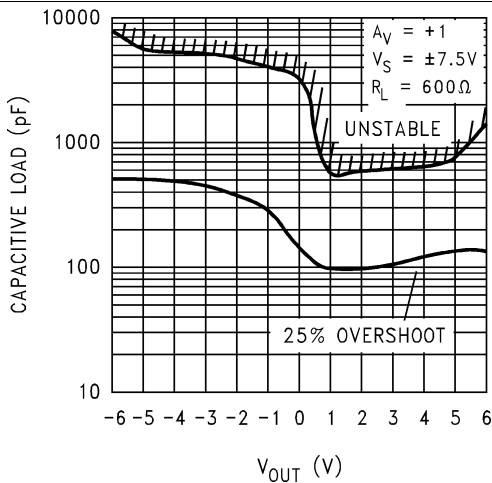

Figure 57. Stability vs Capacitive Load

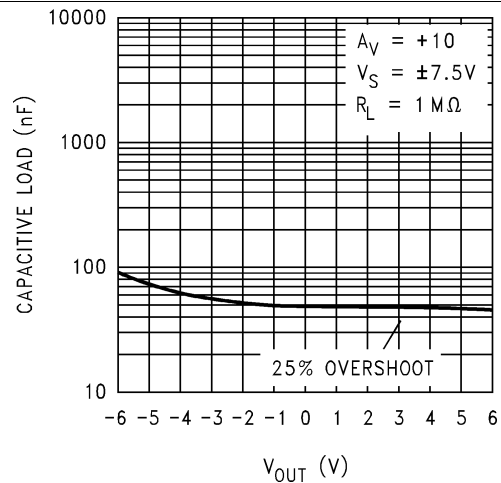

Figure 58. Stability vs Capacitive Load

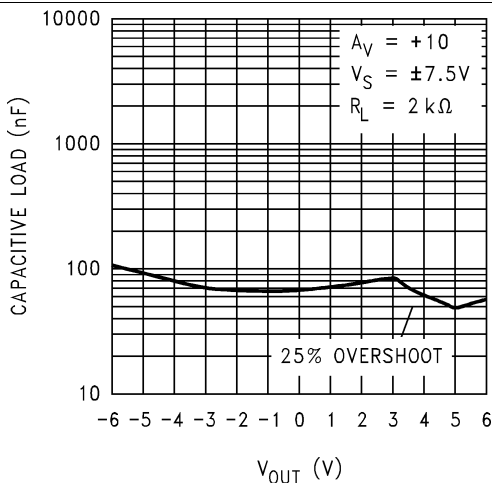

Figure 59. Stability vs Capacitive Load

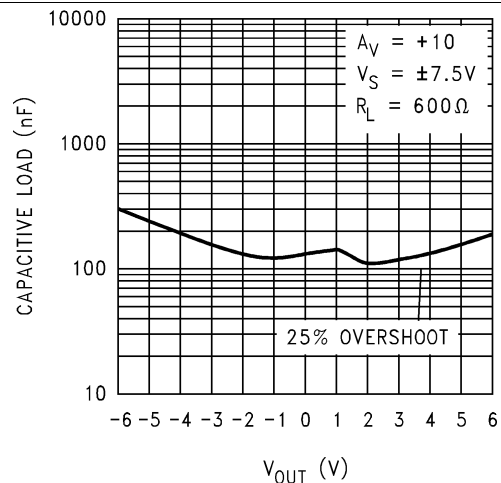

Figure 60. Stability vs Capacitive Load

7 Detailed Description

7.1 Overview

The LMC7101 is a single channel, low-power operational amplifier available in a space-saving SOT-23 package, offering rail-to-rail input and output operation across a wide range of power supply configurations. The LMC7101Q-Q1 is the automotive Q-grade variant.

7.2 Functional Block Diagram

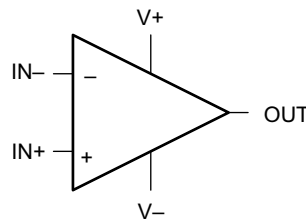

7.3 Feature Description

7.3.1 Benefits of the LMC7101 Tiny Amplifier

7.3.1.1 Size

The small footprint of the SOT-23-5 packaged tiny amplifier, (0.12 × 0.118 inches, 3.05 × 3 mm) saves space on printed circuit boards, and enable the design of smaller electronic products. Because they are easier to carry, many customers prefer smaller and lighter products.

7.3.1.2 Height

The 0.056 inches (1.43 mm) height of the tiny amplifier makes is suitable for use in a wide range of portable applications in which a thin profile is required.

7.3.1.3 Signal Integrity

Signals can pick up noise between the signal source and the amplifier. By using a physically smaller amplifier package, the tiny amplifier can be placed closer to the signal source, thus reducing noise pickup and increasing signal integrity. The tiny amplifier can also be placed next to the signal destination, such as a buffer, for the reference of an analog-to-digital converter.

7.3.1.4 Simplified Board Layout

The tiny amplifier can simplify board layout in several ways. Avoid long PCB traces by correctly placing amplifiers instead of routing signals to a dual or quad device.

By using multiple tiny amplifiers instead of duals or quads, complex signal routing and possibly crosstalk can be reduced.

7.3.1.5 Low THD

The high open-loop gain of the LMC7101 amp allows it to achieve very low audio distortion—typically 0.01% at 10 kHz with a 10-kΩ load at 5-V supplies. This makes the tiny amplifier an excellent for audio, modems, and low frequency signal processing.

7.3.1.6 Low Supply Current

The typical 0.5-mA supply current of the LMC7101 extends battery life in portable applications, and may allow the reduction of the size of batteries in some applications.

Feature Description (continued)

7.3.1.7 Wide Voltage Range

The LMC7101 is characterized at 15 V, 5 V and 3 V. Performance data is provided at these popular voltages. This wide voltage range makes the LMC7101 a good choice for devices where the voltage may vary over the life of the batteries.

7.4 Device Functional Modes

7.4.1 Input Common Mode

7.4.1.1 Voltage Range

The LMC7101 does not exhibit phase inversion when an input voltage exceeds the negative supply voltage. [Figure 61](#) shows an input voltage exceeding both supplies with no resulting phase inversion of the output.

The absolute maximum input voltage is 300-mV beyond either rail at room temperature. Voltages greatly exceeding this maximum rating, as in [Figure 62](#), can cause excessive current to flow in or out of the input pins, thus adversely affecting reliability.

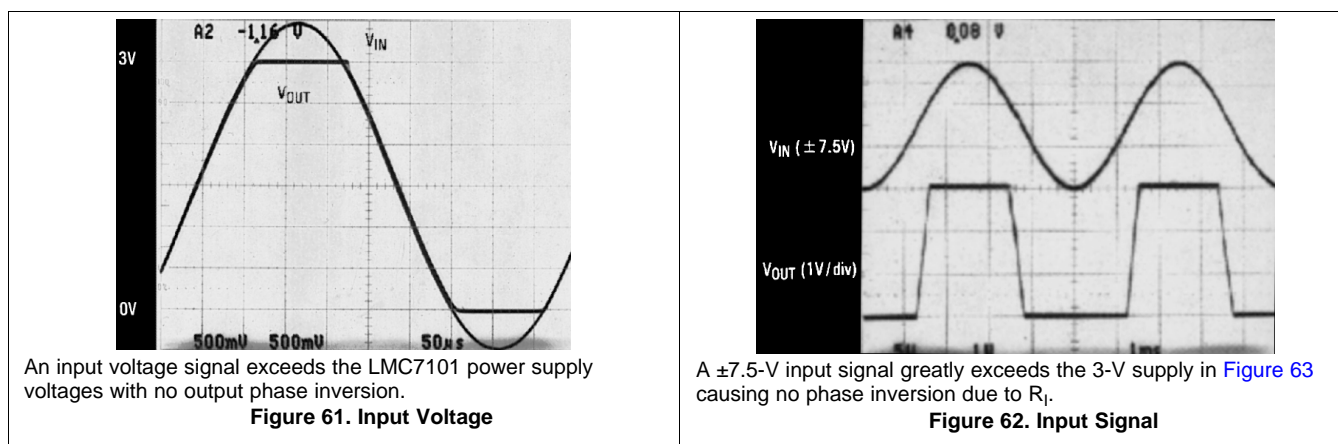

An input voltage signal exceeds the LMC7101 power supply voltages with no output phase inversion.

Figure 61. Input Voltage

A ± 7.5 -V input signal greatly exceeds the 3-V supply in [Figure 63](#) causing no phase inversion due to R_I .

Figure 62. Input Signal

Applications that exceed this rating must externally limit the maximum input current to ± 5 mA with an input resistor as shown in [Figure 63](#).

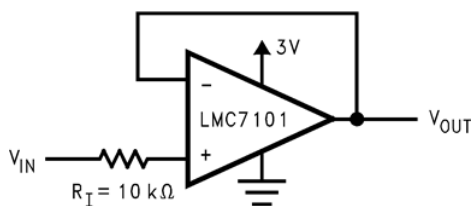

Figure 63. R_I Input Current Protection for Voltages Exceeding the Supply Voltage

8 Application and Implementation

NOTE

Information in the following applications sections is not part of the TI component specification, and TI does not warrant its accuracy or completeness. TI's customers are responsible for determining suitability of components for their purposes. Customers must validate and test their design implementation to confirm system functionality.

8.1 Application Information

8.1.1 Rail-to-Rail Output

The approximate output resistance of the LMC7101 is 180-Ω sourcing and 130-Ω sinking at $V_S = 3\text{ V}$ and 110-Ω sourcing and 80-Ω sinking at $V_S = 5\text{ V}$. Using the calculated output resistance, maximum output voltage swing can be estimated as a function of load.

8.1.2 Capacitive Load Tolerance

The LMC7101 can typically directly drive a 100-pF load with $V_S = 15\text{ V}$ at unity gain without oscillating. The unity gain follower is the most sensitive configuration. Direct capacitive loading reduces the phase margin of operational amplifiers. The combination of the output impedance and the capacitive load of the operational amplifier induces phase lag, which results in either an underdamped pulse response or oscillation.

Capacitive load compensation can be accomplished using resistive isolation as shown in [Figure 64](#). This simple technique is useful for isolating the capacitive input of multiplexers and A/D converters.

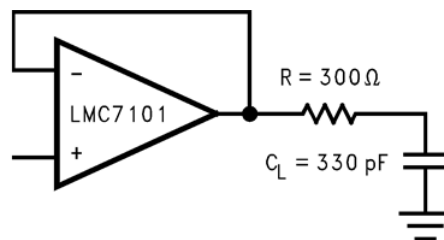

Figure 64. Resistive Isolation of a 330-pF Capacitive Load

8.1.3 Compensating for Input Capacitance When Using Large Value Feedback Resistors

When using very large value feedback resistors, (usually $> 500\text{ k}\Omega$) the large feedback resistance can react with the input capacitance due to transducers, photo diodes, and circuit board parasitics to reduce phase margins.

The effect of input capacitance can be compensated for by adding a feedback capacitor. The feedback capacitor (as in [Figure 65](#)), C_f is first estimated by [Equation 1](#) and [Equation 2](#), which typically provides significant overcompensation.

$$\frac{1}{2\pi R_1 C_{IN}} \geq \frac{1}{2\pi R_2 C_f} \quad (1)$$

$$R_1 C_{IN} \leq R_2 C_f \quad (2)$$

Printed circuit board stray capacitance may be larger or smaller than that of a breadboard, so the actual optimum value for C_f may be different. The values of C_f must be checked on the actual circuit (refer to *CMOS Quad Operational Amplifier (SNOSBZ3)* for a more detailed discussion).

Application Information (continued)

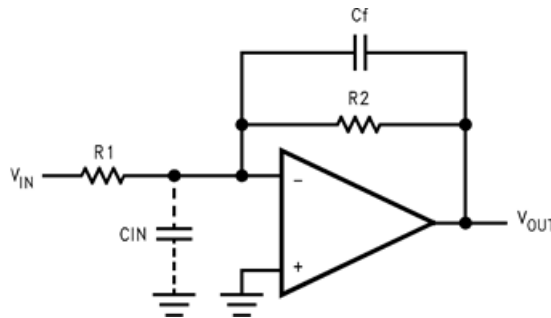

Figure 65. Cancelling the Effect of Input Capacitance

8.2 Typical Application

Figure 66 shows a high input impedance noninverting circuit. This circuit gives a closed-loop gain equal to the ratio of the sum of $R1$ and $R2$ to $R1$ and a closed-loop 3-dB bandwidth equal to the amplifier unity-gain frequency divided by the closed-loop gain. This design has the benefit of a very high input impedance, which is equal to the differential input impedance multiplied by loop gain. (Open loop gain/Closed loop gain.) In DC coupled applications, input impedance is not as important as input current and its voltage drop across the source resistance. The amplifier output will go into saturation if the input is allowed to float, which may be important if the amplifier must be switched from source to source.

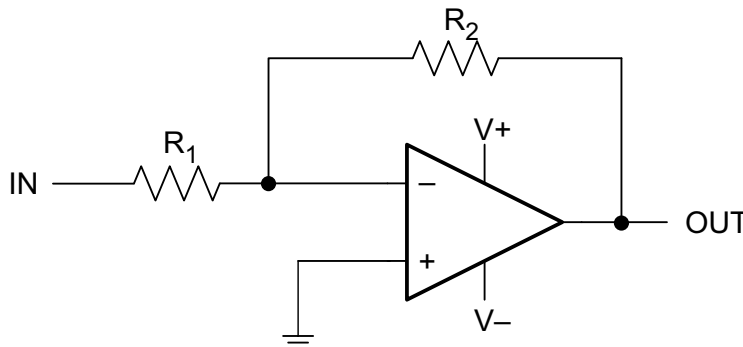

Figure 66. Example Application

Typical Application (continued)

8.2.1 Design Requirements

For this example application, the supply voltage is 5 V, and $100 \times \pm 5\%$ of noninverting gain is necessary. The signal input impedance is approximately 10 k Ω .

8.2.2 Detailed Design Procedure

Use the equation for a noninverting amplifier configuration; $G = 1 + R_2 / R_1$, set R_1 to 10 k Ω , and R_2 to $99 \times$ the value of R_1 , which would be 990 k Ω . Replacing the 990-k Ω resistor with a more readily available 1-M Ω resistor will result in a gain of 101, which is within the desired gain tolerance. The gain-frequency characteristic of the amplifier and its feedback network must be such that oscillation does not occur. To meet this condition, the phase shift through amplifier and feedback network must never exceed 180° for any frequency where the gain of the amplifier and its feedback network is greater than unity. In practical applications, the phase shift must not approach 180° because this is the situation of conditional stability. The most critical case occurs when the attenuation of the feedback network is zero.

8.2.3 Application Curve

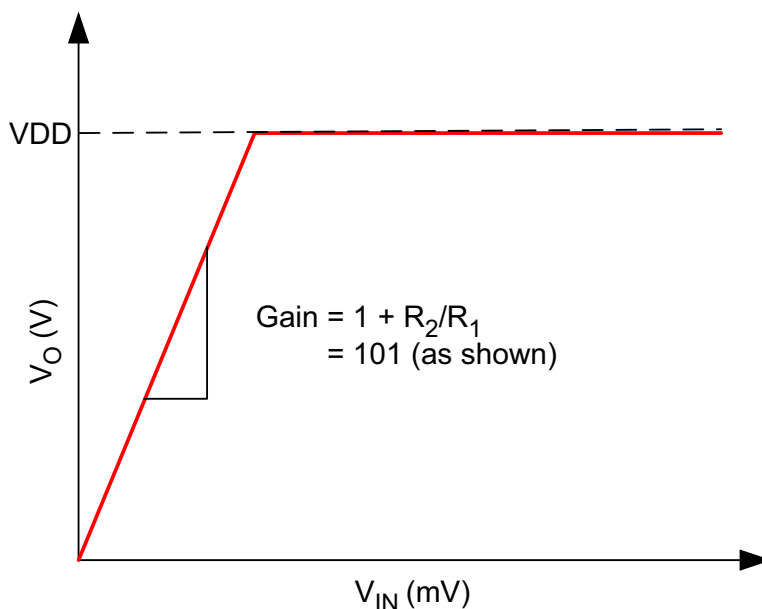

Figure 67. Output Response

9 Power Supply Recommendations

For proper operation, the power supplies must be decoupled. For supply decoupling, TI recommends placing 10-nF to 1- μ F capacitors as close as possible to the operational-amplifier power supply pins. For single supply configurations, place a capacitor between the V^+ and V^- supply pins. For dual supply configurations, place one capacitor between V^+ and ground, and place a second capacitor between V^- and ground. Bypass capacitors must have a low ESR of less than 0.1 Ω .

10 Layout

10.1 Layout Guidelines

Care must be taken to minimize the loop area formed by the bypass capacitor connection between supply pins and ground. A ground plane underneath the device is recommended; any bypass components to ground must have a nearby via to the ground plane. The optimum bypass capacitor placement is closest to the corresponding supply pin. Use of thicker traces from the bypass capacitors to the corresponding supply pins will lower the power-supply inductance and provide a more stable power supply.

The feedback components must be placed as close as possible to the device to minimize stray parasitics.

10.2 Layout Example

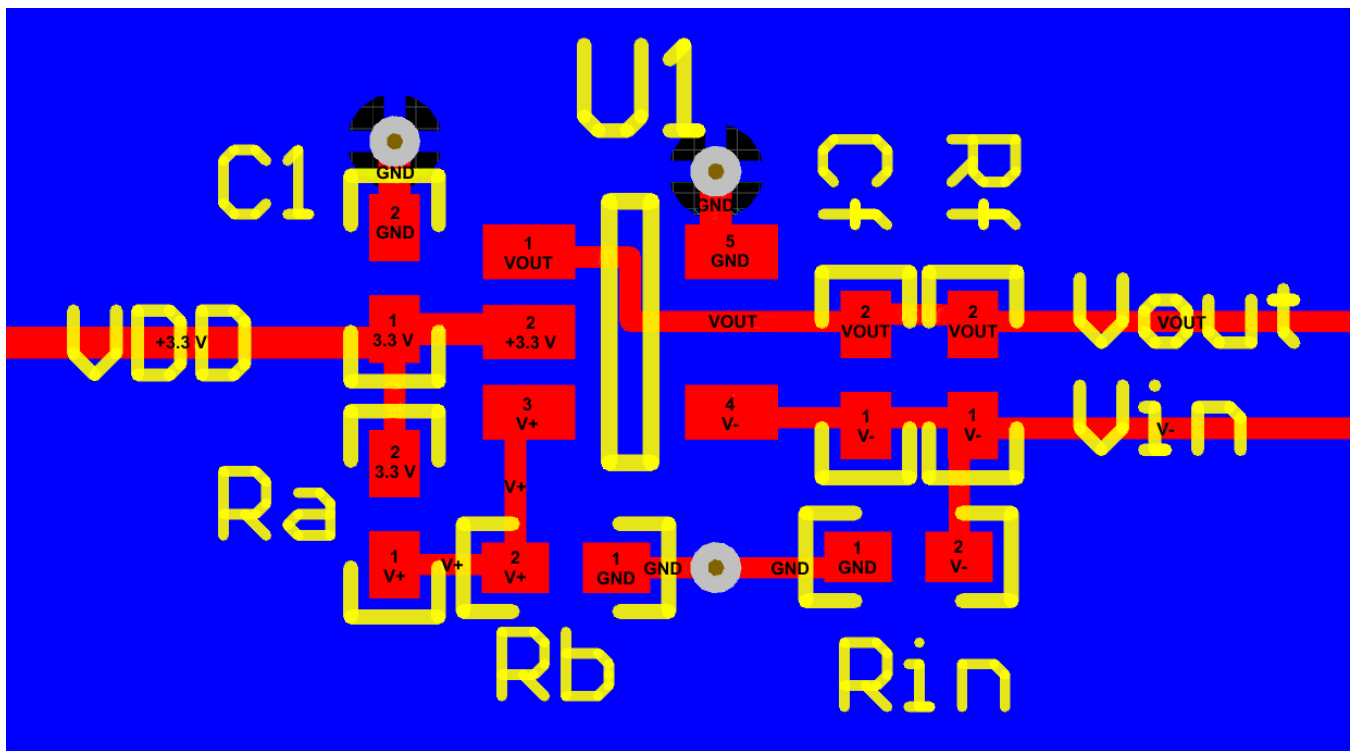

Figure 68. LMC7101 Example Layout

11 Device and Documentation Support

11.1 Documentation Support

For additional information, see *LMC660 CMOS Quad Operational Amplifier (SNOSBZ3)*.

11.2 Related Links

Table 1 lists quick access links. Categories include technical documents, support and community resources, tools and software, and quick access to sample or buy.

Table 1. Related Links

| PARTS | PRODUCT FOLDER | SAMPLE & BUY | TECHNICAL DOCUMENTS | TOOLS & SOFTWARE | SUPPORT & COMMUNITY |
|-------------|----------------------------|----------------------------|----------------------------|----------------------------|----------------------------|
| LMC7101 | Click here | Click here | Click here | Click here | Click here |
| LMC7101Q-Q1 | Click here | Click here | Click here | Click here | Click here |

11.3 Community Resource

The following links connect to TI community resources. Linked contents are provided "AS IS" by the respective contributors. They do not constitute TI specifications and do not necessarily reflect TI's views; see TI's [Terms of Use](#).

TI E2E™ Online Community *TI's Engineer-to-Engineer (E2E) Community*. Created to foster collaboration among engineers. At e2e.ti.com, you can ask questions, share knowledge, explore ideas and help solve problems with fellow engineers.

Design Support *TI's Design Support* Quickly find helpful E2E forums along with design support tools and contact information for technical support.

11.4 Trademarks

E2E is a trademark of Texas Instruments.
All other trademarks are the property of their respective owners.

11.5 Electrostatic Discharge Caution



These devices have limited built-in ESD protection. The leads should be shorted together or the device placed in conductive foam during storage or handling to prevent electrostatic damage to the MOS gates.

11.6 Glossary

SLYZ022 — *TI Glossary*.

This glossary lists and explains terms, acronyms, and definitions.

12 Mechanical, Packaging, and Orderable Information

The following pages include mechanical, packaging, and orderable information. This information is the most current data available for the designated devices. This data is subject to change without notice and revision of this document. For browser-based versions of this data sheet, refer to the left-hand navigation.

PACKAGING INFORMATION

| Orderable Device | Status (1) | Package Type | Package Drawing | Pins | Package Qty | Eco Plan (2) | Lead finish/ Ball material (6) | MSL Peak Temp (3) | Op Temp (°C) | Device Marking (4/5) | Samples |
|-------------------|---------------|--------------|-----------------|------|-------------|-----------------|--------------------------------------|----------------------|--------------|-------------------------|-------------------------|
| LMC7101AIM5X/NOPB | ACTIVE | SOT-23 | DBV | 5 | 3000 | RoHS & Green | NIPDAU SN | Level-1-260C-UNLIM | -40 to 85 | A00A | Samples |
| LMC7101BIM5/NOPB | OBSOLETE | SOT-23 | DBV | 5 | | TBD | Call TI | Call TI | -40 to 85 | A00B | |
| LMC7101BIM5X/NOPB | ACTIVE | SOT-23 | DBV | 5 | 3000 | RoHS & Green | NIPDAU SN | Level-1-260C-UNLIM | -40 to 85 | A00B | Samples |
| LMC7101QM5/NOPB | OBSOLETE | SOT-23 | DBV | 5 | | TBD | Call TI | Call TI | -40 to 125 | AT6A | |
| LMC7101QM5X/NOPB | ACTIVE | SOT-23 | DBV | 5 | 3000 | RoHS & Green | Call TI SN | Level-1-260C-UNLIM | -40 to 125 | AT6A | Samples |

(1) The marketing status values are defined as follows:

ACTIVE: Product device recommended for new designs.

LIFEBUY: TI has announced that the device will be discontinued, and a lifetime-buy period is in effect.

NRND: Not recommended for new designs. Device is in production to support existing customers, but TI does not recommend using this part in a new design.

PREVIEW: Device has been announced but is not in production. Samples may or may not be available.

OBSOLETE: TI has discontinued the production of the device.

(2) **RoHS:** TI defines "RoHS" to mean semiconductor products that are compliant with the current EU RoHS requirements for all 10 RoHS substances, including the requirement that RoHS substance do not exceed 0.1% by weight in homogeneous materials. Where designed to be soldered at high temperatures, "RoHS" products are suitable for use in specified lead-free processes. TI may reference these types of products as "Pb-Free".

RoHS Exempt: TI defines "RoHS Exempt" to mean products that contain lead but are compliant with EU RoHS pursuant to a specific EU RoHS exemption.

Green: TI defines "Green" to mean the content of Chlorine (Cl) and Bromine (Br) based flame retardants meet JS709B low halogen requirements of <=1000ppm threshold. Antimony trioxide based flame retardants must also meet the <=1000ppm threshold requirement.

(3) MSL, Peak Temp. - The Moisture Sensitivity Level rating according to the JEDEC industry standard classifications, and peak solder temperature.

(4) There may be additional marking, which relates to the logo, the lot trace code information, or the environmental category on the device.

(5) Multiple Device Markings will be inside parentheses. Only one Device Marking contained in parentheses and separated by a "~" will appear on a device. If a line is indented then it is a continuation of the previous line and the two combined represent the entire Device Marking for that device.

(6) Lead finish/Ball material - Orderable Devices may have multiple material finish options. Finish options are separated by a vertical ruled line. Lead finish/Ball material values may wrap to two lines if the finish value exceeds the maximum column width.

Important Information and Disclaimer: The information provided on this page represents TI's knowledge and belief as of the date that it is provided. TI bases its knowledge and belief on information provided by third parties, and makes no representation or warranty as to the accuracy of such information. Efforts are underway to better integrate information from third parties. TI has taken and

continues to take reasonable steps to provide representative and accurate information but may not have conducted destructive testing or chemical analysis on incoming materials and chemicals. TI and TI suppliers consider certain information to be proprietary, and thus CAS numbers and other limited information may not be available for release.

In no event shall TI's liability arising out of such information exceed the total purchase price of the TI part(s) at issue in this document sold by TI to Customer on an annual basis.

TAPE AND REEL INFORMATION



QUADRANT ASSIGNMENTS FOR PIN 1 ORIENTATION IN TAPE



*All dimensions are nominal

| Device | Package Type | Package Drawing | Pins | SPQ | Reel Diameter (mm) | Reel Width W1 (mm) | A0 (mm) | B0 (mm) | K0 (mm) | P1 (mm) | W (mm) | Pin1 Quadrant |
|-------------------|--------------|-----------------|------|------|--------------------|--------------------|---------|---------|---------|---------|--------|---------------|
| LMC7101AIM5 | SOT-23 | DBV | 5 | 1000 | 178.0 | 8.4 | 3.2 | 3.2 | 1.4 | 4.0 | 8.0 | Q3 |
| LMC7101AIM5/NOPB | SOT-23 | DBV | 5 | 1000 | 178.0 | 8.4 | 3.2 | 3.2 | 1.4 | 4.0 | 8.0 | Q3 |
| LMC7101AIM5X/NOPB | SOT-23 | DBV | 5 | 3000 | 178.0 | 8.4 | 3.2 | 3.2 | 1.4 | 4.0 | 8.0 | Q3 |
| LMC7101BIM5 | SOT-23 | DBV | 5 | 1000 | 178.0 | 8.4 | 3.2 | 3.2 | 1.4 | 4.0 | 8.0 | Q3 |
| LMC7101BIM5/NOPB | SOT-23 | DBV | 5 | 1000 | 178.0 | 8.4 | 3.2 | 3.2 | 1.4 | 4.0 | 8.0 | Q3 |
| LMC7101BIM5X | SOT-23 | DBV | 5 | 3000 | 178.0 | 8.4 | 3.2 | 3.2 | 1.4 | 4.0 | 8.0 | Q3 |
| LMC7101BIM5X/NOPB | SOT-23 | DBV | 5 | 3000 | 180.0 | 8.4 | 3.2 | 3.2 | 1.4 | 4.0 | 8.0 | Q3 |
| LMC7101BIM5X/NOPB | SOT-23 | DBV | 5 | 3000 | 178.0 | 8.4 | 3.2 | 3.2 | 1.4 | 4.0 | 8.0 | Q3 |
| LMC7101BIM5X/NOPB | SOT-23 | DBV | 5 | 3000 | 180.0 | 8.4 | 3.2 | 3.2 | 1.4 | 4.0 | 8.0 | Q3 |
| LMC7101QM5/NOPB | SOT-23 | DBV | 5 | 1000 | 178.0 | 8.4 | 3.2 | 3.2 | 1.4 | 4.0 | 8.0 | Q3 |
| LMC7101QM5X/NOPB | SOT-23 | DBV | 5 | 3000 | 178.0 | 8.4 | 3.2 | 3.2 | 1.4 | 4.0 | 8.0 | Q3 |

TAPE AND REEL BOX DIMENSIONS

*All dimensions are nominal

| Device | Package Type | Package Drawing | Pins | SPQ | Length (mm) | Width (mm) | Height (mm) |
|-------------------|--------------|-----------------|------|------|-------------|------------|-------------|
| LMC7101AIM5 | SOT-23 | DBV | 5 | 1000 | 208.0 | 191.0 | 35.0 |
| LMC7101AIM5/NOPB | SOT-23 | DBV | 5 | 1000 | 208.0 | 191.0 | 35.0 |
| LMC7101AIM5X/NOPB | SOT-23 | DBV | 5 | 3000 | 208.0 | 191.0 | 35.0 |
| LMC7101BIM5 | SOT-23 | DBV | 5 | 1000 | 208.0 | 191.0 | 35.0 |
| LMC7101BIM5/NOPB | SOT-23 | DBV | 5 | 1000 | 208.0 | 191.0 | 35.0 |
| LMC7101BIM5X | SOT-23 | DBV | 5 | 3000 | 208.0 | 191.0 | 35.0 |
| LMC7101BIM5X/NOPB | SOT-23 | DBV | 5 | 3000 | 210.0 | 185.0 | 35.0 |
| LMC7101BIM5X/NOPB | SOT-23 | DBV | 5 | 3000 | 208.0 | 191.0 | 35.0 |
| LMC7101BIM5X/NOPB | SOT-23 | DBV | 5 | 3000 | 210.0 | 185.0 | 35.0 |
| LMC7101QM5/NOPB | SOT-23 | DBV | 5 | 1000 | 208.0 | 191.0 | 35.0 |
| LMC7101QM5X/NOPB | SOT-23 | DBV | 5 | 3000 | 208.0 | 191.0 | 35.0 |

EXAMPLE BOARD LAYOUT

DBV0005A

SOT-23 - 1.45 mm max height

SMALL OUTLINE TRANSISTOR



LAND PATTERN EXAMPLE
EXPOSED METAL SHOWN
SCALE:15X



SOLDER MASK DETAILS

4214839/K 08/2024

NOTES: (continued)

- 6. Publication IPC-7351 may have alternate designs.
- 7. Solder mask tolerances between and around signal pads can vary based on board fabrication site.

EXAMPLE STENCIL DESIGN

DBV0005A

SOT-23 - 1.45 mm max height

SMALL OUTLINE TRANSISTOR



SOLDER PASTE EXAMPLE
BASED ON 0.125 mm THICK STENCIL
SCALE:15X

4214839/K 08/2024

NOTES: (continued)

8. Laser cutting apertures with trapezoidal walls and rounded corners may offer better paste release. IPC-7525 may have alternate design recommendations.
9. Board assembly site may have different recommendations for stencil design.

IMPORTANT NOTICE AND DISCLAIMER

TI PROVIDES TECHNICAL AND RELIABILITY DATA (INCLUDING DATA SHEETS), DESIGN RESOURCES (INCLUDING REFERENCE DESIGNS), APPLICATION OR OTHER DESIGN ADVICE, WEB TOOLS, SAFETY INFORMATION, AND OTHER RESOURCES "AS IS" AND WITH ALL FAULTS, AND DISCLAIMS ALL WARRANTIES, EXPRESS AND IMPLIED, INCLUDING WITHOUT LIMITATION ANY IMPLIED WARRANTIES OF MERCHANTABILITY, FITNESS FOR A PARTICULAR PURPOSE OR NON-INFRINGEMENT OF THIRD PARTY INTELLECTUAL PROPERTY RIGHTS.

These resources are intended for skilled developers designing with TI products. You are solely responsible for (1) selecting the appropriate TI products for your application, (2) designing, validating and testing your application, and (3) ensuring your application meets applicable standards, and any other safety, security, regulatory or other requirements.

These resources are subject to change without notice. TI grants you permission to use these resources only for development of an application that uses the TI products described in the resource. Other reproduction and display of these resources is prohibited. No license is granted to any other TI intellectual property right or to any third party intellectual property right. TI disclaims responsibility for, and you will fully indemnify TI and its representatives against, any claims, damages, costs, losses, and liabilities arising out of your use of these resources.

TI's products are provided subject to [TI's Terms of Sale](#) or other applicable terms available either on [ti.com](https://www.ti.com) or provided in conjunction with such TI products. TI's provision of these resources does not expand or otherwise alter TI's applicable warranties or warranty disclaimers for TI products.

TI objects to and rejects any additional or different terms you may have proposed.

Mailing Address: Texas Instruments, Post Office Box 655303, Dallas, Texas 75265
Copyright © 2024, Texas Instruments Incorporated