

SNx4LVC86A Quadruple 2-Input Exclusive-OR Gates

1 Features

- Operate from 1.65V to 3.6V
- Specified from -40°C to 85°C , -40°C to 125°C , and -55°C to 125°C
- Inputs accept voltages to 5.5V
- Max t_{pd} of 4.6ns at 3.3V
- Typical V_{OLP} (output ground bounce) $<0.8\text{V}$ at $V_{CC} = 3.3\text{V}$, $T_A = 25^{\circ}\text{C}$
- Typical V_{OHV} (output V_{OH} undershoot) $>2\text{V}$ at $V_{CC} = 3.3\text{V}$, $T_A = 25^{\circ}\text{C}$
- Latch-up performance exceeds 250 mA per JESD 17
- ESD protection exceeds JESD 22
 - 2000V human-body model (A114-A)
 - 1000V charged-device model (C101)

2 Applications

- AV receiver
- Audio dock: portable
- Blu-ray player and home theater
- MP3 player or recorder
- Personal digital assistant (PDA)
- Power: telecom/server AC/DC supply: single controller: analog and digital
- Solid state drive (SSD): client and enterprise
- TV: LCD, digital, and high-definition (HDTV)
- Tablet: enterprise
- Video analytics: server
- Wireless headset, keyboard, and mouse

3 Description

The SN54LVC86A quadruple 2-input exclusive-OR gate is designed for 2.7V to 3.6V V_{CC} operation, and the SN74LVC86A quadruple 2-input exclusive-OR gate is designed for 1.65V to 3.6V V_{CC} operation.

PART NUMBER	PACKAGE ⁽¹⁾	PACKAGE SIZE ⁽²⁾	BODY SIZE ⁽³⁾
SNx4LVC86A	BQA (WQFN, 14)	3mm × 2.5mm	3mm × 2.5mm
	RGY (VQFN, 14)	3.50mm × 3.50mm	3.50mm × 3.50mm
	D (SOIC, 14)	8.65mm × 6mm	8.65mm × 3.91mm
	NS (SOP, 14)	10.2mm × 7.8mm	10.20mm × 5.30mm
	DB (SSOP, 14)	6.2mm × 7.8mm	6.20mm × 5.30mm
	PW (TSSOP, 14)	5mm × 6.4mm	5.00mm × 4.40mm
	W (CFP, 14)	9.21mm × 9mm	9.21mm × 6.29mm
	FK (LCCC, 20)	8.89mm × 8.89mm	8.89mm × 8.89mm

- (1) For more information, see [Mechanical, Packaging, and Orderable Information](#).
- (2) The package size (length × width) is a nominal value and includes pins, where applicable.
- (3) The body size (length × width) is a nominal value and does not include pins.

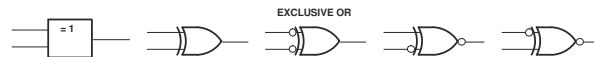

These five equivalent exclusive-OR symbols are valid for an SN74LVC86A gate in positive logic; negation may be shown at any two ports.

Exclusive-OR Logic



Table of Contents

1 Features	1	7 Detailed Description	9
2 Applications	1	7.1 Overview.....	9
3 Description	1	7.2 Functional Block Diagram.....	9
4 Pin Configuration and Functions	3	7.3 Feature Description.....	9
5 Specifications	4	7.4 Device Functional Modes.....	9
5.1 Absolute Maximum Ratings.....	4	8 Application and Implementation	10
5.2 ESD Ratings.....	4	8.1 Application Information.....	10
5.3 Recommended Operating Conditions, SN54LVC86A	4	8.2 Typical Application.....	10
5.4 Recommended Operating Conditions, SN74LVC86A	4	8.3 Layout.....	11
5.5 Thermal Information.....	5	9 Device and Documentation Support	13
5.6 Electrical Characteristics, SN54LVC86A	5	9.1 Documentation Support (Analog).....	13
5.7 Electrical Characteristics, SN74LVC86A	6	9.2 Receiving Notification of Documentation Updates...	13
5.8 Switching Characteristics, SN54LVC86A	6	9.3 Support Resources.....	13
5.9 Switching Characteristics, SN74LVC86A	6	9.4 Trademarks.....	13
5.10 Operating Characteristics.....	7	9.5 Electrostatic Discharge Caution.....	13
5.11 Typical Characteristics.....	7	9.6 Glossary.....	13
6 Parameter Measurement Information	8	10 Revision History	13
		11 Mechanical, Packaging, and Orderable Information	14

4 Pin Configuration and Functions

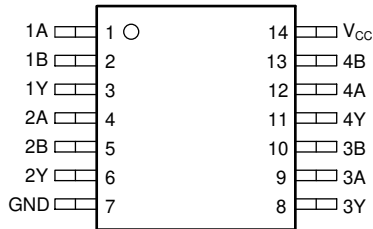

Figure 4-1. SN54LVC86A J or W Package, 14-Pin CDIP or CFP; SN74LVC86A D, DB, NS, or PW Package, 14-Pin SOIC, SSOP, SOP or TSSOP (Top View)

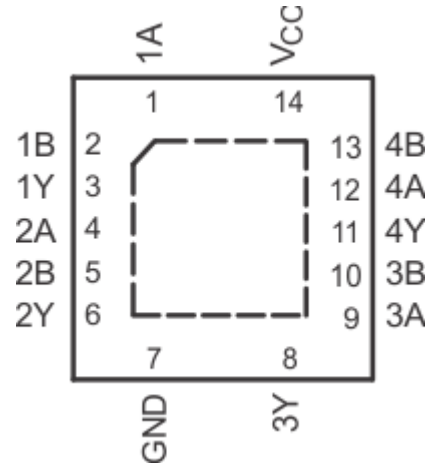

Figure 4-2. SN74LVC86A BQA or RGY Package, 14-Pin WQFN or VQFN (Top View)

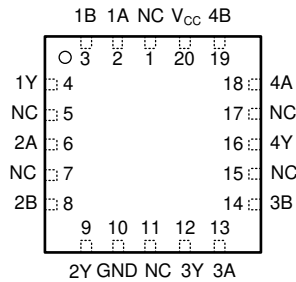

Figure 4-3. SN54LVC86A FK Package, 14-Pin LCCC (Top View)

Table 4-1. Pin Functions

NO.	PIN		I/O	DESCRIPTION
	J, W, D, DB, NS, PW, RGY	FK		
	14 PINS	20 PINS		
1A	1	2	I	Gate 1 input
1B	2	3	I	Gate 1 input
1Y	3	4	O	Gate 1 output
2A	4	6	I	Gate 2 input
2B	5	8	I	Gate 2 input
2Y	6	9	O	Gate 2 output
3Y	8	12	O	Gate 3 output
3A	9	13	I	Gate 3 input
3B	10	14	I	Gate 3 input
4Y	11	16	O	Gate 4 output
4A	12	18	I	Gate 4 input
4B	13	19	I	Gate 4 input
GND	7	10	—	Ground Pin
NC	—	1, 5, 7, 11, 15, 17	—	Do not connect
V _{CC}	14	20	—	Power Pin

5 Specifications

5.1 Absolute Maximum Ratings

over operating free-air temperature range (unless otherwise noted)

		MIN	MAX	UNIT
V _{CC}	Supply voltage range	-0.5	6.5	V
V _I	Input voltage range ⁽¹⁾	-0.5	6.5	V
V _O	Output voltage range ^{(1) (2)}	-0.5	V _{CC} + 0.5	V
I _{IK}	Input clamp current	V _I < 0		-50 mA
I _{OK}	Output clamp current	V _O < 0		-50 mA
I _O	Continuous output current			±50 mA
	Continuous current through V _{CC} or GND			±100 mA
P _{tot}	Power dissipation	T _A = -40°C to 125°C ^{(3) (4)}		500 mW
T _{stg}	Storage temperature range	-65	150	°C

(1) The input negative-voltage and output voltage ratings may be exceeded if the input and output current ratings are observed.

(2) The value of V_{CC} is provided in the recommended operating conditions table.

(3) For the D package: above 70°C, the value of P_{tot} derates linearly with 8 mW/K.

(4) For the DB, DGV, NS, and PW packages: above 60°C, the value of P_{tot} derates linearly with 5.5 mW/K.

5.2 ESD Ratings

			VALUE	UNIT
V _(ESD)	Electrostatic discharge	Human body model (HBM), per ANSI/ESDA/JEDEC JS-001, all pins ⁽¹⁾	±2000	V
		Charged device model (CDM), per JEDEC specification JESD22-C101, all pins ⁽²⁾	±1000	

(1) JEDEC document JEP155 states that 500-V HBM allows safe manufacturing with a standard ESD control process.

(2) JEDEC document JEP157 states that 250-V CDM allows safe manufacturing with a standard ESD control process.

5.3 Recommended Operating Conditions, SN54LVC86A

over operating free-air temperature range (unless otherwise noted)

		SN54LVC86A		UNIT
		-55 TO 125°C		
		MIN	MAX	
V _{CC}	Supply voltage	Operating	2 3.6	V
		Data retention only	1.5	
V _{IH}	High-level input voltage	V _{CC} = 2.7 V to 3.6 V		V
V _{IL}	Low-level input voltage	V _{CC} = 2.7 V to 3.6 V		0.8 V
V _I	Input voltage	0	5.5	V
V _O	Output voltage	0	V _{CC}	V
I _{OH}	High-level output current	V _{CC} = 2.7 V	-12	mA
		V _{CC} = 3 V	-24	
I _{OL}	Low-level output current	V _{CC} = 2.7 V	12	mA
		V _{CC} = 3 V	24	
Δt/Δv	Input transition rise or fall rate			9 ns/V

5.4 Recommended Operating Conditions, SN74LVC86A

over operating free-air temperature range (unless otherwise noted)

		SN74LVC86A						UNIT		
		T _A = 25°C		–40 TO 85°C		–40 TO 125°C				
		MIN	MAX	MIN	MAX	MIN	MAX			
V _{CC}	Supply voltage	Operating		1.65	3.6	1.65	3.6	1.65	3.6	V
		Data retention only		1.5		1.5		1.5		
V _{IH}	High-level input voltage	V _{CC} = 1.65 V to 1.95 V		0.65 × V _{CC}		0.65 × V _{CC}		0.65 × V _{CC}		V
		V _{CC} = 2.3 V to 2.7 V		1.7		1.7		1.7		
		V _{CC} = 2.7 V to 3.6 V		2		2		2		
V _{IL}	Low-level input voltage	V _{CC} = 1.65 V to 1.95 V		0.35 × V _{CC}		0.35 × V _{CC}		0.35 × V _{CC}		V
		V _{CC} = 2.3 V to 2.7 V		0.7		0.7		0.7		
		V _{CC} = 2.7 V to 3.6 V		0.8		0.8		0.8		
V _I	Input voltage	0	5.5	0	5.5	0	5.5	0	5.5	V
V _O	Output voltage	0	V _{CC}	0	V _{CC}	0	V _{CC}	0	V _{CC}	V
I _{OH}	High-level output current	V _{CC} = 1.65 V		–4		–4		–4		mA
		V _{CC} = 2.3 V		–8		–8		–8		
		V _{CC} = 2.7 V		–12		–12		–12		
		V _{CC} = 3 V		–24		–24		–24		
I _{OL}	Low-level output current	V _{CC} = 1.65 V		4		4		4		mA
		V _{CC} = 2.3 V		8		8		8		
		V _{CC} = 2.7 V		12		12		12		
		V _{CC} = 3 V		24		24		24		
Δt/Δv	Input transition rise or fall rate	9		9		9		9		ns/V

5.5 Thermal Information

THERMAL METRIC ⁽¹⁾		SN74LVC86A						UNIT
		BQA	D	DB	NS	PW	RGY	
		14 PINS	14 PINS	14 PINS	14 PINS	14 PINS	14 PINS	
R _{θJA}	Junction-to-ambient thermal resistance	102.3	127.8	96	123.8	150.8	92.1	°C/W

(1) For more information about traditional and new thermal metrics, see the *IC Package Thermal Metrics* application report, [SPRA953](#).

5.6 Electrical Characteristics, SN54LVC86A

over operating free-air temperature range (unless otherwise noted)

PARAMETER	TEST CONDITIONS	V _{CC}	SN54LVC86A			UNIT	
			–55 TO 125°C				
			MIN	TYP	MAX		
V _{OH}	I _{OH} = –100 μA	2.7 V to 3.6 V	V _{CC} – 0.2			V	
	I _{OH} = –12 mA	2.7 V	2.2				
		3 V	2.4				
	I _{OH} = –24 mA	3 V	2.2				
V _{OL}	I _{OL} = 100 μA	2.7 V to 3.6 V	0.2			V	
	I _{OL} = 12 mA	2.7 V	0.4				
	I _{OL} = 24 mA	3 V	0.55				
I _I	V _I = 5.5 V or GND	3.6 V	±5			μA	
I _{CC}	V _I = V _{CC} or GND	I _O = 0	3.6 V	10			μA

SN54LVC86A, SN74LVC86A

SCAS288R – JANUARY 1993 – REVISED AUGUST 2024

over operating free-air temperature range (unless otherwise noted)

PARAMETER	TEST CONDITIONS	V _{CC}	SN54LVC86A			UNIT
			–55 TO 125°C			
			MIN	TYP	MAX	
ΔI_{CC}	One input at V _{CC} – 0.6 V, Other inputs at V _{CC} or GND	2.7 V to 3.6 V	500			μA
C _i	V _I = V _{CC} or GND	3.3 V	5 ⁽¹⁾			pF

 (1) T_A = 25°C

5.7 Electrical Characteristics, SN74LVC86A

over operating free-air temperature range (unless otherwise noted)

PARAMETER	TEST CONDITIONS	V _{CC}	SN74LVC86A						UNIT	
			T _A = 25°C			–40 TO 85°C		–40 TO 125°C		
			MIN	TYP	MAX	MIN	MAX	MIN		MAX
V _{OH}	I _{OH} = –100μA	1.65V to 3.6V	V _{CC} – 0.2			V _{CC} – 0.2		V _{CC} – 0.3		V
	I _{OH} = –4mA	1.65V	1.29			1.2		1.05		
	I _{OH} = –8mA	2.3V	1.9			1.7		1.55		
	I _{OH} = –12mA	2.7V	2.2			2.2		2.05		
		3V	2.4			2.4		2.25		
I _{OH} = –24mA	3V	2.3			2.2		2			
V _{OL}	I _{OL} = 100μA	1.65V to 3.6V	0.1			0.2		0.3		V
	I _{OL} = 4mA	1.65V	0.24			0.45		0.6		
	I _{OL} = 8mA	2.3V	0.3			0.7		0.75		
	I _{OL} = 12mA	2.7V	0.4			0.4		0.6		
	I _{OL} = 24mA	3V	0.55			0.55		0.8		
I _I	V _I = 5.5V or GND	3.6V	±1			±5		±20		μA
I _{CC}	V _I = V _{CC} or GND I _O = 0	3.6V	1			10		40		μA
ΔI_{CC}	One input at V _{CC} – 0.6V, Other inputs at V _{CC} or GND	2.7V to 3.6V	500			500		5000		μA
C _i	V _I = V _{CC} or GND	3.3V	5							pF

5.8 Switching Characteristics, SN54LVC86A

 over recommended operating free-air temperature range (unless otherwise noted) (see [Load Circuit and Voltage Waveforms](#))

PARAMETER	FROM (INPUT)	TO (OUTPUT)	V _{CC}	SN54LVC86A		UNIT
				–55 TO 125°C		
				MIN	MAX	
t _{pd}	A	Y	2.7 V	5.6		ns
			3.3 V ± 0.3 V	1	4.6	

5.9 Switching Characteristics, SN74LVC86A

 over recommended operating free-air temperature range (unless otherwise noted) (see [Load Circuit and Voltage Waveforms](#))

PARAMETER	FROM (INPUT)	TO (OUTPUT)	V _{CC}	SN74LVC86A						UNIT	
				T _A = 25°C			–40 TO 85°C		–40 TO 125°C		
				MIN	TYP	MAX	MIN	MAX	MIN		MAX
t _{pd}	A	Y	1.8V ± 0.15V	1	4.1	9.4	1	9.9	1	11.4	ns
			2.5V ± 0.2V	1	2.9	7.1	1	7.6	1	9.7	
			2.7V	1	2.8	5.4	1	5.6	1	7.1	
			3.3V ± 0.3V	1	2.5	4.4	1	4.6	1	5.8	

over recommended operating free-air temperature range (unless otherwise noted) (see [Load Circuit and Voltage Waveforms](#))

PARAMETER	FROM (INPUT)	TO (OUTPUT)	V _{CC}	SN74LVC86A						UNIT	
				T _A = 25°C			-40 TO 85°C		-40 TO 125°C		
				MIN	TYP	MAX	MIN	MAX	MIN		MAX
t _{sk(o)}			3.3V ± 0.3V					1	1.5	ns	

5.10 Operating Characteristics

T_A = 25°C

PARAMETER	TEST CONDITIONS	V _{CC}	TYP	UNIT
C _{pd} Power dissipation capacitance per gate	f = 10 MHz	1.8V	6.5	pF
		2.5V	7.5	
		3.3V	8.5	

5.11 Typical Characteristics

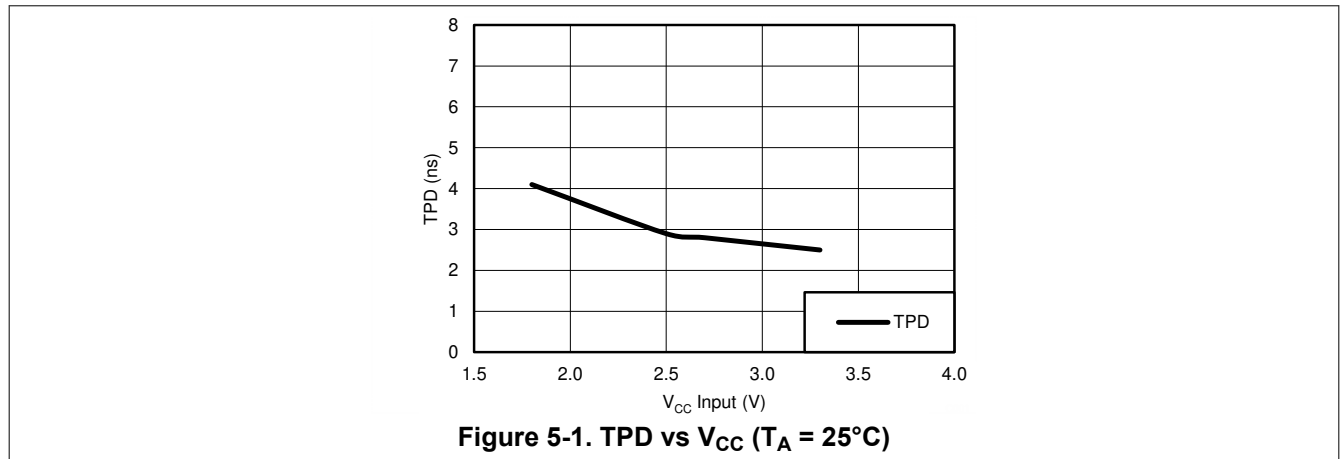

6 Parameter Measurement Information

Phase relationships between waveforms were chosen arbitrarily for the examples listed in the following table. All input pulses are supplied by generators having the following characteristics: PRR ≤ 1MHz, Z_O = 50Ω, t_t ≤ 2.5ns.

The outputs are measured individually with one input transition per measurement.

V _{CC}	V _t	R _L	C _L	ΔV
1.8V ± 0.15V	V _{CC} /2	1kΩ	30pF	0.15V
2.5V ± 0.2V	V _{CC} /2	500Ω	30pF	0.15V
2.7V	1.5V	500Ω	50pF	0.3V
3.3V ± 0.3V	1.5V	500Ω	50pF	0.3V

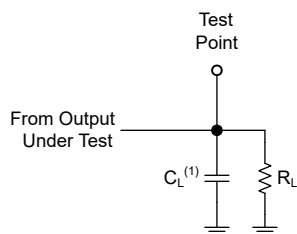

(1) C_L includes probe and test-fixture capacitance.

Figure 6-1. Load Circuit for Push-Pull Outputs

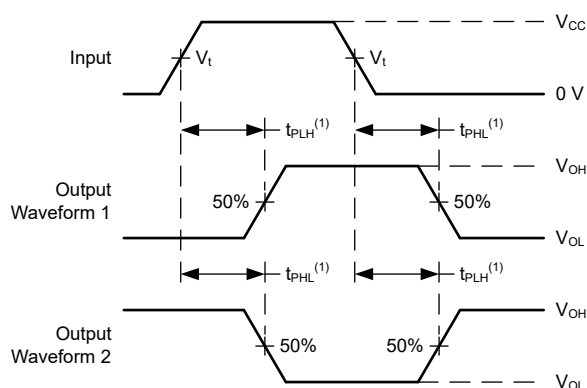

(1) The greater between t_{PLH} and t_{PHL} is the same as t_{pd}.

Figure 6-2. Voltage Waveforms Propagation Delays

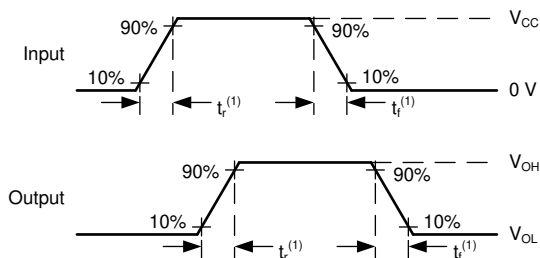

(1) The greater between t_r and t_f is the same as t_t.

Figure 6-3. Voltage Waveforms, Input and Output Transition Times

7 Detailed Description

7.1 Overview

The 'LVC86A devices perform the Boolean function $Y = A \oplus B$ or $Y = \bar{A}B + A\bar{B}$ in positive logic.

A common application is as a true/complement element. If one of the inputs is low, the other input is reproduced in true form at the output. If one of the inputs is high, the signal on the other input is reproduced inverted at the output.

Inputs can be driven from either 3.3V or 5V devices. This feature allows the use of these devices as down-translators in a mixed 3.3V/5V system environment.

7.2 Functional Block Diagram

Exclusive-OR Logic

An exclusive-OR gate has many applications, some of which can be represented better by alternative logic symbols.

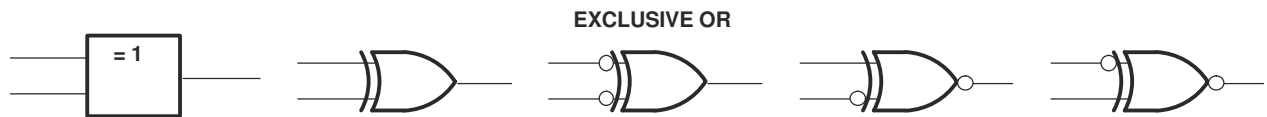

These five equivalent exclusive-OR symbols are valid for an SN74LVC86A gate in positive logic; negation may be shown at any two ports.

LOGIC-IDENTITY ELEMENT



The output is active (low) if all inputs stand at the same logic level (i.e., $A = B$).

EVEN-PARITY ELEMENT

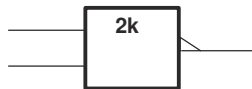

The output is active (low) if an even number of inputs (i.e., 0 or 2) are active.

ODD-PARITY ELEMENT

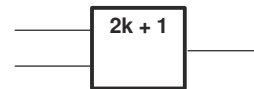

The output is active (high) if an odd number of inputs (i.e., only 1 of the 2) are active.

7.3 Feature Description

- Wide operating voltage range
 - Operates from 1.65 V to 3.6 V
- Allows up or down voltage translation
 - Inputs and outputs accept voltages to 5.5 V

7.4 Device Functional Modes

Table 7-1. FUNCTION TABLE (EACH GATE)

INPUTS		OUTPUT Y
A	B	
L	L	L
L	H	H
H	L	H
H	H	L

8 Application and Implementation

8.1 Application Information

The SN74LVC86A device is a high-drive, open-drain CMOS device that can be used for a multitude of buffer-type functions. It can produce 24 mA of drive current at 3 V. Therefore, this device is ideal for driving multiple inputs and for high-speed applications up to 100 MHz. The inputs and outputs are 5.5-V tolerant allowing the device to translate up to 5.5 V or down to V_{CC} .

8.2 Typical Application

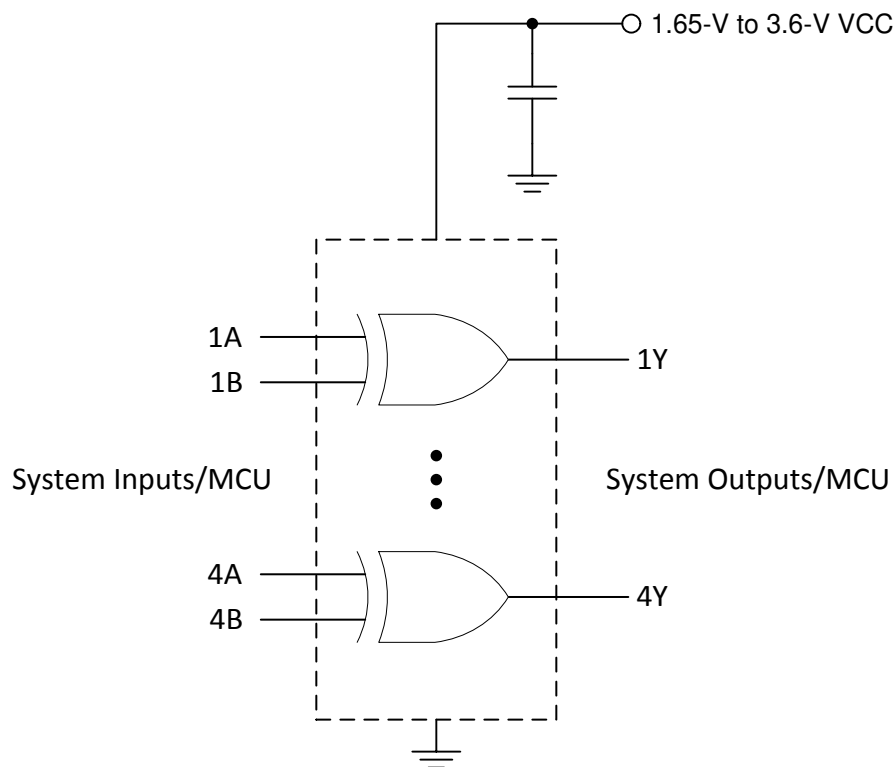

Figure 8-1. Typical OR Gate Application and Supply Voltage

8.2.1 Design Requirements

This device uses CMOS technology and has balanced output drive. Care should be taken to avoid bus contention because it can drive currents that would exceed maximum limits. The high drive will also create fast edges into light loads; therefore, routing and load conditions should be considered to prevent ringing.

8.2.2 Detailed Design Procedure

- Recommended Input Conditions
 - Rise time and fall time specs: See $(\Delta t/\Delta V)$ in the [Section 5.3](#) table.
 - Specified high and low levels: See $(V_{IH}$ and $V_{IL})$ in the [Section 5.3](#) table.
 - Inputs are overvoltage tolerant allowing them to go as high as 5.5 V at any valid V_{CC} .
- Recommend Output Conditions
 - Load currents should not exceed 25 mA per output and 50 mA total for the part.
 - Outputs should not be pulled above 5.5 V.

8.2.3 Application Curves

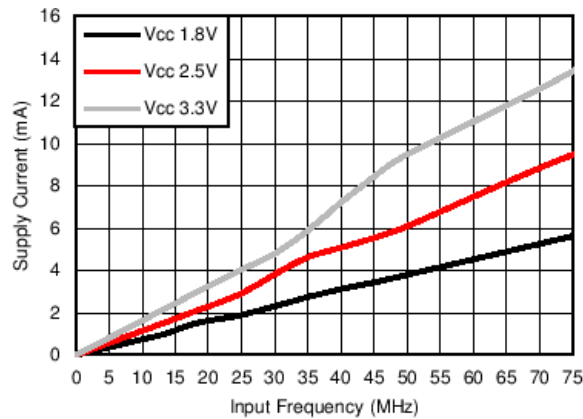

Figure 8-2. Supply Current vs. Input Frequency

Power Supply Recommendations

The power supply can be any voltage between the MIN and MAX supply voltage rating located in the [Section 5.3](#) table.

Each V_{CC} pin should have a good bypass capacitor to prevent power disturbance. For devices with a single supply, 0.1 μF is recommended; if there are multiple V_{CC} pins, then 0.01 μF or 0.022 μF is recommended for each power pin. It is acceptable to parallel multiple bypass caps to reject different frequencies of noise. A 0.1 μF and a 1 μF are commonly used in parallel. The bypass capacitor should be installed as close to the power pin as possible for best results.

8.3 Layout

8.3.1 Layout Guidelines

When using multiple bit logic devices inputs should never float.

In many cases, functions or parts of functions of digital logic devices are unused, for example, when only two inputs of a triple-input AND gate are used or only 3 of the 4 buffer gates are used. Such input pins should not be left unconnected because the undefined voltages at the outside connections result in undefined operational states. [Section 8.3.2](#) specifies the rules that must be observed under all circumstances. All unused inputs of digital logic devices must be connected to a high or low bias to prevent them from floating. The logic level that should be applied to any particular unused input depends on the function of the device. Generally they will be tied to GND or V_{CC} , whichever makes more sense or is more convenient. It is generally acceptable to float outputs, unless the part is a transceiver.

8.3.2 Layout Example

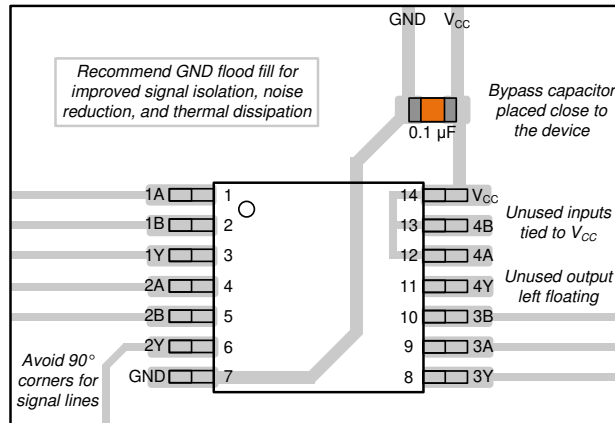

Figure 8-3. Example Layout for the SN74LVC86A

9 Device and Documentation Support

9.1 Documentation Support (Analog)

9.1.1 Related Links

The table below lists quick access links. Categories include technical documents, support and community resources, tools and software, and quick access to sample or buy.

Table 9-1. Related Links

PARTS	PRODUCT FOLDER	SAMPLE & BUY	TECHNICAL DOCUMENTS	TOOLS & SOFTWARE	SUPPORT & COMMUNITY
SN54LVC86A	Click here	Click here	Click here	Click here	Click here
SN74LVC86A	Click here	Click here	Click here	Click here	Click here

9.2 Receiving Notification of Documentation Updates

To receive notification of documentation updates, navigate to the device product folder on ti.com. Click on *Notifications* to register and receive a weekly digest of any product information that has changed. For change details, review the revision history included in any revised document.

9.3 Support Resources

[TI E2E™ support forums](#) are an engineer's go-to source for fast, verified answers and design help — straight from the experts. Search existing answers or ask your own question to get the quick design help you need.

Linked content is provided "AS IS" by the respective contributors. They do not constitute TI specifications and do not necessarily reflect TI's views; see TI's [Terms of Use](#).

9.4 Trademarks

TI E2E™ is a trademark of Texas Instruments.
All trademarks are the property of their respective owners.

9.5 Electrostatic Discharge Caution



This integrated circuit can be damaged by ESD. Texas Instruments recommends that all integrated circuits be handled with appropriate precautions. Failure to observe proper handling and installation procedures can cause damage.

ESD damage can range from subtle performance degradation to complete device failure. Precision integrated circuits may be more susceptible to damage because very small parametric changes could cause the device not to meet its published specifications.

9.6 Glossary

[TI Glossary](#) This glossary lists and explains terms, acronyms, and definitions.

10 Revision History

NOTE: Page numbers for previous revisions may differ from page numbers in the current version.

Changes from Revision Q (May 2024) to Revision R (August 2024) Page

- Updated RθJA values: D = 86 to 127.8, NS = 76 to 123.8, PW = 113 to 150.8, RGY = 47 to 92.1, all values in °C/W..... 5

Changes from Revision P (April 2005) to Revision Q (April 2024) Page

- Added *Device Information* table, *Pin Functions* table, *ESD Ratings* table, *Thermal Information* table, *Device Functional Modes*.Application and Implementation section, *Device and Documentation Support* section, and *Mechanical, Packaging, and Orderable Information* section 1
- Deleted references to machine model 1

-
- Added BQA package to *Device Information* table, *Pin Configuration and Functions* section, and *Thermal Information* table..... 1
-

11 Mechanical, Packaging, and Orderable Information

The following pages include mechanical, packaging, and orderable information. This information is the most current data available for the designated devices. This data is subject to change without notice and revision of this document. For browser-based versions of this data sheet, refer to the left-hand navigation.

PACKAGING INFORMATION

Orderable Device	Status (1)	Package Type	Package Drawing	Pins	Package Qty	Eco Plan (2)	Lead finish/ Ball material (6)	MSL Peak Temp (3)	Op Temp (°C)	Device Marking (4/5)	Samples
5962-9761901Q2A	ACTIVE	LCCC	FK	20	55	Non-RoHS & Green	SNPB	N / A for Pkg Type	-55 to 125	5962- 9761901Q2A SNJ54LVC 86AFK	Samples
5962-9761901QDA	ACTIVE	CFP	W	14	25	Non-RoHS & Green	SNPB	N / A for Pkg Type	-55 to 125	5962-9761901QD A SNJ54LVC86AW	Samples
SN74LVC86ABQAR	ACTIVE	WQFN	BQA	14	3000	RoHS & Green	NIPDAU	Level-1-260C-UNLIM	-40 to 125	LVC86A	Samples
SN74LVC86AD	ACTIVE	SOIC	D	14	50	RoHS & Green	NIPDAU	Level-1-260C-UNLIM	-40 to 125	LVC86A	Samples
SN74LVC86ADBR	ACTIVE	SSOP	DB	14	2000	RoHS & Green	NIPDAU	Level-1-260C-UNLIM	-40 to 125	LC86A	Samples
SN74LVC86ADG4	ACTIVE	SOIC	D	14	50	RoHS & Green	NIPDAU	Level-1-260C-UNLIM	-40 to 125	LVC86A	Samples
SN74LVC86ADR	ACTIVE	SOIC	D	14	2500	RoHS & Green	NIPDAU	Level-1-260C-UNLIM	-40 to 125	LVC86A	Samples
SN74LVC86ADRG4	ACTIVE	SOIC	D	14	2500	RoHS & Green	NIPDAU	Level-1-260C-UNLIM	-40 to 125	LVC86A	Samples
SN74LVC86ADT	ACTIVE	SOIC	D	14	250	RoHS & Green	NIPDAU	Level-1-260C-UNLIM	-40 to 125	LVC86A	Samples
SN74LVC86ANSR	ACTIVE	SO	NS	14	2000	RoHS & Green	NIPDAU	Level-1-260C-UNLIM	-40 to 125	LVC86A	Samples
SN74LVC86APW	ACTIVE	TSSOP	PW	14	90	RoHS & Green	NIPDAU	Level-1-260C-UNLIM	-40 to 125	LC86A	Samples
SN74LVC86APWE4	ACTIVE	TSSOP	PW	14	90	RoHS & Green	NIPDAU	Level-1-260C-UNLIM	-40 to 125	LC86A	Samples
SN74LVC86APWG4	ACTIVE	TSSOP	PW	14	90	RoHS & Green	NIPDAU	Level-1-260C-UNLIM	-40 to 125	LC86A	Samples
SN74LVC86APWR	ACTIVE	TSSOP	PW	14	2000	RoHS & Green	NIPDAU	Level-1-260C-UNLIM	-40 to 125	LC86A	Samples
SN74LVC86APWRG4	ACTIVE	TSSOP	PW	14	2000	RoHS & Green	NIPDAU	Level-1-260C-UNLIM	-40 to 125	LC86A	Samples
SN74LVC86ARGYR	ACTIVE	VQFN	RGY	14	3000	RoHS & Green	NIPDAU	Level-2-260C-1 YEAR	-40 to 125	LC86A	Samples
SN74LVC86ARGYRG4	ACTIVE	VQFN	RGY	14	3000	RoHS & Green	NIPDAU	Level-2-260C-1 YEAR	-40 to 125	LC86A	Samples
SNJ54LVC86AFK	ACTIVE	LCCC	FK	20	55	Non-RoHS & Green	SNPB	N / A for Pkg Type	-55 to 125	5962- 9761901Q2A	Samples

Orderable Device	Status (1)	Package Type	Package Drawing	Pins	Package Qty	Eco Plan (2)	Lead finish/ Ball material (6)	MSL Peak Temp (3)	Op Temp (°C)	Device Marking (4/5)	Samples
SNJ54LVC86AW	ACTIVE	CFP	W	14	25	Non-RoHS & Green	SNPB	N / A for Pkg Type	-55 to 125	SNJ54LVC 86AFK 5962-9761901QD A SNJ54LVC86AW	<div style="background-color: #e67e22; color: white; padding: 2px 5px; display: inline-block;">Samples</div>

(1) The marketing status values are defined as follows:

ACTIVE: Product device recommended for new designs.

LIFEBUY: TI has announced that the device will be discontinued, and a lifetime-buy period is in effect.

NRND: Not recommended for new designs. Device is in production to support existing customers, but TI does not recommend using this part in a new design.

PREVIEW: Device has been announced but is not in production. Samples may or may not be available.

OBSELETE: TI has discontinued the production of the device.

(2) **RoHS:** TI defines "RoHS" to mean semiconductor products that are compliant with the current EU RoHS requirements for all 10 RoHS substances, including the requirement that RoHS substance do not exceed 0.1% by weight in homogeneous materials. Where designed to be soldered at high temperatures, "RoHS" products are suitable for use in specified lead-free processes. TI may reference these types of products as "Pb-Free".

RoHS Exempt: TI defines "RoHS Exempt" to mean products that contain lead but are compliant with EU RoHS pursuant to a specific EU RoHS exemption.

Green: TI defines "Green" to mean the content of Chlorine (Cl) and Bromine (Br) based flame retardants meet JS709B low halogen requirements of <=1000ppm threshold. Antimony trioxide based flame retardants must also meet the <=1000ppm threshold requirement.

(3) MSL, Peak Temp. - The Moisture Sensitivity Level rating according to the JEDEC industry standard classifications, and peak solder temperature.

(4) There may be additional marking, which relates to the logo, the lot trace code information, or the environmental category on the device.

(5) Multiple Device Markings will be inside parentheses. Only one Device Marking contained in parentheses and separated by a "~" will appear on a device. If a line is indented then it is a continuation of the previous line and the two combined represent the entire Device Marking for that device.

(6) Lead finish/Ball material - Orderable Devices may have multiple material finish options. Finish options are separated by a vertical ruled line. Lead finish/Ball material values may wrap to two lines if the finish value exceeds the maximum column width.

Important Information and Disclaimer: The information provided on this page represents TI's knowledge and belief as of the date that it is provided. TI bases its knowledge and belief on information provided by third parties, and makes no representation or warranty as to the accuracy of such information. Efforts are underway to better integrate information from third parties. TI has taken and continues to take reasonable steps to provide representative and accurate information but may not have conducted destructive testing or chemical analysis on incoming materials and chemicals. TI and TI suppliers consider certain information to be proprietary, and thus CAS numbers and other limited information may not be available for release.

In no event shall TI's liability arising out of such information exceed the total purchase price of the TI part(s) at issue in this document sold by TI to Customer on an annual basis.

OTHER QUALIFIED VERSIONS OF SN54LVC86A, SN74LVC86A :

- Catalog : [SN74LVC86A](#)
- Automotive : [SN74LVC86A-Q1](#), [SN74LVC86A-Q1](#)
- Enhanced Product : [SN74LVC86A-EP](#), [SN74LVC86A-EP](#)
- Military : [SN54LVC86A](#)

NOTE: Qualified Version Definitions:

- Catalog - TI's standard catalog product
- Automotive - Q100 devices qualified for high-reliability automotive applications targeting zero defects
- Enhanced Product - Supports Defense, Aerospace and Medical Applications
- Military - QML certified for Military and Defense Applications

IMPORTANT NOTICE AND DISCLAIMER

TI PROVIDES TECHNICAL AND RELIABILITY DATA (INCLUDING DATA SHEETS), DESIGN RESOURCES (INCLUDING REFERENCE DESIGNS), APPLICATION OR OTHER DESIGN ADVICE, WEB TOOLS, SAFETY INFORMATION, AND OTHER RESOURCES "AS IS" AND WITH ALL FAULTS, AND DISCLAIMS ALL WARRANTIES, EXPRESS AND IMPLIED, INCLUDING WITHOUT LIMITATION ANY IMPLIED WARRANTIES OF MERCHANTABILITY, FITNESS FOR A PARTICULAR PURPOSE OR NON-INFRINGEMENT OF THIRD PARTY INTELLECTUAL PROPERTY RIGHTS.

These resources are intended for skilled developers designing with TI products. You are solely responsible for (1) selecting the appropriate TI products for your application, (2) designing, validating and testing your application, and (3) ensuring your application meets applicable standards, and any other safety, security, regulatory or other requirements.

These resources are subject to change without notice. TI grants you permission to use these resources only for development of an application that uses the TI products described in the resource. Other reproduction and display of these resources is prohibited. No license is granted to any other TI intellectual property right or to any third party intellectual property right. TI disclaims responsibility for, and you will fully indemnify TI and its representatives against, any claims, damages, costs, losses, and liabilities arising out of your use of these resources.

TI's products are provided subject to [TI's Terms of Sale](#) or other applicable terms available either on [ti.com](https://www.ti.com) or provided in conjunction with such TI products. TI's provision of these resources does not expand or otherwise alter TI's applicable warranties or warranty disclaimers for TI products.

TI objects to and rejects any additional or different terms you may have proposed.

Mailing Address: Texas Instruments, Post Office Box 655303, Dallas, Texas 75265
Copyright © 2024, Texas Instruments Incorporated