

# TLE207x, TLE207xA EXCALIBUR LOW-NOISE HIGH-SPEED JFET-INPUT OPERATIONAL AMPLIFIERS

SLOS181C – FEBRUARY 1997 – REVISED DECEMBER 2009

- Direct Upgrades to TL05x, TL07x, and TL08x BiFET Operational Amplifiers
- Greater Than 2× Bandwidth (10 MHz) and 3× Slew Rate (45 V/μs) Than TL07x
- Ensured Maximum Noise Floor 17 nV/√Hz
- On-Chip Offset Voltage Trimming for Improved DC Performance
- Wider Supply Rails Increase Dynamic Signal Range to ±19 V

## description

The TLE207x series of JFET-input operational amplifiers more than double the bandwidth and triple the slew rate of the TL07x and TL08x families of BiFET operational amplifiers. Texas Instruments Excalibur process yields a typical noise floor of 11.6 nV/√Hz, 17-nV/√Hz ensured maximum, offering immediate improvement in noise-sensitive circuits designed using the TL07x. The TLE207x also has wider supply voltage rails, increasing the dynamic signal range for BiFET circuits to ±19 V. On-chip zener trimming of offset voltage yields precision grades for greater accuracy in dc-coupled applications. The TLE207x are pin-compatible with lower performance BiFET operational amplifiers for ease in improving performance in existing designs.

BiFET operational amplifiers offer the inherently higher input impedance of the JFET-input transistors, without sacrificing the output drive associated with bipolar amplifiers. This makes them better suited for interfacing with high-impedance sensors or very low-level ac signals. They also feature inherently better ac response than bipolar or CMOS devices having comparable power consumption.

The TLE207x family of BiFET amplifiers are Texas Instruments highest performance BiFETs, with tighter input offset voltage and ensured maximum noise specifications. Designers requiring less stringent specifications but seeking the improved ac characteristics of the TLE207x should consider the TLE208x operational amplifier family.

Because BiFET operational amplifiers are designed for use with dual power supplies, care must be taken to observe common-mode input voltage limits and output swing when operating from a single supply. DC biasing of the input signal is required and loads should be terminated to a virtual ground node at mid-supply. Texas Instruments TLE2426 integrated virtual ground generator is useful when operating BiFET amplifiers from single supplies.

The TLE207x are fully specified at ±15 V and ±5 V. For operation in low-voltage and/or single-supply systems, Texas Instruments LinCMOS families of operational amplifiers (TLC- and TLV-prefix) are recommended. When moving from BiFET to CMOS amplifiers, particular attention should be paid to slew rate and bandwidth requirements and output loading.



Please be aware that an important notice concerning availability, standard warranty, and use in critical applications of Texas Instruments semiconductor products and disclaimers thereto appears at the end of this data sheet.

PRODUCTION DATA information is current as of publication date. Products conform to specifications per the terms of Texas Instruments standard warranty. Production processing does not necessarily include testing of all parameters.



POST OFFICE BOX 655303 • DALLAS, TEXAS 75265

Copyright © 1997 – 2004, Texas Instruments Incorporated

# TLE207x, TLE207xA EXCALIBUR LOW-NOISE HIGH-SPEED JFET-INPUT OPERATIONAL AMPLIFIERS

SLOS181C – FEBRUARY 1997 – REVISED DECEMBER 2009

## TLE2071 AVAILABLE OPTIONS

| T <sub>A</sub> | V <sub>IOmax</sub><br>AT 25°C | PACKAGED DEVICES         |                           |                           |                         |                             |
|----------------|-------------------------------|--------------------------|---------------------------|---------------------------|-------------------------|-----------------------------|
|                |                               | SMALL<br>OUTLINE†<br>(D) | CHIP CARRIER<br>(FK)      | CERAMIC DIP<br>(JG)       | PLASTIC DIP<br>(P)      | CERAMIC<br>FLAT PACK<br>(U) |
| 0°C to 70°C    | 2 mV<br>4 mV                  | TLE2071ACD<br>TLE2071CD  | —                         | —                         | TLE2071ACP<br>TLE2071CP | —                           |
| –40°C to 85°C  | 2 mV<br>4 mV                  | TLE2071AID<br>TLE2071ID  | —                         | —                         | TLE2071AIP<br>TLE2071IP | —                           |
| –55°C to 125°C | 2 mV<br>4 mV                  | —<br>—                   | TLE2071AMFK<br>TLE2071MFK | TLE2071AMJG<br>TLE2071MJG | —<br>—                  | TLE2071AMU<br>TLE2071MU     |

† The D packages are available taped and reeled. Add R suffix to device type (e.g., TLE2071ACDR).

## TLE2072 AVAILABLE OPTIONS

| T <sub>A</sub> | V <sub>IOmax</sub><br>AT 25°C | PACKAGED DEVICES         |                           |                           |                         |                             |
|----------------|-------------------------------|--------------------------|---------------------------|---------------------------|-------------------------|-----------------------------|
|                |                               | SMALL<br>OUTLINE†<br>(D) | CHIP CARRIER<br>(FK)      | CERAMIC<br>DIP<br>(JG)    | PLASTIC<br>DIP<br>(P)   | CERAMIC<br>FLAT PACK<br>(U) |
| 0°C to 70°C    | 3.5 mV<br>6 mV                | TLE2072ACD<br>TLE2072CD  | —                         | —                         | TLE2072ACP<br>TLE2072CP | —                           |
| –40°C to 85°C  | 3.5 mV<br>6 mV                | TLE2072AID<br>TLE2072ID  | —                         | —                         | TLE2072AIP<br>TLE2072IP | —                           |
| –55°C to 125°C | 3.5 mV<br>6 mV                | —                        | TLE2072AMFK<br>TLE2072MFK | TLE2072AMJG<br>TLE2072MJG | —                       | TLE2072AMU<br>TLE2072MU     |

† The D packages are available taped and reeled. Add R suffix to device type (e.g., TLE2072ACDR).

## TLE2074 AVAILABLE OPTIONS

| T <sub>A</sub> | V <sub>IOmax</sub><br>AT 25°C | PACKAGED DEVICES          |                           |                         |                         |                             |
|----------------|-------------------------------|---------------------------|---------------------------|-------------------------|-------------------------|-----------------------------|
|                |                               | SMALL<br>OUTLINE†<br>(DW) | CHIP CARRIER<br>(FK)      | CERAMIC<br>DIP<br>(J)   | PLASTIC<br>DIP<br>(N)   | CERAMIC<br>FLAT PACK<br>(W) |
| 0°C to 70°C    | 3 mV<br>5 mV                  | TLE2074ACDW<br>TLE2074CDW | —                         | —                       | TLE2074ACN<br>TLE2074CN | —                           |
| –40°C to 85°C  | 3 mV<br>5 mV                  | TLE2074AIDW<br>TLE2074IDW | —                         | —                       | TLE2074AIN<br>TLE2074IN | —                           |
| –55°C to 125°C | 3 mV<br>5 mV                  | —                         | TLE2074AMFK<br>TLE2074MFK | TLE2074AMJ<br>TLE2074MJ | —                       | TLE2074AMW<br>TLE2074MW     |

† The DW packages are available taped and reeled. Add R suffix to device type (e.g., TLE2074ACDWR).

## symbol

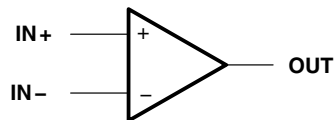

# TLE207x, TLE207xA EXCALIBUR LOW-NOISE HIGH-SPEED JFET-INPUT OPERATIONAL AMPLIFIERS

SLOS181C – FEBRUARY 1997 – REVISED DECEMBER 2009

**TLE2071 AND TLE2071A  
D, JG, OR P PACKAGE  
(TOP VIEW)**

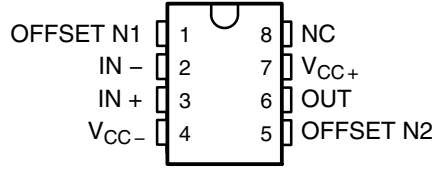

**TLE2072 AND TLE2072A  
D, JG, OR P PACKAGE  
(TOP VIEW)**

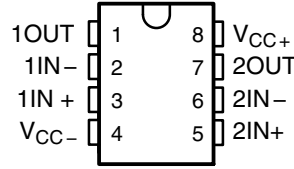

**TLE2074 AND TLE2074A  
J, N, OR W PACKAGE  
(TOP VIEW)**

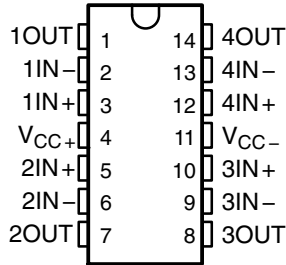

**TLE2074 AND TLE2074A  
DW PACKAGE  
(TOP VIEW)**

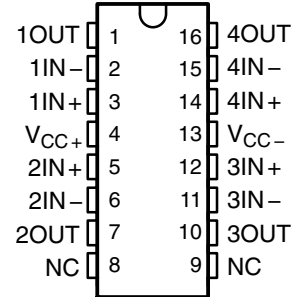

**TLE2071M AND TLE2071AM  
FK PACKAGE  
(TOP VIEW)**



**TLE2072M AND TLE2072AM  
FK PACKAGE  
(TOP VIEW)**



**TLE2074M AND TLE2074AM  
FK PACKAGE  
(TOP VIEW)**



**TLE2071 AND TLE2071A  
U PACKAGE  
(TOP VIEW)**



**TLE2072 AND TLE2072A  
U PACKAGE  
(TOP VIEW)**



NC – No internal connection

**TLE207X, TLE207XA**  
**EXCALIBUR LOW-NOISE HIGH-SPEED**  
**JFET-INPUT OPERATIONAL AMPLIFIERS**  
SLOS181C - FEBRUARY 1997 - REVISED DECEMBER 2009

equivalent schematic



NOTES: A. OFFSET N1 AND OFFSET N2 are only available on the TLE2071x devices.

equivalent schematic (continued)

| ACTUAL DEVICE COMPONENT COUNT |         |         |         |
|-------------------------------|---------|---------|---------|
| COMPONENT                     | TLE2071 | TLE2072 | TLE2074 |
| Transistors                   | 33      | 57      | 114     |
| Resistors                     | 25      | 37      | 74      |
| Diodes                        | 8       | 5       | 10      |
| Capacitors                    | 6       | 11      | 22      |

# TLE207x, TLE207xA EXCALIBUR LOW-NOISE HIGH-SPEED JFET-INPUT OPERATIONAL AMPLIFIERS

SLOS181C – FEBRUARY 1997 – REVISED DECEMBER 2009

## absolute maximum ratings over operating free-air temperature range (unless otherwise noted)<sup>†</sup>

|  |                        |
|--|------------------------|
| Supply voltage, $V_{CC+}$ (see Note 1)   | 19 V                   |
| Supply voltage, $V_{CC-}$ (see Note 1)   | -19 V                  |
| Differential input voltage range, $V_{ID}$ (see Note 2)                              | $V_{CC+}$ to $V_{CC-}$ |
| Input voltage range, $V_I$ (any input)   | $V_{CC+}$ to $V_{CC-}$ |
| Input current, $I_I$ (each input)  | $\pm 1$ mA             |
| Output current, $I_O$ (each output)  | $\pm 80$ mA            |
| Total current into $V_{CC+}$   | 160 mA                 |
| Total current out of $V_{CC-}$   | 160 mA                 |
| Duration of short-circuit current at (or below) 25°C (see Note 3)                    | unlimited              |
| Package thermal impedance, $\theta_{JA}$ (see Notes 4 and 5):                        |                        |
| D package  | 97.1°C/W               |
| DW package   | 57.3°C/W               |
| N package  | 79.7°C/W               |
| P package  | 84.6°C/W               |
| Package thermal impedance, $\theta_{JC}$ (see Notes 4 and 5):                        |                        |
| FK package   | 5.6°C/W                |
| J package  | 15.1°C/W               |
| JG package   | 14.5°C/W               |
| U package  | 14.7°C/W               |
| W package  | 10°C/W                 |
| Operating free-air temperature range, $T_A$ :  |                        |
| C suffix   | 0°C to 70°C            |
| I suffix   | -40°C to 85°C          |
| M suffix   | -55°C to 125°C         |
| Storage temperature range  | -65°C to 150°C         |
| Case temperature for 60 seconds: FK package  | 260°C                  |
| Lead temperature 1,6 mm (1/16 inch) from case for 10 seconds: DW or N package        | 260°C                  |
| Lead temperature 1,6 mm (1/16 inch) from case for 60 seconds: J, JG, U, or W package | 300°C                  |

<sup>†</sup> Stresses beyond those listed under “absolute maximum ratings” may cause permanent damage to the device. These are stress ratings only, and functional operation of the device at these or any other conditions beyond those indicated under “recommended operating conditions” is not implied. Exposure to absolute-maximum-rated conditions for extended periods may affect device reliability.

- NOTES:
1. All voltage values, except differential voltages, are with respect to the midpoint between  $V_{CC+}$  and  $V_{CC-}$ .
  2. Differential voltages are at the noninverting input with respect to the inverting input.
  3. The output may be shorted to either supply. Temperatures and/or supply voltages must be limited to ensure that the maximum dissipation rate is not exceeded.
  4. Maximum power dissipation is a function of  $T_J(\text{max})$ ,  $\theta_{JA}$ , and  $T_A$ . The maximum allowable power dissipation at any allowable ambient temperature is  $P_D = (T_J(\text{max}) - T_A)/\theta_{JA}$ . Operating at the absolute maximum  $T_J$  of 150°C can affect reliability.
  5. The package thermal impedance is calculated in accordance with JESD 51-7 (plastic) or MIL-STD-883 Method 1012 (ceramic).

## recommended operating conditions

|                                       |                        | C SUFFIX   |          | I SUFFIX   |          | M SUFFIX   |          | UNIT |
|---------------------------------------|------------------------|------------|----------|------------|----------|------------|----------|------|
|                                       |                        | MIN        | MAX      | MIN        | MAX      | MIN        | MAX      |      |
| Supply voltage, $V_{CC\pm}$           |                        | $\pm 2.25$ | $\pm 19$ | $\pm 2.25$ | $\pm 19$ | $\pm 2.25$ | $\pm 19$ | V    |
| Common-mode input voltage, $V_{IC}$   | $V_{CC\pm} = \pm 5$ V  | -0.9       | 5        | -0.8       | 5        | -0.8       | 5        | V    |
|                                       | $V_{CC\pm} = \pm 15$ V | -10.9      | 15       | -10.8      | 15       | -10.8      | 15       |      |
| Operating free-air temperature, $T_A$ |                        | 0          | 70       | -40        | 85       | -55        | 125      | °C   |



**TLE207x, TLE207xA**  
**EXCALIBUR LOW-NOISE HIGH-SPEED**  
**JFET-INPUT OPERATIONAL AMPLIFIERS**

SLOS181C – FEBRUARY 1997 – REVISED DECEMBER 2009

**TLE2071C electrical characteristics at specified free-air temperature,  $V_{CC\pm} = \pm 5\text{ V}$  (unless otherwise noted)**

| PARAMETER   | TEST CONDITIONS   | $T_A^\dagger$              | TLE2071C   |           |     | TLE2071AC |           |                              | UNIT     |    |
|---|---|----------------------------|------------|-----------|-----|-----------|-----------|------------------------------|----------|----|
|   |   |                            | MIN        | TYP       | MAX | MIN       | TYP       | MAX                          |          |    |
| $V_{IO}$ Input offset voltage   | $V_{IC} = 0,$<br>$R_S = 50\ \Omega$   | 25°C                       | 0.34       | 4         |     | 0.3       | 2         | mV                           |          |    |
|   |   | Full range                 |            |           | 6   |           | 4         |                              |          |    |
| $\alpha_{VIO}$ Temperature coefficient of input offset voltage                  |   | Full range                 | 3.2        | 29        |     | 3.2       | 29        | $\mu\text{V}/^\circ\text{C}$ |          |    |
| $I_{IO}$ Input offset current   | $V_{IC} = 0,$<br>$V_O = 0,$<br>See Figure 4   | 25°C                       | 5          | 100       |     | 5         | 100       | pA                           |          |    |
|   |   | Full range                 |            | 1.4       |     |           | 1.4       | nA                           |          |    |
| $I_{IB}$ Input bias current   |   | 25°C                       | 15         | 175       |     | 15        | 175       | pA                           |          |    |
|   |   | Full range                 |            | 5         |     |           | 5         | nA                           |          |    |
| $V_{ICR}$ Common-mode input voltage range                                       | $R_S = 50\ \Omega$  | 25°C                       | 5 to -1    | 5 to -1.9 |     | 5 to -1   | 5 to -1.9 | V                            |          |    |
|   |   | Full range                 | 5 to -0.9  |           |     | 5 to -0.9 |           |                              |          |    |
| $V_{OM+}$ Maximum positive peak output voltage swing                            | $I_O = -200\ \mu\text{A}$   | 25°C                       | 3.8        | 4.1       |     | 3.8       | 4.1       | V                            |          |    |
|   |   | Full range                 | 3.7        |           |     | 3.7       |           |                              |          |    |
|   | $I_O = -2\ \text{mA}$   | 25°C                       | 3.5        | 3.9       |     | 3.5       | 3.9       |                              |          |    |
|   |   | Full range                 | 3.4        |           |     | 3.4       |           |                              |          |    |
|   | $I_O = -20\ \text{mA}$  | 25°C                       | 1.5        | 2.3       |     | 1.5       | 2.3       |                              |          |    |
|   |   | Full range                 | 1.5        |           |     | 1.5       |           |                              |          |    |
| $V_{OM-}$ Maximum negative peak output voltage swing                            | $I_O = 200\ \mu\text{A}$  | 25°C                       | -3.5       | -4.2      |     | -3.5      | -4.2      | V                            |          |    |
|   |   | Full range                 | -3.4       |           |     | -3.4      |           |                              |          |    |
|   | $I_O = 2\ \text{mA}$  | 25°C                       | -3.7       | -4.1      |     | -3.7      | -4.1      |                              |          |    |
|   |   | Full range                 | -3.6       |           |     | -3.6      |           |                              |          |    |
|   | $I_O = 20\ \text{mA}$   | 25°C                       | -1.5       | -2.4      |     | -1.5      | -2.4      |                              |          |    |
|   |   | Full range                 | -1.5       |           |     | -1.5      |           |                              |          |    |
| $A_{VD}$ Large-signal differential voltage amplification                        | $V_O = \pm 2.3\ \text{V}$   | $R_L = 600\ \Omega$        | 25°C       | 80        | 91  |           | 80        | 91                           | dB       |    |
|   |   |                            | Full range | 79        |     |           | 79        |                              |          |    |
|   |   | $R_L = 2\ \text{k}\Omega$  | 25°C       | 90        | 100 |           | 90        | 100                          |          |    |
|   |   |                            | Full range | 89        |     |           | 89        |                              |          |    |
|   |   | $R_L = 10\ \text{k}\Omega$ | 25°C       | 95        | 106 |           | 95        | 106                          |          |    |
|   |   |                            | Full range | 94        |     |           | 94        |                              |          |    |
| $r_i$ Input resistance  | $V_{IC} = 0$  | 25°C                       | $10^{12}$  |           |     | $10^{12}$ |           |                              | $\Omega$ |    |
| $c_i$ Input capacitance   | $V_{IC} = 0,$<br>See Figure 5   | Common mode                | 25°C       | 11        |     |           | 11        |                              |          | pF |
|   |   | Differential               | 25°C       | 2.5       |     |           | 2.5       |                              |          |    |
| $z_o$ Open-loop output impedance  | $f = 1\ \text{MHz}$   | 25°C                       | 80         |           |     | 80        |           |                              | $\Omega$ |    |
| CMRR Common-mode rejection ratio  | $V_{IC} = V_{ICRmin},$<br>$V_O = 0,$<br>$R_S = 50\ \Omega$                              | 25°C                       | 70         | 89        |     | 70        | 89        | dB                           |          |    |
|   |   | Full range                 | 68         |           |     | 68        |           |                              |          |    |
| $k_{SVR}$ Supply-voltage rejection ratio ( $\Delta V_{CC\pm} / \Delta V_{IO}$ ) | $V_{CC\pm} = \pm 5\ \text{V to } \pm 15\ \text{V},$<br>$V_O = 0,$<br>$R_S = 50\ \Omega$ | 25°C                       | 82         | 99        |     | 82        | 99        | dB                           |          |    |
|   |   | Full range                 | 80         |           |     | 80        |           |                              |          |    |

$^\dagger$  Full range is 0°C to 70°C.



**TLE207x, TLE207xA**  
**EXCALIBUR LOW-NOISE HIGH-SPEED**  
**JFET-INPUT OPERATIONAL AMPLIFIERS**

SLOS181C – FEBRUARY 1997 – REVISED DECEMBER 2009

**TLE2071C electrical characteristics at specified free-air temperature,  $V_{CC\pm} = \pm 5\text{ V}$  (unless otherwise noted) (continued)**

| PARAMETER                             | TEST CONDITIONS     | $T_A^\dagger$          | TLE2071C |     |     | TLE2071AC |     |     | UNIT |
|---------------------------------------|---------------------|------------------------|----------|-----|-----|-----------|-----|-----|------|
|                                       |                     |                        | MIN      | TYP | MAX | MIN       | TYP | MAX |      |
| $I_{CC}$ Supply current               | $V_O = 0$ , No load | 25°C                   | 1.35     | 1.6 | 2.2 | 1.35      | 1.6 | 2.2 | mA   |
|                                       |                     | Full range             | 2.2      |     |     | 2.2       |     |     |      |
| $I_{OS}$ Short-circuit output current | $V_O = 0$           | $V_{ID} = 1\text{ V}$  | -35      |     |     | -35       |     |     | mA   |
|                                       |                     | $V_{ID} = -1\text{ V}$ | 45       |     |     | 45        |     |     |      |

† Full range is 0°C to 70°C.

**TLE2071C operating characteristics at specified free-air temperature,  $V_{CC\pm} = \pm 5\text{ V}$**

| PARAMETER   | TEST CONDITIONS  | $T_A^\dagger$   | TLE2071C |     |     | TLE2071AC |     |                        | UNIT                   |
|---|--|---|----------|-----|-----|-----------|-----|------------------------|------------------------|
|   |  |   | MIN      | TYP | MAX | MIN       | TYP | MAX                    |                        |
| SR+ Positive slew rate                                  | $V_{O(PP)} = \pm 2.3\text{ V}$ ,<br>$A_{VD} = -1$ , $R_L = 2\text{ k}\Omega$ ,<br>$C_L = 100\text{ pF}$ , See Figure 1 | 25°C  | 35       |     |     | 35        |     |                        | V/ $\mu$ s             |
|   |  | Full range  | 23       |     |     | 23        |     |                        |                        |
| SR- Negative slew rate                                  |  | 25°C  | 38       |     |     | 38        |     |                        | V/ $\mu$ s             |
|   |  | Full range  | 23       |     |     | 23        |     |                        |                        |
| $t_s$ Settling time                                     | $A_{VD} = -1$ ,<br>2-V step,<br>$R_L = 1\text{ k}\Omega$ ,<br>$C_L = 100\text{ pF}$                                    | To 10 mV  | 0.25     |     |     | 0.25      |     |                        | $\mu$ s                |
|   |  | To 1 mV   | 0.4      |     |     | 0.4       |     |                        |                        |
| $V_n$ Equivalent input noise voltage                    | $R_S = 20\ \Omega$ ,<br>See Figure 3   | f = 10 Hz   | 48       | 85  |     | 48        | 85  | nV/ $\sqrt{\text{Hz}}$ |                        |
|   |  | f = 10 kHz  | 12       | 17  |     | 12        | 17  |                        |                        |
| $V_{N(PP)}$ Peak-to-peak equivalent input noise voltage |  | f = 10 Hz to 10 kHz                                   | 6        |     |     | 6         |     |                        | $\mu$ V                |
|   |  | f = 0.1 Hz to 10 Hz                                   | 0.6      |     |     | 0.6       |     |                        |                        |
| $I_n$ Equivalent input noise current                    | $V_{IC} = 0$ , f = 10 kHz  | 25°C  | 2.8      |     |     | 2.8       |     |                        | fA/ $\sqrt{\text{Hz}}$ |
| THD + N Total harmonic distortion plus noise            | $V_{O(PP)} = 5\text{ V}$ ,<br>f = 1 kHz,<br>$R_S = 25\ \Omega$   | $A_{VD} = 10$ ,<br>$R_L = 2\text{ k}\Omega$ ,<br>25°C | 0.013%   |     |     | 0.013%    |     |                        |                        |
| $B_1$ Unity-gain bandwidth                              | $V_I = 10\text{ mV}$ ,<br>$C_L = 25\text{ pF}$ ,<br>$R_L = 2\text{ k}\Omega$ ,<br>See Figure 2                         | 25°C  | 9.4      |     |     | 9.4       |     |                        | MHz                    |
| $B_{OM}$ Maximum output-swing bandwidth                 | $V_{O(PP)} = 4\text{ V}$ ,<br>$R_L = 2\text{ k}\Omega$ ,<br>$C_L = 25\text{ pF}$ ,<br>$A_{VD} = -1$                    | 25°C  | 2.8      |     |     | 2.8       |     |                        | MHz                    |
| $\phi_m$ Phase margin at unity gain                     | $V_I = 10\text{ mV}$ ,<br>$C_L = 25\text{ pF}$ ,<br>$R_L = 2\text{ k}\Omega$ ,<br>See Figure 2                         | 25°C  | 56°      |     |     | 56°       |     |                        |                        |

† Full range is 0°C to 70°C.





**TLE207x, TLE207xA**  
**EXCALIBUR LOW-NOISE HIGH-SPEED**  
**JFET-INPUT OPERATIONAL AMPLIFIERS**

SLOS181C – FEBRUARY 1997 – REVISED DECEMBER 2009

**TLE2071C electrical characteristics at specified free-air temperature,  $V_{CC\pm} = \pm 15$  V (unless otherwise noted)**

| PARAMETER   | TEST CONDITIONS   | $T_A$ †               | TLE2071C    |             |     | TLE2071AC   |             |                  | UNIT     |    |
|---|---|-----------------------|-------------|-------------|-----|-------------|-------------|------------------|----------|----|
|   |   |                       | MIN         | TYP         | MAX | MIN         | TYP         | MAX              |          |    |
| $V_{IO}$ Input offset voltage   | $V_{IC} = 0,$<br>$R_S = 50 \Omega$<br>$V_O = 0,$                        | 25°C                  | 0.49        | 4           |     | 0.47        | 2           | mV               |          |    |
|   |   | Full range            |             |             | 6   |             | 4           |                  |          |    |
| $\alpha_{VIO}$ Temperature coefficient of input offset voltage                |   | Full range            | 3.2         | 29          |     | 3.2         | 29          | $\mu V/^\circ C$ |          |    |
| $I_{IO}$ Input offset current   | $V_{IC} = 0,$<br>$V_O = 0,$<br>See Figure 4                             | 25°C                  | 6           | 100         |     | 6           | 100         | pA               |          |    |
|   |   | Full range            |             | 1.4         |     |             | 1.4         | nA               |          |    |
| $I_{IB}$ Input bias current   |   | 25°C                  | 20          | 175         |     | 20          | 175         | pA               |          |    |
|   |   | Full range            |             | 5           |     |             | 5           | nA               |          |    |
| $V_{ICR}$ Common-mode input voltage range                                     | $R_S = 50 \Omega$   | 25°C                  | 15 to -11   | 15 to -11.9 |     | 15 to -11   | 15 to -11.9 | V                |          |    |
|   |   | Full range            | 15 to -10.9 |             |     | 15 to -10.9 |             |                  |          |    |
| $V_{OM+}$ Maximum positive peak output voltage swing                          | $I_O = -200 \mu A$  | 25°C                  | 13.8        | 14.1        |     | 13.8        | 14.1        | V                |          |    |
|   |   | Full range            | 13.7        |             |     | 13.7        |             |                  |          |    |
|   | $I_O = -2$ mA   | 25°C                  | 13.5        | 13.9        |     | 13.5        | 13.9        |                  |          |    |
|   |   | Full range            | 13.4        |             |     | 13.4        |             |                  |          |    |
|   | $I_O = -20$ mA  | 25°C                  | 11.5        | 12.3        |     | 11.5        | 12.3        |                  |          |    |
|   |   | Full range            | 11.5        |             |     | 11.5        |             |                  |          |    |
| $V_{OM-}$ Maximum negative peak output voltage swing                          | $I_O = 200 \mu A$   | 25°C                  | -13.8       | -14.2       |     | -13.8       | -14.2       | V                |          |    |
|   |   | Full range            | -13.7       |             |     | -13.7       |             |                  |          |    |
|   | $I_O = 2$ mA  | 25°C                  | -13.5       | -14         |     | -13.5       | -14         |                  |          |    |
|   |   | Full range            | -13.4       |             |     | -13.4       |             |                  |          |    |
|   | $I_O = 20$ mA   | 25°C                  | -11.5       | -12.4       |     | -11.5       | -12.4       |                  |          |    |
|   |   | Full range            | -11.5       |             |     | -11.5       |             |                  |          |    |
| $A_{VD}$ Large-signal differential voltage amplification                      | $V_O = \pm 10$ V  | $R_L = 600 \Omega$    | 25°C        | 80          | 96  |             | 80          | 96               | dB       |    |
|   |   |                       | Full range  | 79          |     |             | 79          |                  |          |    |
|   |   | $R_L = 2$ k $\Omega$  | 25°C        | 90          | 109 |             | 90          | 109              |          |    |
|   |   |                       | Full range  | 89          |     |             | 89          |                  |          |    |
|   |   | $R_L = 10$ k $\Omega$ | 25°C        | 95          | 118 |             | 95          | 118              |          |    |
|   |   |                       | Full range  | 94          |     |             | 94          |                  |          |    |
| $r_i$ Input resistance  | $V_{IC} = 0$  | 25°C                  | $10^{12}$   |             |     | $10^{12}$   |             |                  | $\Omega$ |    |
| $c_i$ Input capacitance   | $V_{IC} = 0,$<br>See Figure 5   | Common mode           | 25°C        | 7.5         |     |             | 7.5         |                  |          | pF |
|   |   | Differential          | 25°C        | 2.5         |     |             | 2.5         |                  |          |    |
| $z_o$ Open-loop output impedance  | $f = 1$ MHz   | 25°C                  | 80          |             |     | 80          |             |                  | $\Omega$ |    |
| CMRR Common-mode rejection ratio  | $V_{IC} = V_{ICRmin},$<br>$V_O = 0,$<br>$R_S = 50 \Omega$               | 25°C                  | 80          | 98          |     | 80          | 98          | dB               |          |    |
|   |   | Full range            | 79          |             |     | 79          |             |                  |          |    |
| $k_{SVR}$ Supply-voltage rejection ratio ( $\Delta V_{CC\pm}/\Delta V_{IO}$ ) | $V_{CC\pm} = \pm 5$ V to $\pm 15$ V,<br>$V_O = 0,$<br>$R_S = 50 \Omega$ | 25°C                  | 82          | 99          |     | 82          | 99          | dB               |          |    |
|   |   | Full range            | 80          |             |     | 81          |             |                  |          |    |

† Full range is 0°C to 70°C.



# TLE207x, TLE207xA EXCALIBUR LOW-NOISE HIGH-SPEED JFET-INPUT OPERATIONAL AMPLIFIERS

SLOS181C – FEBRUARY 1997 – REVISED DECEMBER 2009

**TLE2071C electrical characteristics at specified free-air temperature,  $V_{CC\pm} = \pm 15$  V (unless otherwise noted) (continued)**

| PARAMETER                             | TEST CONDITIONS     | $T_A$ †         | TLE2071C |     |     | TLE2071AC |     |     | UNIT |
|---------------------------------------|---------------------|-----------------|----------|-----|-----|-----------|-----|-----|------|
|                                       |                     |                 | MIN      | TYP | MAX | MIN       | TYP | MAX |      |
| $I_{CC}$ Supply current               | $V_O = 0$ , No load | 25°C            | 1.35     | 1.7 | 2.2 | 1.35      | 1.7 | 2.2 | mA   |
|                                       |                     | Full range      | 2.2      |     |     | 2.2       |     |     |      |
| $I_{OS}$ Short-circuit output current | $V_O = 0$           | $V_{ID} = 1$ V  | -30      | -45 |     | -30       | -45 |     | mA   |
|                                       |                     | $V_{ID} = -1$ V | 30       | 48  |     | 30        | 48  |     |      |

† Full range is 0°C to 70°C.

**TLE2071C operating characteristics at specified free-air temperature,  $V_{CC\pm} = \pm 15$  V**

| PARAMETER   | TEST CONDITIONS   | $T_A$ †             | TLE2071C |     |     | TLE2071AC |     |     | UNIT            |
|---|---|---------------------|----------|-----|-----|-----------|-----|-----|-----------------|
|   |   |                     | MIN      | TYP | MAX | MIN       | TYP | MAX |                 |
| SR+ Positive slew rate                                  | $V_{O(PP)} = 10$ V, $A_{VD} = -1$ ,<br>$R_L = 2$ k $\Omega$ ,<br>See Figure 1                   | 25°C                | 30       | 40  |     | 30        | 40  |     | V/ $\mu$ s      |
|   |   | Full range          | 27       |     |     | 27        |     |     |                 |
| SR- Negative slew rate                                  |   | 25°C                | 30       | 45  |     | 30        | 45  |     | V/ $\mu$ s      |
|   |   | Full range          | 27       |     |     | 27        |     |     |                 |
| $t_s$ Settling time                                     | $A_{VD} = -1$ ,<br>10-V step,<br>$R_L = 1$ k $\Omega$ ,<br>$C_L = 100$ pF                       | To 10 mV            | 0.4      |     |     | 0.4       |     |     | $\mu$ s         |
|   |   | To 1 mV             | 1.5      |     |     | 1.5       |     |     |                 |
| $V_n$ Equivalent input noise voltage                    |   | f = 10 Hz           | 48       | 85  |     | 48        | 85  |     | nV/ $\sqrt{Hz}$ |
|   |   | f = 10 kHz          | 12       | 17  |     | 12        | 17  |     |                 |
| $V_{N(PP)}$ Peak-to-peak equivalent input noise voltage | $R_S = 20$ $\Omega$ ,<br>See Figure 3   | f = 10 Hz to 10 kHz | 6        |     |     | 6         |     |     | $\mu$ V         |
|   |   | f = 0.1 Hz to 10 Hz | 0.6      |     |     | 0.6       |     |     |                 |
| $I_n$ Equivalent input noise current                    | $V_{IC} = 0$ , f = 10 kHz   | 25°C                | 2.8      |     |     | 2.8       |     |     | fA/ $\sqrt{Hz}$ |
| THD + N Total harmonic distortion plus noise            | $V_{O(PP)} = 20$ V, $A_{VD} = 10$ ,<br>f = 1 kHz, $R_L = 2$ k $\Omega$ ,<br>$R_S = 25$ $\Omega$ | 25°C                | 0.008%   |     |     | 0.008%    |     |     |                 |
| $B_1$ Unity-gain bandwidth                              | $V_I = 10$ mV, $R_L = 2$ k $\Omega$ ,<br>$C_L = 25$ pF, See Figure 2                            | 25°C                | 8        | 10  |     | 8         | 10  |     | MHz             |
| $B_{OM}$ Maximum output-swing bandwidth                 | $V_{O(PP)} = 20$ V, $A_{VD} = -1$ ,<br>$R_L = 2$ k $\Omega$ , $C_L = 25$ pF                     | 25°C                | 478      | 637 |     | 478       | 637 |     | kHz             |
| $\phi_m$ Phase margin at unity gain                     | $V_I = 10$ mV, $R_L = 2$ k $\Omega$ ,<br>$C_L = 25$ pF, See Figure 2                            | 25°C                | 57°      |     |     | 57°       |     |     |                 |

† Full range is 0°C to 70°C.



**TLE207x, TLE207xA**  
**EXCALIBUR LOW-NOISE HIGH-SPEED**  
**JFET-INPUT OPERATIONAL AMPLIFIERS**

SLOS181C – FEBRUARY 1997 – REVISED DECEMBER 2009

**TLE2071I electrical characteristics at specified free-air temperature,  $V_{CC\pm} = \pm 5$  V (unless otherwise noted)**

| PARAMETER   | TEST CONDITIONS  | $T_A$ †                    | TLE2071I   |           |     | TLE2071AI |           |                              | UNIT     |    |
|---|--|----------------------------|------------|-----------|-----|-----------|-----------|------------------------------|----------|----|
|   |  |                            | MIN        | TYP       | MAX | MIN       | TYP       | MAX                          |          |    |
| $V_{IO}$ Input offset voltage   | $V_{IC} = 0,$<br>$R_S = 50 \Omega,$<br>$V_O = 0,$                                      | 25°C                       | 0.34       | 4         |     | 0.3       | 2         | mV                           |          |    |
|   |  | Full range                 |            |           | 7.6 |           | 5.6       |                              |          |    |
| $\alpha_{VIO}$ Temperature coefficient of input offset voltage                |  | Full range                 | 3.2        | 29        |     | 3.2       | 29        | $\mu\text{V}/^\circ\text{C}$ |          |    |
| $I_{IO}$ Input offset current   | $V_{IC} = 0,$<br>$V_O = 0,$<br>See Figure 4  | 25°C                       | 5          | 100       |     | 5         | 100       | pA                           |          |    |
|   |  | Full range                 |            |           | 5   |           | 5         | nA                           |          |    |
| $I_{IB}$ Input bias current   |  | 25°C                       | 15         | 175       |     | 15        | 175       | pA                           |          |    |
|   |  | Full range                 |            |           | 10  |           | 10        | nA                           |          |    |
| $V_{ICR}$ Common-mode input voltage range                                     | $R_S = 50 \Omega$  | 25°C                       | 5 to -1    | 5 to -1.9 |     | 5 to -1   | 5 to -1.9 | V                            |          |    |
|   |  | Full range                 | 5 to -0.8  |           |     | 5 to -0.8 |           |                              |          |    |
| $V_{OM+}$ Maximum positive peak output voltage swing                          | $I_O = -200 \mu\text{A}$   | 25°C                       | 3.8        | 4.1       |     | 3.8       | 4.1       | V                            |          |    |
|   |  | Full range                 | 3.7        |           |     | 3.7       |           |                              |          |    |
|   | $I_O = -2 \text{ mA}$  | 25°C                       | 3.5        | 3.9       |     | 3.5       | 3.9       |                              |          |    |
|   |  | Full range                 | 3.4        |           |     | 3.4       |           |                              |          |    |
|   | $I_O = -20 \text{ mA}$   | 25°C                       | 1.5        | 2.3       |     | 1.5       | 2.3       |                              |          |    |
|   |  | Full range                 | 1.5        |           |     | 1.5       |           |                              |          |    |
| $V_{OM-}$ Maximum negative peak output voltage swing                          | $I_O = 200 \mu\text{A}$  | 25°C                       | -3.8       | -4.2      |     | -3.8      | -4.2      | V                            |          |    |
|   |  | Full range                 | -3.7       |           |     | -3.7      |           |                              |          |    |
|   | $I_O = 2 \text{ mA}$   | 25°C                       | -3.5       | -4.1      |     | -3.5      | -4.1      |                              |          |    |
|   |  | Full range                 | -3.4       |           |     | -3.4      |           |                              |          |    |
|   | $I_O = 20 \text{ mA}$  | 25°C                       | -1.5       | -2.4      |     | -1.5      | -2.4      |                              |          |    |
|   |  | Full range                 | -1.5       |           |     | -1.5      |           |                              |          |    |
| $A_{VD}$ Large-signal differential voltage amplification                      | $V_O = \pm 2.3 \text{ V}$  | $R_L = 600 \Omega$         | 25°C       | 80        | 91  |           | 80        | 91                           | dB       |    |
|   |  |                            | Full range | 79        |     |           | 79        |                              |          |    |
|   |  | $R_L = 2 \text{ k}\Omega$  | 25°C       | 90        | 100 |           | 90        | 100                          |          |    |
|   |  |                            | Full range | 89        |     |           | 89        |                              |          |    |
|   |  | $R_L = 10 \text{ k}\Omega$ | 25°C       | 95        | 106 |           | 95        | 106                          |          |    |
|   |  |                            | Full range | 94        |     |           | 94        |                              |          |    |
| $r_i$ Input resistance  | $V_{IC} = 0$   | 25°C                       | $10^{12}$  |           |     | $10^{12}$ |           |                              | $\Omega$ |    |
| $c_i$ Input capacitance   | $V_{IC} = 0,$<br>See Figure 5  | Common mode                | 25°C       | 11        |     |           | 11        |                              |          | pF |
|   |  | Differential               | 25°C       | 2.5       |     |           | 2.5       |                              |          |    |
| $z_o$ Open-loop output impedance  | $f = 1 \text{ MHz}$  | 25°C                       | 80         |           |     | 80        |           |                              | $\Omega$ |    |
| CMRR Common-mode rejection ratio  | $V_{IC} = V_{ICRmin},$<br>$V_O = 0,$<br>$R_S = 50 \Omega$                              | 25°C                       | 70         | 89        |     | 70        | 89        | dB                           |          |    |
|   |  | Full range                 | 68         |           |     | 68        |           |                              |          |    |
| $k_{SVR}$ Supply-voltage rejection ratio ( $\Delta V_{CC\pm}/\Delta V_{IO}$ ) | $V_{CC\pm} = \pm 5 \text{ V to } \pm 15 \text{ V},$<br>$V_O = 0,$<br>$R_S = 50 \Omega$ | 25°C                       | 82         | 99        |     | 82        | 99        | dB                           |          |    |
|   |  | Full range                 | 80         |           |     | 80        |           |                              |          |    |

† Full range is  $-40^\circ\text{C}$  to  $85^\circ\text{C}$ .



# TLE207x, TLE207xA EXCALIBUR LOW-NOISE HIGH-SPEED JFET-INPUT OPERATIONAL AMPLIFIERS

SLOS181C – FEBRUARY 1997 – REVISED DECEMBER 2009

**TLE2071I electrical characteristics at specified free-air temperature,  $V_{CC\pm} = \pm 5\text{ V}$  (unless otherwise noted) (continued)**

| PARAMETER                             | TEST CONDITIONS     | $T_A^\dagger$          | TLE2071I |     |     | TLE2071AI |     |     | UNIT |
|---------------------------------------|---------------------|------------------------|----------|-----|-----|-----------|-----|-----|------|
|                                       |                     |                        | MIN      | TYP | MAX | MIN       | TYP | MAX |      |
| $I_{CC}$ Supply current               | $V_O = 0$ , No load | 25°C                   | 1.35     | 1.6 | 2.2 | 1.35      | 1.6 | 2.2 | mA   |
|                                       |                     | Full range             | 2.2      |     |     | 2.2       |     |     |      |
| $I_{OS}$ Short-circuit output current | $V_O = 0$           | $V_{ID} = 1\text{ V}$  | -35      |     |     | -35       |     |     | mA   |
|                                       |                     | $V_{ID} = -1\text{ V}$ | 45       |     |     | 45        |     |     |      |

† Full range is  $-40^\circ\text{C}$  to  $85^\circ\text{C}$ .

**TLE2071I operating characteristics at specified free-air temperature,  $V_{CC\pm} = \pm 5\text{ V}$**

| PARAMETER   | TEST CONDITIONS  | $T_A^\dagger$       | TLE2071I |     |     | TLE2071AI |     |                        | UNIT                   |
|---|--|---------------------|----------|-----|-----|-----------|-----|------------------------|------------------------|
|   |  |                     | MIN      | TYP | MAX | MIN       | TYP | MAX                    |                        |
| SR+ Positive slew rate                                  | $V_{O(PP)} = \pm 2.3\text{ V}$ ,<br>$A_{VD} = -1$ , $R_L = 2\text{ k}\Omega$ ,<br>$C_L = 100\text{ pF}$ , See Figure 1 | 25°C                | 35       |     |     | 35        |     |                        | V/ $\mu\text{s}$       |
|   |  | Full range          | 22       |     |     | 22        |     |                        |                        |
| SR- Negative slew rate                                  |  | 25°C                | 38       |     |     | 38        |     |                        | V/ $\mu\text{s}$       |
|   |  | Full range          | 22       |     |     | 22        |     |                        |                        |
| $t_s$ Settling time                                     | $A_{VD} = -1$ ,<br>2-V step,<br>$R_L = 1\text{ k}\Omega$ ,<br>$C_L = 100\text{ pF}$                                    | To 10 mV            | 0.25     |     |     | 0.25      |     |                        | $\mu\text{s}$          |
|   |  | To 1 mV             | 0.4      |     |     | 0.4       |     |                        |                        |
| $V_n$ Equivalent input noise voltage                    | $R_S = 20\ \Omega$ ,<br>See Figure 3   | f = 10 Hz           | 48       | 85  |     | 48        | 85  | nV/ $\sqrt{\text{Hz}}$ |                        |
|   |  | f = 10 kHz          | 12       | 17  |     | 12        | 17  |                        |                        |
| $V_{N(PP)}$ Peak-to-peak equivalent input noise voltage | $R_S = 20\ \Omega$ ,<br>See Figure 3   | f = 10 Hz to 10 kHz | 6        |     |     | 6         |     |                        | $\mu\text{V}$          |
|   |  | f = 0.1 Hz to 10 Hz | 0.6      |     |     | 0.6       |     |                        |                        |
| $I_n$ Equivalent input noise current                    | $V_{IC} = 0$ , f = 10 kHz  | 25°C                | 2.8      |     |     | 2.8       |     |                        | fA/ $\sqrt{\text{Hz}}$ |
| THD + N Total harmonic distortion plus noise            | $V_{O(PP)} = 5\text{ V}$ , $A_{VD} = 10$ ,<br>f = 1 kHz, $R_L = 2\text{ k}\Omega$ ,<br>$R_S = 25\ \Omega$              | 25°C                | 0.013%   |     |     | 0.013%    |     |                        |                        |
| $B_1$ Unity-gain bandwidth                              | $V_I = 10\text{ mV}$ , $R_L = 2\text{ k}\Omega$ ,<br>$C_L = 25\text{ pF}$ , See Figure 2                               | 25°C                | 9.4      |     |     | 9.4       |     |                        | MHz                    |
| $B_{OM}$ Maximum output-swing bandwidth                 | $V_{O(PP)} = 4\text{ V}$ , $A_{VD} = -1$ ,<br>$R_L = 2\text{ k}\Omega$ , $C_L = 25\text{ pF}$                          | 25°C                | 2.8      |     |     | 2.8       |     |                        | MHz                    |
| $\phi_m$ Phase margin at unity gain                     | $V_I = 10\text{ mV}$ , $R_L = 2\text{ k}\Omega$ ,<br>$C_L = 25\text{ pF}$ , See Figure 2                               | 25°C                | 56°      |     |     | 56°       |     |                        |                        |

† Full range is  $-40^\circ\text{C}$  to  $85^\circ\text{C}$ .



**TLE207x, TLE207xA**  
**EXCALIBUR LOW-NOISE HIGH-SPEED**  
**JFET-INPUT OPERATIONAL AMPLIFIERS**

SLOS181C – FEBRUARY 1997 – REVISED DECEMBER 2009

**TLE20711 electrical characteristics at specified free-air temperature,  $V_{CC\pm} = \pm 15$  V (unless otherwise noted)**

| PARAMETER   | TEST CONDITIONS  | $T_A$ †                    | TLE20711    |             |     | TLE2071AI   |             |                              | UNIT     |    |
|---|--|----------------------------|-------------|-------------|-----|-------------|-------------|------------------------------|----------|----|
|   |  |                            | MIN         | TYP         | MAX | MIN         | TYP         | MAX                          |          |    |
| $V_{IO}$ Input offset voltage   | $V_{IC} = 0,$<br>$R_S = 50 \Omega,$<br>$V_O = 0,$                                      | 25°C                       | 0.49        | 4           |     | 0.47        | 2           | mV                           |          |    |
|   |  | Full range                 |             |             | 7.6 |             | 5.6         |                              |          |    |
| $\alpha_{VIO}$ Temperature coefficient of input offset voltage                |  | Full range                 | 3.2         | 29          |     | 3.2         | 29          | $\mu\text{V}/^\circ\text{C}$ |          |    |
| $I_{IO}$ Input offset current   | $V_{IC} = 0,$<br>$V_O = 0,$<br>See Figure 4  | 25°C                       | 6           | 100         |     | 6           | 100         | pA                           |          |    |
|   |  | Full range                 |             | 5           |     |             | 5           | nA                           |          |    |
| $I_{IB}$ Input bias current   |  | 25°C                       | 20          | 175         |     | 20          | 175         | pA                           |          |    |
|   |  | Full range                 |             | 10          |     |             | 10          | nA                           |          |    |
| $V_{ICR}$ Common-mode input voltage range                                     | $R_S = 50 \Omega$  | 25°C                       | 15 to -11   | 15 to -11.9 |     | 15 to -11   | 15 to -11.9 | V                            |          |    |
|   |  | Full range                 | 15 to -10.8 |             |     | 15 to -10.8 |             |                              |          |    |
| $V_{OM+}$ Maximum positive peak output voltage swing                          | $I_O = -200 \mu\text{A}$   | 25°C                       | 13.8        | 14.1        |     | 13.8        | 14.1        | V                            |          |    |
|   |  | Full range                 | 13.7        |             |     | 13.7        |             |                              |          |    |
|   | $I_O = -2 \text{ mA}$  | 25°C                       | 13.5        | 13.9        |     | 13.5        | 13.9        |                              |          |    |
|   |  | Full range                 | 13.4        |             |     | 13.4        |             |                              |          |    |
|   | $I_O = -20 \text{ mA}$   | 25°C                       | 11.5        | 12.3        |     | 11.5        | 12.3        |                              |          |    |
|   |  | Full range                 | 11.5        |             |     | 11.5        |             |                              |          |    |
| $V_{OM-}$ Maximum negative peak output voltage swing                          | $I_O = 200 \mu\text{A}$  | 25°C                       | -13.8       | -14.2       |     | -13.8       | -14.2       | V                            |          |    |
|   |  | Full range                 | -13.7       |             |     | -13.7       |             |                              |          |    |
|   | $I_O = 2 \text{ mA}$   | 25°C                       | -13.5       | -14         |     | -13.5       | -14         |                              |          |    |
|   |  | Full range                 | -13.4       |             |     | -13.4       |             |                              |          |    |
|   | $I_O = 20 \text{ mA}$  | 25°C                       | -11.5       | -12.4       |     | -11.5       | -12.4       |                              |          |    |
|   |  | Full range                 | -11.5       |             |     | -11.5       |             |                              |          |    |
| $A_{VD}$ Large-signal differential voltage amplification                      | $V_O = \pm 10 \text{ V}$   | $R_L = 600 \Omega$         | 25°C        | 80          | 96  |             | 80          | 96                           | dB       |    |
|   |  |                            | Full range  | 79          |     |             | 79          |                              |          |    |
|   |  | $R_L = 2 \text{ k}\Omega$  | 25°C        | 90          | 109 |             | 90          | 109                          |          |    |
|   |  |                            | Full range  | 89          |     |             | 89          |                              |          |    |
|   |  | $R_L = 10 \text{ k}\Omega$ | 25°C        | 95          | 118 |             | 95          | 118                          |          |    |
|   |  |                            | Full range  | 94          |     |             | 94          |                              |          |    |
| $r_i$ Input resistance  | $V_{IC} = 0$   | 25°C                       | $10^{12}$   |             |     | $10^{12}$   |             |                              | $\Omega$ |    |
| $c_i$ Input capacitance   | $V_{IC} = 0,$<br>See Figure 5  | Common mode                | 25°C        | 7.5         |     |             | 7.5         |                              |          | pF |
|   |  | Differential               | 25°C        | 2.5         |     |             | 2.5         |                              |          |    |
| $z_o$ Open-loop output impedance  | $f = 1 \text{ MHz}$  | 25°C                       | 80          |             |     | 80          |             |                              | $\Omega$ |    |
| CMRR Common-mode rejection ratio  | $V_{IC} = V_{ICRmin},$<br>$V_O = 0,$<br>$R_S = 50 \Omega$                              | 25°C                       | 80          | 98          |     | 80          | 98          | dB                           |          |    |
|   |  | Full range                 | 79          |             |     | 79          |             |                              |          |    |
| $k_{SVR}$ Supply-voltage rejection ratio ( $\Delta V_{CC\pm}/\Delta V_{IO}$ ) | $V_{CC\pm} = \pm 5 \text{ V to } \pm 15 \text{ V},$<br>$V_O = 0,$<br>$R_S = 50 \Omega$ | 25°C                       | 82          | 99          |     | 82          | 99          | dB                           |          |    |
|   |  | Full range                 | 80          |             |     | 80          |             |                              |          |    |

† Full range is  $-40^\circ\text{C}$  to  $85^\circ\text{C}$ .



# TLE207x, TLE207xA EXCALIBUR LOW-NOISE HIGH-SPEED JFET-INPUT OPERATIONAL AMPLIFIERS

SLOS181C – FEBRUARY 1997 – REVISED DECEMBER 2009

**TLE2071I electrical characteristics at specified free-air temperature,  $V_{CC\pm} = \pm 15$  V (unless otherwise noted) (continued)**

| PARAMETER                             | TEST CONDITIONS     | $T_A^\dagger$   | TLE2071I |     |     | TLE2071AI |     |     | UNIT |
|---------------------------------------|---------------------|-----------------|----------|-----|-----|-----------|-----|-----|------|
|                                       |                     |                 | MIN      | TYP | MAX | MIN       | TYP | MAX |      |
| $I_{CC}$ Supply current               | $V_O = 0$ , No load | 25°C            | 1.35     | 1.7 | 2.2 | 1.35      | 1.7 | 2.2 | mA   |
|                                       |                     | Full range      | 2.2      |     |     | 2.2       |     |     |      |
| $I_{OS}$ Short-circuit output current | $V_O = 0$           | $V_{ID} = 1$ V  | -30      | -45 |     | -30       | -45 |     | mA   |
|                                       |                     | $V_{ID} = -1$ V | 30       | 48  |     | 30        | 48  |     |      |

$^\dagger$  Full range is  $-40^\circ\text{C}$  to  $85^\circ\text{C}$ .

**TLE2071I operating characteristics at specified free-air temperature,  $V_{CC\pm} = \pm 15$  V**

| PARAMETER   | TEST CONDITIONS   | $T_A^\dagger$                             | TLE2071I |        |     | TLE2071AI |        |     | UNIT                   |  |
|---|---|---|----------|--------|-----|-----------|--------|-----|------------------------|--|
|   |   |   | MIN      | TYP    | MAX | MIN       | TYP    | MAX |                        |  |
| SR+ Positive slew rate                                  | $V_{O(PP)} = \pm 10$ V,<br>$A_{VD} = -1$ ,<br>$C_L = 100$ pF,<br>$R_L = 2$ k $\Omega$ ,<br>See Figure 1 | 25°C                                      | 30       | 40     |     | 30        | 40     |     | V/ $\mu$ s             |  |
|   |   | Full range                                | 24       |        |     | 24        |        |     |                        |  |
| SR- Negative slew rate                                  |   | 25°C                                      | 30       | 45     |     | 30        | 45     |     | V/ $\mu$ s             |  |
|   |   | Full range                                | 24       |        |     | 24        |        |     |                        |  |
| $t_s$ Settling time                                     | $A_{VD} = -1$ ,<br>10-V step,<br>$R_L = 1$ k $\Omega$ ,<br>$C_L = 100$ pF                               | To 10 mV                                  | 0.4      |        |     | 0.4       |        |     | $\mu$ s                |  |
|   |   | To 1 mV                                   | 1.5      |        |     | 1.5       |        |     |                        |  |
| $V_n$ Equivalent input noise voltage                    | $R_S = 20$ $\Omega$ ,<br>See Figure 3   | f = 10 Hz                                 | 48       | 85     |     | 48        | 85     |     | nV/ $\sqrt{\text{Hz}}$ |  |
|   |   | f = 10 kHz                                | 12       | 17     |     | 12        | 17     |     |                        |  |
| $V_{N(PP)}$ Peak-to-peak equivalent input noise voltage |   | f = 10 Hz to 10 kHz                       | 6        |        |     | 6         |        |     | $\mu$ V                |  |
|   |   | f = 0.1 Hz to 10 Hz                       | 0.6      |        |     | 0.6       |        |     |                        |  |
| $I_n$ Equivalent input noise current                    | $V_{IC} = 0$ , f = 10 kHz   | 25°C                                      | 2.8      |        |     | 2.8       |        |     | fA/ $\sqrt{\text{Hz}}$ |  |
| THD + N Total harmonic distortion plus noise            | $V_{O(PP)} = 20$ V,<br>f = 1 kHz,<br>$R_S = 25$ $\Omega$  | $A_{VD} = 10$ ,<br>$R_L = 2$ k $\Omega$ , | 25°C     | 0.008% |     |           | 0.008% |     |                        |  |
| $B_1$ Unity-gain bandwidth                              | $V_I = 10$ mV,<br>$C_L = 25$ pF,  | $R_L = 2$ k $\Omega$ ,<br>See Figure 2    | 25°C     | 8      | 10  |           | 8      | 10  | MHz                    |  |
| $B_{OM}$ Maximum output-swing bandwidth                 | $V_{O(PP)} = 20$ V,<br>$R_L = 2$ k $\Omega$ ,   | $A_{VD} = -1$ ,<br>$C_L = 25$ pF          | 25°C     | 478    | 637 |           | 478    | 637 | kHz                    |  |
| $\phi_m$ Phase margin at unity gain                     | $V_I = 10$ mV,<br>$C_L = 25$ pF,  | $R_L = 2$ k $\Omega$ ,<br>See Figure 2    | 25°C     | 57°    |     |           | 57°    |     |                        |  |

$^\dagger$  Full range is  $-40^\circ\text{C}$  to  $85^\circ\text{C}$ .



**TLE207x, TLE207xA**  
**EXCALIBUR LOW-NOISE HIGH-SPEED**  
**JFET-INPUT OPERATIONAL AMPLIFIERS**

SLOS181C – FEBRUARY 1997 – REVISED DECEMBER 2009

**TLE2071M electrical characteristics at specified free-air temperature,  $V_{CC\pm} = \pm 5\text{ V}$  (unless otherwise noted)**

| PARAMETER   | TEST CONDITIONS   | $T_A^\dagger$              | TLE2071M   |                 |     | TLE2071AM |                 |                              | UNIT     |    |
|---|---|----------------------------|------------|-----------------|-----|-----------|-----------------|------------------------------|----------|----|
|   |   |                            | MIN        | TYP             | MAX | MIN       | TYP             | MAX                          |          |    |
| $V_{IO}$ Input offset voltage   | $V_{IC} = 0,$<br>$R_S = 50\ \Omega,$<br>$V_O = 0,$                                      | 25°C                       | 0.34       | 4               |     | 0.3       | 2               | mV                           |          |    |
|   |   | Full range                 |            |                 | 9.2 |           | 7.2             |                              |          |    |
| $\alpha_{VIO}$ Temperature coefficient of input offset voltage                  |   | Full range                 | 3.2        | 29 <sup>‡</sup> |     | 3.2       | 29 <sup>‡</sup> | $\mu\text{V}/^\circ\text{C}$ |          |    |
| $I_{IO}$ Input offset current   | $V_{IC} = 0,$<br>$V_O = 0,$<br>See Figure 4   | 25°C                       | 5          | 100             |     | 5         | 100             | pA                           |          |    |
|   |   | Full range                 |            |                 | 20  |           | 20              | nA                           |          |    |
| $I_{IB}$ Input bias current   |   | 25°C                       | 15         | 175             |     | 15        | 175             | pA                           |          |    |
|   |   | Full range                 |            |                 | 60  |           | 60              | nA                           |          |    |
| $V_{ICR}$ Common-mode input voltage range                                       | $R_S = 50\ \Omega$  | 25°C                       | 5 to -1    | 5 to -1.9       |     | 5 to -1   | 5 to -1.9       | V                            |          |    |
|   |   | Full range                 | 5 to -0.8  |                 |     | 5 to -0.8 |                 |                              |          |    |
| $V_{OM+}$ Maximum positive peak output voltage swing                            | $I_O = -200\ \mu\text{A}$   | 25°C                       | 3.8        | 4.1             |     | 3.8       | 4.1             | V                            |          |    |
|   |   | Full range                 | 3.6        |                 |     | 3.6       |                 |                              |          |    |
|   | $I_O = -2\ \text{mA}$   | 25°C                       | 3.5        | 3.9             |     | 3.5       | 3.9             |                              |          |    |
|   |   | Full range                 | 3.3        |                 |     | 3.3       |                 |                              |          |    |
|   | $I_O = -20\ \text{mA}$  | 25°C                       | 1.5        | 2.3             |     | 1.5       | 2.3             |                              |          |    |
|   |   | Full range                 | 1.4        |                 |     | 1.4       |                 |                              |          |    |
| $V_{OM-}$ Maximum negative peak output voltage swing                            | $I_O = 200\ \mu\text{A}$  | 25°C                       | -3.8       | -4.2            |     | -3.8      | -4.2            | V                            |          |    |
|   |   | Full range                 | -3.6       |                 |     | -3.6      |                 |                              |          |    |
|   | $I_O = 2\ \text{mA}$  | 25°C                       | -3.5       | -4.1            |     | -3.5      | -4.1            |                              |          |    |
|   |   | Full range                 | -3.3       |                 |     | -3.3      |                 |                              |          |    |
|   | $I_O = 20\ \text{mA}$   | 25°C                       | -1.5       | -2.4            |     | -1.5      | -2.4            |                              |          |    |
|   |   | Full range                 | -1.4       |                 |     | -1.4      |                 |                              |          |    |
| $A_{VD}$ Large-signal differential voltage amplification                        | $V_O = \pm 2.3\ \text{V}$   | $R_L = 600\ \Omega$        | 25°C       | 80              | 91  |           | 80              | 91                           | dB       |    |
|   |   |                            | Full range | 78              |     |           | 78              |                              |          |    |
|   |   | $R_L = 2\ \text{k}\Omega$  | 25°C       | 90              | 100 |           | 90              | 100                          |          |    |
|   |   |                            | Full range | 88              |     |           | 88              |                              |          |    |
|   |   | $R_L = 10\ \text{k}\Omega$ | 25°C       | 95              | 106 |           | 95              | 106                          |          |    |
|   |   |                            | Full range | 93              |     |           | 93              |                              |          |    |
| $r_i$ Input resistance  | $V_{IC} = 0$  | 25°C                       | $10^{12}$  |                 |     | $10^{12}$ |                 |                              | $\Omega$ |    |
| $c_i$ Input capacitance   | $V_{IC} = 0,$<br>See Figure 5   | Common mode                | 25°C       | 11              |     |           | 11              |                              |          | pF |
|   |   | Differential               | 25°C       | 2.5             |     |           | 2.5             |                              |          |    |
| $z_o$ Open-loop output impedance  | $f = 1\ \text{MHz}$   | 25°C                       | 80         |                 |     | 80        |                 |                              | $\Omega$ |    |
| CMRR Common-mode rejection ratio  | $V_{IC} = V_{ICRmin},$<br>$V_O = 0,$<br>$R_S = 50\ \Omega$                              | 25°C                       | 70         | 89              |     | 70        | 89              | dB                           |          |    |
|   |   | Full range                 | 68         |                 |     | 68        |                 |                              |          |    |
| $k_{SVR}$ Supply-voltage rejection ratio ( $\Delta V_{CC\pm} / \Delta V_{IO}$ ) | $V_{CC\pm} = \pm 5\ \text{V to } \pm 15\ \text{V},$<br>$V_O = 0,$<br>$R_S = 50\ \Omega$ | 25°C                       | 82         | 99              |     | 82        | 99              | dB                           |          |    |
|   |   | Full range                 | 80         |                 |     | 80        |                 |                              |          |    |

<sup>†</sup> Full range is  $-55^\circ\text{C}$  to  $125^\circ\text{C}$ .

<sup>‡</sup> \*On products compliant to MIL-PRF-38535, Class B, this parameter is not production tested.



**TLE207x, TLE207xA**  
**EXCALIBUR LOW-NOISE HIGH-SPEED**  
**JFET-INPUT OPERATIONAL AMPLIFIERS**

SLOS181C – FEBRUARY 1997 – REVISED DECEMBER 2009

**TLE2071M electrical characteristics at specified free-air temperature,  $V_{CC\pm} = \pm 5\text{ V}$  (unless otherwise noted)**

| PARAMETER                             | TEST CONDITIONS     | $T_A$ †                | TLE2071M |     |     | TLE2071AM |     |     | UNIT |
|---------------------------------------|---------------------|------------------------|----------|-----|-----|-----------|-----|-----|------|
|                                       |                     |                        | MIN      | TYP | MAX | MIN       | TYP | MAX |      |
| $I_{CC}$ Supply current               | $V_O = 0$ , No load | 25°C                   | 1.35     | 1.6 | 2.2 | 1.35      | 1.6 | 2.2 | mA   |
|                                       |                     | Full range             | 2.2      |     |     | 2.2       |     |     |      |
| $I_{OS}$ Short-circuit output current | $V_O = 0$           | $V_{ID} = 1\text{ V}$  | -35      |     |     | -35       |     |     | mA   |
|                                       |                     | $V_{ID} = -1\text{ V}$ | 45       |     |     | 45        |     |     |      |

† Full range is  $-55^\circ\text{C}$  to  $125^\circ\text{C}$ .

**TLE2071M operating characteristics at specified free-air temperature,  $V_{CC\pm} = \pm 5\text{ V}$**

| PARAMETER   | TEST CONDITIONS  | $T_A$ †  | TLE2071M  |        |     | TLE2071AM |        |                        | UNIT             |                        |
|---|--|--|---|--------|-----|-----------|--------|------------------------|------------------|------------------------|
|   |  |  | MIN   | TYP    | MAX | MIN       | TYP    | MAX                    |                  |                        |
| SR+ Positive slew rate                                  | $V_{O(PP)} = \pm 2.3\text{ V}$ ,<br>$A_{VD} = -1$ ,<br>$C_L = 100\text{ pF}$ ,<br>$R_L = 2\text{ k}\Omega$ ,<br>See Figure 1 | 25°C   | 35  |        |     | 35        |        |                        | V/ $\mu\text{s}$ |                        |
|   |  | Full range   | 20‡   |        |     | 20‡       |        |                        |                  |                        |
| SR- Negative slew rate                                  |  | 25°C   | 38  |        |     | 38        |        |                        | V/ $\mu\text{s}$ |                        |
|   |  | Full range   | 20‡   |        |     | 20‡       |        |                        |                  |                        |
| $t_s$ Settling time                                     | $A_{VD} = -1$ ,<br>2-V step,<br>$R_L = 1\text{ k}\Omega$ ,<br>$C_L = 100\text{ pF}$  | To 10 mV   | 0.25  |        |     | 0.25      |        |                        | $\mu\text{s}$    |                        |
|   |  | To 1 mV  | 0.4   |        |     | 0.4       |        |                        |                  |                        |
| $V_n$ Equivalent input noise voltage                    | $R_S = 20\ \Omega$ ,<br>See Figure 3   | f = 10 Hz  | 48  | 85‡    |     | 48        | 85‡    | nV/ $\sqrt{\text{Hz}}$ |                  |                        |
|   |  | f = 10 kHz   | 12  | 17‡    |     | 12        | 17‡    |                        |                  |                        |
| $V_{N(PP)}$ Peak-to-peak equivalent input noise voltage |  | f = 10 Hz to 10 kHz  | 6   |        |     | 6         |        |                        | $\mu\text{V}$    |                        |
|   |  | f = 0.1 Hz to 10 Hz  | 0.6   |        |     | 0.6       |        |                        |                  |                        |
| $I_n$ Equivalent input noise current                    |  | $V_{IC} = 0$ , f = 10 kHz                                      | 25°C  | 2.8    |     |           | 2.8    |                        |                  | fA/ $\sqrt{\text{Hz}}$ |
| THD + N Total harmonic distortion plus noise            |  | $V_{O(PP)} = 5\text{ V}$ ,<br>f = 1 kHz,<br>$R_S = 25\ \Omega$ | $A_{VD} = 10$ ,<br>$R_L = 2\text{ k}\Omega$ ,<br>25°C | 0.013% |     |           | 0.013% |                        |                  |                        |
| $B_1$ Unity-gain bandwidth                              | $V_I = 10\text{ mV}$ ,<br>$C_L = 25\text{ pF}$ ,<br>$R_L = 2\text{ k}\Omega$ ,<br>See Figure 2                               | 25°C   | 9.4   |        |     | 9.4       |        |                        | MHz              |                        |
| $B_{OM}$ Maximum output-swing bandwidth                 | $V_{O(PP)} = 4\text{ V}$ ,<br>$R_L = 2\text{ k}\Omega$ ,<br>$C_L = 25\text{ pF}$   | $A_{VD} = -1$ ,<br>25°C  | 2.8   |        |     | 2.8       |        |                        | MHz              |                        |
| $\phi_m$ Phase margin at unity gain                     | $V_I = 10\text{ mV}$ ,<br>$C_L = 25\text{ pF}$ ,<br>$R_L = 2\text{ k}\Omega$ ,<br>See Figure 2                               | 25°C   | 56°   |        |     | 56°       |        |                        |                  |                        |

† Full range is  $-55^\circ\text{C}$  to  $125^\circ\text{C}$ .

‡ \*On products compliant to MIL-PRF-38535, Class B, this parameter is not production tested.





**TLE207x, TLE207xA**  
**EXCALIBUR LOW-NOISE HIGH-SPEED**  
**JFET-INPUT OPERATIONAL AMPLIFIERS**

SLOS181C – FEBRUARY 1997 – REVISED DECEMBER 2009

**TLE2071M electrical characteristics at specified free-air temperature,  $V_{CC\pm} = \pm 15$  V (unless otherwise noted)**

| PARAMETER   | TEST CONDITIONS  | $T_A$ †                    | TLE2071M    |             |     | TLE2071AM   |             |                              | UNIT     |    |
|---|--|----------------------------|-------------|-------------|-----|-------------|-------------|------------------------------|----------|----|
|   |  |                            | MIN         | TYP         | MAX | MIN         | TYP         | MAX                          |          |    |
| $V_{IO}$ Input offset voltage   | $V_{IC} = 0,$<br>$R_S = 50 \Omega$<br>$V_O = 0,$                                       | 25°C                       | 0.49        | 4           |     | 0.47        | 2           | mV                           |          |    |
|   |  | Full range                 |             |             | 9.2 |             | 7.2         |                              |          |    |
| $\alpha_{VIO}$ Temperature coefficient of input offset voltage                |  | Full range                 | 3.2         | 29*         |     | 3.2         | 29*         | $\mu\text{V}/^\circ\text{C}$ |          |    |
| $I_{IO}$ Input offset current   | $V_{IC} = 0,$<br>$V_O = 0,$<br>See Figure 4  | 25°C                       | 6           | 100         |     | 6           | 100         | pA                           |          |    |
|   |  | Full range                 |             |             | 20  |             | 20          | nA                           |          |    |
| $I_{IB}$ Input bias current   |  | 25°C                       | 20          | 175         |     | 20          | 175         | pA                           |          |    |
|   |  | Full range                 |             |             | 60  |             | 60          | nA                           |          |    |
| $V_{ICR}$ Common-mode input voltage range                                     | $R_S = 50 \Omega$  | 25°C                       | 15 to -11   | 15 to -11.9 |     | 15 to -11   | 15 to -11.9 | V                            |          |    |
|   |  | Full range                 | 15 to -10.9 |             |     | 15 to -10.9 |             |                              |          |    |
| $V_{OM+}$ Maximum positive peak output voltage swing                          | $I_O = -200 \mu\text{A}$   | 25°C                       | 13.8        | 14.1        |     | 13.8        | 14.1        | V                            |          |    |
|   |  | Full range                 | 13.6        |             |     | 13.6        |             |                              |          |    |
|   | $I_O = -2 \text{ mA}$  | 25°C                       | 13.5        | 13.9        |     | 13.5        | 13.9        |                              |          |    |
|   |  | Full range                 | 13.3        |             |     | 13.3        |             |                              |          |    |
|   | $I_O = -20 \text{ mA}$   | 25°C                       | 11.5        | 12.3        |     | 11.5        | 12.3        |                              |          |    |
|   |  | Full range                 | 11.4        |             |     | 11.4        |             |                              |          |    |
| $V_{OM-}$ Maximum negative peak output voltage swing                          | $I_O = 200 \mu\text{A}$  | 25°C                       | -13.8       | -14.2       |     | -13.8       | -14.2       | V                            |          |    |
|   |  | Full range                 | -13.6       |             |     | -13.6       |             |                              |          |    |
|   | $I_O = 2 \text{ mA}$   | 25°C                       | -13.5       | -14         |     | -13.5       | -14         |                              |          |    |
|   |  | Full range                 | -13.3       |             |     | -13.3       |             |                              |          |    |
|   | $I_O = 20 \text{ mA}$  | 25°C                       | -11.5       | -12.4       |     | -11.5       | -12.4       |                              |          |    |
|   |  | Full range                 | -11.4       |             |     | -11.4       |             |                              |          |    |
| $A_{VD}$ Large-signal differential voltage amplification                      | $V_O = \pm 10 \text{ V}$   | $R_L = 600 \Omega$         | 25°C        | 80          | 96  |             | 80          | 96                           | dB       |    |
|   |  |                            | Full range  | 78          |     |             | 78          |                              |          |    |
|   |  | $R_L = 2 \text{ k}\Omega$  | 25°C        | 90          | 109 |             | 90          | 109                          |          |    |
|   |  |                            | Full range  | 88          |     |             | 88          |                              |          |    |
|   |  | $R_L = 10 \text{ k}\Omega$ | 25°C        | 95          | 118 |             | 95          | 118                          |          |    |
|   |  |                            | Full range  | 93          |     |             | 93          |                              |          |    |
| $r_i$ Input resistance  | $V_{IC} = 0$   | 25°C                       | $10^{12}$   |             |     | $10^{12}$   |             |                              | $\Omega$ |    |
| $c_i$ Input capacitance   | $V_{IC} = 0,$<br>See Figure 5  | Common mode                | 25°C        | 7.5         |     |             | 7.5         |                              |          | pF |
|   |  | Differential               | 25°C        | 2.5         |     |             | 2.5         |                              |          |    |
| $z_o$ Open-loop output impedance  | $f = 1 \text{ MHz}$  | 25°C                       | 80          |             |     | 80          |             |                              | $\Omega$ |    |
| CMRR Common-mode rejection ratio  | $V_{IC} = V_{ICRmin},$<br>$V_O = 0,$<br>$R_S = 50 \Omega$                              | 25°C                       | 80          | 98          |     | 80          | 98          | dB                           |          |    |
|   |  | Full range                 | 78          |             |     | 78          |             |                              |          |    |
| $k_{SVR}$ Supply-voltage rejection ratio ( $\Delta V_{CC\pm}/\Delta V_{IO}$ ) | $V_{CC\pm} = \pm 5 \text{ V to } \pm 15 \text{ V},$<br>$V_O = 0,$<br>$R_S = 50 \Omega$ | 25°C                       | 82          | 99          |     | 82          | 99          | dB                           |          |    |
|   |  | Full range                 | 80          |             |     | 80          |             |                              |          |    |

\*On products compliant to MIL-PRF-38535, Class B, this parameter is not production tested.

† Full range is  $-55^\circ\text{C}$  to  $125^\circ\text{C}$ .



# TLE207x, TLE207xA EXCALIBUR LOW-NOISE HIGH-SPEED JFET-INPUT OPERATIONAL AMPLIFIERS

SLOS181C – FEBRUARY 1997 – REVISED DECEMBER 2009

**TLE2071M electrical characteristics at specified free-air temperature,  $V_{CC\pm} = \pm 15$  V (unless otherwise noted) (continued)**

| PARAMETER                             | TEST CONDITIONS     | $T_A$ †         | TLE2071M |     |     | TLE2071AM |     |     | UNIT |
|---------------------------------------|---------------------|-----------------|----------|-----|-----|-----------|-----|-----|------|
|                                       |                     |                 | MIN      | TYP | MAX | MIN       | TYP | MAX |      |
| $I_{CC}$ Supply current               | $V_O = 0$ , No load | 25°C            | 1.35     | 1.7 | 2.2 | 1.35      | 1.7 | 2.2 | mA   |
|                                       |                     | Full range      | 2.2      |     |     | 2.2       |     |     |      |
| $I_{OS}$ Short-circuit output current | $V_O = 0$           | $V_{ID} = 1$ V  | -30      | -45 |     | -30       | -45 |     | mA   |
|                                       |                     | $V_{ID} = -1$ V | 30       | 48  |     | 30        | 48  |     |      |

† Full range is  $-55^\circ\text{C}$  to  $125^\circ\text{C}$ .

**TLE2071M operating characteristics at specified free-air temperature,  $V_{CC\pm} = \pm 15$  V**

| PARAMETER   | TEST CONDITIONS  | $T_A$ †                                | TLE2071M |        |     | TLE2071AM |        |     | UNIT                   |  |
|---|--|--|----------|--------|-----|-----------|--------|-----|------------------------|--|
|   |  |  | MIN      | TYP    | MAX | MIN       | TYP    | MAX |                        |  |
| SR+ Positive slew rate                                  | $V_{O(PP)} = 10$ V, $A_{VD} = -1$ ,<br>$R_L = 2$ k $\Omega$ ,<br>$C_L = 100$ pF,<br>See Figure 1 | 25°C                                   | 30       | 40     |     | 30        | 40     |     | V/ $\mu$ s             |  |
|   |  | Full range                             | 22       |        |     | 22        |        |     |                        |  |
| SR- Negative slew rate                                  |  | 25°C                                   | 30       | 45     |     | 30        | 45     |     | V/ $\mu$ s             |  |
|   |  | Full range                             | 22       |        |     | 22        |        |     |                        |  |
| $t_s$ Settling time                                     | $A_{VD} = -1$ ,<br>10-V step,<br>$R_L = 1$ k $\Omega$ ,<br>$C_L = 100$ pF                        | To 10 mV                               | 0.4      |        |     | 0.4       |        |     | $\mu$ s                |  |
|   |  | To 1 mV                                | 1.5      |        |     | 1.5       |        |     |                        |  |
| $V_n$ Equivalent input noise voltage                    | $R_S = 20$ $\Omega$ ,<br>See Figure 3  | f = 10 Hz                              | 48       | 85*    |     | 48        | 85*    |     | nV/ $\sqrt{\text{Hz}}$ |  |
|   |  | f = 10 kHz                             | 12       | 17*    |     | 12        | 17*    |     |                        |  |
| $V_{N(PP)}$ Peak-to-peak equivalent input noise voltage |  | f = 10 Hz to 10 kHz                    | 6        |        |     | 6         |        |     | $\mu$ V                |  |
|   |  | f = 0.1 Hz to 10 Hz                    | 0.6      |        |     | 0.6       |        |     |                        |  |
| $I_n$ Equivalent input noise current                    | $V_{IC} = 0$ , f = 10 kHz  | 25°C                                   | 2.8      |        |     | 2.8       |        |     | fA/ $\sqrt{\text{Hz}}$ |  |
| THD + N Total harmonic distortion plus noise            | $V_{O(PP)} = 20$ V, f = 1 kHz, $R_S = 25$ $\Omega$   | $A_{VD} = 10$ , $R_L = 2$ k $\Omega$   | 25°C     | 0.008% |     |           | 0.008% |     |                        |  |
| $B_1$ Unity-gain bandwidth                              | $V_I = 10$ mV, $C_L = 25$ pF,  | $R_L = 2$ k $\Omega$ ,<br>See Figure 2 | 25°C     | 8*     | 10  |           | 8*     | 10  | MHz                    |  |
| $B_{OM}$ Maximum output-swing bandwidth                 | $V_{O(PP)} = 20$ V, $R_L = 2$ k $\Omega$ ,   | $A_{VD} = -1$ ,<br>$C_L = 25$ pF       | 25°C     | 478*   | 637 |           | 478*   | 637 | kHz                    |  |
| $\phi_m$ Phase margin at unity gain                     | $V_I = 10$ mV, $C_L = 25$ pF,  | $R_L = 2$ k $\Omega$ ,<br>See Figure 2 | 25°C     | 57°    |     |           | 57°    |     |                        |  |

\*On products compliant to MIL-PRF-38535, Class B, this parameter is not production tested.

† Full range is  $-55^\circ\text{C}$  to  $125^\circ\text{C}$ .



**TLE207x, TLE207xA**  
**EXCALIBUR LOW-NOISE HIGH-SPEED**  
**JFET-INPUT OPERATIONAL AMPLIFIERS**

SLOS181C – FEBRUARY 1997 – REVISED DECEMBER 2009

**TLE2071Y electrical characteristics at  $V_{CC\pm} = \pm 15\text{ V}$ ,  $T_A = 25^\circ\text{C}$**

| PARAMETER   | TEST CONDITIONS   | TLE2071Y                   |                  |     | UNIT     |
|---|---|----------------------------|------------------|-----|----------|
|   |   | MIN                        | TYP              | MAX |          |
| $V_{IO}$ Input offset voltage   | $V_{IC} = 0$ , $V_O = 0$ , $R_S = 50\ \Omega$                                       |                            | 0.49             | 4   | mV       |
| $I_{IO}$ Input offset current   | $V_{IC} = 0$ , $V_O = 0$ , See Figure 4   |                            | 6                | 100 | pA       |
| $I_{IB}$ Input bias current   |   |                            | 20               | 175 | pA       |
| $V_{ICR}$ Common-mode input voltage range                                     | $R_S = 50\ \Omega$  | 15<br>to<br>-11            | 15<br>to<br>11.9 |     | V        |
| $V_{OM+}$ Maximum positive peak output voltage swing                          | $I_O = -200\ \mu\text{A}$   | 13.8                       | 14.1             |     | V        |
|   | $I_O = -2\ \text{mA}$   | 13.5                       | 13.9             |     |          |
|   | $I_O = -20\ \text{mA}$  | 11.5                       | 12.3             |     |          |
| $V_{OM-}$ Maximum negative peak output voltage swing                          | $I_O = 200\ \mu\text{A}$  | -13.8                      | -14.2            |     | V        |
|   | $I_O = 2\ \text{mA}$  | -13.5                      | -14              |     |          |
|   | $I_O = 20\ \text{mA}$   | -11.5                      | -12.4            |     |          |
| $A_{VD}$ Large-signal differential voltage amplification                      | $V_O = \pm 10\ \text{V}$  | $R_L = 600\ \Omega$        | 80               | 96  | dB       |
|   |   | $R_L = 2\ \text{k}\Omega$  | 90               | 109 |          |
|   |   | $R_L = 10\ \text{k}\Omega$ | 95               | 118 |          |
| $r_i$ Input resistance  | $V_{IC} = 0$  | $10^{12}$                  |                  |     | $\Omega$ |
| $c_i$ Input capacitance   | $V_O = 0$ ,<br>See Figure 5   | Common mode                | 7.5              |     | pF       |
|   |   | Differential               | 2.5              |     |          |
| $z_o$ Open-loop output impedance  | $f = 1\ \text{MHz}$   | 80                         |                  |     | $\Omega$ |
| CMRR Common-mode rejection ratio  | $V_{IC} = V_{ICRmin}$ , $R_S = 50\ \Omega$ , $V_O = 0$                              | 80                         | 98               |     | dB       |
| $k_{SVR}$ Supply-voltage rejection ratio ( $\Delta V_{CC\pm}/\Delta V_{IO}$ ) | $V_{CC\pm} = \pm 5\ \text{V to } \pm 15\ \text{V}$ , $R_S = 50\ \Omega$ , $V_O = 0$ | 82                         | 99               |     | dB       |
| $I_{CC}$ Supply current   | $V_O = 0$ , No load   | 1.35                       | 1.7              | 2.2 | mA       |
| $I_{OS}$ Short-circuit output current   | $V_O = 0$   | $V_{ID} = 1\ \text{V}$     | -30              | -45 | mA       |
|   |   | $V_{ID} = -1\ \text{V}$    | 30               | 48  |          |



# TLE207x, TLE207xA EXCALIBUR LOW-NOISE HIGH-SPEED JFET-INPUT OPERATIONAL AMPLIFIERS

SLOS181C – FEBRUARY 1997 – REVISED DECEMBER 2009

**TLE2072C electrical characteristics at specified free-air temperature,  $V_{CC\pm} = \pm 5\text{ V}$  (unless otherwise noted)**

| PARAMETER   | TEST CONDITIONS  | $T_A$ †                    | TLE2072C   |           |      | TLE2072AC |           |                              | UNIT     |    |
|---|--|----------------------------|------------|-----------|------|-----------|-----------|------------------------------|----------|----|
|   |  |                            | MIN        | TYP       | MAX  | MIN       | TYP       | MAX                          |          |    |
| $V_{IO}$ Input offset voltage   | $V_{IC} = 0, V_O = 0,$<br>$R_S = 50\ \Omega$                                       | 25°C                       | 0.9        | 6         |      | 0.65      | 3.5       | mV                           |          |    |
|   |  | Full range                 |            |           | 7.8  |           | 5.3       |                              |          |    |
| $\alpha_{VIO}$ Temperature coefficient of input offset voltage                  |  | Full range                 | 2.3        | 25        |      | 2.3       | 25        | $\mu\text{V}/^\circ\text{C}$ |          |    |
| $I_{IO}$ Input offset current   | $V_{IC} = 0, V_O = 0,$<br>See Figure 4   | 25°C                       | 5          | 100       |      | 5         | 100       | pA                           |          |    |
|   |  | Full range                 |            |           | 1.4  |           | 1.4       | nA                           |          |    |
| $I_{IB}$ Input bias current   |  | 25°C                       | 15         | 175       |      | 15        | 175       | pA                           |          |    |
|   |  | Full range                 |            |           | 5    |           | 5         | nA                           |          |    |
| $V_{ICR}$ Common-mode input voltage range                                       | $R_S = 50\ \Omega$   | 25°C                       | 5 to -1    | 5 to -1.9 |      | 5 to -1   | 5 to -1.9 | V                            |          |    |
|   |  | Full range                 | 5 to -0.9  |           |      | 5 to -0.9 |           |                              |          |    |
| $V_{OM+}$ Maximum positive peak output voltage swing                            | $I_O = -200\ \mu\text{A}$  | 25°C                       | 3.8        | 4.1       |      | 3.8       | 4.1       | V                            |          |    |
|   |  | Full range                 | 3.7        |           |      | 3.7       |           |                              |          |    |
|   | $I_O = -2\ \text{mA}$  | 25°C                       | 3.5        | 3.9       |      | 3.5       | 3.9       |                              |          |    |
|   |  | Full range                 | 3.4        |           |      | 3.4       |           |                              |          |    |
| $I_O = -20\ \text{mA}$  | 25°C   | 1.5                        | 2.3        |           | 1.5  | 2.3       |           |                              |          |    |
|   | Full range   | 1.5                        |            |           | 1.5  |           |           |                              |          |    |
| $V_{OM-}$ Maximum negative peak output voltage swing                            | $I_O = 200\ \mu\text{A}$   | 25°C                       | -3.8       | -4.2      |      | -3.8      | -4.2      | V                            |          |    |
|   |  | Full range                 | -3.7       |           |      | -3.7      |           |                              |          |    |
|   | $I_O = 2\ \text{mA}$   | 25°C                       | -3.5       | -4.1      |      | -3.5      | -4.1      |                              |          |    |
|   |  | Full range                 | -3.4       |           |      | -3.4      |           |                              |          |    |
| $I_O = 20\ \text{mA}$   | 25°C   | -1.5                       | -2.4       |           | -1.5 | -2.4      |           |                              |          |    |
|   | Full range   | -1.5                       |            |           | -1.5 |           |           |                              |          |    |
| $A_{VD}$ Large-signal differential voltage amplification                        | $V_O = \pm 2.3\ \text{V}$  | $R_L = 600\ \Omega$        | 25°C       | 80        | 91   |           | 80        | 91                           | dB       |    |
|   |  |                            | Full range | 79        |      |           | 79        |                              |          |    |
|   |  | $R_L = 2\ \text{k}\Omega$  | 25°C       | 90        | 100  |           | 90        | 100                          |          |    |
|   |  |                            | Full range | 89        |      |           | 89        |                              |          |    |
|   |  | $R_L = 10\ \text{k}\Omega$ | 25°C       | 95        | 106  |           | 95        | 106                          |          |    |
|   |  |                            | Full range | 94        |      |           | 94        |                              |          |    |
| $r_i$ Input resistance  | $V_{IC} = 0$   | 25°C                       | $10^{12}$  |           |      | $10^{12}$ |           |                              | $\Omega$ |    |
| $c_i$ Input capacitance   | $V_{IC} = 0,$<br>See Figure 5  | Common mode                | 25°C       | 11        |      |           | 11        |                              |          | pF |
|   |  | Differential               | 25°C       | 2.5       |      |           | 2.5       |                              |          |    |
| $z_o$ Open-loop output impedance  | $f = 1\ \text{MHz}$  | 25°C                       | 80         |           |      | 80        |           |                              | $\Omega$ |    |
| CMRR Common-mode rejection ratio  | $V_{IC} = V_{ICRmin},$<br>$V_O = 0, R_S = 50\ \Omega$                              | 25°C                       | 70         | 89        |      | 70        | 89        | dB                           |          |    |
|   |  | Full range                 | 68         |           |      | 68        |           |                              |          |    |
| $k_{SVR}$ Supply-voltage rejection ratio ( $\Delta V_{CC\pm} / \Delta V_{IO}$ ) | $V_{CC\pm} = \pm 5\ \text{V to } \pm 15\ \text{V},$<br>$V_O = 0, R_S = 50\ \Omega$ | 25°C                       | 82         | 99        |      | 82        | 99        | dB                           |          |    |
|   |  | Full range                 | 80         |           |      | 80        |           |                              |          |    |

† Full range is 0°C to 70°C.



**TLE207x, TLE207xA**  
**EXCALIBUR LOW-NOISE HIGH-SPEED**  
**JFET-INPUT OPERATIONAL AMPLIFIERS**

SLOS181C – FEBRUARY 1997 – REVISED DECEMBER 2009

**TLE2072C electrical characteristics at specified free-air temperature,  $V_{CC\pm} = \pm 5\text{ V}$  (unless otherwise noted)**  
**(continued)**

| PARAMETER | TEST CONDITIONS                | $T_A$                                   | TLE2072C               |     |     | TLE2072AC |     |     | UNIT |    |
|-----------|--------------------------------|---|------------------------|-----|-----|-----------|-----|-----|------|----|
|           |                                |   | MIN                    | TYP | MAX | MIN       | TYP | MAX |      |    |
| $I_{CC}$  | Supply current (both channels) | $V_O = 0$ , No load                     | 25°C                   | 2.7 | 2.9 | 3.9       | 2.7 | 2.9 | 3.9  | mA |
|           |                                |   | Full range             | 3.9 |     |           | 3.9 |     |      |    |
| $a_x$     | Crosstalk attenuation          | $V_{IC} = 0$ , $R_L = 2\text{ k}\Omega$ | 25°C                   | 120 |     |           | 120 |     |      | dB |
| $I_{OS}$  | Short-circuit output current   | $V_O = 0$                               | $V_{ID} = 1\text{ V}$  | -35 |     |           | -35 |     |      | mA |
|           |                                |   | $V_{ID} = -1\text{ V}$ | 45  |     |           | 45  |     |      |    |

**TLE2072C operating characteristics at specified free-air temperature,  $V_{CC\pm} = \pm 5\text{ V}$**

| PARAMETER   | TEST CONDITIONS                             | $T_A^\dagger$  | TLE2072C            |        |     | TLE2072AC |        |     | UNIT |                              |
|-------------|---|--|---------------------|--------|-----|-----------|--------|-----|------|------------------------------|
|             |   |  | MIN                 | TYP    | MAX | MIN       | TYP    | MAX |      |                              |
| SR+         | Positive slew rate                          | $V_{O(PP)} = \pm 2.3\text{ V}$ ,<br>$A_{VD} = -1$ ,<br>$C_L = 100\text{ pF}$ ,<br>$R_L = 2\text{ k}\Omega$ ,<br>See Figure 1 | 25°C                | 35     |     |           | 35     |     |      | $\text{V}/\mu\text{s}$       |
|             |   |  | Full range          | 22     |     |           | 22     |     |      |                              |
| SR-         | Negative slew rate                          | $V_{O(PP)} = \pm 2.3\text{ V}$ ,<br>$A_{VD} = -1$ ,<br>$C_L = 100\text{ pF}$ ,<br>$R_L = 2\text{ k}\Omega$ ,<br>See Figure 1 | 25°C                | 38     |     |           | 38     |     |      | $\text{V}/\mu\text{s}$       |
|             |   |  | Full range          | 22     |     |           | 22     |     |      |                              |
| $t_s$       | Settling time                               | $A_{VD} = -1$ ,<br>2-V step,<br>$R_L = 1\text{ k}\Omega$ ,<br>$C_L = 100\text{ pF}$  | To 10 mV            | 0.25   |     |           | 0.25   |     |      | $\mu\text{s}$                |
|             |   |  | To 1 mV             | 0.4    |     |           | 0.4    |     |      |                              |
| $V_n$       | Equivalent input noise voltage              | $R_S = 20\ \Omega$ ,<br>See Figure 3   | f = 10 Hz           | 48     | 85  |           | 48     | 85  |      | $\text{nV}/\sqrt{\text{Hz}}$ |
|             |   |  | f = 10 kHz          | 12     | 17  |           | 12     | 17  |      |                              |
| $V_{N(PP)}$ | Peak-to-peak equivalent input noise voltage | $R_S = 20\ \Omega$ ,<br>See Figure 3   | f = 10 Hz to 10 kHz | 6      |     |           | 6      |     |      | $\mu\text{V}$                |
|             |   |  | f = 0.1 Hz to 10 Hz | 0.6    |     |           | 0.6    |     |      |                              |
| $I_n$       | Equivalent input noise current              | $V_{IC} = 0$ , f = 10 kHz  | 25°C                | 2.8    |     |           | 2.8    |     |      | $\text{fA}/\sqrt{\text{Hz}}$ |
| THD + N     | Total harmonic distortion plus noise        | $V_{O(PP)} = 5\text{ V}$ ,<br>f = 1 kHz,<br>$R_S = 25\ \Omega$   | 25°C                | 0.013% |     |           | 0.013% |     |      |                              |
| $B_1$       | Unity-gain bandwidth                        | $V_I = 10\text{ mV}$ ,<br>$C_L = 25\text{ pF}$ ,<br>$R_L = 2\text{ k}\Omega$ ,<br>See Figure 2                               | 25°C                | 9.4    |     |           | 9.4    |     |      | MHz                          |
| $B_{OM}$    | Maximum output-swing bandwidth              | $V_{O(PP)} = 4\text{ V}$ ,<br>$R_L = 2\text{ k}\Omega$ ,<br>$A_{VD} = -1$ ,<br>$C_L = 25\text{ pF}$                          | 25°C                | 2.8    |     |           | 2.8    |     |      | MHz                          |
| $\phi_m$    | Phase margin at unity gain                  | $V_I = 10\text{ mV}$ ,<br>$C_L = 25\text{ pF}$ ,<br>$R_L = 2\text{ k}\Omega$ ,<br>See Figure 2                               | 25°C                | 56°    |     |           | 56°    |     |      |                              |

$^\dagger$  Full range is 0°C to 70°C.

# TLE207x, TLE207xA EXCALIBUR LOW-NOISE HIGH-SPEED JFET-INPUT OPERATIONAL AMPLIFIERS

SLOS181C – FEBRUARY 1997 – REVISED DECEMBER 2009

**TLE2072C electrical characteristics at specified free-air temperature,  $V_{CC\pm} = \pm 15$  V (unless otherwise noted)**

| PARAMETER   | TEST CONDITIONS   | $T_A$ †               | TLE2072C    |             |       | TLE2072AC   |             |                  | UNIT     |    |
|---|---|-----------------------|-------------|-------------|-------|-------------|-------------|------------------|----------|----|
|   |   |                       | MIN         | TYP         | MAX   | MIN         | TYP         | MAX              |          |    |
| $V_{IO}$ Input offset voltage   | $V_{IC} = 0,$<br>$R_S = 50 \Omega$<br>$V_O = 0,$                        | 25°C                  | 1.1         | 6           |       | 0.7         | 3.5         | mV               |          |    |
|   |   | Full range            |             |             | 7.8   |             | 5.3         |                  |          |    |
| $\alpha_{VIO}$ Temperature coefficient of input offset voltage                |   | Full range            | 2.4         | 25          |       | 2.4         | 25          | $\mu V/^\circ C$ |          |    |
| $I_{IO}$ Input offset current   | $V_{IC} = 0,$<br>$V_O = 0,$<br>See Figure 4                             | 25°C                  | 6           | 100         |       | 6           | 100         | pA               |          |    |
|   |   | Full range            |             |             | 1.4   |             | 1.4         | nA               |          |    |
| $I_{IB}$ Input bias current   |   | 25°C                  | 20          | 175         |       | 20          | 175         | pA               |          |    |
|   |   | Full range            |             |             | 5     |             | 5           | nA               |          |    |
| $V_{ICR}$ Common-mode input voltage range                                     | $R_S = 50 \Omega$   | 25°C                  | 15 to -11   | 15 to -11.9 |       | 15 to -11   | 15 to -11.9 | V                |          |    |
|   |   | Full range            | 15 to -10.9 |             |       | 15 to -10.9 |             |                  |          |    |
| $V_{OM+}$ Maximum positive peak output voltage swing                          | $I_O = -200 \mu A$  | 25°C                  | 13.8        | 14.1        |       | 13.8        | 14.1        | V                |          |    |
|   |   | Full range            | 13.6        |             |       | 13.6        |             |                  |          |    |
|   | $I_O = -2$ mA   | 25°C                  | 13.5        | 13.9        |       | 13.5        | 13.9        |                  |          |    |
|   |   | Full range            | 13.4        |             |       | 13.4        |             |                  |          |    |
| $I_O = -20$ mA  | 25°C  | 11.5                  | 12.3        |             | 11.5  | 12.3        |             |                  |          |    |
|   | Full range  | 11.5                  |             |             | 11.5  |             |             |                  |          |    |
| $V_{OM-}$ Maximum negative peak output voltage swing                          | $I_O = 200 \mu A$   | 25°C                  | -13.8       | -14.2       |       | -13.8       | -14.2       | V                |          |    |
|   |   | Full range            | -13.7       |             |       | -13.7       |             |                  |          |    |
|   | $I_O = 2$ mA  | 25°C                  | -13.5       | -14         |       | -13.5       | -14         |                  |          |    |
|   |   | Full range            | -13.4       |             |       | -13.4       |             |                  |          |    |
| $I_O = 20$ mA   | 25°C  | -11.5                 | -12.4       |             | -11.5 | -12.4       |             |                  |          |    |
|   | Full range  | -11.5                 |             |             | -11.5 |             |             |                  |          |    |
| $A_{VD}$ Large-signal differential voltage amplification                      | $V_O = \pm 10$ V  | $R_L = 600 \Omega$    | 25°C        | 80          | 96    |             | 80          | 96               | dB       |    |
|   |   |                       | Full range  | 79          |       |             | 79          |                  |          |    |
|   |   | $R_L = 2$ k $\Omega$  | 25°C        | 90          | 109   |             | 90          | 109              |          |    |
|   |   |                       | Full range  | 89          |       |             | 89          |                  |          |    |
|   |   | $R_L = 10$ k $\Omega$ | 25°C        | 95          | 118   |             | 95          | 118              |          |    |
|   |   |                       | Full range  | 94          |       |             | 94          |                  |          |    |
| $r_i$ Input resistance  | $V_{IC} = 0$  | 25°C                  | $10^{12}$   |             |       | $10^{12}$   |             |                  | $\Omega$ |    |
| $c_i$ Input capacitance   | $V_{IC} = 0,$<br>See Figure 5   | Common mode           | 25°C        | 7.5         |       |             | 7.5         |                  |          | pF |
|   |   | Differential          | 25°C        | 2.5         |       |             | 2.5         |                  |          |    |
| $z_o$ Open-loop output impedance  | $f = 1$ MHz   | 25°C                  | 80          |             |       | 80          |             |                  | $\Omega$ |    |
| CMRR Common-mode rejection ratio  | $V_{IC} = V_{ICRmin},$<br>$V_O = 0,$<br>$R_S = 50 \Omega$               | 25°C                  | 80          | 98          |       | 80          | 98          | dB               |          |    |
|   |   | Full range            | 79          |             |       | 79          |             |                  |          |    |
| $k_{SVR}$ Supply-voltage rejection ratio ( $\Delta V_{CC\pm}/\Delta V_{IO}$ ) | $V_{CC\pm} = \pm 5$ V to $\pm 15$ V,<br>$V_O = 0,$<br>$R_S = 50 \Omega$ | 25°C                  | 82          | 99          |       | 82          | 99          | dB               |          |    |
|   |   | Full range            | 81          |             |       | 81          |             |                  |          |    |

† Full range is 0°C to 70°C.



**TLE207x, TLE207xA**  
**EXCALIBUR LOW-NOISE HIGH-SPEED**  
**JFET-INPUT OPERATIONAL AMPLIFIERS**

SLOS181C – FEBRUARY 1997 – REVISED DECEMBER 2009

**TLE2072C electrical characteristics at specified free-air temperature,  $V_{CC\pm} = \pm 15\text{ V}$  (unless otherwise noted) (continued)**

| PARAMETER | TEST CONDITIONS                | $T_A$                                   | TLE2072C   |                        |     | TLE2072AC |     |     | UNIT |    |
|-----------|--------------------------------|---|------------|------------------------|-----|-----------|-----|-----|------|----|
|           |                                |   | MIN        | TYP                    | MAX | MIN       | TYP | MAX |      |    |
| $I_{CC}$  | Supply current (both channels) | $V_O = 0$ , No load                     | 25°C       | 2.7                    | 3.1 | 3.9       | 2.7 | 3.1 | 3.9  | mA |
|           |                                |   | Full range | 3.9                    |     |           | 3.9 |     |      |    |
| $a_x$     | Crosstalk attenuation          | $V_{IC} = 0$ , $R_L = 2\text{ k}\Omega$ | 25°C       | 120                    |     |           | 120 |     |      | dB |
| $I_{OS}$  | Short-circuit output current   | $V_O = 0$                               | 25°C       | $V_{ID} = 1\text{ V}$  | -30 | -45       | -30 | -45 | mA   |    |
|           |                                |   |            | $V_{ID} = -1\text{ V}$ | 30  | 48        | 30  | 48  |      |    |

**TLE2072C operating characteristics at specified free-air temperature,  $V_{CC\pm} = \pm 15\text{ V}$**

| PARAMETER   | TEST CONDITIONS                             | $T_A$ †   | TLE2072C            |        |     | TLE2072AC |        |                        | UNIT |                        |
|-------------|---|---|---------------------|--------|-----|-----------|--------|------------------------|------|------------------------|
|             |   |   | MIN                 | TYP    | MAX | MIN       | TYP    | MAX                    |      |                        |
| SR+         | Positive slew rate                          | $V_{O(PP)} = 10\text{ V}$ ,<br>$A_{VD} = -1$ ,<br>$C_L = 100\text{ pF}$ ,<br>$R_L = 2\text{ k}\Omega$ ,<br>See Figure 1 | 25°C                | 28     | 40  | 28        | 40     | V/ $\mu$ s             |      |                        |
|             |   |   | Full range          | 25     |     |           | 25     |                        |      |                        |
| SR-         | Negative slew rate                          | $V_{O(PP)} = 10\text{ V}$ ,<br>$A_{VD} = -1$ ,<br>$C_L = 100\text{ pF}$ ,<br>$R_L = 2\text{ k}\Omega$ ,<br>See Figure 1 | 25°C                | 30     | 45  | 30        | 45     | V/ $\mu$ s             |      |                        |
|             |   |   | Full range          | 25     |     |           | 25     |                        |      |                        |
| $t_s$       | Settling time                               | $A_{VD} = -1$ ,<br>10-V step,<br>$R_L = 1\text{ k}\Omega$ ,<br>$C_L = 100\text{ pF}$                                    | To 10 mV            | 0.4    |     |           | 0.4    |                        |      | $\mu$ s                |
|             |   |   | To 1 mV             | 1.5    |     |           | 1.5    |                        |      |                        |
| $V_n$       | Equivalent input noise voltage              | $R_S = 20\ \Omega$ ,<br>See Figure 3  | f = 10 Hz           | 48     | 85  | 48        | 85     | nV/ $\sqrt{\text{Hz}}$ |      |                        |
|             |   |   | f = 10 kHz          | 12     | 17  | 12        | 17     |                        |      |                        |
| $V_{N(PP)}$ | Peak-to-peak equivalent input noise voltage | $R_S = 20\ \Omega$ ,<br>See Figure 3  | f = 10 Hz to 10 kHz | 6      |     |           | 6      |                        |      | $\mu$ V                |
|             |   |   | f = 0.1 Hz to 10 Hz | 0.6    |     |           | 0.6    |                        |      |                        |
| $I_n$       | Equivalent input noise current              | $V_{IC} = 0$ , f = 10 kHz   | 25°C                | 2.8    |     |           | 2.8    |                        |      | fA/ $\sqrt{\text{Hz}}$ |
| THD + N     | Total harmonic distortion plus noise        | $V_{O(PP)} = 20\text{ V}$ ,<br>f = 1 kHz,<br>$R_S = 25\ \Omega$   | 25°C                | 0.008% |     |           | 0.008% |                        |      |                        |
| $B_1$       | Unity-gain bandwidth                        | $V_I = 10\text{ mV}$ ,<br>$C_L = 25\text{ pF}$ ,<br>$R_L = 2\text{ k}\Omega$ ,<br>See Figure 2                          | 25°C                | 8      | 10  | 8         | 10     | MHz                    |      |                        |
| $B_{OM}$    | Maximum output-swing bandwidth              | $V_{O(PP)} = 20\text{ V}$ ,<br>$R_L = 2\text{ k}\Omega$ ,<br>$A_{VD} = -1$ ,<br>$C_L = 25\text{ pF}$                    | 25°C                | 478    | 637 | 478       | 637    | kHz                    |      |                        |
| $\phi_m$    | Phase margin at unity gain                  | $V_I = 10\text{ mV}$ ,<br>$C_L = 25\text{ pF}$ ,<br>$R_L = 2\text{ k}\Omega$ ,<br>See Figure 2                          | 25°C                | 57°    |     |           | 57°    |                        |      |                        |

† Full range is 0°C to 70°C.

# TLE207x, TLE207xA EXCALIBUR LOW-NOISE HIGH-SPEED JFET-INPUT OPERATIONAL AMPLIFIERS

SLOS181C – FEBRUARY 1997 – REVISED DECEMBER 2009

TLE2072I electrical characteristics at specified free-air temperature,  $V_{CC\pm} = \pm 5\text{ V}$  (unless otherwise noted)

| PARAMETER   | TEST CONDITIONS   | $T_A$ †                    | TLE2072I   |           |     | TLE2072AI |           |                              | UNIT     |    |
|---|---|----------------------------|------------|-----------|-----|-----------|-----------|------------------------------|----------|----|
|   |   |                            | MIN        | TYP       | MAX | MIN       | TYP       | MAX                          |          |    |
| $V_{IO}$ Input offset voltage   | $V_{IC} = 0, V_O = 0, R_S = 50\ \Omega$                                       | 25°C                       | 0.9        | 6         |     | 0.65      | 3.5       | mV                           |          |    |
|   |   | Full range                 |            |           | 9.1 |           | 6.4       |                              |          |    |
| $\alpha_{VIO}$ Temperature coefficient of input offset voltage                |   | Full range                 | 2.4        | 25        |     | 2.4       | 25        | $\mu\text{V}/^\circ\text{C}$ |          |    |
| $I_{IO}$ Input offset current   | $V_{IC} = 0, V_O = 0, \text{See Figure 4}$                                    | 25°C                       | 5          | 100       |     | 5         | 100       | pA                           |          |    |
|   |   | Full range                 |            |           | 5   |           | 5         | nA                           |          |    |
| $I_{IB}$ Input bias current   |   | 25°C                       | 15         | 175       |     | 15        | 175       | pA                           |          |    |
|   |   | Full range                 |            |           | 10  |           | 10        | nA                           |          |    |
| $V_{ICR}$ Common-mode input voltage range                                     | $R_S = 50\ \Omega$  | 25°C                       | 5 to -1    | 5 to -1.9 |     | 5 to -1   | 5 to -1.9 | V                            |          |    |
|   |   | Full range                 | 5 to -0.8  |           |     | 5 to -0.8 |           |                              |          |    |
| $V_{OM+}$ Maximum positive peak output voltage swing                          | $I_O = -200\ \mu\text{A}$   | 25°C                       | 3.8        | 4.1       |     | 3.8       | 4.1       | V                            |          |    |
|   |   | Full range                 | 3.7        |           |     | 3.7       |           |                              |          |    |
|   | $I_O = -2\ \text{mA}$   | 25°C                       | 3.5        | 3.9       |     | 3.5       | 3.9       |                              |          |    |
|   |   | Full range                 | 3.4        |           |     | 3.4       |           |                              |          |    |
|   | $I_O = -20\ \text{mA}$  | 25°C                       | 1.5        | 2.3       |     | 1.5       | 2.3       |                              |          |    |
|   |   | Full range                 | 1.5        |           |     | 1.5       |           |                              |          |    |
| $V_{OM-}$ Maximum negative peak output voltage swing                          | $I_O = 200\ \mu\text{A}$  | 25°C                       | -3.8       | -4.2      |     | -3.8      | -4.2      | V                            |          |    |
|   |   | Full range                 | -3.7       |           |     | -3.7      |           |                              |          |    |
|   | $I_O = 2\ \text{mA}$  | 25°C                       | -3.5       | -4.1      |     | -3.5      | -4.1      |                              |          |    |
|   |   | Full range                 | -3.4       |           |     | -3.4      |           |                              |          |    |
|   | $I_O = 20\ \text{mA}$   | 25°C                       | -1.5       | -2.4      |     | -1.5      | -2.4      |                              |          |    |
|   |   | Full range                 | -1.5       |           |     | -1.5      |           |                              |          |    |
| $A_{VD}$ Large-signal differential voltage amplification                      | $V_O = \pm 2.3\ \text{V}$   | $R_L = 600\ \Omega$        | 25°C       | 80        | 91  |           | 80        | 91                           | dB       |    |
|   |   |                            | Full range | 79        |     |           | 79        |                              |          |    |
|   |   | $R_L = 2\ \text{k}\Omega$  | 25°C       | 90        | 100 |           | 90        | 100                          |          |    |
|   |   |                            | Full range | 89        |     |           | 89        |                              |          |    |
|   |   | $R_L = 10\ \text{k}\Omega$ | 25°C       | 95        | 106 |           | 95        | 106                          |          |    |
|   |   |                            | Full range | 94        |     |           | 94        |                              |          |    |
| $r_i$ Input resistance  | $V_{IC} = 0$  | 25°C                       | $10^{12}$  |           |     | $10^{12}$ |           |                              | $\Omega$ |    |
| $c_i$ Input capacitance   | $V_{IC} = 0, \text{See Figure 5}$   | Common mode                | 25°C       | 11        |     |           | 11        |                              |          | pF |
|   |   | Differential               | 25°C       | 2.5       |     |           | 2.5       |                              |          |    |
| $z_o$ Open-loop output impedance  | $f = 1\ \text{MHz}$   | 25°C                       | 80         |           |     | 80        |           |                              | $\Omega$ |    |
| CMRR Common-mode rejection ratio  | $V_{IC} = V_{ICRmin}, V_O = 0, R_S = 50\ \Omega$                              | 25°C                       | 70         | 89        |     | 70        | 89        | dB                           |          |    |
|   |   | Full range                 | 68         |           |     | 68        |           |                              |          |    |
| $k_{SVR}$ Supply-voltage rejection ratio ( $\Delta V_{CC\pm}/\Delta V_{IO}$ ) | $V_{CC\pm} = \pm 5\ \text{V to } \pm 15\ \text{V}, V_O = 0, R_S = 50\ \Omega$ | 25°C                       | 82         | 99        |     | 82        | 99        | dB                           |          |    |
|   |   | Full range                 | 80         |           |     | 80        |           |                              |          |    |

† Full range is  $-40^\circ\text{C}$  to  $85^\circ\text{C}$ .





**TLE207x, TLE207xA**  
**EXCALIBUR LOW-NOISE HIGH-SPEED**  
**JFET-INPUT OPERATIONAL AMPLIFIERS**

SLOS181C – FEBRUARY 1997 – REVISED DECEMBER 2009

**TLE2072I electrical characteristics at specified free-air temperature,  $V_{CC\pm} = \pm 5\text{ V}$  (unless otherwise noted) (continued)**

| PARAMETER | TEST CONDITIONS                | $T_A$                                   | TLE2072I               |     |     | TLE2072AI |     |     | UNIT |    |
|-----------|--------------------------------|---|------------------------|-----|-----|-----------|-----|-----|------|----|
|           |                                |   | MIN                    | TYP | MAX | MIN       | TYP | MAX |      |    |
| $I_{CC}$  | Supply current (both channels) | $V_O = 0$ , No load                     | 25°C                   | 2.7 | 2.9 | 3.9       | 2.7 | 2.9 | 3.9  | mA |
|           |                                |   | Full range             | 3.9 |     |           | 3.9 |     |      |    |
| $a_x$     | Crosstalk attenuation          | $V_{IC} = 0$ , $R_L = 2\text{ k}\Omega$ | 25°C                   | 120 |     |           | 120 |     |      | dB |
| $I_{OS}$  | Short-circuit output current   | $V_O = 0$                               | $V_{ID} = 1\text{ V}$  | -35 |     |           | -35 |     |      | mA |
|           |                                |   | $V_{ID} = -1\text{ V}$ | 45  |     |           | 45  |     |      |    |

**TLE2072I operating characteristics at specified free-air temperature,  $V_{CC\pm} = \pm 5\text{ V}$**

| PARAMETER   | TEST CONDITIONS                             | $T_A$ †  | TLE2072I  |        |     | TLE2072AI |        |     | UNIT                   |                        |
|-------------|---|--|---|--------|-----|-----------|--------|-----|------------------------|------------------------|
|             |   |  | MIN   | TYP    | MAX | MIN       | TYP    | MAX |                        |                        |
| SR+         | Positive slew rate                          | $V_{O(PP)} = \pm 2.3\text{ V}$ ,<br>$A_{VD} = -1$ ,<br>$C_L = 100\text{ pF}$ ,<br>$R_L = 2\text{ k}\Omega$ ,<br>See Figure 1 | 25°C  | 35     |     |           | 35     |     |                        | V/ $\mu\text{s}$       |
|             |   |  | Full range  | 20     |     |           | 20     |     |                        |                        |
| SR-         | Negative slew rate                          | $V_{O(PP)} = \pm 2.3\text{ V}$ ,<br>$A_{VD} = -1$ ,<br>$C_L = 100\text{ pF}$ ,<br>$R_L = 2\text{ k}\Omega$ ,<br>See Figure 1 | 25°C  | 38     |     |           | 38     |     |                        | V/ $\mu\text{s}$       |
|             |   |  | Full range  | 20     |     |           | 20     |     |                        |                        |
| $t_s$       | Settling time                               | $A_{VD} = -1$ ,<br>2-V step,<br>$R_L = 1\text{ k}\Omega$ ,<br>$C_L = 100\text{ pF}$  | To 10 mV  | 0.25   |     |           | 0.25   |     |                        | $\mu\text{s}$          |
|             |   |  | To 1 mV   | 0.4    |     |           | 0.4    |     |                        |                        |
| $V_n$       | Equivalent input noise voltage              | $R_S = 20\ \Omega$ ,<br>See Figure 3   | f = 10 Hz   | 48     | 85  |           | 48     | 85  | nV/ $\sqrt{\text{Hz}}$ |                        |
|             |   |  | f = 10 kHz  | 12     | 17  |           | 12     | 17  |                        |                        |
| $V_{N(PP)}$ | Peak-to-peak equivalent input noise voltage | $R_S = 20\ \Omega$ ,<br>See Figure 3   | f = 10 Hz to 10 kHz                                   | 6      |     |           | 6      |     |                        | $\mu\text{V}$          |
|             |   |  | f = 0.1 Hz to 10 Hz                                   | 0.6    |     |           | 0.6    |     |                        |                        |
| $I_n$       | Equivalent input noise current              | $V_{IC} = 0$ , f = 10 kHz  | 25°C  | 2.8    |     |           | 2.8    |     |                        | fA/ $\sqrt{\text{Hz}}$ |
| THD + N     | Total harmonic distortion plus noise        | $V_{O(PP)} = 5\text{ V}$ ,<br>f = 1 kHz,<br>$R_S = 25\ \Omega$   | $A_{VD} = 10$ ,<br>$R_L = 2\text{ k}\Omega$ ,<br>25°C | 0.013% |     |           | 0.013% |     |                        |                        |
| $B_1$       | Unity-gain bandwidth                        | $V_I = 10\text{ mV}$ ,<br>$C_L = 25\text{ pF}$ ,<br>$R_L = 2\text{ k}\Omega$ ,<br>See Figure 2                               | 25°C  | 9.4    |     |           | 9.4    |     |                        | MHz                    |
| $B_{OM}$    | Maximum output-swing bandwidth              | $V_{O(PP)} = 4\text{ V}$ ,<br>$R_L = 2\text{ k}\Omega$ ,<br>$A_{VD} = -1$ ,<br>$C_L = 25\text{ pF}$                          | 25°C  | 2.8    |     |           | 2.8    |     |                        | MHz                    |
| $\phi_m$    | Phase margin at unity gain                  | $V_I = 10\text{ mV}$ ,<br>$C_L = 25\text{ pF}$ ,<br>$R_L = 2\text{ k}\Omega$ ,<br>See Figure 2                               | 25°C  | 56°    |     |           | 56°    |     |                        |                        |

† Full range is 40°C to 85°C.

# TLE207x, TLE207xA EXCALIBUR LOW-NOISE HIGH-SPEED JFET-INPUT OPERATIONAL AMPLIFIERS

SLOS181C – FEBRUARY 1997 – REVISED DECEMBER 2009

**TLE2072I electrical characteristics at specified free-air temperature,  $V_{CC\pm} = \pm 15\text{ V}$  (unless otherwise noted)**

| PARAMETER   | TEST CONDITIONS   | $T_A$ †                    | TLE2072I    |             |     | TLE2072AI   |             |                              | UNIT     |    |
|---|---|----------------------------|-------------|-------------|-----|-------------|-------------|------------------------------|----------|----|
|   |   |                            | MIN         | TYP         | MAX | MIN         | TYP         | MAX                          |          |    |
| $V_{IO}$ Input offset voltage   | $V_{IC} = 0,$<br>$R_S = 50\ \Omega,$<br>$V_O = 0,$                                      | 25°C                       | 1.1         | 6           |     | 0.7         | 3.5         | mV                           |          |    |
|   |   | Full range                 |             |             | 9.1 |             | 6.4         |                              |          |    |
| $\alpha_{VIO}$ Temperature coefficient of input offset voltage                |   | Full range                 | 2.4         | 25          |     | 2.4         | 25          | $\mu\text{V}/^\circ\text{C}$ |          |    |
| $I_{IO}$ Input offset current   | $V_{IC} = 0,$<br>$V_O = 0,$<br>See Figure 4   | 25°C                       | 6           | 100         |     | 6           | 100         | pA                           |          |    |
|   |   | Full range                 |             |             | 5   |             | 5           | nA                           |          |    |
| $I_{IB}$ Input bias current   |   | 25°C                       | 20          | 175         |     | 20          | 175         | pA                           |          |    |
|   |   | Full range                 |             |             | 10  |             | 10          | nA                           |          |    |
| $V_{ICR}$ Common-mode input voltage range                                     | $R_S = 50\ \Omega$  | 25°C                       | 15 to -11   | 15 to -11.9 |     | 15 to -11   | 15 to -11.9 | V                            |          |    |
|   |   | Full range                 | 15 to -10.8 |             |     | 15 to -10.8 |             |                              |          |    |
| $V_{OM+}$ Maximum positive peak output voltage swing                          | $I_O = -200\ \mu\text{A}$   | 25°C                       | 13.8        | 14.1        |     | 13.8        | 14.1        | V                            |          |    |
|   |   | Full range                 | 13.7        |             |     | 13.7        |             |                              |          |    |
|   | $I_O = -2\ \text{mA}$   | 25°C                       | 13.5        | 13.9        |     | 13.5        | 13.9        |                              |          |    |
|   |   | Full range                 | 13.4        |             |     | 13.4        |             |                              |          |    |
|   | $I_O = -20\ \text{mA}$  | 25°C                       | 11.5        | 12.3        |     | 11.5        | 12.3        |                              |          |    |
|   |   | Full range                 | 11.5        |             |     | 11.5        |             |                              |          |    |
| $V_{OM-}$ Maximum negative peak output voltage swing                          | $I_O = 200\ \mu\text{A}$  | 25°C                       | -13.8       | -14.2       |     | -13.8       | -14.2       | V                            |          |    |
|   |   | Full range                 | -13.7       |             |     | -13.7       |             |                              |          |    |
|   | $I_O = 2\ \text{mA}$  | 25°C                       | -13.5       | -14         |     | -13.5       | -14         |                              |          |    |
|   |   | Full range                 | -13.4       |             |     | -13.4       |             |                              |          |    |
|   | $I_O = 20\ \text{mA}$   | 25°C                       | -11.5       | -12.4       |     | -11.5       | -12.4       |                              |          |    |
|   |   | Full range                 | -11.5       |             |     | -11.5       |             |                              |          |    |
| $A_{VD}$ Large-signal differential voltage amplification                      | $V_O = \pm 10\ \text{V}$  | $R_L = 600\ \Omega$        | 25°C        | 80          | 96  |             | 80          | 96                           | dB       |    |
|   |   |                            | Full range  | 79          |     |             | 79          |                              |          |    |
|   |   | $R_L = 2\ \text{k}\Omega$  | 25°C        | 90          | 109 |             | 90          | 109                          |          |    |
|   |   |                            | Full range  | 89          |     |             | 89          |                              |          |    |
|   |   | $R_L = 10\ \text{k}\Omega$ | 25°C        | 95          | 118 |             | 95          | 118                          |          |    |
|   |   |                            | Full range  | 94          |     |             | 94          |                              |          |    |
| $r_i$ Input resistance  | $V_{IC} = 0$  | 25°C                       | $10^{12}$   |             |     | $10^{12}$   |             |                              | $\Omega$ |    |
| $c_i$ Input capacitance   | $V_{IC} = 0,$<br>See Figure 5   | Common mode                | 25°C        | 7.5         |     |             | 7.5         |                              |          | pF |
|   |   | Differential               | 25°C        | 2.5         |     |             | 2.5         |                              |          |    |
| $z_o$ Open-loop output impedance  | $f = 1\ \text{MHz}$   | 25°C                       | 80          |             |     | 80          |             |                              | $\Omega$ |    |
| CMRR Common-mode rejection ratio  | $V_{IC} = V_{ICRmin},$<br>$V_O = 0,$<br>$R_S = 50\ \Omega$                              | 25°C                       | 80          | 98          |     | 80          | 98          | dB                           |          |    |
|   |   | Full range                 | 79          |             |     | 79          |             |                              |          |    |
| $k_{SVR}$ Supply-voltage rejection ratio ( $\Delta V_{CC\pm}/\Delta V_{IO}$ ) | $V_{CC\pm} = \pm 5\ \text{V to } \pm 15\ \text{V},$<br>$V_O = 0,$<br>$R_S = 50\ \Omega$ | 25°C                       | 82          | 99          |     | 82          | 99          | dB                           |          |    |
|   |   | Full range                 | 80          |             |     | 80          |             |                              |          |    |

† Full range is  $-40^\circ\text{C}$  to  $85^\circ\text{C}$ .



**TLE207x, TLE207xA**  
**EXCALIBUR LOW-NOISE HIGH-SPEED**  
**JFET-INPUT OPERATIONAL AMPLIFIERS**

SLOS181C – FEBRUARY 1997 – REVISED DECEMBER 2009

**TLE2072I electrical characteristics at specified free-air temperature,  $V_{CC\pm} = \pm 15\text{ V}$  (unless otherwise noted)**  
**(continued)**

| PARAMETER | TEST CONDITIONS                | $T_A$                                   | TLE2072I   |                        |     | TLE2072AI |     |     | UNIT |    |
|-----------|--------------------------------|---|------------|------------------------|-----|-----------|-----|-----|------|----|
|           |                                |   | MIN        | TYP                    | MAX | MIN       | TYP | MAX |      |    |
| $I_{CC}$  | Supply current (both channels) | $V_O = 0$ , No load                     | 25°C       | 2.7                    | 3.1 | 3.9       | 2.7 | 3.1 | 3.9  | mA |
|           |                                |   | Full range | 3.9                    |     |           | 3.9 |     |      |    |
| $a_x$     | Crosstalk attenuation          | $V_{IC} = 0$ , $R_L = 2\text{ k}\Omega$ | 25°C       | 120                    |     |           | 120 |     |      | dB |
| $I_{OS}$  | Short-circuit output current   | $V_O = 0$                               | 25°C       | $V_{ID} = 1\text{ V}$  | -30 | -45       | -30 | -45 | mA   |    |
|           |                                |   |            | $V_{ID} = -1\text{ V}$ | 30  | 48        | 30  | 48  |      |    |

**TLE2072I operating characteristics at specified free-air temperature,  $V_{CC\pm} = \pm 15\text{ V}$**

| PARAMETER   | TEST CONDITIONS                             | $T_A$ †   | TLE2072I   |                     |     | TLE2072AI |     |                        | UNIT                   |
|-------------|---|---|------------|---------------------|-----|-----------|-----|------------------------|------------------------|
|             |   |   | MIN        | TYP                 | MAX | MIN       | TYP | MAX                    |                        |
| SR+         | Positive slew rate                          | $V_{O(PP)} = \pm 10\text{ V}$ ,<br>$A_{VD} = -1$ ,<br>$C_L = 100\text{ pF}$ ,<br>$R_L = 2\text{ k}\Omega$ ,<br>See Figure 1 | 25°C       | 28                  | 40  | 28        | 40  | V/ $\mu$ s             |                        |
|             |   |   | Full range | 22                  |     |           | 22  |                        |                        |
| SR-         | Negative slew rate                          | $V_{O(PP)} = \pm 10\text{ V}$ ,<br>$A_{VD} = -1$ ,<br>$C_L = 100\text{ pF}$ ,<br>$R_L = 2\text{ k}\Omega$ ,<br>See Figure 1 | 25°C       | 30                  | 45  | 30        | 45  | V/ $\mu$ s             |                        |
|             |   |   | Full range | 22                  |     |           | 22  |                        |                        |
| $t_s$       | Settling time                               | $A_{VD} = -1$ ,<br>10-V step,<br>$R_L = 1\text{ k}\Omega$ ,<br>$C_L = 100\text{ pF}$  | 25°C       | To 10 mV            | 0.4 |           | 0.4 |                        | $\mu$ s                |
|             |   |   |            | To 1 mV             | 1.5 |           | 1.5 |                        |                        |
| $V_n$       | Equivalent input noise voltage              | $R_S = 20\ \Omega$ ,<br>See Figure 3  | 25°C       | f = 10 Hz           | 48  | 85        | 48  | 85                     | nV/ $\sqrt{\text{Hz}}$ |
|             |   |   |            | f = 10 kHz          | 12  | 17        | 12  | 17                     |                        |
| $V_{N(PP)}$ | Peak-to-peak equivalent input noise voltage | $R_S = 20\ \Omega$ ,<br>See Figure 3  | 25°C       | f = 0 Hz to 10 kHz  | 6   |           | 6   |                        | $\mu$ V                |
|             |   |   |            | f = 0.1 Hz to 10 Hz | 0.6 |           | 0.6 |                        |                        |
| $I_n$       | Equivalent input noise current              | $V_{IC} = 0$ , f = 10 kHz   | 25°C       | 2.8                 |     | 2.8       |     | fA/ $\sqrt{\text{Hz}}$ |                        |
| THD + N     | Total harmonic distortion plus noise        | $V_{O(PP)} = 20\text{ V}$ ,<br>f = 1 kHz,<br>$R_S = 25\ \Omega$   | 25°C       | 0.008%              |     | 0.008%    |     |                        |                        |
| $B_1$       | Unity-gain bandwidth                        | $V_I = 10\text{ mV}$ ,<br>$C_L = 25\text{ pF}$ ,<br>$R_L = 2\text{ k}\Omega$ ,<br>See Figure 2                              | 25°C       | 8                   | 10  | 8         | 10  | MHz                    |                        |
| $B_{OM}$    | Maximum output-swing bandwidth              | $V_{O(PP)} = 20\text{ V}$ ,<br>$R_L = 2\text{ k}\Omega$ ,<br>$A_{VD} = -1$ ,<br>$C_L = 25\text{ pF}$                        | 25°C       | 478                 | 637 | 478       | 637 | kHz                    |                        |
| $\phi_m$    | Phase margin at unity gain                  | $V_I = 10\text{ mV}$ ,<br>$C_L = 25\text{ pF}$ ,<br>$R_L = 2\text{ k}\Omega$ ,<br>See Figure 2                              | 25°C       | 57°                 |     | 57°       |     |                        |                        |

† Full range is -40°C to 85°C.

# TLE207x, TLE207xA EXCALIBUR LOW-NOISE HIGH-SPEED JFET-INPUT OPERATIONAL AMPLIFIERS

SLOS181C – FEBRUARY 1997 – REVISED DECEMBER 2009

**TLE2072M electrical characteristics at specified free-air temperature,  $V_{CC\pm} = \pm 5\text{ V}$  (unless otherwise noted)**

| PARAMETER  | TEST CONDITIONS                                       | $T_A$ †                    | TLE2072M   |           |           | TLE2072AM |                              |     | UNIT |
|--|---|----------------------------|------------|-----------|-----------|-----------|------------------------------|-----|------|
|  |   |                            | MIN        | TYP       | MAX       | MIN       | TYP                          | MAX |      |
| $V_{IO}$ Input offset voltage                                  | $V_{IC} = 0, V_O = 0,$<br>$R_S = 50\ \Omega,$         | 25°C                       | 0.9        | 6         | 0.65      | 3.5       | mV                           |     |      |
|  |   | Full range                 | 10.5       |           |           | 8         |                              |     |      |
| $\alpha_{VIO}$ Temperature coefficient of input offset voltage |   | Full range                 | 2.3        | 25*       | 2.3       | 25*       | $\mu\text{V}/^\circ\text{C}$ |     |      |
| $I_{IO}$ Input offset current                                  | $V_{IC} = 0, V_O = 0,$<br>See Figure 4                | 25°C                       | 5          | 100       | 5         | 100       | pA                           |     |      |
|  |   | Full range                 | 20         |           |           | 20        |                              |     |      |
| $I_{IB}$ Input bias current                                    |   | 25°C                       | 15         | 175       | 15        | 175       | pA                           |     |      |
|  |   | Full range                 | 60         |           |           | 60        |                              |     |      |
| $V_{ICR}$ Common-mode input voltage range                      | $R_S = 50\ \Omega$                                    | 25°C                       | 5 to -1    | 5 to -1.9 | 5 to -1   | 5 to -1.9 | V                            |     |      |
|  |   | Full range                 | 5 to -0.8  |           | 5 to -0.8 |           |                              |     |      |
| $V_{OM+}$ Maximum positive peak output voltage swing           | $I_O = -200\ \mu\text{A}$                             | 25°C                       | 3.8        | 4.1       | 3.8       | 4.1       | V                            |     |      |
|  |   | Full range                 | 3.6        |           |           | 3.6       |                              |     |      |
|  | $I_O = -2\ \text{mA}$                                 | 25°C                       | 3.5        | 3.9       | 3.5       | 3.9       |                              |     |      |
|  |   | Full range                 | 3.3        |           |           | 3.3       |                              |     |      |
| $I_O = -20\ \text{mA}$   | 25°C  | 1.5                        | 2.3        | 1.5       | 2.3       |           |                              |     |      |
|  | Full range  | 1.4                        |            |           | 1.4       |           |                              |     |      |
| $V_{OM-}$ Maximum negative peak output voltage swing           | $I_O = 200\ \mu\text{A}$                              | 25°C                       | -3.8       | -4.2      | -3.8      | -4.2      | V                            |     |      |
|  |   | Full range                 | -3.6       |           |           | -3.6      |                              |     |      |
|  | $I_O = 2\ \text{mA}$                                  | 25°C                       | -3.5       | -4.1      | -3.5      | -4.1      |                              |     |      |
|  |   | Full range                 | -3.3       |           |           | -3.3      |                              |     |      |
| $I_O = 20\ \text{mA}$  | 25°C  | -1.5                       | -2.4       | -1.5      | -2.4      |           |                              |     |      |
|  | Full range  | -1.4                       |            |           | -1.4      |           |                              |     |      |
| $A_{VD}$ Large-signal differential voltage amplification       | $V_O = \pm 2.3\ \text{V}$                             | $R_L = 600\ \Omega$        | 25°C       | 80        | 91        | 80        | 91                           | dB  |      |
|  |   |                            | Full range | 78        |           |           | 78                           |     |      |
|  |   | $R_L = 2\ \text{k}\Omega$  | 25°C       | 90        | 100       | 90        | 100                          |     |      |
|  |   |                            | Full range | 88        |           |           | 88                           |     |      |
|  |   | $R_L = 10\ \text{k}\Omega$ | 25°C       | 95        | 106       | 95        | 106                          |     |      |
|  |   |                            | Full range | 93        |           |           | 93                           |     |      |
| $r_i$ Input resistance   | $V_{IC} = 0$  | 25°C                       | $10^{12}$  |           |           | $10^{12}$ | $\Omega$                     |     |      |
| $c_i$ Input capacitance  | $V_{IC} = 0,$<br>See Figure 5                         | Common mode                | 25°C       | 11        |           |           | 11                           | pF  |      |
|  |   | Differential               | 25°C       | 2.5       |           |           | 2.5                          |     |      |
| $z_o$ Open-loop output impedance                               | $f = 1\ \text{MHz}$                                   | 25°C                       | 80         |           |           | 80        | $\Omega$                     |     |      |
| CMRR Common-mode rejection ratio                               | $V_{IC} = V_{ICRmin},$<br>$V_O = 0, R_S = 50\ \Omega$ | 25°C                       | 70         | 89        | 70        | 89        | dB                           |     |      |
|  |   | Full range                 | 68         |           |           | 68        |                              |     |      |

\*On products compliant to MIL-PRF-38535, Class B, this parameter is not production tested.

† Full range is  $-55^\circ\text{C}$  to  $125^\circ\text{C}$ .



**TLE207x, TLE207xA**  
**EXCALIBUR LOW-NOISE HIGH-SPEED**  
**JFET-INPUT OPERATIONAL AMPLIFIERS**

SLOS181C – FEBRUARY 1997 – REVISED DECEMBER 2009

**TLE2072M electrical characteristics at specified free-air temperature,  $V_{CC\pm} = \pm 5\text{ V}$  (unless otherwise noted) (continued)**

| PARAMETER | TEST CONDITIONS   | $T_A^\dagger$  | TLE2072M               |     |     | TLE2072AM   |     |     | UNIT |
|-----------|---|--|------------------------|-----|-----|-------------|-----|-----|------|
|           |   |  | MIN                    | TYP | MAX | MIN         | TYP | MAX |      |
| $k_{SVR}$ | Supply-voltage rejection ratio ( $\Delta V_{CC\pm} / \Delta V_{IO}$ ) | $V_{CC\pm} = \pm 5\text{ V}$ to $\pm 15\text{ V}$ ,<br>$V_O = 0$ ,<br>$R_S = 50\ \Omega$ | Full range             |     |     | 80          |     |     | dB   |
| $I_{CC}$  | Supply current (both channels)  | $V_O = 0$ ,<br>No load   | 25°C                   |     |     | 2.7 2.9 3.6 |     |     | mA   |
|           |   |  | Full range             |     |     | 3.6         |     |     |      |
| $a_x$     | Crosstalk attenuation   | $V_{IC} = 0$ ,<br>$R_L = 2\text{ k}\Omega$   | 25°C                   |     |     | 120         |     |     | dB   |
| $I_{OS}$  | Short-circuit output current  | $V_O = 0$  | $V_{ID} = 1\text{ V}$  |     |     | -35         |     |     | mA   |
|           |   |  | $V_{ID} = -1\text{ V}$ |     |     | 45          |     |     |      |

$^\dagger$  Full range is  $-55^\circ\text{C}$  to  $125^\circ\text{C}$ .

**TLE2072M operating characteristics at specified free-air temperature,  $V_{CC\pm} = \pm 5\text{ V}$**

| PARAMETER   | TEST CONDITIONS                             | $T_A^\dagger$  | TLE2072M            |     |     | TLE2072AM |     |     | UNIT                         |
|-------------|---|--|---------------------|-----|-----|-----------|-----|-----|------------------------------|
|             |   |  | MIN                 | TYP | MAX | MIN       | TYP | MAX |                              |
| $SR_+$      | Positive slew rate                          | $V_{O(PP)} = \pm 2.3\text{ V}$ ,<br>$A_{VD} = -1$ ,<br>$C_L = 100\text{ pF}$ ,<br>$R_L = 2\text{ k}\Omega$ ,<br>See Figure 1 | 25°C                |     |     | 35        |     |     | $\text{V}/\mu\text{s}$       |
|             |   |  | Full range          |     |     | 18*       |     |     |                              |
| $SR_-$      | Negative slew rate                          | $V_{O(PP)} = \pm 2.3\text{ V}$ ,<br>$A_{VD} = -1$ ,<br>$C_L = 100\text{ pF}$ ,<br>$R_L = 2\text{ k}\Omega$ ,<br>See Figure 1 | 25°C                |     |     | 38        |     |     | $\text{V}/\mu\text{s}$       |
|             |   |  | Full range          |     |     | 18*       |     |     |                              |
| $t_s$       | Settling time                               | $A_{VD} = -1$ ,<br>2-V step,<br>$R_L = 1\text{ k}\Omega$ ,<br>$C_L = 100\text{ pF}$  | To 10 mV            |     |     | 0.25      |     |     | $\mu\text{s}$                |
|             |   |  | To 1 mV             |     |     | 0.4       |     |     |                              |
| $V_n$       | Equivalent input noise voltage              | $R_S = 20\ \Omega$ ,<br>See Figure 3   | f = 10 Hz           |     |     | 48 85*    |     |     | $\text{nV}/\sqrt{\text{Hz}}$ |
|             |   |  | f = 10 kHz          |     |     | 12 17*    |     |     |                              |
| $V_{N(PP)}$ | Peak-to-peak equivalent input noise voltage | $R_S = 20\ \Omega$ ,<br>See Figure 3   | f = 10 Hz to 10 kHz |     |     | 6         |     |     | $\mu\text{V}$                |
|             |   |  | f = 0.1 Hz to 10 Hz |     |     | 0.6       |     |     |                              |
| $I_n$       | Equivalent input noise current              | $V_{IC} = 0$ ,<br>f = 10 kHz   | 25°C                |     |     | 2.8       |     |     | $\text{fA}/\sqrt{\text{Hz}}$ |
| THD + N     | Total harmonic distortion plus noise        | $V_{O(PP)} = 5\text{ V}$ ,<br>f = 1 kHz,<br>$R_S = 25\ \Omega$   | 25°C                |     |     | 0.013%    |     |     |                              |
| $B_1$       | Unity-gain bandwidth                        | $V_I = 10\text{ mV}$ ,<br>$C_L = 25\text{ pF}$ ,<br>$R_L = 2\text{ k}\Omega$ ,<br>See Figure 2                               | 25°C                |     |     | 9.4       |     |     | MHz                          |
| $B_{OM}$    | Maximum output-swing bandwidth              | $V_{O(PP)} = 4\text{ V}$ ,<br>$R_L = 2\text{ k}\Omega$ ,<br>$A_{VD} = -1$ ,<br>$C_L = 25\text{ pF}$                          | 25°C                |     |     | 2.8       |     |     | MHz                          |
| $\phi_m$    | Phase margin at unity gain                  | $V_I = 10\text{ mV}$ ,<br>$C_L = 25\text{ pF}$ ,<br>$R_L = 2\text{ k}\Omega$ ,<br>See Figure 2                               | 25°C                |     |     | 56°       |     |     |                              |

\*On products compliant to MIL-PRF-38535, Class B, this parameter is not production tested.

$^\dagger$  Full range is  $-55^\circ\text{C}$  to  $125^\circ\text{C}$ .



# TLE207x, TLE207xA EXCALIBUR LOW-NOISE HIGH-SPEED JFET-INPUT OPERATIONAL AMPLIFIERS

SLOS181C – FEBRUARY 1997 – REVISED DECEMBER 2009

**TLE2072M electrical characteristics at specified free-air temperature,  $V_{CC\pm} = \pm 15$  V (unless otherwise noted)**

| PARAMETER   | TEST CONDITIONS  | $T_A$ †                    | TLE2072M    |             |       | TLE2072AM   |             |                  | UNIT     |    |
|---|--|----------------------------|-------------|-------------|-------|-------------|-------------|------------------|----------|----|
|   |  |                            | MIN         | TYP         | MAX   | MIN         | TYP         | MAX              |          |    |
| $V_{IO}$ Input offset voltage   | $V_{IC} = 0, V_O = 0, R_S = 50 \Omega$                                       | 25°C                       | 1.1         | 6           |       | 0.7         | 3.5         | mV               |          |    |
|   |  | Full range                 |             |             | 10.5  |             | 8           |                  |          |    |
| $\alpha_{VIO}$ Temperature coefficient of input offset voltage                |  | Full range                 | 2.4         | 25*         |       | 2.4         | 25*         | $\mu V/^\circ C$ |          |    |
| $I_{IO}$ Input offset current   | $V_{IC} = 0, V_O = 0, \text{See Figure 4}$                                   | 25°C                       | 6           | 100         |       | 6           | 100         | pA               |          |    |
|   |  | Full range                 |             |             | 20    |             | 20          | nA               |          |    |
| $I_{IB}$ Input bias current   |  | 25°C                       | 20          | 175         |       | 20          | 175         | pA               |          |    |
|   |  | Full range                 |             |             | 60    |             | 60          | nA               |          |    |
| $V_{ICR}$ Common-mode input voltage range                                     | $R_S = 50 \Omega$  | 25°C                       | 15 to -11   | 15 to -11.9 |       | 15 to -11   | 15 to -11.9 | V                |          |    |
|   |  | Full range                 | 15 to -10.8 |             |       | 15 to -10.8 |             |                  |          |    |
| $V_{OM+}$ Maximum positive peak output voltage swing                          | $I_O = -200 \mu A$   | 25°C                       | 13.8        | 14.1        |       | 13.8        | 14.1        | V                |          |    |
|   |  | Full range                 | 13.6        |             |       | 13.6        |             |                  |          |    |
|   | $I_O = -2 \text{ mA}$  | 25°C                       | 13.5        | 13.9        |       | 13.5        | 13.9        |                  |          |    |
|   |  | Full range                 | 13.3        |             |       | 13.3        |             |                  |          |    |
| $I_O = -20 \text{ mA}$  | 25°C   | 11.5                       | 12.3        |             | 11.5  | 12.3        |             |                  |          |    |
|   | Full range   | 11.4                       |             |             | 11.4  |             |             |                  |          |    |
| $V_{OM-}$ Maximum negative peak output voltage swing                          | $I_O = 200 \mu A$  | 25°C                       | -13.8       | -14.2       |       | -13.8       | -14.2       | V                |          |    |
|   |  | Full range                 | -13.6       |             |       | -13.6       |             |                  |          |    |
|   | $I_O = 2 \text{ mA}$   | 25°C                       | -13.5       | -14         |       | -13.5       | -14         |                  |          |    |
|   |  | Full range                 | -13.3       |             |       | -13.3       |             |                  |          |    |
| $I_O = 20 \text{ mA}$   | 25°C   | -11.5                      | -12.4       |             | -11.5 | -12.4       |             |                  |          |    |
|   | Full range   | -11.4                      |             |             | -11.4 |             |             |                  |          |    |
| $A_{VD}$ Large-signal differential voltage amplification                      | $V_O = \pm 10 \text{ V}$   | $R_L = 600 \Omega$         | 25°C        | 80          | 96    |             | 80          | 96               | dB       |    |
|   |  |                            | Full range  | 78          |       |             | 78          |                  |          |    |
|   |  | $R_L = 2 \text{ k}\Omega$  | 25°C        | 90          | 109   |             | 90          | 109              |          |    |
|   |  |                            | Full range  | 89          |       |             | 89          |                  |          |    |
|   |  | $R_L = 10 \text{ k}\Omega$ | 25°C        | 95          | 118   |             | 95          | 118              |          |    |
|   |  |                            | Full range  | 93          |       |             | 93          |                  |          |    |
| $r_i$ Input resistance  | $V_{IC} = 0$   | 25°C                       | $10^{12}$   |             |       | $10^{12}$   |             |                  | $\Omega$ |    |
| $c_i$ Input capacitance   | $V_{IC} = 0, \text{See Figure 5}$  | Common mode                | 25°C        | 7.5         |       |             | 7.5         |                  |          | pF |
|   |  | Differential               | 25°C        | 2.5         |       |             | 2.5         |                  |          |    |
| $z_o$ Open-loop output impedance  | $f = 1 \text{ MHz}$  | 25°C                       | 80          |             |       | 80          |             |                  | $\Omega$ |    |
| CMRR Common-mode rejection ratio  | $V_{IC} = V_{ICRmin}, V_O = 0, R_S = 50 \Omega$                              | 25°C                       | 80          | 98          |       | 80          | 98          | dB               |          |    |
|   |  | Full range                 | 78          |             |       | 78          |             |                  |          |    |
| $k_{SVR}$ Supply-voltage rejection ratio ( $\Delta V_{CC\pm}/\Delta V_{IO}$ ) | $V_{CC\pm} = \pm 5 \text{ V to } \pm 15 \text{ V}, V_O = 0, R_S = 50 \Omega$ | 25°C                       | 82          | 99          |       | 82          | 99          | dB               |          |    |
|   |  | Full range                 | 80          |             |       | 80          |             |                  |          |    |

\*On products compliant to MIL-PRF-38535, Class B, this parameter is not production tested.

† Full range is  $-55^\circ C$  to  $125^\circ C$ .



**TLE207x, TLE207xA**  
**EXCALIBUR LOW-NOISE HIGH-SPEED**  
**JFET-INPUT OPERATIONAL AMPLIFIERS**

SLOS181C – FEBRUARY 1997 – REVISED DECEMBER 2009

**TLE2072M electrical characteristics at specified free-air temperature,  $V_{CC\pm} = \pm 15$  V (unless otherwise noted)**

| PARAMETER | TEST CONDITIONS                | $T_A$ †                             | TLE2072M   |                 |     | TLE2072AM |     |     | UNIT |    |
|-----------|--------------------------------|-------------------------------------|------------|-----------------|-----|-----------|-----|-----|------|----|
|           |                                |                                     | MIN        | TYP             | MAX | MIN       | TYP | MAX |      |    |
| $I_{CC}$  | Supply current (both channels) | $V_O = 0$ , No load                 | 25°C       | 2.7             | 3.1 | 3.6       | 2.7 | 3.1 | 3.6  | mA |
|           |                                |                                     | Full range | 3.6             |     |           | 3.6 |     |      |    |
| $a_x$     | Crosstalk attenuation          | $V_{IC} = 0$ , $R_L = 2$ k $\Omega$ | 25°C       | 120             |     |           | 120 |     |      | dB |
| $I_{OS}$  | Short-circuit output current   | $V_O = 0$                           | 25°C       | $V_{ID} = 1$ V  | -30 | -45       | -30 | -45 | mA   |    |
|           |                                |                                     |            | $V_{ID} = -1$ V | 30  | 48        | 30  | 48  |      |    |

† Full range is  $-55^\circ\text{C}$  to  $125^\circ\text{C}$ .

**TLE2072M operating characteristics at specified free-air temperature,  $V_{CC\pm} = \pm 15$  V**

| PARAMETER   | TEST CONDITIONS                             | $T_A$ †   | TLE2072M   |                     |     | TLE2072AM |        |     | UNIT                   |                        |
|-------------|---|---|------------|---------------------|-----|-----------|--------|-----|------------------------|------------------------|
|             |   |   | MIN        | TYP                 | MAX | MIN       | TYP    | MAX |                        |                        |
| SR+         | Positive slew rate                          | $V_{O(PP)} = 10$ V, $R_L = 2$ k $\Omega$ , $C_L = 100$ pF, See Figure 1 | 25°C       | 28                  | 40  |           | 28     | 40  | V/ $\mu$ s             |                        |
|             |   |   | Full range | 20                  |     |           | 20     |     |                        |                        |
| SR-         | Negative slew rate                          | $V_{O(PP)} = 10$ V, $R_L = 2$ k $\Omega$ , $C_L = 100$ pF, See Figure 1 | 25°C       | 30                  | 45  |           | 30     | 45  | V/ $\mu$ s             |                        |
|             |   |   | Full range | 20                  |     |           | 20     |     |                        |                        |
| $t_s$       | Settling time                               | $A_{VD} = -1$ , 10-V step, $R_L = 1$ k $\Omega$ , $C_L = 100$ pF        | 25°C       | To 10 mV            | 0.4 |           | 0.4    |     | $\mu$ s                |                        |
|             |   |   |            | To 1 mV             | 1.5 |           | 1.5    |     |                        |                        |
| $V_n$       | Equivalent input noise voltage              | $R_S = 20$ $\Omega$ , See Figure 3                                      | 25°C       | f = 10 Hz           | 48  | 85*       | 48     | 85* | nV/ $\sqrt{\text{Hz}}$ |                        |
|             |   |   |            | f = 10 kHz          | 12  | 17*       | 12     | 17* |                        |                        |
| $V_{N(PP)}$ | Peak-to-peak equivalent input noise voltage | $R_S = 20$ $\Omega$ , See Figure 3                                      | 25°C       | f = 10 Hz to 10 kHz | 6   |           | 6      |     | $\mu$ V                |                        |
|             |   |   |            | f = 0.1 Hz to 10 Hz | 0.6 |           | 0.6    |     |                        |                        |
| $I_n$       | Equivalent input noise current              | $V_{IC} = 0$ , f = 10 kHz   | 25°C       | 2.8                 |     |           | 2.8    |     |                        | fA/ $\sqrt{\text{Hz}}$ |
| THD + N     | Total harmonic distortion plus noise        | $V_{O(PP)} = 20$ V, f = 1 kHz, $R_S = 25$ $\Omega$                      | 25°C       | 0.008%              |     |           | 0.008% |     |                        |                        |
| $B_1$       | Unity-gain bandwidth                        | $V_I = 10$ mV, $R_L = 2$ k $\Omega$ , $C_L = 25$ pF, See Figure 2       | 25°C       | 8*                  | 10  |           | 8*     | 10  | MHz                    |                        |
| $B_{OM}$    | Maximum output-swing bandwidth              | $V_{O(PP)} = 20$ V, $R_L = 2$ k $\Omega$ , $C_L = 25$ pF                | 25°C       | 478*                | 637 |           | 478*   | 637 | kHz                    |                        |
| $\phi_m$    | Phase margin at unity gain                  | $V_I = 10$ mV, $R_L = 2$ k $\Omega$ , $C_L = 25$ pF, See Figure 2       | 25°C       | 57°                 |     |           | 57°    |     |                        |                        |

\*On products compliant to MIL-PRF-38535, Class B, this parameter is not production tested.

† Full range is  $-55^\circ\text{C}$  to  $125^\circ\text{C}$ .



**TLE207x, TLE207xA**  
**EXCALIBUR LOW-NOISE HIGH-SPEED**  
**JFET-INPUT OPERATIONAL AMPLIFIERS**

SLOS181C – FEBRUARY 1997 – REVISED DECEMBER 2009

**TLE2072Y electrical characteristics at  $V_{CC\pm} = \pm 15\text{ V}$ ,  $T_A = 25^\circ\text{C}$**

| PARAMETER |   | TEST CONDITIONS  |                            | TLE2072Y                |                  |     | UNIT     |
|-----------|---|--|----------------------------|-------------------------|------------------|-----|----------|
|           |   |  |                            | MIN                     | TYP              | MAX |          |
| $V_{IO}$  | Input offset voltage  | $V_{IC} = 0$ , $V_O = 0$ , $R_S = 50\ \Omega$  |                            | 1.1                     | 6                |     | mV       |
| $I_{IO}$  | Input offset current  | $V_{IC} = 0$ , $V_O = 0$ , See Figure 4  |                            | 6                       | 100              |     | pA       |
| $I_{IB}$  | Input bias current  |  |                            | 20                      | 175              |     | pA       |
| $V_{ICR}$ | Common-mode input voltage range                                     | $R_S = 50\ \Omega$   |                            | 15<br>to<br>-11         | 15<br>to<br>11.9 |     | V        |
| $V_{OM+}$ | Maximum positive peak output voltage swing                          | $I_O = -200\ \mu\text{A}$  |                            | 13.8                    | 14.1             |     | V        |
|           |   | $I_O = -2\ \text{mA}$  |                            | 13.5                    | 13.9             |     |          |
|           |   | $I_O = -20\ \text{mA}$   |                            | 11.5                    | 12.3             |     |          |
| $V_{OM-}$ | Maximum negative peak output voltage swing                          | $I_O = 200\ \mu\text{A}$   |                            | -13.8                   | -14.2            |     | V        |
|           |   | $I_O = 2\ \text{mA}$   |                            | -13.5                   | -14              |     |          |
|           |   | $I_O = 20\ \text{mA}$  |                            | -11.5                   | -12.4            |     |          |
| $A_{VD}$  | Large-signal differential voltage amplification                     | $V_O = \pm 10\ \text{V}$   | $R_L = 600\ \Omega$        | 80                      | 96               |     | dB       |
|           |   |  | $R_L = 2\ \text{k}\Omega$  | 90                      | 109              |     |          |
|           |   |  | $R_L = 10\ \text{k}\Omega$ | 95                      | 118              |     |          |
| $r_i$     | Input resistance  | $V_{IC} = 0$   |                            | 10 <sup>12</sup>        |                  |     | $\Omega$ |
| $c_i$     | Input capacitance   | $V_{IC} = 0$ ,<br>See Figure 5   | Common mode                | 7.5                     |                  |     | pF       |
|           |   |  | Differential               | 2.5                     |                  |     |          |
| $Z_o$     | Open-loop output impedance  | $f = 1\ \text{MHz}$  |                            | 80                      |                  |     | $\Omega$ |
| CMRR      | Common-mode rejection ratio   | $V_{IC} = V_{ICRmin}$ , $V_O = 0$ , $R_S = 50\ \Omega$                                   |                            | 80                      | 98               |     | dB       |
| $k_{SVR}$ | Supply-voltage rejection ratio ( $\Delta V_{CC\pm}/\Delta V_{IO}$ ) | $V_{CC\pm} = \pm 5\ \text{V to } \pm 15\ \text{V}$ ,<br>$R_S = 50\ \Omega$ , $V_O = 0$ , |                            | 82                      | 99               |     | dB       |
| $I_{CC}$  | Supply current (both channels)                                      | $V_O = 0$ , No load  |                            | 2.7                     | 3.1              | 3.9 | mA       |
| $I_{OS}$  | Short-circuit output current  | $V_O = 0$  |                            | $V_{ID} = 1\ \text{V}$  | -30              | -45 | mA       |
|           |   |  |                            | $V_{ID} = -1\ \text{V}$ | 30               | 48  |          |





**TLE207x, TLE207xA**  
**EXCALIBUR LOW-NOISE HIGH-SPEED**  
**JFET-INPUT OPERATIONAL AMPLIFIERS**

SLOS181C – FEBRUARY 1997 – REVISED DECEMBER 2009

**TLE2074C electrical characteristics at specified free-air temperature,  $V_{CC\pm} = \pm 5\text{ V}$  (unless otherwise noted)**

| PARAMETER   | TEST CONDITIONS   | $T_A$ †                           | TLE2074C   |           |      | TLE2074AC |           |                              | UNIT     |    |
|---|---|-----------------------------------|------------|-----------|------|-----------|-----------|------------------------------|----------|----|
|   |   |                                   | MIN        | TYP       | MAX  | MIN       | TYP       | MAX                          |          |    |
| $V_{IO}$ Input offset voltage   | $V_{IC} = 0, V_O = 0, R_S = 50\ \Omega$                                       | 25°C                              | -1.6       | 5         |      | -0.5      | 3         | mV                           |          |    |
|   |   | Full range                        |            |           | 7.1  |           | 5.1       |                              |          |    |
| $\alpha_{VIO}$ Temperature coefficient of input offset voltage                  |   | Full range                        | 10.1       | 30        |      | 10.1      | 30        | $\mu\text{V}/^\circ\text{C}$ |          |    |
| $I_{IO}$ Input offset current   | $V_{IC} = 0, V_O = 0, \text{See Figure 4}$                                    | 25°C                              | 15         | 100       |      | 15        | 100       | pA                           |          |    |
|   |   | Full range                        |            |           | 1400 |           | 1400      |                              |          |    |
| $I_{IB}$ Input bias current   |   | 25°C                              | 20         | 175       |      | 20        | 175       | pA                           |          |    |
|   |   | Full range                        |            |           | 5000 |           | 5000      |                              |          |    |
| $V_{ICR}$ Common-mode input voltage range                                       | $R_S = 50\ \Omega$  | 25°C                              | 5 to -1    | 5 to -1.9 |      | 5 to -1   | 5 to -1.9 | V                            |          |    |
|   |   | Full range                        | 5 to -0.9  |           |      | 5 to -0.9 |           |                              |          |    |
| $V_{OM+}$ Maximum positive peak output voltage swing                            | $I_O = -200\ \mu\text{A}$   | 25°C                              | 3.8        | 4.1       |      | 3.8       | 4.1       | V                            |          |    |
|   |   | Full range                        | 3.7        |           |      | 3.7       |           |                              |          |    |
|   | $I_O = -2\ \text{mA}$   | 25°C                              | 3.5        | 3.9       |      | 3.5       | 3.9       |                              |          |    |
|   |   | Full range                        | 3.4        |           |      | 3.4       |           |                              |          |    |
|   | $I_O = -20\ \text{mA}$  | 25°C                              | 1.5        | 2.3       |      | 1.5       | 2.3       |                              |          |    |
|   |   | Full range                        | 1.5        |           |      | 1.5       |           |                              |          |    |
| $V_{OM-}$ Maximum negative peak output voltage swing                            | $I_O = 200\ \mu\text{A}$  | 25°C                              | -3.8       | -4.2      |      | -3.8      | -4.2      | V                            |          |    |
|   |   | Full range                        | -3.7       |           |      | -3.7      |           |                              |          |    |
|   | $I_O = 2\ \text{mA}$  | 25°C                              | -3.5       | -4.1      |      | -3.5      | -4.1      |                              |          |    |
|   |   | Full range                        | -3.4       |           |      | -3.4      |           |                              |          |    |
|   | $I_O = 20\ \text{mA}$   | 25°C                              | -1.5       | -2.4      |      | -1.5      | -2.4      |                              |          |    |
|   |   | Full range                        | -1.5       |           |      | -1.5      |           |                              |          |    |
| $A_{VD}$ Large-signal differential voltage amplification                        | $V_O = \pm 2.3\ \text{V}$   | $R_L = 600\ \Omega$               | 25°C       | 80        | 91   |           | 80        | 91                           | dB       |    |
|   |   |                                   | Full range | 79        |      |           | 79        |                              |          |    |
|   |   | $R_L = 2\ \text{k}\Omega$         | 25°C       | 90        | 100  |           | 90        | 100                          |          |    |
|   |   |                                   | Full range | 89        |      |           | 89        |                              |          |    |
|   |   | $R_L = 10\ \text{k}\Omega$        | 25°C       | 95        | 106  |           | 95        | 106                          |          |    |
|   |   |                                   | Full range | 94        |      |           | 94        |                              |          |    |
| $r_i$ Input resistance  | $V_{IC} = 0$  | 25°C                              | $10^{12}$  |           |      | $10^{12}$ |           |                              | $\Omega$ |    |
| $c_i$ Input capacitance   | Common mode   | $V_{IC} = 0, \text{See Figure 5}$ | 25°C       | 11        |      |           | 11        |                              |          | pF |
|   | Differential  |                                   | 25°C       | 2.5       |      |           | 2.5       |                              |          |    |
| $z_o$ Open-loop output impedance  | $f = 1\ \text{MHz}$   | 25°C                              | 80         |           |      | 80        |           |                              | $\Omega$ |    |
| CMRR Common-mode rejection ratio  | $V_{IC} = V_{ICRmin}, V_O = 0, R_S = 50\ \Omega$                              | 25°C                              | 70         | 89        |      | 70        | 89        | dB                           |          |    |
|   |   | Full range                        | 68         |           |      | 68        |           |                              |          |    |
| $k_{SVR}$ Supply-voltage rejection ratio ( $\Delta V_{CC\pm} / \Delta V_{IO}$ ) | $V_{CC\pm} = \pm 5\ \text{V to } \pm 15\ \text{V}, V_O = 0, R_S = 50\ \Omega$ | 25°C                              | 82         | 99        |      | 82        | 99        | dB                           |          |    |
|   |   | Full range                        | 80         |           |      | 80        |           |                              |          |    |

† Full range is 0°C to 70°C.

**TLE207x, TLE207xA**  
**EXCALIBUR LOW-NOISE HIGH-SPEED**  
**JFET-INPUT OPERATIONAL AMPLIFIERS**

SLOS181C – FEBRUARY 1997 – REVISED DECEMBER 2009

**TLE2074C electrical characteristics at specified free-air temperature,  $V_{CC\pm} = \pm 5\text{ V}$  (unless otherwise noted) (continued)**

| PARAMETER | TEST CONDITIONS   | $T_A$ †                                 | TLE2074C |     |     | TLE2074AC |     |     | UNIT |
|-----------|---|---|----------|-----|-----|-----------|-----|-----|------|
|           |   |   | MIN      | TYP | MAX | MIN       | TYP | MAX |      |
| $I_{CC}$  | Supply current (four amplifiers)<br>$V_O = 0$ , No load | 25°C                                    | 5.2      | 6.3 | 7.5 | 5.2       | 6.3 | 7.5 | mA   |
|           |   | Full range                              | 7.5      |     |     | 7.5       |     |     |      |
|           | Crosstalk attenuation                                   | $V_{IC} = 0$ , $R_L = 2\text{ k}\Omega$ | 120      |     |     | 120       |     |     | dB   |
| $I_{OS}$  | Short-circuit output current<br>$V_O = 0$               | $V_{ID} = 1\text{ V}$                   | -35      |     |     | -35       |     |     | mA   |
|           |   | $V_{ID} = -1\text{ V}$                  | 45       |     |     | 45        |     |     |      |

† Full range is 0°C to 70°C.

**TLE2074C operating characteristics at specified free-air temperature,  $V_{CC\pm} = \pm 5\text{ V}$**

| PARAMETER   | TEST CONDITIONS                             | $T_A$ †    | TLE2074C |   |        | TLE2074AC |        |     | UNIT                   |
|-------------|---|------------|----------|---|--------|-----------|--------|-----|------------------------|
|             |   |            | MIN      | TYP   | MAX    | MIN       | TYP    | MAX |                        |
| SR+         | Positive slew rate                          | 25°C       | 35       |   |        | 35        |        |     | V/ $\mu$ s             |
|             |   | Full range | 22       |   |        | 22        |        |     |                        |
| SR-         | Negative slew rate                          | 25°C       | 38       |   |        | 38        |        |     | V/ $\mu$ s             |
|             |   | Full range | 22       |   |        | 22        |        |     |                        |
| $t_s$       | Settling time                               | 25°C       |          | To 10 mV  | 0.25   |           | 0.25   |     | $\mu$ s                |
|             |   |            |          | To 1 mV   | 0.4    |           | 0.4    |     |                        |
| $V_n$       | Equivalent input noise voltage              | 25°C       |          | f = 10 Hz   | 48     | 85        | 48     | 85  | nV/ $\sqrt{\text{Hz}}$ |
|             |   |            |          | f = 10 kHz  | 12     | 17        | 12     | 17  |                        |
| $V_{N(PP)}$ | Peak-to-peak equivalent input noise voltage | 25°C       |          | f = 10 Hz to 10 kHz   | 6      |           | 6      |     | $\mu$ V                |
|             |   |            |          | f = 0.1 Hz to 10 Hz   | 0.6    |           | 0.6    |     |                        |
| $I_n$       | Equivalent input noise current              | 25°C       |          | f = 10 kHz  | 2.8    |           | 2.8    |     | fA/ $\sqrt{\text{Hz}}$ |
| THD + N     | Total harmonic distortion plus noise        | 25°C       |          | $V_{O(PP)} = 5\text{ V}$ ,<br>f = 1 kHz,<br>$R_S = 25\ \Omega$                                      | 0.013% |           | 0.013% |     |                        |
| $B_1$       | Unity-gain bandwidth                        | 25°C       |          | $V_I = 10\text{ mV}$ ,<br>$C_L = 25\text{ pF}$ ,<br>$R_L = 2\text{ k}\Omega$ ,<br>See Figure 2      | 9.4    |           | 9.4    |     | MHz                    |
| $B_{OM}$    | Maximum output-swing bandwidth              | 25°C       |          | $V_{O(PP)} = 4\text{ V}$ ,<br>$R_L = 2\text{ k}\Omega$ ,<br>$C_L = 25\text{ pF}$ ,<br>$A_{VD} = -1$ | 2.8    |           | 2.8    |     | MHz                    |
| $\phi_m$    | Phase margin at unity gain                  | 25°C       |          | $V_I = 10\text{ mV}$ ,<br>$C_L = 25\text{ pF}$ ,<br>$R_L = 2\text{ k}\Omega$ ,<br>See Figure 2      | 56°    |           | 56°    |     |                        |

† Full range is 0°C to 70°C.



**TLE207x, TLE207xA**  
**EXCALIBUR LOW-NOISE HIGH-SPEED**  
**JFET-INPUT OPERATIONAL AMPLIFIERS**

SLOS181C – FEBRUARY 1997 – REVISED DECEMBER 2009

**TLE2074C electrical characteristics at specified free-air temperature,  $V_{CC\pm} = \pm 15\text{ V}$  (unless otherwise noted)**

| PARAMETER   | TEST CONDITIONS  | $T_A$ †                       | TLE2074C    |             |      | TLE2074AC   |             |                              | UNIT |
|---|--|-------------------------------|-------------|-------------|------|-------------|-------------|------------------------------|------|
|   |  |                               | MIN         | TYP         | MAX  | MIN         | TYP         | MAX                          |      |
| $V_{IO}$ Input offset voltage   | $V_{IC} = 0,$<br>$R_S = 50\ \Omega$<br>$V_O = 0,$  | 25°C                          | -1.6        | 5           |      | -0.5        | 3           | mV                           |      |
|   |  | Full range                    |             |             | 7.1  |             | 5.1         |                              |      |
| $\alpha_{VIO}$ Temperature coefficient of input offset voltage                |  | Full range                    | 10.1        | 30          |      | 10.1        | 30          | $\mu\text{V}/^\circ\text{C}$ |      |
| $I_{IO}$ Input offset current   | $V_{IC} = 0,$<br>$V_O = 0,$<br>See Figure 4  | 25°C                          | 15          | 100         |      | 15          | 100         | pA                           |      |
|   |  | Full range                    |             |             | 1400 |             | 1400        |                              |      |
| $I_{IB}$ Input bias current   |  | 25°C                          | 25          | 175         |      | 25          | 175         | pA                           |      |
|   |  | Full range                    |             |             | 5000 |             | 5000        |                              |      |
| $V_{ICR}$ Common-mode input voltage range                                     | $R_S = 50\ \Omega$   | 25°C                          | 15 to -11   | 15 to -11.9 |      | 15 to -11   | 15 to -11.9 | V                            |      |
|   |  | Full range                    | 15 to -10.9 |             |      | 15 to -10.9 |             |                              |      |
| $V_{OM+}$ Maximum positive peak output voltage swing                          | $I_O = -200\ \mu\text{A}$  | 25°C                          | 13.8        | 14.1        |      | 13.8        | 14.1        | V                            |      |
|   |  | Full range                    | 13.7        |             |      | 13.7        |             |                              |      |
|   | $I_O = -2\ \text{mA}$  | 25°C                          | 13.5        | 13.9        |      | 13.5        | 13.9        |                              |      |
|   |  | Full range                    | 13.4        |             |      | 13.4        |             |                              |      |
|   | $I_O = -20\ \text{mA}$   | 25°C                          | 11.5        | 12.3        |      | 11.5        | 12.3        |                              |      |
|   |  | Full range                    | 11.5        |             |      | 11.5        |             |                              |      |
| $V_{OM-}$ Maximum negative peak output voltage swing                          | $I_O = 200\ \mu\text{A}$   | 25°C                          | -13.8       | -14.2       |      | -13.8       | -14.2       | V                            |      |
|   |  | Full range                    | -13.7       |             |      | -13.7       |             |                              |      |
|   | $I_O = 2\ \text{mA}$   | 25°C                          | -13.7       | -14         |      | -13.7       | -14         |                              |      |
|   |  | Full range                    | -13.6       |             |      | -13.6       |             |                              |      |
|   | $I_O = 20\ \text{mA}$  | 25°C                          | -11.5       | -12.4       |      | -11.5       | -12.4       |                              |      |
|   |  | Full range                    | -11.5       |             |      | -11.5       |             |                              |      |
| $A_{VD}$ Large-signal differential voltage amplification                      | $V_O = \pm 10\ \text{V}$   | $R_L = 600\ \Omega$           | 25°C        | 80          | 96   |             | 80          | 96                           | dB   |
|   |  |                               | Full range  | 79          |      |             | 79          |                              |      |
|   |  | $R_L = 2\ \text{k}\Omega$     | 25°C        | 90          | 109  |             | 90          | 109                          |      |
|   |  |                               | Full range  | 89          |      |             | 89          |                              |      |
|   |  | $R_L = 10\ \text{k}\Omega$    | 25°C        | 95          | 118  |             | 95          | 118                          |      |
|   |  |                               | Full range  | 94          |      |             | 94          |                              |      |
| $r_i$ Input resistance  | $V_{IC} = 0$   | 25°C                          |             | $10^{12}$   |      | $10^{12}$   | $\Omega$    |                              |      |
| $c_i$ Input capacitance   | Common mode  | $V_{IC} = 0,$<br>See Figure 5 | 25°C        |             | 7.5  |             | 7.5         | pF                           |      |
|   | Differential   |                               | 25°C        |             | 2.5  |             | 2.5         |                              |      |
| $z_o$ Open-loop output impedance  | $f = 1\ \text{MHz}$  | 25°C                          |             | 80          |      | 80          | $\Omega$    |                              |      |
| CMRR Common-mode rejection ratio  | $V_{IC} = V_{ICRmin},$<br>$V_O = 0,$<br>$R_S = 50\ \Omega$                               | 25°C                          | 80          | 98          |      | 80          | 98          | dB                           |      |
|   |  | Full range                    | 79          |             |      | 79          |             |                              |      |
| $k_{SVR}$ Supply-voltage rejection ratio ( $\Delta V_{CC\pm}/\Delta V_{IO}$ ) | $V_{CC\pm} = \pm 5\ \text{V}$ to $\pm 15\ \text{V},$<br>$V_O = 0,$<br>$R_S = 50\ \Omega$ | 25°C                          | 82          | 99          |      | 82          | 99          | dB                           |      |
|   |  | Full range                    | 81          |             |      | 81          |             |                              |      |

† Full range is 0°C to 70°C.

**TLE207x, TLE207xA**  
**EXCALIBUR LOW-NOISE HIGH-SPEED**  
**JFET-INPUT OPERATIONAL AMPLIFIERS**

SLOS181C – FEBRUARY 1997 – REVISED DECEMBER 2009

**TLE2074C electrical characteristics at specified free-air temperature,  $V_{CC\pm} = \pm 15\text{ V}$  (unless otherwise noted) (continued)**

| PARAMETER                                 | TEST CONDITIONS                         | $T_A^\dagger$          | TLE2074C |     |     | TLE2074AC |     |     | UNIT |
|---|---|------------------------|----------|-----|-----|-----------|-----|-----|------|
|   |   |                        | MIN      | TYP | MAX | MIN       | TYP | MAX |      |
| $I_{CC}$ Supply current (four amplifiers) | $V_O = 0$ , No load                     | 25°C                   | 5.2      | 6.5 | 7.5 | 5.2       | 6.5 | 7.5 | mA   |
|   |   | Full range             | 7.5      |     |     | 7.5       |     |     |      |
| Crosstalk attenuation                     | $V_{IC} = 0$ , $R_L = 2\text{ k}\Omega$ | 25°C                   | 120      |     |     | 120       |     |     | dB   |
| $I_{OS}$ Short-circuit output current     | $V_O = 0$                               | $V_{ID} = 1\text{ V}$  | -30      | -45 |     | -30       | -45 |     | mA   |
|   |   | $V_{ID} = -1\text{ V}$ | 30       | 48  |     | 30        | 48  |     |      |

† Full range is 0°C to 70°C.

**TLE2074C operating characteristics at specified free-air temperature,  $V_{CC\pm} = \pm 15\text{ V}$**

| PARAMETER   | TEST CONDITIONS   | $T_A^\dagger$       | TLE2074C |     |     | TLE2074AC |     |     | UNIT                   |
|---|---|---------------------|----------|-----|-----|-----------|-----|-----|------------------------|
|   |   |                     | MIN      | TYP | MAX | MIN       | TYP | MAX |                        |
| SR+ Positive slew rate                                  | $V_{O(PP)} = 10\text{ V}$ , $A_{VD} = -1$ , $R_L = 2\text{ k}\Omega$ , $C_L = 100\text{ pF}$ , See Figure 1 | 25°C                | 25       | 40  |     | 25        | 40  |     | V/ $\mu\text{s}$       |
|   |   | Full range          | 22       |     |     | 22        |     |     |                        |
| SR- Negative slew rate                                  |   | 25°C                | 30       | 45  |     | 30        | 45  |     | V/ $\mu\text{s}$       |
|   |   | Full range          | 25       |     |     | 25        |     |     |                        |
| $t_s$ Settling time                                     | $A_{VD} = -1$ , 10-V step, $R_L = 1\text{ k}\Omega$ , $C_L = 100\text{ pF}$                                 | To 10 mV            | 0.4      |     |     | 0.4       |     |     | $\mu\text{s}$          |
|   |   | To 1 mV             | 1.5      |     |     | 1.5       |     |     |                        |
| $V_n$ Equivalent input noise voltage                    | $R_S = 20\ \Omega$ , See Figure 3   | f = 10 Hz           | 48       | 85  |     | 48        | 85  |     | nV/ $\sqrt{\text{Hz}}$ |
|   |   | f = 10 kHz          | 12       | 17  |     | 12        | 17  |     |                        |
| $V_{N(PP)}$ Peak-to-peak equivalent input noise voltage |   | f = 10 Hz to 10 kHz | 6        |     |     | 6         |     |     | $\mu\text{V}$          |
|   |   | f = 0.1 Hz to 10 Hz | 0.6      |     |     | 0.6       |     |     |                        |
| $I_n$ Equivalent input noise current                    | $V_{IC} = 0$ , f = 10 kHz   | 25°C                | 2.8      |     |     | 2.8       |     |     | fA/ $\sqrt{\text{Hz}}$ |
| THD + N Total harmonic distortion plus noise            | $V_{O(PP)} = 20\text{ V}$ , f = 1 kHz, $R_S = 25\ \Omega$ , $A_{VD} = 10$ , $R_L = 2\text{ k}\Omega$        | 25°C                | 0.008%   |     |     | 0.008%    |     |     |                        |
| $B_1$ Unity-gain bandwidth                              | $V_I = 10\text{ mV}$ , $C_L = 25\text{ pF}$ , $R_L = 2\text{ k}\Omega$ , See Figure 2                       | 25°C                | 8        | 10  |     | 8         | 10  |     | MHz                    |
| $B_{OM}$ Maximum output-swing bandwidth                 | $V_{O(PP)} = 20\text{ V}$ , $R_L = 2\text{ k}\Omega$ , $A_{VD} = -1$ , $C_L = 25\text{ pF}$                 | 25°C                | 478      | 637 |     | 478       | 637 |     | kHz                    |
| $\phi_m$ Phase margin at unity gain                     | $V_I = 10\text{ mV}$ , $C_L = 25\text{ pF}$ , $R_L = 2\text{ k}\Omega$ , See Figure 2                       | 25°C                | 57°      |     |     | 57°       |     |     |                        |

† Full range is 0°C to 70°C.



**TLE207x, TLE207xA**  
**EXCALIBUR LOW-NOISE HIGH-SPEED**  
**JFET-INPUT OPERATIONAL AMPLIFIERS**

SLOS181C – FEBRUARY 1997 – REVISED DECEMBER 2009

**TLE2074I electrical characteristics at specified free-air temperature,  $V_{CC\pm} = \pm 5\text{ V}$  (unless otherwise noted)**

| PARAMETER   | TEST CONDITIONS   | $T_A^\dagger$                      | TLE2074I   |           |      | TLE2074AI |           |                              | UNIT     |    |
|---|---|------------------------------------|------------|-----------|------|-----------|-----------|------------------------------|----------|----|
|   |   |                                    | MIN        | TYP       | MAX  | MIN       | TYP       | MAX                          |          |    |
| $V_{IO}$ Input offset voltage   | $V_{IC} = 0, V_O = 0,$<br>$R_S = 50\ \Omega$                                  | 25°C                               | -1.6       | 5         |      | -0.5      | 3         | mV                           |          |    |
|   |   | Full range                         |            |           | 9    |           | 7         |                              |          |    |
| $\alpha_{VIO}$ Temperature coefficient of input offset voltage                |   | Full range                         | 10.1       | 30        |      | 10.1      | 30        | $\mu\text{V}/^\circ\text{C}$ |          |    |
| $I_{IO}$ Input offset current   | $V_{IC} = 0, V_O = 0,$<br>See Figure 4  | 25°C                               | 15         | 100       |      | 15        | 100       | pA                           |          |    |
|   |   | Full range                         |            | 5         |      |           | 5         | nA                           |          |    |
| $I_{IB}$ Input bias current   |   | 25°C                               | 20         | 175       |      | 20        | 175       | pA                           |          |    |
|   |   | Full range                         |            | 10        |      |           | 10        | nA                           |          |    |
| $V_{ICR}$ Common-mode input voltage range                                     | $R_S = 50\ \Omega$  | 25°C                               | 5 to -1    | 5 to -1.9 |      | 5 to -1   | 5 to -1.9 | V                            |          |    |
|   |   | Full range                         | 5 to -0.8  |           |      | 5 to -0.8 |           |                              |          |    |
| $V_{OM+}$ Maximum positive peak output voltage swing                          | $I_O = -200\ \mu\text{A}$   | 25°C                               | 3.8        | 4.1       |      | 3.8       | 4.1       | V                            |          |    |
|   |   | Full range                         | 3.7        |           |      | 3.7       |           |                              |          |    |
|   | $I_O = -2\ \text{mA}$   | 25°C                               | 3.5        | 3.9       |      | 3.5       | 3.9       |                              |          |    |
|   |   | Full range                         | 3.4        |           |      | 3.4       |           |                              |          |    |
| $I_O = -20\ \text{mA}$  | 25°C  | 1.5                                | 2.3        |           | 1.5  | 2.3       |           |                              |          |    |
|   | Full range  | 1.5                                |            |           | 1.5  |           |           |                              |          |    |
| $V_{OM-}$ Maximum negative peak output voltage swing                          | $I_O = 200\ \mu\text{A}$  | 25°C                               | -3.8       | -4.2      |      | -3.8      | -4.2      | V                            |          |    |
|   |   | Full range                         | -3.7       |           |      | -3.7      |           |                              |          |    |
|   | $I_O = 2\ \text{mA}$  | 25°C                               | -3.5       | -4.1      |      | -3.5      | -4.1      |                              |          |    |
|   |   | Full range                         | -3.4       |           |      | -3.4      |           |                              |          |    |
| $I_O = 20\ \text{mA}$   | 25°C  | -1.5                               | -2.4       |           | -1.5 | -2.4      |           |                              |          |    |
|   | Full range  | -1.5                               |            |           | -1.5 |           |           |                              |          |    |
| $A_{VD}$ Large-signal differential voltage amplification                      | $V_O = \pm 2.3\ \text{V}$   | $R_L = 600\ \Omega$                | 25°C       | 80        | 91   |           | 80        | 91                           | dB       |    |
|   |   |                                    | Full range | 79        |      |           | 79        |                              |          |    |
|   |   | $R_L = 2\ \text{k}\Omega$          | 25°C       | 90        | 100  |           | 90        | 100                          |          |    |
|   |   |                                    | Full range | 89        |      |           | 89        |                              |          |    |
|   |   | $R_L = 10\ \text{k}\Omega$         | 25°C       | 95        | 106  |           | 95        | 106                          |          |    |
|   |   |                                    | Full range | 94        |      |           | 94        |                              |          |    |
| $r_i$ Input resistance  | $V_{IC} = 0$  | 25°C                               | $10^{12}$  |           |      | $10^{12}$ |           |                              | $\Omega$ |    |
| $c_i$ Input capacitance   | Common mode   | $V_{IC} = 0, \text{ See Figure 5}$ | 25°C       | 11        |      |           | 11        |                              |          | pF |
|   | Differential  |                                    | 25°C       | 2.5       |      |           | 2.5       |                              |          |    |
| $z_o$ Open-loop output impedance  | $f = 1\ \text{MHz}$   | 25°C                               | 80         |           |      | 80        |           |                              | $\Omega$ |    |
| CMRR Common-mode rejection ratio  | $V_{IC} = V_{ICR\text{min}}, V_O = 0, R_S = 50\ \Omega$                       | 25°C                               | 70         | 89        |      | 70        | 89        | dB                           |          |    |
|   |   | Full range                         | 68         |           |      | 68        |           |                              |          |    |
| $k_{SVR}$ Supply-voltage rejection ratio ( $\Delta V_{CC\pm}/\Delta V_{IO}$ ) | $V_{CC\pm} = \pm 5\ \text{V to } \pm 15\ \text{V}, V_O = 0, R_S = 50\ \Omega$ | 25°C                               | 82         | 99        |      | 82        | 99        | dB                           |          |    |
|   |   | Full range                         | 80         |           |      | 80        |           |                              |          |    |

$^\dagger$  Full range is  $-40^\circ\text{C}$  to  $85^\circ\text{C}$ .



**TLE207x, TLE207xA**  
**EXCALIBUR LOW-NOISE HIGH-SPEED**  
**JFET-INPUT OPERATIONAL AMPLIFIERS**

SLOS181C – FEBRUARY 1997 – REVISED DECEMBER 2009

**TLE2074I electrical characteristics at specified free-air temperature,  $V_{CC\pm} = \pm 5\text{ V}$  (unless otherwise noted) (continued)**

| PARAMETER                                 | TEST CONDITIONS                         | $T_A^\dagger$          | TLE2074I |     |     | TLE2074AI |     |     | UNIT |
|---|---|------------------------|----------|-----|-----|-----------|-----|-----|------|
|   |   |                        | MIN      | TYP | MAX | MIN       | TYP | MAX |      |
| $I_{CC}$ Supply current (four amplifiers) | $V_O = 0$ , No load                     | 25°C                   | 5.2      | 6.3 | 7.5 | 5.2       | 6.3 | 7.5 | mA   |
|   |   | Full range             | 7.5      |     |     | 7.5       |     |     |      |
| Crosstalk attenuation                     | $V_{IC} = 0$ , $R_L = 2\text{ k}\Omega$ | 25°C                   | 120      |     |     | 120       |     |     | dB   |
| $I_{OS}$ Short-circuit output current     | $V_O = 0$                               | $V_{ID} = 1\text{ V}$  | -35      |     |     | -35       |     |     | mA   |
|   |   | $V_{ID} = -1\text{ V}$ | 45       |     |     | 45        |     |     |      |

$^\dagger$  Full range is  $-40^\circ\text{C}$  to  $85^\circ\text{C}$ .

**TLE2074I operating characteristics at specified free-air temperature,  $V_{CC\pm} = \pm 5\text{ V}$**

| PARAMETER   | TEST CONDITIONS  | $T_A^\dagger$                               | TLE2074I |        |     | TLE2074AI |        |                        | UNIT                   |     |
|---|--|---|----------|--------|-----|-----------|--------|------------------------|------------------------|-----|
|   |  |   | MIN      | TYP    | MAX | MIN       | TYP    | MAX                    |                        |     |
| SR+ Positive slew rate                                  | $V_{O(PP)} = \pm 2.3\text{ V}$ ,<br>$A_{VD} = -1$ ,<br>$C_L = 100\text{ pF}$ ,<br>$R_L = 2\text{ k}\Omega$ ,<br>See Figure 1 | 25°C  | 35       |        |     | 35        |        |                        | V/ $\mu\text{s}$       |     |
|   |  | Full range                                  | 20       |        |     | 20        |        |                        |                        |     |
| SR- Negative slew rate                                  |  | 25°C  | 38       |        |     | 38        |        |                        | V/ $\mu\text{s}$       |     |
|   |  | Full range                                  | 20       |        |     | 20        |        |                        |                        |     |
| $t_s$ Settling time                                     | $A_{VD} = -1$ ,<br>2-V step,<br>$R_L = 1\text{ k}\Omega$ ,<br>$C_L = 100\text{ pF}$  | To 10 mV                                    | 0.25     |        |     | 0.25      |        |                        | $\mu\text{s}$          |     |
|   |  | To 1 mV                                     | 0.4      |        |     | 0.4       |        |                        |                        |     |
| $V_n$ Equivalent input noise voltage                    | $R_S = 20\ \Omega$ ,<br>See Figure 3   | f = 10 Hz                                   | 48       | 85     |     | 48        | 85     | nV/ $\sqrt{\text{Hz}}$ |                        |     |
|   |  | f = 10 kHz                                  | 12       | 17     |     | 12        | 17     |                        |                        |     |
| $V_{N(PP)}$ Peak-to-peak equivalent input noise voltage |  | f = 10 Hz to 10 kHz                         | 6        |        |     | 6         |        |                        | $\mu\text{V}$          |     |
|   |  | f = 0.1 Hz to 10 Hz                         | 0.6      |        |     | 0.6       |        |                        |                        |     |
| $I_n$ Equivalent input noise current                    | $V_{IC} = 0$ , f = 10 kHz  | 25°C  | 2.8      |        |     | 2.8       |        |                        | fA/ $\sqrt{\text{Hz}}$ |     |
| THD + N Total harmonic distortion plus noise            | $V_{O(PP)} = 5\text{ V}$ ,<br>f = 1 kHz,<br>$R_S = 25\ \Omega$   | $A_{VD} = 10$ ,<br>$R_L = 2\text{ k}\Omega$ | 25°C     | 0.013% |     |           | 0.013% |                        |                        |     |
| $B_1$ Unity-gain bandwidth                              | $V_I = 10\text{ mV}$ ,<br>$C_L = 25\text{ pF}$   | $R_L = 2\text{ k}\Omega$ ,<br>See Figure 2  | 25°C     | 9.4    |     |           | 9.4    |                        |                        | MHz |
| $B_{OM}$ Maximum output-swing bandwidth                 | $V_{O(PP)} = 4\text{ V}$ ,<br>$R_L = 2\text{ k}\Omega$   | $A_{VD} = -1$ ,<br>$C_L = 25\text{ pF}$     | 25°C     | 2.8    |     |           | 2.8    |                        |                        | MHz |
| $\phi_m$ Phase margin at unity gain                     | $V_I = 10\text{ mV}$ ,<br>$C_L = 25\text{ pF}$   | $R_L = 2\text{ k}\Omega$ ,<br>See Figure 2  | 25°C     | 56°    |     |           | 56°    |                        |                        |     |

$^\dagger$  Full range is  $-40^\circ\text{C}$  to  $85^\circ\text{C}$ .



**TLE207x, TLE207xA**  
**EXCALIBUR LOW-NOISE HIGH-SPEED**  
**JFET-INPUT OPERATIONAL AMPLIFIERS**

SLOS181C – FEBRUARY 1997 – REVISED DECEMBER 2009

**TLE2074I electrical characteristics at specified free-air temperature,  $V_{CC\pm} = \pm 15\text{ V}$  (unless otherwise noted)**

| PARAMETER      |   | TEST CONDITIONS   |                               | $T_A^\dagger$ | TLE2074I            |             |             | TLE2074AI   |                              |     | UNIT |
|----------------|---|---|-------------------------------|---------------|---------------------|-------------|-------------|-------------|------------------------------|-----|------|
|                |   |   |                               |               | MIN                 | TYP         | MAX         | MIN         | TYP                          | MAX |      |
| $V_{IO}$       | Input offset voltage  | $V_{IC} = 0,$<br>$R_S = 50\ \Omega$   | $V_O = 0,$                    | 25°C          | -1.6                | 5           | -0.5        | 3           | mV                           |     |      |
|                |   |   |                               | Full range    | 9                   |             |             | 7           |                              |     |      |
| $\alpha_{VIO}$ | Temperature coefficient of input offset voltage                     |   |                               | Full range    | 10.1                | 30          | 10.1        | 30          | $\mu\text{V}/^\circ\text{C}$ |     |      |
| $I_{IO}$       | Input offset current  | $V_{IC} = 0,$<br>See Figure 4   | $V_O = 0,$                    | 25°C          | 15                  | 100         | 15          | 100         | pA                           |     |      |
|                |   |   |                               | Full range    | 5                   |             |             | 5           |                              |     |      |
| $I_{IB}$       | Input bias current  |   |                               | 25°C          | 25                  | 175         | 25          | 175         | pA                           |     |      |
|                |   |   |                               | Full range    | 10                  |             |             | 10          |                              |     |      |
| $V_{ICR}$      | Common-mode input voltage range                                     | $R_S = 50\ \Omega$  |                               | 25°C          | 15 to -11           | 15 to -11.9 | 15 to -11   | 15 to -11.9 | V                            |     |      |
|                |   |   |                               | Full range    | 15 to -10.8         |             | 15 to -10.8 |             |                              |     |      |
| $V_{OM+}$      | Maximum positive peak output voltage swing                          |   |                               | 25°C          | 13.8                | 14.1        | 13.8        | 14.1        | V                            |     |      |
|                |   |   |                               | Full range    | 13.7                |             |             | 13.7        |                              |     |      |
|                |   |   |                               | 25°C          | 13.5                | 13.9        | 13.5        | 13.9        |                              |     |      |
|                |   |   |                               | Full range    | 13.4                |             |             | 13.4        |                              |     |      |
|                |   |   |                               | 25°C          | 11.5                | 12.3        | 11.5        | 12.3        |                              |     |      |
|                |   |   |                               | Full range    | 11.5                |             |             | 11.5        |                              |     |      |
| $V_{OM-}$      | Maximum negative peak output voltage swing                          |   |                               | 25°C          | -13.8               | -14.2       | -13.8       | -14.2       | V                            |     |      |
|                |   |   |                               | Full range    | -13.7               |             |             | -13.7       |                              |     |      |
|                |   |   |                               | 25°C          | -13.5               | -14         | -13.5       | -14         |                              |     |      |
|                |   |   |                               | Full range    | -13.4               |             |             | -13.4       |                              |     |      |
|                |   |   |                               | 25°C          | -11.5               | -12.4       | -11.5       | -12.4       |                              |     |      |
|                |   |   |                               | Full range    | -11.5               |             |             | -11.5       |                              |     |      |
| $A_{VD}$       | Large-signal differential voltage amplification                     | $V_O = \pm 10\text{ V}$   |                               |               | $R_L = 600\ \Omega$ | 25°C        | 80          | 96          | 80                           | 96  | dB   |
|                |   |   |                               |               |                     | Full range  | 79          |             |                              | 79  |      |
|                |   |   |                               |               |                     | 25°C        | 90          | 109         | 90                           | 109 |      |
|                |   |   |                               |               |                     | Full range  | 89          |             |                              | 89  |      |
|                |   |   |                               |               |                     | 25°C        | 95          | 118         | 95                           | 118 |      |
|                |   |   |                               |               |                     | Full range  | 94          |             |                              | 94  |      |
| $r_i$          | Input resistance  | $V_{IC} = 0$  |                               | 25°C          | $10^{12}$           |             |             | $10^{12}$   | $\Omega$                     |     |      |
| $c_i$          | Input capacitance   | Common mode   | $V_{IC} = 0,$<br>See Figure 5 | 25°C          | 7.5                 |             |             | 7.5         | pF                           |     |      |
|                |   | Differential  |                               | 25°C          | 2.5                 |             |             | 2.5         |                              |     |      |
| $z_o$          | Open-loop output impedance  | $f = 1\text{ MHz}$  |                               | 25°C          | 80                  |             |             | 80          | $\Omega$                     |     |      |
| CMRR           | Common-mode rejection ratio   | $V_{IC} = V_{ICRmin},$<br>$V_O = 0,$<br>$R_S = 50\ \Omega$                            |                               | 25°C          | 80                  | 98          | 80          | 98          | dB                           |     |      |
|                |   |   |                               | Full range    | 79                  |             |             | 79          |                              |     |      |
| $k_{SVR}$      | Supply-voltage rejection ratio ( $\Delta V_{CC\pm}/\Delta V_{IO}$ ) | $V_{CC\pm} = \pm 5\text{ V to } \pm 15\text{ V},$<br>$V_O = 0,$<br>$R_S = 50\ \Omega$ |                               | 25°C          | 82                  | 99          | 82          | 99          | dB                           |     |      |
|                |   |   |                               | Full range    | 80                  |             |             | 80          |                              |     |      |

$^\dagger$  Full range is  $-40^\circ\text{C}$  to  $85^\circ\text{C}$ .



**TLE207x, TLE207xA**  
**EXCALIBUR LOW-NOISE HIGH-SPEED**  
**JFET-INPUT OPERATIONAL AMPLIFIERS**

SLOS181C – FEBRUARY 1997 – REVISED DECEMBER 2009

**TLE2074I electrical characteristics at specified free-air temperature,  $V_{CC\pm} = \pm 15$  V (unless otherwise noted) (continued)**

| PARAMETER | TEST CONDITIONS                  | $T_A$ †                             | TLE2074I   |                 |     | TLE2074AI |     |     | UNIT |    |
|-----------|----------------------------------|-------------------------------------|------------|-----------------|-----|-----------|-----|-----|------|----|
|           |                                  |                                     | MIN        | TYP             | MAX | MIN       | TYP | MAX |      |    |
| $I_{CC}$  | Supply current (four amplifiers) | $V_O = 0$ , No load                 | 25°C       | 5.2             | 6.5 | 7.5       | 5.2 | 6.5 | 7.5  | mA |
|           |                                  |                                     | Full range | 7.5             |     |           | 7.5 |     |      |    |
|           | Crosstalk attenuation            | $V_{IC} = 0$ , $R_L = 2$ k $\Omega$ | 25°C       | 120             |     |           | 120 |     |      | dB |
| $I_{OS}$  | Short-circuit output current     | $V_O = 0$                           | 25°C       | $V_{ID} = 1$ V  | -30 | -45       | -30 | -45 | mA   |    |
|           |                                  |                                     |            | $V_{ID} = -1$ V | 30  | 48        | 30  | 48  |      |    |

† Full range is  $-40^\circ\text{C}$  to  $85^\circ\text{C}$ .

**TLE2074I operating characteristics at specified free-air temperature,  $V_{CC\pm} = \pm 15$  V**

| PARAMETER   | TEST CONDITIONS                             | $T_A$ †   | TLE2074I   |                     |     | TLE2074AI |     |                        | UNIT                   |
|-------------|---|---|------------|---------------------|-----|-----------|-----|------------------------|------------------------|
|             |   |   | MIN        | TYP                 | MAX | MIN       | TYP | MAX                    |                        |
| SR+         | Positive slew rate                          | $V_{O(PP)} = \pm 10$ V,<br>$A_{VD} = -1$ ,<br>$C_L = 100$ pF,<br>$R_L = 2$ k $\Omega$ ,<br>See Figure 1 | 25°C       | 25                  | 40  | 25        | 40  | V/ $\mu$ s             |                        |
|             |   |   | Full range | 19                  |     |           | 19  |                        |                        |
| SR-         | Negative slew rate                          | $V_{O(PP)} = \pm 10$ V,<br>$A_{VD} = -1$ ,<br>$C_L = 100$ pF,<br>$R_L = 2$ k $\Omega$ ,<br>See Figure 1 | 25°C       | 30                  | 45  | 30        | 45  | V/ $\mu$ s             |                        |
|             |   |   | Full range | 22                  |     |           | 22  |                        |                        |
| $t_s$       | Settling time                               | $A_{VD} = -1$ ,<br>10-V step,<br>$R_L = 1$ k $\Omega$ ,<br>$C_L = 100$ pF                               | 25°C       | To 10 mV            | 0.4 |           | 0.4 |                        | $\mu$ s                |
|             |   |   |            | To 1 mV             | 1.5 |           | 1.5 |                        |                        |
| $V_n$       | Equivalent input noise voltage              | $R_S = 20$ $\Omega$ ,<br>See Figure 3   | 25°C       | f = 10 Hz           | 48  | 85        | 48  | 85                     | nV/ $\sqrt{\text{Hz}}$ |
|             |   |   |            | f = 10 kHz          | 12  | 17        | 12  | 17                     |                        |
| $V_{N(PP)}$ | Peak-to-peak equivalent input noise voltage | $R_S = 20$ $\Omega$ ,<br>See Figure 3   | 25°C       | f = 10 Hz to 10 kHz | 6   |           | 6   |                        | $\mu$ V                |
|             |   |   |            | f = 0.1 Hz to 10 Hz | 0.6 |           | 0.6 |                        |                        |
| $I_n$       | Equivalent input noise current              | $V_{IC} = 0$ , f = 10 kHz   | 25°C       | 2.8                 |     | 2.8       |     | fA/ $\sqrt{\text{Hz}}$ |                        |
| THD + N     | Total harmonic distortion plus noise        | $V_{O(PP)} = 20$ V,<br>f = 1 kHz,<br>$R_S = 25$ $\Omega$  | 25°C       | 0.008%              |     | 0.008%    |     |                        |                        |
| $B_1$       | Unity-gain bandwidth                        | $V_I = 10$ mV,<br>$C_L = 25$ pF,<br>$R_L = 2$ k $\Omega$ ,<br>See Figure 2                              | 25°C       | 8                   | 10  | 8         | 10  | MHz                    |                        |
| $B_{OM}$    | Maximum output-swing bandwidth              | $V_{O(PP)} = 20$ V,<br>$R_L = 2$ k $\Omega$ ,<br>$A_{VD} = -1$ ,<br>$C_L = 25$ pF                       | 25°C       | 478                 | 637 | 478       | 637 | kHz                    |                        |
| $\phi_m$    | Phase margin at unity gain                  | $V_I = 10$ mV,<br>$C_L = 25$ pF,<br>$R_L = 2$ k $\Omega$ ,<br>See Figure 2                              | 25°C       | 57°                 |     | 57°       |     |                        |                        |

† Full range is  $-40^\circ\text{C}$  to  $85^\circ\text{C}$ .





**TLE207x, TLE207xA**  
**EXCALIBUR LOW-NOISE HIGH-SPEED**  
**JFET-INPUT OPERATIONAL AMPLIFIERS**

SLOS181C – FEBRUARY 1997 – REVISED DECEMBER 2009

**TLE2074M electrical characteristics at specified free-air temperature,  $V_{CC\pm} = \pm 5\text{ V}$  (unless otherwise noted)**

| PARAMETER   | TEST CONDITIONS   | $T_A^\dagger$                     | TLE2074M   |                 |      | TLE2074AM |                 |                              | UNIT     |    |
|---|---|-----------------------------------|------------|-----------------|------|-----------|-----------------|------------------------------|----------|----|
|   |   |                                   | MIN        | TYP             | MAX  | MIN       | TYP             | MAX                          |          |    |
| $V_{IO}$ Input offset voltage   | $V_{IC} = 0, V_O = 0, R_S = 50\ \Omega$                                       | 25°C                              | -1.6       | 5               |      | -0.5      | 3               | mV                           |          |    |
|   |   | Full range                        |            |                 | 10.5 |           | 8.5             |                              |          |    |
| $\alpha_{VIO}$ Temperature coefficient of input offset voltage                  |   | Full range                        | 10.1       | 30 <sup>‡</sup> |      | 10.1      | 30 <sup>‡</sup> | $\mu\text{V}/^\circ\text{C}$ |          |    |
| $I_{IO}$ Input offset current   | $V_{IC} = 0, V_O = 0, \text{See Figure 4}$                                    | 25°C                              | 15         | 100             |      | 15        | 100             | pA                           |          |    |
|   |   | Full range                        |            |                 | 20   |           | 20              | nA                           |          |    |
| $I_{IB}$ Input bias current   |   | 25°C                              | 20         | 175             |      | 20        | 175             | pA                           |          |    |
|   |   | Full range                        |            |                 | 60   |           | 60              | nA                           |          |    |
| $V_{ICR}$ Common-mode input voltage range                                       | $R_S = 50\ \Omega$  | 25°C                              | 5 to -1    | 5 to -1.9       |      | 5 to -1   | 5 to -1.9       | V                            |          |    |
|   |   | Full range                        | 5 to -0.8  |                 |      | 5 to -0.8 |                 |                              |          |    |
| $V_{OM+}$ Maximum positive peak output voltage swing                            | $I_O = -200\ \mu\text{A}$   | 25°C                              | 3.8        | 4.1             |      | 3.8       | 4.1             | V                            |          |    |
|   |   | Full range                        | 3.6        |                 |      | 3.6       |                 |                              |          |    |
|   | $I_O = -2\ \text{mA}$   | 25°C                              | 3.5        | 3.9             |      | 3.5       | 3.9             |                              |          |    |
|   |   | Full range                        | 3.3        |                 |      | 3.3       |                 |                              |          |    |
|   | $I_O = -20\ \text{mA}$  | 25°C                              | 1.5        | 2.3             |      | 1.5       | 2.3             |                              |          |    |
|   |   | Full range                        | 1.4        |                 |      | 1.4       |                 |                              |          |    |
| $V_{OM-}$ Maximum negative peak output voltage swing                            | $I_O = 200\ \mu\text{A}$  | 25°C                              | -3.8       | -4.2            |      | -3.8      | -4.2            | V                            |          |    |
|   |   | Full range                        | -3.6       |                 |      | -3.6      |                 |                              |          |    |
|   | $I_O = 2\ \text{mA}$  | 25°C                              | -3.5       | -4.1            |      | -3.5      | -4.1            |                              |          |    |
|   |   | Full range                        | -3.3       |                 |      | -3.3      |                 |                              |          |    |
|   | $I_O = 20\ \text{mA}$   | 25°C                              | -1.5       | -2.4            |      | -1.5      | -2.4            |                              |          |    |
|   |   | Full range                        | -1.4       |                 |      | -1.4      |                 |                              |          |    |
| $A_{VD}$ Large-signal differential voltage amplification                        | $V_O = \pm 2.3\ \text{V}$   | $R_L = 600\ \Omega$               | 25°C       | 80              | 91   |           | 80              | 91                           | dB       |    |
|   |   |                                   | Full range | 78              |      |           | 78              |                              |          |    |
|   |   | $R_L = 2\ \text{k}\Omega$         | 25°C       | 90              | 100  |           | 90              | 100                          |          |    |
|   |   |                                   | Full range | 88              |      |           | 88              |                              |          |    |
|   |   | $R_L = 10\ \text{k}\Omega$        | 25°C       | 95              | 106  |           | 95              | 106                          |          |    |
|   |   |                                   | Full range | 93              |      |           | 93              |                              |          |    |
| $r_i$ Input resistance  | $V_{IC} = 0$  | 25°C                              | $10^{12}$  |                 |      | $10^{12}$ |                 |                              | $\Omega$ |    |
| $c_i$ Input capacitance   | Common mode   | $V_{IC} = 0, \text{See Figure 5}$ | 25°C       | 11              |      |           | 11              |                              |          | pF |
|   | Differential  |                                   | 25°C       | 2.5             |      |           | 2.5             |                              |          |    |
| $z_o$ Open-loop output impedance  | $f = 1\ \text{MHz}$   | 25°C                              | 80         |                 |      | 80        |                 |                              | $\Omega$ |    |
| CMRR Common-mode rejection ratio  | $V_{IC} = V_{ICR\text{min}}, V_O = 0, R_S = 50\ \Omega$                       | 25°C                              | 70         | 89              |      | 70        | 89              | dB                           |          |    |
|   |   | Full range                        | 68         |                 |      | 68        |                 |                              |          |    |
| $k_{SVR}$ Supply-voltage rejection ratio ( $\Delta V_{CC\pm} / \Delta V_{IO}$ ) | $V_{CC\pm} = \pm 5\ \text{V to } \pm 15\ \text{V}, V_O = 0, R_S = 50\ \Omega$ | 25°C                              | 82         | 99              |      | 82        | 99              | dB                           |          |    |
|   |   | Full range                        | 80         |                 |      | 80        |                 |                              |          |    |

<sup>†</sup> Full range is  $-55^\circ\text{C}$  to  $125^\circ\text{C}$ .

<sup>‡</sup> On products compliant to MIL-PRF-38535, Class B, this parameter is not production tested.



**TLE207x, TLE207xA**  
**EXCALIBUR LOW-NOISE HIGH-SPEED**  
**JFET-INPUT OPERATIONAL AMPLIFIERS**

SLOS181C – FEBRUARY 1997 – REVISED DECEMBER 2009

**TLE2074M electrical characteristics at specified free-air temperature,  $V_{CC\pm} = \pm 5\text{ V}$  (unless otherwise noted) (continued)**

| PARAMETER                                 | TEST CONDITIONS                         | $T_A^\dagger$ | TLE2074M               |     |     | TLE2074AM |     |     | UNIT |
|---|---|---------------|------------------------|-----|-----|-----------|-----|-----|------|
|   |   |               | MIN                    | TYP | MAX | MIN       | TYP | MAX |      |
| $I_{CC}$ Supply current (four amplifiers) | $V_O = 0$ , No load                     | 25°C          | 5.2                    | 6.3 | 7.5 | 5.2       | 6.3 | 7.5 | mA   |
|   |   | Full range    | 7.5                    |     |     | 7.5       |     |     |      |
| Crosstalk attenuation                     | $V_{IC} = 0$ , $R_L = 2\text{ k}\Omega$ | 25°C          | 120                    |     |     | 120       |     |     | dB   |
| $I_{OS}$ Short-circuit output current     | $V_O = 0$                               | 25°C          | $V_{ID} = 1\text{ V}$  |     |     | -35       |     |     | mA   |
|   |   |               | $V_{ID} = -1\text{ V}$ |     |     | 45        |     |     |      |

† Full range is  $-55^\circ\text{C}$  to  $125^\circ\text{C}$ .

**TLE2074M operating characteristics at specified free-air temperature,  $V_{CC\pm} = \pm 5\text{ V}$**

| PARAMETER   | TEST CONDITIONS  | $T_A^\dagger$                               | TLE2074M                            |        |                 | TLE2074AM       |                 |                        | UNIT                   |               |
|---|--|---|-------------------------------------|--------|-----------------|-----------------|-----------------|------------------------|------------------------|---------------|
|   |  |   | MIN                                 | TYP    | MAX             | MIN             | TYP             | MAX                    |                        |               |
| SR+ Positive slew rate                                  | $V_{O(PP)} = \pm 2.3\text{ V}$ ,<br>$A_{VD} = -1$ ,<br>$C_L = 100\text{ pF}$ ,<br>$R_L = 2\text{ k}\Omega$ ,<br>See Figure 1 | 25°C  | 35                                  |        |                 | 35              |                 |                        | V/ $\mu\text{s}$       |               |
|   |  | Full range                                  | 18 <sup>‡</sup>                     |        |                 | 18 <sup>‡</sup> |                 |                        |                        |               |
| SR- Negative slew rate                                  |  | 25°C  | 38                                  |        |                 | 38              |                 |                        | V/ $\mu\text{s}$       |               |
|   |  | Full range                                  | 18 <sup>‡</sup>                     |        |                 | 18 <sup>‡</sup> |                 |                        |                        |               |
| $t_s$ Settling time                                     | $A_{VD} = -1$ ,<br>2-V step,<br>$R_L = 1\text{ k}\Omega$ ,<br>$C_L = 100\text{ pF}$  | To 10 mV                                    | 0.25                                |        |                 | 0.25            |                 |                        | $\mu\text{s}$          |               |
|   |  | To 1 mV                                     | 0.4                                 |        |                 | 0.4             |                 |                        |                        |               |
| $V_n$ Equivalent input noise voltage                    | $R_S = 20\ \Omega$ ,<br>See Figure 3   | 25°C  | $f = 10\text{ Hz}$                  | 48     | 85 <sup>‡</sup> | 48              | 85 <sup>‡</sup> | nV/ $\sqrt{\text{Hz}}$ |                        |               |
|   |  |   | $f = 10\text{ kHz}$                 | 12     | 17 <sup>‡</sup> | 12              | 17 <sup>‡</sup> |                        |                        |               |
| $V_{N(PP)}$ Peak-to-peak equivalent input noise voltage |  | 25°C  | $f = 10\text{ Hz to }10\text{ kHz}$ | 6      |                 |                 | 6               |                        |                        | $\mu\text{V}$ |
|   |  |   | $f = 0.1\text{ Hz to }10\text{ Hz}$ | 0.6    |                 |                 | 0.6             |                        |                        |               |
| $I_n$ Equivalent input noise current                    | $V_{IC} = 0$ , $f = 10\text{ kHz}$   | 25°C  | 2.8                                 |        |                 | 2.8             |                 |                        | fA/ $\sqrt{\text{Hz}}$ |               |
| THD + N Total harmonic distortion plus noise            | $V_{O(PP)} = 5\text{ V}$ ,<br>$f = 1\text{ kHz}$ ,<br>$R_S = 25\ \Omega$   | $A_{VD} = 10$ ,<br>$R_L = 2\text{ k}\Omega$ | 25°C                                | 0.013% |                 |                 | 0.013%          |                        |                        |               |
| $B_1$ Unity-gain bandwidth                              | $V_I = 10\text{ mV}$ ,<br>$C_L = 25\text{ pF}$   | $R_L = 2\text{ k}\Omega$ ,<br>See Figure 2  | 25°C                                | 9.4    |                 |                 | 9.4             |                        |                        | MHz           |
| $B_{OM}$ Maximum output-swing bandwidth                 | $V_{O(PP)} = 4\text{ V}$ ,<br>$R_L = 2\text{ k}\Omega$   | $A_{VD} = -1$ ,<br>$C_L = 25\text{ pF}$     | 25°C                                | 2.8    |                 |                 | 2.8             |                        |                        | MHz           |
| $f_m$ Phase margin at unity gain                        | $V_I = 10\text{ mV}$ ,<br>$C_L = 25\text{ pF}$   | $R_L = 2\text{ k}\Omega$ ,<br>See Figure 2  | 25°C                                | 56°    |                 |                 | 56°             |                        |                        |               |

† Full range is  $-55^\circ\text{C}$  to  $125^\circ\text{C}$ .

‡ On products compliant to MIL-PRF-38535, Class B, this parameter is not production tested.



**TLE207x, TLE207xA**  
**EXCALIBUR LOW-NOISE HIGH-SPEED**  
**JFET-INPUT OPERATIONAL AMPLIFIERS**

SLOS181C – FEBRUARY 1997 – REVISED DECEMBER 2009

**TLE2074M electrical characteristics at specified free-air temperature,  $V_{CC\pm} = \pm 15$  V (unless otherwise noted)**

| PARAMETER   | TEST CONDITIONS   | $T_A^\dagger$                 | TLE2074M    |                 |      | TLE2074AM   |                 |                              | UNIT |
|---|---|-------------------------------|-------------|-----------------|------|-------------|-----------------|------------------------------|------|
|   |   |                               | MIN         | TYP             | MAX  | MIN         | TYP             | MAX                          |      |
| $V_{IO}$ Input offset voltage   | $V_{IC} = 0, V_O = 0,$<br>$R_S = 50 \Omega$                                       | 25°C                          | -1.6        | 5               |      | -0.5        | 3               | mV                           |      |
|   |   | Full range                    |             |                 | 10.5 |             | 8.5             |                              |      |
| $\alpha_{VIO}$ Temperature coefficient of input offset voltage                  |   | Full range                    | 10.1        | 30 <sup>‡</sup> |      | 10.1        | 30 <sup>‡</sup> | $\mu\text{V}/^\circ\text{C}$ |      |
| $I_{IO}$ Input offset current   | $V_{IC} = 0, V_O = 0,$<br>See Figure 4  | 25°C                          | 15          | 100             |      | 15          | 100             | pA                           |      |
|   |   | Full range                    |             | 20              |      | 20          |                 | nA                           |      |
| $I_{IB}$ Input bias current   |   | 25°C                          | 25          | 175             |      | 25          | 175             | pA                           |      |
|   |   | Full range                    |             | 60              |      | 60          |                 | nA                           |      |
| $V_{ICR}$ Common-mode input voltage range                                       | $R_S = 50 \Omega$   | 25°C                          | 15 to -11   | 15 to -11.9     |      | 15 to -11   | 15 to -11.9     | V                            |      |
|   |   | Full range                    | 15 to -10.8 |                 |      | 15 to -10.8 |                 |                              |      |
| $V_{OM+}$ Maximum positive peak output voltage swing                            | $I_O = -200 \mu\text{A}$  | 25°C                          | 13.8        | 14.1            |      | 13.8        | 14.1            | V                            |      |
|   |   | Full range                    | 13.6        |                 |      | 13.6        |                 |                              |      |
|   | $I_O = -2 \text{ mA}$   | 25°C                          | 13.5        | 13.9            |      | 13.5        | 13.9            |                              |      |
|   |   | Full range                    | 13.3        |                 |      | 13.3        |                 |                              |      |
|   | $I_O = -20 \text{ mA}$  | 25°C                          | 11.5        | 12.3            |      | 11.5        | 12.3            |                              |      |
|   |   | Full range                    | 11.4        |                 |      | 11.4        |                 |                              |      |
| $V_{OM-}$ Maximum negative peak output voltage swing                            | $I_O = 200 \mu\text{A}$   | 25°C                          | -13.8       | -14.2           |      | -13.8       | -14.2           | V                            |      |
|   |   | Full range                    | -13.6       |                 |      | -13.6       |                 |                              |      |
|   | $I_O = 2 \text{ mA}$  | 25°C                          | -13.5       | -14             |      | -13.5       | -14             |                              |      |
|   |   | Full range                    | -13.3       |                 |      | -13.3       |                 |                              |      |
|   | $I_O = 20 \text{ mA}$   | 25°C                          | -11.5       | -12.4           |      | -11.5       | -12.4           |                              |      |
|   |   | Full range                    | -11.4       |                 |      | -11.4       |                 |                              |      |
| $A_{VD}$ Large-signal differential voltage amplification                        | $V_O = \pm 10 \text{ V}$  | $R_L = 600 \Omega$            | 25°C        | 80              | 96   |             | 80              | 96                           | dB   |
|   |   |                               | Full range  | 78              |      |             | 78              |                              |      |
|   |   | $R_L = 2 \text{ k}\Omega$     | 25°C        | 90              | 109  |             | 90              | 109                          |      |
|   |   |                               | Full range  | 88              |      |             | 88              |                              |      |
|   |   | $R_L = 10 \text{ k}\Omega$    | 25°C        | 95              | 118  |             | 95              | 118                          |      |
|   |   |                               | Full range  | 93              |      |             | 93              |                              |      |
| $r_i$ Input resistance  | $V_{IC} = 0$  | 25°C                          |             | $10^{12}$       |      | $10^{12}$   | $\Omega$        |                              |      |
| $c_i$ Input capacitance   | Common mode   | $V_{IC} = 0,$<br>See Figure 5 | 25°C        | 7.5             |      | 7.5         | pF              |                              |      |
|   | Differential  |                               | 25°C        | 2.5             |      | 2.5         |                 |                              |      |
| $z_o$ Open-loop output impedance  | $f = 1 \text{ MHz}$   | 25°C                          |             | 80              |      | 80          | $\Omega$        |                              |      |
| CMRR Common-mode rejection ratio  | $V_{IC} = V_{ICRmin}, V_O = 0,$<br>$R_S = 50 \Omega$                              | 25°C                          | 80          | 98              |      | 80          | 98              | dB                           |      |
|   |   | Full range                    | 78          |                 |      | 78          |                 |                              |      |
| $k_{SVR}$ Supply-voltage rejection ratio ( $\Delta V_{CC\pm} / \Delta V_{IO}$ ) | $V_{CC\pm} = \pm 5 \text{ V to } \pm 15 \text{ V}, V_O = 0,$<br>$R_S = 50 \Omega$ | 25°C                          | 82          | 99              |      | 82          | 99              | dB                           |      |
|   |   | Full range                    | 80          |                 |      | 80          |                 |                              |      |

<sup>†</sup> Full range is -55°C to 125°C.

<sup>‡</sup> On products compliant to MIL-PRF-38535, Class B, this parameter is not production tested.



# TLE207x, TLE207xA EXCALIBUR LOW-NOISE HIGH-SPEED JFET-INPUT OPERATIONAL AMPLIFIERS

SLOS181C – FEBRUARY 1997 – REVISED DECEMBER 2009

**TLE2074M electrical characteristics at specified free-air temperature,  $V_{CC\pm} = \pm 15$  V (unless otherwise noted) (continued)**

| PARAMETER | TEST CONDITIONS                     | $T_A$ †                                | TLE2074M   |                 |     | TLE2074AM |     |     | UNIT |    |
|-----------|-------------------------------------|--|------------|-----------------|-----|-----------|-----|-----|------|----|
|           |                                     |  | MIN        | TYP             | MAX | MIN       | TYP | MAX |      |    |
| $I_{CC}$  | Supply current<br>(four amplifiers) | $V_O = 0$ ,<br>No load                 | 25°C       | 5.2             | 6.5 | 7.5       | 5.2 | 6.5 | 7.5  | mA |
|           |                                     |  | Full range | 7.5             |     |           | 7.5 |     |      |    |
|           | Crosstalk attenuation               | $V_{IC} = 0$ ,<br>$R_L = 2$ k $\Omega$ | 25°C       | 120             |     |           | 120 |     |      | dB |
| $I_{OS}$  | Short-circuit output current        | $V_O = 0$                              | 25°C       | $V_{ID} = 1$ V  | -30 | -45       | -30 | -45 | mA   |    |
|           |                                     |  |            | $V_{ID} = -1$ V | 30  | 48        | 30  | 48  |      |    |

† Full range is  $-55^\circ\text{C}$  to  $125^\circ\text{C}$ .

**TLE2074M operating characteristics at specified free-air temperature,  $V_{CC\pm} = \pm 15$  V**

| PARAMETER   | TEST CONDITIONS                             | $T_A$ †   | TLE2074M |                     |     | TLE2074AM |     |                        | UNIT                   |
|-------------|---|---|----------|---------------------|-----|-----------|-----|------------------------|------------------------|
|             |   |   | MIN      | TYP                 | MAX | MIN       | TYP | MAX                    |                        |
| SR+         | Positive slew rate                          | $V_{O(PP)} = 10$ V,<br>$R_L = 2$ k $\Omega$ ,<br>See Figure 1                     | 25°C     | 25                  | 40  |           | 25  | 40                     | V/ $\mu$ s             |
|             |   |   |          | Full range          | 17  |           |     | 17                     |                        |
| SR-         | Negative slew rate                          | $V_{O(PP)} = 10$ V,<br>$R_L = 2$ k $\Omega$ ,<br>See Figure 1                     | 25°C     | 30                  | 45  |           | 30  | 45                     | V/ $\mu$ s             |
|             |   |   |          | Full range          | 20  |           |     | 20                     |                        |
| $t_s$       | Settling time                               | $A_{VD} = -1$ ,<br>10-V step,<br>$R_L = 1$ k $\Omega$ ,<br>$C_L = 100$ pF         | 25°C     | To 10 mV            | 0.4 |           | 0.4 |                        | $\mu$ s                |
|             |   |   |          | To 1 mV             | 1.5 |           | 1.5 |                        |                        |
| $V_n$       | Equivalent input noise voltage              | $R_S = 20$ $\Omega$ ,<br>See Figure 3   | 25°C     | f = 10 Hz           | 48  | 85‡       | 48  | 85‡                    | nV/ $\sqrt{\text{Hz}}$ |
|             |   |   |          | f = 10 kHz          | 12  | 17‡       | 12  | 17‡                    |                        |
| $V_{N(PP)}$ | Peak-to-peak equivalent input noise voltage | $R_S = 20$ $\Omega$ ,<br>See Figure 3   | 25°C     | f = 10 Hz to 10 kHz | 6   |           | 6   |                        | $\mu$ V                |
|             |   |   |          | f = 0.1 Hz to 10 Hz | 0.6 |           | 0.6 |                        |                        |
| $I_n$       | Equivalent input noise current              | $V_{IC} = 0$ ,<br>f = 10 kHz  | 25°C     | 2.8                 |     | 2.8       |     | fA/ $\sqrt{\text{Hz}}$ |                        |
| THD + N     | Total harmonic distortion plus noise        | $V_{O(PP)} = 20$ V,<br>f = 1 kHz,<br>$R_S = 25$ $\Omega$                          | 25°C     | 0.008%              |     | 0.008%    |     |                        |                        |
| $B_1$       | Unity-gain bandwidth                        | $V_I = 10$ mV,<br>$C_L = 25$ pF,<br>$R_L = 2$ k $\Omega$ ,<br>See Figure 2        | 25°C     | 8‡                  | 10  | 8‡        | 10  | MHz                    |                        |
| $B_{OM}$    | Maximum output-swing bandwidth              | $V_{O(PP)} = 20$ V,<br>$R_L = 2$ k $\Omega$ ,<br>$A_{VD} = -1$ ,<br>$C_L = 25$ pF | 25°C     | 478‡                | 637 | 478‡      | 637 | kHz                    |                        |
| $\phi_m$    | Phase margin at unity gain                  | $V_I = 10$ mV,<br>$C_L = 25$ pF,<br>$R_L = 2$ k $\Omega$ ,<br>See Figure 2        | 25°C     | 57°                 |     | 57°       |     |                        |                        |

† Full range is  $-55^\circ\text{C}$  to  $125^\circ\text{C}$ .

‡ On products compliant to MIL-PRF-38535, Class B, this parameter is not production tested.



**TLE207x, TLE207xA**  
**EXCALIBUR LOW-NOISE HIGH-SPEED**  
**JFET-INPUT OPERATIONAL AMPLIFIERS**

SLOS181C – FEBRUARY 1997 – REVISED DECEMBER 2009

**TLE2074Y electrical characteristics at  $V_{CC\pm} = \pm 15$  V,  $T_A = 25^\circ\text{C}$  (unless otherwise noted)**

| PARAMETER |   | TEST CONDITIONS  |            | TLE2074Y                   |                  |     | UNIT     |
|-----------|---|--|------------|----------------------------|------------------|-----|----------|
|           |   |  |            | MIN                        | TYP              | MAX |          |
| $V_{IO}$  | Input offset voltage  | $V_{IC} = 0,$<br>$R_S = 50 \Omega$   | $V_O = 0,$ |                            |                  | 5   | mV       |
| $I_{IO}$  | Input offset current  | $V_{IC} = 0,$  | $V_O = 0,$ |                            | 15               | 100 | pA       |
| $I_{IB}$  | Input bias current  | See Figure 4   |            |                            | 25               | 175 |          |
| $V_{ICR}$ | Common-mode input voltage range                                     | $R_S = 50 \Omega$  |            | 15<br>to<br>-11            | 15<br>to<br>11.9 |     | V        |
| $V_{OM+}$ | Maximum positive peak output voltage swing                          | $I_O = -200 \mu\text{A}$   |            | 13.8                       | 14.1             |     | V        |
|           |   | $I_O = -2 \text{ mA}$  |            | 13.5                       | 13.9             |     |          |
|           |   | $I_O = -20 \text{ mA}$   |            | 11.5                       | 12.3             |     |          |
| $V_{OM-}$ | Maximum negative peak output voltage swing                          | $I_O = 200 \mu\text{A}$  |            | -13.8                      | -14.2            |     | V        |
|           |   | $I_O = 2 \text{ mA}$   |            | -13.5                      | -14              |     |          |
|           |   | $I_O = 20 \text{ mA}$  |            | -11.5                      | -12.4            |     |          |
| $A_{VD}$  | Large-signal differential voltage amplification                     | $V_O = \pm 10 \text{ V}$   |            | $R_L = 600 \Omega$         | 80               | 96  | dB       |
|           |   |  |            | $R_L = 2 \text{ k}\Omega$  | 90               | 109 |          |
|           |   |  |            | $R_L = 10 \text{ k}\Omega$ | 95               | 118 |          |
| $r_i$     | Input resistance  | $V_{IC} = 0$   |            | $10^{12}$                  |                  |     | $\Omega$ |
| $c_i$     | Input capacitance   | Common mode  | $V_O = 0,$ | See Figure 5               | 7.5              |     | pF       |
|           |   | Differential   |            |                            | 2.5              |     |          |
| $z_o$     | Open-loop output impedance  | $f = 1 \text{ MHz}$  |            | 80                         |                  |     | $\Omega$ |
| CMRR      | Common-mode rejection ratio   | $V_{IC} = V_{ICRmin},$<br>$R_S = 50 \Omega$  | $V_O = 0,$ | 80                         | 98               |     | dB       |
| $k_{SVR}$ | Supply-voltage rejection ratio ( $\Delta V_{CC\pm}/\Delta V_{IO}$ ) | $V_{CC\pm} = \pm 5 \text{ V to } \pm 15 \text{ V},$<br>$V_O = 0,$<br>$R_S = 50 \Omega$ |            | 82                         | 99               |     | dB       |
| $I_{CC}$  | Supply current (four amplifiers)                                    | $V_O = 0,$   | No load    | 5.2                        | 6.5              | 7.5 | mA       |
| $I_{OS}$  | Short-circuit output current  | $V_O = 0$  |            | $V_{ID} = 1 \text{ V}$     | -30              | -45 | mA       |
|           |   |  |            | $V_{ID} = -1 \text{ V}$    | 30               | 48  |          |

# TLE207x, TLE207xA EXCALIBUR LOW-NOISE HIGH-SPEED JFET-INPUT OPERATIONAL AMPLIFIERS

SLOS181C – FEBRUARY 1997 – REVISED DECEMBER 2009

## PARAMETER MEASUREMENT INFORMATION



† Includes fixture capacitance

**Figure 1. Slew-Rate Test Circuit**

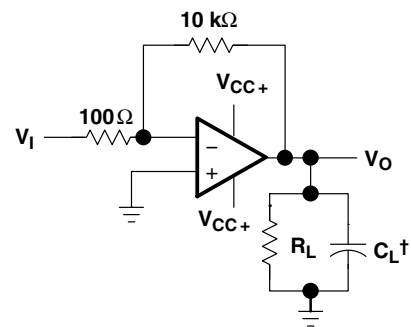

† Includes fixture capacitance

**Figure 2. Unity-Gain Bandwidth and Phase-Margin Test Circuit**

**PARAMETER MEASUREMENT INFORMATION**

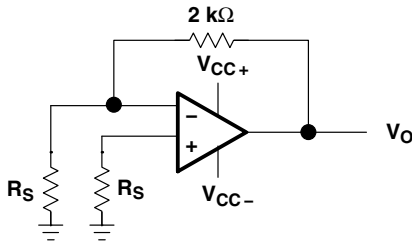

**Figure 3. Noise-Voltage Test Circuit**



**Figure 4. Input-Bias and Offset-Current Test Circuit**

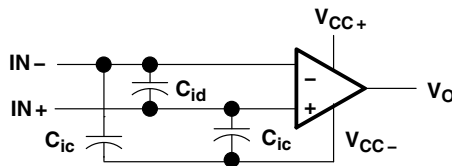

**Figure 5. Internal Input Capacitance**

**typical values**

Typical values presented in this data sheet represent the median (50% point) of device parametric performance.

**input bias and offset current**

At the picoampere bias current level typical of the TLE207x and TLE207xA, accurate measurement of the bias current becomes difficult. Not only does this measurement require a picoammeter but test socket leakages can easily exceed the actual device bias currents. To accurately measure these small currents, Texas Instruments uses a two-step process. The socket leakage is measured using picoammeters with bias voltages applied but with no device in the socket. The device is then inserted in the socket and a second test is performed that measures both the socket leakage and the device input bias current. The two measurements are then subtracted algebraically to determine the bias current of the device.

**TLE207x, TLE207xA**  
**EXCALIBUR LOW-NOISE HIGH-SPEED**  
**JFET-INPUT OPERATIONAL AMPLIFIERS**

SLOS181C – FEBRUARY 1997 – REVISED DECEMBER 2009

**TYPICAL CHARACTERISTICS**

**Table of Graphs**

|                |   |  | <b>FIGURE</b>                       |
|----------------|---|--|-------------------------------------|
| $V_{IO}$       | Input offset voltage                              | Distribution   | 6, 7, 8                             |
| $\alpha_{VIO}$ | Temperature coefficient of input offset voltage   | Distribution   | 9, 10, 11                           |
| $I_{IO}$       | Input offset current                              | vs Free-air temperature  | 12, 13                              |
| $I_{IB}$       | Input bias current                                | vs Free-air temperature<br>vs Total supply voltage                             | 12, 13<br>14                        |
| $V_{ICR}$      | Common-mode input voltage range                   | vs Free-air temperature  | 15                                  |
| $V_O$          | Output voltage                                    | vs Differential input voltage  | 16, 17                              |
| $V_{OM+}$      | Maximum positive peak output voltage              | vs Output current  | 18                                  |
| $V_{OM-}$      | Maximum negative peak output voltage              | vs Output current  | 19                                  |
| $V_{OM}$       | Maximum peak output voltage                       | vs Free-air temperature<br>vs Supply voltage                                   | 20, 21<br>22                        |
| $V_{O(PP)}$    | Maximum peak-to-peak output voltage               | vs Frequency   | 23                                  |
| $V_O$          | Output voltage                                    | vs Settling time   | 24                                  |
| $A_{VD}$       | Large-signal differential voltage amplification   | vs Load resistance<br>vs Free-air temperature                                  | 25<br>26, 27                        |
| $A_{VD}$       | Small-signal differential voltage amplification   | vs Frequency   | 28, 29                              |
| CMRR           | Common-mode rejection ratio                       | vs Frequency<br>vs Free-air temperature  | 30<br>31                            |
| $k_{SVR}$      | Supply-voltage rejection ratio                    | vs Frequency<br>vs Free-air temperature  | 32<br>33                            |
| $I_{CC}$       | Supply current                                    | vs Supply voltage<br>vs Free-air temperature<br>vs Differential input voltage  | 34, 35, 36<br>37, 38, 39<br>40 – 45 |
| $I_{OS}$       | Short-circuit output current                      | vs Supply voltage<br>vs Elapsed time<br>vs Free-air temperature                | 46<br>47<br>48                      |
| SR             | Slew rate   | vs Free-air temperature<br>vs Load resistance<br>vs Differential input voltage | 49, 50<br>51<br>52                  |
| $V_n$          | Equivalent Input noise voltage (spectral density) | vs Frequency   | 53                                  |
| $V_n$          | Input referred noise voltage                      | vs Noise bandwidth<br>Over a 10-second time interval                           | 54<br>55                            |
|                | Third-octave spectral noise density               | vs Frequency bands   | 56                                  |
| THD + N        | Total harmonic distortion plus noise              | vs Frequency   | 57, 58                              |
| $B_1$          | Unity-gain bandwidth                              | vs Load capacitance  | 59                                  |
|                | Gain-bandwidth product                            | vs Free-air temperature<br>vs Supply voltage                                   | 60<br>61                            |
|                | Gain margin                                       | vs Load capacitance  | 62                                  |
| $\phi_m$       | Phase margin                                      | vs Free-air temperature<br>vs Supply voltage<br>vs Load capacitance            | 63<br>64<br>65                      |
|                | Phase shift                                       | vs Frequency   | 28, 29                              |
|                | Noninverting large-signal pulse response          | vs Time  | 66                                  |
|                | Small-signal pulse response                       | vs Time  | 67                                  |
| $z_o$          | Closed-loop output impedance                      | vs Frequency   | 68                                  |
|                | Crosstalk attenuation                             | vs Frequency   | 69                                  |





**TYPICAL CHARACTERISTICS**

**DISTRIBUTION OF TLE2071  
 INPUT OFFSET VOLTAGE**



**Figure 6**

**DISTRIBUTION OF TLE2072  
 INPUT OFFSET VOLTAGE**



**Figure 7**

**DISTRIBUTION OF TLE2074  
 INPUT OFFSET VOLTAGE**

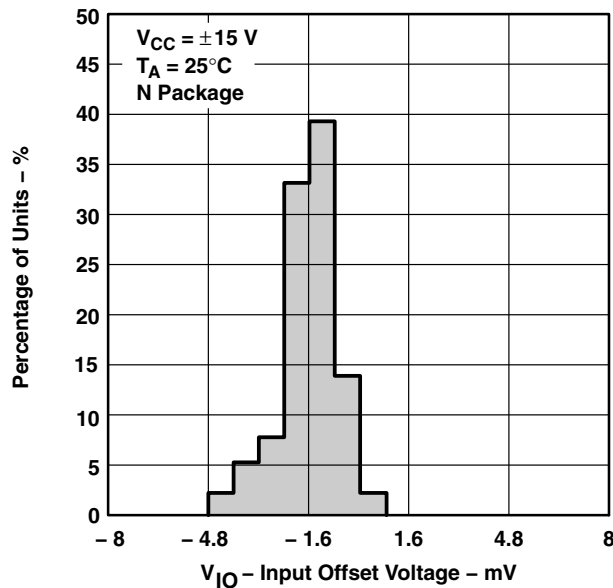

**Figure 8**

**DISTRIBUTION OF TLE2071 INPUT OFFSET  
 VOLTAGE TEMPERATURE COEFFICIENT**

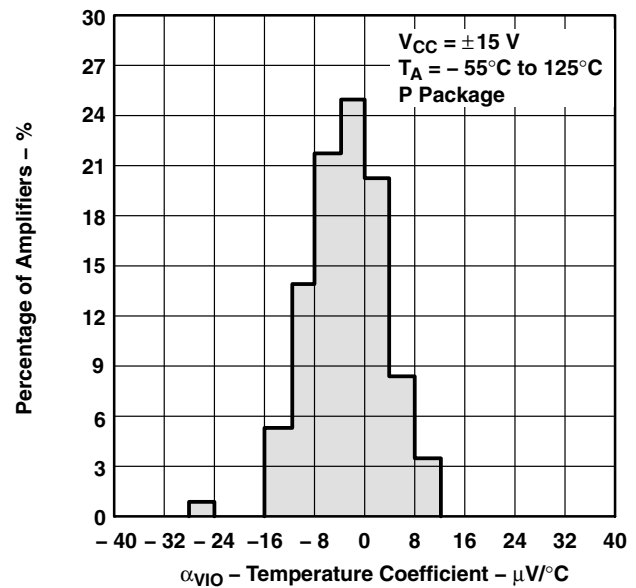

**Figure 9**

# TLE207x, TLE207xA EXCALIBUR LOW-NOISE HIGH-SPEED JFET-INPUT OPERATIONAL AMPLIFIERS

SLOS181C – FEBRUARY 1997 – REVISED DECEMBER 2009

## TYPICAL CHARACTERISTICS

**DISTRIBUTION OF TLE2072 INPUT OFFSET  
VOLTAGE TEMPERATURE COEFFICIENT**



**Figure 10**

**DISTRIBUTION OF TLE2074 INPUT OFFSET  
VOLTAGE TEMPERATURE COEFFICIENT**



**Figure 11**

**INPUT BIAS CURRENT AND  
INPUT OFFSET CURRENT†  
vs  
FREE-AIR TEMPERATURE**



**Figure 12**

**INPUT BIAS CURRENT AND  
INPUT OFFSET CURRENT†  
vs  
FREE-AIR TEMPERATURE**



**Figure 13**

† Data at high and low temperatures are applicable only within the rated operating free-air temperature ranges of the various devices.

**TYPICAL CHARACTERISTICS**

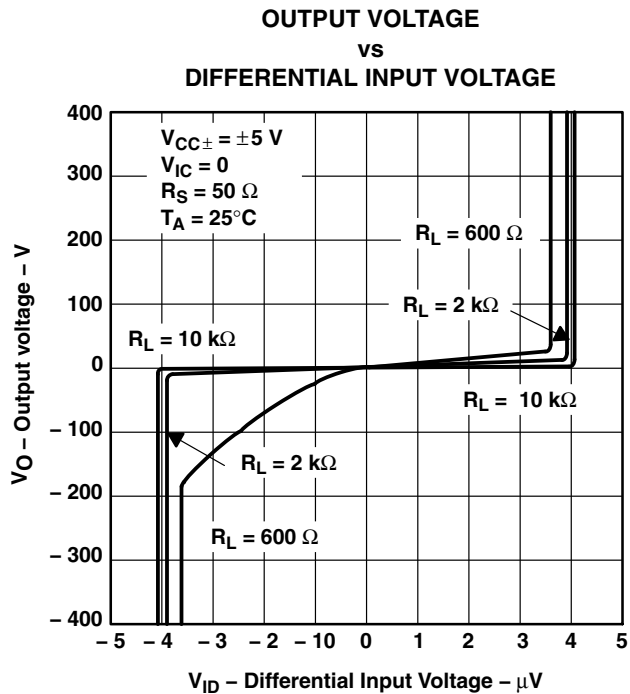
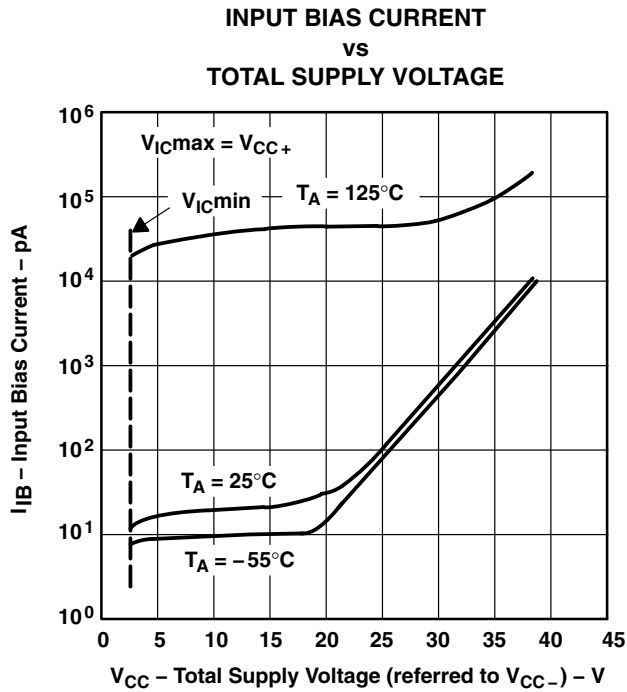

† Data at high and low temperatures are applicable only within the rated operating free-air temperature ranges of the various devices.

**TLE207x, TLE207xA**  
**EXCALIBUR LOW-NOISE HIGH-SPEED**  
**JFET-INPUT OPERATIONAL AMPLIFIERS**

SLOS181C – FEBRUARY 1997 – REVISED DECEMBER 2009

**TYPICAL CHARACTERISTICS**

**MAXIMUM POSITIVE PEAK OUTPUT VOLTAGE†**  
**vs**  
**OUTPUT CURRENT**



**Figure 18**

**MAXIMUM NEGATIVE PEAK OUTPUT VOLTAGE†**  
**vs**  
**OUTPUT CURRENT**



**Figure 19**

**MAXIMUM PEAK OUTPUT VOLTAGE†**  
**vs**  
**FREE-AIR TEMPERATURE**



**Figure 20**

**MAXIMUM PEAK OUTPUT VOLTAGE†**  
**vs**  
**FREE-AIR TEMPERATURE**



**Figure 21**

† Data at high and low temperatures are applicable only within the rated operating free-air temperature ranges of the various devices.

**TYPICAL CHARACTERISTICS**

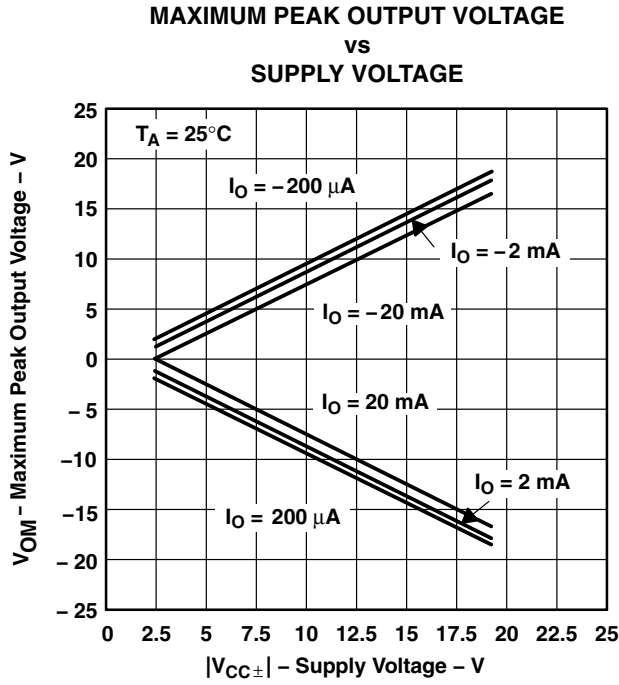

Figure 22

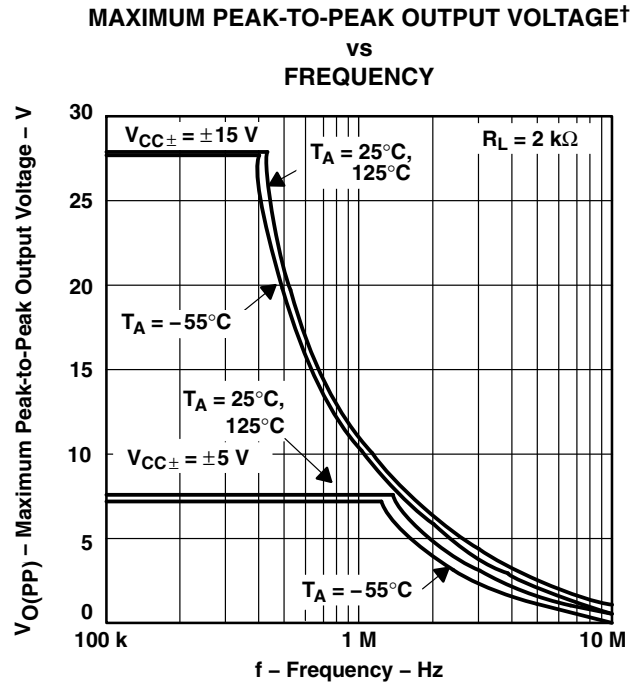

Figure 23

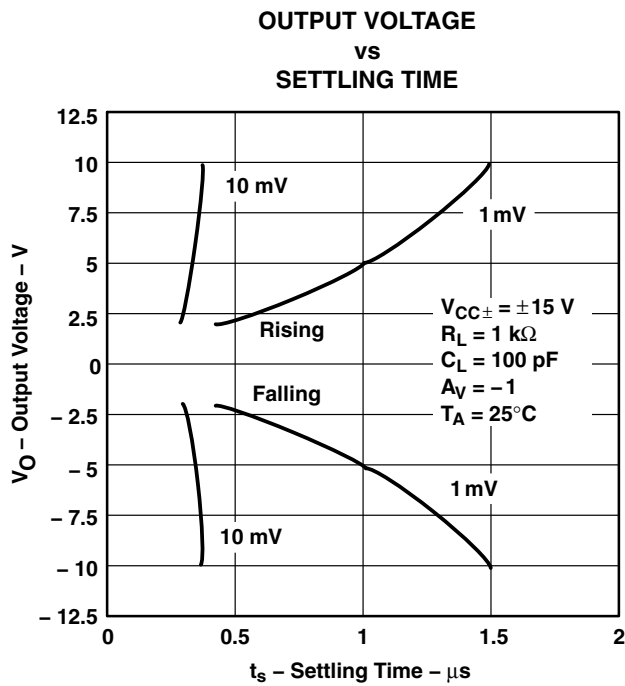

Figure 24

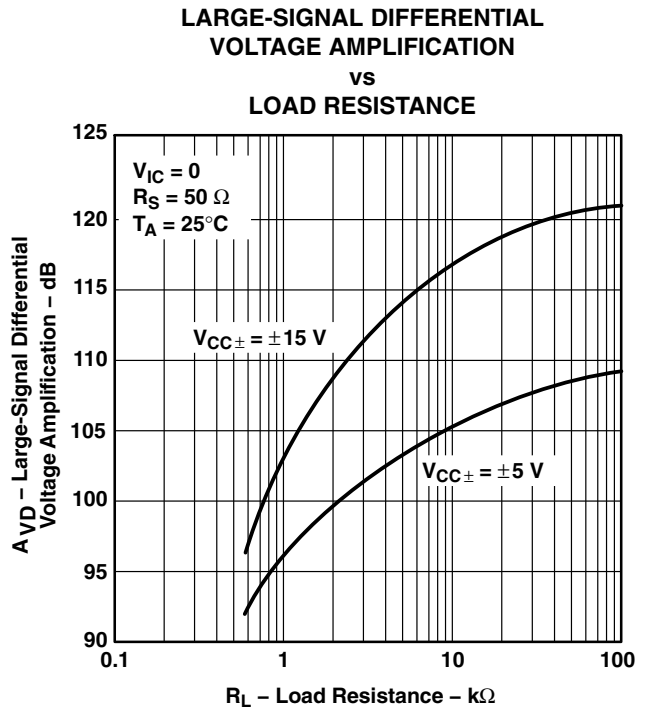

Figure 25

† Data at high and low temperatures are applicable only within the rated operating free-air temperature ranges of the various devices.

**TLE207x, TLE207xA**  
**EXCALIBUR LOW-NOISE HIGH-SPEED**  
**JFET-INPUT OPERATIONAL AMPLIFIERS**

SLOS181C – FEBRUARY 1997 – REVISED DECEMBER 2009

**TYPICAL CHARACTERISTICS**

**LARGE-SIGNAL DIFFERENTIAL  
 VOLTAGE AMPLIFICATION†**  
 vs  
**FREE-AIR TEMPERATURE**



**Figure 26**

**LARGE-SIGNAL DIFFERENTIAL  
 VOLTAGE AMPLIFICATION†**  
 vs  
**FREE-AIR TEMPERATURE**

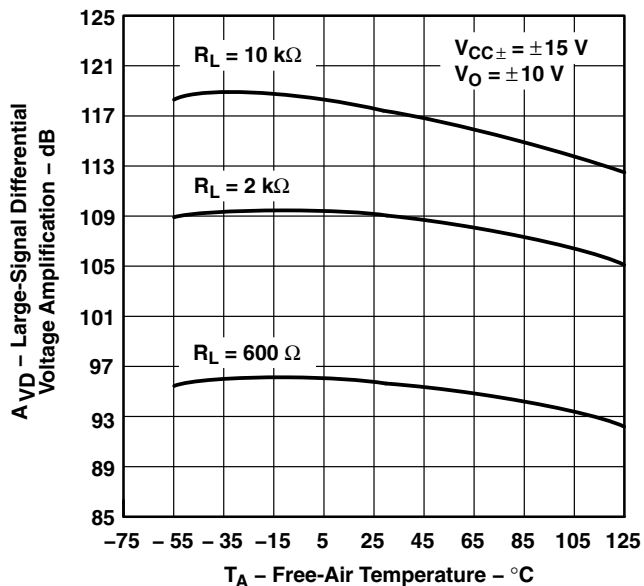

**Figure 27**

† Data at high and low temperatures are applicable only within the rated operating free-air temperature ranges of the various devices.



**TYPICAL CHARACTERISTICS**

**SMALL-SIGNAL DIFFERENTIAL VOLTAGE  
 AMPLIFICATION AND PHASE SHIFT**

vs  
**FREQUENCY**

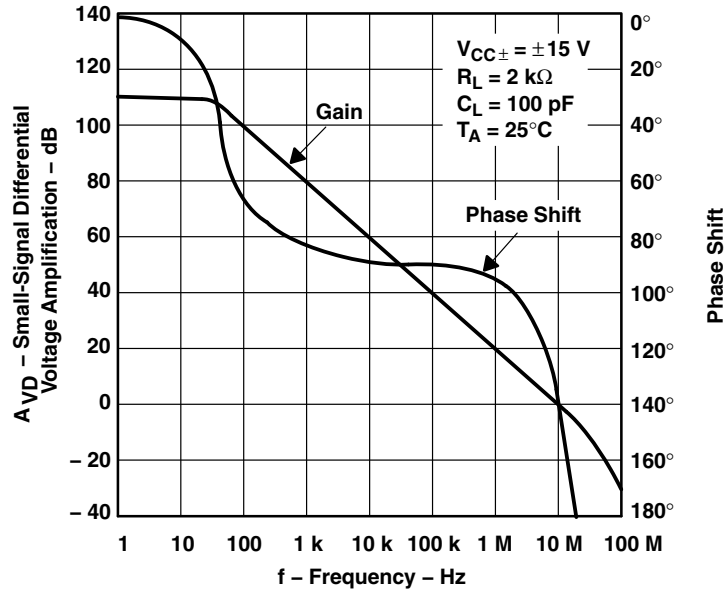

**Figure 28**

**SMALL-SIGNAL DIFFERENTIAL VOLTAGE  
 AMPLIFICATION AND PHASE SHIFT**

vs  
**FREQUENCY**

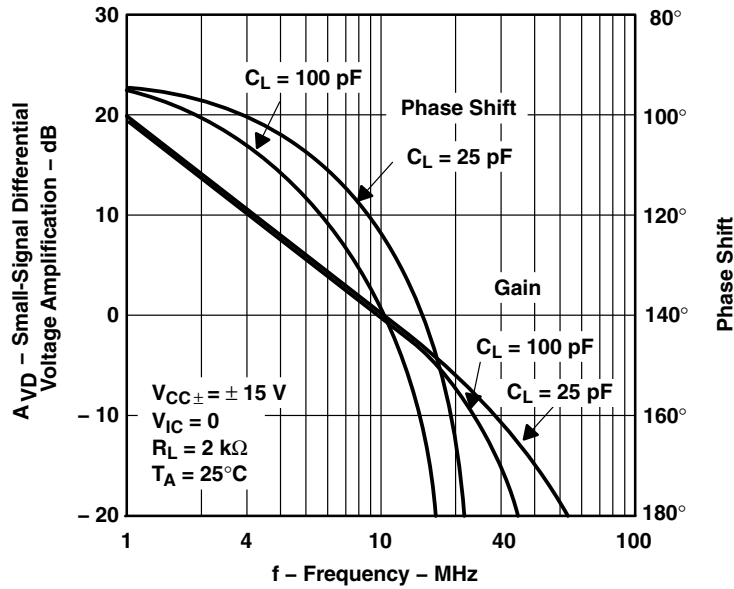

**Figure 29**

# TLE207x, TLE207xA EXCALIBUR LOW-NOISE HIGH-SPEED JFET-INPUT OPERATIONAL AMPLIFIERS

SLOS181C – FEBRUARY 1997 – REVISED DECEMBER 2009

## TYPICAL CHARACTERISTICS



Figure 30



Figure 31



Figure 32

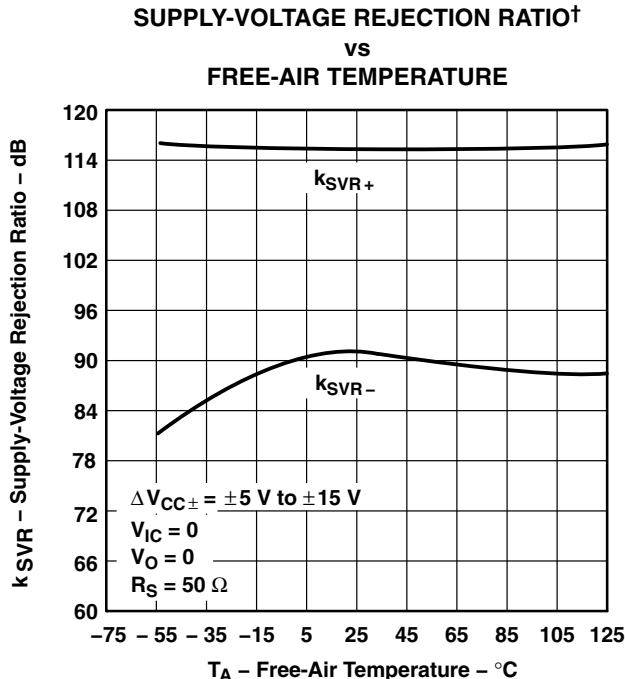
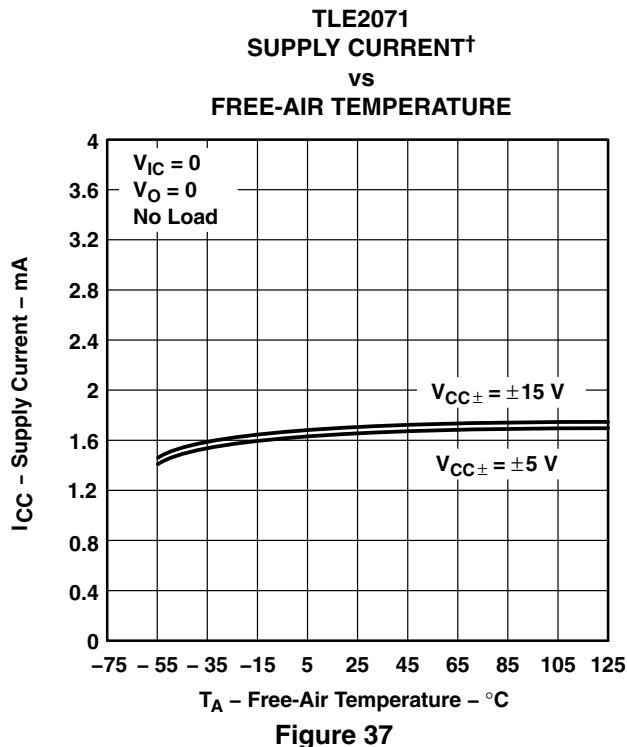
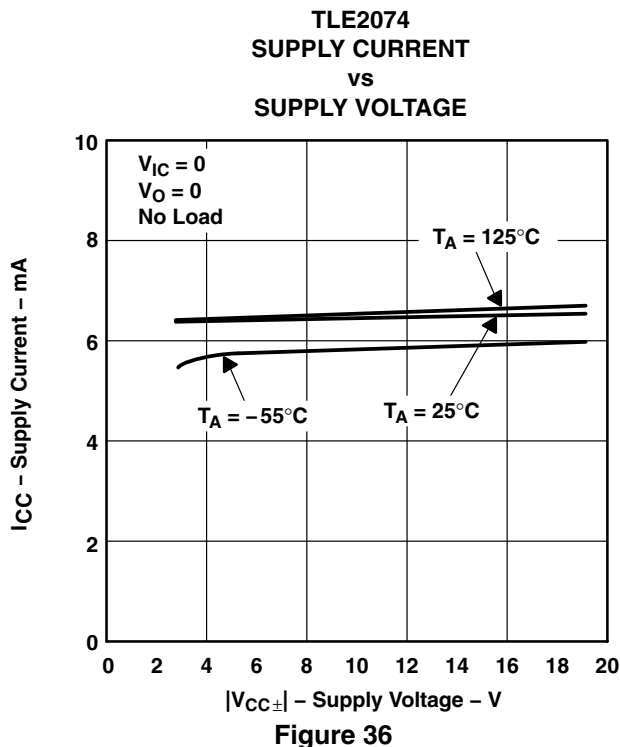
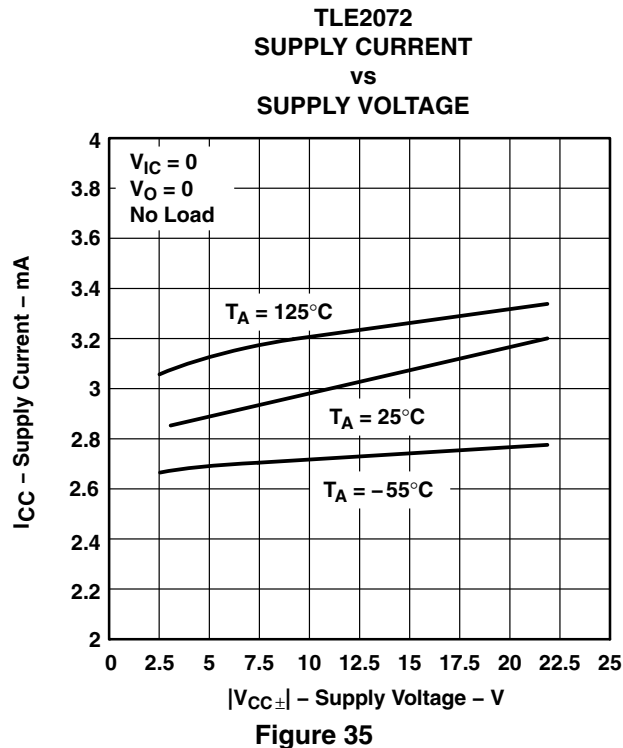
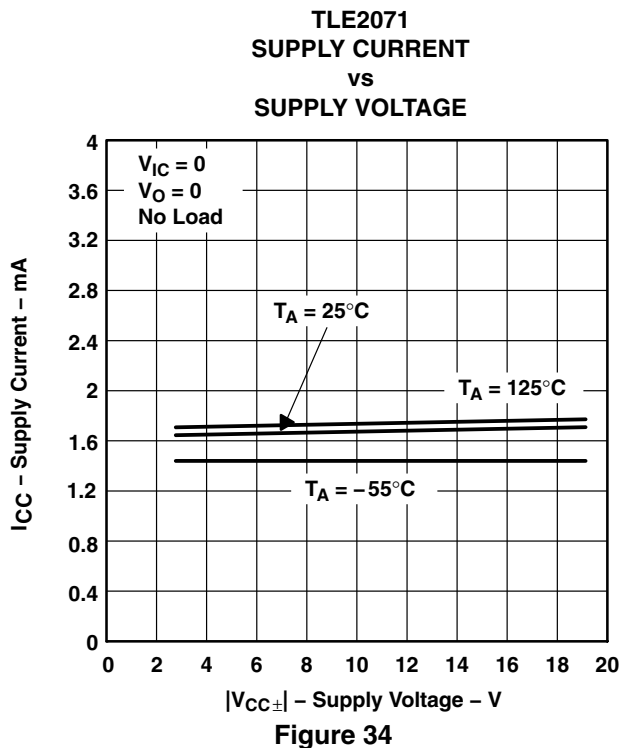

Figure 33

† Data at high and low temperatures are applicable only within the rated operating free-air temperature ranges of the various devices.



TYPICAL CHARACTERISTICS



† Data at high and low temperatures are applicable only within the rated operating free-air temperature ranges of the various devices.

# TLE207x, TLE207xA EXCALIBUR LOW-NOISE HIGH-SPEED JFET-INPUT OPERATIONAL AMPLIFIERS

SLOS181C – FEBRUARY 1997 – REVISED DECEMBER 2009

## TYPICAL CHARACTERISTICS



Figure 38

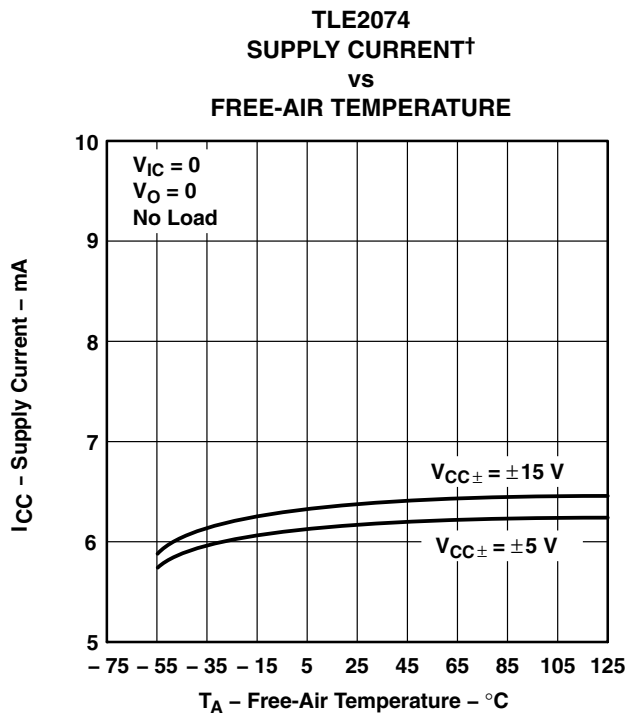

Figure 39

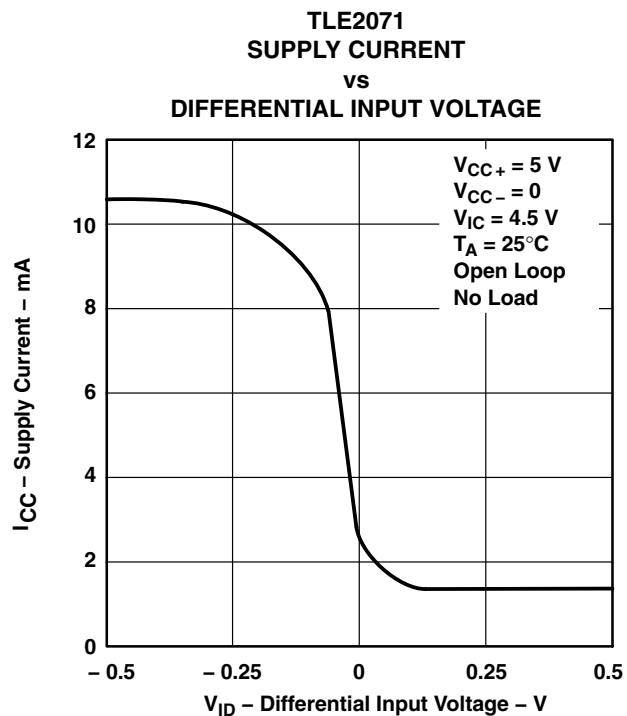

Figure 40

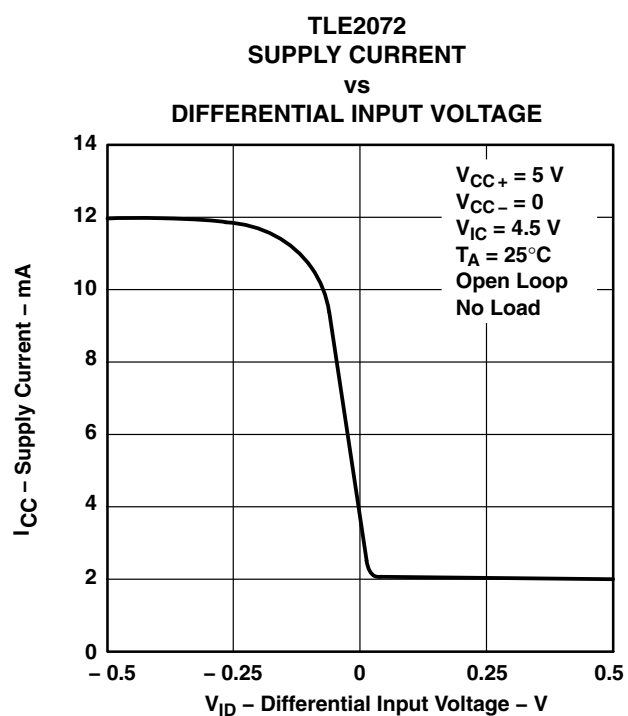
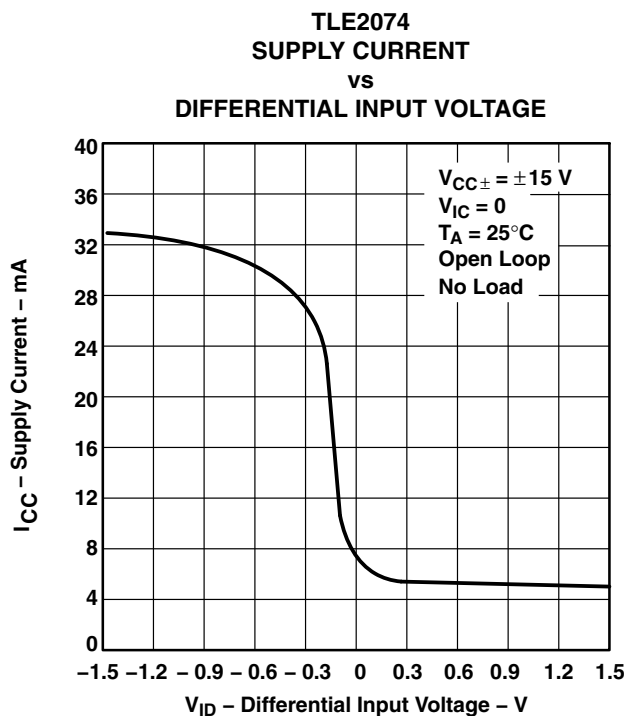
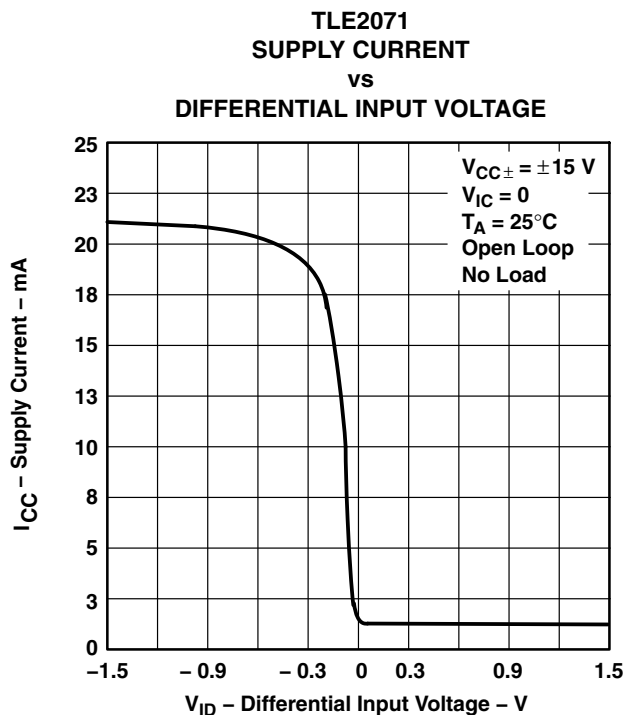

Figure 41

† Data at high and low temperatures are applicable only within the rated operating free-air temperature ranges of the various devices.

TYPICAL CHARACTERISTICS



# TLE207x, TLE207xA EXCALIBUR LOW-NOISE HIGH-SPEED JFET-INPUT OPERATIONAL AMPLIFIERS

SLOS181C – FEBRUARY 1997 – REVISED DECEMBER 2009

## TYPICAL CHARACTERISTICS

SHORT-CIRCUIT OUTPUT CURRENT  
vs  
SUPPLY VOLTAGE



Figure 46

SHORT-CIRCUIT OUTPUT CURRENT  
vs  
ELAPSED TIME



Figure 47

SHORT-CIRCUIT OUTPUT CURRENT†  
vs  
FREE-AIR TEMPERATURE



Figure 48

SLEW RATE†  
vs  
FREE-AIR TEMPERATURE



Figure 49

† Data at high and low temperatures are applicable only within the rated operating free-air temperature ranges of the various devices.

**TYPICAL CHARACTERISTICS**



**Figure 50**

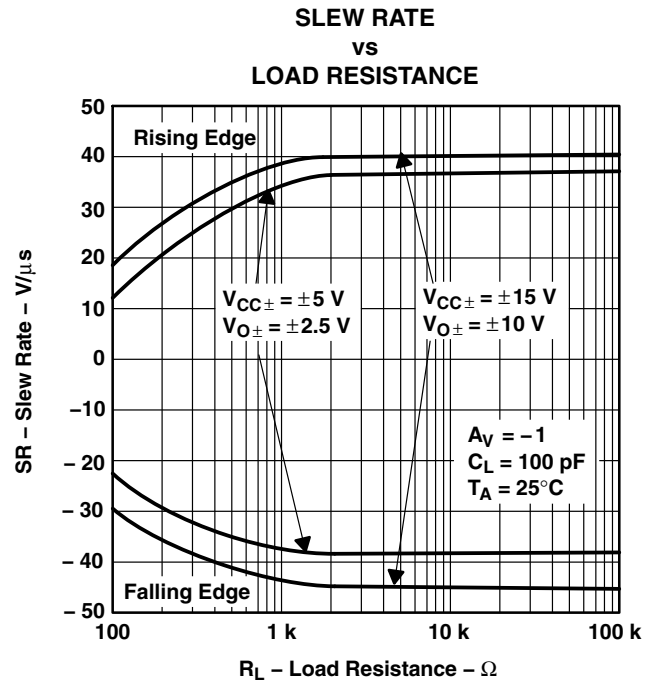

**Figure 51**



**Figure 52**

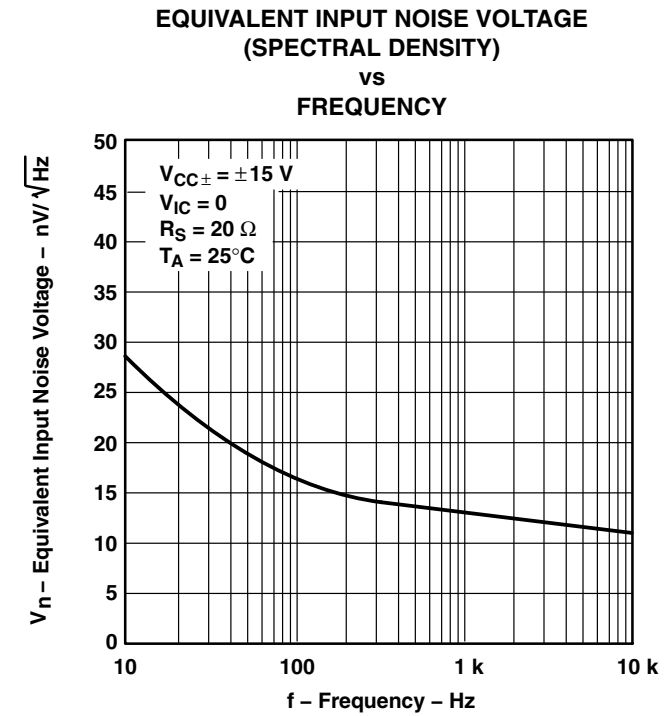

**Figure 53**

† Data at high and low temperatures are applicable only within the rated operating free-air temperature ranges of the various devices.

# TLE207x, TLE207xA EXCALIBUR LOW-NOISE HIGH-SPEED JFET-INPUT OPERATIONAL AMPLIFIERS

SLOS181C – FEBRUARY 1997 – REVISED DECEMBER 2009

## TYPICAL CHARACTERISTICS

INPUT-REFERRED NOISE VOLTAGE  
vs  
NOISE BANDWIDTH



Figure 54

INPUT-REFERRED NOISE VOLTAGE  
OVER A 10-SECOND TIME INTERVAL



Figure 55

THIRD-OCTAVE SPECTRAL NOISE DENSITY  
vs  
FREQUENCY BANDS



Figure 56

TOTAL HARMONIC DISTORTION PLUS NOISE  
vs  
FREQUENCY



Figure 57

**TYPICAL CHARACTERISTICS**

**TOTAL HARMONIC DISTORTION PLUS NOISE  
 vs  
 FREQUENCY**



**Figure 58**

**UNITY-GAIN BANDWIDTH  
 vs  
 LOAD CAPACITANCE**



**Figure 59**

**GAIN-BANDWIDTH PRODUCT†  
 vs  
 FREE-AIR TEMPERATURE**



**Figure 60**

**GAIN-BANDWIDTH PRODUCT  
 vs  
 SUPPLY VOLTAGE**



**Figure 61**

† Data at high and low temperatures are applicable only within the rated operating free-air temperature ranges of the various devices.

**TLE207x, TLE207xA**  
**EXCALIBUR LOW-NOISE HIGH-SPEED**  
**JFET-INPUT OPERATIONAL AMPLIFIERS**

SLOS181C – FEBRUARY 1997 – REVISED DECEMBER 2009

**TYPICAL CHARACTERISTICS**

**GAIN MARGIN**  
**vs**  
**LOAD CAPACITANCE**

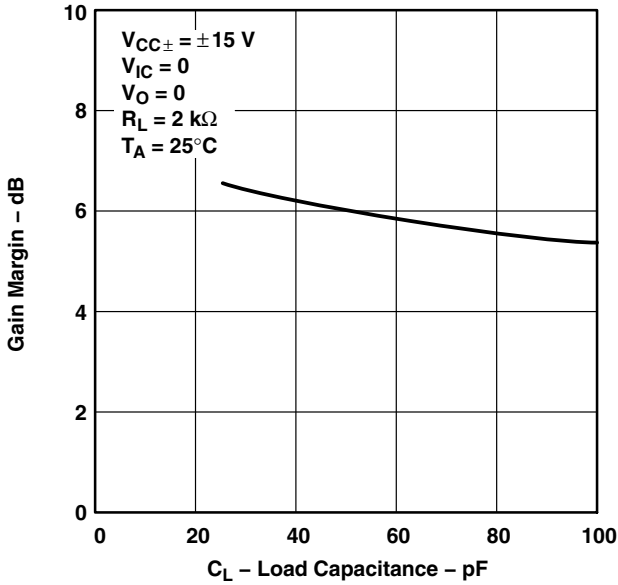

**Figure 62**

**PHASE MARGIN†**  
**vs**  
**FREE-AIR TEMPERATURE**

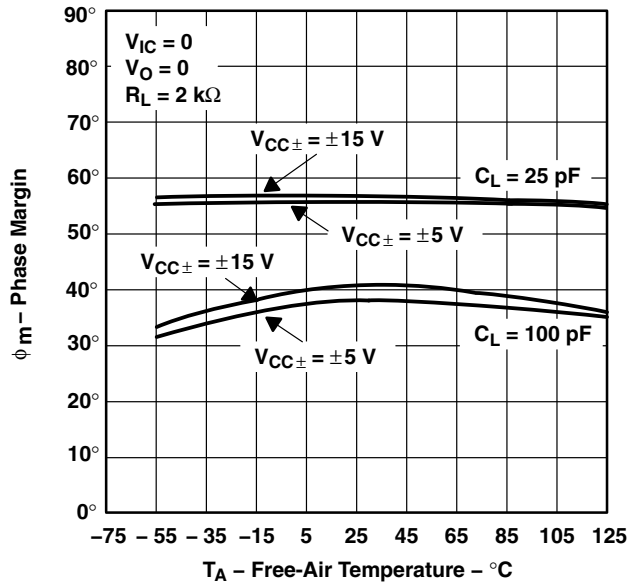

**Figure 63**

**PHASE MARGIN**  
**vs**  
**SUPPLY VOLTAGE**

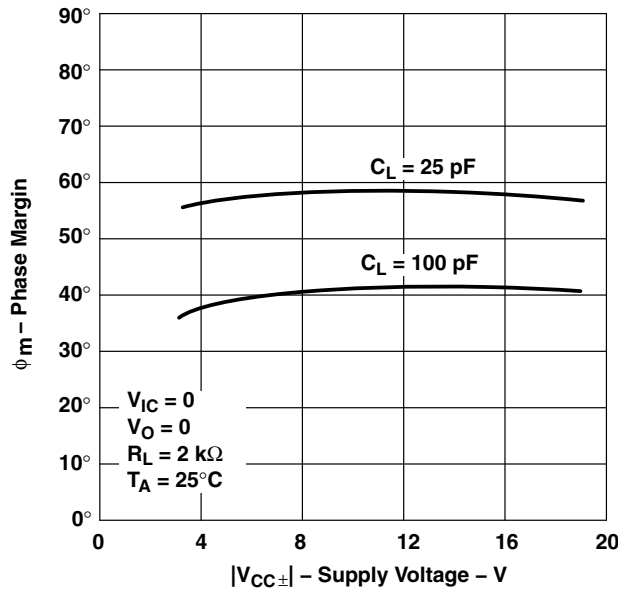

**Figure 64**

**PHASE MARGIN**  
**vs**  
**LOAD CAPACITANCE**

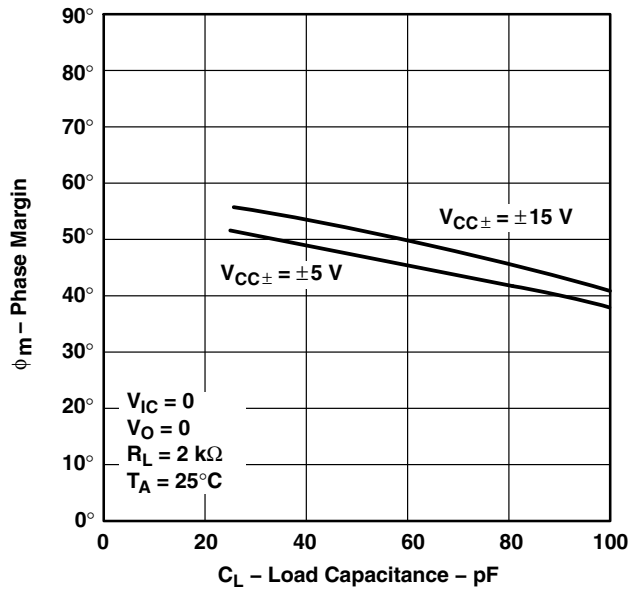

**Figure 65**

† Data at high and low temperatures are applicable only within the rated operating free-air temperature ranges of the various devices.



**TYPICAL CHARACTERISTICS**

**NONINVERTING LARGE-SIGNAL  
 PULSE RESPONSE†**



**Figure 66**

**SMALL-SIGNAL PULSE RESPONSE**



**Figure 67**

**CLOSED-LOOP OUTPUT IMPEDANCE  
 vs  
 FREQUENCY**



**Figure 68**

**TLE2072 AND TLE2074  
 CROSSTALK ATTENUATION  
 vs  
 FREQUENCY**



**Figure 69**

† Data at high and low temperatures are applicable only within the rated operating free-air temperature ranges of the various devices.

# TLE207x, TLE207xA EXCALIBUR LOW-NOISE HIGH-SPEED JFET-INPUT OPERATIONAL AMPLIFIERS

SLOS181C – FEBRUARY 1997 – REVISED DECEMBER 2009

## APPLICATION INFORMATION

### input characteristics

The TLE207x, TLE207xA, and TLE207xB are specified with a minimum and a maximum input voltage that if exceeded at either input could cause the device to malfunction. Because of the extremely high input impedance and resulting low bias current requirements, the TLE207x, TLE207xA, and TLE207xB are well suited for low-level signal processing; however, leakage currents on printed-circuit boards and sockets can easily exceed bias current requirements and cause degradation in system performance. It is good practice to include guard rings around inputs (see Figure 70). These guards should be driven from a low-impedance source at the same voltage level as the common-mode input.

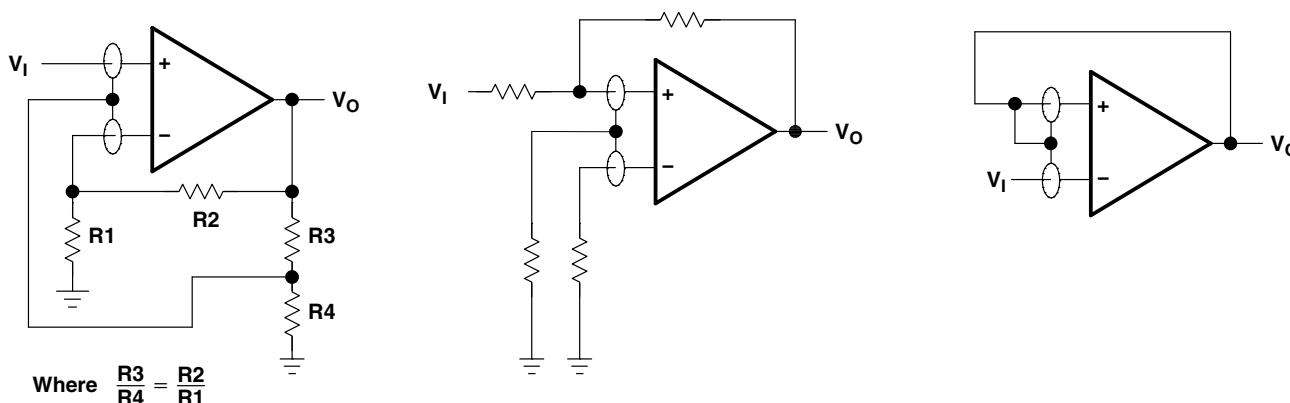

Figure 70. Use of Guard Rings

### TLE2071 input offset voltage nulling

The TLE2071 series offers external null pins that can be used to further reduce the input offset voltage. The circuit of Figure 71 can be connected as shown if the feature is desired. When external nulling is not needed, the null pins may be left unconnected.



Figure 71. Input Offset Voltage Nulling

## APPLICATION INFORMATION

### macromodel information

Macromodel information provided was derived using *PSpice™ Parts™* model generation software. The Boyle macromodel (see Note 4) and subcircuit Figure 72 were generated using the TLE207x typical electrical and operating characteristics at  $T_A = 25^\circ\text{C}$ . Using this information, output simulations of the following key parameters can be generated to a tolerance of 20% (in most cases):

- Maximum positive output voltage swing
- Maximum negative output voltage swing
- Slew rate
- Quiescent power dissipation
- Input bias current
- Open-loop voltage amplification
- Unity-gain frequency
- Common-mode rejection ratio
- Phase margin
- DC output resistance
- AC output resistance
- Short-circuit output current limit

NOTE 4: G.R. Boyle, B.M. Cohn, D. O. Pederson, and J. E. Solomon, "Macromodeling of Integrated Circuit Operational Amplifiers", *IEEE Journal of Solid-State Circuits*, SC-9, 353 (1974).

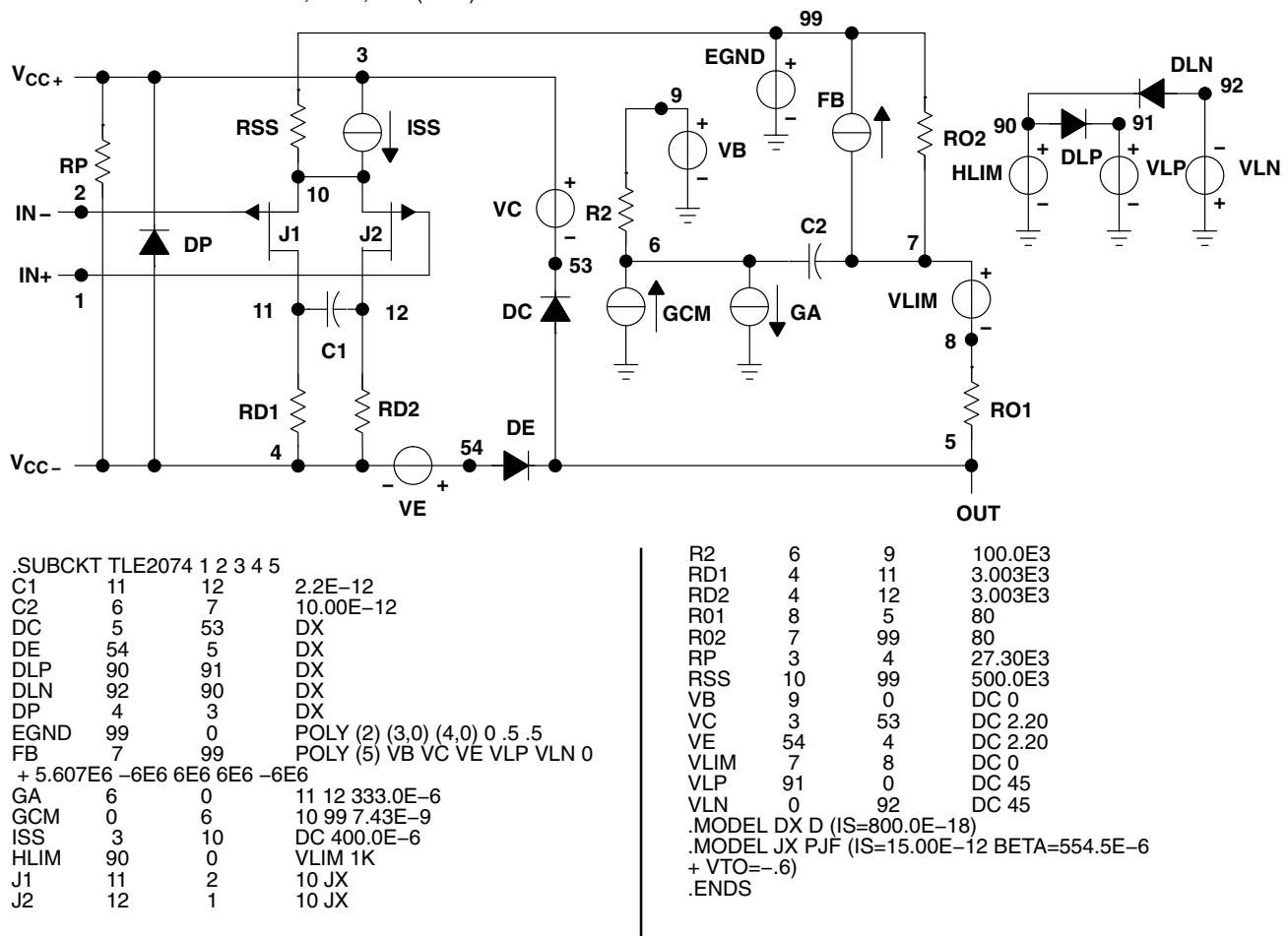

**Figure 72. Boyle Macromodel and Subcircuit**

*PSpice* and *Parts* are trademarks of MicroSim Corporation.

# TLE207x, TLE207xA EXCALIBUR LOW-NOISE HIGH-SPEED JFET-INPUT OPERATIONAL AMPLIFIERS

SLOS181C – FEBRUARY 1997 – REVISED DECEMBER 2009

---

## Revision History

| Version | Date     | Changes  |
|---------|----------|--|
| C       | Dec-2009 | <ul style="list-style-type: none"><li>– For TLE2071M/1AM (VCC <math>\pm 5V</math>) changed <math>V_n</math> NOM &amp; MAX from 28/55 to 48/85 (f = 10 Hz); 11.6/17 to 12/17 (f = 10 KHz), Pg. 16</li><li>– For TLE2071M/1AM (VCC <math>\pm 15V</math>) changed <math>V_n</math> NOM &amp; MAX from 28/55 to 48/85 (f = 10 Hz); 11.6/17 to 12/17 (f = 10 KHz), Pg. 18</li><li>– For TLE2072M/2AM (VCC <math>\pm 5V</math>) changed <math>V_n</math> NOM &amp; MAX from 28/55 to 48/85 (f = 10 Hz); 11.6/17 to 12/17 (f = 10 KHz), Pg. 29</li><li>– For TLE2072M/2AM (VCC <math>\pm 15V</math>) changed <math>V_n</math> NOM &amp; MAX from 28/55 to 48/85 (f = 10 Hz); 11.6/17 to 12/17 (f = 10 KHz), Pg. 31</li><li>– For TLE2074M/4AM (VCC <math>\pm 5V</math>) changed <math>V_n</math> NOM &amp; MAX from 28/55 to 48/85 (f = 10 Hz); 11.6/17 to 12/17 (f = 10 KHz), Pg. 42</li><li>– For TLE2074M/4AM (VCC <math>\pm 15V</math>) changed <math>V_n</math> NOM &amp; MAX from 28/55 to 48/85 (f = 10 Hz); 11.6/17 to 12/17 (f = 10 KHz), Pg. 44</li></ul> |



**PACKAGING INFORMATION**

| Orderable Device | Status<br>(1) | Package Type | Package Drawing | Pins | Package Qty | Eco Plan<br>(2)     | Lead finish/<br>Ball material<br>(6) | MSL Peak Temp<br>(3) | Op Temp (°C) | Device Marking<br>(4/5)                 | Samples                 |
|------------------|---------------|--------------|-----------------|------|-------------|---------------------|--------------------------------------|----------------------|--------------|---|-------------------------|
| 5962-9460201Q2A  | ACTIVE        | LCCC         | FK              | 20   | 55          | Non-RoHS<br>& Green | SNPB                                 | N / A for Pkg Type   | -55 to 125   | 5962-<br>9460201Q2A<br>TLE2071<br>MFKB  | <a href="#">Samples</a> |
| 5962-9460201QPA  | ACTIVE        | CDIP         | JG              | 8    | 50          | Non-RoHS<br>& Green | SNPB                                 | N / A for Pkg Type   | -55 to 125   | 9460201QPA<br>TLE2071M                  | <a href="#">Samples</a> |
| 5962-9460202Q2A  | ACTIVE        | LCCC         | FK              | 20   | 55          | Non-RoHS<br>& Green | SNPB                                 | N / A for Pkg Type   | -55 to 125   | 5962-<br>9460202Q2A<br>TLE2072<br>MFKB  | <a href="#">Samples</a> |
| 5962-9460202QHA  | ACTIVE        | CFP          | U               | 10   | 25          | Non-RoHS<br>& Green | SNPB                                 | N / A for Pkg Type   | -55 to 125   | 9460202QHA<br>TLE2072M                  | <a href="#">Samples</a> |
| 5962-9460202QPA  | ACTIVE        | CDIP         | JG              | 8    | 50          | Non-RoHS<br>& Green | SNPB                                 | N / A for Pkg Type   | -55 to 125   | 9460202QPA<br>TLE2072M                  | <a href="#">Samples</a> |
| 5962-9460203Q2A  | ACTIVE        | LCCC         | FK              | 20   | 55          | Non-RoHS<br>& Green | SNPB                                 | N / A for Pkg Type   | -55 to 125   | 5962-<br>9460203Q2A<br>TLE2074<br>MFKB  | <a href="#">Samples</a> |
| 5962-9460203QCA  | ACTIVE        | CDIP         | J               | 14   | 25          | Non-RoHS<br>& Green | SNPB                                 | N / A for Pkg Type   | -55 to 125   | 5962-9460203QC<br>A<br>TLE2074MJB       | <a href="#">Samples</a> |
| 5962-9460204Q2A  | ACTIVE        | LCCC         | FK              | 20   | 55          | Non-RoHS<br>& Green | SNPB                                 | N / A for Pkg Type   | -55 to 125   | 5962<br>9460204Q2A<br>TLE2071<br>AMFKB  | <a href="#">Samples</a> |
| 5962-9460204QHA  | ACTIVE        | CFP          | U               | 10   | 25          | Non-RoHS<br>& Green | SNPB                                 | N / A for Pkg Type   | -55 to 125   | 9460204QHA<br>TLE2071AM                 | <a href="#">Samples</a> |
| 5962-9460204QPA  | ACTIVE        | CDIP         | JG              | 8    | 50          | Non-RoHS<br>& Green | SNPB                                 | N / A for Pkg Type   | -55 to 125   | 9460204QPA<br>TLE2071AM                 | <a href="#">Samples</a> |
| 5962-9460205Q2A  | ACTIVE        | LCCC         | FK              | 20   | 55          | Non-RoHS<br>& Green | SNPB                                 | N / A for Pkg Type   | -55 to 125   | 5962-<br>9460205Q2A<br>TLE2072<br>AMFKB | <a href="#">Samples</a> |
| 5962-9460205QHA  | ACTIVE        | CFP          | U               | 10   | 25          | Non-RoHS<br>& Green | SNPB                                 | N / A for Pkg Type   | -55 to 125   | 9460205QHA<br>TLE2072AM                 | <a href="#">Samples</a> |

| Orderable Device | Status<br>(1) | Package Type | Package Drawing | Pins | Package Qty | Eco Plan<br>(2)      | Lead finish/<br>Ball material<br>(6) | MSL Peak Temp<br>(3) | Op Temp (°C) | Device Marking<br>(4/5)                 | Samples                 |
|------------------|---------------|--------------|-----------------|------|-------------|----------------------|--------------------------------------|----------------------|--------------|---|-------------------------|
| 5962-9460205QPA  | ACTIVE        | CDIP         | JG              | 8    | 50          | Non-RoHS & Green     | SNPB                                 | N / A for Pkg Type   | -55 to 125   | 9460205QPA<br>TLE2072AM                 | <a href="#">Samples</a> |
| 5962-9460206Q2A  | ACTIVE        | LCCC         | FK              | 20   | 55          | Non-RoHS & Green     | SNPB                                 | N / A for Pkg Type   | -55 to 125   | 5962-<br>9460206Q2A<br>TLE2074<br>AMFKB | <a href="#">Samples</a> |
| 5962-9460206QCA  | ACTIVE        | CDIP         | J               | 14   | 25          | Non-RoHS & Green     | SNPB                                 | N / A for Pkg Type   | -55 to 125   | 5962-9460206QC<br>A<br>TLE2074AMJB      | <a href="#">Samples</a> |
| 5962-9460206QDA  | ACTIVE        | CFP          | W               | 14   | 25          | Non-RoHS & Non-Green | SNPB                                 | N / A for Pkg Type   | -55 to 125   | 5962-9460206QD<br>A<br>TLE2074AMWB      | <a href="#">Samples</a> |
| TLE2071ACD       | OBSOLETE      | SOIC         | D               | 8    |             | TBD                  | Call TI                              | Call TI              | 0 to 70      | 2071AC                                  |                         |
| TLE2071ACDR      | ACTIVE        | SOIC         | D               | 8    | 2500        | RoHS & Green         | NIPDAU                               | Level-1-260C-UNLIM   |              | 2071AC                                  | <a href="#">Samples</a> |
| TLE2071ACP       | ACTIVE        | PDIP         | P               | 8    | 50          | RoHS & Green         | NIPDAU                               | N / A for Pkg Type   |              | TLE2071AC                               | <a href="#">Samples</a> |
| TLE2071AID       | OBSOLETE      | SOIC         | D               | 8    |             | TBD                  | Call TI                              | Call TI              | -40 to 85    | 2071AI                                  |                         |
| TLE2071AIDR      | ACTIVE        | SOIC         | D               | 8    | 2500        | RoHS & Green         | NIPDAU                               | Level-1-260C-UNLIM   |              | 2071AI                                  | <a href="#">Samples</a> |
| TLE2071AIP       | ACTIVE        | PDIP         | P               | 8    | 50          | RoHS & Green         | NIPDAU                               | N / A for Pkg Type   |              | TLE2071AI                               | <a href="#">Samples</a> |
| TLE2071AMFKB     | ACTIVE        | LCCC         | FK              | 20   | 55          | Non-RoHS & Green     | SNPB                                 | N / A for Pkg Type   | -55 to 125   | 5962<br>9460204Q2A<br>TLE2071<br>AMFKB  | <a href="#">Samples</a> |
| TLE2071AMJG      | ACTIVE        | CDIP         | JG              | 8    | 50          | Non-RoHS & Green     | SNPB                                 | N / A for Pkg Type   | -55 to 125   | TLE2071<br>AMJG                         | <a href="#">Samples</a> |
| TLE2071AMJGB     | ACTIVE        | CDIP         | JG              | 8    | 50          | Non-RoHS & Green     | SNPB                                 | N / A for Pkg Type   | -55 to 125   | 9460204QPA<br>TLE2071AM                 | <a href="#">Samples</a> |
| TLE2071AMUB      | ACTIVE        | CFP          | U               | 10   | 25          | Non-RoHS & Green     | SNPB                                 | N / A for Pkg Type   | -55 to 125   | 9460204QHA<br>TLE2071AM                 | <a href="#">Samples</a> |
| TLE2071CD        | OBSOLETE      | SOIC         | D               | 8    |             | TBD                  | Call TI                              | Call TI              | 0 to 70      | 2071C                                   |                         |
| TLE2071CP        | ACTIVE        | PDIP         | P               | 8    | 50          | RoHS & Green         | NIPDAU                               | N / A for Pkg Type   |              | TLE2071CP                               | <a href="#">Samples</a> |
| TLE2071CPE4      | ACTIVE        | PDIP         | P               | 8    | 50          | TBD                  | Call TI                              | Call TI              |              |   | <a href="#">Samples</a> |
| TLE2071ID        | OBSOLETE      | SOIC         | D               | 8    |             | TBD                  | Call TI                              | Call TI              | -40 to 85    | 2071I                                   |                         |

| Orderable Device | Status<br>(1) | Package Type | Package Drawing | Pins | Package Qty | Eco Plan<br>(2)  | Lead finish/<br>Ball material<br>(6) | MSL Peak Temp<br>(3) | Op Temp (°C) | Device Marking<br>(4/5)             | Samples                 |
|------------------|---------------|--------------|-----------------|------|-------------|------------------|--------------------------------------|----------------------|--------------|-------------------------------------|-------------------------|
| TLE2071IDR       | ACTIVE        | SOIC         | D               | 8    | 2500        | RoHS & Green     | NIPDAU                               | Level-1-260C-UNLIM   |              | 2071I                               | <a href="#">Samples</a> |
| TLE2071IP        | ACTIVE        | PDIP         | P               | 8    | 50          | RoHS & Green     | NIPDAU                               | N / A for Pkg Type   |              | TLE2071IP                           | <a href="#">Samples</a> |
| TLE2071MFKB      | ACTIVE        | LCCC         | FK              | 20   | 55          | Non-RoHS & Green | SNPB                                 | N / A for Pkg Type   | -55 to 125   | 5962-9460201Q2A<br>TLE2071<br>MFKB  | <a href="#">Samples</a> |
| TLE2071MJG       | ACTIVE        | CDIP         | JG              | 8    | 50          | Non-RoHS & Green | SNPB                                 | N / A for Pkg Type   | -55 to 125   | TLE2071MJG                          | <a href="#">Samples</a> |
| TLE2071MJGB      | ACTIVE        | CDIP         | JG              | 8    | 50          | Non-RoHS & Green | SNPB                                 | N / A for Pkg Type   | -55 to 125   | 9460201QPA<br>TLE2071M              | <a href="#">Samples</a> |
| TLE2072ACP       | ACTIVE        | PDIP         | P               | 8    | 50          | RoHS & Green     | NIPDAU                               | N / A for Pkg Type   |              | TLE2072AC                           | <a href="#">Samples</a> |
| TLE2072ACPE4     | ACTIVE        | PDIP         | P               | 8    | 50          | TBD              | Call TI                              | Call TI              |              |                                     | <a href="#">Samples</a> |
| TLE2072AID       | OBSOLETE      | SOIC         | D               | 8    |             | TBD              | Call TI                              | Call TI              | -40 to 85    | 2072AI                              |                         |
| TLE2072AIDR      | ACTIVE        | SOIC         | D               | 8    | 2500        | RoHS & Green     | NIPDAU                               | Level-1-260C-UNLIM   |              | 2072AI                              | <a href="#">Samples</a> |
| TLE2072AIP       | ACTIVE        | PDIP         | P               | 8    | 50          | RoHS & Green     | NIPDAU                               | N / A for Pkg Type   |              | TLE2072AI                           | <a href="#">Samples</a> |
| TLE2072AMFKB     | ACTIVE        | LCCC         | FK              | 20   | 55          | Non-RoHS & Green | SNPB                                 | N / A for Pkg Type   | -55 to 125   | 5962-9460205Q2A<br>TLE2072<br>AMFKB | <a href="#">Samples</a> |
| TLE2072AMJG      | ACTIVE        | CDIP         | JG              | 8    | 50          | Non-RoHS & Green | SNPB                                 | N / A for Pkg Type   | -55 to 125   | TLE2072<br>AMJG                     | <a href="#">Samples</a> |
| TLE2072AMJGB     | ACTIVE        | CDIP         | JG              | 8    | 50          | Non-RoHS & Green | SNPB                                 | N / A for Pkg Type   | -55 to 125   | 9460205QPA<br>TLE2072AM             | <a href="#">Samples</a> |
| TLE2072AMUB      | ACTIVE        | CFP          | U               | 10   | 25          | Non-RoHS & Green | SNPB                                 | N / A for Pkg Type   | -55 to 125   | 9460205QHA<br>TLE2072AM             | <a href="#">Samples</a> |
| TLE2072CD        | OBSOLETE      | SOIC         | D               | 8    |             | TBD              | Call TI                              | Call TI              |              | 2072C                               |                         |
| TLE2072CDR       | ACTIVE        | SOIC         | D               | 8    | 2500        | RoHS & Green     | NIPDAU                               | Level-1-260C-UNLIM   |              | 2072C                               | <a href="#">Samples</a> |
| TLE2072CP        | ACTIVE        | PDIP         | P               | 8    | 50          | RoHS & Green     | NIPDAU                               | N / A for Pkg Type   |              | TLE2072CP                           | <a href="#">Samples</a> |
| TLE2072ID        | OBSOLETE      | SOIC         | D               | 8    |             | TBD              | Call TI                              | Call TI              |              | 2072I                               |                         |

| Orderable Device | Status<br>(1) | Package Type | Package Drawing | Pins | Package Qty | Eco Plan<br>(2)      | Lead finish/<br>Ball material<br>(6) | MSL Peak Temp<br>(3) | Op Temp (°C) | Device Marking<br>(4/5)             | Samples                 |
|------------------|---------------|--------------|-----------------|------|-------------|----------------------|--------------------------------------|----------------------|--------------|-------------------------------------|-------------------------|
| TLE2072IDR       | ACTIVE        | SOIC         | D               | 8    | 2500        | RoHS & Green         | NIPDAU                               | Level-1-260C-UNLIM   | -40 to 85    | 2072I                               | <a href="#">Samples</a> |
| TLE2072IDRG4     | ACTIVE        | SOIC         | D               | 8    | 2500        | TBD                  | Call TI                              | Call TI              | -40 to 85    |                                     | <a href="#">Samples</a> |
| TLE2072IP        | ACTIVE        | PDIP         | P               | 8    | 50          | RoHS & Green         | NIPDAU                               | N / A for Pkg Type   |              | TLE2072IP                           | <a href="#">Samples</a> |
| TLE2072MFKB      | ACTIVE        | LCCC         | FK              | 20   | 55          | Non-RoHS & Green     | SNPB                                 | N / A for Pkg Type   | -55 to 125   | 5962-9460202Q2A<br>TLE2072<br>MFKB  | <a href="#">Samples</a> |
| TLE2072MJG       | ACTIVE        | CDIP         | JG              | 8    | 50          | Non-RoHS & Green     | SNPB                                 | N / A for Pkg Type   | -55 to 125   | TLE2072MJG                          | <a href="#">Samples</a> |
| TLE2072MJGB      | ACTIVE        | CDIP         | JG              | 8    | 50          | Non-RoHS & Green     | SNPB                                 | N / A for Pkg Type   | -55 to 125   | 9460202QPA<br>TLE2072M              | <a href="#">Samples</a> |
| TLE2072MUB       | ACTIVE        | CFP          | U               | 10   | 25          | Non-RoHS & Green     | SNPB                                 | N / A for Pkg Type   | -55 to 125   | 9460202QHA<br>TLE2072M              | <a href="#">Samples</a> |
| TLE2074ACDW      | ACTIVE        | SOIC         | DW              | 16   | 40          | RoHS & Green         | NIPDAU                               | Level-1-260C-UNLIM   | 0 to 70      | TLE2074AC                           | <a href="#">Samples</a> |
| TLE2074ACN       | ACTIVE        | PDIP         | N               | 14   | 25          | RoHS & Green         | NIPDAU                               | N / A for Pkg Type   |              | TLE2074ACN                          | <a href="#">Samples</a> |
| TLE2074ACNE4     | ACTIVE        | PDIP         | N               | 14   | 25          | TBD                  | Call TI                              | Call TI              |              |                                     | <a href="#">Samples</a> |
| TLE2074AIDW      | ACTIVE        | SOIC         | DW              | 16   | 40          | RoHS & Green         | NIPDAU                               | Level-1-260C-UNLIM   | -40 to 85    | TLE2074AI                           | <a href="#">Samples</a> |
| TLE2074AIN       | ACTIVE        | PDIP         | N               | 14   | 25          | RoHS & Green         | NIPDAU                               | N / A for Pkg Type   |              | TLE2074AIN                          | <a href="#">Samples</a> |
| TLE2074AINE4     | ACTIVE        | PDIP         | N               | 14   | 25          | TBD                  | Call TI                              | Call TI              |              |                                     | <a href="#">Samples</a> |
| TLE2074AMFKB     | ACTIVE        | LCCC         | FK              | 20   | 55          | Non-RoHS & Green     | SNPB                                 | N / A for Pkg Type   | -55 to 125   | 5962-9460206Q2A<br>TLE2074<br>AMFKB | <a href="#">Samples</a> |
| TLE2074AMJ       | ACTIVE        | CDIP         | J               | 14   | 25          | Non-RoHS & Green     | SNPB                                 | N / A for Pkg Type   | -55 to 125   | TLE2074AMJ                          | <a href="#">Samples</a> |
| TLE2074AMJB      | ACTIVE        | CDIP         | J               | 14   | 25          | Non-RoHS & Green     | SNPB                                 | N / A for Pkg Type   | -55 to 125   | 5962-9460206QC<br>A<br>TLE2074AMJB  | <a href="#">Samples</a> |
| TLE2074AMWB      | ACTIVE        | CFP          | W               | 14   | 25          | Non-RoHS & Non-Green | SNPB                                 | N / A for Pkg Type   | -55 to 125   | 5962-9460206QD<br>A                 | <a href="#">Samples</a> |



| Orderable Device | Status<br>(1) | Package Type | Package Drawing | Pins | Package Qty | Eco Plan<br>(2)     | Lead finish/<br>Ball material<br>(6) | MSL Peak Temp<br>(3) | Op Temp (°C) | Device Marking<br>(4/5)                | Samples                 |
|------------------|---------------|--------------|-----------------|------|-------------|---------------------|--------------------------------------|----------------------|--------------|--|-------------------------|
|                  |               |              |                 |      |             |                     |                                      |                      |              | TLE2074AMWB                            |                         |
| TLE2074CDW       | ACTIVE        | SOIC         | DW              | 16   | 40          | RoHS & Green        | NIPDAU                               | Level-1-260C-UNLIM   | 0 to 70      | TLE2074C                               | <a href="#">Samples</a> |
| TLE2074CDWR      | ACTIVE        | SOIC         | DW              | 16   | 2000        | RoHS & Green        | NIPDAU                               | Level-1-260C-UNLIM   |              | TLE2074C                               | <a href="#">Samples</a> |
| TLE2074CN        | ACTIVE        | PDIP         | N               | 14   | 25          | RoHS & Green        | NIPDAU                               | N / A for Pkg Type   |              | TLE2074CN                              | <a href="#">Samples</a> |
| TLE2074IDW       | ACTIVE        | SOIC         | DW              | 16   | 40          | RoHS & Green        | NIPDAU                               | Level-1-260C-UNLIM   | -40 to 85    | TLE2074I                               | <a href="#">Samples</a> |
| TLE2074IDWG4     | ACTIVE        | SOIC         | DW              | 16   | 40          | TBD                 | Call TI                              | Call TI              | -40 to 85    |  | <a href="#">Samples</a> |
| TLE2074IDWR      | ACTIVE        | SOIC         | DW              | 16   | 2000        | RoHS & Green        | NIPDAU                               | Level-1-260C-UNLIM   |              | TLE2074I                               | <a href="#">Samples</a> |
| TLE2074IN        | ACTIVE        | PDIP         | N               | 14   | 25          | RoHS & Green        | NIPDAU                               | N / A for Pkg Type   |              | TLE2074IN                              | <a href="#">Samples</a> |
| TLE2074MFKB      | ACTIVE        | LCCC         | FK              | 20   | 55          | Non-RoHS<br>& Green | SNPB                                 | N / A for Pkg Type   | -55 to 125   | 5962-<br>9460203Q2A<br>TLE2074<br>MFKB | <a href="#">Samples</a> |
| TLE2074MJ        | ACTIVE        | CDIP         | J               | 14   | 25          | Non-RoHS<br>& Green | SNPB                                 | N / A for Pkg Type   | -55 to 125   | TLE2074MJ                              | <a href="#">Samples</a> |
| TLE2074MJB       | ACTIVE        | CDIP         | J               | 14   | 25          | Non-RoHS<br>& Green | SNPB                                 | N / A for Pkg Type   | -55 to 125   | 5962-9460203QC<br>A<br>TLE2074MJB      | <a href="#">Samples</a> |

(1) The marketing status values are defined as follows:

**ACTIVE:** Product device recommended for new designs.

**LIFEBUY:** TI has announced that the device will be discontinued, and a lifetime-buy period is in effect.

**NRND:** Not recommended for new designs. Device is in production to support existing customers, but TI does not recommend using this part in a new design.

**PREVIEW:** Device has been announced but is not in production. Samples may or may not be available.

**OBSOLETE:** TI has discontinued the production of the device.

(2) **RoHS:** TI defines "RoHS" to mean semiconductor products that are compliant with the current EU RoHS requirements for all 10 RoHS substances, including the requirement that RoHS substance do not exceed 0.1% by weight in homogeneous materials. Where designed to be soldered at high temperatures, "RoHS" products are suitable for use in specified lead-free processes. TI may reference these types of products as "Pb-Free".

**RoHS Exempt:** TI defines "RoHS Exempt" to mean products that contain lead but are compliant with EU RoHS pursuant to a specific EU RoHS exemption.

**Green:** TI defines "Green" to mean the content of Chlorine (Cl) and Bromine (Br) based flame retardants meet JS709B low halogen requirements of <=1000ppm threshold. Antimony trioxide based flame retardants must also meet the <=1000ppm threshold requirement.

(3) MSL, Peak Temp. - The Moisture Sensitivity Level rating according to the JEDEC industry standard classifications, and peak solder temperature.

(4) There may be additional marking, which relates to the logo, the lot trace code information, or the environmental category on the device.

(5) Multiple Device Markings will be inside parentheses. Only one Device Marking contained in parentheses and separated by a "~" will appear on a device. If a line is indented then it is a continuation of the previous line and the two combined represent the entire Device Marking for that device.

(6) Lead finish/Ball material - Orderable Devices may have multiple material finish options. Finish options are separated by a vertical ruled line. Lead finish/Ball material values may wrap to two lines if the finish value exceeds the maximum column width.

**Important Information and Disclaimer:**The information provided on this page represents TI's knowledge and belief as of the date that it is provided. TI bases its knowledge and belief on information provided by third parties, and makes no representation or warranty as to the accuracy of such information. Efforts are underway to better integrate information from third parties. TI has taken and continues to take reasonable steps to provide representative and accurate information but may not have conducted destructive testing or chemical analysis on incoming materials and chemicals. TI and TI suppliers consider certain information to be proprietary, and thus CAS numbers and other limited information may not be available for release.

In no event shall TI's liability arising out of such information exceed the total purchase price of the TI part(s) at issue in this document sold by TI to Customer on an annual basis.

**OTHER QUALIFIED VERSIONS OF TLE2071, TLE2071A, TLE2071AM, TLE2071M, TLE2072, TLE2072A, TLE2072AM, TLE2072M, TLE2074, TLE2074A, TLE2074AM, TLE2074M :**

- Catalog : [TLE2071A](#), [TLE2071](#), [TLE2072A](#), [TLE2072](#), [TLE2074A](#), [TLE2074](#)
  
- Automotive : [TLE2071A-Q1](#), [TLE2071A-Q1](#), [TLE2072A-Q1](#), [TLE2072A-Q1](#)
  
- Military : [TLE2071M](#), [TLE2071AM](#), [TLE2072M](#), [TLE2072AM](#), [TLE2074M](#), [TLE2074AM](#)

NOTE: Qualified Version Definitions:

- Catalog - TI's standard catalog product
  
- Automotive - Q100 devices qualified for high-reliability automotive applications targeting zero defects
  
- Military - QML certified for Military and Defense Applications

**TAPE AND REEL INFORMATION**

**QUADRANT ASSIGNMENTS FOR PIN 1 ORIENTATION IN TAPE**

\*All dimensions are nominal

| Device      | Package Type | Package Drawing | Pins | SPQ  | Reel Diameter (mm) | Reel Width W1 (mm) | A0 (mm) | B0 (mm) | K0 (mm) | P1 (mm) | W (mm) | Pin1 Quadrant |
|-------------|--------------|-----------------|------|------|--------------------|--------------------|---------|---------|---------|---------|--------|---------------|
| TLE2071ACDR | SOIC         | D               | 8    | 2500 | 330.0              | 12.4               | 6.4     | 5.2     | 2.1     | 8.0     | 12.0   | Q1            |
| TLE2071AIDR | SOIC         | D               | 8    | 2500 | 330.0              | 12.4               | 6.4     | 5.2     | 2.1     | 8.0     | 12.0   | Q1            |
| TLE2071IDR  | SOIC         | D               | 8    | 2500 | 330.0              | 12.4               | 6.4     | 5.2     | 2.1     | 8.0     | 12.0   | Q1            |
| TLE2072AIDR | SOIC         | D               | 8    | 2500 | 330.0              | 12.4               | 6.4     | 5.2     | 2.1     | 8.0     | 12.0   | Q1            |
| TLE2072CDR  | SOIC         | D               | 8    | 2500 | 330.0              | 12.4               | 6.4     | 5.2     | 2.1     | 8.0     | 12.0   | Q1            |
| TLE2072IDR  | SOIC         | D               | 8    | 2500 | 330.0              | 12.4               | 6.4     | 5.2     | 2.1     | 8.0     | 12.0   | Q1            |
| TLE2074CDWR | SOIC         | DW              | 16   | 2000 | 330.0              | 16.4               | 10.75   | 10.7    | 2.7     | 12.0    | 16.0   | Q1            |
| TLE2074IDWR | SOIC         | DW              | 16   | 2000 | 330.0              | 16.4               | 10.75   | 10.7    | 2.7     | 12.0    | 16.0   | Q1            |

**TAPE AND REEL BOX DIMENSIONS**

\*All dimensions are nominal

| Device      | Package Type | Package Drawing | Pins | SPQ  | Length (mm) | Width (mm) | Height (mm) |
|-------------|--------------|-----------------|------|------|-------------|------------|-------------|
| TLE2071ACDR | SOIC         | D               | 8    | 2500 | 340.5       | 338.1      | 20.6        |
| TLE2071AIDR | SOIC         | D               | 8    | 2500 | 340.5       | 338.1      | 20.6        |
| TLE2071IDR  | SOIC         | D               | 8    | 2500 | 340.5       | 338.1      | 20.6        |
| TLE2072AIDR | SOIC         | D               | 8    | 2500 | 340.5       | 338.1      | 20.6        |
| TLE2072CDR  | SOIC         | D               | 8    | 2500 | 340.5       | 338.1      | 20.6        |
| TLE2072IDR  | SOIC         | D               | 8    | 2500 | 340.5       | 338.1      | 20.6        |
| TLE2074CDWR | SOIC         | DW              | 16   | 2000 | 350.0       | 350.0      | 43.0        |
| TLE2074IDWR | SOIC         | DW              | 16   | 2000 | 350.0       | 350.0      | 43.0        |

**TUBE**

\*All dimensions are nominal

| Device          | Package Name | Package Type | Pins | SPQ | L (mm) | W (mm) | T (μm) | B (mm) |
|-----------------|--------------|--------------|------|-----|--------|--------|--------|--------|
| 5962-9460201Q2A | FK           | LCCC         | 20   | 55  | 506.98 | 12.06  | 2030   | NA     |
| 5962-9460202Q2A | FK           | LCCC         | 20   | 55  | 506.98 | 12.06  | 2030   | NA     |
| 5962-9460202QHA | U            | CFP          | 10   | 25  | 506.98 | 26.16  | 6220   | NA     |
| 5962-9460203Q2A | FK           | LCCC         | 20   | 55  | 506.98 | 12.06  | 2030   | NA     |
| 5962-9460204Q2A | FK           | LCCC         | 20   | 55  | 506.98 | 12.06  | 2030   | NA     |
| 5962-9460204QHA | U            | CFP          | 10   | 25  | 506.98 | 26.16  | 6220   | NA     |
| 5962-9460205Q2A | FK           | LCCC         | 20   | 55  | 506.98 | 12.06  | 2030   | NA     |
| 5962-9460205QHA | U            | CFP          | 10   | 25  | 506.98 | 26.16  | 6220   | NA     |
| 5962-9460206Q2A | FK           | LCCC         | 20   | 55  | 506.98 | 12.06  | 2030   | NA     |
| 5962-9460206QDA | W            | CFP          | 14   | 25  | 506.98 | 26.16  | 6220   | NA     |
| TLE2071ACP      | P            | PDIP         | 8    | 50  | 506    | 13.97  | 11230  | 4.32   |
| TLE2071AIP      | P            | PDIP         | 8    | 50  | 506    | 13.97  | 11230  | 4.32   |
| TLE2071AMFKB    | FK           | LCCC         | 20   | 55  | 506.98 | 12.06  | 2030   | NA     |
| TLE2071AMUB     | U            | CFP          | 10   | 25  | 506.98 | 26.16  | 6220   | NA     |
| TLE2071CP       | P            | PDIP         | 8    | 50  | 506    | 13.97  | 11230  | 4.32   |
| TLE2071IP       | P            | PDIP         | 8    | 50  | 506    | 13.97  | 11230  | 4.32   |
| TLE2071MFKB     | FK           | LCCC         | 20   | 55  | 506.98 | 12.06  | 2030   | NA     |
| TLE2072ACP      | P            | PDIP         | 8    | 50  | 506    | 13.97  | 11230  | 4.32   |
| TLE2072ACP      | P            | PDIP         | 8    | 50  | 506    | 13.97  | 11230  | 4.32   |
| TLE2072AIP      | P            | PDIP         | 8    | 50  | 506    | 13.97  | 11230  | 4.32   |
| TLE2072AMFKB    | FK           | LCCC         | 20   | 55  | 506.98 | 12.06  | 2030   | NA     |
| TLE2072AMUB     | U            | CFP          | 10   | 25  | 506.98 | 26.16  | 6220   | NA     |
| TLE2072CP       | P            | PDIP         | 8    | 50  | 506    | 13.97  | 11230  | 4.32   |
| TLE2072CP       | P            | PDIP         | 8    | 50  | 506    | 13.97  | 11230  | 4.32   |
| TLE2072IP       | P            | PDIP         | 8    | 50  | 506    | 13.97  | 11230  | 4.32   |
| TLE2072IP       | P            | PDIP         | 8    | 50  | 506    | 13.97  | 11230  | 4.32   |
| TLE2072MFKB     | FK           | LCCC         | 20   | 55  | 506.98 | 12.06  | 2030   | NA     |
| TLE2072MUB      | U            | CFP          | 10   | 25  | 506.98 | 26.16  | 6220   | NA     |
| TLE2074ACDW     | DW           | SOIC         | 16   | 40  | 506.98 | 12.7   | 4826   | 6.6    |

| Device       | Package Name | Package Type | Pins | SPQ | L (mm) | W (mm) | T (μm) | B (mm) |
|--------------|--------------|--------------|------|-----|--------|--------|--------|--------|
| TLE2074ACN   | N            | PDIP         | 14   | 25  | 506    | 13.97  | 11230  | 4.32   |
| TLE2074AIDW  | DW           | SOIC         | 16   | 40  | 506.98 | 12.7   | 4826   | 6.6    |
| TLE2074AIN   | N            | PDIP         | 14   | 25  | 506    | 13.97  | 11230  | 4.32   |
| TLE2074AMFKB | FK           | LCCC         | 20   | 55  | 506.98 | 12.06  | 2030   | NA     |
| TLE2074AMWB  | W            | CFP          | 14   | 25  | 506.98 | 26.16  | 6220   | NA     |
| TLE2074CDW   | DW           | SOIC         | 16   | 40  | 506.98 | 12.7   | 4826   | 6.6    |
| TLE2074CN    | N            | PDIP         | 14   | 25  | 506    | 13.97  | 11230  | 4.32   |
| TLE2074IDW   | DW           | SOIC         | 16   | 40  | 506.98 | 12.7   | 4826   | 6.6    |
| TLE2074IN    | N            | PDIP         | 14   | 25  | 506    | 13.97  | 11230  | 4.32   |
| TLE2074MFKB  | FK           | LCCC         | 20   | 55  | 506.98 | 12.06  | 2030   | NA     |

# PACKAGE OUTLINE

## JG0008A

### CDIP - 5.08 mm max height

CERAMIC DUAL IN-LINE PACKAGE



#### NOTES:

1. All linear dimensions are in millimeters. Any dimensions in parenthesis are for reference only. Dimensioning and tolerancing per ASME Y14.5M.
2. This drawing is subject to change without notice.
3. This package can be hermetically sealed with a ceramic lid using glass frit.
4. Index point is provided on cap for terminal identification.
5. Falls within MIL STD 1835 GDIP1-T8

# EXAMPLE BOARD LAYOUT

JG0008A

CDIP - 5.08 mm max height

CERAMIC DUAL IN-LINE PACKAGE



LAND PATTERN EXAMPLE  
NON SOLDER MASK DEFINED  
SCALE: 9X

4230036/A 09/2023



# U0010A



# PACKAGE OUTLINE

CFP - 2.03 mm max height

CERAMIC FLATPACK

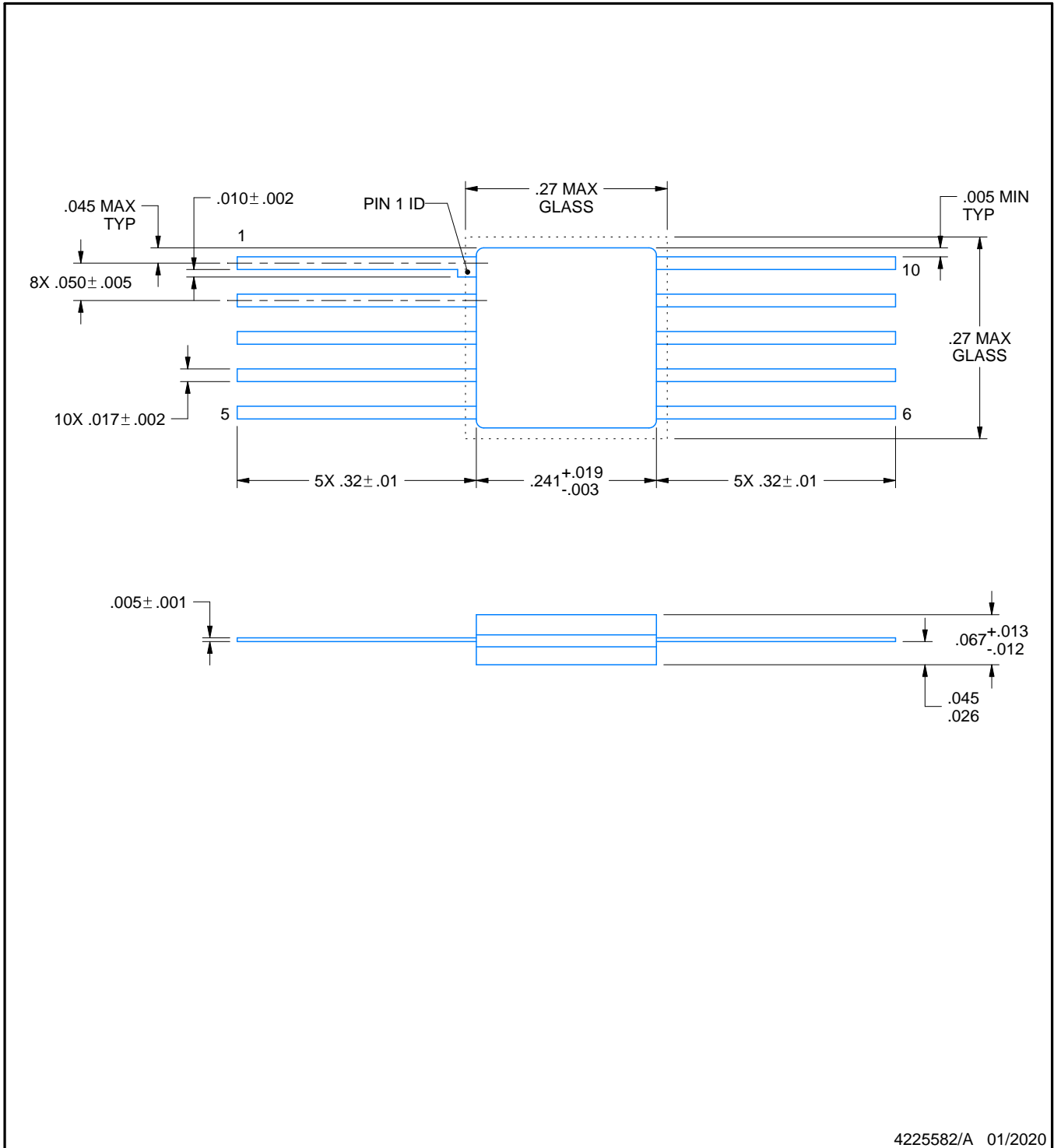

NOTES:

1. All linear dimensions are in inches. Any dimensions in parenthesis are for reference only. Dimensioning and tolerancing per ASME Y14.5M.
2. This drawing is subject to change without notice.

## GENERIC PACKAGE VIEW

**FK 20**

**LCCC - 2.03 mm max height**

8.89 x 8.89, 1.27 mm pitch

LEADLESS CERAMIC CHIP CARRIER

This image is a representation of the package family, actual package may vary.  
Refer to the product data sheet for package details.



4229370VA\

J 14

**GENERIC PACKAGE VIEW**  
**CDIP - 5.08 mm max height**  
CERAMIC DUAL IN LINE PACKAGE



Images above are just a representation of the package family, actual package may vary.  
Refer to the product data sheet for package details.

4040083-5/G



J0014A

# PACKAGE OUTLINE

CDIP - 5.08 mm max height

CERAMIC DUAL IN LINE PACKAGE



4214771/A 05/2017

**NOTES:**

1. All controlling linear dimensions are in inches. Dimensions in brackets are in millimeters. Any dimension in brackets or parenthesis are for reference only. Dimensioning and tolerancing per ASME Y14.5M.
2. This drawing is subject to change without notice.
3. This package is hermetically sealed with a ceramic lid using glass frit.
4. Index point is provided on cap for terminal identification only and on press ceramic glass frit seal only.
5. Falls within MIL-STD-1835 and GDIP1-T14.

# EXAMPLE BOARD LAYOUT

J0014A

CDIP - 5.08 mm max height

CERAMIC DUAL IN LINE PACKAGE



LAND PATTERN EXAMPLE  
NON-SOLDER MASK DEFINED  
SCALE: 5X



4214771/A 05/2017



D0008A

# PACKAGE OUTLINE

SOIC - 1.75 mm max height

SMALL OUTLINE INTEGRATED CIRCUIT



4214825/C 02/2019

### NOTES:

- Linear dimensions are in inches [millimeters]. Dimensions in parenthesis are for reference only. Controlling dimensions are in inches. Dimensioning and tolerancing per ASME Y14.5M.
- This drawing is subject to change without notice.
- This dimension does not include mold flash, protrusions, or gate burrs. Mold flash, protrusions, or gate burrs shall not exceed  $.006$  [0.15] per side.
- This dimension does not include interlead flash.
- Reference JEDEC registration MS-012, variation AA.

# EXAMPLE BOARD LAYOUT

D0008A

SOIC - 1.75 mm max height

SMALL OUTLINE INTEGRATED CIRCUIT



LAND PATTERN EXAMPLE  
 EXPOSED METAL SHOWN  
 SCALE:8X



SOLDER MASK DETAILS

4214825/C 02/2019

NOTES: (continued)

- 6. Publication IPC-7351 may have alternate designs.
- 7. Solder mask tolerances between and around signal pads can vary based on board fabrication site.

# EXAMPLE STENCIL DESIGN

D0008A

SOIC - 1.75 mm max height

SMALL OUTLINE INTEGRATED CIRCUIT



SOLDER PASTE EXAMPLE  
BASED ON .005 INCH [0.125 MM] THICK STENCIL  
SCALE:8X

4214825/C 02/2019

NOTES: (continued)

8. Laser cutting apertures with trapezoidal walls and rounded corners may offer better paste release. IPC-7525 may have alternate design recommendations.
9. Board assembly site may have different recommendations for stencil design.



P (R-PDIP-T8)

PLASTIC DUAL-IN-LINE PACKAGE



- NOTES:
- A. All linear dimensions are in inches (millimeters).
  - B. This drawing is subject to change without notice.
  - C. Falls within JEDEC MS-001 variation BA.

N (R-PDIP-T\*\*)

PLASTIC DUAL-IN-LINE PACKAGE

16 PINS SHOWN



- NOTES:
- A. All linear dimensions are in inches (millimeters).
  - B. This drawing is subject to change without notice.
  - Falls within JEDEC MS-001, except 18 and 20 pin minimum body length (Dim A).
  - The 20 pin end lead shoulder width is a vendor option, either half or full width.

W (R-GDFP-F14)

CERAMIC DUAL FLATPACK



- NOTES:
- A. All linear dimensions are in inches (millimeters).
  - B. This drawing is subject to change without notice.
  - C. This package can be hermetically sealed with a ceramic lid using glass frit.
  - D. Index point is provided on cap for terminal identification only.
  - E. Falls within MIL STD 1835 GDFP1-F14

## GENERIC PACKAGE VIEW

**DW 16**

**SOIC - 2.65 mm max height**

7.5 x 10.3, 1.27 mm pitch

SMALL OUTLINE INTEGRATED CIRCUIT

This image is a representation of the package family, actual package may vary.  
Refer to the product data sheet for package details.



4224780/A



# DW0016A

# PACKAGE OUTLINE

## SOIC - 2.65 mm max height

SOIC



4220721/A 07/2016

### NOTES:

1. All linear dimensions are in millimeters. Dimensions in parenthesis are for reference only. Dimensioning and tolerancing per ASME Y14.5M.
2. This drawing is subject to change without notice.
3. This dimension does not include mold flash, protrusions, or gate burrs. Mold flash, protrusions, or gate burrs shall not exceed 0.15 mm, per side.
4. This dimension does not include interlead flash. Interlead flash shall not exceed 0.25 mm, per side.
5. Reference JEDEC registration MS-013.

# EXAMPLE BOARD LAYOUT

DW0016A

SOIC - 2.65 mm max height

SOIC



LAND PATTERN EXAMPLE  
SCALE:7X



SOLDER MASK DETAILS

4220721/A 07/2016

NOTES: (continued)

6. Publication IPC-7351 may have alternate designs.

7. Solder mask tolerances between and around signal pads can vary based on board fabrication site.

# EXAMPLE STENCIL DESIGN

DW0016A

SOIC - 2.65 mm max height

SOIC



SOLDER PASTE EXAMPLE  
BASED ON 0.125 mm THICK STENCIL  
SCALE:7X

4220721/A 07/2016

NOTES: (continued)

8. Laser cutting apertures with trapezoidal walls and rounded corners may offer better paste release. IPC-7525 may have alternate design recommendations.
9. Board assembly site may have different recommendations for stencil design.

## IMPORTANT NOTICE AND DISCLAIMER

TI PROVIDES TECHNICAL AND RELIABILITY DATA (INCLUDING DATA SHEETS), DESIGN RESOURCES (INCLUDING REFERENCE DESIGNS), APPLICATION OR OTHER DESIGN ADVICE, WEB TOOLS, SAFETY INFORMATION, AND OTHER RESOURCES "AS IS" AND WITH ALL FAULTS, AND DISCLAIMS ALL WARRANTIES, EXPRESS AND IMPLIED, INCLUDING WITHOUT LIMITATION ANY IMPLIED WARRANTIES OF MERCHANTABILITY, FITNESS FOR A PARTICULAR PURPOSE OR NON-INFRINGEMENT OF THIRD PARTY INTELLECTUAL PROPERTY RIGHTS.

These resources are intended for skilled developers designing with TI products. You are solely responsible for (1) selecting the appropriate TI products for your application, (2) designing, validating and testing your application, and (3) ensuring your application meets applicable standards, and any other safety, security, regulatory or other requirements.

These resources are subject to change without notice. TI grants you permission to use these resources only for development of an application that uses the TI products described in the resource. Other reproduction and display of these resources is prohibited. No license is granted to any other TI intellectual property right or to any third party intellectual property right. TI disclaims responsibility for, and you will fully indemnify TI and its representatives against, any claims, damages, costs, losses, and liabilities arising out of your use of these resources.

TI's products are provided subject to [TI's Terms of Sale](#) or other applicable terms available either on [ti.com](https://www.ti.com) or provided in conjunction with such TI products. TI's provision of these resources does not expand or otherwise alter TI's applicable warranties or warranty disclaimers for TI products.

TI objects to and rejects any additional or different terms you may have proposed.

Mailing Address: Texas Instruments, Post Office Box 655303, Dallas, Texas 75265  
Copyright © 2024, Texas Instruments Incorporated