

10-BIT, 4 ANALOG INPUT, 6-MSPS, SIMULTANEOUS SAMPLING ANALOG-TO-DIGITAL CONVERTER

FEATURES

- Simultaneous Sampling of 4 Single-Ended Signals or 2 Differential Signals or Combination of Both
- Signal-to-Noise and Distortion Ratio: 59 dB at $f_1 = 2$ MHz
- Differential Nonlinearity Error: ± 1 LSB
- Integral Nonlinearity Error: ± 1 LSB
- Auto-Scan Mode for 2, 3, or 4 Inputs
- 3-V or 5-V Digital Interface Compatible
- Low Power: 216 mW Max at 5 V
- Power Down: 1 mW Max
- 5-V Analog Single Supply Operation
- Internal Voltage References . . . 50 PPM/ $^{\circ}$ C and $\pm 5\%$ Accuracy
- Glueless DSP Interface
- Parallel μ C/DSP Interface

APPLICATIONS

- Radar Applications
- Communications
- Control Applications
- High-Speed DSP Front-End
- Automotive Applications

DESCRIPTION

The THS1007 is a CMOS, low-power, 10-bit, 6 MSPS analog-to-digital converter (ADC). The speed, resolution, bandwidth, and single-supply operation are suited for applications in radar, imaging, high-speed acquisition, and communications. A multistage pipelined architecture with output error correction logic provides for no missing codes over the full operating temperature range. Internal control registers are used to program the ADC into the desired

mode. The THS1007 consists of four analog inputs, which are sampled simultaneously. These inputs can be selected individually and configured to single-ended or differential inputs. Internal reference voltages for the ADC (1.5 V and 3.5 V) are provided. An external reference can also be chosen to suit the dc accuracy and temperature drift requirements of the application.

The THS1007C is characterized for operation from 0 $^{\circ}$ C to 70 $^{\circ}$ C, and the THS1007I is characterized for operation from -40 $^{\circ}$ C to 85 $^{\circ}$ C.

DA (TSSOP) PACKAGE
(TOP VIEW)

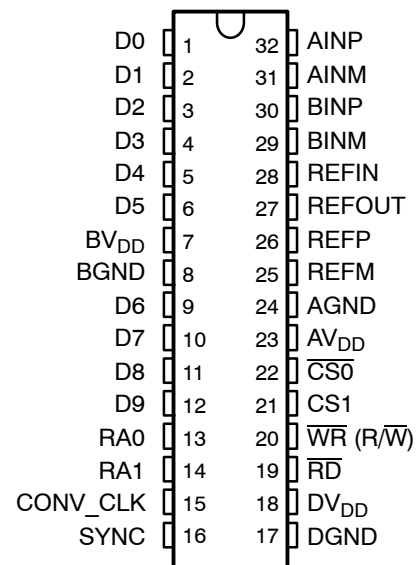

ORDERING INFORMATION

T_A	PACKAGED DEVICE
	TSSOP (DA)
0 $^{\circ}$ C to 70 $^{\circ}$ C	THS1007CDA
-40 $^{\circ}$ C to 85 $^{\circ}$ C	THS1007IDA



Please be aware that an important notice concerning availability, standard warranty, and use in critical applications of Texas Instruments semiconductor products and disclaimers thereto appears at the end of this data sheet.

THS1007

SLAS286B – AUGUST 2000– REVISED DECEMBER 2010



These devices have limited built-in ESD protection. The leads should be shorted together or the device placed in conductive foam during storage or handling to prevent electrostatic damage to the MOS gates.

ABSOLUTE MAXIMUM RATINGS

over operating free-air temperature range unless otherwise noted⁽¹⁾

		UNITS
Supply voltage range	DGND to DV _{DD}	-0.3 V to 6.5 V
	BGND to BV _{DD}	-0.3 V to 6.5 V
	AGND to AV _{DD}	-0.3 V to 6.5 V
Analog input voltage range		AGND -0.3 V to AV _{DD} + 1.5 V
Reference input voltage		-0.3 V + AGND to AV _{DD} + 0.3 V
Digital input voltage range		-0.3 V to BV _{DD} /DV _{DD} + 0.3 V
Operating virtual junction temperature range, T _J		-40°C to 150°C
Operating free-air temperature range, T _A	THS1007C	0°C to 70°C
	THS1007I	-40°C to 85°C
Storage temperature range, T _{stg}		-65°C to 150°C
Lead temperature 1,6 mm (1/16 inch) from case for 10 seconds		260°C

⁽¹⁾ Stresses beyond those listed under “absolute maximum ratings” may cause permanent damage to the device. These are stress ratings only, and functional operation of the device at these or any other conditions beyond those indicated under “recommended operating conditions” is not implied. Exposure to absolute-maximum-rated conditions for extended periods may affect device reliability.

RECOMMENDED OPERATING CONDITIONS

POWER SUPPLY		MIN	NOM	MAX	UNIT
Supply voltage	AV _{DD}	4.75	5	5.25	V
	DV _{DD}	4.75	5	5.25	
	BV _{DD}	3		5.25	

ANALOG AND REFERENCE INPUTS		MIN	NOM	MAX	UNIT
Analog input voltage in single-ended configuration		V _{REFM}		V _{REFP}	V
Common-mode input voltage V _{CM} in differential configuration		1	2.5	4	V
External reference voltage, V _{REFP} (optional)			3.5	AV _{DD} -1.2	V
External reference voltage, V _{REFM} (optional)		1.4	1.5		V
Input voltage difference, REFP – REFM			2		V

DIGITAL INPUTS		MIN	NOM	MAX	UNIT	
High-level input voltage, V _{IH}	BV _{DD} = 3.3 V	2			V	
	BV _{DD} = 5.25 V	2.6			V	
Low-level input voltage, V _{IL}	BV _{DD} = 3.3 V			0.6	V	
	BV _{DD} = 5.25 V			0.6	V	
Input CONV_CLK frequency				6	MHz	
CONV_CLK pulse duration, clock high, t _w (CONV_CLKH)			80	83	5000	ns
CONV_CLK pulse duration, clock low, t _w (CONV_CLKL)			80	83	5000	ns
Operating free-air temperature, T _A	THS1007CDA	0		70	°C	
	THS1007IDA	-40		85		

ELECTRICAL CHARACTERISTICS

 over recommended operating conditions, $AV_{DD} = DV_{DD} = 5\text{ V}$, $BV_{DD} = 3.3\text{ V}$, $V_{REF} = \text{internal}$ (unless otherwise noted)

DIGITAL SPECIFICATIONS						
PARAMETER		TEST CONDITIONS	MIN	TYP	MAX	UNIT
Digital inputs						
I_{IH}	High-level input current	$DV_{DD} = \text{digital inputs}$	-50		50	μA
I_{IL}	Low-level input current	Digital input = 0 V	-50		50	μA
C_i	Input capacitance			5		pF
Digital outputs						
V_{OH}	High-level output voltage	$I_{OH} = -50\ \mu\text{A}$, $BV_{DD} = 3.3\text{ V}, 5\text{ V}$	$BV_{DD} - 0.5$			V
V_{OL}	Low-level output voltage	$I_{OL} = 50\ \mu\text{A}$, $BV_{DD} = 3.3\text{ V}, 5\text{ V}$			0.4	V
I_{OZ}	High-impedance-state output current	$CS1 = \text{DGND}$, $CS0 = DV_{DD}$	-10		10	μA
C_O	Output capacitance			5		pF
C_L	Load capacitance at databus D0 – D9				30	pF

ELECTRICAL CHARACTERISTICS

 over recommended operating conditions, $AV_{DD} = DV_{DD} = 5\text{ V}$, $BV_{DD} = 3.3\text{ V}$, $f_s = 6\text{ MSPS}$, $V_{REF} = \text{internal}$ (unless otherwise noted)

DC SPECIFICATIONS						
PARAMETER		TEST CONDITIONS	MIN	TYP	MAX	UNIT
Resolution			10			Bits
Accuracy						
Integral nonlinearity, INL					± 1	LSB
Differential nonlinearity, DNL					± 1	LSB
Offset error		After calibration in single-ended mode		± 5		LSB
Offset error		After calibration in differential mode	-10		10	LSB
Gain error			-10		10	LSB
Analog input						
Input capacitance				15		pF
Input leakage current		$V_{AIN} = V_{REFM}$ to V_{REFP}			± 10	μA
Internal voltage reference						
Accuracy, V_{REFP}			3.3	3.5	3.7	V
Accuracy, V_{REFM}			1.4	1.5	1.6	V
Temperature coefficient				50		PPM/ ^o C
Reference noise				100		μV
Accuracy, REFOUT			2.475	2.5	2.525	V
Power supply						
I_{DDA}	Analog supply current	$AV_{DD} = DV_{DD} = 5\text{ V}$, $BV_{DD} = 3.3\text{ V}$		36	40	mA
I_{DDD}	Digital supply current	$AV_{DD} = DV_{DD} = 5\text{ V}$, $BV_{DD} = 3.3\text{ V}$		0.5	3	mA
I_{DDB}	Buffer supply current	$AV_{DD} = DV_{DD} = 5\text{ V}$, $BV_{DD} = 3.3\text{ V}$		1.5	4	mA
Power dissipation		$AV_{DD} = DV_{DD} = 5\text{ V}$, $BV_{DD} = 3.3\text{ V}$		186	216	mW
Power dissipation in power down with conversion clock inactive		$AV_{DD} = DV_{DD} = 5\text{ V}$, $BV_{DD} = 3.3\text{ V}$			0.25	mW

THS1007

SLAS286B – AUGUST 2000– REVISED DECEMBER 2010

ELECTRICAL CHARACTERISTICS

 over recommended operating conditions, V_{REF} = internal, $f_s = 6$ MSPS, $f_i = 2$ MHz at -1 dBFS (unless otherwise noted)

AC SPECIFICATIONS, $AV_{DD} = DV_{DD} = 5$ V, $BV_{DD} = 3.3$ V, $C_L < 30$ pF						
PARAMETER		TEST CONDITIONS	MIN	TYP	MAX	UNIT
SINAD	Signal-to-noise ratio + distortion	Differential mode	56	59		dB
		Single-ended mode	55	58		dB
SNR	Signal-to-noise ratio	Differential mode	59	61		dB
		Single-ended mode	58	60		dB
THD	Total harmonic distortion	Differential mode		-64	-61	dB
		Single-ended mode		-63	-60	dB
ENOB (SNR)	Effective number of bits	Differential mode	9	9.5		Bits
		Single-ended mode	8.85	9.35		Bits
SFDR	Spurious free dynamic range	Differential mode	61	65		dB
		Single-ended mode	60	64		dB
Analog Input						
	Full-power bandwidth with a source impedance of 150 Ω in differential configuration.	Full scale sinewave, -3 dB		96		MHz
	Full-power bandwidth with a source impedance of 150 Ω in single-ended configuration.	Full scale sinewave, -3 dB		54		MHz
	Small-signal bandwidth with a source impedance of 150 Ω in differential configuration.	100 mVpp sinewave, -3 dB		96		MHz
	Small-signal bandwidth with a source impedance of 150 Ω in single-ended configuration.	100 mVpp sinewave, -3 dB		54		MHz

TIMING REQUIREMENTS

 $AV_{DD} = DV_{DD} = 5$ V, $BV_{DD} = 3.3$ V, V_{REF} = internal, $C_L < 30$ pF

PARAMETER		TEST CONDITIONS	MIN	TYP	MAX	UNIT
t_{pipe}	Latency			5		CONV CLK
$t_{su}(CONV_CLKL-READL)$	Setup time, CONV_CLK low before CS valid		10			ns
$t_{su}(READH-CONV_CLKL)$	Setup time, CS invalid to CONV_CLK low		20			ns
$t_d(CONV_CLKL-SYNCL)$	Delay time, CONV_CLK low to SYNC low				10	ns
$t_d(CONV_CLKL-SYNCH)$	Delay time, CONV_CLK low to SYNC high				10	ns

Terminal Functions

TERMINAL		I/O	DESCRIPTION
NAME	NO.		
AINP	32	I	Analog input, single-ended or positive input of differential channel A
AINM	31	I	Analog input, single-ended or negative input of differential channel A
BINP	30	I	Analog input, single-ended or positive input of differential channel B
BINM	29	I	Analog input, single-ended or negative input of differential channel B
AV _{DD}	23	I	Analog supply voltage
AGND	24	I	Analog ground
BV _{DD}	7	I	Digital supply voltage for buffer
BGND	8	I	Digital ground for buffer
CONV_CLK	15	I	Digital input. This input is the conversion clock input.
$\overline{\text{CS}}0$	22	I	Chip select input (active low)
CS1	21	I	Chip select input (active high)
SYNC	16	O	Synchronization output. This signal indicates in a multichannel operation that data of channel A is brought to the digital output and can therefore be used for synchronization.
DGND	17	I	Digital ground. Ground reference for digital circuitry.
DV _{DD}	18	I	Digital supply voltage
D0 – D9	1–6, 9–12	I/O/Z	Digital input, output; D0 = LSB
RA0	13	I	Digital input. RA0 is used as an address line for the control register. This is required for writing to the control register 0 and control register 1. See Table 7.
RA1	14	I	Digital input. RA1 is used as an address line for the control register. This is required for writing to control register 0 and control register 1. See Table 7.
REFIN	28	I	Common-mode reference input for the analog input channels. It is recommended that this pin be connected to the reference output REFOUT.
REFP	26	I	Reference input, requires a bypass capacitor of 10 μ F to AGND in order to bypass the internal reference voltage. An external reference voltage at this input can be applied. This option can be programmed through control register 0. See Table 8.
REFM	25	I	Reference input, requires a bypass capacitor of 10 μ F to AGND in order to bypass the internal reference voltage. An external reference voltage at this input can be applied. This option can be programmed through control register 0. See Table 8.
REFOUT	27	O	Analog fixed reference output voltage of 2.5 V. Sink and source capability of 250 μ A. The reference output requires a capacitor of 10 μ F to AGND for filtering and stability.
$\overline{\text{RD}}^{(1)}$	19	I	The $\overline{\text{RD}}$ input is used only if the $\overline{\text{WR}}$ input is configured as a write only input. In this case, it is a digital input, active low as a data read select from the processor. See timing section.
$\overline{\text{WR}} (\text{R}/\overline{\text{W}})^{(1)}$	20	I	This input is programmable. It functions as a read-write input R/W and can also be configured as a write-only input $\overline{\text{WR}}$, which is active low and used as data write select from the processor. In this case, the $\overline{\text{RD}}$ input is used as a read input from the processor. See timing section.

⁽¹⁾ The start-conditions of $\overline{\text{RD}}$ and $\overline{\text{WR}} (\text{R}/\overline{\text{W}})$ are unknown. The first access to the ADC has to be a write access to initialize the ADC.

THS1007

SLAS286B – AUGUST 2000– REVISED DECEMBER 2010

FUNCTIONAL BLOCK DIAGRAM

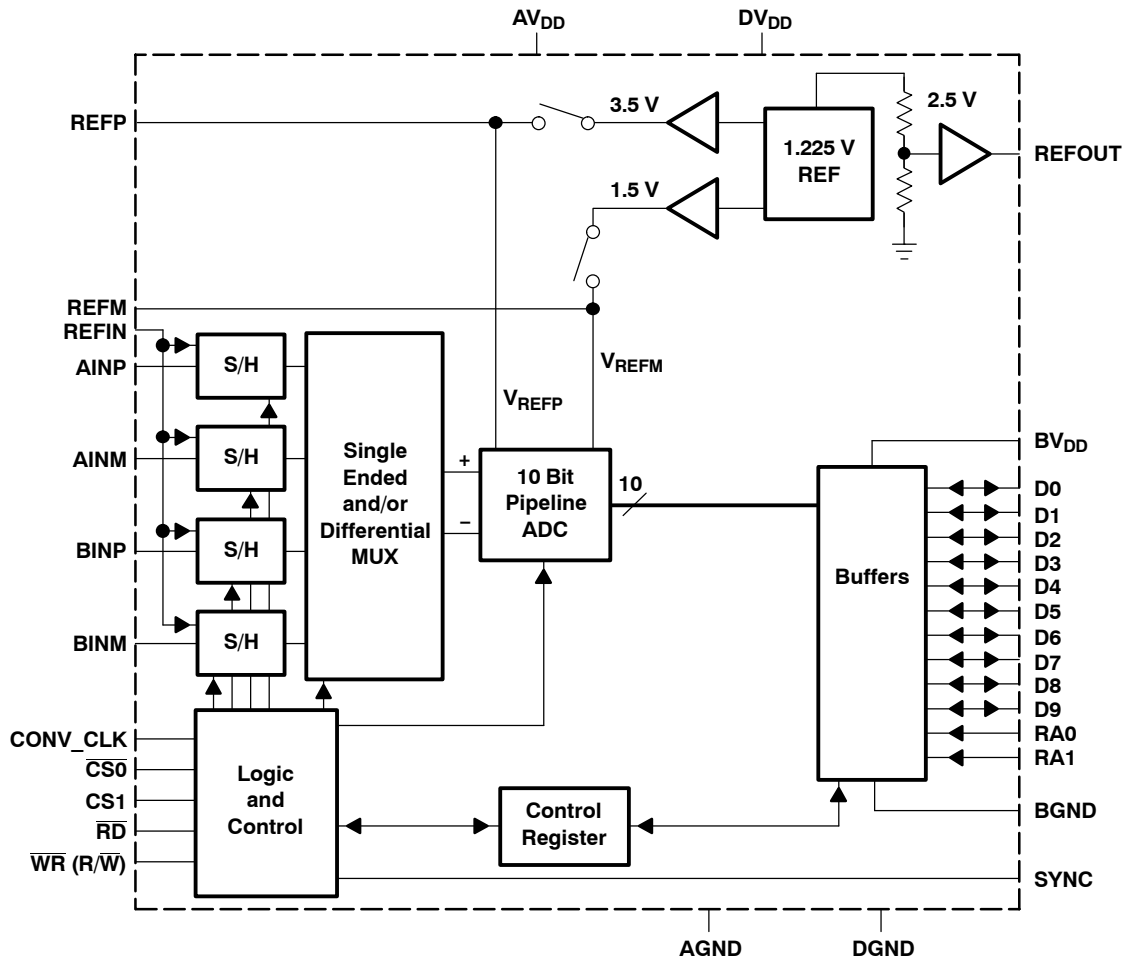

TYPICAL CHARACTERISTICS

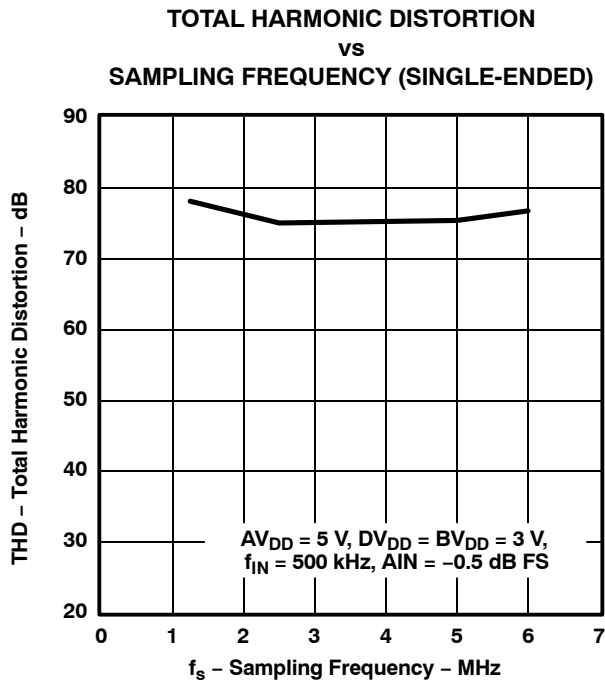

Figure 1

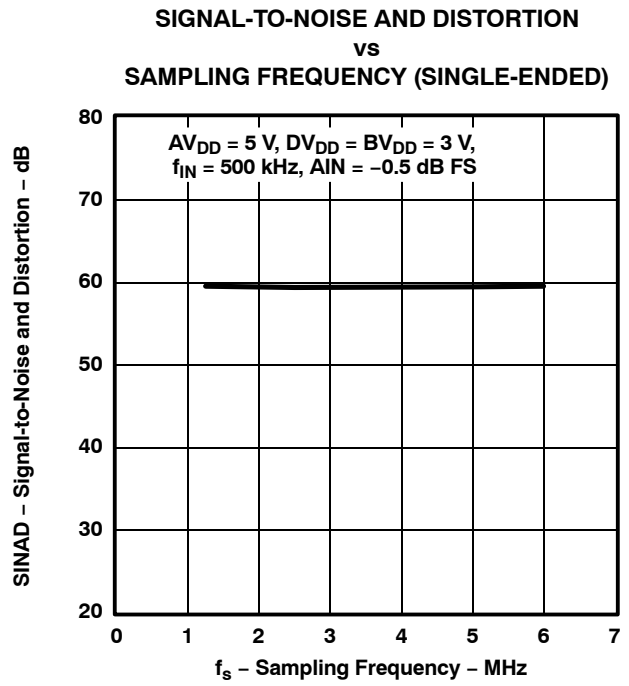

Figure 2

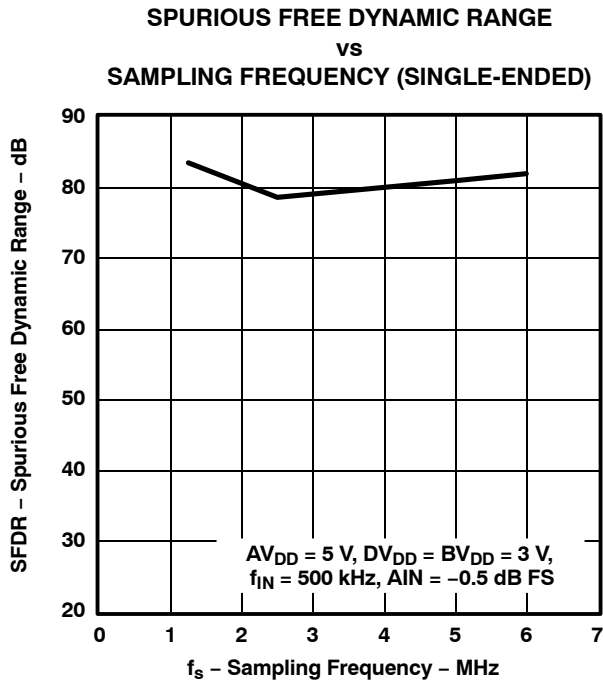

Figure 3

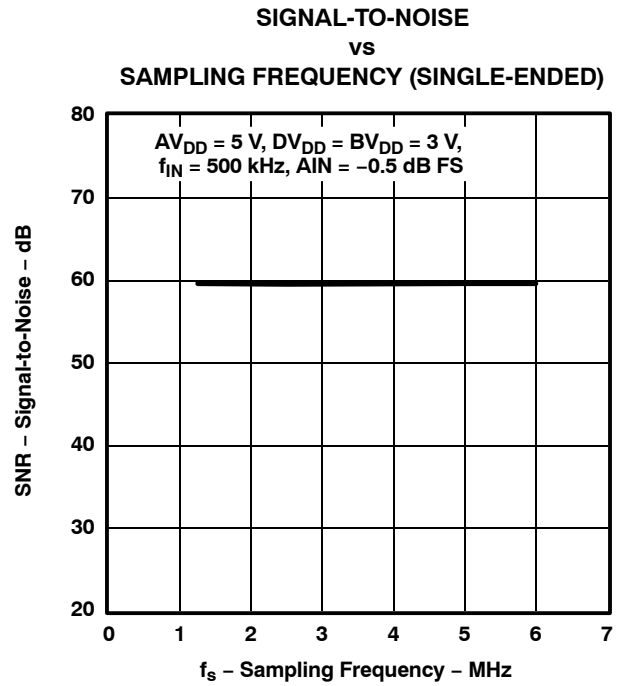

Figure 4

TYPICAL CHARACTERISTICS

TOTAL HARMONIC DISTORTION
vs
SAMPLING FREQUENCY (DIFFERENTIAL)

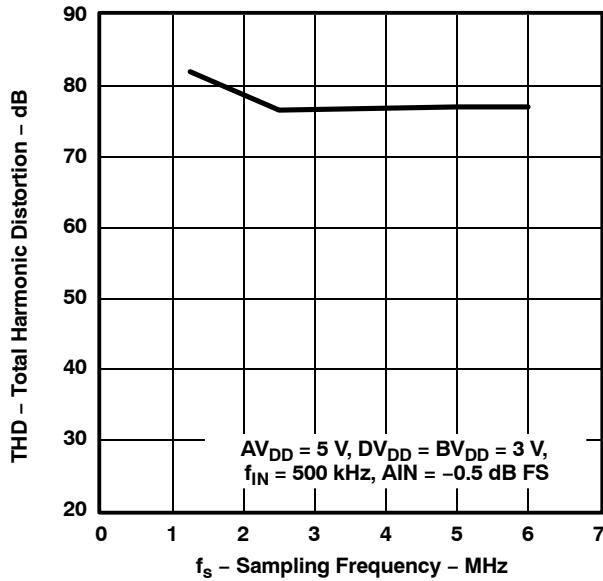

Figure 5

SIGNAL-TO-NOISE AND DISTORTION
vs
SAMPLING FREQUENCY (DIFFERENTIAL)

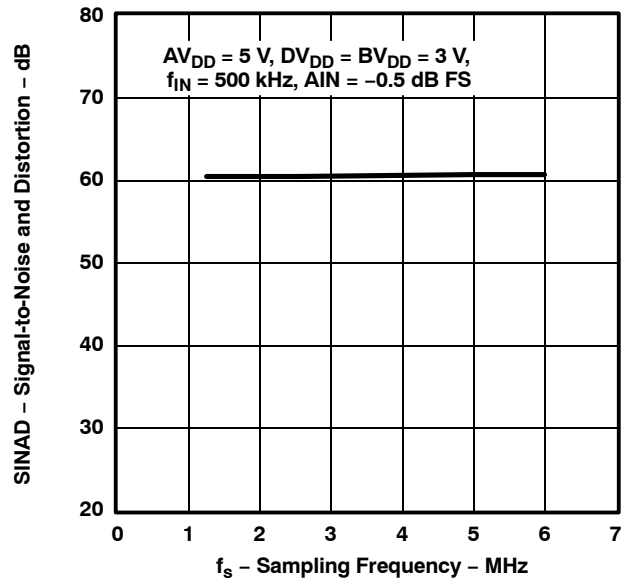

Figure 6

SPURIOUS FREE DYNAMIC RANGE
vs
SAMPLING FREQUENCY (DIFFERENTIAL)

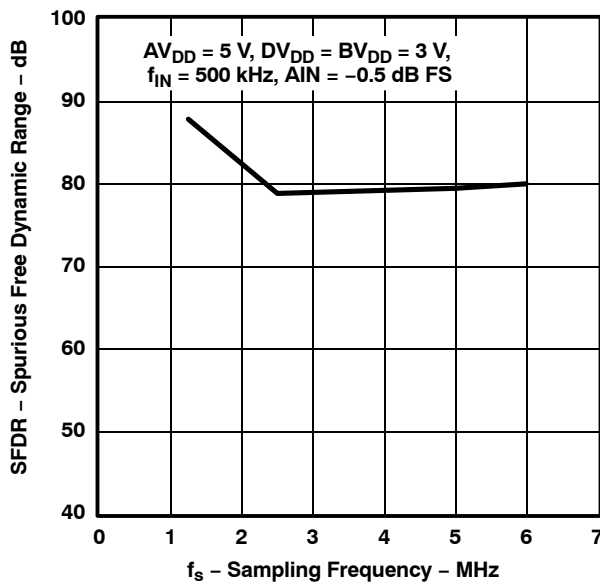

Figure 7

SIGNAL-TO-NOISE
vs
SAMPLING FREQUENCY (DIFFERENTIAL)

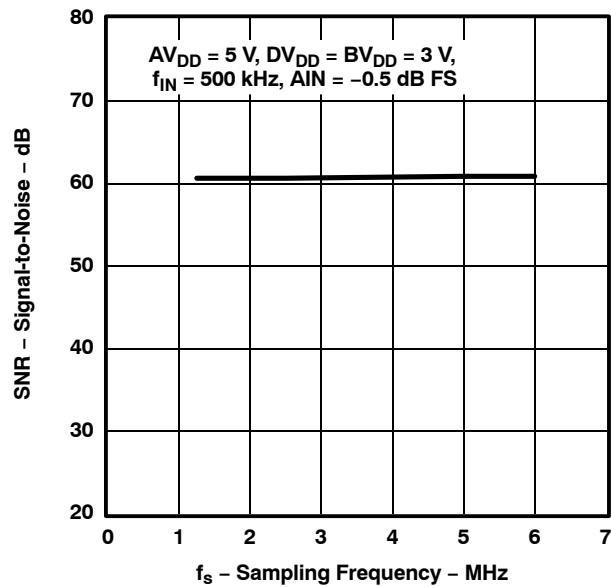

Figure 8

TYPICAL CHARACTERISTICS

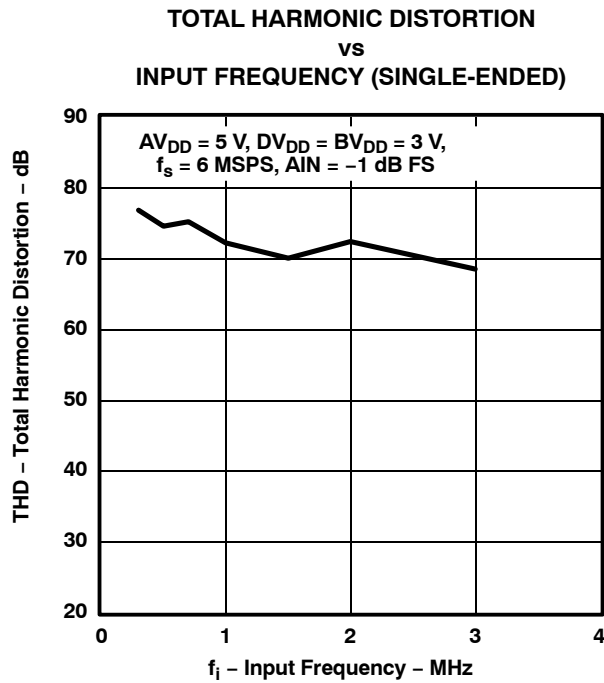

Figure 9

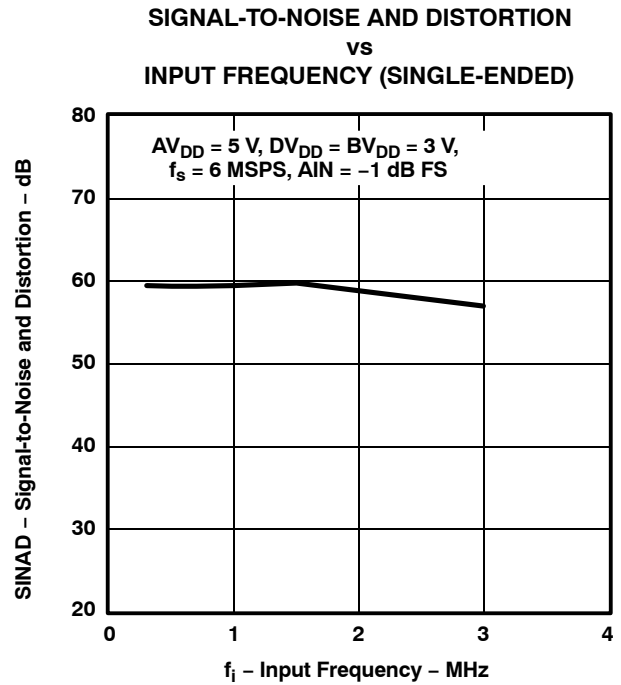

Figure 10

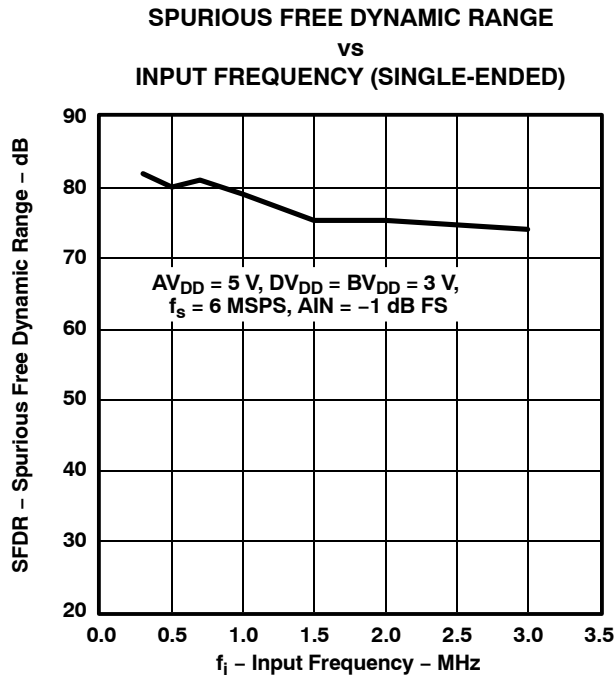

Figure 11

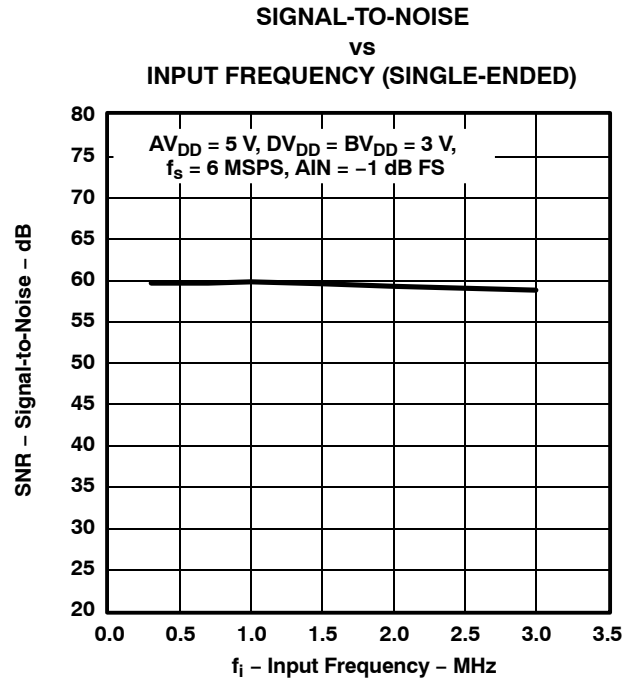

Figure 12

TYPICAL CHARACTERISTICS

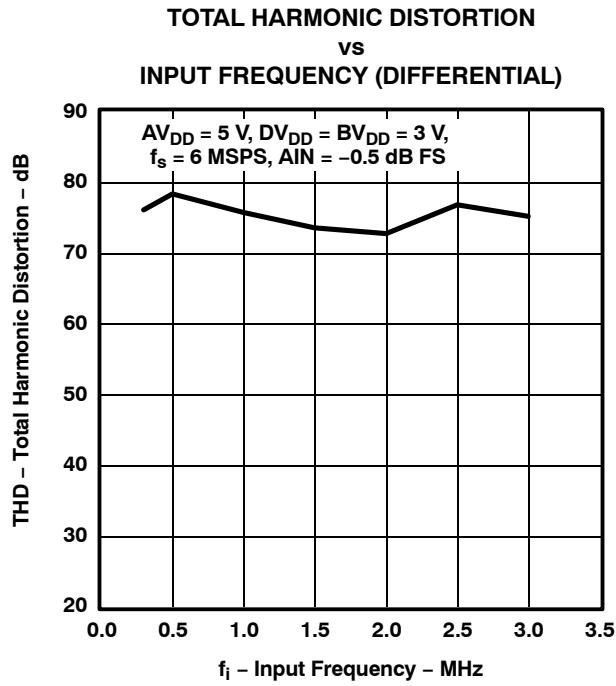

Figure 13

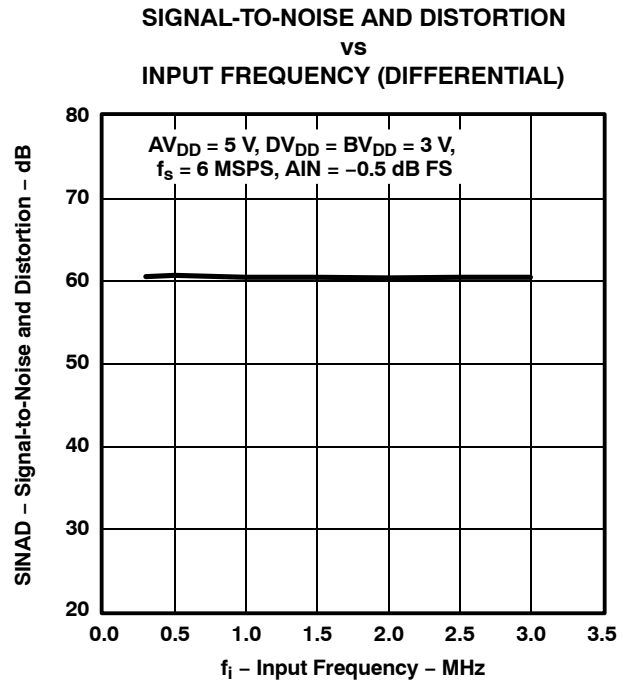

Figure 14

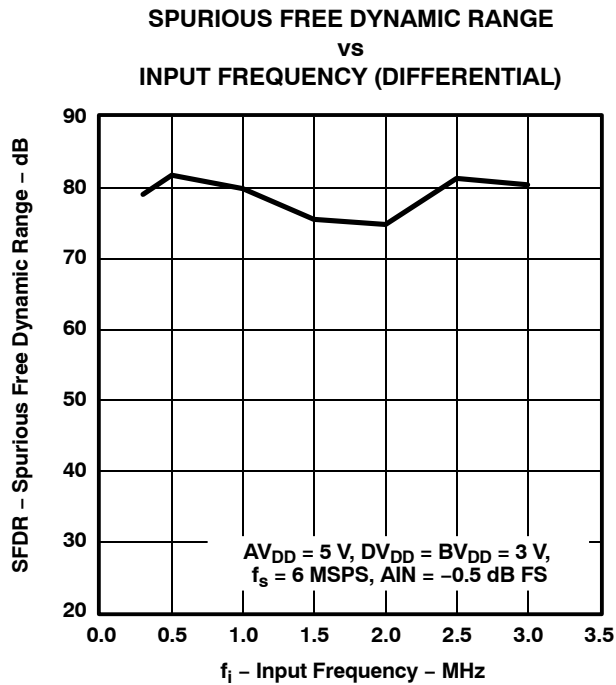

Figure 15

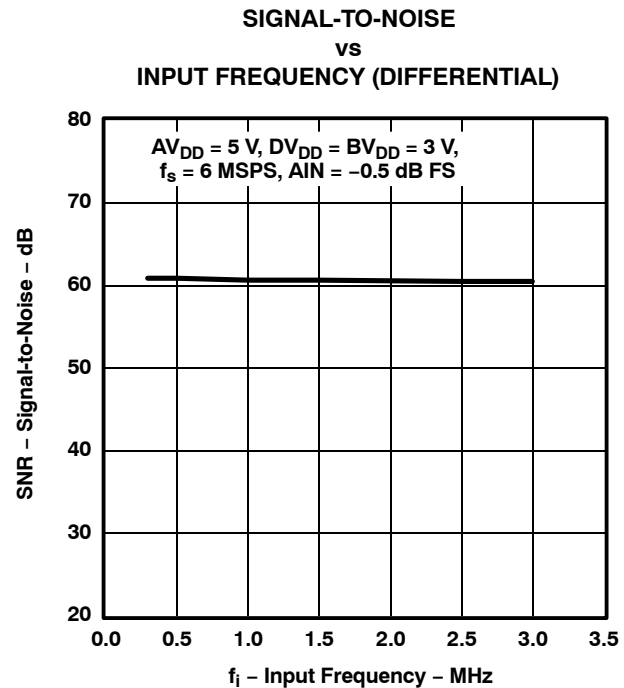
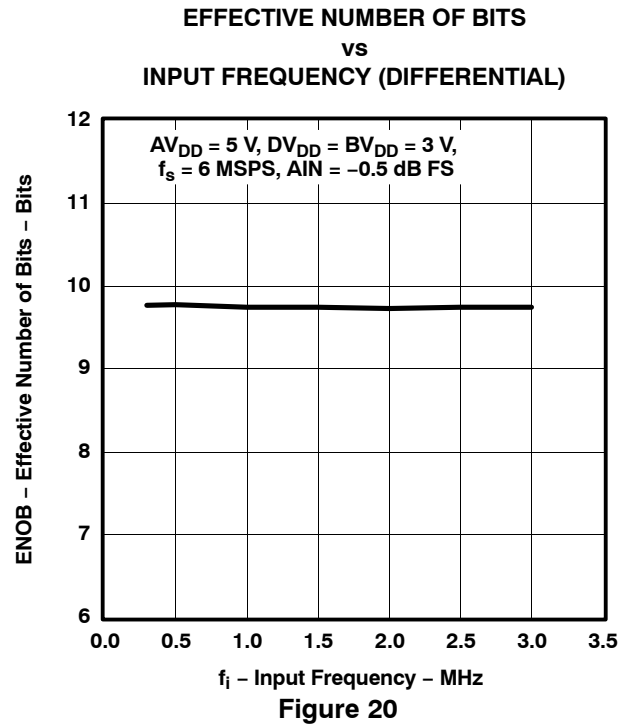
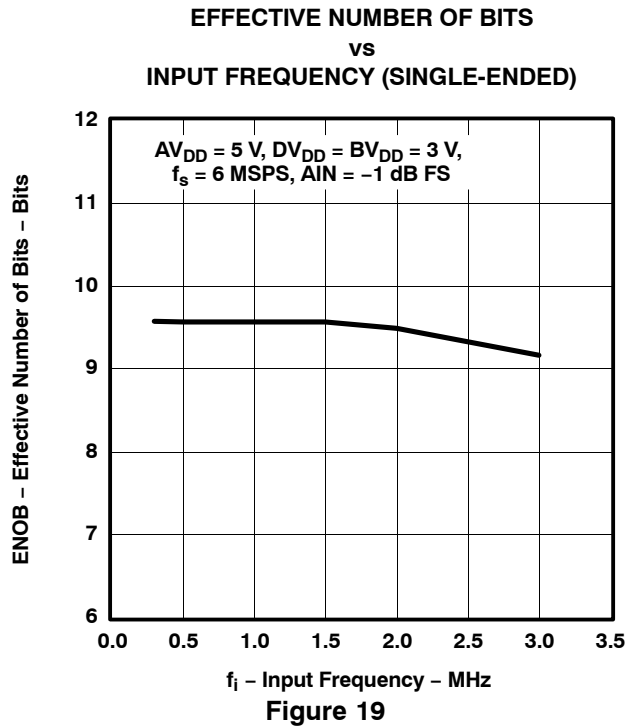
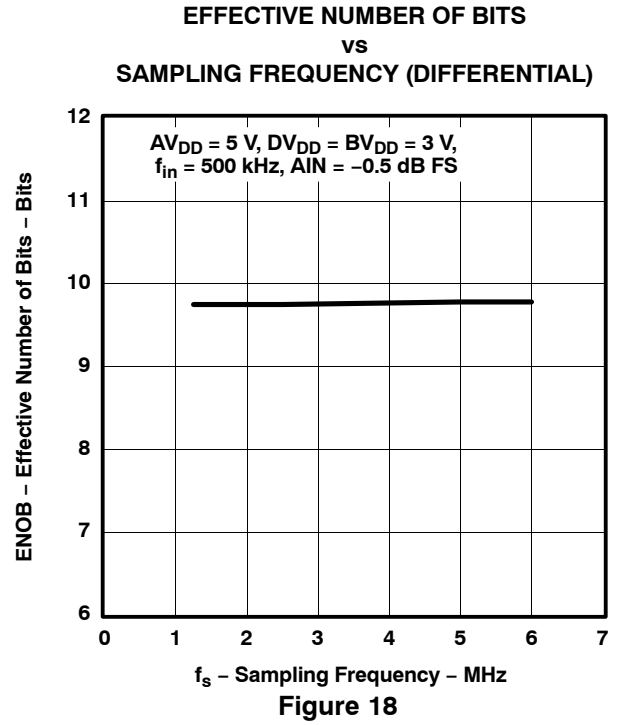
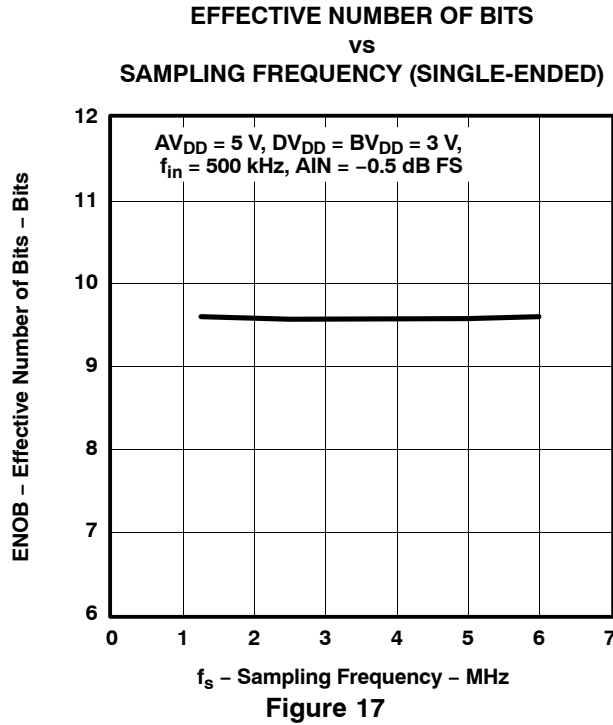

Figure 16

TYPICAL CHARACTERISTICS



TYPICAL CHARACTERISTICS

INTEGRAL NONLINEARITY
vs
TEMPERATURE

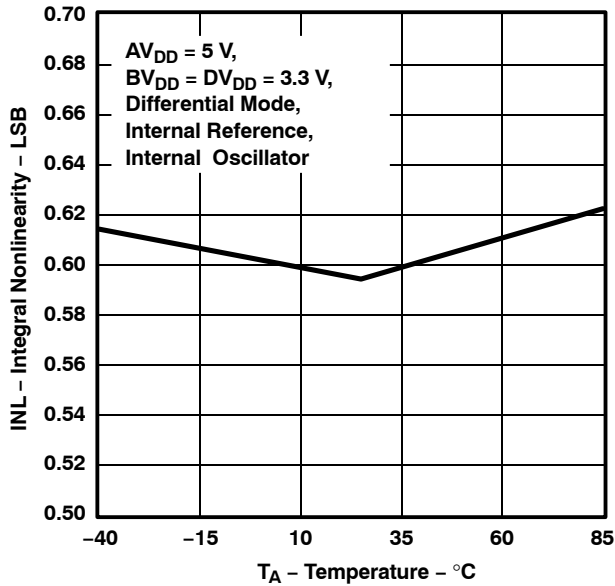

Figure 21

DIFFERENTIAL NONLINEARITY
vs
TEMPERATURE

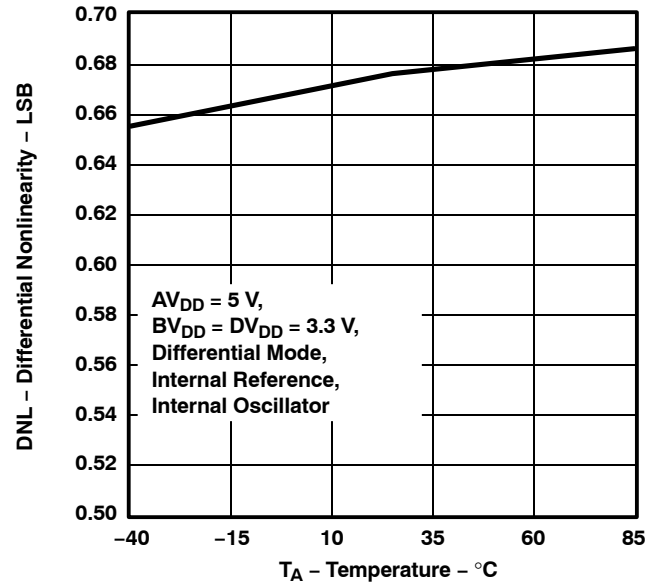

Figure 22

GAIN
vs
INPUT FREQUENCY (SINGLE-ENDED)

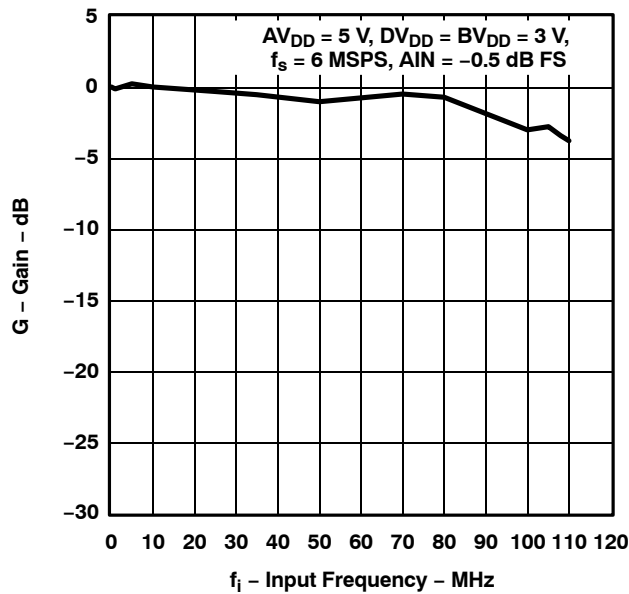

Figure 23

TYPICAL CHARACTERISTICS

FAST FOURIER TRANSFORM (4096 POINTS)
(SINGLE-ENDED)
vs
FREQUENCY

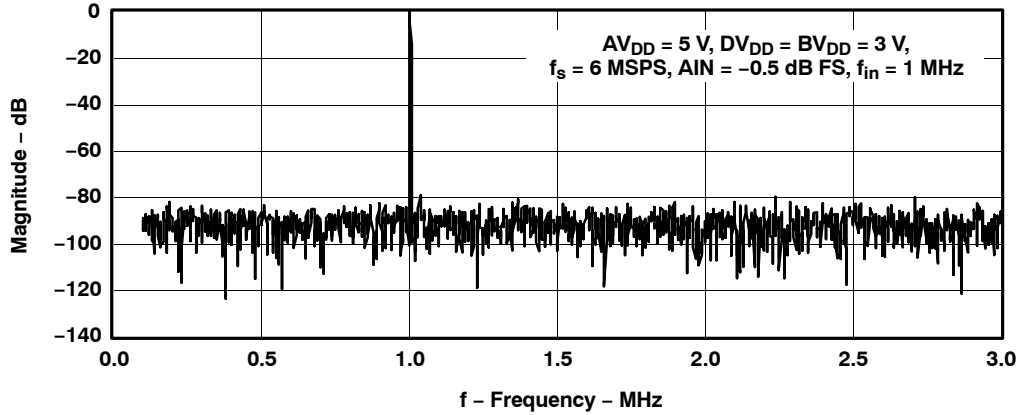

Figure 24

FAST FOURIER TRANSFORM (4096 POINTS)
(DIFFERENTIAL)
vs
FREQUENCY

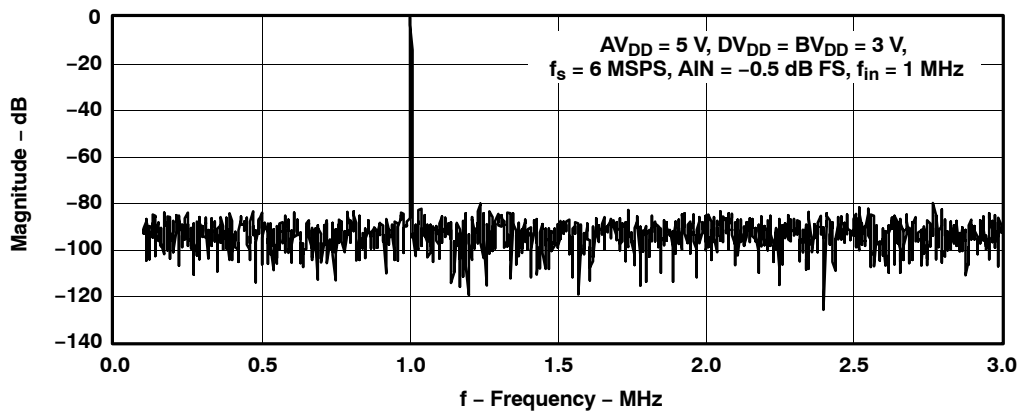

Figure 25

TYPICAL CHARACTERISTICS

**DIFFERENTIAL NONLINEARITY
vs
ADC CODE**

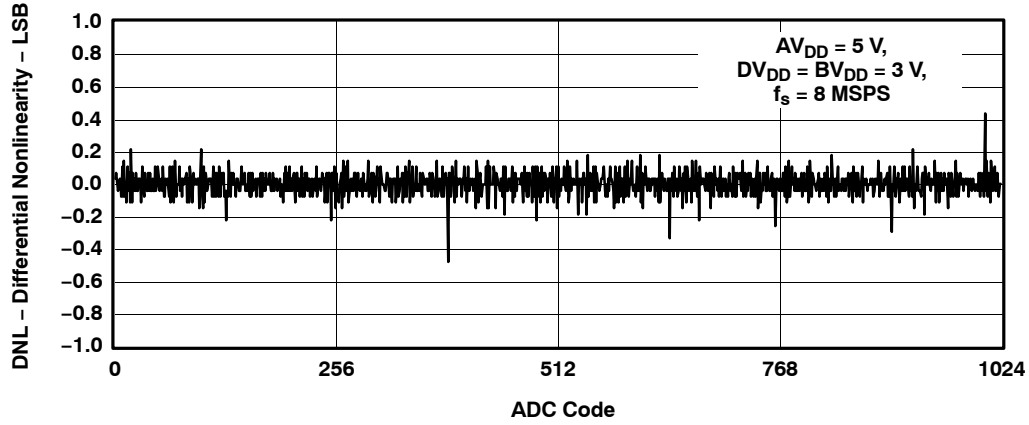

Figure 26

**INTEGRAL NONLINEARITY
vs
ADC CODE**

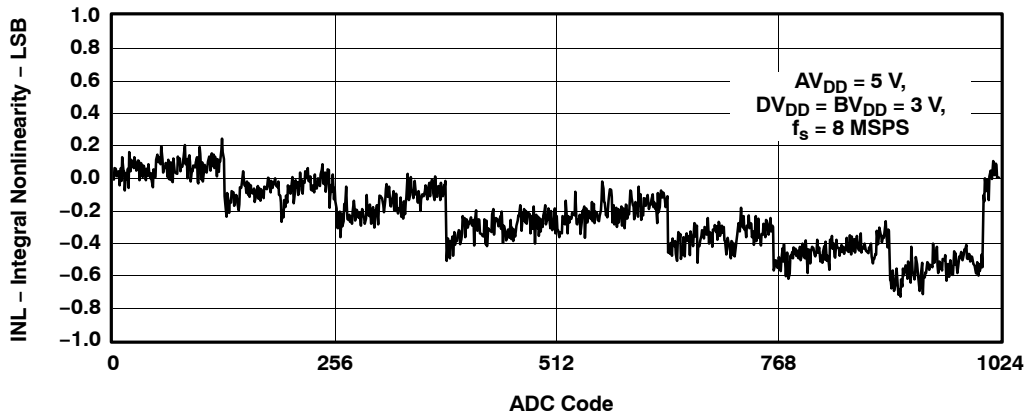

Figure 27

DETAILED DESCRIPTION

Reference Voltage

The THS1007 has a built-in reference, which provides the reference voltages for the ADC. VREFP is set to 3.5 V and VREFM is set to 1.5 V. An external reference can also be used through two reference input pins, REFP and REFM, if the reference source is programmed as external. The voltage levels applied to these pins establish the upper and lower limits of the analog inputs to produce a full-scale and zero-scale reading respectively.

Analog Inputs

The THS1007 consists of 4 analog inputs, which are sampled simultaneously. These inputs can be selected individually and configured as single-ended or differential inputs. The desired analog input channel can be programmed.

Converter

The THS1007 uses a 10-bit pipelined multistaged architecture, which achieves a high sample rate with low power consumption. The THS1007 distributes the conversion over several smaller ADC sub-blocks, refining the conversion with progressively higher accuracy as the device passes the results from stage to stage. This distributed conversion requires a small fraction of the number of comparators used in a traditional flash ADC. A sample-and-hold amplifier (SHA) within each of the stages permits the first stage to operate on a new input sample while the second through the eighth stages operate on the seven preceding samples.

Conversion Clock

An external clock signal with a duty cycle of 50% has to be applied to the clock input (CONV_CLK). A new conversion is started with every falling edge of the applied clock signal. The conversion values are available at the output with a latency of 5 clock cycles.

SYNC

In multichannel mode, the first SYNC signal is delayed by $[7 + (\# \text{ Channels Sampled})]$ cycles of the CONV_CLK after a SYNC reset. This is due to the latency of the pipeline architecture of the THS1007.

Sampling Rate

The maximum possible conversion rate per channel is dependent on the selected analog input channels. Table 1 shows the maximum conversion rate for different combinations.

Table 1. Maximum Conversion Rate in Continuous Conversion Mode

CHANNEL CONFIGURATION	NUMBER OF CHANNELS	MAXIMUM CONVERSION RATE PER CHANNEL
1 single-ended channel	1	6 MSPS
2 single-ended channels	2	3 MSPS
3 single-ended channels	3	2 MSPS
4 single-ended channels	4	1.5 MSPS
1 differential channel	1	6 MSPS
2 differential channels	2	3 MSPS
1 single-ended and 1 differential channel	2	3 MSPS
2 single-ended and 1 differential channels	3	2 MSPS

The maximum conversion rate per channel, f_c , is given by:

$$f_c = \frac{6 \text{ MSPS}}{\# \text{ channels}}$$

Conversion

During conversion, the ADC operates with a free running external clock applied to the input CONV_CLK. With every falling edge of the CONV_CLK signal a new converted value is available to the data bus with the corresponding read signal. The THS1007 allows up to four analog inputs to be selected. The inputs can be configured as two differential channels, four single-ended channels or a combination of differential and single-ended.

To provide the system with channel information, the THS1007 utilizes an active low SYNC signal. When operated in a multichannel configuration, the SYNC signal is active low when data from channel 1 is available to the databus. When operated in single-channel mode (single-ended or differential operation) the SYNC signal is disabled.

Figure 28 shows the timing of the conversion, when one analog input channel is selected. The maximum throughput rate is 6 MSPS in this mode. The signal SYNC is disabled for the selection of one analog input since this information is not necessary. There is a certain timing relationship required for the read signal with respect to the conversion clock. This can be seen in Figure 28 and the timing specifications. A more detailed description of the timing is given in the timing section and signal description of the THS1007.

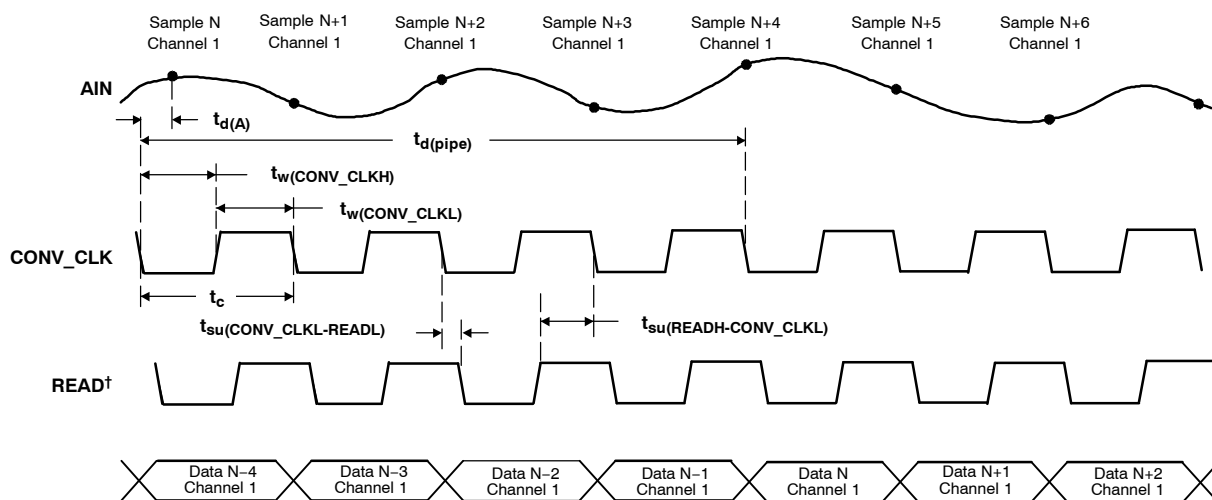

[†]READ is the logical combination from $\overline{CS0}$, CS1 and \overline{RD}

Figure 28. Conversion Timing in 1-Channel Operation

Figure 29 shows the conversion timing when two analog input channels are selected. The maximum throughput rate per channel is 3 MSPS in this mode. The data flow in the bottom of the figure shows the order the converted data is available to the data bus. The SYNC pulse is active low when the data of channel one is available to the databus. The data of channel one is followed by the data of channel two before the SYNC signal is active low again.

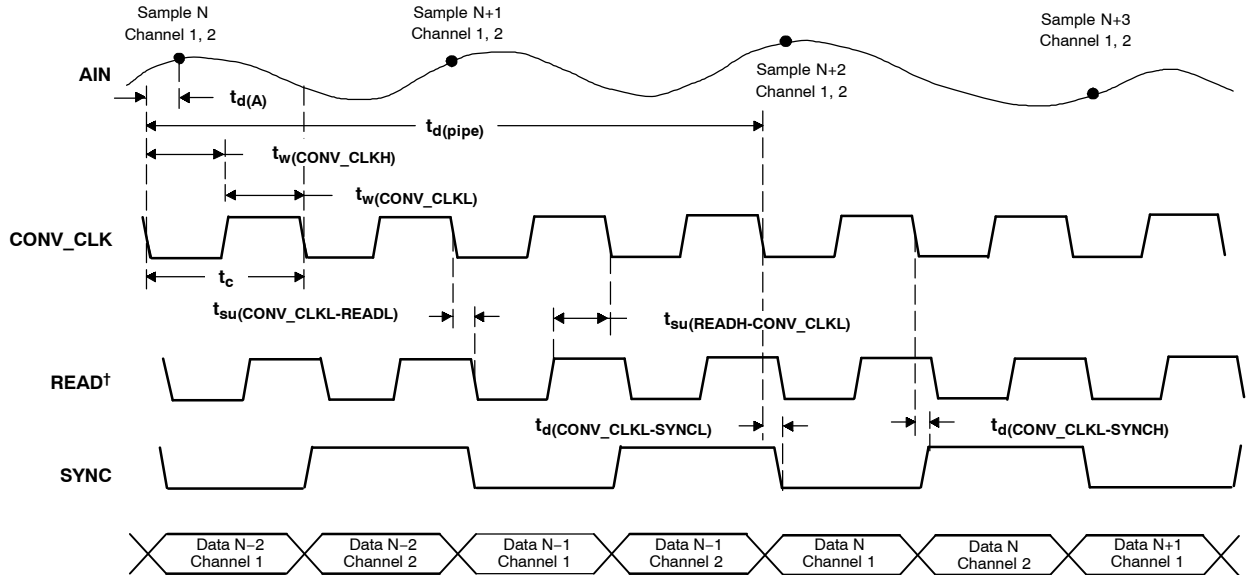

†READ is the logical combination from $\overline{CS0}$, CS1 and \overline{RD}

Figure 29. Conversion Timing in 2-Channel Operation

Figure 30 shows the conversion timing when three analog input channels are selected. The maximum throughput rate per channel is 2 MSPS in this mode. The data flow in the bottom of the figure shows in which order the converted data is available to the data bus. The SYNC signal is active low when the data of channel one is available to the data bus. The data of channel one is followed by the data of channel two and channel three before channel one is again available and the SYNC signal is active low.

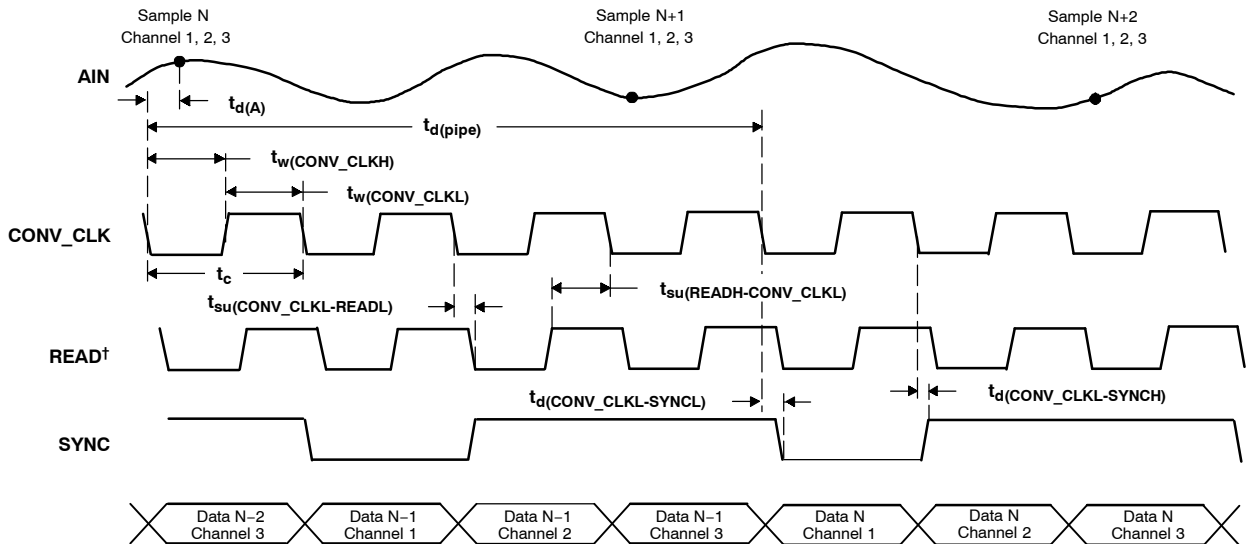

†READ is the logical combination from $\overline{CS0}$, CS1 and \overline{RD}

Figure 30. Conversion Timing in 3-Channel Operation

Figure 31 shows the conversion timing when four analog input channels are selected. The maximum throughput rate per channel is 1.5 MSPS in this mode. The data flow in the bottom of the figure shows in which order the converted data is available to the databus. The SYNC signal is active low when the data of channel one is available to the data bus. The data of channel one is followed by the data of channel two, the data of channel three and the data of channel four before channel one is again available to the databus and SYNC is active low.

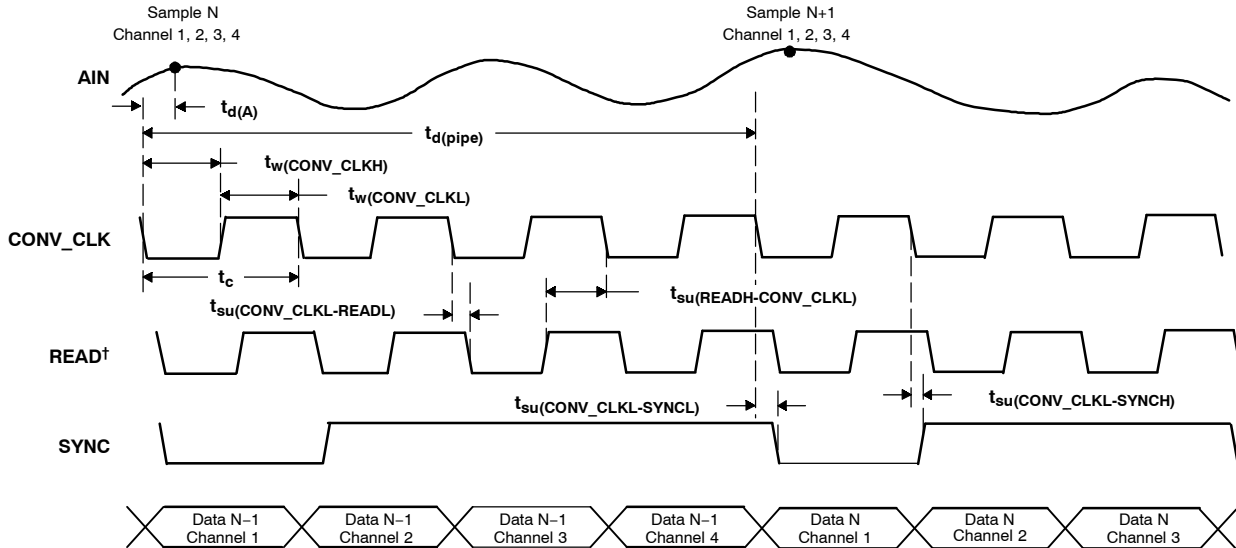

†READ is the logical combination from $\overline{CS0}$, CS1 and \overline{RD}

Figure 31. Timing of Continuous Conversion Mode (4-channel operation)

DIGITAL OUTPUT DATA FORMAT

The digital output data format of the THS1007 can either be in binary format or in twos complement format. The following tables list the digital outputs for the analog input voltages.

Table 2. Binary Output Format for Single-Ended Configuration

SINGLE-ENDED, BINARY OUTPUT	
ANALOG INPUT VOLTAGE	DIGITAL OUTPUT CODE
$A_{IN} = V_{REFP}$	3FFh
$A_{IN} = (V_{REFP} + V_{REFM})/2$	200h
$A_{IN} = V_{REFM}$	000h

Table 3. Two's Complement Output Format for Single-Ended Configuration

SINGLE-ENDED, TWOS COMPLEMENT	
ANALOG INPUT VOLTAGE	DIGITAL OUTPUT CODE
$A_{IN} = V_{REFP}$	1FFh
$A_{IN} = (V_{REFP} + V_{REFM})/2$	000h
$A_{IN} = V_{REFM}$	200h

Table 4. Binary Output Format for Differential Configuration

DIFFERENTIAL, BINARY OUTPUT	
ANALOG INPUT VOLTAGE	DIGITAL OUTPUT CODE
$V_{in} = A_{INP} - A_{INM}$ $V_{REF} = V_{REFP} - V_{REFM}$	
$V_{in} = V_{REF}$	3FFh
$V_{in} = 0$	200h
$V_{in} = -V_{REF}$	000h

Table 5. Two's Complement Output Format for Differential Configuration

DIFFERENTIAL, BINARY OUTPUT	
ANALOG INPUT VOLTAGE	DIGITAL OUTPUT CODE
$V_{in} = A_{INP} - A_{INM}$ $V_{REF} = V_{REFP} - V_{REFM}$	
$V_{in} = V_{REF}$	1FFh
$V_{in} = 0$	000h
$V_{in} = -V_{REF}$	200h

THS1007

SLAS286B – AUGUST 2000– REVISED DECEMBER 2010

ADC CONTROL REGISTER

The THS1007 contains two 10-bit wide control registers (CR0, CR1) in order to program the device into the desired mode. The bit definitions of both control registers are shown in 6.

Table 6. Bit Definitions of Control Register CR0 and CR1

REG	BIT 9	BIT 8	BIT 7	BIT 6	BIT 5	BIT 4	BIT 3	BIT 2	BIT 1	BIT 0
CR0	TEST1	TEST0	SCAN	DIFF1	DIFF0	CHSEL1	CHSEL0	PD	RES	VREF
CR1	RESERVED	OFFSET	BIN/2's	R/W	RES	RES	RES	RES	SRST	RESET

Writing to Control Register 0 and Control Register 1

The 10-bit wide control register 0 and control register 1 can be programmed by addressing the desired control register and writing the register value to the ADC. The addressing is performed with the upper bits RA0 and RA1. During this write process, the data bits D0 to D9 contain the desired control register value. Table 7 shows the addressing of each control register.

Table 7. Control Register Addressing

D0 – D9	RA0	RA1	Addressed Control Register
Desired register value	0	0	Control register 0
Desired register value	1	0	Control register 1
Desired register value	0	1	Reserved for future
Desired register value	1	1	Reserved for future

INITIALIZATION OF THE THS1007

The initialization of the THS1007 should be done according to the configuration flow shown in Figure 32.

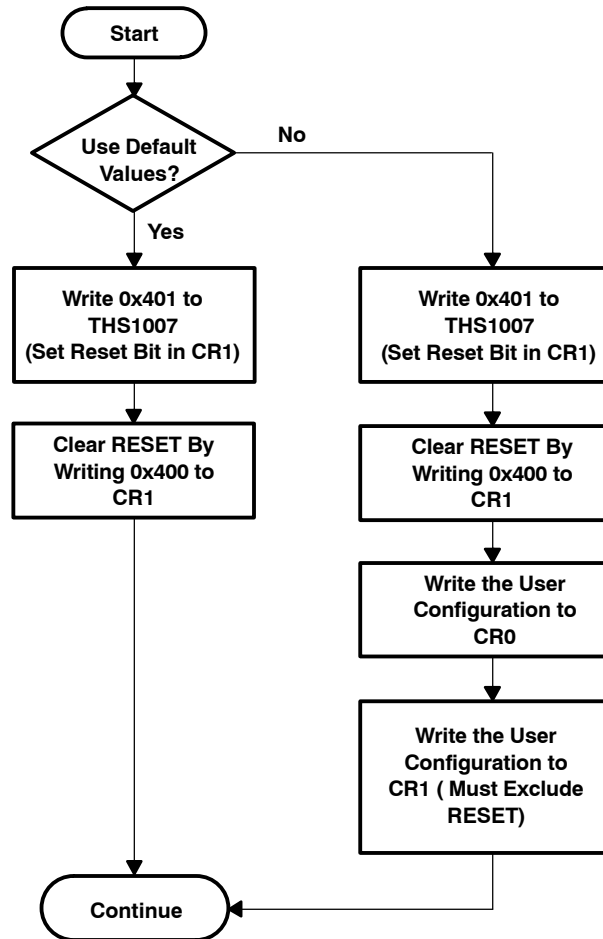

Figure 32. THS1007 Configuration Flow

THS1007

SLAS286B – AUGUST 2000– REVISED DECEMBER 2010

ADC CONTROL REGISTERS

Control Register 0, Write Only (see Table 7)

BIT 11	BIT 10	BIT 9	BIT 8	BIT 7	BIT 6	BIT 5	BIT 4	BIT 3	BIT 2	BIT 1	BIT 0
0	0	TEST1	TEST0	SCAN	DIFF1	DIFF0	CHSEL1	CHSEL0	PD	RES	VREF

Table 8. Control Register 0 Bit Functions

BITS	RESET VALUE	NAME	FUNCTION
0	0	VREF	Vref select: Bit 0 = 0 → The internal reference is selected Bit 0 = 1 → The external reference voltage is used for the ADC
1	0	RES	RESERVED
2	0	PD	Power down. Bit 2 = 0 → The ADC is active Bit 2 = 1 → Power down The reading and writing to and from the digital outputs is possible during power down.
3, 4	0,0	CHSEL0, CHSEL1	Channel select Bit 3 and bit 4 select the analog input channel of the ADC. Refer to Table 9.
5,6	1,0	DIFF0, DIFF1	Number of differential channels Bit 5 and bit 6 contain information about the number of selected differential channels. Refer to Table 9.
7	0	SCAN	Autoscan enable Bit 7 enables or disables the autoscan function of the ADC. Refer to Table 9.
8,9	0,0	TEST0, TEST1	Test input enable Bit 8 and bit 9 control the test function of the ADC. Three different test voltages can be measured. This feedback allows the check of all hardware connections and the ADC operation. Refer to Table 10 for selection of the three different test voltages.

ANALOG INPUT CHANNEL SELECTION

The analog input channels of the THS1007 can be selected via bits 3 to 7 of control register 0. One single channel (single-ended or differential) is selected via bit 3 and bit 4 of control register 0. Bit 5 controls the selection between single-ended and differential configuration. Bit 6 and bit 7 select the autoscan mode, if more than one input channel is selected. Table 10 shows the possible selections.

Table 9. Analog Input Channel Configurations

BIT 7 SCAN	BIT 6 DIFF1	BIT 5 DIFF0	BIT 4 CHSEL1	BIT 3 CHSEL0	DESCRIPTION OF THE SELECTED INPUTS
0	0	0	0	0	Analog input AINP (single ended)
0	0	0	0	1	Analog input AINM (single ended)
0	0	0	1	0	Analog input BINP (single ended)
0	0	0	1	1	Analog input BINM (single ended)
0	0	1	0	0	Differential channel (AINP–AINM)
0	0	1	0	1	Differential channel (BINP–BINM)
1	0	0	0	1	Autoscan two single ended channels: AINP, AINM, AINP, ...
1	0	0	1	0	Autoscan three single ended channels: AINP, AINM, BINP, AINP, ...
1	0	0	1	1	Autoscan four single ended channels: AINP, AINM, BINP, BINM, AINP, ...
1	0	1	0	1	Autoscan one differential channel and one single ended channel AINP, (BINP–BINM), AINP, (BINP–BINM), ...
1	0	1	1	0	Autoscan one differential channel and two single ended channel AINP, AINM, (BINP–BINM), AINP, ...
1	1	0	0	1	Autoscan two differential channels (AINP–AINM), (BINP–BINM), (AINP–AINM), ...
0	0	1	1	0	Reserved
0	0	1	1	1	Reserved
1	0	0	0	0	Reserved
1	0	1	0	0	Reserved
1	0	1	1	1	Reserved
1	1	0	0	0	Reserved
1	1	0	1	0	Reserved
1	1	0	1	1	Reserved
1	1	1	0	0	Reserved
1	1	1	0	1	Reserved
1	1	1	1	0	Reserved
1	1	1	1	1	Reserved

Test Mode

The test mode of the ADC is selected via bit 8 and bit 9 of control register 0. The different selections are shown in Table 10.

Table 10. Test Mode

BIT 9 TEST1	BIT 8 TEST0	OUTPUT RESULT
0	0	Normal mode
0	1	V_{REFP}
1	0	$((V_{REFM})+(V_{REFP}))/2$
1	1	V_{REFM}

Three different options can be selected. This feature allows support testing of hardware connections between the ADC and the processor.

Control Register 1, Write Only (see Table 7)

BIT 11	BIT10	BIT 9	BIT 8	BIT 7	BIT 6	BIT 5	BIT 4	BIT 3	BIT 2	BIT 1	BIT 0
0	1	RESERVED	OFFSET	BIN/2s	R/ \bar{W}	RES	RES	RES	RES	SRST	RESET

Table 11. Control Register 1 Bit Functions

BITS	RESET VALUE	NAME	FUNCTION
0	0	RESET	Reset Writing a 1 into this bit resets the device and sets the control register 0 and control register 1 to the reset values. To bring the device out of RESET, a 0 has to be written into this bit.
1	0	SRST	Writing a 1 into this bit resets the sync generator. When running in multichannel mode, this must be set during the configuration cycle.
2, 3	0,0	RES	Reserved
4	1	RES	Reserved
5	1	RES	Reserved
6	0	R/ \bar{W}	R/ \bar{W} , RD/ $\bar{W}\bar{R}$ selection Bit 6 of control register 1 controls the function of the inputs $\bar{R}\bar{D}$ and $\bar{W}\bar{R}$. When bit 6 in control register 1 is set to 1, $\bar{W}\bar{R}$ becomes a R/ \bar{W} input and $\bar{R}\bar{D}$ is disabled. From now on a read is signalled with R/W high and a write with R/W as a low signal. If bit 6 in control register 1 is set to 0, the input $\bar{R}\bar{D}$ becomes a read input and the input $\bar{W}\bar{R}$ becomes a write input.
7	0	BIN/2s	Complement select If bit 7 of control register 1 is set to 0, the output value of the ADC is in twos complement. If bit 7 of control register 1 is set to 1, the output value of the ADC is in binary format. Refer to Table 2 through Table 5.
8	0	OFFSET	Offset cancellation mode Bit 8 = 0 → normal conversion mode Bit 8 = 1 → offset calibration mode If a 1 is written into bit 8 of control register 1, the device internally sets the inputs to zero and does a conversion. The conversion result is stored in an offset register and subtracted from all conversions in order to reduce the offset error.
9	0	RESERVED	Always write 0.

TIMING AND SIGNAL DESCRIPTION OF THE THS1007

The reading from the THS1007 and writing to the THS1007 is performed by using the chip select inputs ($\overline{CS0}$, CS1), the write input \overline{WR} and the read input \overline{RD} . The write input is configurable to a combined read/write input ($\overline{R/\overline{W}}$). This is desired in cases where the connected processor consists of a combined read/write output signal ($\overline{R/\overline{W}}$). The two chip select inputs can be used to interface easily to a processor.

Reading from the THS1007 takes place by an internal \overline{RD}_{int} signal, which is generated from the logical combination of the external signals $\overline{CS0}$, CS1 and \overline{RD} (see Figure 33). This signal is then used to strobe the words and to enable the output buffers. The last external signal (either $\overline{CS0}$, CS1 or \overline{RD}) to become valid makes \overline{RD}_{int} active while the write input (\overline{WR}) is inactive. The first of those external signals switching to its inactive state deactivates \overline{RD}_{int} again.

Writing to the THS1007 takes place by an internal \overline{WR}_{int} signal, which is generated from the logical combination of the external signals $\overline{CS0}$, CS1 and \overline{WR} . This signal strobes the control words into the control registers 0 and 1. The last external signal (either $\overline{CS0}$, CS1 or \overline{WR}) to become valid switches \overline{WR}_{int} active while the read input (RD) is inactive. The first of those external signals going to its inactive state deactivates \overline{WR}_{int} again.

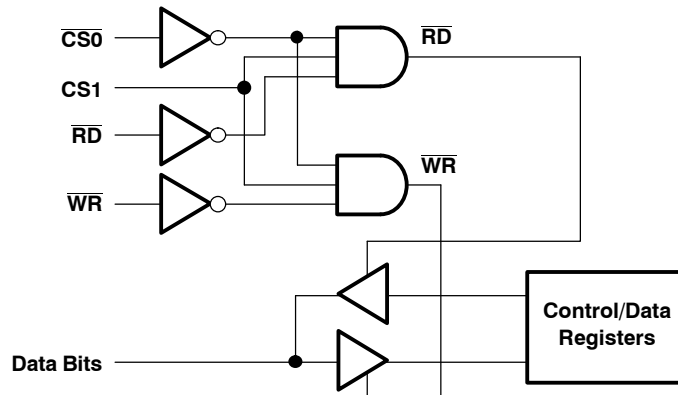

Figure 33. Logical Combination of $\overline{CS0}$, CS1, \overline{RD} , and \overline{WR}

Read Timing (using $\overline{R/\overline{W}}$, $\overline{CS0}$ -controlled)

Figure 34 shows the read-timing behavior when the $\overline{WR}(\overline{R/\overline{W}})$ input is programmed as a combined read-write input $\overline{R/\overline{W}}$. The \overline{RD} input has to be tied to high-level in this configuration. This timing is called $\overline{CS0}$ -controlled because $\overline{CS0}$ is the last external signal of $\overline{CS0}$, $CS1$, and $\overline{R/\overline{W}}$ which becomes valid. The reading of the data should be done with a certain timing relative to the conversion clock $CONV_CLK$, as illustrated in Figure 34.

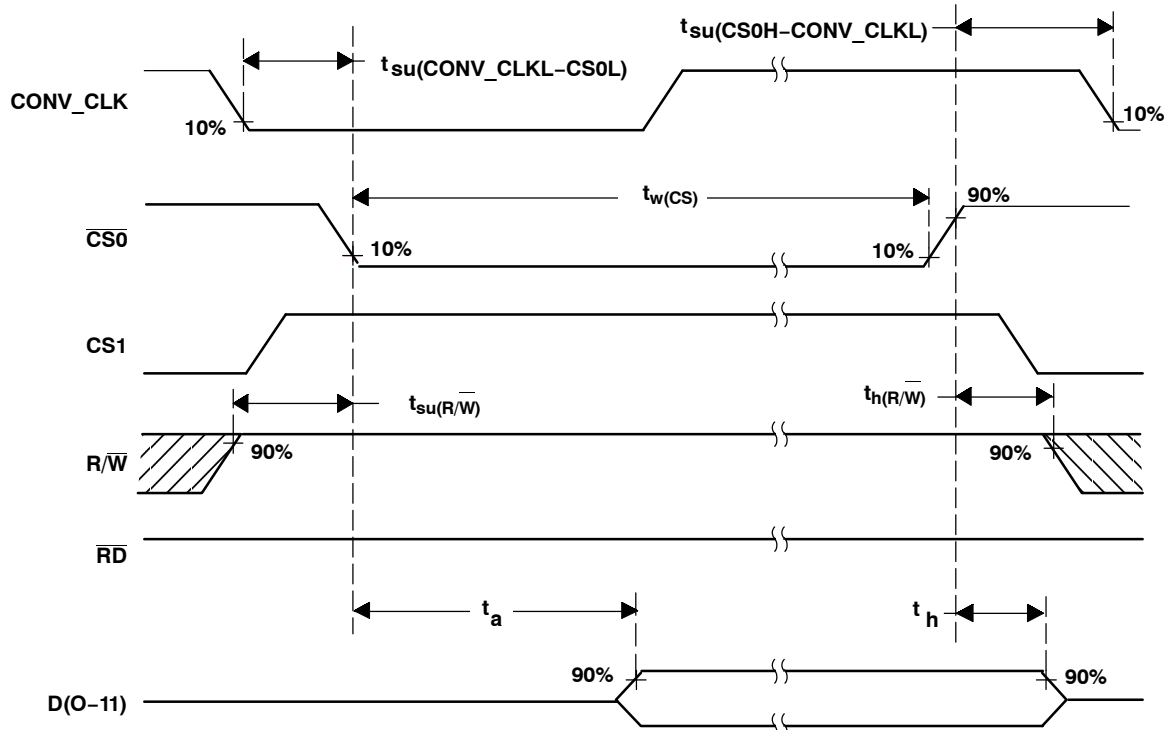

Figure 34. Read Timing Diagram Using $\overline{R/\overline{W}}$ ($\overline{CS0}$ -controlled)

Read Timing Parameter ($\overline{CS0}$ -controlled)†

PARAMETER		MIN	TYP	MAX	UNIT
$t_{su}(CONV_CLKL-CS0L)$	Setup time, $CONV_CLK$ low before CS valid	10			ns
$t_{su}(CS0H-CONV_CLKL)$	Setup time, CS invalid to $CONV_CLK$ low	20			ns
$t_{su}(\overline{R/\overline{W}})$	Setup time, $\overline{R/\overline{W}}$ high to last CS valid	0			ns
t_a	Access time, last CS valid to data valid	0		10	ns
t_h	Hold time, first CS invalid to data invalid	0		5	ns
$t_{h}(\overline{R/\overline{W}})$	Hold time, first external CS invalid to $\overline{R/\overline{W}}$ change	5			ns
$t_w(CS)$	Pulse duration, CS active	10			ns

Write Timing (using $\overline{R/\overline{W}}$, $\overline{CS0}$ -controlled)

Figure 35 shows the write-timing behavior when the $\overline{WR}(\overline{R/\overline{W}})$ input is programmed as a combined read-write input $\overline{R/\overline{W}}$. The \overline{RD} input has to be tied to high-level in this configuration. This timing is called $\overline{CS0}$ -controlled because $\overline{CS0}$ is the last external signal of $\overline{CS0}$, $\overline{CS1}$, and $\overline{R/\overline{W}}$ which becomes valid. The write into the THS1007 can be performed irrespective of the conversion clock signal CONV_CLK .

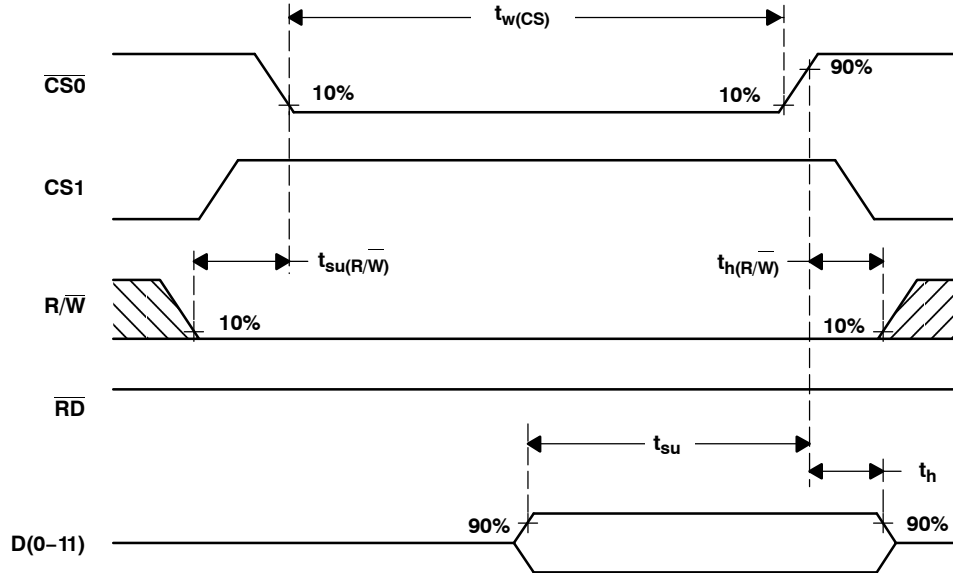

Figure 35. Write Timing Diagram Using $\overline{R/\overline{W}}$ ($\overline{CS0}$ -controlled)

Read Timing Parameter ($\overline{CS0}$ -controlled)[†]

PARAMETER		MIN	TYP	MAX	UNIT
$t_{su(\overline{R/\overline{W}})}$	Setup time, $\overline{R/\overline{W}}$ stable to last CS valid	0			ns
t_{su}	Setup time, data valid to first CS invalid	5			ns
t_h	Hold time, first CS invalid to data invalid	2			ns
$t_{h(\overline{R/\overline{W}})}$	Hold time, first CS invalid to $\overline{R/\overline{W}}$ change	5			ns
$t_w(\overline{CS})$	Pulse duration, CS active	10			ns

ANALOG INPUT CONFIGURATION AND REFERENCE VOLTAGE

The THS1007 features four analog input channels. These can be configured for either single-ended or differential operation. Figure 36 shows a simplified model, where a single-ended configuration for channel AINP is selected. The reference voltages for the ADC itself are V_{REFP} and V_{REFM} (either internal or external reference voltage). The analog input voltage range is between V_{REFM} to V_{REFP} . This means that V_{REFM} defines the minimum voltage, and V_{REFP} defines the maximum voltage, which can be applied to the ADC. The internal reference source provides the voltage V_{REFM} of 1.5 V and the voltage V_{REFP} of 3.5 V (see also section reference voltage). The resulting analog input voltage swing of 2 V can be expressed by:

$$V_{REFM} \leq AINP \leq V_{REFP} \quad (1)$$

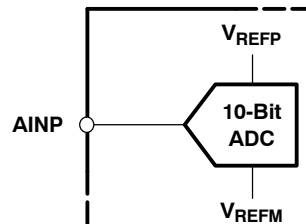

Figure 36. Single-Ended Input Stage

A differential operation is desired in many applications due to a better signal-to-noise ration. Figure 37 shows a simplified model for the analog inputs AINM and AINP, which are configured for differential operation. The differential operation mode provides in terms of performance benefits over the single-ended mode and is therefore recommended for best performance. The THS1007 offers 2 differential analog inputs and in the single-ended mode 4 analog inputs. If the analog input architecture is different, common-mode voltages can be rejected. Additional details for both modes are given below.

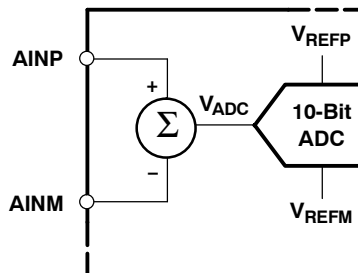

Figure 37. Differential Input Stage

In comparison to the single-ended configuration it can be seen that the voltage V_{ADC} , which is applied at the input of the ADC, is the difference between the input AINP and AINM. The voltage V_{ADC} can be calculated as follows:

$$V_{ADC} = \text{ABS}(AINP - AINM) \quad (2)$$

An advantage to single-ended operation is that the common-mode voltage

$$V_{CM} = \frac{AINM + AINP}{2} \quad (3)$$

can be rejected in the differential configuration, if the following condition for the analog input voltages is true:

$$AGND \leq AINM, AINP \leq AV_{DD} \quad (4)$$

$$1 \text{ V} \leq V_{CM} \leq 4 \text{ V} \quad (5)$$

SINGLE-ENDED MODE OF OPERATION

The THS1007 can be configured for single-ended operation using dc or ac coupling. In either case, the input of the THS1007 must be driven from an operational amplifier that does not degrade the ADC performance. Because the THS1007 operates from a 5-V single supply, it is necessary to level-shift ground-based bipolar signals to comply with its input requirements. This can be achieved with dc and ac-coupling.

DC COUPLING

An operational amplifier can be configured to shift the signal level according to the analog input voltage range of the THS1007. The analog input voltage range of the THS1007 goes from 1.5 V to 3.5 V. An operational amplifier can be used as shown in Figure 38.

Figure 38 shows an example with the analog input signal in the range between -1 V up to 1 V. This signal is shifted by an operational amplifier to the analog input range of the THS1007 (1.5 V to 3.5 V). The operational amplifier is configured as an inverting amplifier with a gain of -1 . The required dc voltage of 1.25 V at the noninverting input is derived from the 2.5-V output reference REFOUT of the THS1007 by using a resistor divider. Therefore, the operational amplifier output voltage is centered at 2.5 V. The $10\ \mu\text{F}$ tantalum capacitor is required for bypassing REFOUT. REFIN of the THS1007 must be connected directly to REFOUT in single-ended mode. The use of ratio matched, thin-film resistor networks minimizes gain and offset errors.

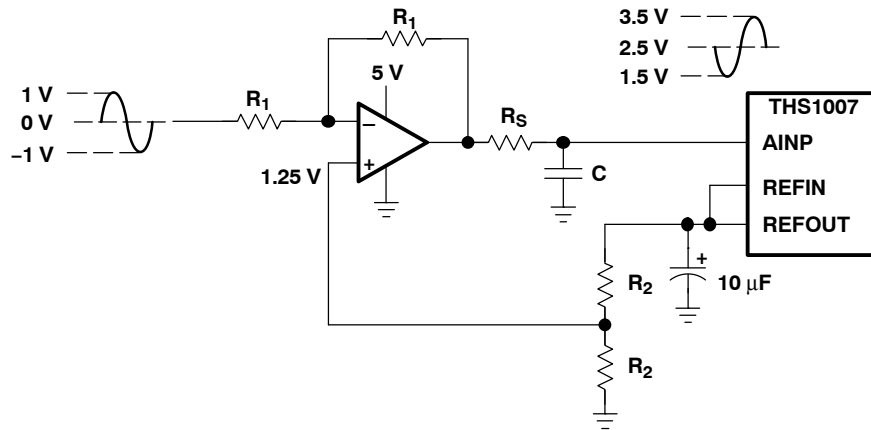

Figure 38. Level-Shift for DC-Coupled Input

DIFFERENTIAL MODE OF OPERATION

For the differential mode of operation, a conversion from single-ended to differential is required. A conversion to differential signals can be achieved by using an RF-transformer, which provides a center tap. Best performance is achieved in differential mode.

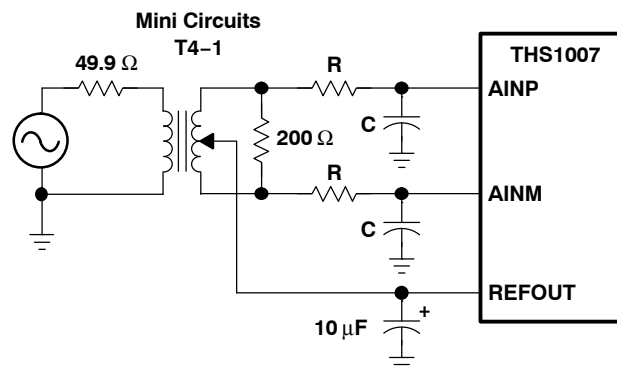

Figure 39. Transformer Coupled Input

DEFINITIONS OF SPECIFICATIONS AND TERMINOLOGY**Integral Nonlinearity**

Integral nonlinearity refers to the deviation of each individual code from a line drawn from zero through full scale. The point used as zero occurs 1/2 LSB before the first code transition. The full-scale point is defined as level 1/2 LSB beyond the last code transition. The deviation is measured from the center of each particular code to the true straight line between these two points.

Differential Nonlinearity

An ideal ADC exhibits code transitions that are exactly 1 LSB apart. DNL is the deviation from this ideal value. A differential nonlinearity error of less than ± 1 LSB ensures no missing codes.

Zero Offset

The major carry transition should occur when the analog input is at zero volts. Zero error is defined as the deviation of the actual transition from that point.

Gain Error

The first code transition should occur at an analog value 1/2 LSB above negative full scale. The last transition should occur at an analog value 1 1/2 LSB below the nominal full scale. Gain error is the deviation of the actual difference between first and last code transitions and the ideal difference between first and last code transitions.

Signal-to-noise Ratio + Distortion (SINAD)

SINAD is the ratio of the rms value of the measured input signal to the rms sum of all other spectral components below the Nyquist frequency, including harmonics but excluding dc. The value for SINAD is expressed in decibels.

Effective Number of Bits (ENOB)

For a sine wave, SINAD can be expressed in terms of the number of bits. Using the following formula,

$$N = \frac{(\text{SINAD} - 1.76)}{6.02}$$

it is possible to get a measure of performance expressed as N, the effective number of bits. Thus, the effective number of bits for a device for sine wave inputs at a given input frequency can be calculated directly from its measured SINAD.

Total Harmonic Distortion (THD)

THD is the ratio of the rms sum of the first six harmonic components to the rms value of the measured input signal and is expressed as a percentage or in decibels.

Spurious Free Dynamic Range (SFDR)

SFDR is the difference in dB between the rms amplitude of the input signal and the peak spurious signal.

PACKAGING INFORMATION

Orderable Device	Status (1)	Package Type	Package Drawing	Pins	Package Qty	Eco Plan (2)	Lead/Ball Finish (6)	MSL Peak Temp (3)	Op Temp (°C)	Device Marking (4/5)	Samples
THS1007CDA	ACTIVE	TSSOP	DA	32	46	Green (RoHS & no Sb/Br)	CU NIPDAU	Level-2-260C-1 YEAR	0 to 70	THS1007	Samples
THS1007IDA	ACTIVE	TSSOP	DA	32	46	Green (RoHS & no Sb/Br)	CU NIPDAU	Level-2-260C-1 YEAR	-40 to 85	THS1007I	Samples

(1) The marketing status values are defined as follows:

ACTIVE: Product device recommended for new designs.

LIFEBUY: TI has announced that the device will be discontinued, and a lifetime-buy period is in effect.

NRND: Not recommended for new designs. Device is in production to support existing customers, but TI does not recommend using this part in a new design.

PREVIEW: Device has been announced but is not in production. Samples may or may not be available.

OBSELETE: TI has discontinued the production of the device.

(2) Eco Plan - The planned eco-friendly classification: Pb-Free (RoHS), Pb-Free (RoHS Exempt), or Green (RoHS & no Sb/Br) - please check <http://www.ti.com/productcontent> for the latest availability information and additional product content details.

TBD: The Pb-Free/Green conversion plan has not been defined.

Pb-Free (RoHS): TI's terms "Lead-Free" or "Pb-Free" mean semiconductor products that are compatible with the current RoHS requirements for all 6 substances, including the requirement that lead not exceed 0.1% by weight in homogeneous materials. Where designed to be soldered at high temperatures, TI Pb-Free products are suitable for use in specified lead-free processes.

Pb-Free (RoHS Exempt): This component has a RoHS exemption for either 1) lead-based flip-chip solder bumps used between the die and package, or 2) lead-based die adhesive used between the die and leadframe. The component is otherwise considered Pb-Free (RoHS compatible) as defined above.

Green (RoHS & no Sb/Br): TI defines "Green" to mean Pb-Free (RoHS compatible), and free of Bromine (Br) and Antimony (Sb) based flame retardants (Br or Sb do not exceed 0.1% by weight in homogeneous material)

(3) MSL, Peak Temp. - The Moisture Sensitivity Level rating according to the JEDEC industry standard classifications, and peak solder temperature.

(4) There may be additional marking, which relates to the logo, the lot trace code information, or the environmental category on the device.

(5) Multiple Device Markings will be inside parentheses. Only one Device Marking contained in parentheses and separated by a "~" will appear on a device. If a line is indented then it is a continuation of the previous line and the two combined represent the entire Device Marking for that device.

(6) Lead/Ball Finish - Orderable Devices may have multiple material finish options. Finish options are separated by a vertical ruled line. Lead/Ball Finish values may wrap to two lines if the finish value exceeds the maximum column width.

Important Information and Disclaimer: The information provided on this page represents TI's knowledge and belief as of the date that it is provided. TI bases its knowledge and belief on information provided by third parties, and makes no representation or warranty as to the accuracy of such information. Efforts are underway to better integrate information from third parties. TI has taken and continues to take reasonable steps to provide representative and accurate information but may not have conducted destructive testing or chemical analysis on incoming materials and chemicals. TI and TI suppliers consider certain information to be proprietary, and thus CAS numbers and other limited information may not be available for release.

In no event shall TI's liability arising out of such information exceed the total purchase price of the TI part(s) at issue in this document sold by TI to Customer on an annual basis.

DA (R-PDSO-G**)
 38 PIN SHOWN

PLASTIC SMALL-OUTLINE PACKAGE

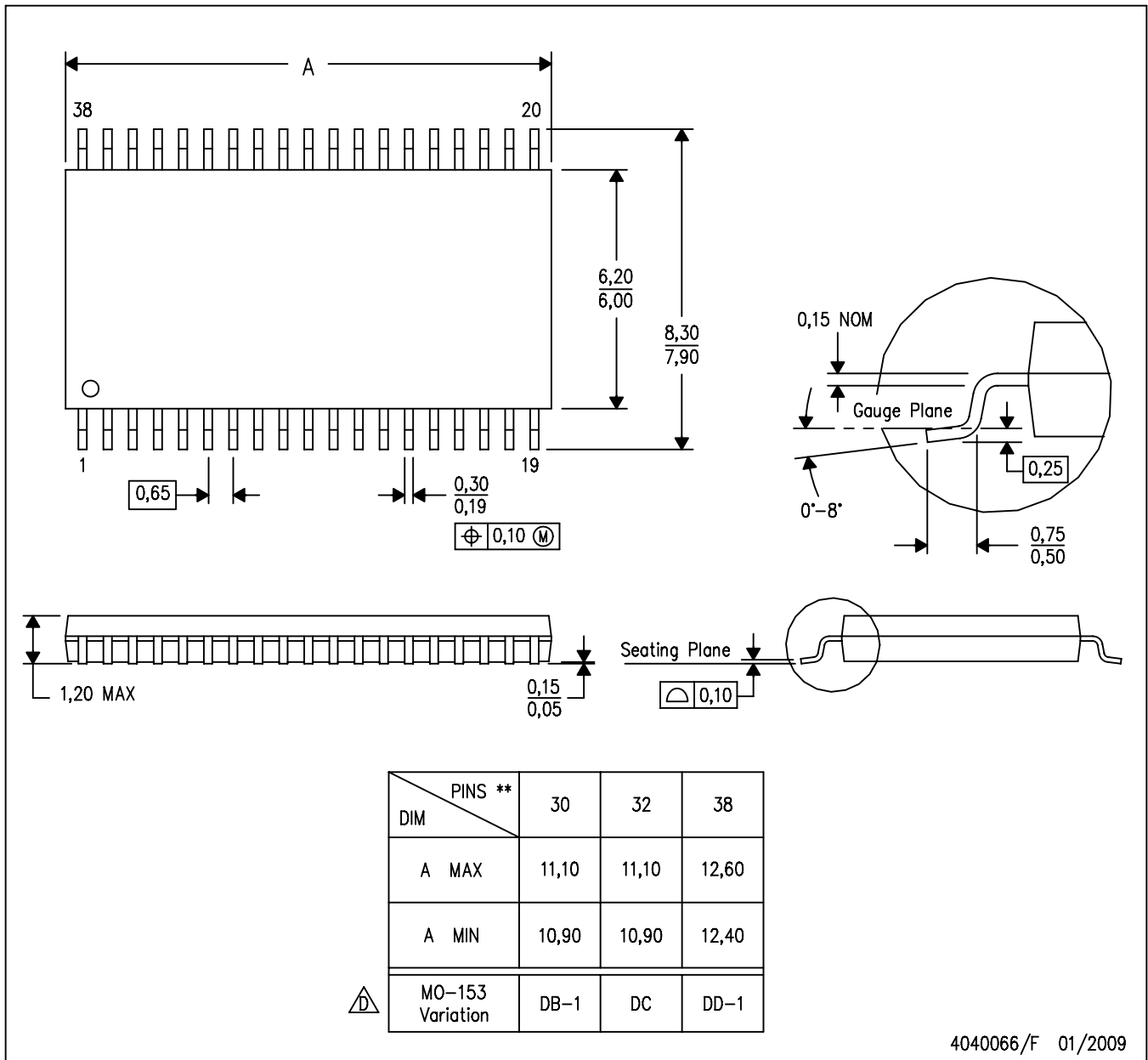

- NOTES:
- A. All linear dimensions are in millimeters.
 - B. This drawing is subject to change without notice.
 - C. Body dimensions do not include mold flash or protrusion. Mold flash and protrusion shall not exceed 0.15 per side.
 - Falls within JEDEC MO-153, except 30 pin body length.

IMPORTANT NOTICE

Texas Instruments Incorporated and its subsidiaries (TI) reserve the right to make corrections, enhancements, improvements and other changes to its semiconductor products and services per JESD46, latest issue, and to discontinue any product or service per JESD48, latest issue. Buyers should obtain the latest relevant information before placing orders and should verify that such information is current and complete. All semiconductor products (also referred to herein as "components") are sold subject to TI's terms and conditions of sale supplied at the time of order acknowledgment.

TI warrants performance of its components to the specifications applicable at the time of sale, in accordance with the warranty in TI's terms and conditions of sale of semiconductor products. Testing and other quality control techniques are used to the extent TI deems necessary to support this warranty. Except where mandated by applicable law, testing of all parameters of each component is not necessarily performed.

TI assumes no liability for applications assistance or the design of Buyers' products. Buyers are responsible for their products and applications using TI components. To minimize the risks associated with Buyers' products and applications, Buyers should provide adequate design and operating safeguards.

TI does not warrant or represent that any license, either express or implied, is granted under any patent right, copyright, mask work right, or other intellectual property right relating to any combination, machine, or process in which TI components or services are used. Information published by TI regarding third-party products or services does not constitute a license to use such products or services or a warranty or endorsement thereof. Use of such information may require a license from a third party under the patents or other intellectual property of the third party, or a license from TI under the patents or other intellectual property of TI.

Reproduction of significant portions of TI information in TI data books or data sheets is permissible only if reproduction is without alteration and is accompanied by all associated warranties, conditions, limitations, and notices. TI is not responsible or liable for such altered documentation. Information of third parties may be subject to additional restrictions.

Resale of TI components or services with statements different from or beyond the parameters stated by TI for that component or service voids all express and any implied warranties for the associated TI component or service and is an unfair and deceptive business practice. TI is not responsible or liable for any such statements.

Buyer acknowledges and agrees that it is solely responsible for compliance with all legal, regulatory and safety-related requirements concerning its products, and any use of TI components in its applications, notwithstanding any applications-related information or support that may be provided by TI. Buyer represents and agrees that it has all the necessary expertise to create and implement safeguards which anticipate dangerous consequences of failures, monitor failures and their consequences, lessen the likelihood of failures that might cause harm and take appropriate remedial actions. Buyer will fully indemnify TI and its representatives against any damages arising out of the use of any TI components in safety-critical applications.

In some cases, TI components may be promoted specifically to facilitate safety-related applications. With such components, TI's goal is to help enable customers to design and create their own end-product solutions that meet applicable functional safety standards and requirements. Nonetheless, such components are subject to these terms.

No TI components are authorized for use in FDA Class III (or similar life-critical medical equipment) unless authorized officers of the parties have executed a special agreement specifically governing such use.

Only those TI components which TI has specifically designated as military grade or "enhanced plastic" are designed and intended for use in military/aerospace applications or environments. Buyer acknowledges and agrees that any military or aerospace use of TI components which have **not** been so designated is solely at the Buyer's risk, and that Buyer is solely responsible for compliance with all legal and regulatory requirements in connection with such use.

TI has specifically designated certain components as meeting ISO/TS16949 requirements, mainly for automotive use. In any case of use of non-designated products, TI will not be responsible for any failure to meet ISO/TS16949.

Products

Audio	www.ti.com/audio
Amplifiers	amplifier.ti.com
Data Converters	dataconverter.ti.com
DLP® Products	www.dlp.com
DSP	dsp.ti.com
Clocks and Timers	www.ti.com/clocks
Interface	interface.ti.com
Logic	logic.ti.com
Power Mgmt	power.ti.com
Microcontrollers	microcontroller.ti.com
RFID	www.ti-rfid.com
OMAP Applications Processors	www.ti.com/omap
Wireless Connectivity	www.ti.com/wirelessconnectivity

Applications

Automotive and Transportation	www.ti.com/automotive
Communications and Telecom	www.ti.com/communications
Computers and Peripherals	www.ti.com/computers
Consumer Electronics	www.ti.com/consumer-apps
Energy and Lighting	www.ti.com/energy
Industrial	www.ti.com/industrial
Medical	www.ti.com/medical
Security	www.ti.com/security
Space, Avionics and Defense	www.ti.com/space-avionics-defense
Video and Imaging	www.ti.com/video

TI E2E Community

e2e.ti.com