

OPAx197-Q1 36V、高精度、レール・ツー・レール入/出力、低オフセット電圧、 小入力バイアス電流の e-trim™ オペアンプ、

1 特長

- 車載アプリケーション用に AEC-Q100 認定済み:
 - 温度グレード 1: -40°C ~ +125°C, T_A
- 低いオフセット電圧: ±250µV (最大値)
- 低い入力オフセット電圧ドリフト: ±0.2µV/°C
- 低ノイズ: 1 kHz において 5.5nV/√Hz
- 大きい同相信号除去比: 140dB
- 小さいバイアス電流: ±5pA
- レール・ツー・レール入出力
- 広い帯域幅: 10MHz GBW
- 高いスルーレート: 20V/µs
- 小さい静止電流: アンプ 1 個あたり 1mA
- 広い電源範囲: ±2.25V ~ ±18V, 4.5V ~ 36V
- EMI および RFI フィルタ付き入力
- 電源レールまでの差動入力電圧範囲
- 高い容量性負荷駆動能力: 1nF
- 業界標準パッケージ
 - シングルおよびデュアル・チャンネルを超小型 8 ピン VSSOP に封入
 - クワッド・チャンネルは 14 ピン VSSOP

2 アプリケーション

- インバータおよびモーター制御
- DC/DC コンバータ
- オンボード・チャージャ (OBC) およびワイヤレス・チャージャ
- バッテリー管理システム (BMS)

3 概要

OPAx197-Q1 ファミリー (OPA197-Q1, OPA2197-Q1, および OPA4197-Q1) は、新世代の 36V、e-trim™ オペアンプとして開発されました。OPAx197-Q1 ファミリーの e-trim オペアンプでは、プラスチック成形プロセス後の製造の最終段階で、オフセットおよびオフセットの温度ドリフトをパッケージ・レベルで調整する、独自の手法が採用されています。この方法により、入力トランジスタに内在する不一致の影響と、パッケージ造形時に発生する誤差が最小化されます。

これらのデバイスは、非常に優れた DC 精度と AC 特性 (レール・ツー・レールの入出力、標準値 ±5µV の低いオフセット電圧、標準値 ±0.2µV/°C の低いオフセット・ドリフト、10MHz 帯域幅など) を提供します。

電源レールまでの差動入力電圧範囲、大きな出力電流 (±65mA)、1nF までの大きな容量性負荷の駆動、高いスルー・レート (20V/µs) など、固有の特徴を備えた OPAx197-Q1 は、高電圧の産業アプリケーション向けの、堅牢で高性能なオペアンプとなっています。

デバイス情報

部品番号	パッケージ ⁽¹⁾	本体サイズ (公称)
OPA197-Q1	VSSOP (8)	3.00mm × 3.00mm
OPA2197-Q1		
OPA4197-Q1	TSSOP (14)	5.00mm × 4.40mm

- (1) 利用可能なパッケージについては、データシートの末尾にあるパッケージ・オプションについての付録を参照してください。

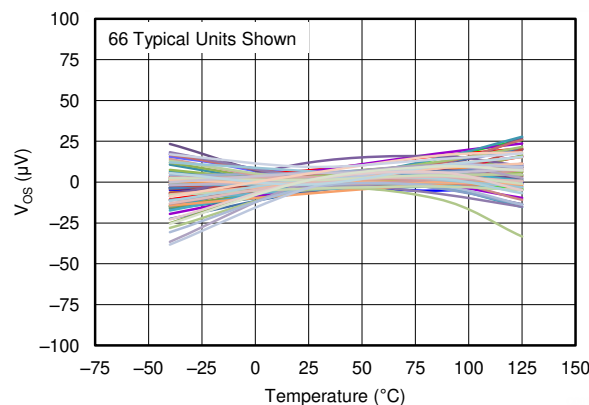

OPAx197-Q1 は温度範囲全体にわたって極めて低い入力オフセット電圧を維持



Table of Contents

1 特長	1	7.3 Feature Description.....	22
2 アプリケーション	1	7.4 Device Functional Modes.....	28
3 概要	1	8 Application and Implementation	29
4 Revision History	2	8.1 Application Information.....	29
5 Pin Configuration and Functions	3	8.2 Typical Applications.....	29
6 Specifications	6	9 Power Supply Recommendations	33
6.1 Absolute Maximum Ratings	6	10 Layout	33
6.2 ESD Ratings	6	10.1 Layout Guidelines.....	33
6.3 Recommended Operating Conditions	6	10.2 Layout Examples.....	34
6.4 Thermal Information: OPA197-Q1	7	11 Device and Documentation Support	35
6.5 Thermal Information: OPA2197-Q1	7	11.1 Device Support.....	35
6.6 Thermal Information: OPA4197-Q1	7	11.2 Documentation Support.....	35
6.7 Electrical Characteristics: $V_S = \pm 4\text{ V to } \pm 18\text{ V}$ ($V_S = 8\text{ V to } 36\text{ V}$)	8	11.3 ドキュメントの更新通知を受け取る方法.....	35
6.8 Electrical Characteristics: $V_S = \pm 2.25\text{ V to } \pm 4\text{ V}$ ($V_S = 4.5\text{ V to } 8\text{ V}$)	10	11.4 サポート・リソース.....	35
6.9 Typical Characteristics.....	12	11.5 Trademarks.....	36
7 Detailed Description	21	11.6 静電気放電に関する注意事項.....	36
7.1 Overview.....	21	11.7 用語集.....	36
7.2 Functional Block Diagram.....	21	12 Mechanical, Packaging, and Orderable Information	36

4 Revision History

Changes from Revision * (March 2018) to Revision A (January 2021)

	Page
• OPA4197-Q1 および関連の項目を追加.....	1

5 Pin Configuration and Functions

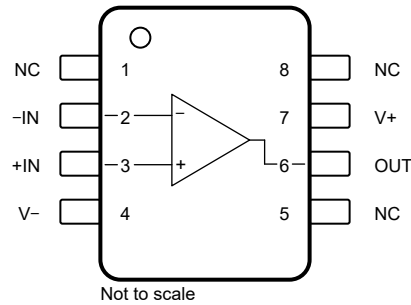
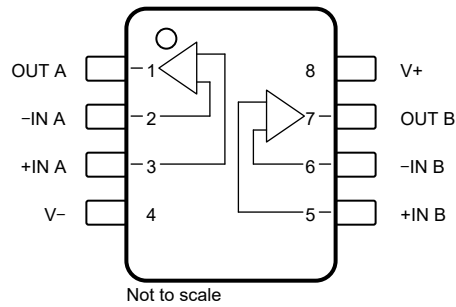

FIG 5-1. OPA197-Q1 DGK Package, 8-Pin VSSOP, Top View

Pin Functions: OPA197-Q1

PIN		I/O	DESCRIPTION
NAME	NO.		
+IN	3	I	Noninverting input
-IN	2	I	Inverting input
NC	1, 5, 8	—	No internal connection (can be left floating)
OUT	6	O	Output
V+	7	—	Positive (highest) power supply
V-	4	—	Negative (lowest) power supply



5-2. OPA2197-Q1 DGK Package, 8-Pin VSSOP, Top View

Pin Functions: OPA2197-Q1

PIN		I/O	DESCRIPTION
NAME	DGK (VSSOP)		
+IN A	3	I	Noninverting input, channel A
+IN B	5	I	Noninverting input, channel B
-IN A	2	I	Inverting input, channel A
-IN B	6	I	Inverting input, channel B
OUT A	1	O	Output, channel A
OUT B	7	O	Output, channel B
V+	8	—	Positive (highest) power supply
V-	4	—	Negative (lowest) power supply

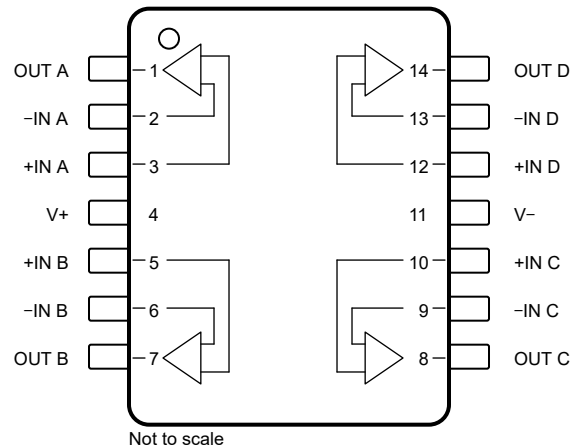

5-3. OPA4197-Q1 PW Package, 14-Pin TSSOP, Top View

Pin Functions: OPA4197-Q1

PIN		I/O	DESCRIPTION
NAME	NO.		
+IN A	3	I	Noninverting input, channel A
+IN B	5	I	Noninverting input, channel B
+IN C	10	I	Noninverting input, channel C
+IN D	12	I	Noninverting input, channel D
-IN A	2	I	Inverting input, channel A
-IN B	6	I	Inverting input, channel B
-IN C	9	I	Inverting input, channel C
-IN D	13	I	Inverting input, channel D
OUT A	1	O	Output, channel A
OUT B	7	O	Output, channel B
OUT C	8	O	Output, channel C
OUT D	14	O	Output, channel D
V+	4	—	Positive (highest) power supply
V-	11	—	Negative (lowest) power supply

6 Specifications

6.1 Absolute Maximum Ratings

over operating free-air temperature range (unless otherwise noted)⁽¹⁾

			MIN	MAX	UNIT
V _S	Supply voltage	Single supply, V _S = (V ₊)		40	V
		Dual supply, V _S = (V ₊) – (V ₋)		±20	
	Signal input voltage	Common-mode	(V ₋) – 0.5	(V ₊) + 0.5	V
		Differential		(V ₊) – (V ₋) + 0.2	
	Signal input current			±10	mA
	Output short circuit ⁽²⁾		Continuous		
	Latch-up per JESD78D		Class IIA		
T _A	Operating temperature		-55	150	°C
T _J	Junction temperature			150	°C
T _{stg}	Storage temperature		-65	150	°C

- (1) Stresses beyond those listed under *Absolute Maximum Ratings* may cause permanent damage to the device. These are stress ratings only, which do not imply functional operation of the device at these or any other conditions beyond those indicated under *Recommended Operating Conditions*. Exposure to absolute-maximum-rated conditions for extended periods may affect device reliability.
- (2) Short-circuit to ground, one amplifier per package.

6.2 ESD Ratings

			VALUE	UNIT
OPA197-Q1, OPA2197-Q1				
V _(ESD)	Electrostatic discharge	Human-body model (HBM), per AEC Q100-002 ⁽¹⁾ HBM ESD classification level 3A	±4000	V
		Charge device model (CDM), per AEC Q100-011 CDM ESD classification level C4A	±500	
OPA4197-Q1				
V _(ESD)	Electrostatic discharge	Human-body model (HBM), per AEC Q100-002 ⁽¹⁾ HBM ESD classification level 2	±2000	V
		Charge device model (CDM), per AEC Q100-011 CDM ESD classification level C5	±750	

- (1) AEC Q100-002 indicates that HBM stressing shall be in accordance with the ANSI/ESDA/JEDEC JS-001 specification.

6.3 Recommended Operating Conditions

over operating free-air temperature range (unless otherwise noted)

			MIN	NOM	MAX	UNIT
V _S	Supply voltage	Single supply, V _S = (V ₊)	4.5		36	V
		Dual supply, V _S = (V ₊) – (V ₋)	±2.25		±18	
T _A	Operating temperature		-40		125	°C

6.4 Thermal Information: OPA197-Q1

THERMAL METRIC ⁽¹⁾		OPA197-Q1	
		DGK (VSSOP)	
		8 PINS	
			UNIT
$R_{\theta JA}$	Junction-to-ambient thermal resistance	180.4	°C/W
$R_{\theta JC(top)}$	Junction-to-case(top) thermal resistance	67.9	°C/W
$R_{\theta JB}$	Junction-to-board thermal resistance	102.1	°C/W
Ψ_{JT}	Junction-to-top characterization parameter	10.4	°C/W
Ψ_{JB}	Junction-to-board characterization parameter	100.3	°C/W
$R_{\theta JC(bot)}$	Junction-to-case(bottom) thermal resistance	N/A	°C/W

(1) For more information about traditional and new thermal metrics, see the [Semiconductor and IC Package Thermal Metrics](#) application report.

6.5 Thermal Information: OPA2197-Q1

THERMAL METRIC ⁽¹⁾		OPA2197-Q1	
		DGK (VSSOP)	
		8 PINS	
			UNIT
$R_{\theta JA}$	Junction-to-ambient thermal resistance	158	°C/W
$R_{\theta JC(top)}$	Junction-to-case(top) thermal resistance	48.6	°C/W
$R_{\theta JB}$	Junction-to-board thermal resistance	78.7	°C/W
Ψ_{JT}	Junction-to-top characterization parameter	3.9	°C/W
Ψ_{JB}	Junction-to-board characterization parameter	77.3	°C/W
$R_{\theta JC(bot)}$	Junction-to-case(bottom) thermal resistance	N/A	°C/W

(1) For more information about traditional and new thermal metrics, see the [Semiconductor and IC Package Thermal Metrics](#) application report.

6.6 Thermal Information: OPA4197-Q1

THERMAL METRIC ⁽¹⁾		OPA4197-Q1	
		PW (TSSOP)	
		14 PINS	
			UNIT
$R_{\theta JA}$	Junction-to-ambient thermal resistance	108.1	°C/W
$R_{\theta JC(top)}$	Junction-to-case(top) thermal resistance	26.3	°C/W
$R_{\theta JB}$	Junction-to-board thermal resistance	54.4	°C/W
Ψ_{JT}	Junction-to-top characterization parameter	1.4	°C/W
Ψ_{JB}	Junction-to-board characterization parameter	53.3	°C/W
$R_{\theta JC(bot)}$	Junction-to-case(bottom) thermal resistance	N/A	°C/W

(1) For more information about traditional and new thermal metrics, see the [Semiconductor and IC Package Thermal Metrics](#) application report.

6.7 Electrical Characteristics: $V_S = \pm 4\text{ V}$ to $\pm 18\text{ V}$ ($V_S = 8\text{ V}$ to 36 V)

at $T_A = +25^\circ\text{C}$, $V_{CM} = V_{OUT} = V_S / 2$, and $R_L = 10\text{ k}\Omega$ connected to $V_S / 2$ (unless otherwise noted)

PARAMETER		TEST CONDITIONS		MIN	TYP	MAX	UNIT
OFFSET VOLTAGE							
V_{OS}	Input offset voltage				± 25	± 250	μV
		$T_A = 0^\circ\text{C}$ to 85°C			± 30	± 350	
		$T_A = -40^\circ\text{C}$ to $+125^\circ\text{C}$			± 50	± 400	
		$V_{CM} = (V+) - 1.5\text{ V}$	$T_A = 0^\circ\text{C}$ to 85°C		± 25	± 350	
			$T_A = -40^\circ\text{C}$ to $+125^\circ\text{C}$		± 50	± 500	
dV_{OS}/dT	Input offset voltage drift	$T_A = 0^\circ\text{C}$ to 85°C			± 0.5	± 2.5	$\mu\text{V}/^\circ\text{C}$
		$T_A = -40^\circ\text{C}$ to $+125^\circ\text{C}$			± 0.8	± 4.5	
PSRR	Power-supply rejection ratio	$T_A = -40^\circ\text{C}$ to $+125^\circ\text{C}$			± 0.3	± 1.0	$\mu\text{V}/\text{V}$
INPUT BIAS CURRENT							
I_B	Input bias current				± 5	± 20	μA
		$T_A = -40^\circ\text{C}$ to $+125^\circ\text{C}$				± 5	nA
I_{OS}	Input offset current				± 2	± 20	μA
		$T_A = -40^\circ\text{C}$ to $+125^\circ\text{C}$				± 2	nA
NOISE							
E_n	Input voltage noise	$(V-) - 0.1\text{ V} < V_{CM} < (V+) - 3\text{ V}$	$f = 0.1\text{ Hz}$ to 10 Hz		1.3		μV_{PP}
		$(V+) - 1.5\text{ V} < V_{CM} < (V+) + 0.1\text{ V}$	$f = 0.1\text{ Hz}$ to 10 Hz		4		
e_n	Input voltage noise density	$(V-) - 0.1\text{ V} < V_{CM} < (V+) - 3\text{ V}$	$f = 100\text{ Hz}$		10.5		$\text{nV}/\sqrt{\text{Hz}}$
			$f = 1\text{ kHz}$		5.5		
		$(V+) - 1.5\text{ V} < V_{CM} < (V+) + 0.1\text{ V}$	$f = 100\text{ Hz}$		32		
			$f = 1\text{ kHz}$		12.5		
i_n	Input current noise density	$f = 1\text{ kHz}$			1.5	$\text{fA}/\sqrt{\text{Hz}}$	
INPUT VOLTAGE							
V_{CM}	Common-mode voltage			$(V-) - 0.1$		$(V+) + 0.1$	V
CMRR	Common-mode rejection ratio	$(V-) - 0.1\text{ V} < V_{CM} < (V+) - 3\text{ V}$		120	140		dB
		$(V-) < V_{CM} < (V+) - 3\text{ V}$, $T_A = -40^\circ\text{C}$ to $+125^\circ\text{C}$		114	126		
		$(V+) - 1.5\text{ V} < V_{CM} < (V+)$			100	120	
$T_A = -40^\circ\text{C}$ to $+125^\circ\text{C}$			86	100			
INPUT IMPEDANCE							
Z_{ID}	Differential			100 1.6			$\text{M}\Omega$ pF
Z_{IC}	Common-mode			1 6.4			$10^{13}\Omega$ pF

6.7 Electrical Characteristics: $V_S = \pm 4\text{ V}$ to $\pm 18\text{ V}$ ($V_S = 8\text{ V}$ to 36 V) (continued)

at $T_A = +25^\circ\text{C}$, $V_{CM} = V_{OUT} = V_S / 2$, and $R_L = 10\text{ k}\Omega$ connected to $V_S / 2$ (unless otherwise noted)

PARAMETER		TEST CONDITIONS		MIN	TYP	MAX	UNIT
OPEN-LOOP GAIN							
A_{OL}	Open-loop voltage gain	$(V-) + 0.6\text{ V} < V_O < (V+) - 0.6\text{ V}$, $R_L = 2\text{ k}\Omega$	$T_A = -40^\circ\text{C}$ to $+125^\circ\text{C}$	120	134		dB
				114	126		
		$(V-) + 0.3\text{ V} < V_O < (V+) - 0.3\text{ V}$, $R_L = 10\text{ k}\Omega$		126	140		
			$T_A = -40^\circ\text{C}$ to $+125^\circ\text{C}$	120	134		
FREQUENCY RESPONSE							
GBW	Unity gain bandwidth				10		MHz
SR	Slew rate	$G = 1$, 10-V step			20		V/ μs
t_s	Settling time	To 0.01%	$G = 1$, 10-V step		1.4		μs
			$G = 1$, 5-V step		0.9		
		To 0.001%	$G = 1$, 10-V step		2.1		μs
			$G = 1$, 5-V step		1.8		
t_{OR}	Overload recovery time	$V_{IN} \times G = V_S$			200		ns
THD+N	Total harmonic distortion + noise	$G = 1$, $f = 1\text{ kHz}$, $V_O = 3.5 V_{RMS}$			0.00008%		
	Crosstalk	OPA4197-Q1 at dc			150		dB
		OPA4197-Q1, $f = 100\text{ kHz}$			130		dB
OUTPUT							
V_O	Voltage output swing from rail	Positive rail	No load		5	15	mV
			$R_L = 10\text{ k}\Omega$		95	110	
			$R_L = 2\text{ k}\Omega$		430	500	
		Negative rail	No load		5	15	
			$R_L = 10\text{ k}\Omega$		95	110	
			$R_L = 2\text{ k}\Omega$		430	500	
I_{SC}	Short-circuit current				± 65		mA
C_{LOAD}	Capacitive load drive				See セクション 6.9		
Z_O	Open-loop output impedance	$f = 1\text{ MHz}$, $I_O = 0\text{ A}$; see 図 6-29			375		Ω
POWER SUPPLY							
I_Q	Quiescent current per amplifier	$I_O = 0\text{ A}$			1	1.2	mA
			$T_A = -40^\circ\text{C}$ to $+125^\circ\text{C}$				
TEMPERATURE							
	Thermal protection				140		$^\circ\text{C}$

6.8 Electrical Characteristics: $V_S = \pm 2.25\text{ V}$ to $\pm 4\text{ V}$ ($V_S = 4.5\text{ V}$ to 8 V)

at $T_A = +25^\circ\text{C}$, $V_{CM} = V_{OUT} = V_S / 2$, and $R_L = 10\text{ k}\Omega$ connected to $V_S / 2$ (unless otherwise noted)

PARAMETER		TEST CONDITIONS		MIN	TYP	MAX	UNIT	
OFFSET VOLTAGE								
V_{OS}	Input offset voltage	$V_{CM} = (V+) - 3\text{ V}$			± 5	± 250	μV	
			$T_A = 0^\circ\text{C}$ to 85°C		± 8	± 350		
			$T_A = -40^\circ\text{C}$ to $+125^\circ\text{C}$		± 10	± 400		
		$(V+) - 3.5\text{ V} < V_{CM} < (V+) - 1.5\text{ V}$		See セクション 7.3.6				
		$V_{CM} = (V+) - 1.5\text{ V}$			± 10	± 250		
			$T_A = 0^\circ\text{C}$ to 85°C		± 25	± 350		
$T_A = -40^\circ\text{C}$ to $+125^\circ\text{C}$			± 50	± 500				
dV_{OS}/dT	Input offset voltage drift	$V_{CM} = (V+) - 3\text{ V}$	$T_A = -40^\circ\text{C}$ to $+125^\circ\text{C}$		± 0.5	± 2.5	$\mu\text{V}/^\circ\text{C}$	
dV_{OS}/dT	Input offset voltage drift	$V_{CM} = (V+) - 1.5\text{ V}$			± 0.8	± 4.5		
PSRR	Power-supply rejection ratio	$T_A = -40^\circ\text{C}$ to $+125^\circ\text{C}$			± 2		$\mu\text{V}/\text{V}$	
INPUT BIAS CURRENT								
I_B	Input bias current				± 5	± 20	μA	
		$T_A = -40^\circ\text{C}$ to $+125^\circ\text{C}$				± 5	nA	
I_{OS}	Input offset current				± 2	± 20	μA	
		$T_A = -40^\circ\text{C}$ to $+125^\circ\text{C}$				± 2	nA	
NOISE								
E_n	Input voltage noise	$(V-) - 0.1\text{ V} < V_{CM} < (V+) - 3\text{ V}$, $f = 0.1\text{ Hz}$ to 10 Hz			1.3		μV_{PP}	
		$(V+) - 1.5\text{ V} < V_{CM} < (V+) + 0.1\text{ V}$, $f = 0.1\text{ Hz}$ to 10 Hz			4			
e_n	Input voltage noise density	$(V-) - 0.1\text{ V} < V_{CM} < (V+) - 3\text{ V}$	$f = 100\text{ Hz}$		10.5		$\text{nV}/\sqrt{\text{Hz}}$	
			$f = 1\text{ kHz}$		5.5			
		$(V+) - 1.5\text{ V} < V_{CM} < (V+) + 0.1\text{ V}$	$f = 100\text{ Hz}$		32			
			$f = 1\text{ kHz}$		12.5			
i_n	Input current noise density	$f = 1\text{ kHz}$			1.5		$\text{fA}/\sqrt{\text{Hz}}$	
INPUT VOLTAGE								
V_{CM}	Common-mode voltage range			$(V-) - 0.1$		$(V+) + 0.1$	V	
CMRR	Common-mode rejection ratio	$(V-) - 0.1\text{ V} < V_{CM} < (V+) - 3\text{ V}$		94	110		dB	
			$T_A = -40^\circ\text{C}$ to $+125^\circ\text{C}$	90	104			
		$(V+) - 1.5\text{ V} < V_{CM} < (V+)$		100	120			
			$T_A = -40^\circ\text{C}$ to $+125^\circ\text{C}$	84	100			
		$(V+) - 3\text{ V} < V_{CM} < (V+) - 1.5\text{ V}$		See セクション 6.9				
INPUT IMPEDANCE								
Z_{ID}	Differential			100 1.6			$\text{M}\Omega$ pF	
Z_{IC}	Common-mode			1 6.4			$10^{13}\Omega$ pF	

6.8 Electrical Characteristics: $V_S = \pm 2.25\text{ V}$ to $\pm 4\text{ V}$ ($V_S = 4.5\text{ V}$ to 8 V) (continued)

 at $T_A = +25^\circ\text{C}$, $V_{CM} = V_{OUT} = V_S / 2$, and $R_L = 10\text{ k}\Omega$ connected to $V_S / 2$ (unless otherwise noted)

PARAMETER		TEST CONDITIONS		MIN	TYP	MAX	UNIT
OPEN-LOOP GAIN							
A_{OL}	Open-loop voltage gain	$(V_-) + 0.6\text{ V} < V_O < (V_+) - 0.6\text{ V}$, $R_L = 2\text{ k}\Omega$	$T_A = -40^\circ\text{C}$ to $+125^\circ\text{C}$	110	120		dB
			$T_A = -40^\circ\text{C}$ to $+125^\circ\text{C}$	100	114		
		$(V_-) + 0.3\text{ V} < V_O < (V_+) - 0.3\text{ V}$, $R_L = 10\text{ k}\Omega$	$T_A = -40^\circ\text{C}$ to $+125^\circ\text{C}$	110	126		dB
			$T_A = -40^\circ\text{C}$ to $+125^\circ\text{C}$	110	120		
FREQUENCY RESPONSE							
GBW	Unity gain bandwidth				10		MHz
SR	Slew rate	$G = 1$, 5-V step			20		V/ μs
t_s	Settling time	To 0.01%, $V_S = \pm 3\text{ V}$, $G = 1$, 5-V step			1		μs
t_{OR}	Overload recovery time	$V_{IN} \times G = V_S$			200		ns
	Crosstalk	OPA4197-Q1 at dc			150		dB
		OPA4197-Q1, $f = 100\text{ kHz}$			130		dB
OUTPUT							
V_O	Voltage output swing from rail	Positive rail	No load		5	15	mV
			$R_L = 10\text{ k}\Omega$		95	110	
			$R_L = 2\text{ k}\Omega$		430	500	
		Negative rail	No load		5	15	
			$R_L = 10\text{ k}\Omega$		95	110	
			$R_L = 2\text{ k}\Omega$		430	500	
I_{SC}	Short-circuit current				± 65		mA
C_{LOAD}	Capacitive load drive				See セクション 6.9		
Z_O	Open-loop output impedance	$f = 1\text{ MHz}$, $I_O = 0\text{ A}$; see 図 6-29			375		Ω
POWER SUPPLY							
I_Q	Quiescent current per amplifier	$I_O = 0\text{ A}$			1	1.2	mA
			$T_A = -40^\circ\text{C}$ to $+125^\circ\text{C}$			1.5	
TEMPERATURE							
	Thermal protection				140		$^\circ\text{C}$

6.9 Typical Characteristics

at $T_A = 25^\circ\text{C}$, $V_S = \pm 18\text{ V}$, $V_{CM} = V_S / 2$, $R_{LOAD} = 10\text{ k}\Omega$ connected to $V_S / 2$, and $C_L = 100\text{ pF}$, (unless otherwise noted)

表 6-1. Table of Graphs

DESCRIPTION	FIGURE
Offset Voltage Production Distribution	图 6-1 to 图 6-6
Offset Voltage Drift Distribution	图 6-7 to 图 6-8
Offset Voltage vs Temperature	图 6-9
Offset Voltage vs Common-Mode Voltage	图 6-10 to 图 6-12
Offset Voltage vs Power Supply	图 6-13
Open-Loop Gain and Phase vs Frequency	图 6-14
Closed-Loop Gain and Phase vs Frequency	图 6-15
Input Bias Current vs Common-Mode Voltage	图 6-16
Input Bias Current vs Temperature	图 6-17
Output Voltage Swing vs Output Current (maximum supply)	图 6-18
CMRR and PSRR vs Frequency	图 6-19
CMRR vs Temperature	图 6-20
PSRR vs Temperature	图 6-21
0.1-Hz to 10-Hz Noise	图 6-22
Input Voltage Noise Spectral Density vs Frequency	图 6-23
THD+N Ratio vs Frequency	图 6-24
THD+N vs Output Amplitude	图 6-25
Quiescent Current vs Supply Voltage	图 6-26
Quiescent Current vs Temperature	图 6-27
Open Loop Gain vs Temperature	图 6-28
Open Loop Output Impedance vs Frequency	图 6-29
Small Signal Overshoot vs Capacitive Load (100-mV Output Step)	图 6-30 , 图 6-31
No Phase Reversal	图 6-32
Positive Overload Recovery	图 6-33
Negative Overload Recovery	图 6-34
Small-Signal Step Response (100 mV)	图 6-35 , 图 6-36
Large-Signal Step Response	图 6-37
Settling Time	图 6-38 to 图 6-41
Short-Circuit Current vs Temperature	图 6-42
Maximum Output Voltage vs Frequency	图 6-43
Propagation Delay Rising Edge	图 6-44
Propagation Delay Falling Edge	图 6-45
Crosstalk vs Frequency	图 6-46

6.9 Typical Characteristics (continued)

at $T_A = 25^\circ\text{C}$, $V_S = \pm 18\text{ V}$, $V_{CM} = V_S / 2$, $R_{LOAD} = 10\text{ k}\Omega$ connected to $V_S / 2$, and $C_L = 100\text{ pF}$, (unless otherwise noted)

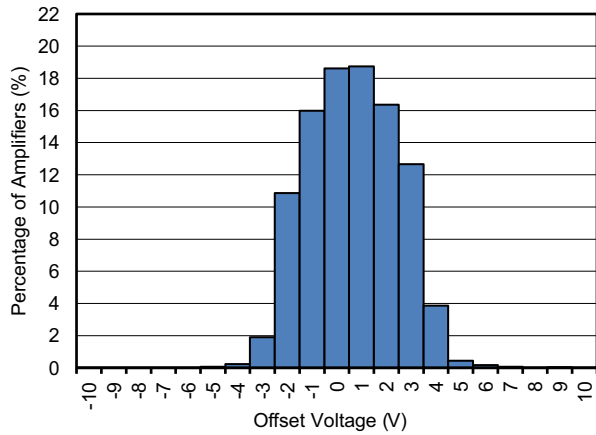

6-1. Offset Voltage Production Distribution at 25°C

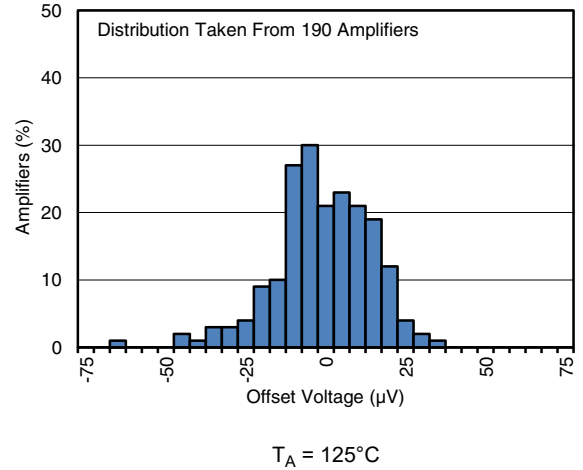

6-2. Offset Voltage Production Distribution at 125°C

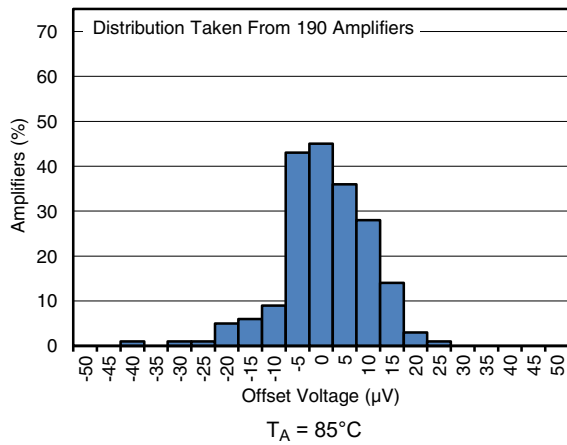

6-3. Offset Voltage Production Distribution at 85°C

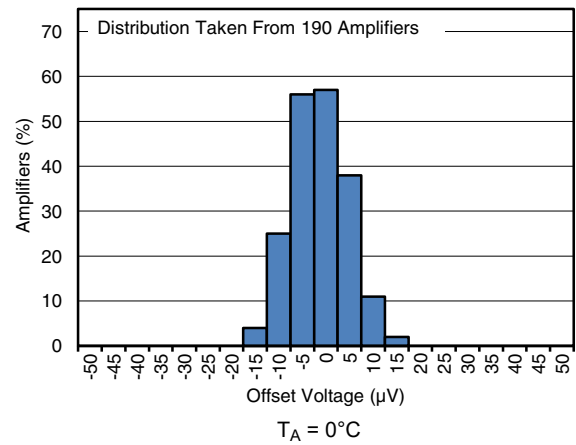

6-4. Offset Voltage Production Distribution at 0°C

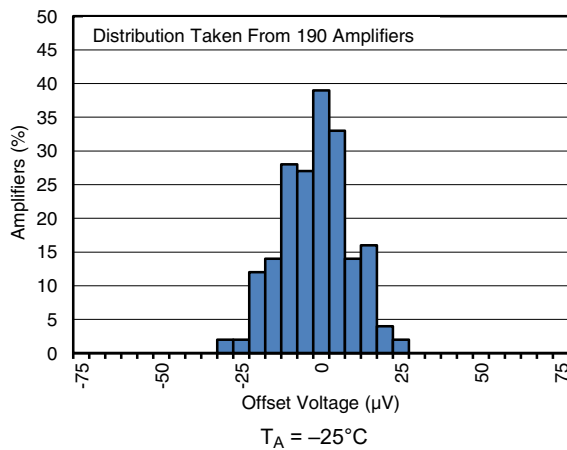

6-5. Offset Voltage Production Distribution at -25°C

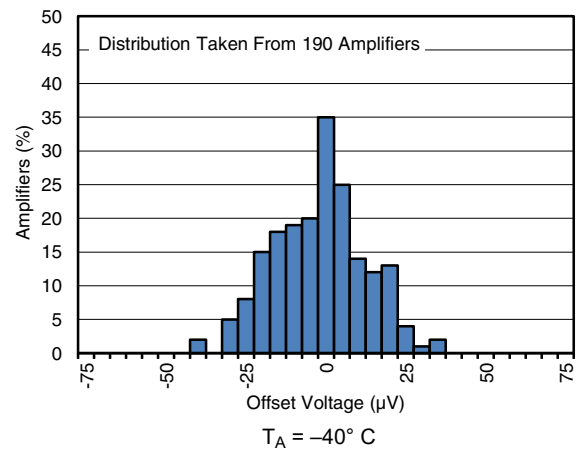

6-6. Offset Voltage Production Distribution at -40°C

6.9 Typical Characteristics (continued)

at $T_A = 25^\circ\text{C}$, $V_S = \pm 18\text{ V}$, $V_{CM} = V_S / 2$, $R_{LOAD} = 10\text{ k}\Omega$ connected to $V_S / 2$, and $C_L = 100\text{ pF}$, (unless otherwise noted)

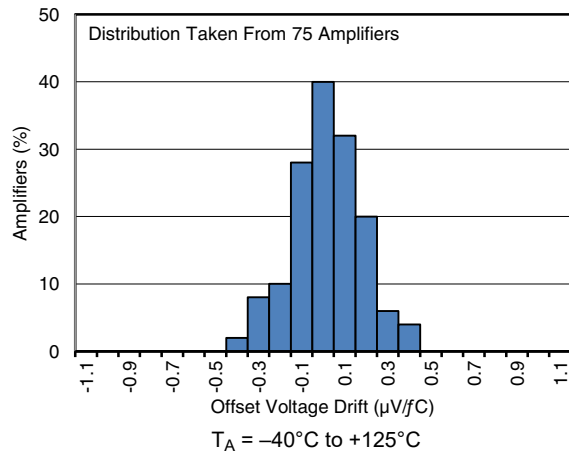

6-7. Offset Voltage Drift Distribution from -40°C to $+125^\circ\text{C}$

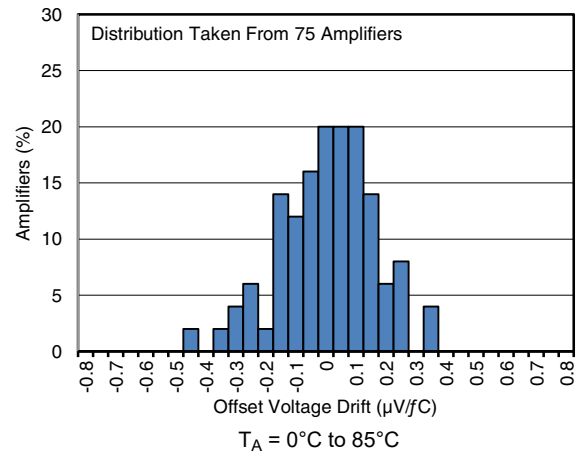

6-8. Offset Voltage Drift Distribution from 0°C to 85°C

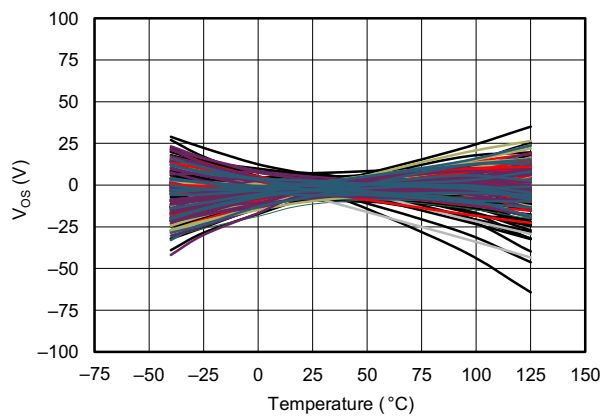

6-9. Offset Voltage vs Temperature

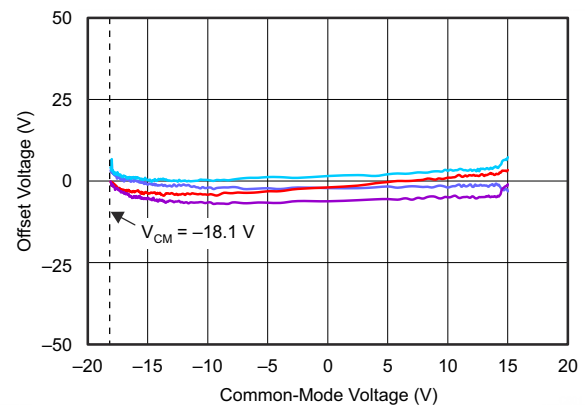

6-10. Offset Voltage vs Common-Mode Voltage

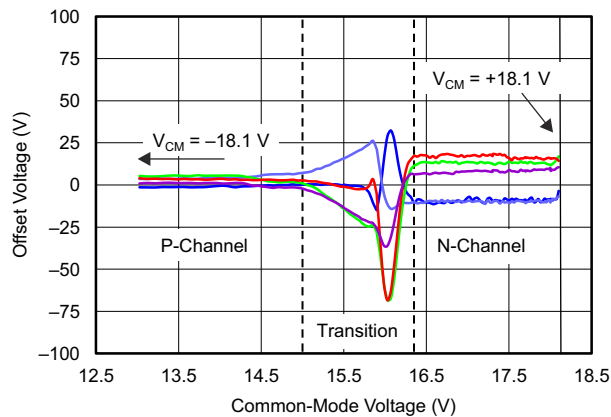

6-11. Offset Voltage vs Common-Mode Voltage

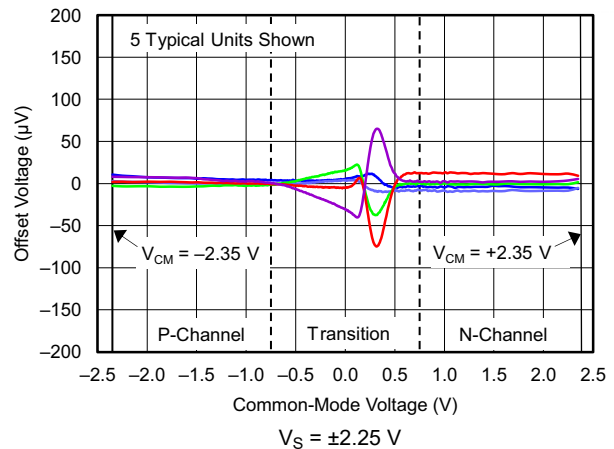

6-12. Offset Voltage vs Common-Mode Voltage

6.9 Typical Characteristics (continued)

at $T_A = 25^\circ\text{C}$, $V_S = \pm 18\text{ V}$, $V_{CM} = V_S / 2$, $R_{LOAD} = 10\text{ k}\Omega$ connected to $V_S / 2$, and $C_L = 100\text{ pF}$, (unless otherwise noted)

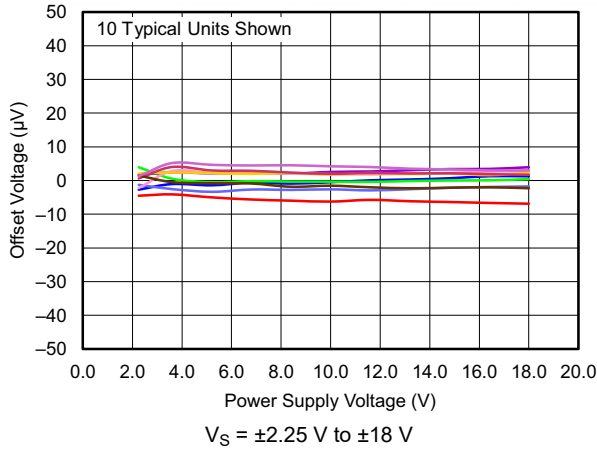

6-13. Offset Voltage vs Power Supply

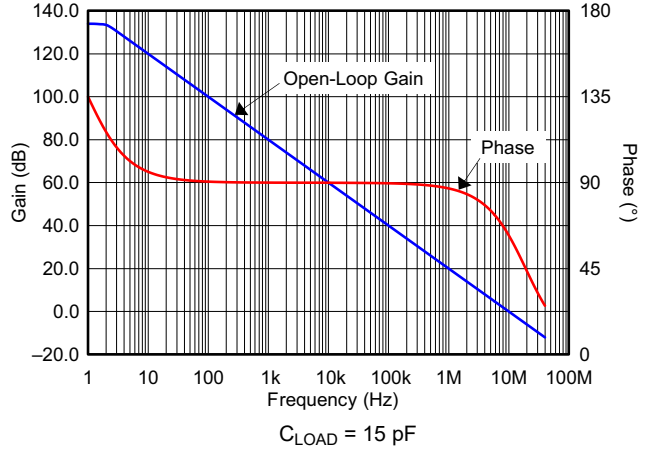

6-14. Open-Loop Gain and Phase vs Frequency

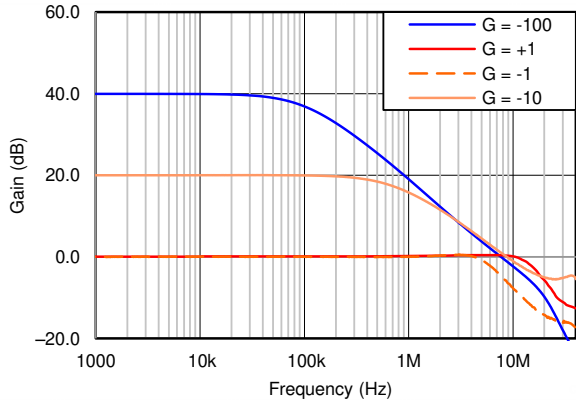

6-15. Closed-Loop Gain and Phase vs Frequency

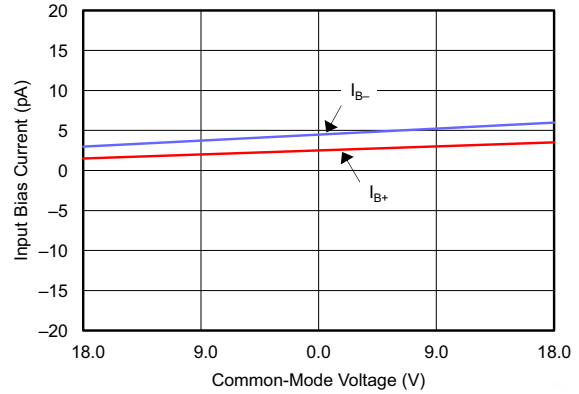

6-16. Input Bias Current vs Common-Mode Voltage

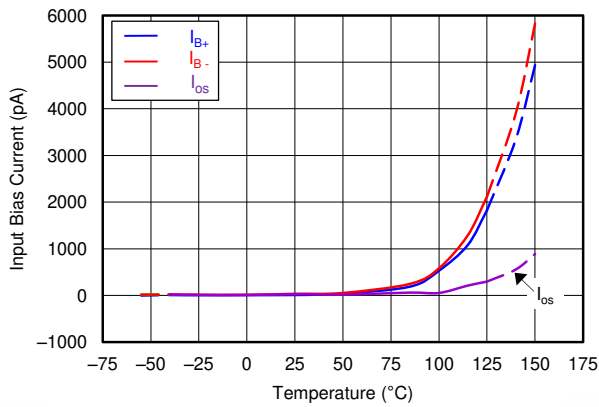

6-17. Input Bias Current vs Temperature

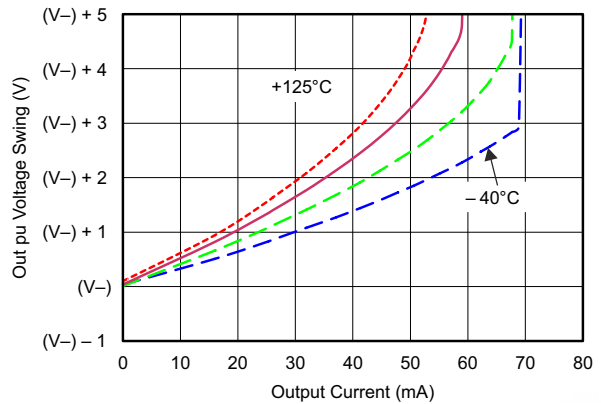

6-18. Output Voltage Swing vs Output Current (Maximum Supply)

6.9 Typical Characteristics (continued)

at $T_A = 25^\circ\text{C}$, $V_S = \pm 18\text{ V}$, $V_{CM} = V_S / 2$, $R_{LOAD} = 10\text{ k}\Omega$ connected to $V_S / 2$, and $C_L = 100\text{ pF}$, (unless otherwise noted)

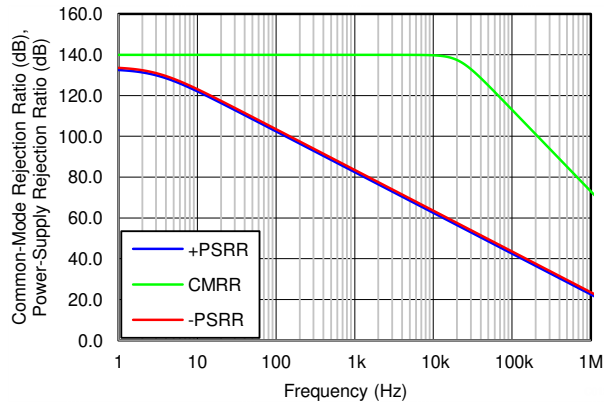

6-19. CMRR and PSRR vs Frequency

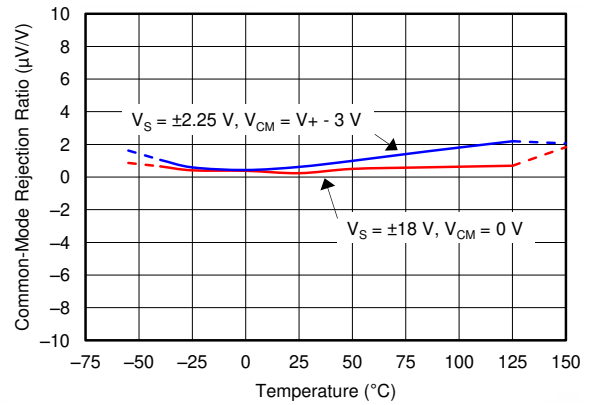

6-20. CMRR vs Temperature

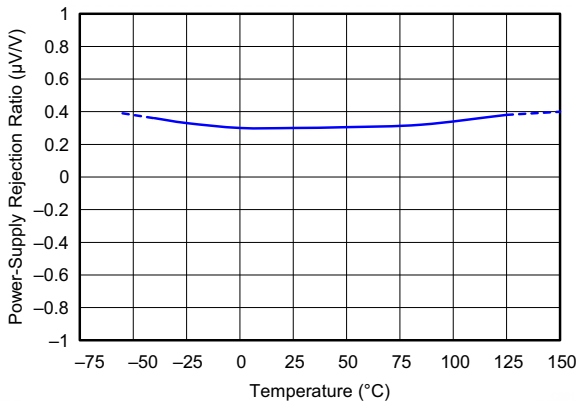

6-21. PSRR vs Temperature

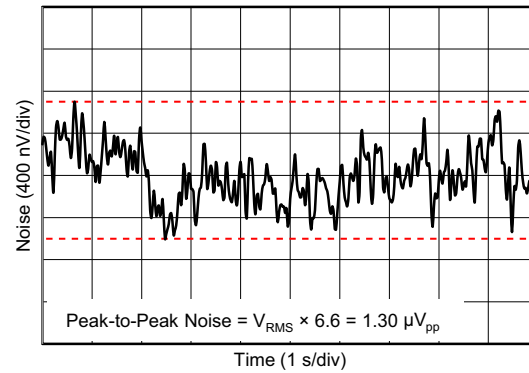

6-22. 0.1-Hz to 10-Hz Noise

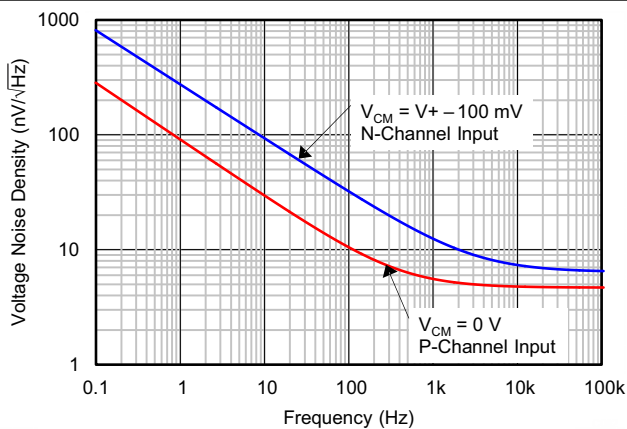

6-23. Input Voltage Noise Spectral Density vs Frequency

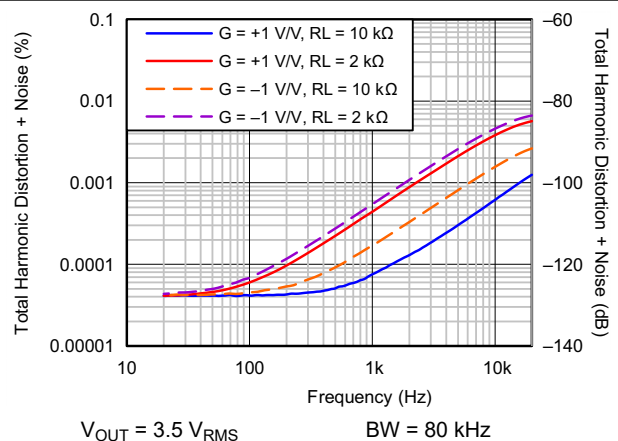

$V_{OUT} = 3.5 V_{RMS}$ $BW = 80\text{ kHz}$

6-24. THD+N Ratio vs Frequency

6.9 Typical Characteristics (continued)

at $T_A = 25^\circ\text{C}$, $V_S = \pm 18\text{ V}$, $V_{CM} = V_S / 2$, $R_{LOAD} = 10\text{ k}\Omega$ connected to $V_S / 2$, and $C_L = 100\text{ pF}$, (unless otherwise noted)

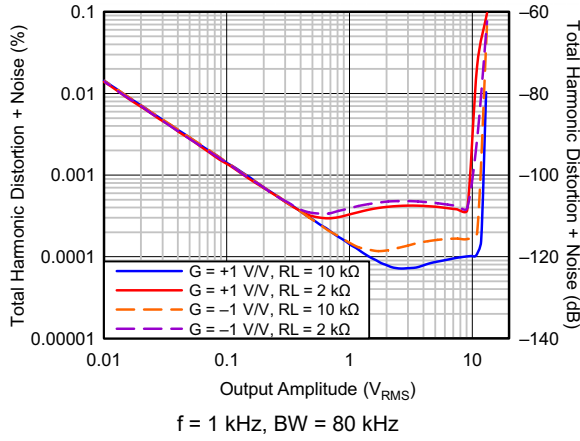

6-25. THD+N vs Output Amplitude

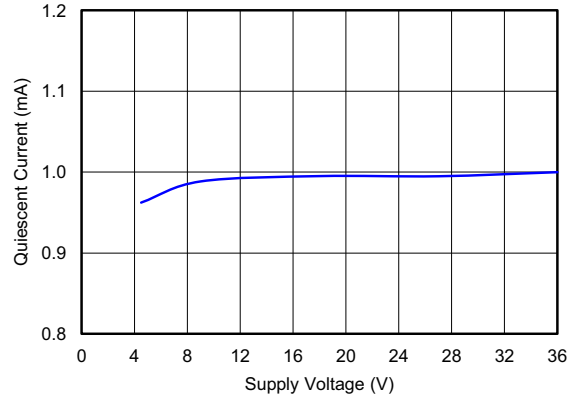

6-26. Quiescent Current vs Supply Voltage

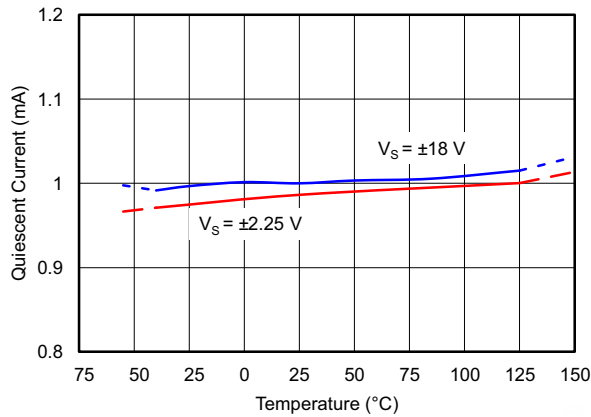

6-27. Quiescent Current vs Temperature

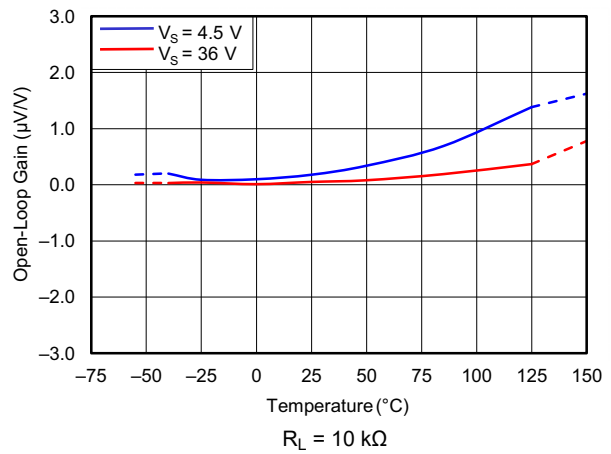

6-28. Open-Loop Gain vs Temperature

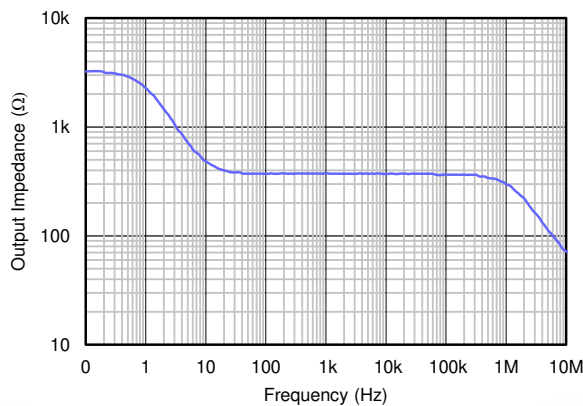

6-29. Open-Loop Output Impedance vs Frequency

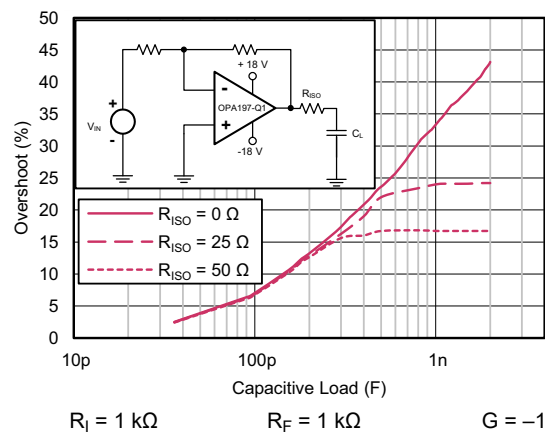

6-30. Small-Signal Overshoot vs Capacitive Load (100-mV Output Step)

6.9 Typical Characteristics (continued)

at $T_A = 25^\circ\text{C}$, $V_S = \pm 18\text{ V}$, $V_{CM} = V_S / 2$, $R_{LOAD} = 10\text{ k}\Omega$ connected to $V_S / 2$, and $C_L = 100\text{ pF}$, (unless otherwise noted)

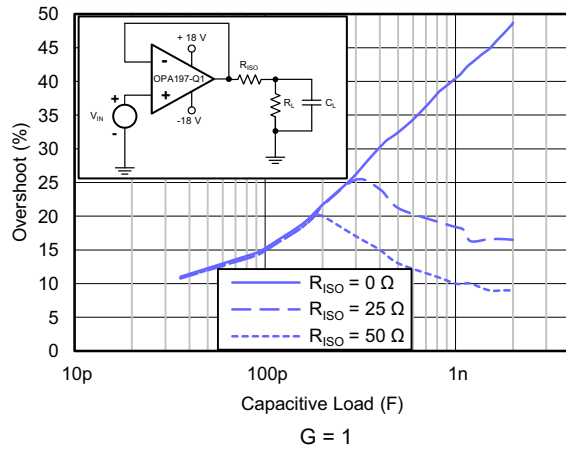

6-31. Small-Signal Overshoot vs Capacitive Load (100-mV Output Step)

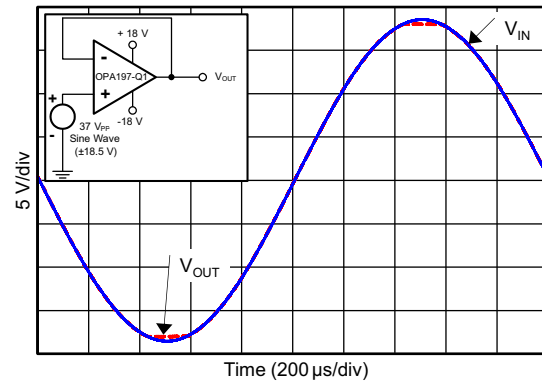

6-32. No Phase Reversal

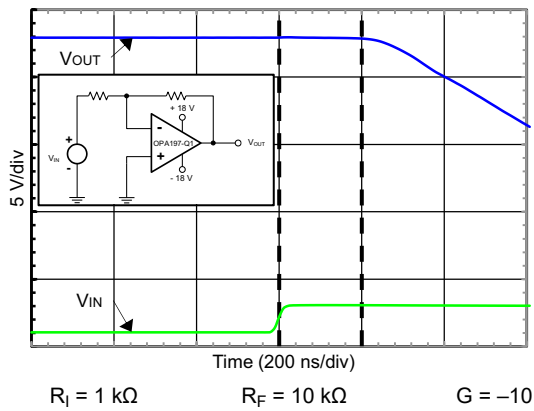

6-33. Positive Overload Recovery

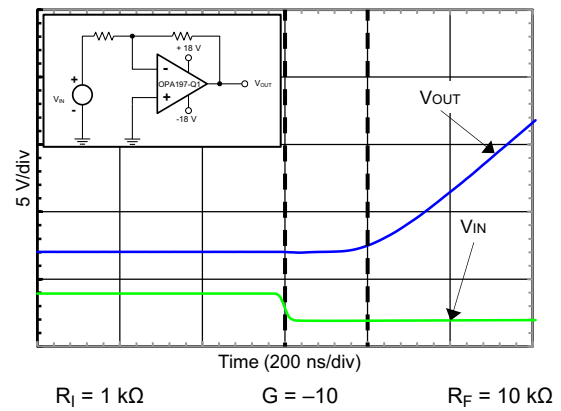

6-34. Negative Overload Recovery

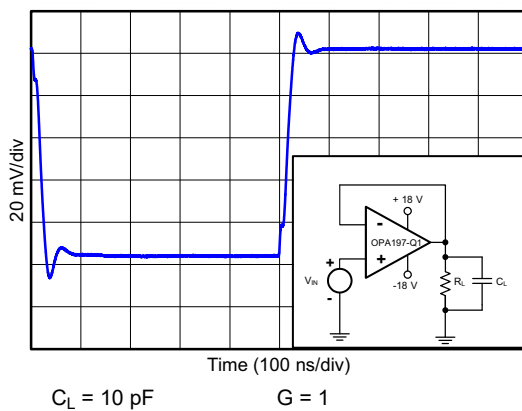

6-35. Small-Signal Step Response (100 mV)

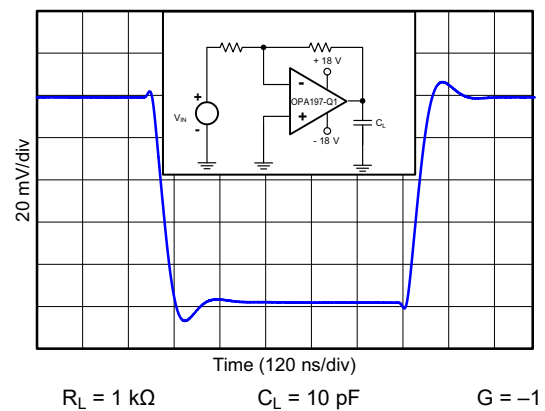

6-36. Small-Signal Step Response (100 mV)

6.9 Typical Characteristics (continued)

at $T_A = 25^\circ\text{C}$, $V_S = \pm 18\text{ V}$, $V_{CM} = V_S / 2$, $R_{LOAD} = 10\text{ k}\Omega$ connected to $V_S / 2$, and $C_L = 100\text{ pF}$, (unless otherwise noted)

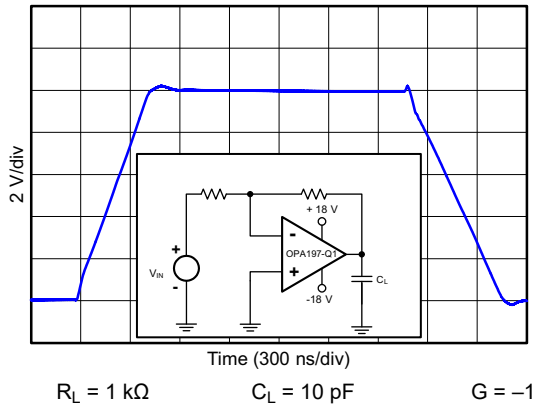

6-37. Large-Signal Step Response

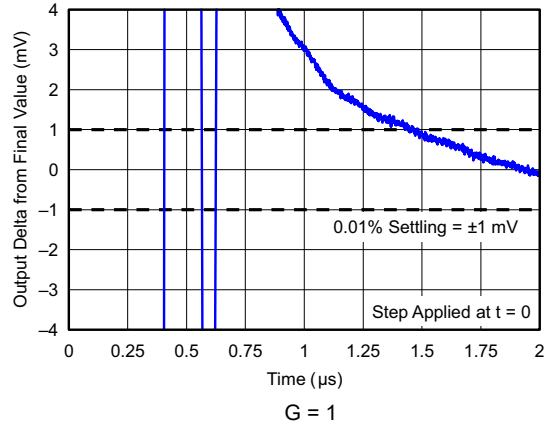

6-38. Settling Time (10-V Positive Step)

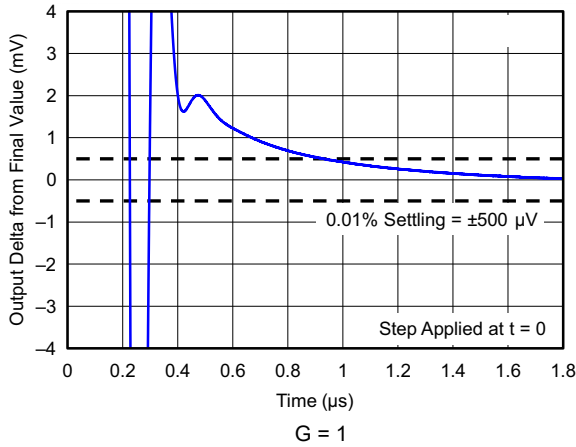

6-39. Settling Time (5-V Positive Step)

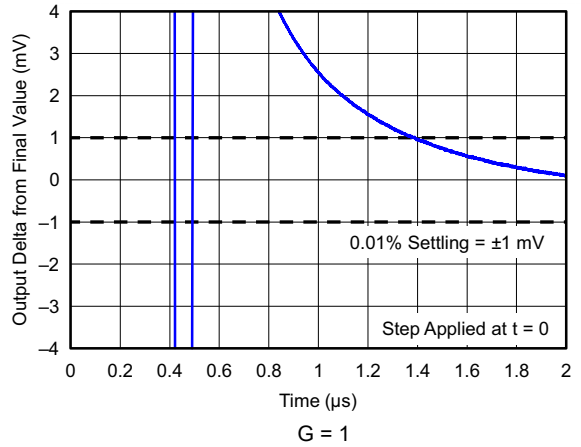

6-40. Settling Time (10-V Negative Step)

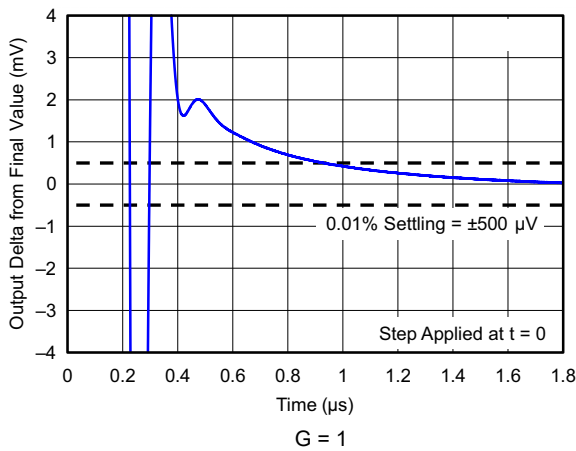

6-41. Settling Time (5-V Negative Step)

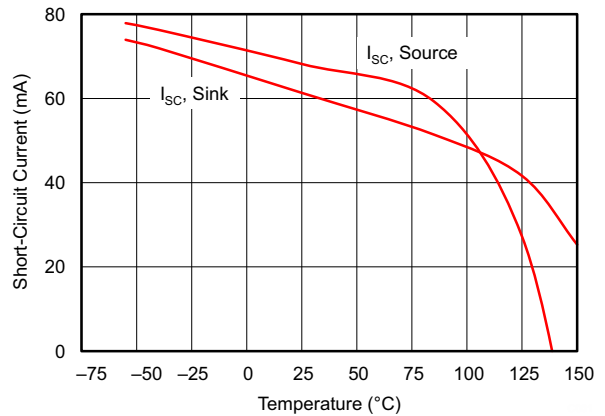

6-42. Short-Circuit Current vs Temperature

6.9 Typical Characteristics (continued)

at $T_A = 25^\circ\text{C}$, $V_S = \pm 18\text{ V}$, $V_{CM} = V_S / 2$, $R_{LOAD} = 10\text{ k}\Omega$ connected to $V_S / 2$, and $C_L = 100\text{ pF}$, (unless otherwise noted)

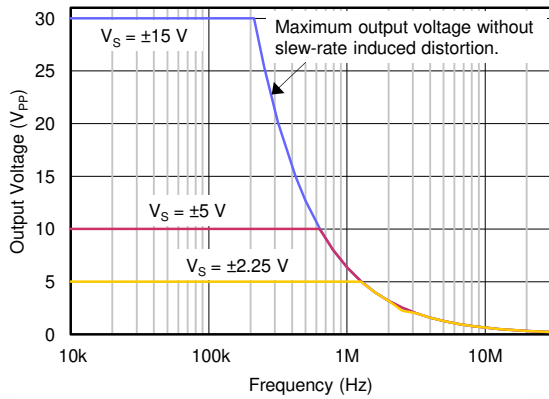

6-43. Maximum Output Voltage vs Frequency

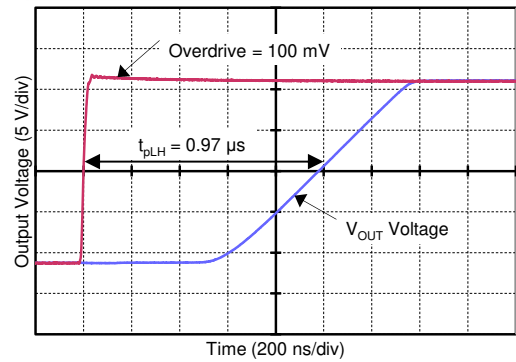

6-44. Propagation Delay Rising Edge

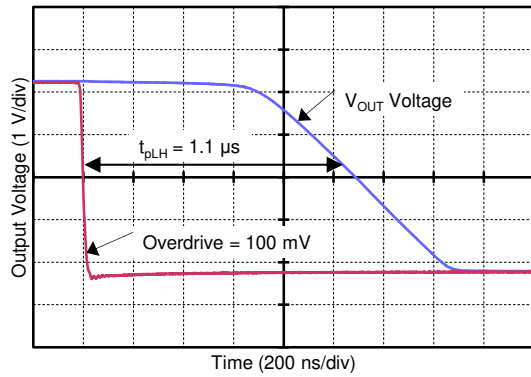

6-45. Propagation Delay Falling Edge

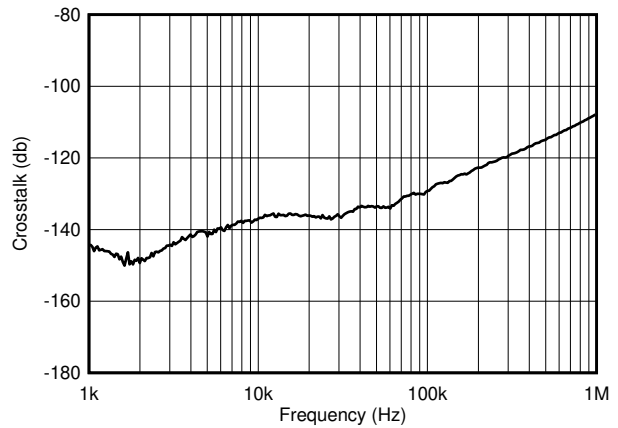

6-46. Crosstalk vs Frequency

7 Detailed Description

7.1 Overview

The OPAx197-Q1 family of e-trim operational amplifiers use a proprietary method of package-level trim for offset and offset temperature drift implemented during the final steps of manufacturing after the plastic molding process. This method minimizes the influence of inherent input transistor mismatch, as well as errors induced during package molding. The trim communication occurs on the output pin of the standard pinout, and after the trim points are set, further communication to the trim structure is permanently disabled. [セクション 7.2](#) shows the simplified diagram of the OPAx197-Q1.

Unlike previous e-trim op amps, the OPAx197-Q1 uses a patented two-temperature trim architecture to achieve a very-low offset voltage of 25 μV (maximum) and low voltage offset drift of 0.5 $\mu\text{V}/^\circ\text{C}$ (maximum) over the full specified temperature range. This level of precision performance at wide supply voltages makes these amplifiers especially useful for high-impedance industrial sensors, filters, and high-voltage data acquisition.

7.2 Functional Block Diagram

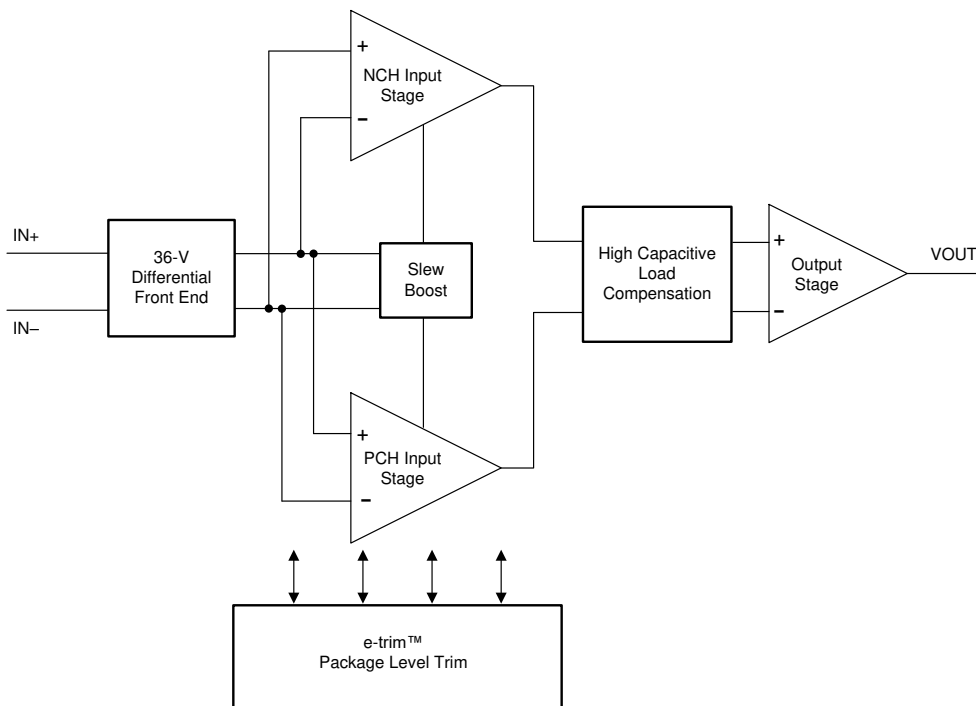

7.3 Feature Description

7.3.1 Input Protection Circuitry

The OPAx197-Q1 use a unique input architecture to eliminate the need for input protection diodes but still provide robust input protection under transient conditions. Conventional input diode protection schemes shown in [7-1](#) can be activated by fast transient step responses, and can introduce signal distortion and settling-time delays because of alternate current paths, as shown in [7-2](#). For low-gain circuits, these fast-ramping input signals forward-bias back-to-back diodes, causing an increase in input current, and resulting in extended settling time, as shown in [7-3](#).

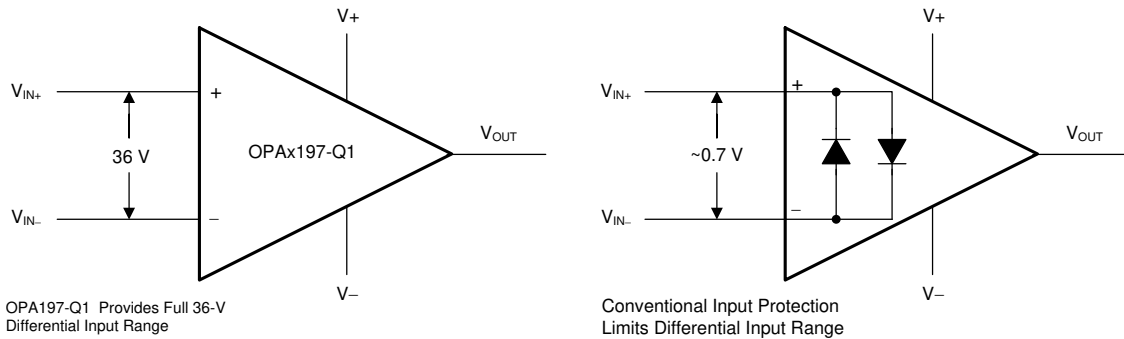

Copyright © 2018, Texas Instruments Incorporated

7-1. OPAx197-Q1 Input Protection Does Not Limit Differential Input Capability

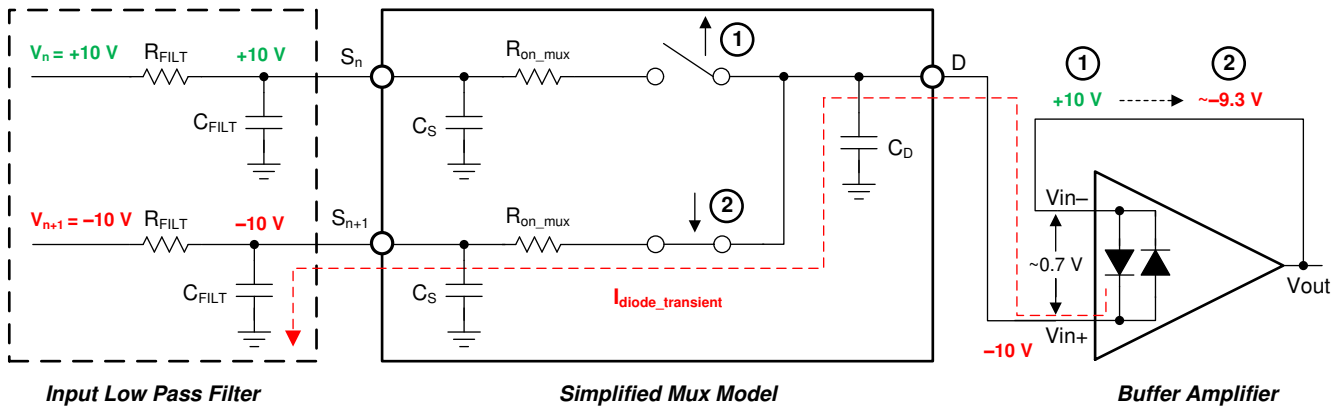

7-2. Back-to-Back Diodes Create Settling Issues

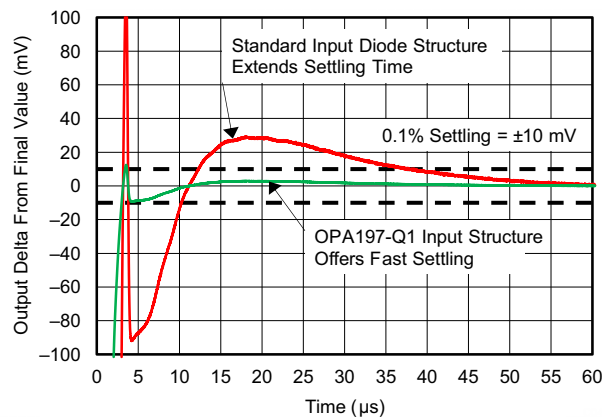

7-3. OPAx197-Q1 Protection Circuit Maintains Fast-Settling Transient Response

The OPAx197-Q1 family of operational amplifiers provides a true high-impedance differential input capability for high-voltage applications. This patented input protection architecture does not introduce additional signal distortion or delayed settling time, making these devices the optimal op amps for multichannel, high-switched, input applications. The OPAx197-Q1 tolerate a maximum differential swing (voltage between inverting and noninverting pins of the op amp) of up to 36 V, making these devices an excellent choice for use as comparators or in applications with fast-ramping input signals, such as multiplexed data-acquisition systems; see [8-1](#).

7.3.2 EMI Rejection

The OPAx197-Q1 use integrated electromagnetic interference (EMI) filtering to reduce the effects of EMI from sources such as wireless communications and densely-populated boards with a mix of analog signal chain and digital components. EMI immunity can be improved with circuit design techniques; the OPAx197-Q1 benefit from these design improvements. Texas Instruments has developed the ability to accurately measure and quantify the immunity of an operational amplifier over a broad frequency spectrum extending from 10 MHz to 6 GHz. [7-4](#) shows the results of this testing on the OPAx197-Q1. [表 7-1](#) shows the EMIRR IN+ values for the OPAx197-Q1 at particular frequencies commonly encountered in real-world applications. Applications listed in [表 7-1](#) may be centered on or operated near the particular frequency shown. Detailed information can also be found in the TI application report [EMI Rejection Ratio of Operational Amplifiers](#) available for download from www.ti.com.



图 7-4. EMIRR Testing

表 7-1. OPAx197-Q1 EMIRR IN+ For Frequencies of Interest

FREQUENCY	APPLICATION OR ALLOCATION	EMIRR IN+
400 MHz	Mobile radio, mobile satellite, space operation, weather, radar, ultra-high frequency (UHF) applications	44.1 dB
900 MHz	Global system for mobile communications (GSM) applications, radio communication, navigation, GPS (to 1.6 GHz), GSM, aeronautical mobile, UHF applications	52.8 dB
1.8 GHz	GSM applications, mobile personal communications, broadband, satellite, L-band (1 GHz to 2 GHz)	61.0 dB
2.4 GHz	802.11b, 802.11g, 802.11n, Bluetooth®, mobile personal communications, industrial, scientific and medical (ISM) radio band, amateur radio and satellite, S-band (2 GHz to 4 GHz)	69.5 dB
3.6 GHz	Radiolocation, aero communication and navigation, satellite, mobile, S-band	88.7 dB
5 GHz	802.11a, 802.11n, aero communication and navigation, mobile communication, space and satellite operation, C-band (4 GHz to 8 GHz)	105.5 dB

7.3.3 Phase Reversal Protection

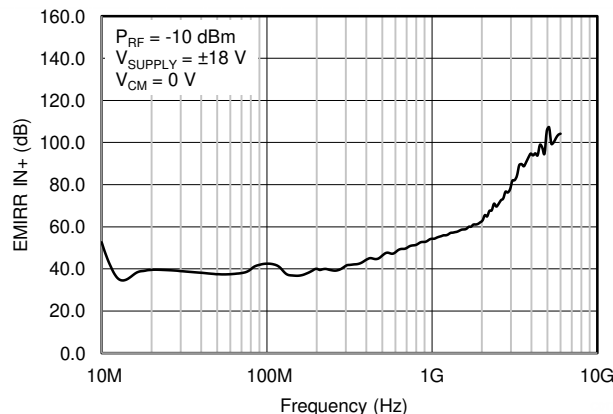
The OPAx197-Q1 family has internal phase-reversal protection. Many op amps exhibit a phase reversal when the input is driven beyond its linear common-mode range. This condition is most often encountered in noninverting circuits when the input is driven beyond the specified common-mode voltage range, causing the output to reverse into the opposite rail. The OPAx197-Q1 is a rail-to-rail input op amp; therefore, the common-mode range can extend up to the rails. Input signals beyond the rails do not cause phase reversal; instead, the output limits into the appropriate rail. This performance is shown in [Figure 7-5](#).

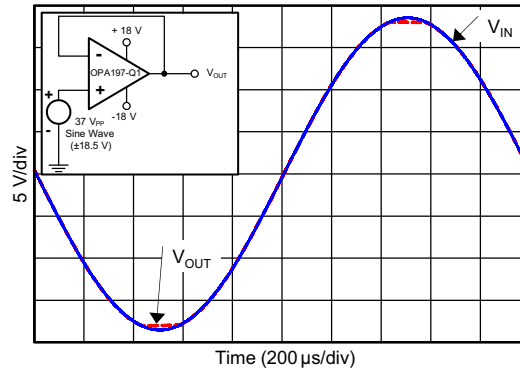
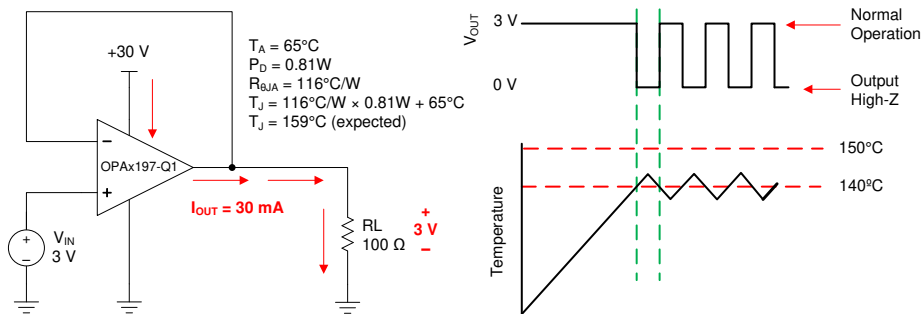

Figure 7-5. No Phase Reversal

7.3.4 Thermal Protection

The internal power dissipation of any amplifier causes the internal (junction) temperature to rise. This phenomenon is called *self heating*. The absolute maximum junction temperature of the OPAx197-Q1 is 150°C and exceeding this maximum temperature causes damage to the device. The OPAx197-Q1 have a thermal protection feature that prevents damage from self heating. The protection works by monitoring the temperature of the device and turning off the op amp output drive for temperatures above 140°C. [Figure 7-6](#) shows an application example for the OPAx197-Q1 that has significant self heating (159°C) because of the power dissipation (0.81 W). Thermal calculations indicate that for an ambient temperature of 65°C, the device junction temperature must reach 187°C. The actual device, however, turns off the output drive to maintain a safe junction temperature. [Figure 7-6](#) shows how the circuit behaves during thermal protection. During normal operation, the device acts as a buffer so the output is 3 V. When self heating causes the device junction temperature to increase above 140°C, the thermal protection forces the output to a high-impedance state and the output is pulled to ground through resistor R_L .



Copyright © 2017, Texas Instruments Incorporated

Figure 7-6. Thermal Protection

7.3.5 Capacitive Load and Stability

The OPAx197-Q1 feature a patented output stage capable of driving large capacitive loads, and in a unity-gain configuration, directly drive up to 1 nF of pure capacitive load. Increasing the gain enhances the ability of these amplifiers to drive greater capacitive loads; see [Figure 7-7](#) and [Figure 7-8](#). The particular op-amp circuit configuration, layout, gain, and output loading are some of the factors to consider when establishing whether an amplifier is stable in operation.

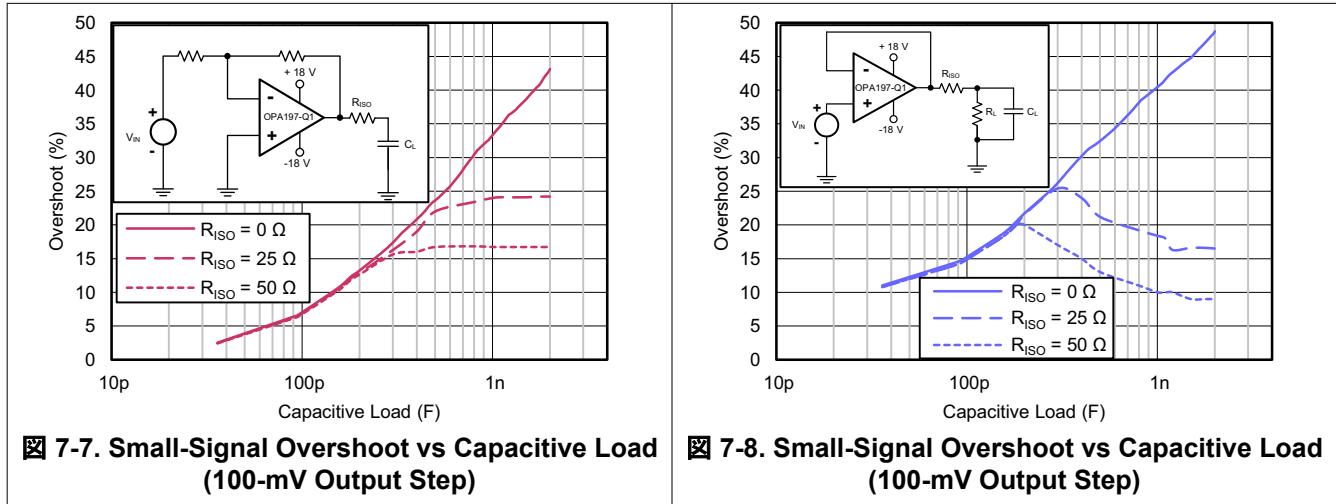

For additional drive capability in unity-gain configurations, improve capacitive load drive by inserting a small (10- Ω to 20- Ω) resistor, R_{ISO} , in series with the output, as shown in [Figure 7-9](#). This resistor significantly reduces ringing and maintains dc performance for purely capacitive loads. However, if a resistive load is in parallel with the capacitive load, then a voltage divider is created, thus introducing a gain error at the output and slightly reducing the output swing. The error introduced is proportional to the ratio R_{ISO} / R_L , and is generally negligible at low output levels. A high capacitive load drive makes the OPAx197-Q1 a great choice for applications such as reference buffers, MOSFET gate drives, and cable-shield drives. The circuit shown in [Figure 7-9](#) uses an isolation resistor, R_{ISO} , to stabilize the output of an op amp. R_{ISO} modifies the open-loop gain of the system for increased phase margin, and results using the OPAx197-Q1 are summarized in [Table 7-2](#). For additional information on techniques to optimize and design using this circuit, TI Precision Design [TIPD128](#) details complete design goals, simulation, and test results.

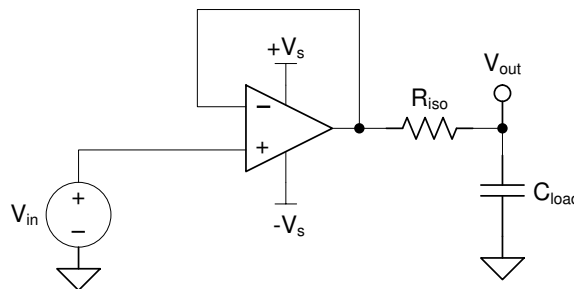

Figure 7-9. Extending Capacitive Load Drive With the OPAx197-Q1

表 7-2. OPAX197-Q1 Capacitive Load Drive Solution Using Isolation Resistor Comparison of Calculated and Measured Results

PARAMETER	VALUE										
	100 pF		1000 pF		0.01 μF		0.1 μF		1 μF		
Capacitive Load	100 pF		1000 pF		0.01 μF		0.1 μF		1 μF		
Phase Margin	45°	60°	45°	60°	45°	60°	45°	60°	45°	60°	
R _{ISO} (Ω)	47	360	24	100	20	51	6.2	15.8	2	4.7	
Measured Overshoot (%)	23.2	8.6	10.4	22.5	9	22.1	8.7	23.1	8.6	21	8.6
Calculated PM	45.1°	58.1°	45.8°	59.7°	46.1°	60.1°	45.2°	60.2°	47.2°	60.2°	

For step-by-step design procedure, circuit schematics, bill of materials, printed circuit board (PCB) files, simulation results, and test results, see [TI Precision Design TIPD128 Capacitive Load Drive Solution using an Isolation Resistor](#).

7.3.6 Common-Mode Voltage Range

The OPAX197-Q1 are 36-V, true rail-to-rail input operational amplifiers with an input common-mode range that extends 100 mV beyond either supply rail. This wide range is achieved with paralleled complementary N-channel and P-channel differential input pairs, as shown in [Figure 7-10](#). The N-channel pair is active for input voltages close to the positive rail, typically $(V+) - 3\text{ V}$ to 100 mV above the positive supply. The P-channel pair is active for inputs from 100 mV below the negative supply to approximately $(V+) - 1.5\text{ V}$. There is a small transition region, typically $(V+) - 3\text{ V}$ to $(V+) - 1.5\text{ V}$, in which both input pairs are on. This transition region can vary modestly with process variation, and within this region, PSRR, CMRR, offset voltage, offset drift, noise, and THD performance may be degraded compared to operation outside this region.

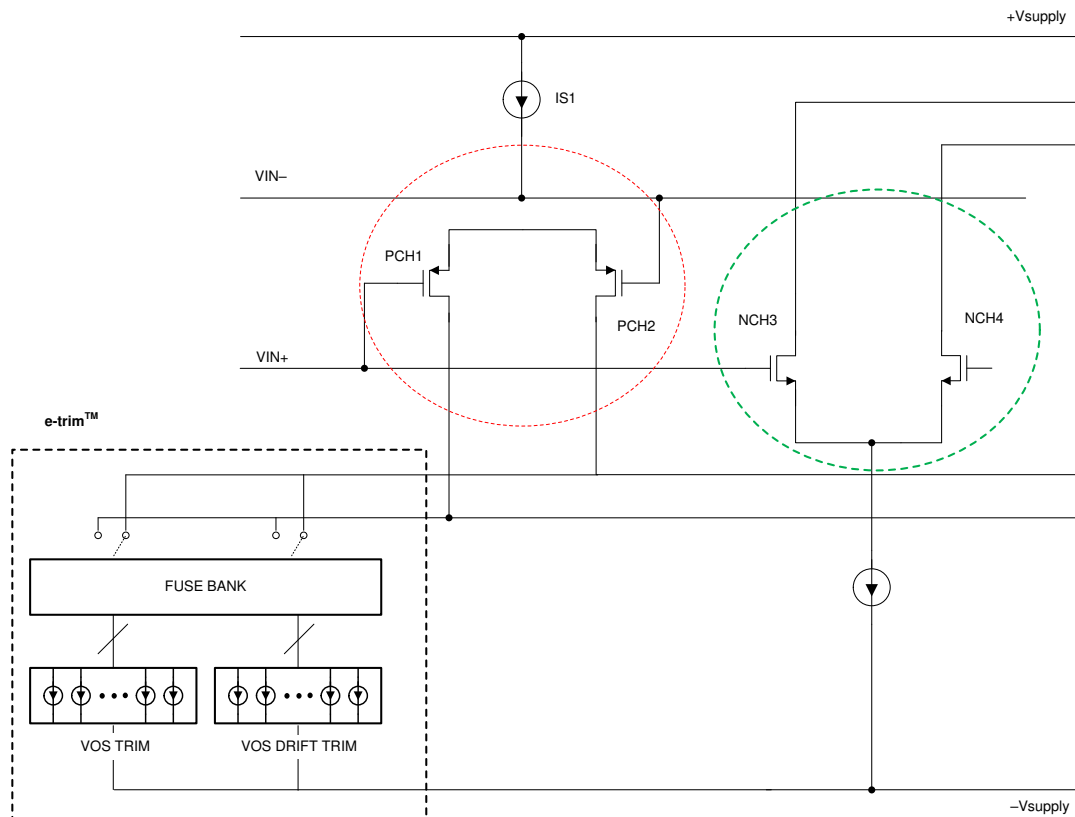

Figure 7-10. Rail-to-Rail Input Stage

To achieve the best performance for two-stage rail-to-rail input amplifiers, avoid the transition region when possible. The OPAx197-Q1 use a precision trim for both the N-channel and P-channel regions. This technique enables significantly lower levels of offset than previous-generation devices, causing variance in the transition region of the input stages to appear exaggerated relative to offset over the full common-mode range, as shown in [Figure 7-11](#).

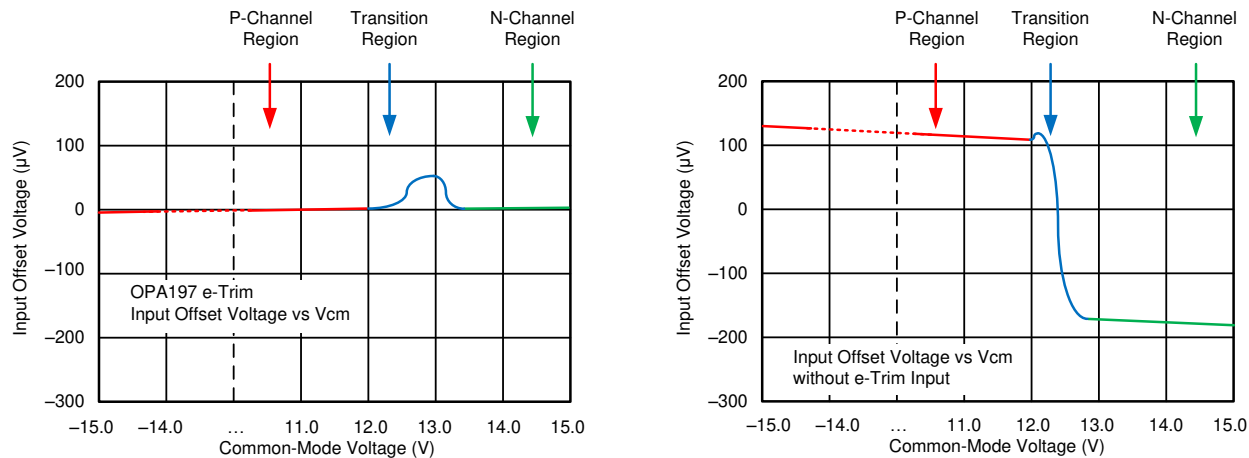
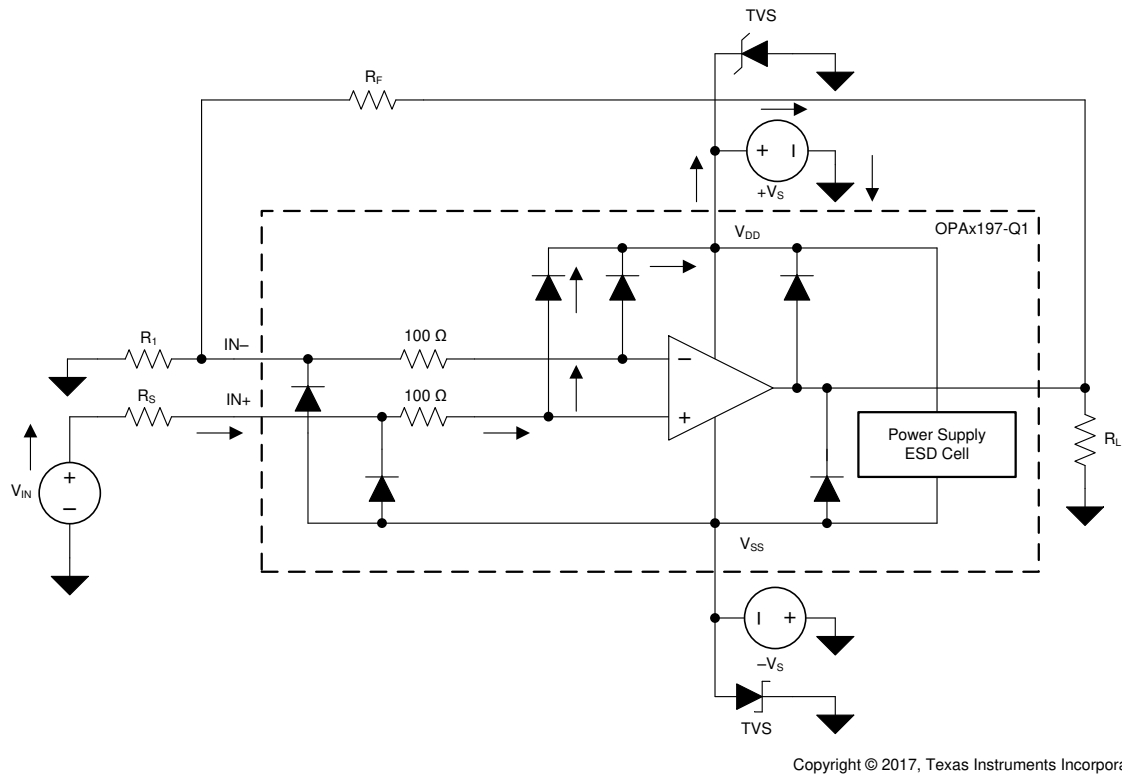

Figure 7-11. Common-Mode Transition vs Standard Rail-to-Rail Amplifiers

7.3.7 Electrical Overstress

Designers often ask questions about the capability of an operational amplifier to withstand electrical overstress (EOS). These questions tend to focus on the device inputs, but may involve the supply voltage pins or even the output pin. Each of these different pin functions have electrical stress limits determined by the voltage breakdown characteristics of the particular semiconductor fabrication process and specific circuits connected to the pin. Additionally, internal electrostatic discharge (ESD) protection is built into these circuits to protect them from accidental ESD events both before and during product assembly.

Having a good understanding of this basic ESD circuitry and its relevance to an electrical overstress event is helpful. [Figure 7-12](#) shows an illustration of the ESD circuits contained in the OPAx197-Q1 (indicated by the dashed line area). The ESD protection circuitry involves several current-steering diodes connected from the input and output pins and routed back to the internal power-supply lines, where the diodes meet at an absorption device or the power-supply ESD cell, internal to the operational amplifier. This protection circuitry is intended to remain inactive during normal circuit operation.



Copyright © 2017, Texas Instruments Incorporated

图 7-12. Equivalent Internal ESD Circuitry Relative to a Typical Circuit Application

An ESD event is very short in duration and very high voltage (for example, 1 kV, 100 ns), whereas an EOS event is long duration and lower voltage (for example, 50 V, 100 ms). The ESD diodes are designed for out-of-circuit ESD protection (that is, during assembly, test, and storage of the device before being soldered to the PCB). During an ESD event, the ESD signal is passed through the ESD steering diodes to an absorption circuit (labeled ESD power-supply circuit). The ESD absorption circuit clamps the supplies to a safe level.

Although this behavior is necessary for out-of-circuit protection, excessive current and damage is caused if activated in-circuit. A transient voltage suppressors (TVS) can be used to prevent against damage caused by turning on the ESD absorption circuit during an in-circuit ESD event. Using the appropriate current limiting resistors and TVS diodes allows for the use of device ESD diodes to protect against EOS events.

7.3.8 Overload Recovery

Overload recovery is defined as the time required for the op amp output to recover from a saturated state to a linear state. The output devices of the op amp enter a saturation region when the output voltage exceeds the rated operating voltage, either due to the high input voltage or the high gain. After the device enters the saturation region, the charge carriers in the output devices require time to return back to the linear state. After the charge carriers return back to the linear state, the device begins to slew at the specified slew rate. Thus, the propagation delay in case of an overload condition is the sum of the overload recovery time and the slew time. The overload recovery time for the OPAx197-Q1 is approximately 200 ns.

7.4 Device Functional Modes

The OPAx197-Q1 have a single functional mode and is operational when the power-supply voltage is greater than 4.5 V (± 2.25 V). The maximum power supply voltage for the OPAx197-Q1 is 36 V (± 18 V).

8 Application and Implementation

注

以下のアプリケーション情報は、TI の製品仕様に含まれるものではなく、TI ではその正確性または完全性を保証いたしません。個々の目的に対する製品の適合性については、お客様の責任で判断していただくこととなります。また、お客様は自身の設計実装を検証しテストすることで、システムの機能を確認する必要があります。

8.1 Application Information

The OPAx197-Q1 family offers outstanding dc precision and ac performance. These devices operate up to 36-V supply rails and offer true rail-to-rail input and output, ultra-low offset voltage and offset voltage drift, as well as 10-MHz bandwidth and high capacitive load drive. These features make the OPAx197-Q1 a robust, high-performance operational amplifier for high-voltage industrial applications.

8.2 Typical Applications

8.2.1 16-Bit Precision Multiplexed Data-Acquisition System

Figure 8-1 shows a 16-bit, differential, 4-channel, multiplexed data-acquisition system. This example is typical in industrial applications that require low distortion and a high-voltage differential input. The circuit uses the ADS8864, a 16-bit, 400-kSPS successive-approximation-resistor (SAR) analog-to-digital converter (ADC), along with a precision, high-voltage, signal-conditioning front end, and a 4-channel differential multiplexer (mux). This TI Precision Design details the process for optimizing the precision, high-voltage, front-end drive circuit using the OPAx197-Q1 and OPA140 to achieve excellent dynamic performance and linearity with the ADS8864.

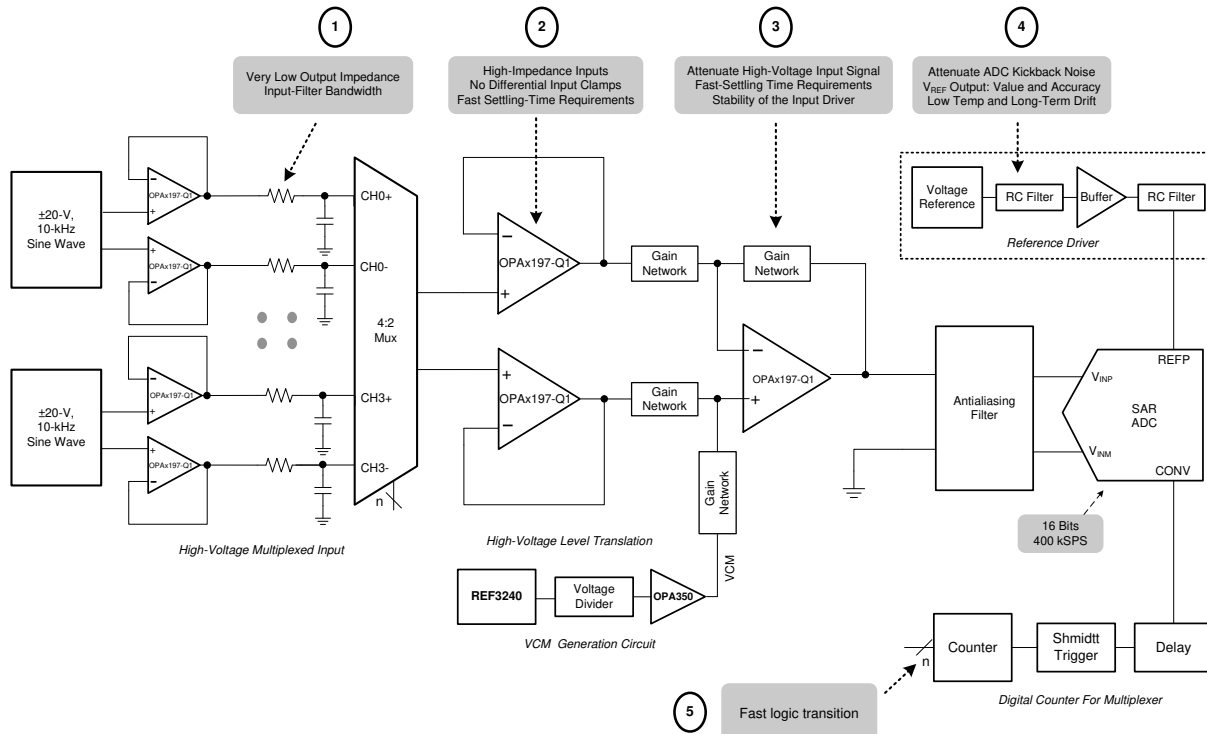

Copyright © 2017, Texas Instruments Incorporated

Figure 8-1. OPAx197-Q1 in 16-Bit, 400-kSPS, 4-Channel, Multiplexed Data Acquisition System for High-Voltage Inputs With Lowest Distortion

8.2.1.1 Design Requirements

The primary objective is to design a $\pm 20\text{-V}$, differential, 4-channel, multiplexed data acquisition system with lowest distortion using the 16-bit ADS8864 at a throughput of 400 kSPS for a 10-kHz, full-scale, pure sine-wave input. The design requirements for this block design are:

- System supply voltage: $\pm 15\text{ V}$
- ADC supply voltage: 3.3 V
- ADC sampling rate: 400 kSPS
- ADC reference voltage (REFP): 4.096 V
- System input signal: A high-voltage differential input signal with a peak amplitude of 10 V and frequency (f_{IN}) of 10 kHz are applied to each differential input of the multiplexer.

8.2.1.2 Detailed Design Procedure

The purpose of this precision design is to design an optimal high voltage multiplexed data acquisition system for highest system linearity and fast settling. The overall system block diagram is illustrated in [Figure 8-1](#). The circuit is a multichannel data acquisition signal chain consisting of an input low-pass filter, mux, mux output buffer, attenuating SAR ADC driver, digital counter for mux and the reference driver. The architecture allows fast sampling of multiple channels using a single ADC, providing a low-cost solution. The two primary design considerations to maximize the performance of a precision multiplexed data acquisition system are the mux input analog front-end and the high-voltage level translation SAR ADC driver design. However, carefully design each analog circuit block based on the ADC performance specifications in order to achieve the fastest settling at 16-bit resolution and lowest distortion system. [Figure 8-1](#) includes the most important specifications for each individual analog block.

This design systematically approaches each analog circuit block to achieve a 16-bit settling for a full-scale input stage voltage and linearity for a 10-kHz sinusoidal input signal at each input channel. The first step in the design is to understand the requirement for extremely low impedance input-filter design for the mux. This understanding helps in the decision of an appropriate input filter and selection of a mux to meet the system settling requirements. The next important step is the design of the attenuating analog front-end (AFE) used to level translate the high-voltage input signal to a low-voltage ADC input when maintaining amplifier stability. The next step is to design a digital interface to switch the mux input channels with minimum delay. The final design challenge is to design a high-precision, reference-driver circuit that provides the required REFP reference voltage with low offset, drift, and noise contributions.

For step-by-step design procedure, circuit schematics, bill of materials, PCB files, simulation results, and test results, refer to [TI Precision Design TIPD151, 16-bit, 400-kSPS, 4-Channel, Multiplexed Data Acquisition System for High Voltage Inputs with Lowest Distortion](#).

8.2.1.3 Application Curve

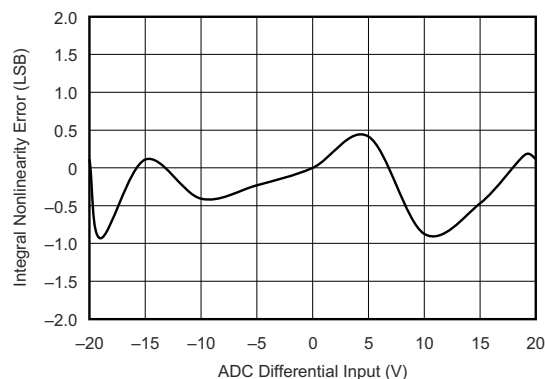
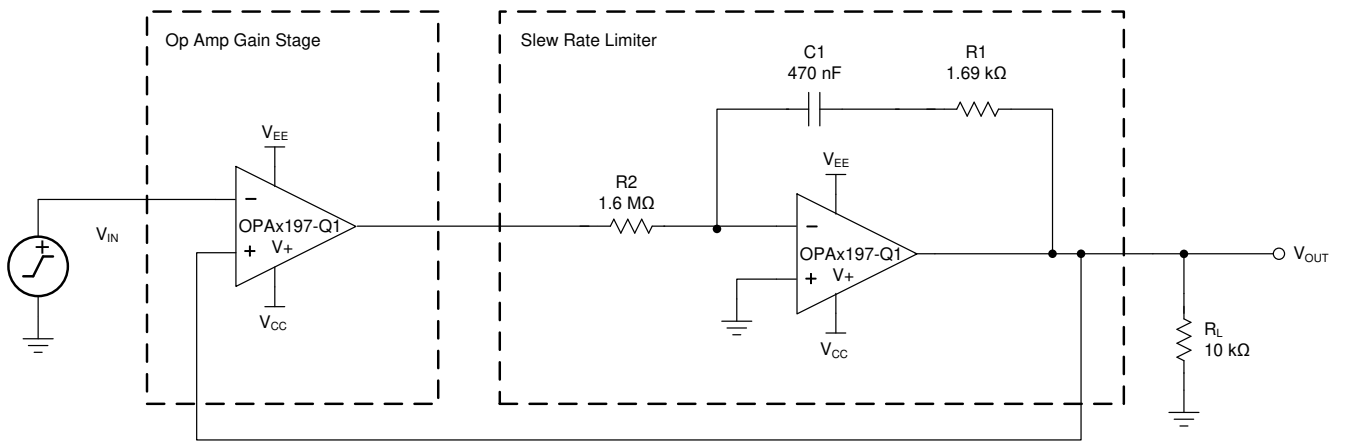

Figure 8-2. ADC 16-Bit Linearity Error for the Multiplexed Data Acquisition Block

8.2.2 Slew-Rate Limit for Input Protection

In control systems for valves or motors, abrupt changes in voltages or currents can cause mechanical damages. By controlling the slew rate of the command voltages into the drive circuits, the load voltages ramps up and down at a safe rate. For symmetrical slew-rate applications (positive slew rate equals negative slew rate), one additional op amp provides slew-rate control for a given analog gain stage. The unique input protection and high output current and slew rate of the OPAx197-Q1 make these devices the optimal amplifiers to achieve slew-rate control for both dual- and single-supply systems. [Figure 8-3](#) shows the OPAx197-Q1 in a slew-rate limit design.



Copyright © 2017, Texas Instruments Incorporated

Figure 8-3. Slew-Rate Limiter Uses One Op Amp

For step-by-step design procedure, circuit schematics, bill of materials, PCB files, simulation results, and test results, see [TI Precision Design TIPD140, Slew Rate Limiter Uses One Op Amp](#).

8.2.3 Precision Reference Buffer

The OPAx197-Q1 feature high output-current-drive capability and low input offset voltage, making these devices an excellent reference buffer to provide an accurate buffered output with ample drive current for transients. For the 10- μ F ceramic capacitor shown in [Figure 8-4](#), a 37.4- Ω isolation resistor (R_{ISO}), provides separation of two feedback paths for optimal stability. Feedback path number one is through R_F and is directly at the output (V_{OUT}). Feedback path number two is through R_{FX} and C_F and is connected at the output of the op amp. The optimized stability components shown for the 10- μ F load give a closed-loop signal bandwidth at V_{OUT} of 4 kHz and still provide a loop gain phase margin of 89°. Any other load capacitances require recalculation of the stability components: R_F , R_{FX} , C_F , and R_{ISO} .

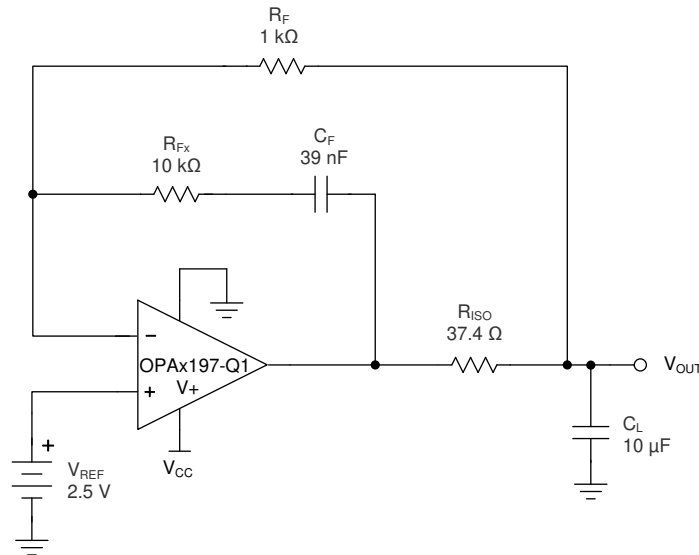

Copyright © 2017, Texas Instruments Incorporated

Figure 8-4. Precision Reference Buffer

9 Power Supply Recommendations

The OPAx197-Q1 are specified for operation from 4.5 V to 36 V (± 2.25 V to ± 18 V); many specifications apply from -40°C to $+125^{\circ}\text{C}$. Parameters that can exhibit significant variance with regard to operating voltage or temperature are presented in [セクション 6.9](#).

注意

Supply voltages larger than 40 V can permanently damage the device; see [Absolute Maximum Ratings](#).

Place 0.1- μF bypass capacitors close to the power-supply pins to reduce errors coupling in from noisy or high-impedance power supplies. For more detailed information on bypass capacitor placement, see [セクション 10](#).

10 Layout

10.1 Layout Guidelines

For best operational performance of the device, use good PCB layout practices, including:

- Noise can propagate into analog circuitry through the power pins of the circuit as a whole and op amp itself. Bypass capacitors are used to reduce the coupled noise by providing low-impedance power sources local to the analog circuitry.
 - Connect low-ESR, 0.1- μF ceramic bypass capacitors between each supply pin and ground, placed as close as possible to the device. A single bypass capacitor from V+ to ground is applicable for single-supply applications.
- Separate grounding for analog and digital portions of circuitry is one of the simplest and most-effective methods of noise suppression. One or more layers on multilayer PCBs are usually devoted to ground planes. A ground plane helps distribute heat and reduces EMI noise pickup. Make sure to physically separate digital and analog grounds paying attention to the flow of the ground current.
- To reduce parasitic coupling, run the input traces as far away as possible from the supply or output traces. If these traces cannot be kept separate, crossing the sensitive trace perpendicular is much better than in parallel with the noisy trace.
- Place the external components as close as possible to the device. As illustrated in [図 10-2](#), keep RF and RG close to the inverting input to minimize parasitic capacitance.
- Keep the length of input traces as short as possible. Always remember that the input traces are the most sensitive part of the circuit.
- Consider a driven, low-impedance guard ring around the critical traces. A guard ring can significantly reduce leakage currents from nearby traces that are at different potentials.
- For best performance, clean the PCB following board assembly.
- Any precision integrated circuit may experience performance shifts due to moisture ingress into the plastic package. Following any aqueous PCB cleaning process, bake the PCB assembly to remove moisture introduced into the device packaging during the cleaning process. A low-temperature, post-cleaning bake at 85°C for 30 minutes is sufficient for most circumstances.

10.2 Layout Examples

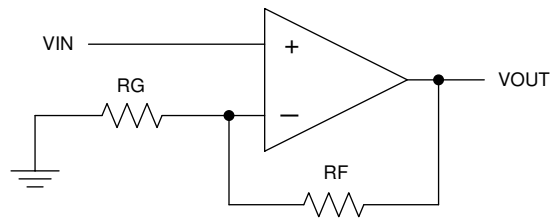

10-1. Schematic Representation

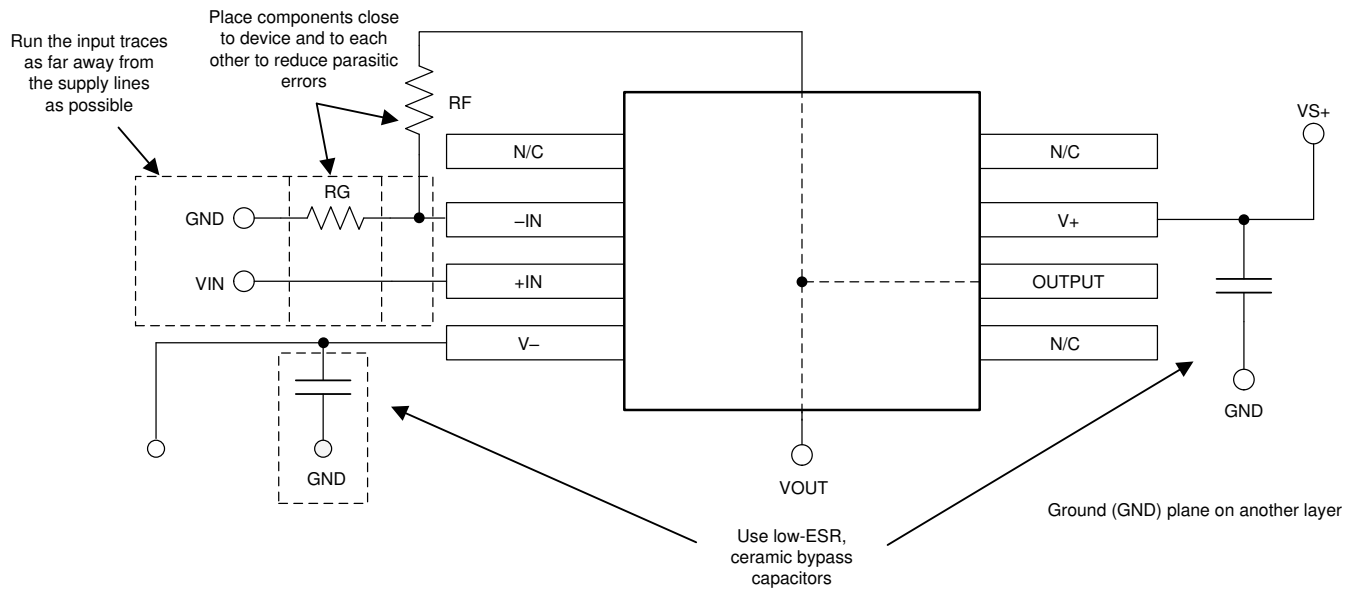

10-2. Operational Amplifier Board Layout for Noninverting Configuration

11 Device and Documentation Support

11.1 Device Support

11.1.1 Development Support

11.1.1.1 TINA-TI™ Simulation Software (Free Download)

TINA™ is a simple, powerful, and easy-to-use circuit simulation program based on a SPICE engine. TINA-TI™ simulation software is a free, fully functional version of the TINA software, preloaded with a library of macro models in addition to a range of both passive and active models. TINA-TI simulation software provides all the conventional dc, transient, and frequency domain analysis of SPICE, as well as additional design capabilities.

Available as a [free download](#) from the Analog eLab Design Center, TINA-TI simulation software offers extensive post-processing capability that allows users to format results in a variety of ways. Virtual instruments offer the ability to select input waveforms and probe circuit nodes, voltages, and waveforms, creating a dynamic quick-start tool.

注

These files require that either the TINA software (from DesignSoft™) or TINA-TI software be installed. Download the free TINA-TI software from the [TINA-TI folder](#).

11.1.1.2 TI Precision Designs

The OPA197 is featured in several Texas Instruments (TI) Precision Designs, available online at <http://www.ti.com/ww/en/analog/precision-designs/>. TI Precision Designs are analog solutions created by TI's precision analog applications experts and offer the theory of operation, component selection, simulation, complete PCB schematic and layout, bill of materials, and measured performance of many useful circuits.

11.2 Documentation Support

11.2.1 Related Documentation

For related documentation see the following:

- Texas Instruments, [EMI Rejection Ratio of Operational Amplifiers application report](#)
- Texas Instruments, [Capacitive Load Drive Solution using an Isolation Resistor reference design](#)

11.3 ドキュメントの更新通知を受け取る方法

ドキュメントの更新についての通知を受け取るには、ti.com のデバイス製品フォルダを開いてください。「更新の通知を受け取る」をクリックして登録すると、変更されたすべての製品情報に関するダイジェストを毎週受け取れます。変更の詳細については、修正されたドキュメントに含まれている改訂履歴をご覧ください。

11.4 サポート・リソース

TI E2E™ サポート・フォーラムは、エンジニアが検証済みの回答と設計に関するヒントをエキスパートから迅速かつ直接得ることができる場所です。既存の回答を検索したり、独自の質問をしたりすることで、設計に必要な支援を迅速に得ることができます。

リンクされているコンテンツは、該当する貢献者により、現状のまま提供されるものです。これらは TI の仕様を構成するものではなく、必ずしも TI の見解を反映したものではありません。TI の[使用条件](#)を参照してください。

11.5 Trademarks

e-trim™, TINA-TI™, and TI E2E™ are trademarks of Texas Instruments.
TINA™ and DesignSoft™ are trademarks of DesignSoft, Inc.
Bluetooth® is a registered trademark of Bluetooth SIG, Inc.
すべての商標は、それぞれの所有者に帰属します。

11.6 静電気放電に関する注意事項



この IC は、ESD によって破損する可能性があります。テキサス・インスツルメンツは、IC を取り扱う際には常に適切な注意を払うことを推奨します。正しい ESD 対策をとらないと、デバイスを破損するおそれがあります。

ESD による破損は、わずかな性能低下からデバイスの完全な故障まで多岐にわたります。精密な IC の場合、パラメータがわずかに変化するだけで公表されている仕様から外れる可能性があるため、破損が発生しやすくなっています。

11.7 用語集

TI 用語集 この用語集には、用語や略語の一覧および定義が記載されています。

12 Mechanical, Packaging, and Orderable Information

The following pages include mechanical, packaging, and orderable information. This information is the most current data available for the designated devices. This data is subject to change without notice and revision of this document. For browser-based versions of this data sheet, refer to the left-hand navigation.

PACKAGING INFORMATION

Orderable Device	Status (1)	Package Type	Package Drawing	Pins	Package Qty	Eco Plan (2)	Lead finish/ Ball material (6)	MSL Peak Temp (3)	Op Temp (°C)	Device Marking (4/5)	Samples
OPA197QDGKRQ1	ACTIVE	VSSOP	DGK	8	2500	RoHS & Green	NIPDAUAG	Level-2-260C-1 YEAR	-40 to 125	197	Samples
OPA2197QDGKRQ1	ACTIVE	VSSOP	DGK	8	2500	RoHS & Green	NIPDAUAG	Level-2-260C-1 YEAR	-40 to 125	2197	Samples
OPA4197QPWRQ1	ACTIVE	TSSOP	PW	14	2000	RoHS & Green	NIPDAU	Level-3-260C-168 HR	-40 to 125	O4197Q	Samples

(1) The marketing status values are defined as follows:

ACTIVE: Product device recommended for new designs.

LIFEBUY: TI has announced that the device will be discontinued, and a lifetime-buy period is in effect.

NRND: Not recommended for new designs. Device is in production to support existing customers, but TI does not recommend using this part in a new design.

PREVIEW: Device has been announced but is not in production. Samples may or may not be available.

OBSOLETE: TI has discontinued the production of the device.

(2) **RoHS:** TI defines "RoHS" to mean semiconductor products that are compliant with the current EU RoHS requirements for all 10 RoHS substances, including the requirement that RoHS substance do not exceed 0.1% by weight in homogeneous materials. Where designed to be soldered at high temperatures, "RoHS" products are suitable for use in specified lead-free processes. TI may reference these types of products as "Pb-Free".

RoHS Exempt: TI defines "RoHS Exempt" to mean products that contain lead but are compliant with EU RoHS pursuant to a specific EU RoHS exemption.

Green: TI defines "Green" to mean the content of Chlorine (Cl) and Bromine (Br) based flame retardants meet JS709B low halogen requirements of <=1000ppm threshold. Antimony trioxide based flame retardants must also meet the <=1000ppm threshold requirement.

(3) MSL, Peak Temp. - The Moisture Sensitivity Level rating according to the JEDEC industry standard classifications, and peak solder temperature.

(4) There may be additional marking, which relates to the logo, the lot trace code information, or the environmental category on the device.

(5) Multiple Device Markings will be inside parentheses. Only one Device Marking contained in parentheses and separated by a "~" will appear on a device. If a line is indented then it is a continuation of the previous line and the two combined represent the entire Device Marking for that device.

(6) Lead finish/Ball material - Orderable Devices may have multiple material finish options. Finish options are separated by a vertical ruled line. Lead finish/Ball material values may wrap to two lines if the finish value exceeds the maximum column width.

Important Information and Disclaimer:The information provided on this page represents TI's knowledge and belief as of the date that it is provided. TI bases its knowledge and belief on information provided by third parties, and makes no representation or warranty as to the accuracy of such information. Efforts are underway to better integrate information from third parties. TI has taken and continues to take reasonable steps to provide representative and accurate information but may not have conducted destructive testing or chemical analysis on incoming materials and chemicals. TI and TI suppliers consider certain information to be proprietary, and thus CAS numbers and other limited information may not be available for release.

In no event shall TI's liability arising out of such information exceed the total purchase price of the TI part(s) at issue in this document sold by TI to Customer on an annual basis.

OTHER QUALIFIED VERSIONS OF OPA197-Q1, OPA2197-Q1, OPA4197-Q1 :

- Catalog : [OPA197](#), [OPA2197](#), [OPA4197](#)

NOTE: Qualified Version Definitions:

- Catalog - TI's standard catalog product

TAPE AND REEL INFORMATION

QUADRANT ASSIGNMENTS FOR PIN 1 ORIENTATION IN TAPE

*All dimensions are nominal

Device	Package Type	Package Drawing	Pins	SPQ	Reel Diameter (mm)	Reel Width W1 (mm)	A0 (mm)	B0 (mm)	K0 (mm)	P1 (mm)	W (mm)	Pin1 Quadrant
OPA197QDGKRQ1	VSSOP	DGK	8	2500	330.0	12.4	5.3	3.4	1.4	8.0	12.0	Q1
OPA2197QDGKRQ1	VSSOP	DGK	8	2500	330.0	12.4	5.3	3.4	1.4	8.0	12.0	Q1
OPA4197QPWRQ1	TSSOP	PW	14	2000	330.0	12.4	6.9	5.6	1.6	8.0	12.0	Q1

TAPE AND REEL BOX DIMENSIONS

*All dimensions are nominal

Device	Package Type	Package Drawing	Pins	SPQ	Length (mm)	Width (mm)	Height (mm)
OPA197QDGKRQ1	VSSOP	DGK	8	2500	366.0	364.0	50.0
OPA2197QDGKRQ1	VSSOP	DGK	8	2500	366.0	364.0	50.0
OPA4197QPWRQ1	TSSOP	PW	14	2000	356.0	356.0	35.0

DGK0008A



PACKAGE OUTLINE

VSSOP - 1.1 mm max height

SMALL OUTLINE PACKAGE



4214862/A 04/2023

NOTES:

PowerPAD is a trademark of Texas Instruments.

1. All linear dimensions are in millimeters. Any dimensions in parenthesis are for reference only. Dimensioning and tolerancing per ASME Y14.5M.
2. This drawing is subject to change without notice.
3. This dimension does not include mold flash, protrusions, or gate burrs. Mold flash, protrusions, or gate burrs shall not exceed 0.15 mm per side.
4. This dimension does not include interlead flash. Interlead flash shall not exceed 0.25 mm per side.
5. Reference JEDEC registration MO-187.

EXAMPLE BOARD LAYOUT

DGK0008A

™ VSSOP - 1.1 mm max height

SMALL OUTLINE PACKAGE

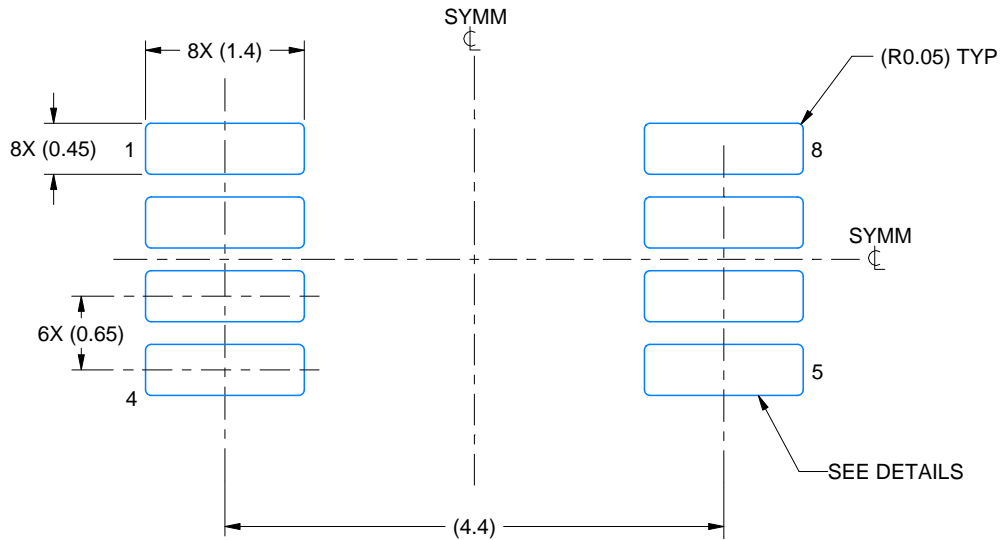

LAND PATTERN EXAMPLE
EXPOSED METAL SHOWN
SCALE: 15X

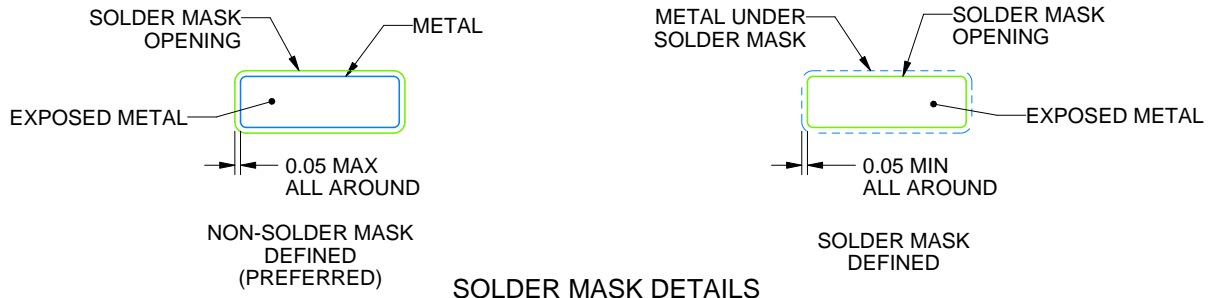

SOLDER MASK DETAILS

4214862/A 04/2023

NOTES: (continued)

6. Publication IPC-7351 may have alternate designs.
7. Solder mask tolerances between and around signal pads can vary based on board fabrication site.
8. Vias are optional depending on application, refer to device data sheet. If any vias are implemented, refer to their locations shown on this view. It is recommended that vias under paste be filled, plugged or tented.
9. Size of metal pad may vary due to creepage requirement.

EXAMPLE STENCIL DESIGN

DGK0008A

TM VSSOP - 1.1 mm max height

SMALL OUTLINE PACKAGE



SOLDER PASTE EXAMPLE
SCALE: 15X

4214862/A 04/2023

NOTES: (continued)

11. Laser cutting apertures with trapezoidal walls and rounded corners may offer better paste release. IPC-7525 may have alternate design recommendations.
12. Board assembly site may have different recommendations for stencil design.

重要なお知らせと免責事項

TI は、技術データと信頼性データ (データシートを含みます)、設計リソース (リファレンス・デザインを含みます)、アプリケーションや設計に関する各種アドバイス、Web ツール、安全性情報、その他のリソースを、欠陥が存在する可能性のある「現状のまま」提供しており、商品性および特定目的に対する適合性の黙示保証、第三者の知的財産権の非侵害保証を含むいかなる保証も、明示的または黙示的にかかわらず拒否します。

これらのリソースは、TI 製品を使用する設計の経験を積んだ開発者への提供を意図したものです。(1) お客様のアプリケーションに適した TI 製品の選定、(2) お客様のアプリケーションの設計、検証、試験、(3) お客様のアプリケーションに該当する各種規格や、その他のあらゆる安全性、セキュリティ、規制、または他の要件への確実な適合に関する責任を、お客様のみが単独で負うものとし、

上記の各種リソースは、予告なく変更される可能性があります。これらのリソースは、リソースで説明されている TI 製品を使用するアプリケーションの開発の目的でのみ、TI はその使用をお客様に許諾します。これらのリソースに関して、他の目的で複製することや掲載することは禁止されています。TI や第三者の知的財産権のライセンスが付与されている訳ではありません。お客様は、これらのリソースを自身で使用した結果発生するあらゆる申し立て、損害、費用、損失、責任について、TI およびその代理人を完全に補償するものとし、TI は一切の責任を拒否します。

TI の製品は、[TI の販売条件](#)、または [ti.com](#) やかかる TI 製品の関連資料などのいずれかを通じて提供する適用可能な条項の下で提供されています。TI がこれらのリソースを提供することは、適用される TI の保証または他の保証の放棄の拡大や変更を意味するものではありません。

お客様がいかなる追加条項または代替条項を提案した場合でも、TI はそれらに異議を唱え、拒否します。

郵送先住所 : Texas Instruments, Post Office Box 655303, Dallas, Texas 75265
Copyright © 2024, Texas Instruments Incorporated