

TMS320F2833x/2823x Multichannel Buffered Serial Port (McBSP)

Reference Guide



Literature Number: SPRUFB7B
September 2007–Revised August 2011

Preface	13
1 Overview	15
1.1 Brief Description	16
1.2 Features of the McBSPs	16
1.3 McBSP Pins/Signals	17
1.3.1 McBSP Generic Block Diagram	18
2 McBSP Operation	19
2.1 Data Transfer Process of McBSPs	20
2.1.1 Data Transfer Process for Word Length of 8, 12, or 16 Bits	20
2.1.2 Data Transfer Process for Word Length of 20, 24, or 32 Bits	20
2.2 Companding (Compressing and Expanding) Data	20
2.2.1 Companding Formats	21
2.2.2 Capability to Compand Internal Data	21
2.2.3 Reversing Bit Order: Option to Transfer LSB First	22
2.3 Clocking and Framing Data	22
2.3.1 Clocking	22
2.3.2 Serial Words	22
2.3.3 Frames and Frame Synchronization	23
2.3.4 Generating Transmit and Receive Interrupts	23
2.3.5 Ignoring Frame-Synchronization Pulses	23
2.3.6 Frame Frequency	24
2.3.7 Maximum Frame Frequency	24
2.4 Frame Phases	24
2.4.1 Number of Phases, Words, and Bits Per Frame	25
2.4.2 Single-Phase Frame Example	25
2.4.3 Dual-Phase Frame Example	25
2.4.4 Implementing the AC97 Standard With a Dual-Phase Frame	26
2.5 McBSP Reception	26
2.6 McBSP Transmission	29
2.7 Interrupts and DMA Events Generated by a McBSP	30
3 McBSP Sample Rate Generator	31
3.1 Block Diagram	32
3.1.1 Clock Generation in the Sample Rate Generator	33
3.1.2 Choosing an Input Clock	33
3.1.3 Choosing a Polarity for the Input Clock	33
3.1.4 Choosing a Frequency for the Output Clock (CLKG)	34
3.1.5 Keeping CLKG Synchronized to External MCLKR	34
3.2 Frame Synchronization Generation in the Sample Rate Generator	35
3.2.1 Choosing the Width of the Frame-Synchronization Pulse on FSG	35
3.2.2 Controlling the Period Between the Starting Edges of Frame-Synchronization Pulses on FSG	35
3.2.3 Keeping FSG Synchronized to an External Clock	35
3.3 Synchronizing Sample Rate Generator Outputs to an External Clock	35
3.3.1 Operating the Transmitter Synchronously with the Receiver	36
3.3.2 Synchronization Examples	36
3.4 Reset and Initialization Procedure for the Sample Rate Generator	37

4	McBSP Exception/Error Conditions	39
4.1	Types of Errors	40
4.2	Overrun in the Receiver	40
4.2.1	Example of Overrun Condition	41
4.2.2	Example of Preventing Overrun Condition	41
4.3	Unexpected Receive Frame-Synchronization Pulse	41
4.3.1	Possible Responses to Receive Frame-Synchronization Pulses	41
4.3.2	Example of Unexpected Receive Frame-Synchronization Pulse	43
4.3.3	Preventing Unexpected Receive Frame-Synchronization Pulses	43
4.4	Overwrite in the Transmitter	44
4.4.1	Example of Overwrite Condition	44
4.4.2	Preventing Overwrites	44
4.5	Underflow in the Transmitter	44
4.5.1	Example of the Underflow Condition	45
4.5.2	Example of Preventing Underflow Condition	45
4.6	Unexpected Transmit Frame-Synchronization Pulse	45
4.6.1	Possible Responses to Transmit Frame-Synchronization Pulses	45
4.6.2	Example of Unexpected Transmit Frame-Synchronization Pulse	47
4.6.3	Preventing Unexpected Transmit Frame-Synchronization Pulses	47
5	Multichannel Selection Modes	49
5.1	Channels, Blocks, and Partitions	50
5.2	Multichannel Selection	51
5.3	Configuring a Frame for Multichannel Selection	51
5.4	Using Two Partitions	51
5.4.1	Assigning Blocks to Partitions A and B	51
5.4.2	Reassigning Blocks During Reception/Transmission	52
5.5	Using Eight Partitions	53
5.6	Receive Multichannel Selection Mode	54
5.7	Transmit Multichannel Selection Modes	54
5.7.1	Disabling/Enabling Versus Masking/Unmasking	55
5.7.2	Activity on McBSP Pins for Different Values of XMCM	55
5.8	Using Interrupts Between Block Transfers	56
6	SPI Operation Using the Clock Stop Mode	59
6.1	SPI Protocol	60
6.2	Clock Stop Mode	60
6.3	Bits Used to Enable and Configure the Clock Stop Mode	60
6.4	Clock Stop Mode Timing Diagrams	61
6.5	Procedure for Configuring a McBSP for SPI Operation	63
6.6	McBSP as the SPI Master	63
6.7	McBSP as an SPI Slave	65
7	Receiver Configuration	67
7.1	Programming the McBSP Registers for the Desired Receiver Operation	68
7.2	Resetting and Enabling the Receiver	68
7.2.1	Reset Considerations	69
7.3	Set the Receiver Pins to Operate as McBSP Pins	69
7.4	Enable/Disable the Digital Loopback Mode	69
7.4.1	Digital Loopback Mode	70
7.5	Enable/Disable the Clock Stop Mode	70
7.5.1	Clock Stop Mode	70
7.6	Enable/Disable the Receive Multichannel Selection Mode	71
7.7	Choose One or Two Phases for the Receive Frame	71
7.8	Set the Receive Word Length(s)	72

7.8.1	Word Length Bits	72
7.9	Set the Receive Frame Length	72
7.9.1	Selected Frame Length	73
7.10	Enable/Disable the Receive Frame-Synchronization Ignore Function	73
7.10.1	Unexpected Frame-Synchronization Pulses and the Frame-Synchronization Ignore Function	73
7.10.2	Examples of Effects of RFIG	74
7.11	Set the Receive Companding Mode	74
7.11.1	Companding	75
7.11.2	Format of Expanded Data	75
7.11.3	Companding Internal Data	75
7.11.4	Option to Receive LSB First	75
7.12	Set the Receive Data Delay	75
7.12.1	Data Delay	76
7.12.2	0-Bit Data Delay	76
7.12.3	2-Bit Data Delay	76
7.13	Set the Receive Sign-Extension and Justification Mode	77
7.13.1	Sign-Extension and the Justification	77
7.14	Set the Receive Interrupt Mode	79
7.15	Set the Receive Frame-Synchronization Mode	79
7.15.1	Receive Frame-Synchronization Modes	79
7.16	Set the Receive Frame-Synchronization Polarity	81
7.16.1	Frame-Synchronization Pulses, Clock Signals, and Their Polarities	81
7.16.2	Frame-Synchronization Period and the Frame-Synchronization Pulse Width	82
7.17	Set the Receive Clock Mode	83
7.17.1	Selecting a Source for the Receive Clock and a Data Direction for the MCLKR Pin	84
7.18	Set the Receive Clock Polarity	84
7.18.1	Frame Synchronization Pulses, Clock Signals, and Their Polarities	85
7.19	Set the SRG Clock Divide-Down Value	85
7.19.1	Sample Rate Generator Clock Divider	86
7.20	Set the SRG Clock Synchronization Mode	86
7.21	Set the SRG Clock Mode (Choose an Input Clock)	86
7.21.1	SRG Clock Mode	87
7.22	Set the SRG Input Clock Polarity	88
7.22.1	Using CLKXP/CLKRP to Choose an Input Clock Polarity	88
8	Transmitter Configuration	89
8.1	Programming the McBSP Registers for the Desired Transmitter Operation	90
8.2	Resetting and Enabling the Transmitter	90
8.2.1	Reset Considerations	91
8.3	Set the Transmitter Pins to Operate as McBSP Pins	91
8.4	Enable/Disable the Digital Loopback Mode	91
8.4.1	Digital Loopback Mode	91
8.5	Enable/Disable the Clock Stop Mode	92
8.5.1	Clock Stop Mode	92
8.6	Enable/Disable Transmit Multichannel Selection	93
8.7	Choose One or Two Phases for the Transmit Frame	94
8.8	Set the Transmit Word Length(s)	94
8.8.1	Word Length Bits	94
8.9	Set the Transmit Frame Length	95
8.9.1	Selected Frame Length	95
8.10	Enable/Disable the Transmit Frame-Synchronization Ignore Function	96
8.10.1	Unexpected Frame-Synchronization Pulses and Frame-Synchronization Ignore	96
8.10.2	Examples Showing the Effects of XFIG	96
8.11	Set the Transmit Companding Mode	97

8.11.1	Companding	97
8.11.2	Format for Data To Be Compressed	97
8.11.3	Capability to Compand Internal Data	98
8.11.4	Option to Transmit LSB First	98
8.12	Set the Transmit Data Delay	98
8.12.1	Data Delay	98
8.12.2	0-Bit Data Delay	99
8.12.3	2-Bit Data Delay	99
8.13	Set the Transmit DXENA Mode	100
8.13.1	DXENA Mode	100
8.14	Set the Transmit Interrupt Mode	100
8.15	Set the Transmit Frame-Synchronization Mode	101
8.15.1	Transmit Frame-Synchronization Modes	101
8.15.2	Other Considerations	101
8.16	Set the Transmit Frame-Synchronization Polarity	102
8.16.1	Frame Synchronization Pulses, Clock Signals, and Their Polarities	102
8.17	Set the SRG Frame-Synchronization Period and Pulse Width	103
8.17.1	Frame-Synchronization Period and Frame-Synchronization Pulse Width	103
8.18	Set the Transmit Clock Mode	104
8.18.1	Selecting a Source for the Transmit Clock and a Data Direction for the MCLKX pin	104
8.18.2	Other Considerations	104
8.19	Set the Transmit Clock Polarity	104
8.19.1	Frame Synchronization Pulses, Clock Signals, and Their Polarities	105
9	Emulation and Reset Considerations	107
9.1	McBSP Emulation Mode	108
9.2	Resetting and Initializing McBSPs	108
9.2.1	McBSP Pin States: DSP Reset Versus Receiver/Transmitter Reset	108
9.2.2	Device Reset, McBSP Reset, and Sample Rate Generator Reset	108
9.2.3	McBSP Initialization Procedure	109
9.2.4	Resetting the Transmitter While the Receiver is Running	110
10	Data Packing Examples	111
10.1	Data Packing Using Frame Length and Word Length	112
10.2	Data Packing Using Word Length and the Frame-Synchronization Ignore Function	113
11	McBSP Registers	115
11.1	Register Summary	116
11.2	Data Receive Registers (DRR[1,2])	116
11.2.1	Data Travel From Data Receive Pins to the Registers	117
11.3	Data Transmit Registers (DXR[1,2])	118
11.3.1	Data Travel From Registers to Data Transmit (DX) Pins	118
11.4	Serial Port Control Registers (SPCR[1,2])	118
11.4.1	Serial Port Control 1 Register (SPCR1)	118
11.4.2	Serial Port Control 2 Register (SPCR2)	121
11.5	Receive Control Registers (RCR[1, 2])	123
11.5.1	Receive Control Register 1 (RCR1)	123
11.5.2	Receive Control Register 2 (RCR2)	124
11.6	Transmit Control Registers (XCR1 and XCR2)	125
11.6.1	Transmit Control 1 Register (XCR1)	126
11.6.2	Transmit Control 2 Register (XCR2)	127
11.7	Sample Rate Generator Registers (SRGR1 and SRGR2)	128
11.7.1	Sample Rate Generator 1 Register (SRGR1)	128
11.7.2	Sample Rate Generator 2 Register (SRGR2)	129
11.8	Multichannel Control Registers (MCR[1,2])	131
11.8.1	Multichannel Control 1 Register (MCR1)	131

11.8.2	Multichannel Control 2 Register (MCR2)	133
11.9	Pin Control Register (PCR)	135
11.10	Receive Channel Enable Registers (RCERA, RCERB, RCERC, RCERD, RCERE, RCERF, RCERG, RCERH)	137
11.10.1	RCERs Used in the Receive Multichannel Selection Mode	138
11.11	Transmit Channel Enable Registers (XCERA, XCERB, XCERC, XCERD, XCERE, XCERF, XCERG, XCERH)	139
11.11.1	XCERs Used in a Transmit Multichannel Selection Mode	140
11.12	Interrupt Generation	141
11.12.1	McBSP Receive Interrupt Generation	142
11.12.2	McBSP Transmit Interrupt Generation	142
11.12.3	Error Flags	143
11.12.4	McBSP Interrupt Enable Register	143
11.13	McBSP Modes	143
A	Revision History	145

List of Figures

1-1.	Conceptual Block Diagram of the McBSP	18
2-1.	McBSP Data Transfer Paths	20
2-2.	Companding Processes	21
2-3.	μ -Law Transmit Data Companding Format	21
2-4.	A-Law Transmit Data Companding Format	21
2-5.	Two Methods by Which the McBSP Can Compand Internal Data	22
2-6.	Example - Clock Signal Control of Bit Transfer Timing.....	22
2-7.	McBSP Operating at Maximum Packet Frequency	24
2-8.	Single-Phase Frame for a McBSP Data Transfer	25
2-9.	Dual-Phase Frame for a McBSP Data Transfer	25
2-10.	Implementing the AC97 Standard With a Dual-Phase Frame	26
2-11.	Timing of an AC97-Standard Data Transfer Near Frame Synchronization	26
2-12.	McBSP Reception Physical Data Path	27
2-13.	McBSP Reception Signal Activity	27
2-14.	McBSP Transmission Physical Data Path	29
2-15.	McBSP Transmission Signal Activity	29
3-1.	Conceptual Block Diagram of the Sample Rate Generator	32
3-2.	Possible Inputs to the Sample Rate Generator and the Polarity Bits.....	34
3-3.	CLKG Synchronization and FSG Generation When GSYNC = 1 and CLKGDV = 1	36
3-4.	CLKG Synchronization and FSG Generation When GSYNC = 1 and CLKGDV = 3	37
4-1.	Overrun in the McBSP Receiver	41
4-2.	Overrun Prevented in the McBSP Receiver	41
4-3.	Possible Responses to Receive Frame-Synchronization Pulses	42
4-4.	An Unexpected Frame-Synchronization Pulse During a McBSP Reception	43
4-5.	Proper Positioning of Frame-Synchronization Pulses	43
4-6.	Data in the McBSP Transmitter Overwritten and Thus Not Transmitted.....	44
4-7.	Underflow During McBSP Transmission	45
4-8.	Underflow Prevented in the McBSP Transmitter	45
4-9.	Possible Responses to Transmit Frame-Synchronization Pulses	46
4-10.	An Unexpected Frame-Synchronization Pulse During a McBSP Transmission	47
4-11.	Proper Positioning of Frame-Synchronization Pulses	47
5-1.	Alternating Between the Channels of Partition A and the Channels of Partition B	52
5-2.	Reassigning Channel Blocks Throughout a McBSP Data Transfer	53
5-3.	McBSP Data Transfer in the 8-Partition Mode	54
5-4.	Activity on McBSP Pins for the Possible Values of XMCM	57
6-1.	Typical SPI Interface	60
6-2.	SPI Transfer With CLKSTP = 10b (No Clock Delay), CLKXP = 0, and CLKRP = 0.....	62
6-3.	SPI Transfer With CLKSTP = 11b (Clock Delay), CLKXP = 0, CLKRP = 1	62
6-4.	SPI Transfer With CLKSTP = 10b (No Clock Delay), CLKXP = 1, and CLKRP = 0.....	62
6-5.	SPI Transfer With CLKSTP = 11b (Clock Delay), CLKXP = 1, CLKRP = 1	62
6-6.	SPI Interface with McBSP Used as Master	64
6-7.	SPI Interface With McBSP Used as Slave	65
7-1.	Unexpected Frame-Synchronization Pulse With (R/X)FIG = 0	74
7-2.	Unexpected Frame-Synchronization Pulse With (R/X)FIG = 1	74
7-3.	Companding Processes for Reception and for Transmission	75
7-4.	Range of Programmable Data Delay	76
7-5.	2-Bit Data Delay Used to Skip a Framing Bit	77

7-6.	Data Clocked Externally Using a Rising Edge and Sampled by the McBSP Receiver on a Falling Edge	82
7-7.	Frame of Period 16 CLKG Periods and Active Width of 2 CLKG Periods	83
7-8.	Data Clocked Externally Using a Rising Edge and Sampled by the McBSP Receiver on a Falling Edge	85
8-1.	Unexpected Frame-Synchronization Pulse With (R/X) FIG = 0	96
8-2.	Unexpected Frame-Synchronization Pulse With (R/X) FIG = 1	96
8-3.	Companding Processes for Reception and for Transmission	97
8-4.	μ -Law Transmit Data Companding Format	97
8-5.	A-Law Transmit Data Companding Format	98
8-6.	Range of Programmable Data Delay	99
8-7.	2-Bit Data Delay Used to Skip a Framing Bit	99
8-8.	Data Clocked Externally Using a Rising Edge and Sampled by the McBSP Receiver on a Falling Edge ...	103
8-9.	Frame of Period 16 CLKG Periods and Active Width of 2 CLKG Periods	103
8-10.	Data Clocked Externally Using a Rising Edge and Sampled by the McBSP Receiver on a Falling Edge ...	105
10-1.	Four 8-Bit Data Words Transferred To/From the McBSP	112
10-2.	One 32-Bit Data Word Transferred To/From the McBSP	113
10-3.	8-Bit Data Words Transferred at Maximum Packet Frequency	113
10-4.	Configuring the Data Stream of as a Continuous 32-Bit Word	114
11-1.	Data Receive Registers (DRR2 and DRR1)	117
11-2.	Data Transmit Registers (DXR2 and DXR1)	118
11-3.	Serial Port Control 1 Register (SPCR1)	118
11-4.	Serial Port Control 2 Register (SPCR2)	121
11-5.	Receive Control Register 1 (RCR1)	123
11-6.	Receive Control Register 2 (RCR2)	124
11-7.	Transmit Control 1 Register (XCR1)	126
11-8.	Transmit Control 2 Register (XCR2)	127
11-9.	Sample Rate Generator 1 Register (SRGR1)	129
11-10.	Sample Rate Generator 2 Register (SRGR2)	129
11-11.	Multichannel Control 1 Register (MCR1)	131
11-12.	Multichannel Control 2 Register (MCR2)	133
11-13.	Pin Control Register (PCR)	135
11-14.	Receive Channel Enable Registers (RCERA...RCERH)	137
11-15.	Transmit Channel Enable Registers (XCERA...XCERH)	139
11-16.	Receive Interrupt Generation	142
11-17.	Transmit Interrupt Generation	142
11-18.	McBSP Interrupt Enable Register (MFFINT)	143

List of Tables

1-1.	McBSP Interface Pins/Signals	17
2-1.	Register Bits That Determine the Number of Phases, Words, and Bits.....	25
2-2.	Interrupts and DMA Events Generated by a McBSP	30
3-1.	Effects of DLB and CLKSTP on Clock Modes.....	33
3-2.	Choosing an Input Clock for the Sample Rate Generator with the SCLKME and CLKSM Bits.....	33
3-3.	Polarity Options for the Input to the Sample Rate Generator	34
3-4.	Input Clock Selection for Sample Rate Generator	37
5-1.	Block - Channel Assignment.....	50
5-2.	2-Partition Mode	50
5-3.	8-Partition mode	50
5-4.	Receive Channel Assignment and Control With Eight Receive Partitions.....	53
5-5.	Transmit Channel Assignment and Control When Eight Transmit Partitions Are Used.....	54
5-6.	Selecting a Transmit Multichannel Selection Mode With the XMCM Bits.....	55
6-1.	Bits Used to Enable and Configure the Clock Stop Mode	61
6-2.	Effects of CLKSTP, CLKXP, and CLKRP on the Clock Scheme	61
6-3.	Bit Values Required to Configure the McBSP as an SPI Master	64
6-4.	Bit Values Required to Configure the McBSP as an SPI Slave	65
7-1.	Register Bits Used to Reset or Enable the McBSP Receiver Field Descriptions	68
7-2.	Reset State of Each McBSP Pin	69
7-3.	Register Bit Used to Enable/Disable the Digital Loopback Mode	69
7-4.	Receive Signals Connected to Transmit Signals in Digital Loopback Mode	70
7-5.	Register Bits Used to Enable/Disable the Clock Stop Mode	70
7-6.	Effects of CLKSTP, CLKXP, and CLKRP on the Clock Scheme	71
7-7.	Register Bit Used to Enable/Disable the Receive Multichannel Selection Mode	71
7-8.	Register Bit Used to Choose One or Two Phases for the Receive Frame	71
7-9.	Register Bits Used to Set the Receive Word Length(s).....	72
7-10.	Register Bits Used to Set the Receive Frame Length.....	72
7-11.	How to Calculate the Length of the Receive Frame	73
7-12.	Register Bit Used to Enable/Disable the Receive Frame-Synchronization Ignore Function	73
7-13.	Register Bits Used to Set the Receive Companding Mode.....	74
7-14.	Register Bits Used to Set the Receive Data Delay	75
7-15.	Register Bits Used to Set the Receive Sign-Extension and Justification Mode.....	77
7-16.	Example: Use of RJUST Field With 12-Bit Data Value ABCh.....	77
7-17.	Example: Use of RJUST Field With 20-Bit Data Value ABCDEh.....	77
7-18.	Register Bits Used to Set the Receive Interrupt Mode	79
7-19.	Register Bits Used to Set the Receive Frame Synchronization Mode	79
7-20.	Select Sources to Provide the Receive Frame-Synchronization Signal and the Effect on the FSR Pin.....	80
7-21.	Register Bit Used to Set Receive Frame-Synchronization Polarity.....	81
7-22.	Register Bits Used to Set the SRG Frame-Synchronization Period and Pulse Width	82
7-23.	Register Bits Used to Set the Receive Clock Mode	83
7-24.	Receive Clock Signal Source Selection	84
7-25.	Register Bit Used to Set Receive Clock Polarity	84
7-26.	Register Bits Used to Set the Sample Rate Generator (SRG) Clock Divide-Down Value.....	86
7-27.	Register Bit Used to Set the SRG Clock Synchronization Mode.....	86
7-28.	Register Bits Used to Set the SRG Clock Mode (Choose an Input Clock)	86
7-29.	Register Bits Used to Set the SRG Input Clock Polarity	88
8-1.	Register Bits Used to Place Transmitter in Reset Field Descriptions	90

8-2.	Register Bit Used to Enable/Disable the Digital Loopback Mode	91
8-3.	Receive Signals Connected to Transmit Signals in Digital Loopback Mode	91
8-4.	Register Bits Used to Enable/Disable the Clock Stop Mode	92
8-5.	Effects of CLKSTP, CLKXP, and CLKRP on the Clock Scheme	92
8-6.	Register Bits Used to Enable/Disable Transmit Multichannel Selection	93
8-7.	Register Bit Used to Choose 1 or 2 Phases for the Transmit Frame.....	94
8-8.	Register Bits Used to Set the Transmit Word Length(s)	94
8-9.	Register Bits Used to Set the Transmit Frame Length	95
8-10.	How to Calculate Frame Length.....	95
8-11.	Register Bit Used to Enable/Disable the Transmit Frame-Synchronization Ignore Function.....	96
8-12.	Register Bits Used to Set the Transmit Companding Mode	97
8-13.	Register Bits Used to Set the Transmit Data Delay.....	98
8-14.	Register Bit Used to Set the Transmit DXENA (DX Delay Enabler) Mode.....	100
8-15.	Register Bits Used to Set the Transmit Interrupt Mode.....	100
8-16.	Register Bits Used to Set the Transmit Frame-Synchronization Mode	101
8-17.	How FSXM and FSGM Select the Source of Transmit Frame-Synchronization Pulses.....	101
8-18.	Register Bit Used to Set Transmit Frame-Synchronization Polarity.....	102
8-19.	Register Bits Used to Set SRG Frame-Synchronization Period and Pulse Width.....	103
8-20.	Register Bit Used to Set the Transmit Clock Mode	104
8-21.	How the CLKXM Bit Selects the Transmit Clock and the Corresponding Status of the MCLKX pin	104
8-22.	Register Bit Used to Set Transmit Clock Polarity	104
9-1.	McBSP Emulation Modes Selectable with FREE and SOFT Bits of SPCR2	108
9-2.	Reset State of Each McBSP Pin.....	108
11-1.	McBSP Register Summary	116
11-2.	Serial Port Control 1 Register (SPCR1) Field Descriptions	119
11-3.	Serial Port Control 2 Register (SPCR2) Field Descriptions	121
11-4.	Receive Control Register 1 (RCR1) Field Descriptions	123
11-5.	Frame Length Formula for Receive Control 1 Register (RCR1).....	124
11-6.	Receive Control Register 2 (RCR2) Field Descriptions.....	124
11-7.	Frame Length Formula for Receive Control 2 Register (RCR2).....	125
11-8.	Transmit Control 1 Register (XCR1) Field Descriptions	126
11-9.	Frame Length Formula for Transmit Control 1 Register (XCR1)	126
11-10.	Transmit Control 2 Register (XCR2) Field Descriptions	127
11-11.	Frame Length Formula for Transmit Control 2 Register (XCR2)	128
11-12.	Sample Rate Generator 1 Register (SRGR1) Field Descriptions	129
11-13.	Sample Rate Generator 2 Register (SRGR2) Field Descriptions	130
11-14.	Multichannel Control 1 Register (MCR1) Field Descriptions	131
11-15.	Multichannel Control 2 Register (MCR2) Field Descriptions	133
11-16.	Pin Control Register (PCR) Field Descriptions.....	135
11-17.	Pin Configuration	137
11-18.	Receive Channel Enable Registers (RCERA...RCERH) Field Descriptions	138
11-19.	Use of the Receive Channel Enable Registers	138
11-20.	Transmit Channel Enable Registers (XCERA...XCERH) Field Descriptions.....	140
11-21.	Use of the Transmit Channel Enable Registers	140
11-22.	Receive Interrupt Sources and Signals	142
11-23.	Transmit Interrupt Sources and Signals	142
11-24.	Error Flags	143
11-25.	McBSP Interrupt Enable Register (MFFINT) Field Descriptions.....	143
11-26.	McBSP Mode Selection	144

A-1. Changes in this Revision.....	145
------------------------------------	-----

Read This First

About This Manual

This document describes the multichannel buffered serial port (McBSP) of the 28x device. There are up to two McBSPs on the 2833x/2823x device.

Notational Conventions

This document uses the following conventions.

- Hexadecimal numbers are shown with the suffix h. For example, the following number is 40 hexadecimal (decimal 64): 40h.

Related Documentation From Texas Instruments

The following documents describe the 28xxx device and related peripherals. Copies of these documents are available by contacting your TI representative.

Data Manual and Errata—

SPRS439— [TMS320F28335](#), [TMS320F28334](#), [TMS320F28332](#), [TMS320F28235](#), [TMS320F28234](#), [TMS320F28232 Digital Signal Controllers \(DSCs\) Data Manual](#) contains the pinout, signal descriptions, as well as electrical and timing specifications for the F2833x/2823x devices.

SPRZ272— [TMS320F28335](#), [F28334](#), [F28332](#), [TMS320F28235](#), [F28234](#), [F28232 Digital Signal Controllers \(DSCs\) Silicon Errata](#) describes the advisories and usage notes for different versions of silicon.

CPU User's Guides—

SPRU430— **TMS320C28x CPU and Instruction Set Reference Guide** describes the central processing unit (CPU) and the assembly language instructions of the TMS320C28x fixed-point digital signal processors (DSPs). It also describes emulation features available on these DSPs.

SPRUE02— **TMS320C28x Floating Point Unit and Instruction Set Reference Guide** describes the floating-point unit and includes the instructions for the FPU.

Peripheral Guides—

SPRU566— **TMS320x28xx, 28xxx DSP Peripheral Reference Guide** describes the peripheral reference guides of the 28x digital signal processors (DSPs).

SPRUFB0— **TMS320x2833x, 2823x System Control and Interrupts Reference Guide** describes the various interrupts and system control features of the 2833x and 2823x digital signal controllers (DSCs).

SPRU812— **TMS320x2833x, 2823x Analog-to-Digital Converter (ADC) Reference Guide** describes how to configure and use the on-chip ADC module, which is a 12-bit pipelined ADC.

SPRU949— **TMS320x2833x, 2823x DSC External Interface (XINTF) Reference Guide** describes the XINTF, which is a nonmultiplexed asynchronous bus, as it is used on the 2833x and 2823x devices.

SPRU963— **TMS320x2833x, 2823x Boot ROM Reference Guide** describes the purpose and features of the bootloader (factory-programmed boot-loading software) and provides examples of code. It also describes other contents of the device on-chip boot ROM and identifies where all of the information is located within that memory.

- [SPRUFB7](#)** — **TMS320x2833x, 2823x Multichannel Buffered Serial Port (McBSP) Reference Guide** describes the McBSP available on the 2833x and 2823x devices. The McBSPs allow direct interface between a DSP and other devices in a system.
- [SPRUFB8](#)** — **TMS320x2833x, 2823x Direct Memory Access (DMA) Module Reference Guide** describes the DMA on the 2833x and 2823x devices.
- [SPRUG04](#)** — **TMS320x2833x, 2823x Enhanced Pulse Width Modulator (ePWM) Module Reference Guide** describes the main areas of the enhanced pulse width modulator that include digital motor control, switch mode power supply control, UPS (uninterruptible power supplies), and other forms of power conversion.
- [SPRUG02](#)** — **TMS320x2833x, 2823x High-Resolution Pulse Width Modulator (HRPWM) Reference Guide** describes the operation of the high-resolution extension to the pulse width modulator (HRPWM).
- [SPRUG4](#)** — **TMS320x2833x, 2823x Enhanced Capture (eCAP) Module Reference Guide** describes the enhanced capture module. It includes the module description and registers.
- [SPRUG05](#)** — **TMS320x2833x, 2823x Enhanced Quadrature Encoder Pulse (eQEP) Module Reference Guide** describes the eQEP module, which is used for interfacing with a linear or rotary incremental encoder to get position, direction, and speed information from a rotating machine in high-performance motion and position control systems. It includes the module description and registers.
- [SPRUEU1](#)** — **TMS320x2833x, 2823x Enhanced Controller Area Network (eCAN) Reference Guide** describes the eCAN that uses established protocol to communicate serially with other controllers in electrically noisy environments.
- [SPRUFZ5](#)** — **TMS320x2833x, 2823x Serial Communications Interface (SCI) Reference Guide** describes the SCI, which is a two-wire asynchronous serial port, commonly known as a UART. The SCI modules support digital communications between the CPU and other asynchronous peripherals that use the standard non-return-to-zero (NRZ) format.
- [SPRUEU3](#)** — **TMS320x2833x, 2823x DSC Serial Peripheral Interface (SPI) Reference Guide** describes the SPI - a high-speed synchronous serial input/output (I/O) port - that allows a serial bit stream of programmed length (one to sixteen bits) to be shifted into and out of the device at a programmed bit-transfer rate.
- [SPRUG03](#)** — **TMS320x2833x, 2823x Inter-Integrated Circuit (I2C) Module Reference Guide** describes the features and operation of the inter-integrated circuit (I2C) module.
- Tools Guides—**
- [SPRU513](#)** — **TMS320C28x Assembly Language Tools v5.0.0 User's Guide** describes the assembly language tools (assembler and other tools used to develop assembly language code), assembler directives, macros, common object file format, and symbolic debugging directives for the TMS320C28x device.
- [SPRU514](#)** — **TMS320C28x Optimizing C/C++ Compiler v5.0.0 User's Guide** describes the TMS320C28x™ C/C++ compiler. This compiler accepts ANSI standard C/C++ source code and produces TMS320 DSP assembly language source code for the TMS320C28x device.
- [SPRU608](#)** — **TMS320C28x Instruction Set Simulator Technical Overview** describes the simulator, available within the Code Composer Studio for TMS320C2000 IDE, that simulates the instruction set of the C28x™ core.
- [SPRU625](#)** — **TMS320C28x DSP/BIOS 5.32 Application Programming Interface (API) Reference Guide** describes development using DSP/BIOS.

Overview

This document describes the multichannel buffered serial port (McBSP) of the 2833x/2823x device.

Topic	Page
1.1 Brief Description	16
1.2 Features of the McBSPs	16
1.3 McBSP Pins/Signals	17

1.1 Brief Description

This device provides up to two high-speed multichannel buffered serial ports (McBSPs) that allow direct interface to codecs and other devices in a system. The McBSP consists of a data-flow path and a control path connected to external devices by six pins as shown in [Figure 1-1](#).

Data is communicated to devices interfaced with the McBSP via the data transmit (DX) pin for transmission and via the data receive (DR) pin for reception. Control information in the form of clocking and frame synchronization is communicated via the following pins: CLKX (transmit clock), CLKR (receive clock), FSX (transmit frame synchronization), and FSR (receive frame synchronization).

The CPU and the DMA controller communicate with the McBSP through 16-bit-wide registers accessible via the internal peripheral bus. The CPU or the DMA controller writes the data to be transmitted to the data transmit registers (DXR1, DXR2). Data written to the DXRs is shifted out to DX via the transmit shift registers (XSR1, XSR2). Similarly, receive data on the DR pin is shifted into the receive shift registers (RSR1, RSR2) and copied into the receive buffer registers (RBR1, RBR2). The contents of the RBRs is then copied to the DRRs, which can be read by the CPU or the DMA controller. This allows simultaneous movement of internal and external data communications.

DRR2, RBR2, RSR2, DXR2, and XSR2 are not used (written, read, or shifted) if the serial word length is 8 bits, 12 bits, or 16 bits. For larger word lengths, these registers are needed to hold the most significant bits.

The frame and clock loop-back is implemented at chip level to enable CLKX and FSX to drive CLKR and FSR. If the loop-back is enabled, the CLKR and FSR get their signals from the CLKX and FSX pads; instead of the CLKR and FSR pins.

1.2 Features of the McBSPs

The McBSPs feature:

- Full-duplex communication
- Double-buffered transmission and triple-buffered reception, allowing a continuous data stream
- Independent clocking and framing for reception and transmission
- The capability to send interrupts to the CPU and to send DMA events to the DMA controller
- 128 channels for transmission and reception
- Multichannel selection modes that enable or disable block transfers in each of the channels
- Direct interface to industry-standard codecs, analog interface chips (AICs), and other serially connected A/D and D/A devices
- Support for external generation of clock signals and frame-synchronization signals
- A programmable sample rate generator for internal generation and control of clock signals and frame-synchronization signals
- Programmable polarity for frame-synchronization pulses and clock signals
- Direct interface to:
 - T1/E1 framers
 - IOM-2 compliant devices
 - AC97-compliant devices (the necessary multiphase frame capability is provided)
 - I2S compliant devices
 - SPI devices
- A wide selection of data sizes: 8, 12, 16, 20, 24, and 32 bits

NOTE: A value of the chosen data size is referred to as a *serial word* or *word* throughout the McBSP documentation. Elsewhere, *word* is used to describe a 16-bit value.

- μ -law and A-law companding
- The option of transmitting/receiving 8-bit data with the LSB first
- Status bits for flagging exception/error conditions

- ABIS mode is not supported.

1.3 McBSP Pins/Signals

Table 1-1 describes the McBSP interface pins and some internal signals.

Table 1-1. McBSP Interface Pins/Signals

McBSP-A Pin	McBSP-B Pin	Type	Description
MCLKRA	MCLKRB	I/O	Supplying or reflecting the receive clock; supplying the input clock of the sample rate generator
MCLKXA	MCLKXB	I/O	Supplying or reflecting the transmit clock; supplying the input clock of the sample rate generator
MDRA	MDRB	I	Serial data receive pin
MDXA	MDXB	O	Serial data transmit pin
MFSRA	MFSRB	I/O	Supplying or reflecting the receive frame-sync signal; controlling sample rate generator synchronization for the case when GSYNC = 1 (see Section 3.3)
MFSXA	MFSXB	I/O	Supplying or reflecting the transmit frame-sync signal
CPU Interrupt Signals			
MRINT			Receive interrupt to CPU
MXINT			Transmit interrupt to CPU
DMA Events			
REVT			Receive synchronization event to DMA
XEVT			Transmit synchronization event to DMA

1.3.1 McBSP Generic Block Diagram

The McBSP consists of a data-flow path and a control path connected to external devices by six pins as shown in Figure 1-1. The figure and the text in this section use generic pin names.

Figure 1-1. Conceptual Block Diagram of the McBSP

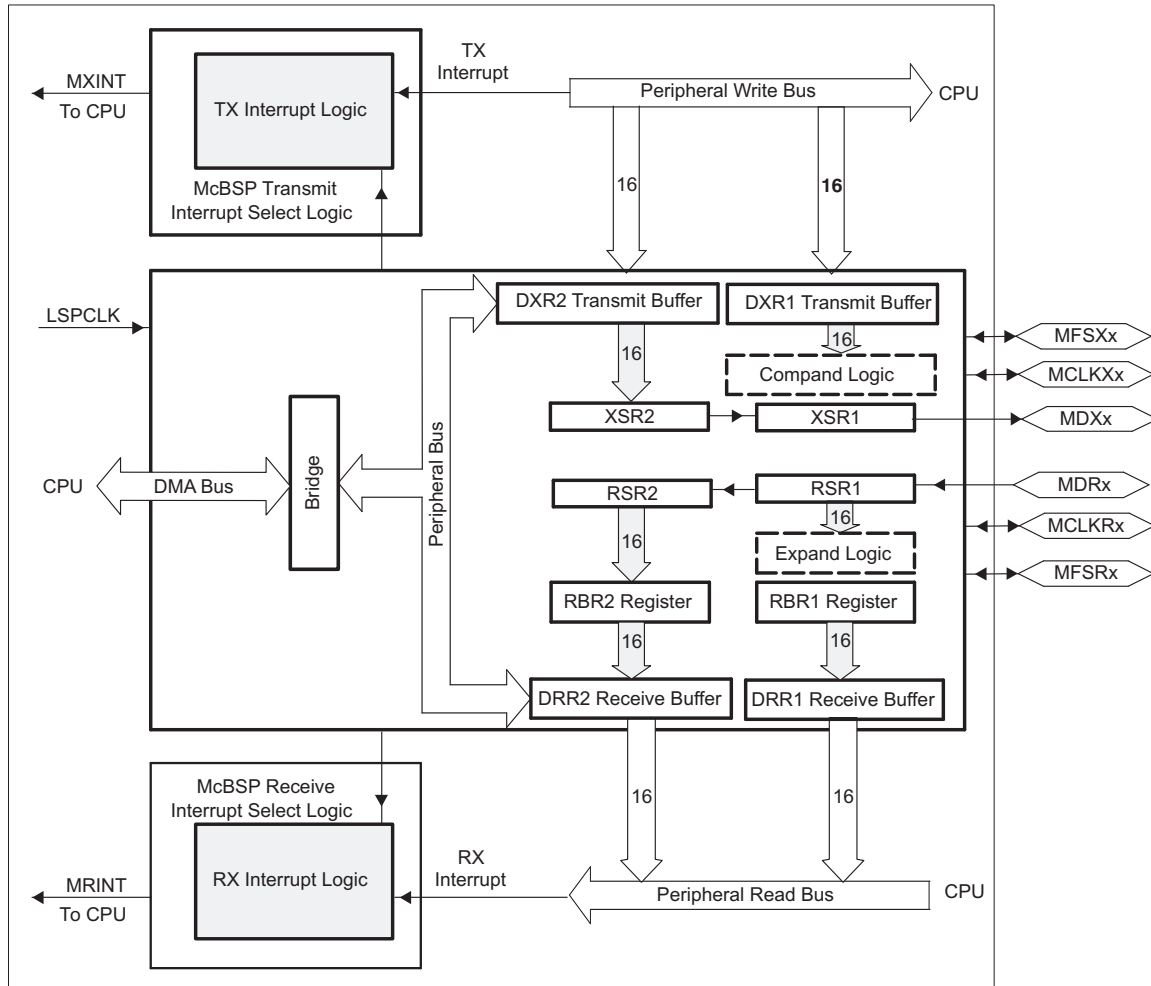

A Not available in all devices. See the device-specific data sheet

McBSP Operation

This section addresses the following topics:

- Data transfer process
- Companding (compressing and expanding) data
- Clocking and framing data
- Frame phases
- McBSP reception
- McBSP transmission
- Interrupts and DMA events generated by McBSPs

Topic		Page
2.1 Data Transfer Process of McBSPs		20
2.2 Companding (Compressing and Expanding) Data		20
2.3 Clocking and Framing Data		22
2.4 Frame Phases		24
2.5 McBSP Reception		26
2.6 McBSP Transmission		29
2.7 Interrupts and DMA Events Generated by a McBSP		30

2.1 Data Transfer Process of McBSPs

Figure 2-1 shows a diagram of the McBSP data transfer paths. The McBSP receive operation is triple-buffered, and transmit operation is double-buffered. The use of registers varies, depending on whether the defined length of each serial word is 16 bits.

Figure 2-1. McBSP Data Transfer Paths

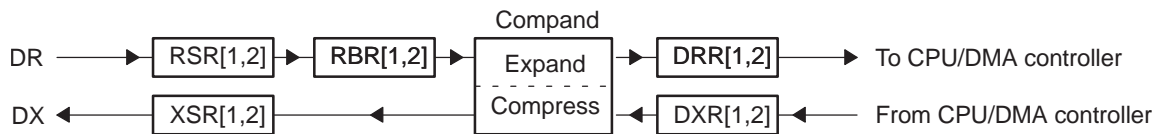

2.1.1 Data Transfer Process for Word Length of 8, 12, or 16 Bits

If the word length is 16 bits or smaller, only one 16-bit register is needed at each stage of the data transfer paths. The registers DRR2, RBR2, RSR2, DXR2, and XSR2 are not used (written, read, or shifted).

Receive data arrives on the DR pin and is shifted into receive shift register 1 (RSR1). Once a full word is received, the content of RSR1 is copied to receive buffer register 1 (RBR1) if RBR1 is not full with previous data. RBR1 is then copied to data receive register 1 (DRR1), unless the previous content of DRR1 has not been read by the CPU or the DMA controller. If the companding feature of the McBSP is implemented, the required word length is 8 bits and receive data is expanded into the appropriate format before being passed from RBR1 to DRR1. For more details about reception, see [Section 2.5](#).

Transmit data is written by the CPU or the DMA controller to data transmit register 1 (DXR1). If there is no previous data in transmit shift register (XSR1), the value in DXR1 is copied to XSR1; otherwise, DXR1 is copied to XSR1 when the last bit of the previous data is shifted out on the DX pin. If selected, the companding module compresses 16-bit data into the appropriate 8-bit format before passing it to XSR1. After transmit frame synchronization, the transmitter begins shifting bits from XSR1 to the DX pin. For more details about transmission, see [Section 2.6](#).

2.1.2 Data Transfer Process for Word Length of 20, 24, or 32 Bits

If the word length is larger than 16 bits, two 16-bit registers are needed at each stage of the data transfer paths. The registers DRR2, RBR2, RSR2, DXR2, and XSR2 are needed to hold the most significant bits.

Receive data arrives on the DR pin and is shifted first into RSR2 and then into RSR1. Once the full word is received, the contents of RSR2 and RSR1 are copied to RBR2 and RBR1, respectively, if RBR1 is not full. Then the contents of RBR2 and RBR1 are copied to DRR2 and DRR1, respectively, unless the previous content of DRR1 has not been read by the CPU or the DMA controller. The CPU or the DMA controller must read data from DRR2 first and then from DRR1. When DRR1 is read, the next RBR-to-DRR copy occurs. For more details about reception, see [Section 2.5](#).

For transmission, the CPU or the DMA controller must write data to DXR2 first and then to DXR1. When new data arrives in DXR1, if there is no previous data in XSR1, the contents of DXR2 and DXR1 are copied to XSR2 and XSR1, respectively; otherwise, the contents of the DXRs are copied to the XSRs when the last bit of the previous data is shifted out on the DX pin. After transmit frame synchronization, the transmitter begins shifting bits from the XSRs to the DX pin. For more details about transmission, see [Section 2.6](#).

2.2 Companding (Compressing and Expanding) Data

Companding (COMpressing and exPANDING) hardware allows compression and expansion of data in either μ -law or A-law format. The companding standard employed in the United States and Japan is μ -law. The European companding standard is referred to as A-law. The specifications for μ -law and A-law log PCM are part of the CCITT G.711 recommendation.

A-law and μ -law allow 13 bits and 14 bits of dynamic range, respectively. Any values outside this range are set to the most positive or most negative value. Thus, for companding to work best, the data transferred to and from the McBSP via the CPU or DMA controller must be at least 16 bits wide.

The μ -law and A-law formats both encode data into 8-bit code words. Companded data is always 8 bits wide; the appropriate word length bits (RWDLEN1, RWDLEN2, XWDLEN1, XWDLEN2) must therefore be set to 0, indicating an 8-bit wide serial data stream. If companding is enabled and either of the frame phases does not have an 8-bit word length, companding continues as if the word length is 8 bits.

Figure 2-2 illustrates the companding processes. When companding is chosen for the transmitter, compression occurs during the process of copying data from DXR1 to XSR1. The transmit data is encoded according to the specified companding law (A-law or μ -law). When companding is chosen for the receiver, expansion occurs during the process of copying data from RBR1 to DRR1. The receive data is decoded to two's-complement format.

Figure 2-2. Companding Processes

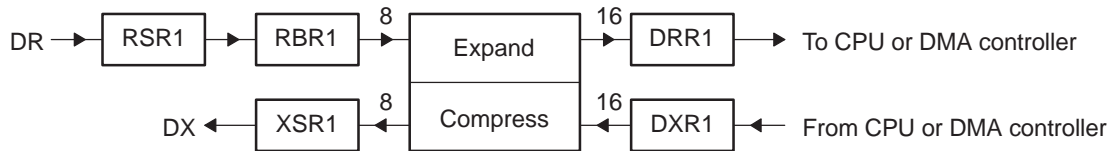

2.2.1 Companding Formats

For reception, the 8-bit compressed data in RBR1 is expanded to left-justified 16-bit data in DRR1. The receive sign-extension and justification mode specified in RJUST is ignored when companding is used.

For transmission using μ -law compression, the 14 data bits must be left-justified in DXR1 and that the remaining two low-order bits are filled with 0s as shown in Figure 2-3.

Figure 2-3. μ -Law Transmit Data Companding Format

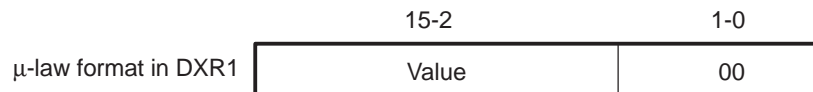

For transmission using A-law compression, the 13 data bits must be left-justified in DXR1, with the remaining three low-order bits filled with 0s as shown in Figure 2-4.

Figure 2-4. A-Law Transmit Data Companding Format

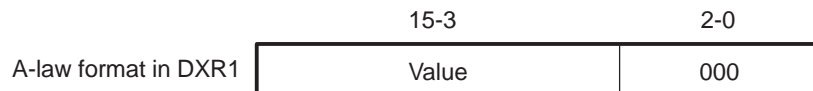

2.2.2 Capability to Compand Internal Data

If the McBSP is otherwise unused (the serial port transmit and receive sections are reset), the companding hardware can compand internal data. This can be used to:

- Convert linear to the appropriate μ -law or A-law format
- Convert μ -law or A-law to the linear format
- Observe the quantization effects in companding by transmitting linear data and compressing and re-expanding this data. This is useful only if both XCOMPAND and RCOMPAND enable the same companding format.

Figure 2-5 shows two methods by which the McBSP can compand internal data. Data paths for these two methods are used to indicate:

- When both the transmit and receive sections of the serial port are reset, DRR1 and DXR1 are connected internally through the companding logic. Values from DXR1 are compressed, as selected by XCOMPAND, and then expanded, as selected by RCOMPAND. RRDY and XRDY bits are not set. However, data is available in DRR1 within four CPU clocks after being written to DXR1.

The advantage of this method is its speed. The disadvantage is that there is no synchronization available to the CPU and DMA to control the flow. DRR1 and DXR1 are internally connected if the (X/R)COMPAND bits are set to 10b or 11b (compand using μ -law or A-law).

- The McBSP is enabled in digital loopback mode with companding appropriately enabled by RCOMPAND and XCOMPAND. Receive and transmit interrupts (RINT when RINTM = 0 and XINT when XINTM = 0) or synchronization events (REVT and XEVT) allow synchronization of the CPU or DMA to these conversions, respectively. Here, the time for this companding depends on the serial bit rate selected.

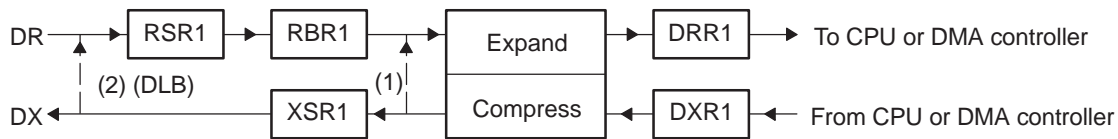
Figure 2-5. Two Methods by Which the McBSP Can Compand Internal Data

2.2.3 Reversing Bit Order: Option to Transfer LSB First

Generally, the McBSP transmits or receives all data with the most significant bit (MSB) first. However, certain 8-bit data protocols (that do not use companded data) require the least significant bit (LSB) to be transferred first. If you set XCOMPAND = 01b in XCR2, the bit ordering of 8-bit words is reversed (LSB first) before being sent from the serial port. If you set RCOMPAND = 01b in RCR2, the bit ordering of 8-bit words is reversed during reception. Similar to companding, this feature is enabled only if the appropriate word length bits are set to 0, indicating that 8-bit words are to be transferred serially. If either phase of the frame does not have an 8-bit word length, the McBSP assumes the word length is eight bits, and LSB-first ordering is done.

2.3 Clocking and Framing Data

This section explains basic concepts and terminology important for understanding how McBSP data transfers are timed and delimited.

2.3.1 Clocking

Data is shifted one bit at a time from the DR pin to the RSR(s) or from the XSR(s) to the DX pin. The time for each bit transfer is controlled by the rising or falling edge of a clock signal.

The receive clock signal (CLKR) controls bit transfers from the DR pin to the RSR(s). The transmit clock signal (CLKX) controls bit transfers from the XSR(s) to the DX pin. CLKR or CLKX can be derived from a pin at the boundary of the McBSP or derived from inside the McBSP. The polarities of CLKR and CLKX are programmable.

In the example in [Figure 2-6](#), the clock signal controls the timing of each bit transfer on the pin.

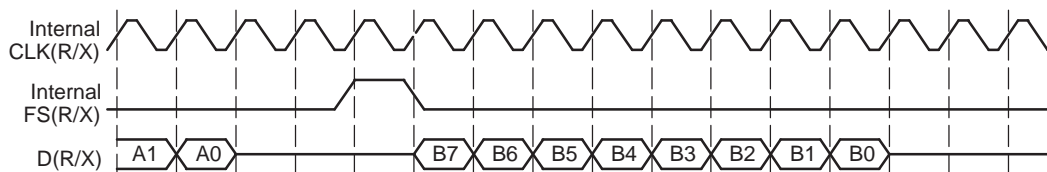
Figure 2-6. Example - Clock Signal Control of Bit Transfer Timing

NOTE: The McBSP cannot operate at a frequency faster than $\frac{1}{2}$ the LSPCLK frequency. When driving CLKX or CLKR at the pin, choose an appropriate input clock frequency. When using the internal sample rate generator for CLKX and/or CLKR, choose an appropriate input clock frequency and divide down value (CLKDV) (i.e., be certain that CLKX or CLKR \leq LSPCLK/2).

2.3.2 Serial Words

Bits traveling between a shift register (RSR or XSR) and a data pin (DR or DX) are transferred in a group called a serial word. You can define how many bits are in a word.

Bits coming in on the DR pin are held in RSR until RSR holds a full serial word. Only then is the word passed to RBR (and ultimately to the DRR).

During transmission, XSR does not accept new data from DXR until a full serial word has been passed from XSR to the DX pin.

In the example in [Figure 2-6](#), an 8-bit word size was defined (see bits 7 through 0 of word B being transferred).

2.3.3 Frames and Frame Synchronization

One or more words are transferred in a group called a frame. You can define how many words are in a frame.

All of the words in a frame are sent in a continuous stream. However, there can be pauses between frame transfers. The McBSP uses frame-synchronization signals to determine when each frame is received/transmitted. When a pulse occurs on a frame-synchronization signal, the McBSP begins receiving/transmitting a frame of data. When the next pulse occurs, the McBSP receives/transmits the next frame, and so on.

Pulses on the receive frame-synchronization (FSR) signal initiate frame transfers on DR. Pulses on the transmit frame-sync (FSX) signal initiate frame transfers on DX. FSR or FSX can be derived from a pin at the boundary of the McBSP or derived from inside the McBSP.

In the example in [Figure 2-6](#), a one-word frame is transferred when a frame-synchronization pulse occurs.

In McBSP operation, the inactive-to-active transition of the frame-synchronization signal indicates the start of the next frame. For this reason, the frame-synchronization signal may be high for an arbitrary number of clock cycles. Only after the signal is recognized to have gone inactive, and then active again, does the next frame synchronization occur.

2.3.4 Generating Transmit and Receive Interrupts

The McBSP can send receive and transmit interrupts to the CPU to indicate specific events in the McBSP. To facilitate detection of frame synchronization, these interrupts can be sent in response to frame-synchronization pulses. Set the appropriate interrupt mode bits to 10b (for reception, RINTM = 10b; for transmission, XINTM = 10b).

2.3.4.1 Detecting Frame-Synchronization Pulses, Even in Reset State

Unlike other serial port interrupt modes, this mode can operate while the associated portion of the serial port is in reset (such as activating RINT when the receiver is in reset). In this case, FSRM/FSXM and FSRP/FSXP still select the appropriate source and polarity of frame synchronization. Thus, even when the serial port is in the reset state, these signals are synchronized to the CPU clock and then sent to the CPU in the form of RINT and XINT at the point at which they feed the receiver and transmitter of the serial port. Consequently, a new frame-synchronization pulse can be detected, and after this occurs the CPU can take the serial port out of reset safely.

2.3.5 Ignoring Frame-Synchronization Pulses

The McBSP can be configured to ignore transmit and/or receive frame-synchronization pulses. To have the receiver or transmitter recognize frame-synchronization pulses, clear the appropriate frame-synchronization ignore bit (RFIG = 0 for the receiver, XFIG = 0 for the transmitter). To have the receiver or transmitter ignore frame-synchronization pulses until the desired frame length or number of words is reached, set the appropriate frame-synchronization ignore bit (RFIG = 1 for the receiver, XFIG = 1 for the transmitter). For more details on unexpected frame-synchronization pulses, see one of the following topics:

- *Unexpected Receive Frame-Synchronization Pulse* (see [Section 4.3](#))
- *Unexpected Transmit Frame-Synchronization Pulse* (see [Section 4.6](#))

You can also use the frame-synchronization ignore function for data packing (for more details, see [Section 10.2](#)).

2.3.6 Frame Frequency

The frame frequency is determined by the period between frame-synchronization pulses and is defined as shown by Example 1.

Example 1: McBSP Frame Frequency

$$\text{Frame Frequency} = \frac{\text{Clock Frequency}}{\text{Number of Clock Cycles Between Frame- Sync Pulses}}$$

The frame frequency can be increased by decreasing the time between frame-synchronization pulses (limited only by the number of bits per frame). As the frame transmit frequency increases, the inactivity period between the data packets for adjacent transfers decreases to zero.

2.3.7 Maximum Frame Frequency

The minimum number of clock cycles between frame synchronization pulses is equal to the number of bits transferred per frame. The maximum frame frequency is defined as shown by Example 2.

Example 2: McBSP Maximum Frame Frequency

$$\text{Maximum Frame Frequency} = \frac{\text{Clock Frequency}}{\text{Number of Bits Per Frame}}$$

Figure 2-7 shows the McBSP operating at maximum packet frequency. At maximum packet frequency, the data bits in consecutive packets are transmitted contiguously with no inactivity between bits.

Figure 2-7. McBSP Operating at Maximum Packet Frequency

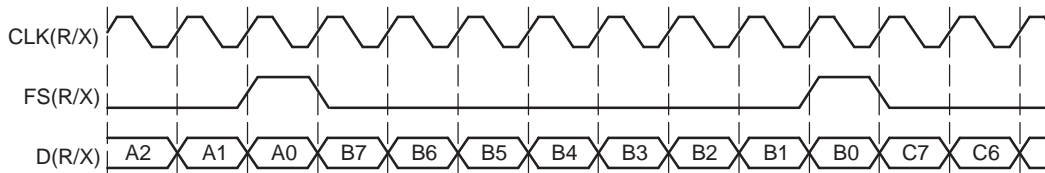

If there is a 1-bit data delay as shown in this figure, the frame-synchronization pulse overlaps the last bit transmitted in the previous frame. Effectively, this permits a continuous stream of data, making frame-synchronization pulses redundant. Theoretically, only an initial frame-synchronization pulse is required to initiate a multipacket transfer.

The McBSP supports operation of the serial port in this fashion by ignoring the successive frame-synchronization pulses. Data is clocked into the receiver or clocked out of the transmitter during every clock cycle.

NOTE: For XDATDLY = 0 (0-bit data delay), the first bit of data is transmitted asynchronously to the internal transmit clock signal (CLKX). For more details, see [Section 8.12, Set the Transmit Data Delay](#).

2.4 Frame Phases

The McBSP allows you to configure each frame to contain one or two phases. The number of words and the number of bits per word can be specified differently for each of the two phases of a frame, allowing greater flexibility in structuring data transfers. For example, you might define a frame as consisting of one phase containing two words of 16 bits each, followed by a second phase consisting of 10 words of 8 bits each. This configuration permits you to compose frames for custom applications or, in general, to maximize the efficiency of data transfers.

2.4.1 Number of Phases, Words, and Bits Per Frame

Table 2-1 shows which bit-fields in the receive control registers (RCR1 and RCR2) and in the transmit control registers (XCR1 and XCR2) determine the number of phases per frame, the number of words per frame, and number of bits per word for each phase, for the receiver and transmitter. The maximum number of words per frame is 128 for a single-phase frame and 256 for a dual-phase frame. The number of bits per word can be 8, 12, 16, 20, 24, or 32 bits.

Table 2-1. Register Bits That Determine the Number of Phases, Words, and Bits

Operation	Number of Phases	Words per Frame Set With	Bits per Word Set With
Reception	1 (RPHASE = 0)	RFRLLEN1	RWDLEN1
Reception	2 (RPHASE = 1)	RFRLLEN1 and RFRLLEN2	RWDLEN1 for phase 1 RWDLEN2 for phase 2
Transmission	1 (XPHASE = 0)	XFRLLEN1	XWDLEN1
Transmission	2 (XPHASE = 1)	XFRLLEN1 and XFRLLEN2	XWDLEN1 for phase 1 XWDLEN2 for phase 2

2.4.2 Single-Phase Frame Example

Figure 2-8 shows an example of a single-phase data frame containing one 8-bit word. Because the transfer is configured for one data bit delay, the data on the DX and DR pins are available one clock cycle after FS(R/X) goes active. The figure makes the following assumptions:

- (R/X)PHASE = 0: Single-phase frame
- (R/X)FRLLEN1 = 0b: 1 word per frame
- (R/X)WDLEN1 = 000b: 8-bit word length
- (R/X)FRLLEN2 and (R/X)WDLEN2 are ignored
- CLK(X/R)P = 0: Receive data clocked on falling edge; transmit data clocked on rising edge
- FS(R/X)P = 0: Active-high frame-synchronization signals
- (R/X)DATDLY = 01b: 1-bit data delay

Figure 2-8. Single-Phase Frame for a McBSP Data Transfer

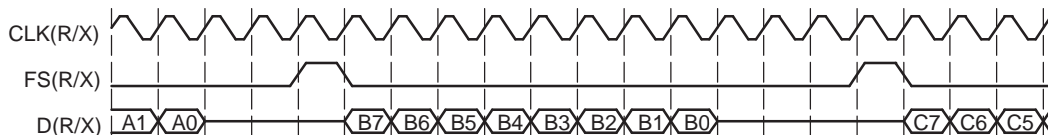

2.4.3 Dual-Phase Frame Example

Figure 2-9 shows an example of a frame where the first phase consists of two words of 12 bits each, followed by a second phase of three words of 8 bits each. The entire bit stream in the frame is contiguous. There are no gaps either between words or between phases.

Figure 2-9. Dual-Phase Frame for a McBSP Data Transfer

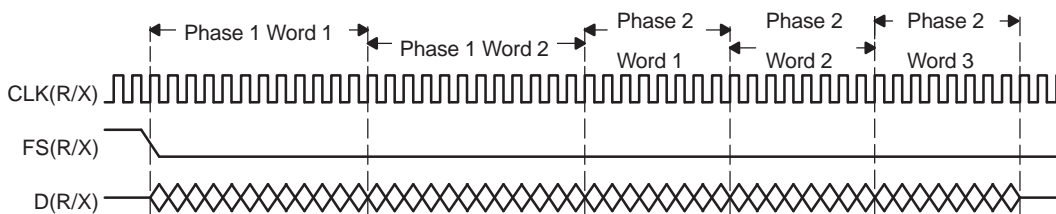

A XRDY gets asserted once per phase. So, if there are 2 phases, XRDY gets asserted twice (once per phase).

2.4.4 Implementing the AC97 Standard With a Dual-Phase Frame

Figure 2-10 shows an example of the Audio Codec '97 (AC97) standard, which uses the dual-phase frame feature. Notice that words, not individual bits, are shown on the D(R/X) signal. The first phase (P1) consists of a single 16-bit word. The second phase (P2) consists of twelve 20-bit words. The phase configurations are listed after the figure.

Figure 2-10. Implementing the AC97 Standard With a Dual-Phase Frame

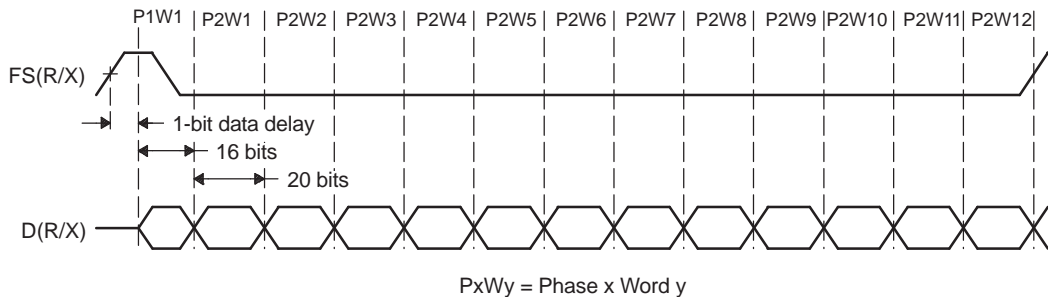

- (R/X)PHASE = 1: Dual-phase frame
- (R/X)FRLLEN1 = 0000000b: 1 word in phase 1
- (R/X)WDLEN1 = 010b: 16 bits per word in phase 1
- (R/X)FRLLEN2 = 0001011b: 12 words in phase 2
- (R/X)WDLEN2 = 011b: 20 bits per word in phase 2
- CLKRP/CLKXP= 0: Receive data sampled on falling edge of internal CLKR / transmit data clocked on rising edge of internal CLKX
- FSRP/FSXP = 0: Active-high frame-sync signal
- (R/X)DATDLY = 01b: Data delay of 1 clock cycle (1-bit data delay)

Figure 2-11 shows the timing of an AC97-standard data transfer near frame synchronization. In this figure, individual bits are shown on D(R/X). Specifically, the figure shows the last two bits of phase 2 of one frame and the first four bits of phase 1 of the next frame. Regardless of the data delay, data transfers can occur without gaps. The first bit of the second frame (P1W1B15) immediately follows the last bit of the first frame (P2W12B0). Because a 1-bit data delay has been chosen, the transition on the frame-sync signal can occur when P2W12B0 is transferred.

Figure 2-11. Timing of an AC97-Standard Data Transfer Near Frame Synchronization

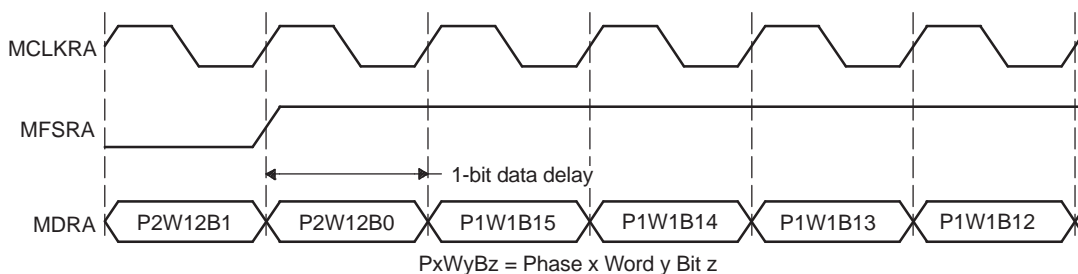

2.5 McBSP Reception

This section explains the fundamental process of reception in the McBSP. For details about how to program the McBSP receiver, see *Receiver Configuration* in [Chapter 7](#).

Figure 2-12 and Figure 2-13 show how reception occurs in the McBSP. Figure 2-12 shows the physical path for the data. Figure 2-13 is a timing diagram showing signal activity for one possible reception scenario. A description of the process follows the figures.

Figure 2-12. McBSP Reception Physical Data Path

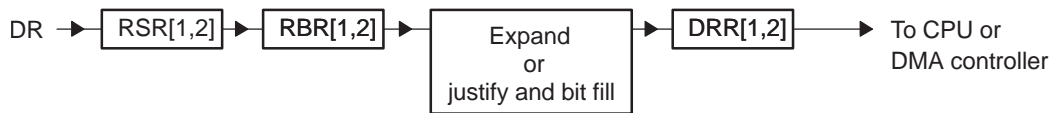

- A RSR[1,2]: Receive shift registers 1 and 2
- B RBR[1,2]: Receive buffer registers 1 and 2
- C DRR[1,2]: Data receive registers 1 and 2

Figure 2-13. McBSP Reception Signal Activity

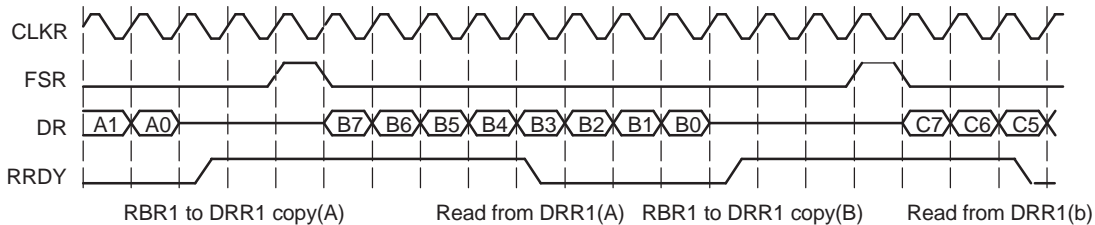

- A CLKR: Internal receive clock
- B FSR: Internal receive frame-synchronization signal
- C DR: Data on DR pin
- D RRDY: Status of receiver ready bit (high is 1)

The following process describes how data travels from the DR pin to the CPU or to the DMA controller:

1. The McBSP waits for a receive frame-synchronization pulse on internal FSR.
2. When the pulse arrives, the McBSP inserts the appropriate data delay that is selected with the RDATDLY bits of RCR2.
In the preceding timing diagram (Figure 2-13), a 1-bit data delay is selected.
3. The McBSP accepts data bits on the DR pin and shifts them into the receive shift register(s).
If the word length is 16 bits or smaller, only RSR1 is used. If the word length is larger than 16 bits, RSR2 and RSR1 are used and RSR2 contains the most significant bits. For details on choosing a word length, see Section 7.8, *Set the Receive Word Length(s)*.
4. When a full word is received, the McBSP copies the contents of the receive shift register(s) to the receive buffer register(s), provided that RBR1 is not full with previous data.
If the word length is 16 bits or smaller, only RBR1 is used. If the word length is larger than 16 bits, RBR2 and RBR1 are used and RBR2 contains the most significant bits.
5. The McBSP copies the contents of the receive buffer register(s) into the data receive register(s), provided that DRR1 is not full with previous data. When DRR1 receives new data, the receiver ready bit (RRDY) is set in SPCR1. This indicates that received data is ready to be read by the CPU or the DMA controller.
If the word length is 16 bits or smaller, only DRR1 is used. If the word length is larger than 16 bits, DRR2 and DRR1 are used and DRR2 contains the most significant bits.
If companding is used during the copy (RCOMPAND = 10b or 11b in RCR2), the 8-bit compressed data in RBR1 is expanded to a left-justified 16-bit value in DRR1. If companding is disabled, the data copied from RBR[1,2] to DRR[1,2] is justified and bit filled according to the RJUST bits.
6. The CPU or the DMA controller reads the data from the data receive register(s). When DRR1 is read, RRDY is cleared and the next RBR-to-DRR copy is initiated.

NOTE: If both DRRs are required (word length larger than 16 bits), the CPU or the DMA controller must read from DRR2 first and then from DRR1. As soon as DRR1 is read, the next RBR-to-DRR copy is initiated. If DRR2 is not read first, the data in DRR2 is lost.

When activity is not properly timed, errors can occur. See the following topics for more details:

- *Overrun in the Receiver* (see Section 4.2)

- *Unexpected Receive Frame-Synchronization Pulse* (see [Section 4.3](#))

2.6 McBSP Transmission

This section explains the fundamental process of transmission in the McBSP. For details about how to program the McBSP transmitter, see [Chapter 8, Transmitter Configuration](#).

[Figure 2-14](#) and [Figure 2-15](#) show how transmission occurs in the McBSP. [Figure 2-14](#) shows the physical path for the data. [Figure 2-15](#) is a timing diagram showing signal activity for one possible transmission scenario. A description of the process follows the figures.

Figure 2-14. McBSP Transmission Physical Data Path

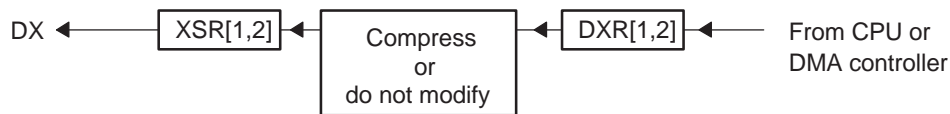

- A XSR[1,2]: Transmit shift registers 1 and 2
- B DXR[1,2]: Data transmit registers 1 and 2

Figure 2-15. McBSP Transmission Signal Activity

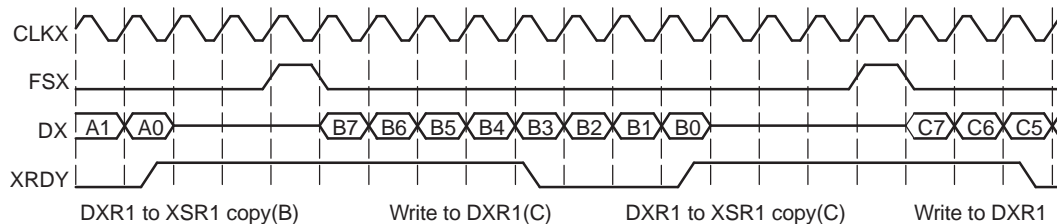

- A CLKX: Internal transmit clock
- B FSX: Internal transmit frame-synchronization signal
- C DX: Data on DX pin
- D XRDY: Status of transmitter ready bit (high is 1)

1. The CPU or the DMA controller writes data to the data transmit register(s). When DXR1 is loaded, the transmitter ready bit (XRDY) is cleared in SPCR2 to indicate that the transmitter is not ready for new data.

If the word length is 16 bits or smaller, only DXR1 is used. If the word length is larger than 16 bits, DXR2 and DXR1 are used and DXR2 contains the most significant bits. For details on choosing a word length, see [Section 8.8, Set the Transmit Word Length\(s\)](#).

NOTE: If both DXRs are needed (word length larger than 16 bits), the CPU or the DMA controller must load DXR2 first and then load DXR1. As soon as DXR1 is loaded, the contents of both DXRs are copied to the transmit shift registers (XSRs), as described in the next step. If DXR2 is not loaded first, the previous content of DXR2 is passed to the XSR2.

2. When new data arrives in DXR1, the McBSP copies the content of the data transmit register(s) to the transmit shift register(s). In addition, the transmit ready bit (XRDY) is set. This indicates that the transmitter is ready to accept new data from the CPU or the DMA controller.

If the word length is 16 bits or smaller, only XSR1 is used. If the word length is larger than 16 bits, XSR2 and XSR1 are used and XSR2 contains the most significant bits.

If companding is used during the transfer (XCOMPAND = 10b or 11b in XCR2), the McBSP compresses the 16-bit data in DXR1 to 8-bit data in the μ -law or A-law format in XSR1. If companding is disabled, the McBSP passes data from the DXR(s) to the XSR(s) without modification.

3. The McBSP waits for a transmit frame-synchronization pulse on internal FSX.
4. When the pulse arrives, the McBSP inserts the appropriate data delay that is selected with the XDADLY bits of XCR2.

In the preceding timing diagram ([Figure 2-15](#)), a 1-bit data delay is selected.

5. The McBSP shifts data bits from the transmit shift register(s) to the DX pin.

When activity is not properly timed, errors can occur. See the following topics for more details:

- *Overwrite in the Transmitter* ([Section 4.4](#))
- *Underflow in the Transmitter* ([Section 4.5](#))
- *Unexpected Transmit Frame-Synchronization Pulse* ([Section 4.6](#))

2.7 Interrupts and DMA Events Generated by a McBSP

The McBSP sends notification of important events to the CPU and DMA via the internal signals shown in [Table 2-2](#).

Table 2-2. Interrupts and DMA Events Generated by a McBSP

Internal Signal	Description
RINT	Receive interrupt The McBSP can send a receive interrupt request to CPU based upon a selected condition in the receiver of the McBSP (a condition selected by the RINTM bits of SPCR1).
XINT	Transmit interrupt The McBSP can send a transmit interrupt request to CPU based upon a selected condition in the transmitter of the McBSP (a condition selected by the XINTM bits of SPCR2).
REVT	Receive synchronization event An REVT signal is sent to the DMA when data has been received in the data receive registers (DRRs).
XEVT	Transmit synchronization event An XEVT signal is sent to the DMA when the data transmit registers (DXRs) are ready to accept the next serial word for transmission.

McBSP Sample Rate Generator

Each McBSP contains a sample rate generator (SRG) that can be programmed to generate an internal data clock (CLKG) and an internal frame-synchronization signal (FSG). CLKG can be used for bit shifting on the data receive (DR) pin and/or the data transmit (DX) pin. FSG can be used to initiate frame transfers on DR and/or DX. [Figure 3-1](#) is a conceptual block diagram of the sample rate generator.

Topic	Page
3.1 Block Diagram	32
3.2 Frame Synchronization Generation in the Sample Rate Generator	35
3.3 Synchronizing Sample Rate Generator Outputs to an External Clock	35
3.4 Reset and Initialization Procedure for the Sample Rate Generator	37

3.1 Block Diagram

Figure 3-1. Conceptual Block Diagram of the Sample Rate Generator

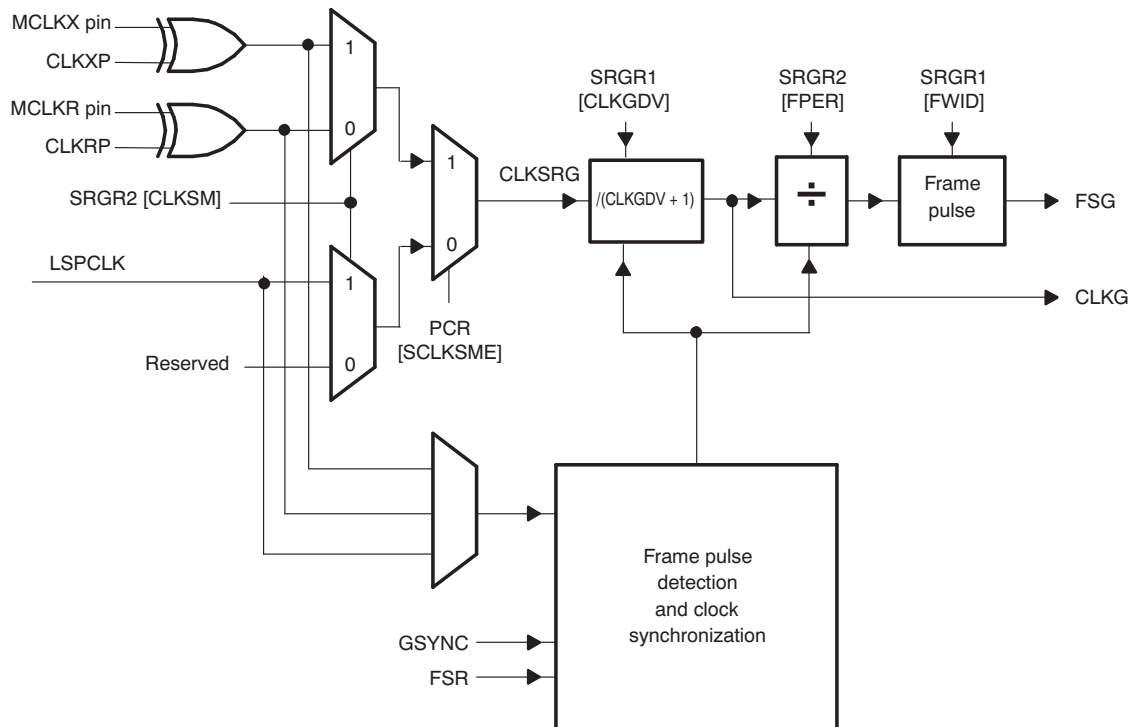

The source clock for the sample rate generator (labeled CLKSRG in the diagram) can be supplied by the LSPCLK, or by an external pin (MCLKX or MCLKR). The source is selected with the SCLKME bit of PCR and the CLKSM bit of SRGR2. If a pin is used, the polarity of the incoming signal can be inverted with the appropriate polarity bit (CLKXP of PCR or CLKRP of PCR).

The sample rate generator has a three-stage clock divider that gives CLKG and FSG programmability. The three stages provide:

- Clock divide-down. The source clock is divided according to the CLKGDV bits of SRGR1 to produce CLKG.
- Frame period divide-down. CLKG is divided according to the FPER bits of SRGR2 to control the period from the start of a frame-pulse to the start of the next pulse.
- Frame-synchronization pulse-width countdown. CLKG cycles are counted according to the FWID bits of SRGR1 to control the width of each frame-synchronization pulse.

NOTE: The McBSP cannot operate at a frequency faster than $\frac{1}{2}$ the source clock frequency. Choose an input clock frequency and a CLKGDV value such that CLKG is less than or equal to $\frac{1}{2}$ the source clock frequency.

In addition to the three-stage clock divider, the sample rate generator has a frame-synchronization pulse detection and clock synchronization module that allows synchronization of the clock divide down with an incoming frame-synchronization pulse on the FSR pin. This feature is enabled or disabled with the GSYNC bit of SRGR2.

For details on getting the sample rate generator ready for operation, see [Section 3.4, Reset and Initialization Procedure](#).

3.1.1 Clock Generation in the Sample Rate Generator

The sample rate generator can produce a clock signal (CLKG) for use by the receiver, the transmitter, or both. Use of the sample rate generator to drive clocking is controlled by the clock mode bits (CLKRM and CLKXM) in the pin control register (PCR). When a clock mode bit is set to 1 (CLKRM = 1 for reception, CLKXM = 1 for transmission), the corresponding data clock (CLKR for reception, CLKX for transmission) is driven by the internal sample rate generator output clock (CLKG).

The effects of CLKRM = 1 and CLKXM = 1 on the McBSP are partially affected by the use of the digital loopback mode and the clock stop (SPI) mode, respectively, as described in [Table 3-1](#). The digital loopback mode (described in [Section 7.4](#)) is selected with the DLB bit of SPCR1. The clock stop mode (described in [Section 6.2](#)) is selected with the CLKSTP bits of SPCR1.

When using the sample rate generator as a clock source, make sure the sample rate generator is enabled (GRST = 1).

Table 3-1. Effects of DLB and CLKSTP on Clock Modes

Mode Bit Settings		Effect
CLKRM = 1	DLB = 0 (Digital loopback mode disabled)	CLKR is an output pin driven by the sample rate generator output clock (CLKG).
	DLB = 1 (Digital loopback mode enabled)	CLKR is an output pin driven by internal CLKX. The source for CLKX depends on the CLKXM bit.
CLKXM = 1	CLKSTP = 00b or 01b (Clock stop (SPI) mode disabled)	CLKX is an output pin driven by the sample rate generator output clock (CLKG).
	CLKSTP = 10b or 11b (Clock stop (SPI) mode enabled)	The McBSP is a master in an SPI system. Internal CLKX drives internal CLKR and the shift clocks of any SPI-compliant slave devices in the system. CLKX is driven by the internal sample rate generator.

3.1.2 Choosing an Input Clock

The sample rate generator must be driven by an input clock signal from one of the three sources selectable with the SCLKME bit of PCR and the CLKSM bit of SRGR2 (see [Table 3-2](#)). When CLKSM = 1, the minimum divide down value in CLKGDV bits is 1. CLKGDV is described in [Section 3.1.4](#).

Table 3-2. Choosing an Input Clock for the Sample Rate Generator with the SCLKME and CLKSM Bits

SCLKME	CLKSM	Input Clock for Sample Rate Generator
0	0	Reserved
0	1	LSPCLK
1	0	Signal on MCLKR pin
1	1	Signal on MCLKX pin

3.1.3 Choosing a Polarity for the Input Clock

As shown in [Figure 3-2](#), when the input clock is received from a pin, you can choose the polarity of the input clock. The rising edge of CLKSRG generates CLKG and FSG, but you can determine which edge of the input clock causes a rising edge on CLKSRG. The polarity options and their effects are described in [Table 3-3](#).

Figure 3-2. Possible Inputs to the Sample Rate Generator and the Polarity Bits

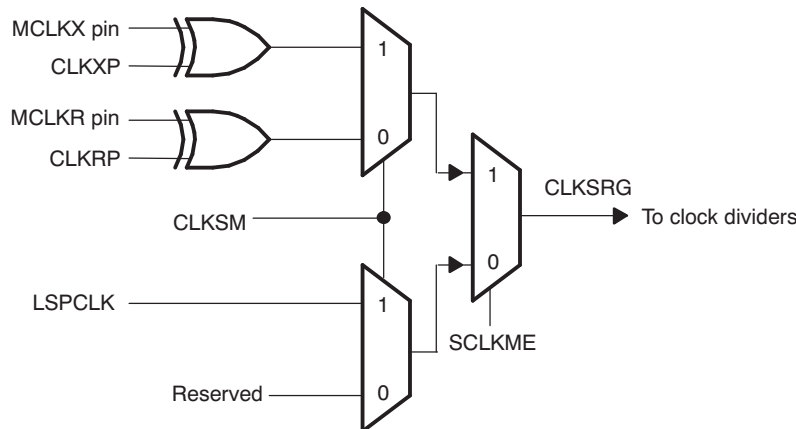

Table 3-3. Polarity Options for the Input to the Sample Rate Generator

Input Clock	Polarity Option	Effect
LSPCLK	Always positive polarity	Rising edge of CPU clock generates transitions on CLKG and FSG.
Signal on MCLKR pin	CLKRP = 0 in PCR	Falling edge on MCLKR pin generates transitions on CLKG and FSG.
	CLKRP = 1 in PCR	Rising edge on MCLKR pin generates transitions on CLKG and FSG.
Signal on MCLKX pin	CLKXP = 0 in PCR	Rising edge on MCLKX pin generates transitions on CLKG and FSG.
	CLKXP = 1 in PCR	Falling edge on MCLKX pin generates transitions on CLKG and FSG.

3.1.4 Choosing a Frequency for the Output Clock (CLKG)

The input clock (LSPCLK or external clock) can be divided down by a programmable value to drive CLKG. Regardless of the source to the sample rate generator, the rising edge of CLKS_{RG} (see [Figure 3-1](#)) generates CLKG and FSG.

The first divider stage of the sample rate generator creates the output clock from the input clock. This divider stage uses a counter that is preloaded with the divide down value in the CLKGDV bits of SRGR1. The output of this stage is the data clock (CLKG). CLKG has the frequency represented by the equation.

Equation 1: CLKG Frequency

$$\text{CLKG frequency} = \frac{\text{Input clock frequency}}{(\text{CLKGDV} + 1)}$$

3.1.4.1 CLKG Frequency

Thus, the input clock frequency is divided by a value between 1 and 256. When CLKGDV is odd or equal to 0, the CLKG duty cycle is 50%. When CLKGDV is an even value, 2p, representing an odd divide down, the high-state duration is p+1 cycles and the low-state duration is p cycles.

3.1.5 Keeping CLKG Synchronized to External MCLKR

When the MCLKR pin is used to drive the sample rate generator (see [Section 3.1.2](#)), the GSYNC bit in SRGR2 and the FSR pin can be used to configure the timing of the output clock (CLKG) relative to the input clock. Note that this feature is available only when the MCLKR pin is used to feed the external clock.

GSYNC = 1 ensures that the McBSP and an external device are dividing down the input clock with the same phase relationship. If GSYNC = 1, an inactive-to-active transition on the FSR pin triggers a resynchronization of CLKG and generation of FSG.

For more details about synchronization, see [Section 3.3](#).

3.2 Frame Synchronization Generation in the Sample Rate Generator

The sample rate generator can produce a frame-synchronization signal (FSG) for use by the receiver, the transmitter, or both.

If you want the receiver to use FSG for frame synchronization, make sure $FSRM = 1$. (When $FSRM = 0$, receive frame synchronization is supplied via the FSR pin.)

If you want the transmitter to use FSG for frame synchronization, you must set:

- $FSXM = 1$ in PCR: This indicates that transmit frame synchronization is supplied by the McBSP itself rather than from the FSX pin.
- $FSGM = 1$ in SRGR2: This indicates that when $FSXM = 1$, transmit frame synchronization is supplied by the sample rate generator. (When $FSGM = 0$ and $FSXM = 1$, the transmitter uses frame-synchronization pulses generated every time data is transferred from $DXR[1,2]$ to $XSR[1,2]$.)

In either case, the sample rate generator must be enabled ($GRST = 1$) and the frame-synchronization logic in the sample rate generator must be enabled ($FRST = 1$).

3.2.1 Choosing the Width of the Frame-Synchronization Pulse on FSG

Each pulse on FSG has a programmable width. You program the FWID bits of SRGR1, and the resulting pulse width is $(FWID + 1)$ CLKG cycles, where CLKG is the output clock of the sample rate generator.

3.2.2 Controlling the Period Between the Starting Edges of Frame-Synchronization Pulses on FSG

You can control the amount of time from the starting edge of one FSG pulse to the starting edge of the next FSG pulse. This period is controlled in one of two ways, depending on the configuration of the sample rate generator:

- If the sample rate generator is using an external input clock and $GSYNC = 1$ in SRGR2, FSG pulses in response to an inactive-to-active transition on the FSR pin. Thus, the frame-synchronization period is controlled by an external device.
- Otherwise, you program the FPER bits of SRGR2, and the resulting frame-synchronization period is $(FPER + 1)$ CLKG cycles, where CLKG is the output clock of the sample rate generator.

3.2.3 Keeping FSG Synchronized to an External Clock

When an external signal is selected to drive the sample rate generator (see [Section 3.1.2](#) on page [Section 3.1.2](#)), the GSYNC bit of SRGR2 and the FSR pin can be used to configure the timing of FSG pulses.

$GSYNC = 1$ ensures that the McBSP and an external device are dividing down the input clock with the same phase relationship. If $GSYNC = 1$, an inactive-to-active transition on the FSR pin triggers a resynchronization of CLKG and generation of FSG.

See [Section 3.3](#) for more details about synchronization.

3.3 Synchronizing Sample Rate Generator Outputs to an External Clock

The sample rate generator can produce a clock signal (CLKG) and a frame-synchronization signal (FSG) based on an input clock signal that is either the CPU clock signal or a signal at the MCLKR or MCLKX pin. When an external clock is selected to drive the sample rate generator, the GSYNC bit of SRGR2 and the FSR pin can be used to control the timing of CLKG and the pulsing of FSG relative to the chosen input clock.

Make $GSYNC = 1$ when you want the McBSP and an external device to divide down the input clock with the same phase relationship. If $GSYNC = 1$:

- An inactive-to-active transition on the FSR pin triggers a resynchronization of CLKG and a pulsing of FSG.
- CLKG always begins with a high state after synchronization.
- FSR is always detected at the same edge of the input clock signal that generates CLKG, no matter

how long the FSR pulse is.

- The FPER bits of SRGR2 are ignored because the frame-synchronization period on FSG is determined by the arrival of the next frame-synchronization pulse on the FSR pin.

If GSYNC = 0, CLKG runs freely and is not resynchronized, and the frame-synchronization period on FSG is determined by FPER.

3.3.1 Operating the Transmitter Synchronously with the Receiver

When GSYNC = 1, the transmitter can operate synchronously with the receiver, provided that:

- FSX is programmed to be driven by FSG (FSGM = 1 in SRGR2 and FSXM = 1 in PCR). If the input FSR has appropriate timing so that it can be sampled by the falling edge of CLKG, it can be used, instead, by setting FSXM = 0 and connecting FSR to FSX externally.
- The sample rate generator clock drives the transmit and receive clocking (CLKRM = CLKXM = 1 in PCR).

3.3.2 Synchronization Examples

Figure 3-3 and Figure 3-4 show the clock and frame-synchronization operation with various polarities of CLKR and FSR. These figures assume FWID = 0 in SRGR1, for an FSG pulse that is one CLKG cycle wide. The FPER bits of SRGR2 are not programmed; the period from the start of a frame-synchronization pulse to the start of the next pulse is determined by the arrival of the next inactive-to-active transition on the FSR pin. Each of the figures shows what happens to CLKG when it is initially synchronized and GSYNC = 1, and when it is not initially synchronized and GSYNC = 1. The second figure has a slower CLKG frequency (it has a larger divide-down value in the CLKGDV bits of SRGR1).

Figure 3-3. CLKG Synchronization and FSG Generation When GSYNC = 1 and CLKGDV = 1

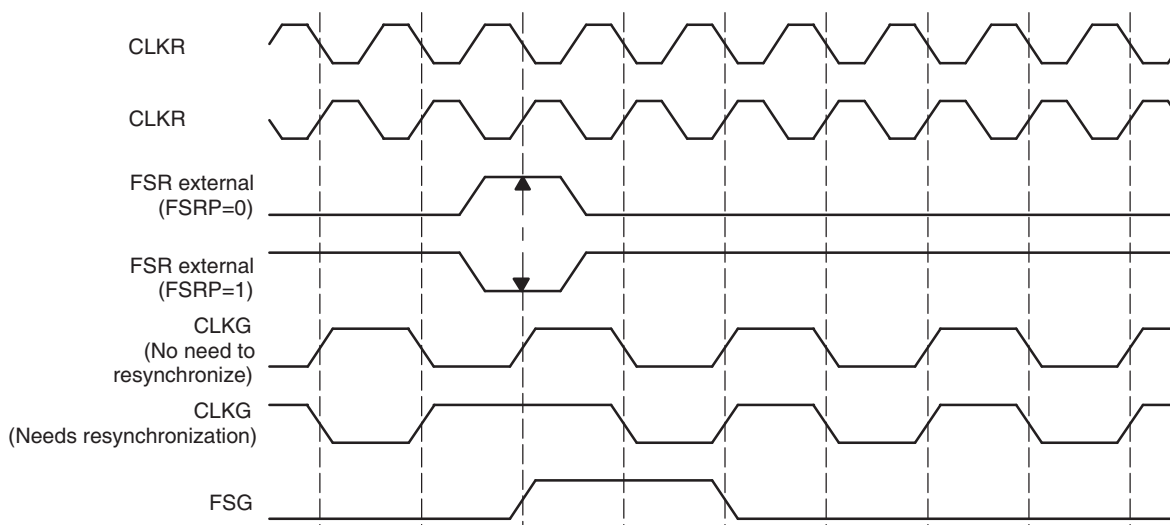
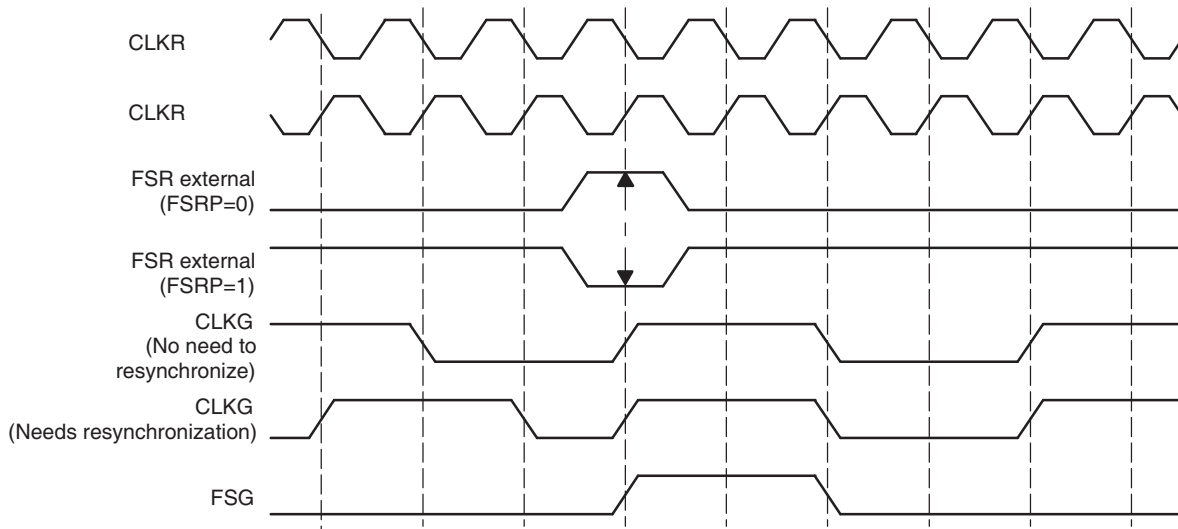

Figure 3-4. CLKG Synchronization and FSG Generation When GSYNC = 1 and CLKGDV = 3



3.4 Reset and Initialization Procedure for the Sample Rate Generator

To reset and initialize the sample rate generator:

Step 1. Place the McBSP/sample rate generator in reset.

During a DSP reset, the sample rate generator, the receiver, and the transmitter reset bits (GRST, RRST, and XRST) are automatically forced to 0. Otherwise, during normal operation, the sample rate generator can be reset by making GRST = 0 in SPCR2, provided that CLKG and/or FSG is not used by any portion of the McBSP. Depending on your system you may also want to reset the receiver (RRST = 0 in SPCR1) and reset the transmitter (XRST = 0 in SPCR2).

If GRST = 0 due to a device reset, CLKG is driven by the CPU clock divided by 2, and FSG is driven inactive-low. If GRST = 0 due to program code, CLKG and FSG are driven low (inactive).

Step 2. Program the registers that affect the sample rate generator.

Program the sample rate generator registers (SRGR1 and SRGR2) as required for your application. If necessary, other control registers can be loaded with desired values, provided the respective portion of the McBSP (the receiver or transmitter) is in reset.

After the sample rate generator registers are programmed, wait 2 CLKSRG cycles. This ensures proper synchronization internally.

Step 3. Enable the sample rate generator (take it out of reset).

In SPCR2, make GRST = 1 to enable the sample rate generator.

After the sample rate generator is enabled, wait two CLKG cycles for the sample rate generator logic to stabilize.

On the next rising edge of CLKSRG, CLKG transitions to 1 and starts clocking with a frequency equal to .

Table 3-4. Input Clock Selection for Sample Rate Generator

SCLKME	CLKSM	Input Clock for Sample Rate Generator
0	0	Reserved
0	1	LSPCLK
1	0	Signal on MCLKR pin
1	1	Signal on MCLKX pin

Step 4. If necessary, enable the receiver and/or the transmitter.

If necessary, remove the receiver and/or transmitter from reset by setting RRST and/or XRST = 1.

Step 5. If necessary, enable the frame-synchronization logic of the sample rate generator.

After the required data acquisition setup is done (DXR[1,2] is loaded with data), set GRST = 1 in SPCR2 if an internally generated frame-synchronization pulse is required. FSG is generated with an active-high edge after the programmed number of CLKG clocks (FPER + 1) have elapsed.

Equation 2: CLKG Frequency

$$\text{CLKG frequency} = \frac{\text{Input clock frequency}}{(\text{CLKGDV} + 1)}$$

where the input clock is selected with the SCLKME bit of PCR and the CLKSM bit of SRGR2 in one of the configurations shown in [Table 3-4](#).

McBSP Exception/Error Conditions

This chapter describes exception/error conditions and how to handle them.

Topic	Page
4.1 Types of Errors	40
4.2 Overrun in the Receiver	40
4.3 Unexpected Receive Frame-Synchronization Pulse	41
4.4 Overwrite in the Transmitter	44
4.5 Underflow in the Transmitter	44
4.6 Unexpected Transmit Frame-Synchronization Pulse	45

4.1 Types of Errors

There are five serial port events that can constitute a system error:

- Receiver overrun (RFULL = 1)
This occurs when DRR1 has not been read since the last RBR-to-DRR copy. Consequently, the receiver does not copy a new word from the RBR(s) to the DRR(s) and the RSR(s) are now full with another new word shifted in from DR. Therefore, RFULL = 1 indicates an error condition wherein any new data that can arrive at this time on DR replaces the contents of the RSR(s), and the previous word is lost. The RSRs continue to be overwritten as long as new data arrives on DR and DRR1 is not read. For more details about overrun in the receiver, see [Section 4.2](#).
- Unexpected receive frame-synchronization pulse (RSYNCERR = 1)
This occurs during reception when RFIG = 0 and an unexpected frame-synchronization pulse occurs. An unexpected frame-synchronization pulse is one that begins the next frame transfer before all the bits of the current frame have been received. Such a pulse causes data reception to abort and restart. If new data has been copied into the RBR(s) from the RSR(s) since the last RBR-to-DRR copy, this new data in the RBR(s) is lost. This is because no RBR-to-DRR copy occurs; the reception has been restarted. For more details about receive frame-synchronization errors, see [Section 4.3](#).
- Transmitter data overwrite
This occurs when the CPU or DMA controller overwrites data in the DXR(s) before the data is copied to the XSR(s). The overwritten data never reaches the DX pin. For more details about overwrite in the transmitter, see [Section 4.4](#).
- Transmitter underflow ($\overline{\text{XEMPTY}} = 0$)
If a new frame-synchronization signal arrives before new data is loaded into DXR1, the previous data in the DXR(s) is sent again. This procedure continues for every new frame-synchronization pulse that arrives until DXR1 is loaded with new data. For more details about underflow in the transmitter, see [Section 4.5](#).
- Unexpected transmit frame-synchronization pulse (XSYNCERR = 1)
This occurs during transmission when XFIG = 0 and an unexpected frame-synchronization pulse occurs. An unexpected frame-synchronization pulse is one that begins the next frame transfer before all the bits of the current frame have been transferred. Such a pulse causes the current data transmission to abort and restart. If new data has been written to the DXR(s) since the last DXR-to-XSR copy, the current value in the XSR(s) is lost. For more details about transmit frame-synchronization errors, see [Section 4.6](#).

4.2 Overrun in the Receiver

RFULL = 1 in SPCR1 indicates that the receiver has experienced overrun and is in an error condition. RFULL is set when all of the following conditions are met:

1. DRR1 has not been read since the last RBR-to-DRR copy (RRDY = 1).
2. RBR1 is full and an RBR-to-DRR copy has not occurred.
3. RSR1 is full and an RSR1-to-RBR copy has not occurred.

As described in the [Section 2.5, McBSP Reception](#), data arriving on DR is continuously shifted into RSR1 (for word length of 16 bits or smaller) or RSR2 and RSR1 (for word length larger than 16 bits). Once a complete word is shifted into the RSR(s), an RSR-to-RBR copy can occur only if the previous data in RBR1 has been copied to DRR1. The RRDY bit is set when new data arrives in DRR1 and is cleared when that data is read from DRR1. Until RRDY = 0, the next RBR-to-DRR copy does not take place, and the data is held in the RSR(s). New data arriving on the DR pin is shifted into RSR(s), and the previous content of the RSR(s) is lost.

You can prevent the loss of data if DRR1 is read no later than 2.5 cycles before the end of the third word is shifted into the RSR1.

NOTE: If both DRRs are needed (word length larger than 16 bits), the CPU or the DMA controller must read from DRR2 first and then from DRR1. As soon as DRR1 is read, the next RBR-to-DRR copy is initiated. If DRR2 is not read first, the data in DRR2 is lost.

After the receiver starts running from reset, a minimum of three words must be received before RFULL is set. Either of the following events clears the RFULL bit and allows subsequent transfers to be read properly:

- The CPU or DMA controller reads DRR1.
- The receiver is reset individually (RRST = 0) or as part of a device reset.

Another frame-synchronization pulse is required to restart the receiver.

4.2.1 Example of Overrun Condition

Figure 4-1 shows the receive overrun condition. Because serial word A is not read from DRR1 before serial word B arrives in RBR1, B is not transferred to DRR1 yet. Another new word © arrives and RSR1 is full with this data. DRR1 is finally read, but not earlier than 2.5 cycles before the end of word C. Therefore, new data (D) overwrites word C in RSR1. If DRR1 is not read in time, the next word can overwrite D.

Figure 4-1. Overrun in the McBSP Receiver

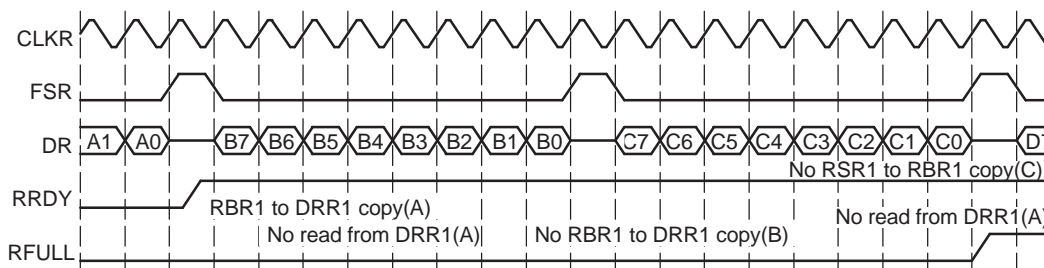

4.2.2 Example of Preventing Overrun Condition

Figure 4-2 shows the case where RFULL is set, but the overrun condition is prevented by a read from DRR1 at least 2.5 cycles before the next serial word © is completely shifted into RSR1. This ensures that an RBR1-to-DRR1 copy of word B occurs before receiver attempts to transfer word C from RSR1 to RBR1.

Figure 4-2. Overrun Prevented in the McBSP Receiver

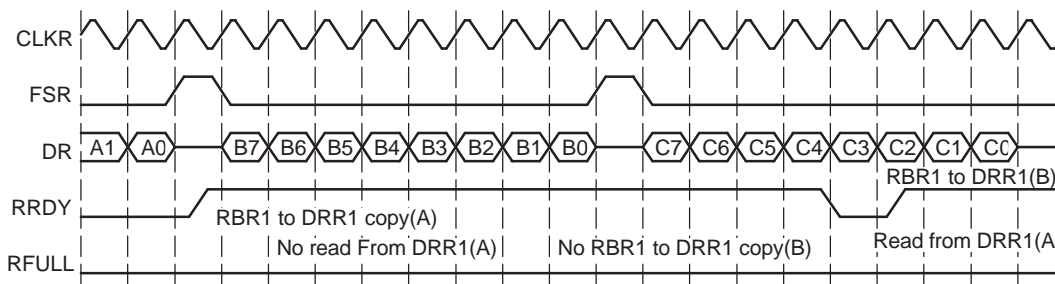

4.3 Unexpected Receive Frame-Synchronization Pulse

Section 4.3.1 shows how the McBSP responds to any receive frame-synchronization pulses, including an unexpected pulse. Section 4.3.2 and Section 4.3.3 show an examples of a frame-synchronization error and an example of how to prevent such an error, respectively.

4.3.1 Possible Responses to Receive Frame-Synchronization Pulses

Figure 4-3 shows the decision tree that the receiver uses to handle all incoming frame-synchronization pulses. The figure assumes that the receiver has been started (RRST = 1 in SPCR1). Case 3 in the figure is the case in which an error occurs.

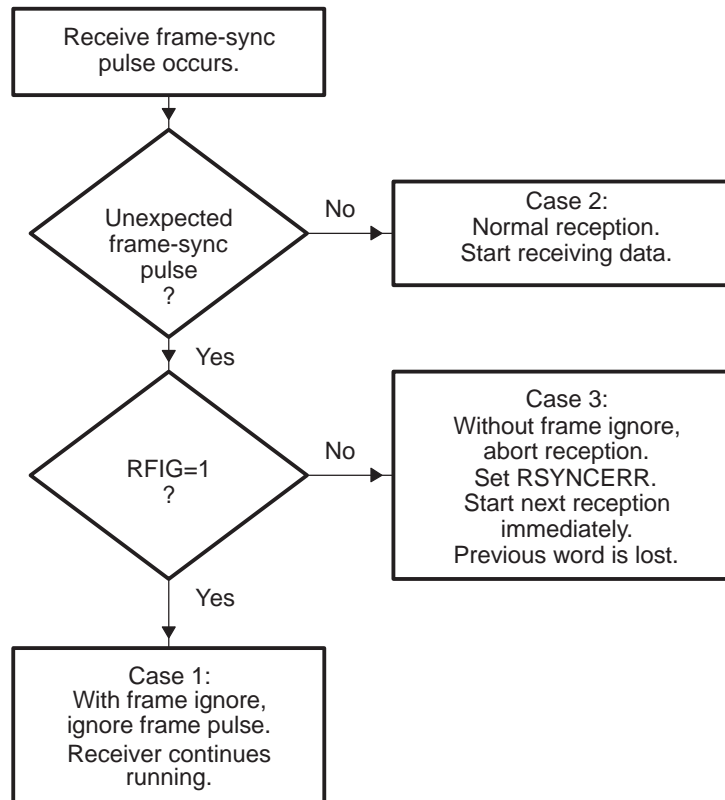
Figure 4-3. Possible Responses to Receive Frame-Synchronization Pulses

Any one of three cases can occur:

- Case 1: Unexpected internal FSR pulses with RFIG = 1 in RCR2. Receive frame-synchronization pulses are ignored, and the reception continues.
- Case 2: Normal serial port reception. Reception continues normally because the frame-synchronization pulse is not unexpected. There are three possible reasons why a receive operation might *not* be in progress when the pulse occurs:
 - The FSR pulse is the first after the receiver is enabled (RRST = 1 in SPCR1).
 - The FSR pulse is the first after DRR[1,2] is read, clearing a receiver full (RFULL = 1 in SPCR1) condition.
 - The serial port is in the interpacket intervals. The programmed data delay for reception (programmed with the RDATDLY bits in RCR2) may start during these interpacket intervals for the first bit of the next word to be received. Thus, at maximum frame frequency, frame synchronization can still be received 0 to 2 clock cycles before the first bit of the synchronized frame.
- Case 3: Unexpected receive frame synchronization with RFIG = 0 (frame-synchronization pulses not ignored). Unexpected frame-synchronization pulses can originate from an external source or from the internal sample rate generator.

If a frame-synchronization pulse starts the transfer of a new frame before the current frame is fully received, this pulse is treated as an unexpected frame-synchronization pulse, and the receiver sets the receive frame-synchronization error bit (RSYNCERR) in SPCR1. RSYNCERR can be cleared only by a receiver reset or by a write of 0 to this bit.

If you want the McBSP to notify the CPU of receive frame-synchronization errors, you can set a special receive interrupt mode with the RINTM bits of SPCR1. When RINTM = 11b, the McBSP sends a receive interrupt (RINT) request to the CPU each time that RSYNCERR is set.

4.3.2 Example of Unexpected Receive Frame-Synchronization Pulse

Figure 4-4 shows an unexpected receive frame-synchronization pulse during normal operation of the serial port, with time intervals between data packets. When the unexpected frame-synchronization pulse occurs, the RSYNCERR bit is set, the reception of data B is aborted, and the reception of data C begins. In addition, if RINTM = 11b, the McBSP sends a receive interrupt (RINT) request to the CPU.

Figure 4-4. An Unexpected Frame-Synchronization Pulse During a McBSP Reception

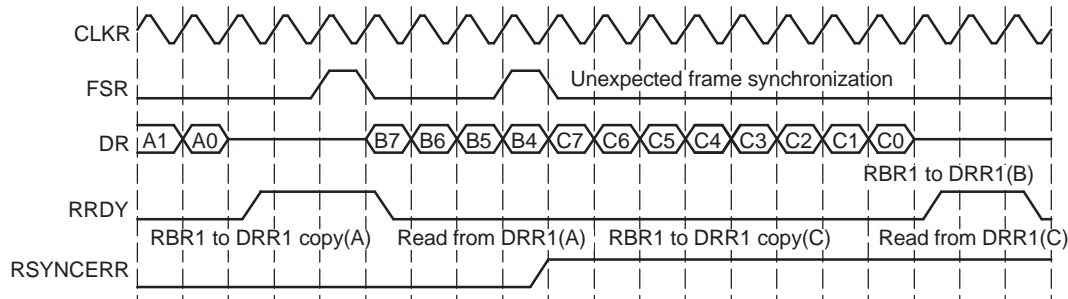

4.3.3 Preventing Unexpected Receive Frame-Synchronization Pulses

Each frame transfer can be delayed by 0, 1, or 2 MCLKR cycles, depending on the value in the RDATDLY bits of RCR2. For each possible data delay, Figure 4-5 shows when a new frame-synchronization pulse on FSR can safely occur relative to the last bit of the current frame.

Figure 4-5. Proper Positioning of Frame-Synchronization Pulses

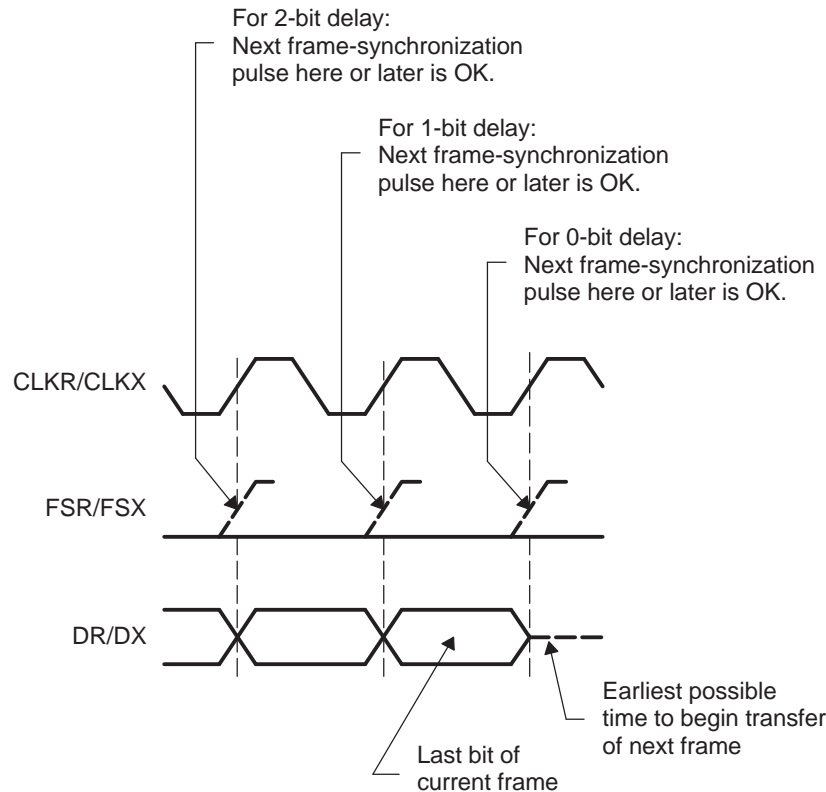

4.4 Overwrite in the Transmitter

As described in the section on McBSP transmission (page Section 2.6), the transmitter must copy the data previously written to the DXR(s) by the CPU or DMA controller into the XSR(s) and then shift each bit from the XSR(s) to the DX pin. If new data is written to the DXR(s) before the previous data is copied to the XSR(s), the previous data in the DXR(s) is overwritten and thus lost.

4.4.1 Example of Overwrite Condition

Figure 4-6 shows what happens if the data in DXR1 is overwritten before being transmitted. Initially, DXR1 is loaded with data C. A subsequent write to DXR1 overwrites C with D before C is copied to XSR1. Thus, C is never transmitted on DX.

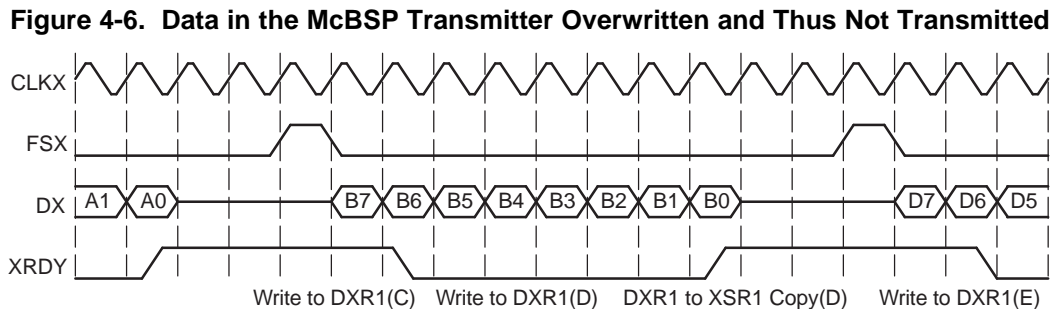

4.4.2 Preventing Overwrites

You can prevent CPU overwrites by making the CPU:

- Poll for XRDY = 1 in SPCR2 before writing to the DXR(s). XRDY is set when data is copied from DXR1 to XSR1 and is cleared when new data is written to DXR1.
- Wait for a transmit interrupt (XINT) before writing to the DXR(s). When XINTM = 00b in SPCR2, the transmitter sends XINT to the CPU each time XRDY is set.

You can prevent DMA overwrites by synchronizing DMA transfers to the transmit synchronization event XEVT. The transmitter sends an XEVT signal each time XRDY is set.

4.5 Underflow in the Transmitter

The McBSP indicates a transmitter empty (or underflow) condition by clearing the $\overline{\text{XEMPTY}}$ bit in SPCR2. Either of the following events activates $\overline{\text{XEMPTY}}$ (XEMPTY = 0):

- DXR1 has not been loaded since the last DXR-to-XSR copy, and all bits of the data word in the XSR(s) have been shifted out on the DX pin.
- The transmitter is reset (by forcing XRST = 0 in SPCR2, or by a device reset) and is then restarted.

In the underflow condition, the transmitter continues to transmit the old data that is in the DXR(s) for every new transmit frame-synchronization signal until a new value is loaded into DXR1 by the CPU or the DMA controller.

NOTE: If both DXRs are needed (word length larger than 16 bits), the CPU or the DMA controller must load DXR2 first and then load DXR1. As soon as DXR1 is loaded, the contents of both DXRs are copied to the transmit shift registers (XSRs). If DXR2 is not loaded first, the previous content of DXR2 is passed to the XSR2.

XEMPTY is deactivated (XEMPTY = 1) when a new word in DXR1 is transferred to XSR1. If FSXM = 1 in PCR and FSGM = 0 in SRGR2, the transmitter generates a single internal FSX pulse in response to a DXR-to-XSR copy. Otherwise, the transmitter waits for the next frame-synchronization pulse before sending out the next frame on DX.

When the transmitter is taken out of reset (XRST = 1), it is in a transmitter ready (XRDY = 1 in SPCR2)

and transmitter empty (XEMPTY = 0) state. If DXR1 is loaded by the CPU or the DMA controller before internal FSX goes active high, a valid DXR-to-XSR transfer occurs. This allows for the first word of the first frame to be valid even before the transmit frame-synchronization pulse is generated or detected. Alternatively, if a transmit frame-synchronization pulse is detected before DXR1 is loaded, zeros are output on DX.

4.5.1 Example of the Underflow Condition

Figure 4-7 shows an underflow condition. After B is transmitted, DXR1 is not reloaded before the subsequent frame-synchronization pulse. Thus, B is again transmitted on DX.

Figure 4-7. Underflow During McBSP Transmission

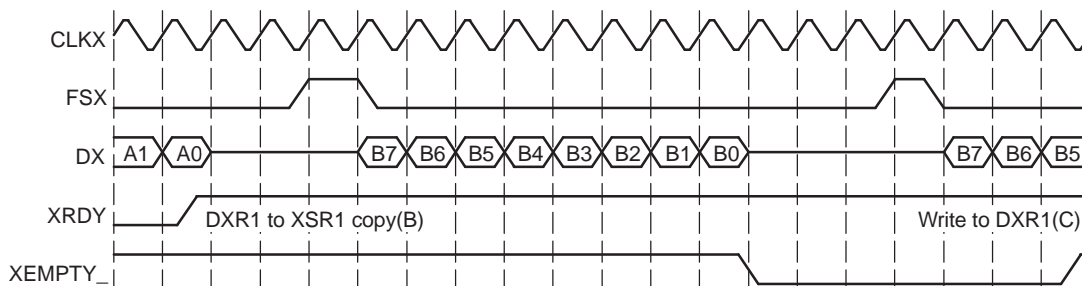

4.5.2 Example of Preventing Underflow Condition

Figure 4-8 shows the case of writing to DXR1 just before an underflow condition would otherwise occur. After B is transmitted, C is written to DXR1 before the next frame-synchronization pulse. As a result, there is no underflow; B is not transmitted twice.

Figure 4-8. Underflow Prevented in the McBSP Transmitter

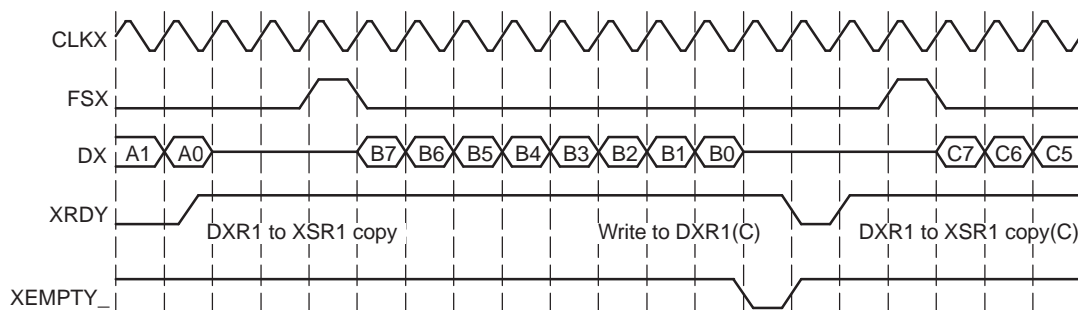

4.6 Unexpected Transmit Frame-Synchronization Pulse

Section 4.6.1 shows how the McBSP responds to any transmit frame-synchronization pulses, including an unexpected pulse. Section 4.6.2 and Section 4.6.3 show examples of a frame-synchronization error and an example of how to prevent such an error, respectively.

4.6.1 Possible Responses to Transmit Frame-Synchronization Pulses

Figure 4-9 shows the decision tree that the transmitter uses to handle all incoming frame-synchronization pulses. The figure assumes that the transmitter has been started (XRST = 1 in SPCR2). Case 3 in the figure is the case in which an error occurs.

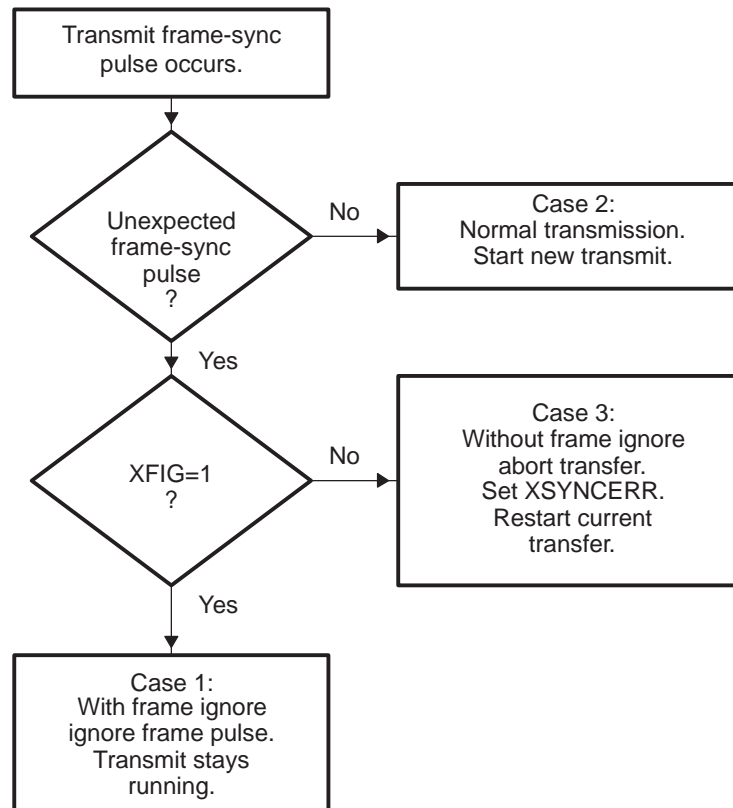
Figure 4-9. Possible Responses to Transmit Frame-Synchronization Pulses

Any one of three cases can occur:

- Case 1: Unexpected internal FSX pulses with XFIG = 1 in XCR2. Transmit frame-synchronization pulses are ignored, and the transmission continues.
- Case 2: Normal serial port transmission. Transmission continues normally because the frame-synchronization pulse is not unexpected. There are two possible reasons why a transmit operations might *not* be in progress when the pulse occurs:

This FSX pulse is the first after the transmitter is enabled (XRST = 1).

The serial port is in the interpacket intervals. The programmed data delay for transmission (programmed with the XDATDLY bits of XCR2) may start during these interpacket intervals before the first bit of the previous word is transmitted. Thus, at maximum packet frequency, frame synchronization can still be received 0 to 2 clock cycles before the first bit of the synchronized frame.

- Case 3: Unexpected transmit frame synchronization with XFIG = 0 (frame-synchronization pulses not ignored). Unexpected frame-synchronization pulses can originate from an external source or from the internal sample rate generator.

If a frame-synchronization pulse starts the transfer of a new frame before the current frame is fully transmitted, this pulse is treated as an unexpected frame-synchronization pulse, and the transmitter sets the transmit frame-synchronization error bit (XSYNCERR) in SPCR2. XSYNCERR can be cleared only by a transmitter reset or by a write of 0 to this bit.

If you want the McBSP to notify the CPU of frame-synchronization errors, you can set a special transmit interrupt mode with the XINTM bits of SPCR2. When XINTM = 11b, the McBSP sends a transmit interrupt (XINT) request to the CPU each time that XSYNCERR is set.

4.6.2 Example of Unexpected Transmit Frame-Synchronization Pulse

Figure 4-10 shows an unexpected transmit frame-synchronization pulse during normal operation of the serial port with intervals between the data packets. When the unexpected frame-synchronization pulse occurs, the XSYNCERR bit is set and the transmission of data B is restarted because no new data has been passed to XSR1 yet. In addition, if XINTM = 11b, the McBSP sends a transmit interrupt (XINT) request to the CPU.

Figure 4-10. An Unexpected Frame-Synchronization Pulse During a McBSP Transmission

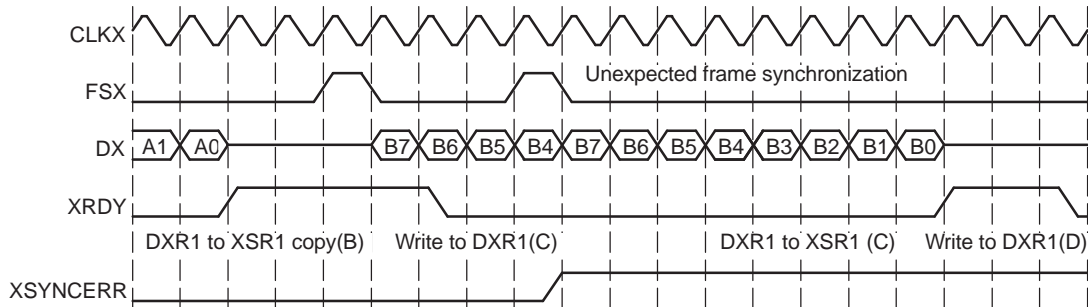

4.6.3 Preventing Unexpected Transmit Frame-Synchronization Pulses

Each frame transfer can be delayed by 0, 1, or 2 CLKX cycles, depending on the value in the XDATDLY bits of XCR2. For each possible data delay, Figure 4-11 shows when a new frame-synchronization pulse on FSX can safely occur relative to the last bit of the current frame.

Figure 4-11. Proper Positioning of Frame-Synchronization Pulses

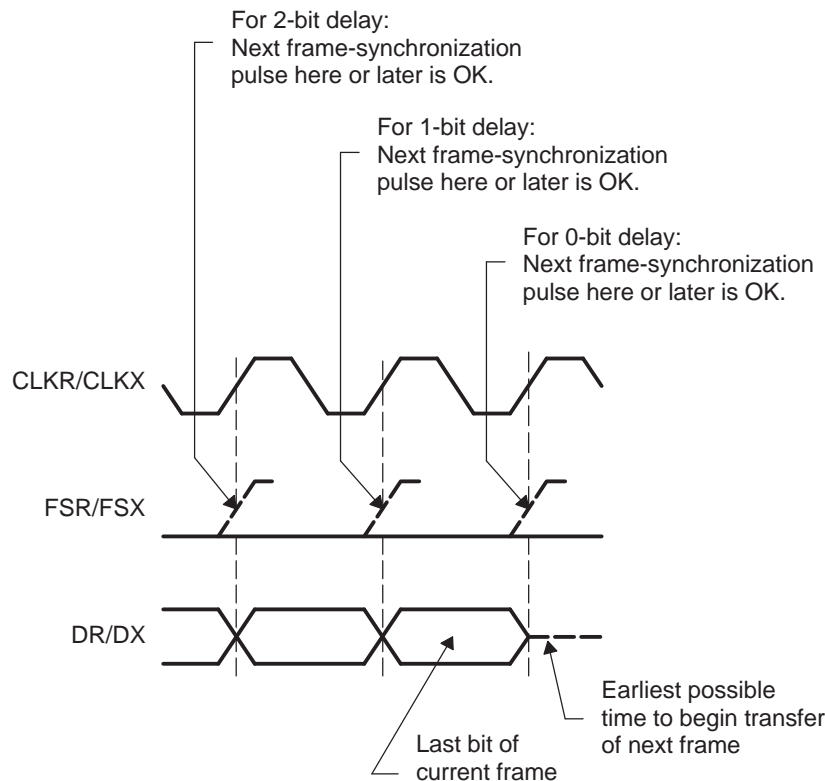

Multichannel Selection Modes

This section discusses the multichannel selection modes for the McBSP.

Topic	Page
5.1 Channels, Blocks, and Partitions	50
5.2 Multichannel Selection	51
5.3 Configuring a Frame for Multichannel Selection	51
5.4 Using Two Partitions	51
5.5 Using Eight Partitions	53
5.6 Receive Multichannel Selection Mode	54
5.7 Transmit Multichannel Selection Modes	54
5.8 Using Interrupts Between Block Transfers	56

5.1 Channels, Blocks, and Partitions

A McBSP channel is a time slot for shifting in/out the bits of one serial word. Each McBSP supports up to 128 channels for reception and 128 channels for transmission.

In the receiver and in the transmitter, the 128 available channels are divided into eight blocks that each contain 16 contiguous channels (see [Table 5-1](#) through [Table 5-3](#)) :

- It is possible to have two receive partitions (A & B) and 8 transmit partitions (A – H).
- McBSP can transmit/receive on selected channels.
- Each channel partition has a dedicated channel-enable register. Each bit controls whether data flow is allowed or prevented in one of the channels assigned to that partition.
- There are three transmit multichannel modes and one receive multichannel mode.

Table 5-1. Block - Channel Assignment

Block	Channels
0	0 -15
1	16 - 31
2	32 - 47
3	48 - 63
4	64 - 79
5	80 - 95
6	96 - 111
7	112 - 127

The blocks are assigned to partitions according to the selected partition mode. In the two-partition mode (described in [Section 5.4](#)), you assign one even-numbered block (0, 2, 4, or 6) to partition A and one odd-numbered block (1, 3, 5, or 7) to partition B. In the 8-partition mode (described in [Section 5.5](#)), blocks 0 through 7 are automatically assigned to partitions, A through H, respectively.

Table 5-2. 2-Partition Mode

Partition	Blocks
A	0 or 2 or 4 or 6
B	1 or 3 or 5 or 7

Table 5-3. 8-Partition mode

Partition	Blocks	Channels
A	0	0 -15
B	1	16 - 31
C	2	32 - 47
D	3	48 - 63
E	4	64 - 79
F	5	80 - 95
G	6	96 - 111
H	7	112 - 127

The number of partitions for reception and the number of partitions for transmission are independent. For example, it is possible to use two receive partitions (A and B) and eight transmit partitions (A-H).

5.2 Multichannel Selection

When a McBSP uses a time-division multiplexed (TDM) data stream while communicating with other McBSPs or serial devices, the McBSP may need to receive and/or transmit on only a few channels. To save memory and bus bandwidth, you can use a multichannel selection mode to prevent data flow in some of the channels.

Each channel partition has a dedicated channel enable register. If the appropriate multichannel selection mode is on, each bit in the register controls whether data flow is allowed or prevented in one of the channels that is assigned to that partition.

The McBSP has one receive multichannel selection mode (described in [Section 5.6](#)) and three transmit multichannel selection modes (described in [Section 5.7](#)).

5.3 Configuring a Frame for Multichannel Selection

Before you enable a multichannel selection mode, make sure you properly configure the data frame:

- Select a single-phase frame (RPHASE/XPHASE = 0). Each frame represents a TDM data stream.
- Set a frame length (in RFRLN1/XFRLN1) that includes the highest-numbered channel to be used. For example, if you plan to use channels 0, 15, and 39 for reception, the receive frame length must be at least 40 (RFRLN1 = 39). If XFRLN1 = 39 in this case, the receiver creates 40 time slots per frame but only receives data during time slots 0, 15, and 39 of each frame.

5.4 Using Two Partitions

For multichannel selection operation in the receiver and/or the transmitter, you can use two partitions or eight partitions (described in [Section 5.5](#)). If you choose the 2-partition mode (RMCME = 0 for reception, XMCME = 0 for transmission), McBSP channels are activated using an alternating scheme. In response to a frame-synchronization pulse, the receiver or transmitter begins with the channels in partition A and then alternates between partitions B and A until the complete frame has been transferred. When the next frame-synchronization pulse occurs, the next frame is transferred beginning with the channels in partition A.

5.4.1 Assigning Blocks to Partitions A and B

For reception, any two of the eight receive-channel blocks can be assigned to receive partitions A and B, which means up to 32 receive channels can be enabled at any given point in time. Similarly, any two of the eight transmit-channel blocks (up to 32 enabled transmit channels) can be assigned to transmit partitions A and B.

For reception:

- Assign an even-numbered channel block (0, 2, 4, or 6) to receive partition A by writing to the RPABLK bits. In the receive multichannel selection mode (described in [Section 5.6](#)), the channels in this partition are controlled by receive channel enable register A (RCERA).
- Assign an odd-numbered block (1, 3, 5, or 7) to receive partition B with the RPBBLK bits. In the receive multichannel selection mode, the channels in this partition are controlled by receive channel enable register B (RCERB).

For transmission:

- Assign an even-numbered channel block (0, 2, 4, or 6) to transmit partition A by writing to the XPABLK bits. In one of the transmit multichannel selection modes (described in [Section 5.7](#)), the channels in this partition are controlled by transmit channel enable register A (XCERA).
- Assign an odd-numbered block (1, 3, 5, or 7) to transmit partition B with the XPBBLK bits. In one of the transmit multichannel selection modes, the channels in this partition are controlled by transmit channel enable register B (XCERB).

Figure 5-1 shows an example of alternating between the channels of partition A and the channels of partition B. Channels 0-15 have been assigned to partition A, and channels 16-31 have been assigned to partition B. In response to a frame-synchronization pulse, the McBSP begins a frame transfer with partition A and then alternates between partitions B and A until the complete frame is transferred.

Figure 5-1. Alternating Between the Channels of Partition A and the Channels of Partition B

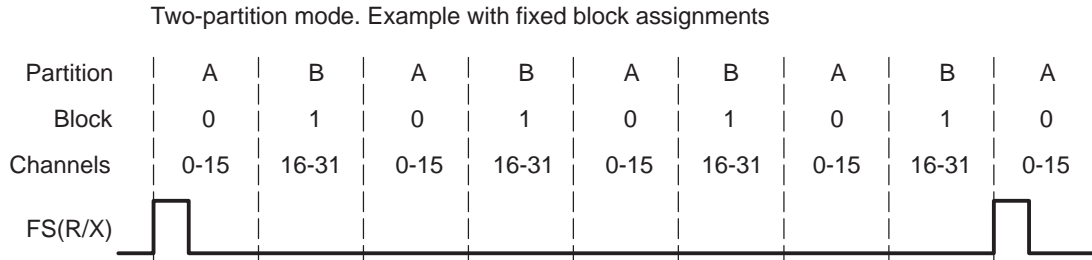

As explained in [Section 5.4.2](#), you can dynamically change which blocks of channels are assigned to the partitions.

5.4.2 Reassigning Blocks During Reception/Transmission

If you want to use more than 32 channels, you can change which channel blocks are assigned to partitions A and B during the course of a data transfer. However, these changes must be carefully timed. While a partition is being transferred, its associated block assignment bits cannot be modified and its associated channel enable register cannot be modified. For example, if block 3 is being transferred and block 3 is assigned to partition A, you can modify neither (R/X)PABLK to assign different channels to partition A nor (R/X)CERA to change the channel configuration for partition A.

Several features of the McBSP help you time the reassignment:

- The block of channels currently involved in reception/transmission (the current block) is reflected in the RCBLK/XCBLK bits. Your program can poll these bits to determine which partition is active. When a partition is not active, it is safe to change its block assignment and channel configuration.
- At the end of every block (at the boundary of two partitions), an interrupt can be sent to the CPU. In response to the interrupt, the CPU can then check the RCBLK/XCBLK bits and update the inactive partition. See [Section 5.8, Using Interrupts Between Block Transfers](#).

Figure 5-2 shows an example of reassigning channels throughout a data transfer. In response to a frame-synchronization pulse, the McBSP alternates between partitions A and B. Whenever partition B is active, the CPU changes the block assignment for partition A. Whenever partition A is active, the CPU changes the block assignment for partition B.

Figure 5-2. Reassigning Channel Blocks Throughout a McBSP Data Transfer

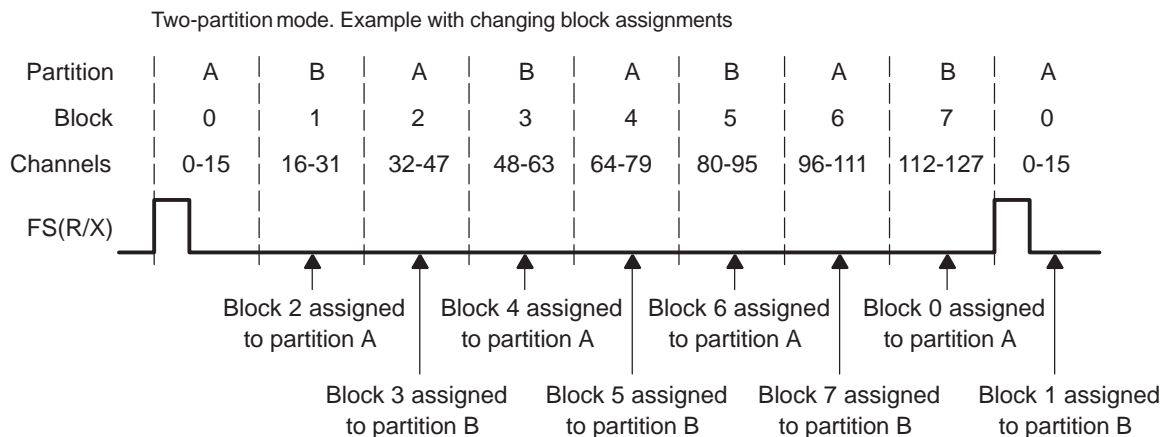

5.5 Using Eight Partitions

For multichannel selection operation in the receiver and/or the transmitter, you can use eight partitions or two partitions (described in [Section 5.4](#)). If you choose the 8-partition mode (RMCME = 1 for reception, XMCME = 1 for transmission), McBSP channels are activated in the following order: A, B, C, D, E, F, G, H. In response to a frame-synchronization pulse, the receiver or transmitter begins with the channels in partition A and then continues with the other partitions in order until the complete frame has been transferred. When the next frame-synchronization pulse occurs, the next frame is transferred, beginning with the channels in partition A.

In the 8-partition mode, the (R/X)PABLK and (R/X)PBBLK bits are ignored and the 16-channel blocks are assigned to the partitions as shown in [Table 5-4](#) and [Table 5-5](#). These assignments cannot be changed. The tables also show the registers used to control the channels in the partitions.

Table 5-4. Receive Channel Assignment and Control With Eight Receive Partitions

Receive Partition	Assigned Block of Receive Channels	Register Used For Channel Control
A	Block 0: channels 0 through 15	RCERA
B	Block 1: channels 16 through 31	RCERB
C	Block 2: channels 32 through 47	RCERC
D	Block 3: channels 48 through 63	RCERD
E	Block 4: channels 64 through 79	RCERE
F	Block 5: channels 80 through 95	RCERF
G	Block 6: channels 96 through 111	RCERG
H	Block 7: channels 112 through 127	RCERH

Table 5-5. Transmit Channel Assignment and Control When Eight Transmit Partitions Are Used

Transmit Partition	Assigned Block of Transmit Channels	Register Used For Channel Control
A	Block 0: channels 0 through 15	XCERA
B	Block 1: channels 16 through 31	XCERB
C	Block 2: channels 32 through 47	XCERC
D	Block 3: channels 48 through 63	XCERD
E	Block 4: channels 64 through 79	XCERE
F	Block 5: channels 80 through 95	XCERF
G	Block 6: channels 96 through 111	XCERG
H	Block 7: channels 112 through 127	XCERH

Figure 5-3 shows an example of the McBSP using the 8-partition mode. In response to a frame-synchronization pulse, the McBSP begins a frame transfer with partition A and then activates B, C, D, E, F, G, and H to complete a 128-word frame.

Figure 5-3. McBSP Data Transfer in the 8-Partition Mode

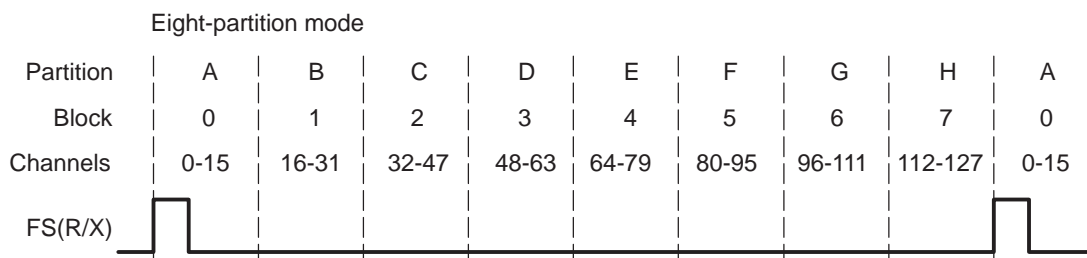

5.6 Receive Multichannel Selection Mode

The RMCME bit of MCR1 determines whether all channels or only selected channels are enabled for reception. When RMCME = 0, all 128 receive channels are enabled and cannot be disabled. When RMCME = 1, the receive multichannel selection mode is enabled. In this mode:

- Channels can be individually enabled or disabled. The only channels enabled are those selected in the appropriate receive channel enable registers (RCERs). The way channels are assigned to the RCERs depends on the number of receive channel partitions (2 or 8), as defined by the RMCME bit of MCR1.
- If a receive channel is disabled, any bits received in that channel are passed only as far as the receive buffer register(s) (RBR(s)). The receiver does not copy the content of the RBR(s) to the DRR(s), and as a result, does not set the receiver ready bit (RRDY). Therefore, no DMA synchronization event (REVT) is generated and, if the receiver interrupt mode depends on RRDY (RINTM = 00b), no interrupt is generated.

As an example of how the McBSP behaves in the receive multichannel selection mode, suppose you enable only channels 0, 15, and 39 and that the frame length is 40. The McBSP:

1. Accepts bits shifted in from the DR pin in channel 0
2. Ignores bits received in channels 1-14
3. Accepts bits shifted in from the DR pin in channel 15
4. Ignores bits received in channels 16-38
5. Accepts bits shifted in from the DR pin in channel 39

5.7 Transmit Multichannel Selection Modes

The XMCM bits of XCR2 determine whether all channels or only selected channels are enabled and unmasked for transmission. More details on enabling and masking are in Section 5.7.1. The McBSP has three transmit multichannel selection modes (XMCM = 01b, XMCM = 10b, and XMCM = 11b), which are described in the following table.

Table 5-6. Selecting a Transmit Multichannel Selection Mode With the XMCM Bits

XMCM	Transmit Multichannel Selection Mode
00b	No transmit multichannel selection mode is on. All channels are enabled and unmasked. No channels can be disabled or masked.
01b	All channels are disabled unless they are selected in the appropriate transmit channel enable registers (XCERs). If enabled, a channel in this mode is also unmasked. The XMCM bit of MCR2 determines whether 32 channels or 128 channels are selectable in XCERs.
10b	All channels are enabled, but they are masked unless they are selected in the appropriate transmit channel enable registers (XCERs). The XMCM bit of MCR2 determines whether 32 channels or 128 channels are selectable in XCERs.
11b	This mode is used for symmetric transmission and reception. All channels are disabled for transmission unless they are enabled for reception in the appropriate receive channel enable registers (RCERs). Once enabled, they are masked unless they are also selected in the appropriate transmit channel enable registers (XCERs). The XMCM bit of MCR2 determines whether 32 channels or 128 channels are selectable in RCERs and XCERs.

As an example of how the McBSP behaves in a transmit multichannel selection mode, suppose that XMCM = 01b (all channels disabled unless individually enabled) and that you have enabled only channels 0, 15, and 39. Suppose also that the frame length is 40. The McBSP:...

1. Shifts data to the DX pin in channel 0
2. Places the DX pin in the high impedance state in channels 1-14
3. Shifts data to the DX pin in channel 15
4. Places the DX pin in the high impedance state in channels 16-38
5. Shifts data to the DX pin in channel 39

5.7.1 Disabling/Enabling Versus Masking/Unmasking

For transmission, a channel can be:

- Enabled and unmasked (transmission can begin and can be completed)
- Enabled but masked (transmission can begin but cannot be completed)
- Disabled (transmission cannot occur)

The following definitions explain the channel control options:

Enabled channel	A channel that can begin transmission by passing data from the data transmit register(s) (DXR(s)) to the transmit shift registers (XSR(s)).
Masked channel	A channel that cannot complete transmission. The DX pin is held in the high impedance state; data cannot be shifted out on the DX pin. In systems where symmetric transmit and receive provides software benefits, this feature allows transmit channels to be disabled on a shared serial bus. A similar feature is not needed for reception because multiple receptions cannot cause serial bus contention.
Disabled channel	A channel that is not enabled. A disabled channel is also masked. Because no DXR-to-XSR copy occurs, the XRDY bit of SPCR2 is not set. Therefore, no DMA synchronization event (XEVT) is generated, and if the transmit interrupt mode depends on XRDY (XINTM = 00b in SPCR2), no interrupt is generated. The XEMPTY bit of SPCR2 is not affected.
Unmasked channel	A channel that is not masked. Data in the XSR(s) is shifted out on the DX pin.

5.7.2 Activity on McBSP Pins for Different Values of XMCM

Figure 5-4 shows the activity on the McBSP pins for the various XMCM values. In all cases, the transmit frame is configured as follows:

- XPHASE = 0: Single-phase frame (required for multichannel selection modes)
- XFRLN1 = 0000011b: 4 words per frame
- XWDLEN1 = 000b: 8 bits per word

- XMCME = 0: 2-partition mode (only partitions A and B used)

In the case where XMCM = 11b, transmission and reception are symmetric, which means the corresponding bits for the receiver (RPHASE, RFLEN1, RWDLEN1, and RMCME) must have the same values as XPHASE, XFLEN1, and XWDLEN1, respectively.

In the figure, the arrows showing where the various events occur are only sample indications. Wherever possible, there is a time window in which these events can occur.

5.8 Using Interrupts Between Block Transfers

When a multichannel selection mode is used, an interrupt request can be sent to the CPU at the end of every 16-channel block (at the boundary between partitions and at the end of the frame). In the receive multichannel selection mode, a receive interrupt (RINT) request is generated at the end of each block transfer if RINTM = 01b. In any of the transmit multichannel selection modes, a transmit interrupt (XINT) request is generated at the end of each block transfer if XINTM = 01b. When RINTM/XINTM = 01b, no interrupt is generated unless a multichannel selection mode is on.

These interrupt pulses are active high and last for two CPU clock cycles.

This type of interrupt is especially helpful if you are using the two-partition mode (described in [Section 5.4](#)) and you want to know when you can assign a different block of channels to partition A or B.

Figure 5-4. Activity on McBSP Pins for the Possible Values of XMCM

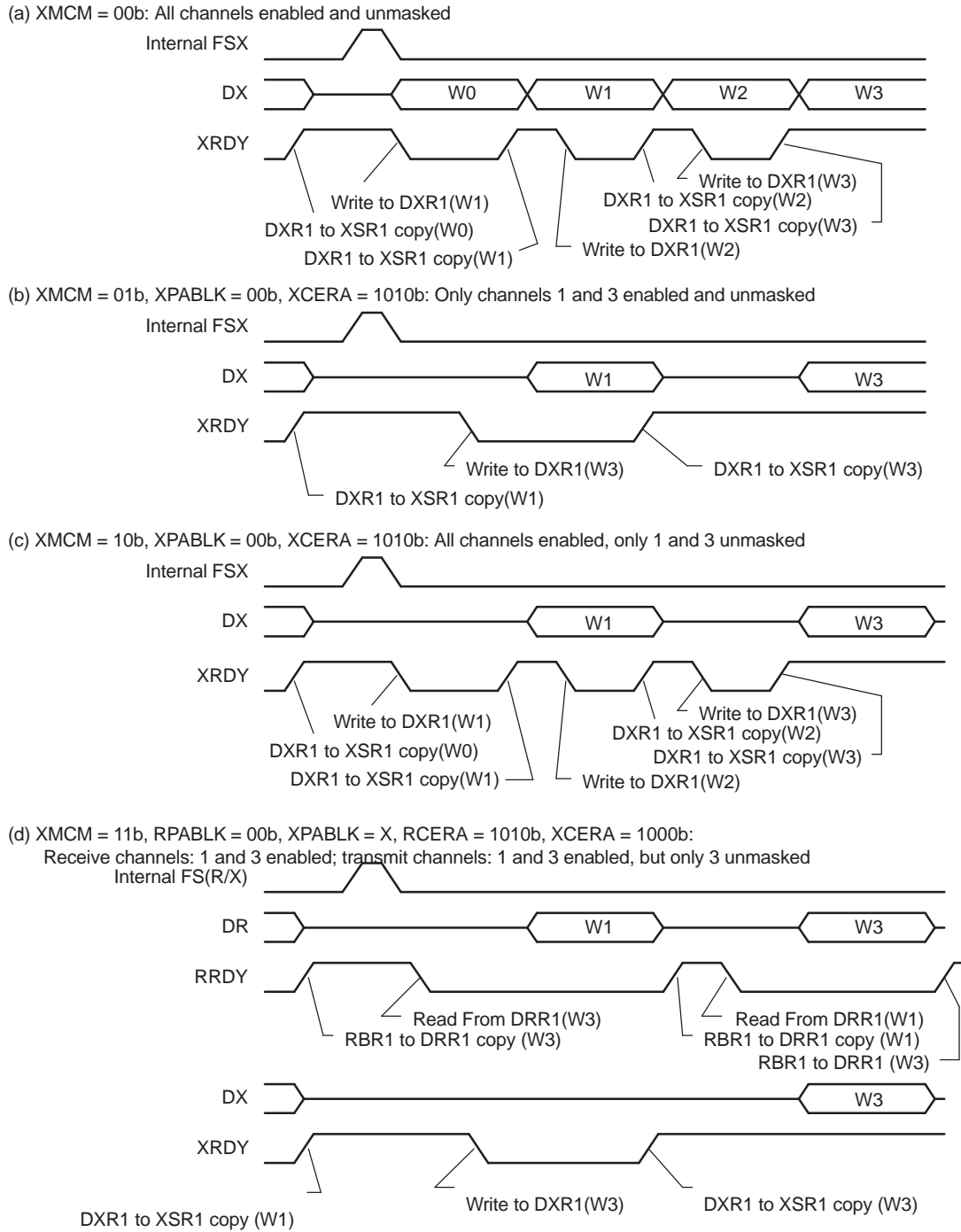

SPI Operation Using the Clock Stop Mode

This chapter explains how to use the McBSP in SPI mode.

Topic	Page
6.1 SPI Protocol	60
6.2 Clock Stop Mode	60
6.3 Bits Used to Enable and Configure the Clock Stop Mode	60
6.4 Clock Stop Mode Timing Diagrams	61
6.5 Procedure for Configuring a McBSP for SPI Operation	63
6.6 McBSP as the SPI Master	63
6.7 McBSP as an SPI Slave	65

6.1 SPI Protocol

The SPI protocol is a master-slave configuration with one master device and one or more slave devices. The interface consists of the following four signals:

- Serial data input (also referred to as master in/slave out, or SPISOMI)
- Serial data output (also referred to as master out/slave in, or SPISIMO)
- Shift-clock (also referred to as SPICLK)
- Slave-enable signal (also referred to as $\overline{\text{SPISTE}}$)

A typical SPI interface with a single slave device is shown in [Figure 6-1](#).

Figure 6-1. Typical SPI Interface

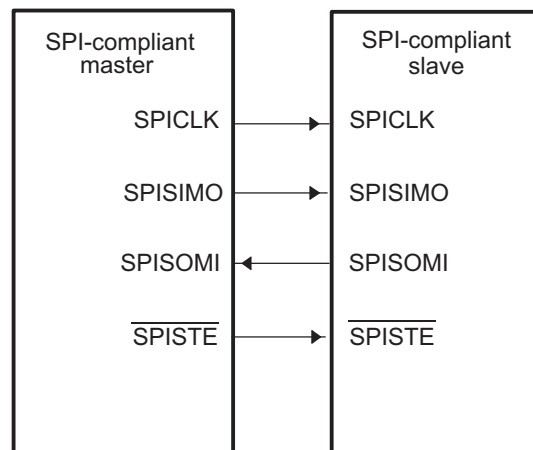

The master device controls the flow of communication by providing shift-clock and slave-enable signals. The slave-enable signal is an optional active-low signal that enables the serial data input and output of the slave device (device not sending out the clock).

In the absence of a dedicated slave-enable signal, communication between the master and slave is determined by the presence or absence of an active shift-clock. When the McBSP is operating in SPI master mode and the $\overline{\text{SPISTE}}$ signal is not used by the slave SPI port, the slave device must remain enabled at all times, and multiple slaves cannot be used.

6.2 Clock Stop Mode

The clock stop mode of the McBSP provides compatibility with the SPI protocol. When the McBSP is configured in clock stop mode, the transmitter and receiver are internally synchronized so that the McBSP functions as an SPI master or slave device. The transmit clock signal (CLKX) corresponds to the serial clock signal (SPICLK) of the SPI protocol, while the transmit frame-synchronization signal (FSX) is used as the slave-enable signal ($\overline{\text{SPISTE}}$).

The receive clock signal (MCLKR) and receive frame-synchronization signal (FSR) are not used in the clock stop mode because these signals are internally connected to their transmit counterparts, CLKX and FSX.

6.3 Bits Used to Enable and Configure the Clock Stop Mode

The bits required to configure the McBSP as an SPI device are introduced in [Table 6-1](#). [Table 6-2](#) shows how the various combinations of the CLKSTP bit and the polarity bits CLKXP and CLKRP create four possible clock stop mode configurations. The timing diagrams in [Section 6.4](#) show the effects of CLKSTP, CLKXP, and CLKRP.

Table 6-1. Bits Used to Enable and Configure the Clock Stop Mode

Bit Field	Description
CLKSTP bits of SPCR1	Use these bits to enable the clock stop mode and to select one of two timing variations. (See also Table 6-2 .)
CLKXP bit of PCR	This bit determines the polarity of the CLKX signal. (See also Table 6-2 .)
CLKRP bit of PCR	This bit determines the polarity of the MCLKR signal. (See also Table 6-2 .)
CLKXM bit of PCR	This bit determines whether CLKX is an input signal (McBSP as slave) or an output signal (McBSP as master).
XPHASE bit of XCR2	You must use a single-phase transmit frame (XPHASE = 0).
RPHASE bit of RCR2	You must use a single-phase receive frame (RPHASE = 0).
XFRLEN1 bits of XCR1	You must use a transmit frame length of 1 serial word (XFRLEN1 = 0).
RFLEN1 bits of RCR1	You must use a receive frame length of 1 serial word (RFLEN1 = 0).
XWDLEN1 bits of XCR1	The XWDLEN1 bits determine the transmit packet length. XWDLEN1 must be equal to RWDLEN1 because in the clock stop mode. The McBSP transmit and receive circuits are synchronized to a single clock.
RWDLEN1 bits of RCR1	The RWDLEN1 bits determine the receive packet length. RWDLEN1 must be equal to XWDLEN1 because in the clock stop mode. The McBSP transmit and receive circuits are synchronized to a single clock.

Table 6-2. Effects of CLKSTP, CLKXP, and CLKRP on the Clock Scheme

Bit Settings	Clock Scheme
CLKSTP = 00b or 01b CLKXP = 0 or 1 CLKRP = 0 or 1	Clock stop mode disabled. Clock enabled for non-SPI mode.
CLKSTP = 10b CLKXP = 0 CLKRP = 0	Low inactive state without delay: The McBSP transmits data on the rising edge of CLKX and receives data on the falling edge of MCLKR.
CLKSTP = 11b CLKXP = 0 CLKRP = 1	Low inactive state with delay: The McBSP transmits data one-half cycle ahead of the rising edge of CLKX and receives data on the rising edge of MCLKR.
CLKSTP = 10b CLKXP = 1 CLKRP = 0	High inactive state without delay: The McBSP transmits data on the falling edge of CLKX and receives data on the rising edge of MCLKR.
CLKSTP = 11b CLKXP = 1 CLKRP = 1	High inactive state with delay: The McBSP transmits data one-half cycle ahead of the falling edge of CLKX and receives data on the falling edge of MCLKR.

6.4 Clock Stop Mode Timing Diagrams

The timing diagrams for the four possible clock stop mode configurations are shown here. Notice that the frame-synchronization signal used in clock stop mode is active throughout the entire transmission as a slave-enable signal. Although the timing diagrams show 8-bit transfers, the packet length can be set to 8, 12, 16, 20, 24, or 32 bits per packet. The receive packet length is selected with the RWDLEN1 bits of RCR1, and the transmit packet length is selected with the XWDLEN1 bits of XCR1. For clock stop mode, the values of RWDLEN1 and XWDLEN1 must be the same because the McBSP transmit and receive circuits are synchronized to a single clock.

NOTE: Even if multiple words are consecutively transferred, the CLKX signal is always stopped and the FSX signal returns to the inactive state after a packet transfer. When consecutive packet transfers are performed, this leads to a minimum idle time of two bit-periods between each packet transfer.

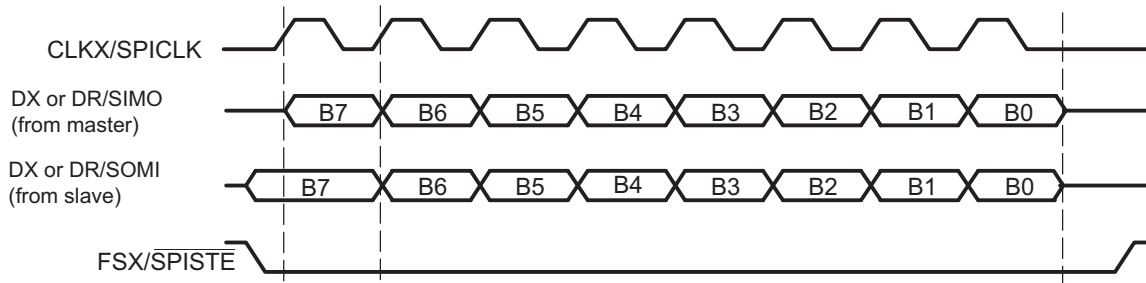
Figure 6-2. SPI Transfer With CLKSTP = 10b (No Clock Delay), CLKXP = 0, and CLKRP = 0

- A If the McBSP is the SPI master (CLKXM = 1), SIMO = DX. If the McBSP is the SPI slave (CLKXM = 0), SIMO = DR.
 B If the McBSP is the SPI master (CLKXM = 1), SOMI = DR. If the McBSP is the SPI slave (CLKXM = 0), SOMI = DX.

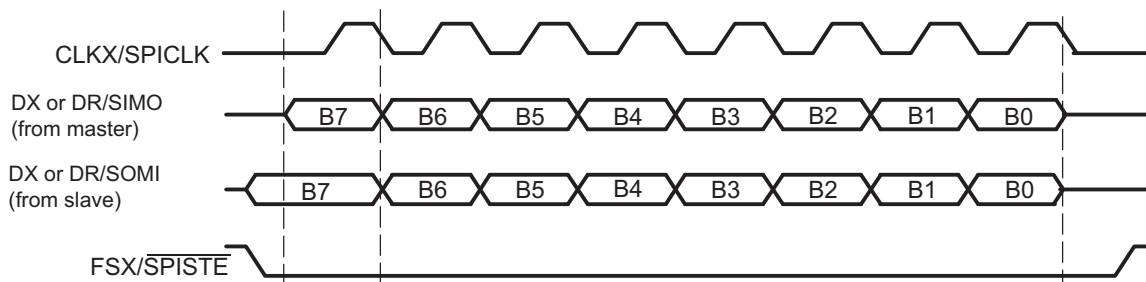
Figure 6-3. SPI Transfer With CLKSTP = 11b (Clock Delay), CLKXP = 0, CLKRP = 1

- A If the McBSP is the SPI master (CLKXM = 1), SIMO = DX. If the McBSP is the SPI slave (CLKXM = 0), SIMO = DR.
 B If the McBSP is the SPI master (CLKXM = 1), SOMI = DR. If the McBSP is the SPI slave (CLKXM = 0), SOMI = DX.

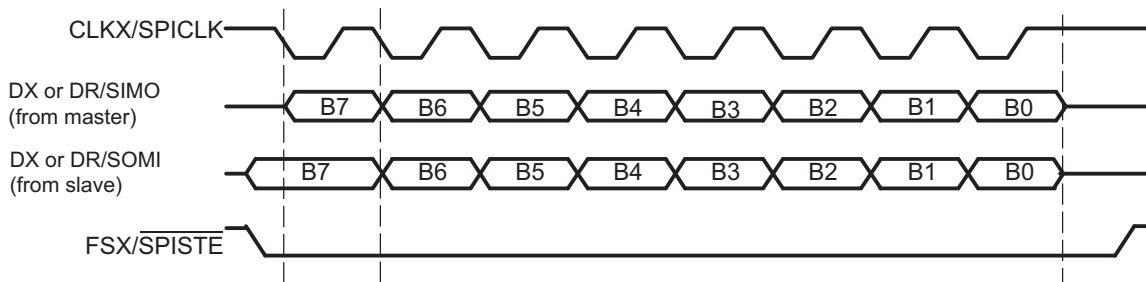
Figure 6-4. SPI Transfer With CLKSTP = 10b (No Clock Delay), CLKXP = 1, and CLKRP = 0

- A If the McBSP is the SPI master (CLKXM = 1), SIMO = DX. If the McBSP is the SPI slave (CLKXM = 0), SIMO = DR.
 B If the McBSP is the SPI master (CLKXM = 1), SOMI = DR. If the McBSP is the SPI slave (CLKXM = 0), SOMI = DX.

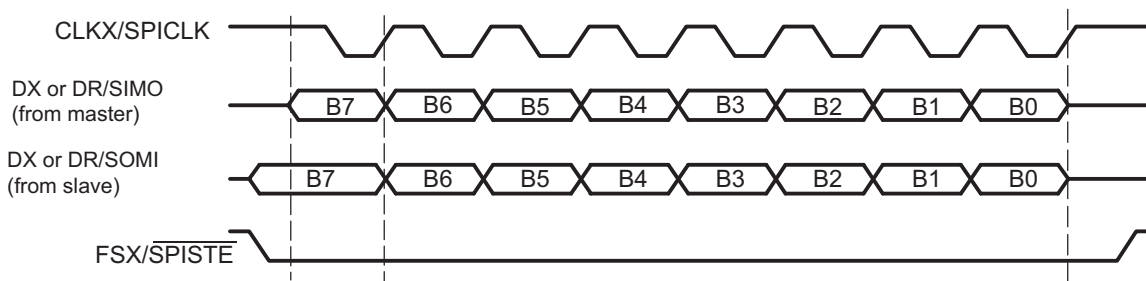
Figure 6-5. SPI Transfer With CLKSTP = 11b (Clock Delay), CLKXP = 1, CLKRP = 1

- A If the McBSP is the SPI master (CLKXM = 1), SIMO=DX. If the McBSP is the SPI slave (CLKXM = 0), SIMO = DR.
 B If the McBSP is the SPI master (CLKXM = 1), SOMI=DR. If the McBSP is the SPI slave (CLKXM = 0), SOMI = DX.

6.5 Procedure for Configuring a McBSP for SPI Operation

To configure the McBSP for SPI master or slave operation:

Step 1. Place the transmitter and receiver in reset.

Clear the transmitter reset bit (XRST = 0) in SPCR2 to reset the transmitter. Clear the receiver reset bit (RRST = 0) in SPCR1 to reset the receiver.

Step 2. Place the sample rate generator in reset.

Clear the sample rate generator reset bit (GRST = 0) in SPCR2 to reset the sample rate generator.

Step 3. Program registers that affect SPI operation.

Program the appropriate McBSP registers to configure the McBSP for proper operation as an SPI master or an SPI slave. For a list of important bits settings, see one of the following topics:

- *McBSP as the SPI Master* ([Section 6.6](#))
- *McBSP as an SPI Slave* ([Section 6.7](#))

Step 4. Enable the sample rate generator.

To release the sample rate generator from reset, set the sample rate generator reset bit (GRST = 1) in SPCR2.

Make sure that during the write to SPCR2, you only modify GRST. Otherwise, you modify the McBSP configuration you selected in the previous step.

Step 5. Enable the transmitter and receiver.

After the sample rate generator is released from reset, wait two sample rate generator clock periods for the McBSP logic to stabilize.

If the CPU services the McBSP transmit and receive buffers, then you can immediately enable the transmitter (XRST = 1 in SPCR2) and enable the receiver (RRST = 1 in SPCR1).

If the DMA controller services the McBSP transmit and receive buffers, then you must first configure the DMA controller (this includes enabling the channels that service the McBSP buffers). When the DMA controller is ready, make XRST = 1 and RRST = 1.

In either case, make sure you only change XRST and RRST when you write to SPCR2 and SPCR1. Otherwise, you modify the bit settings you selected earlier in this procedure.

After the transmitter and receiver are released from reset, wait two sample rate generator clock periods for the McBSP logic to stabilize.

Step 6. If necessary, enable the frame-synchronization logic of the sample rate generator.

After the required data acquisition setup is done (DXR[1,2] is loaded with data), set FRST = 1 if an internally generated frame-synchronization pulse is required (that is, if the McBSP is the SPI master).

6.6 McBSP as the SPI Master

An SPI interface with the McBSP used as the master is shown in [Figure 6-6](#). When the McBSP is configured as a master, the transmit output signal (DX) is used as the SPISIMO signal of the SPI protocol and the receive input signal (DR) is used as the SPISOMI signal.

The register bit values required to configure the McBSP as a master are listed in [Table 6-3](#). After the table are more details about the configuration requirements.

Figure 6-6. SPI Interface with McBSP Used as Master

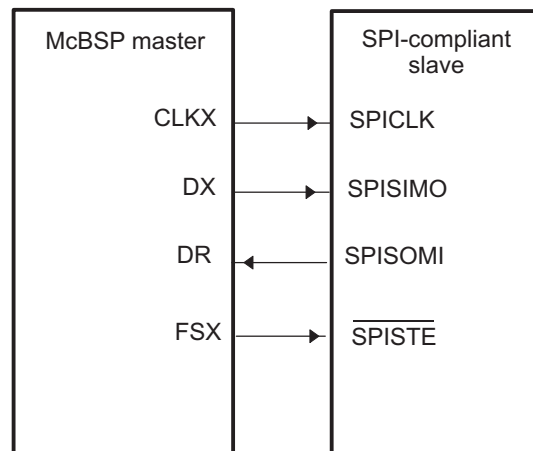

Table 6-3. Bit Values Required to Configure the McBSP as an SPI Master

Required Bit Setting	Description
CLKSTP = 10b or 11b	The clock stop mode (without or with a clock delay) is selected.
CLKXP = 0 or 1	The polarity of CLKX as seen on the MCLKX pin is positive (CLKXP = 0) or negative (CLKXP = 1).
CLKRP = 0 or 1	The polarity of MCLKR as seen on the MCLKR pin is positive (CLKRP = 0) or negative (CLKRP = 1).
CLKXM = 1	The MCLKX pin is an output pin driven by the internal sample rate generator. Because CLKSTP is equal to 10b or 11b, MCLKR is driven internally by CLKX.
SCLKME = 0	The clock generated by the sample rate generator (CLKG) is derived from the CPU clock.
CLKSM = 1	
CLKGDV is a value from 1 to 255	CLKGDV defines the divide down value for CLKG.
FSXM = 1	The FSX pin is an output pin driven according to the FSGM bit. (See the TMS320F28335 Applications and Media Processor Data Manual (SPRS224) for more information.
FSGM = 0	The transmitter drives a frame-synchronization pulse on the FSX pin every time data is transferred from DXR1 to XSR1.
FSXP = 1	The FSX pin is active low.
XDATDLY = 01b	This setting provides the correct setup time on the FSX signal.
RDATDLY = 01b	

When the McBSP functions as the SPI master, it controls the transmission of data by producing the serial clock signal. The clock signal on the MCLKX pin is enabled only during packet transfers. When packets are not being transferred, the MCLKX pin remains high or low depending on the polarity used.

For SPI master operation, the MCLKX pin must be configured as an output. The sample rate generator is then used to derive the CLKX signal from the CPU clock. The clock stop mode internally connects the MCLKX pin to the MCLKR signal so that no external signal connection is required on the MCLKR pin and both the transmit and receive circuits are clocked by the master clock (CLKX).

The data delay parameters of the McBSP (XDATDLY and RDATDLY) must be set to 1 for proper SPI master operation. A data delay value of 0 or 2 is undefined in the clock stop mode.

The McBSP can also provide a slave-enable signal (SS_) on the FSX pin. If a slave-enable signal is required, the FSX pin must be configured as an output and the transmitter must be configured so that a frame-synchronization pulse is generated automatically each time a packet is transmitted (FSGM = 0). The polarity of the FSX pin is programmable high or low; however, in most cases the pin must be configured active low.

When the McBSP is configured as described for SPI-master operation, the bit fields for frame-synchronization pulse width (FWID) and frame-synchronization period (FPER) are overridden, and custom frame-synchronization waveforms are not allowed. To see the resulting waveform produced on the FSX pin, see the timing diagrams in [Section 6.4](#). The signal becomes active before the first bit of a packet transfer, and remains active until the last bit of the packet is transferred. After the packet transfer is complete, the FSX signal returns to the inactive state.

6.7 McBSP as an SPI Slave

An SPI interface with the McBSP used as a slave is shown in [Figure 6-7](#). When the McBSP is configured as a slave, DX is used as the SPISOMI signal and DR is used as the SPISIMO signal.

The register bit values required to configure the McBSP as a slave are listed in [Table 6-4](#). Following the table are more details about configuration requirements.

Figure 6-7. SPI Interface With McBSP Used as Slave

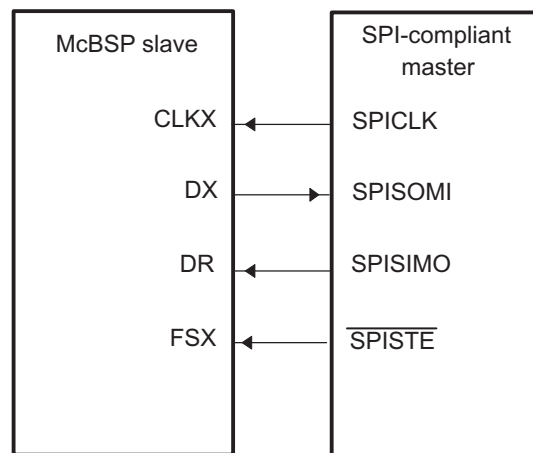

Table 6-4. Bit Values Required to Configure the McBSP as an SPI Slave

Required Bit Setting	Description
CLKSTP = 10b or 11b	The clock stop mode (without or with a clock delay) is selected.
CLKXP = 0 or 1	The polarity of CLKX as seen on the MCLKX pin is positive (CLKXP = 0) or negative (CLKXP = 1).
CLKRP = 0 or 1	The polarity of MCLKR as seen on the MCLKR pin is positive (CLKRP = 0) or negative (CLKRP = 1).
CLKXM = 0	The MCLKX pin is an input pin, so that it can be driven by the SPI master. Because CLKSTP = 10b or 11b, MCLKR is driven internally by CLKX.
SCLKME = 0	The clock generated by the sample rate generator (CLKG) is derived from the CPU clock. (The sample rate generator is used to synchronize the McBSP logic with the externally-generated master clock.)
CLKSM = 1	
CLKGDV = 1	The sample rate generator divides the CPU clock before generating CLKG.
FSXM = 0	The FSX pin is an input pin, so that it can be driven by the SPI master.
FSXP = 1	The FSX pin is active low.
XDATDLY = 00b	These bits must be 0s for SPI slave operation.
RDATDLY = 00b	

When the McBSP is used as an SPI slave, the master clock and slave-enable signals are generated externally by a master device. Accordingly, the CLKX and FSX pins must be configured as inputs. The MCLKX pin is internally connected to the MCLKR signal, so that both the transmit and receive circuits of the McBSP are clocked by the external master clock. The FSX pin is also internally connected to the FSR signal, and no external signal connections are required on the MCLKR and FSR pins.

Although the CLKX signal is generated externally by the master and is asynchronous to the McBSP, the sample rate generator of the McBSP must be enabled for proper SPI slave operation. The sample rate generator must be programmed to its maximum rate of half the CPU clock rate. The internal sample rate clock is then used to synchronize the McBSP logic to the external master clock and slave-enable signals.

The McBSP requires an active edge of the slave-enable signal on the FSX input for each transfer. This means that the master device must assert the slave-enable signal at the beginning of each transfer, and deassert the signal after the completion of each packet transfer; the slave-enable signal cannot remain active between transfers. Unlike the standard SPI, this pin cannot be tied low all the time.

The data delay parameters of the McBSP must be set to 0 for proper SPI slave operation. A value of 1 or 2 is undefined in the clock stop mode.

Receiver Configuration

To configure the McBSP receiver, perform the following procedure:

1. Place the McBSP/receiver in reset (see [Section 7.2](#)).
2. Program McBSP registers for the desired receiver operation (see [Section 7.1](#)).
3. Take the receiver out of reset (see [Section 7.2](#)).

Topic	Page
7.1 Programming the McBSP Registers for the Desired Receiver Operation	68
7.2 Resetting and Enabling the Receiver	68
7.3 Set the Receiver Pins to Operate as McBSP Pins	69
7.4 Enable/Disable the Digital Loopback Mode	69
7.5 Enable/Disable the Clock Stop Mode	70
7.6 Enable/Disable the Receive Multichannel Selection Mode	71
7.7 Choose One or Two Phases for the Receive Frame	71
7.8 Set the Receive Word Length(s)	72
7.9 Set the Receive Frame Length	72
7.10 Enable/Disable the Receive Frame-Synchronization Ignore Function	73
7.11 Set the Receive Companding Mode	74
7.12 Set the Receive Data Delay	75
7.13 Set the Receive Sign-Extension and Justification Mode	77
7.14 Set the Receive Interrupt Mode	79
7.15 Set the Receive Frame-Synchronization Mode	79
7.16 Set the Receive Frame-Synchronization Polarity	81
7.17 Set the Receive Clock Mode	83
7.18 Set the Receive Clock Polarity	84
7.19 Set the SRG Clock Divide-Down Value	85
7.20 Set the SRG Clock Synchronization Mode	86
7.21 Set the SRG Clock Mode (Choose an Input Clock)	86
7.22 Set the SRG Input Clock Polarity	88

7.1 Programming the McBSP Registers for the Desired Receiver Operation

The following is a list of important tasks to be performed when you are configuring the McBSP receiver. Each task corresponds to one or more McBSP register bit fields.

- Global behavior:
 - Set the receiver pins to operate as McBSP pins.
 - Enable/disable the digital loopback mode.
 - Enable/disable the clock stop mode.
 - Enable/disable the receive multichannel selection mode.
- Data behavior:
 - Choose 1 or 2 phases for the receive frame.
 - Set the receive word length(s).
 - Set the receive frame length.
 - Enable/disable the receive frame-synchronization ignore function.
 - Set the receive companding mode.
 - Set the receive data delay.
 - Set the receive sign-extension and justification mode.
 - Set the receive interrupt mode.
- Frame-synchronization behavior:
 - Set the receive frame-synchronization mode.
 - Set the receive frame-synchronization polarity.
 - Set the sample rate generator (SRG) frame-synchronization period and pulse width.
- Clock behavior:
 - Set the receive clock mode.
 - Set the receive clock polarity.
 - Set the SRG clock divide-down value.
 - Set the SRG clock synchronization mode.
 - Set the SRG clock mode (choose an input clock).
 - Set the SRG input clock polarity.

7.2 Resetting and Enabling the Receiver

The first step of the receiver configuration procedure is to reset the receiver, and the last step is to enable the receiver (to take it out of reset). [Table 7-1](#) describes the bits used for both of these steps.

Table 7-1. Register Bits Used to Reset or Enable the McBSP Receiver Field Descriptions

Register	Bit	Field	Value	Description
SPCR2	7	FRST	0	Frame-synchronization logic is reset. The sample rate generator does not generate frame-synchronization signal FSG, even if GRST = 1.
			1	If GRST = 1, frame-synchronization signal FSG is generated after (FPER + 1) number of CLKG clock cycles; all frame counters are loaded with their programmed values.
SPCR2	6	GRST	0	Sample rate generator is reset. If GRST = 0 due to a DSP reset, CLKG is driven by the CPU clock divided by 2, and FSG is driven low (inactive). If GRST = 0 due to program code, CLKG and FSG are both driven low (inactive).
			1	Sample rate generator is enabled. CLKG is driven according to the configuration programmed in the sample rate generator registers (SRGR[1,2]). If FRST = 1, the generator also generates the frame-synchronization signal FSG as programmed in the sample rate generator registers.

Table 7-1. Register Bits Used to Reset or Enable the McBSP Receiver Field Descriptions (continued)

Register	Bit	Field	Value	Description
SPCR1	0	RRST		Receiver reset
			0	The serial port receiver is disabled and in the reset state.
			1	The serial port receiver is enabled.

7.2.1 Reset Considerations

The serial port can be reset in the following two ways:

1. The DSP reset (\overline{XRS} signal driven low) places the receiver, transmitter, and sample rate generator in reset. When the device reset is removed (\overline{XRS} signal released), $GRST = FRST = RRST = XRST = 0$ keep the entire serial port in the reset state, provided the McBSP clock is turned on.
2. The serial port transmitter and receiver can be reset directly using the RRST and XRST bits in the serial port control registers. The sample rate generator can be reset directly using the GRST bit in SPCR2.

Table 7-2 shows the state of McBSP pins when the serial port is reset due to a device reset and a direct receiver/transmitter reset.

For more details about McBSP reset conditions and effects, see Section 9.2, *Resetting and Initializing a McBSP*.

Table 7-2. Reset State of Each McBSP Pin

Pin	Possible State(s)	State Forced By Device Reset	State Forced By Receiver Reset (RRST = 0 and GRST = 1)
MDRx	I	GPIO Input	Input
MCLKRx	I/O/Z	GPIO Input	Known state if input; MCLKR running if output
MFSRx	I/O/Z	GPIO Input	Known state if input; FSRP inactive state if output Transmitter reset ($XRST = 0$ and $GRST = 1$)
MDXx	O/Z	GPIO Input	Low impedance after transmit bit clock provided
MCLKXx	I/O/Z	GPIO Input	Known state if input; CLKX running if output
MFSXx	I/O/Z	GPIO Input	Known state if input; FSXP inactive state if output

7.3 Set the Receiver Pins to Operate as McBSP Pins

To configure a pin for its McBSP function, you should configure the bits of the GPxMUXn register appropriately. In addition to this, bits 12 and 13 of the PCR register must be set to 0. These bits are defined as reserved.

7.4 Enable/Disable the Digital Loopback Mode

The DLB bit determines whether the digital loopback mode is on. DLB is described in Table 7-3.

Table 7-3. Register Bit Used to Enable/Disable the Digital Loopback Mode

Register	Bit	Name	Function	Type	Reset Value	
SPCR1	15	DLB	Digital loopback mode	R/W	0	
			DLB = 0			Digital loopback mode is disabled.
			DLB = 1			Digital loopback mode is enabled.

7.4.1 Digital Loopback Mode

In the digital loopback mode, the receive signals are connected internally through multiplexers to the corresponding transmit signals, as shown in [Table 7-4](#). This mode allows testing of serial port code with a single DSP device; the McBSP receives the data it transmits.

Table 7-4. Receive Signals Connected to Transmit Signals in Digital Loopback Mode

This Receive Signal	Is Fed Internally by This Transmit Signal
MDR (receive data)	MDX (transmit data)
MFSR (receive frame synchronization)	MFSX (transmit frame synchronization)
MCLKR (receive clock)	MCLKX (transmit clock)

7.5 Enable/Disable the Clock Stop Mode

The CLKSTP bits determine whether the clock stop mode is on. CLKSTP is described in [Table 7-5](#).

Table 7-5. Register Bits Used to Enable/Disable the Clock Stop Mode

Register	Bit	Name	Function	Type	Reset Value	
SPCR1	12-11	CLKSTP	Clock stop mode		R/W	00
			CLKSTP = 0Xb	Clock stop mode disabled; normal clocking for non-SPI mode		
			CLKSTP = 10b	Clock stop mode enabled, without clock delay		
			CLKSTP = 11b	Clock stop mode enabled, with clock delay		

7.5.1 Clock Stop Mode

The clock stop mode supports the SPI master-slave protocol. If you do not plan to use the SPI protocol, you can clear CLKSTP to disable the clock stop mode.

In the clock stop mode, the clock stops at the end of each data transfer. At the beginning of each data transfer, the clock starts immediately (CLKSTP = 10b) or after a half-cycle delay (CLKSTP = 11b). The CLKXP bit determines whether the starting edge of the clock on the MCLKX pin is rising or falling. The CLKRP bit determines whether receive data is sampled on the rising or falling edge of the clock shown on the MCLKR pin.

[Table 7-6](#) summarizes the impact of CLKSTP, CLKXP, and CLKRP on serial port operation. In the clock stop mode, the receive clock is tied internally to the transmit clock, and the receive frame-synchronization signal is tied internally to the transmit frame-synchronization signal.

Table 7-6. Effects of CLKSTP, CLKXP, and CLKRP on the Clock Scheme

Bit Settings	Clock Scheme
CLKSTP = 00b or 01b CLKXP = 0 or 1 CLKRP = 0 or 1	Clock stop mode disabled. Clock enabled for non-SPI mode.
CLKSTP = 10b CLKXP = 0 CLKRP = 0	Low inactive state without delay: The McBSP transmits data on the rising edge of CLKX and receives data on the falling edge of MCLKR.
CLKSTP = 11b CLKXP = 0 CLKRP = 1	Low inactive state with delay: The McBSP transmits data one-half cycle ahead of the rising edge of CLKX and receives data on the rising edge of MCLKR.
CLKSTP = 10b CLKXP = 1 CLKRP = 0	High inactive state without delay: The McBSP transmits data on the falling edge of CLKX and receives data on the rising edge of MCLKR.
CLKSTP = 11b CLKXP = 1 CLKRP = 1	High inactive state with delay: The McBSP transmits data one-half cycle ahead of the falling edge of CLKX and receives data on the falling edge of MCLKR.

7.6 Enable/Disable the Receive Multichannel Selection Mode

The RMCM bit determines whether the receive multichannel selection mode is on. RMCM is described in [Table 7-7](#). For more details, see [Section 5.6, Receive Multichannel Selection Mode](#).

Table 7-7. Register Bit Used to Enable/Disable the Receive Multichannel Selection Mode

Register	Bit	Name	Function	Type	Reset Value
MCR1	0	RMCM	Receive multichannel selection mode	R/W	0
			RMCM = 0		The mode is disabled. All 128 channels are enabled.
			RMCM = 1		The mode is enabled. Channels can be individually enabled or disabled. The only channels enabled are those selected in the appropriate receive channel enable registers (RCERs). The way channels are assigned to the RCERs depends on the number of receive channel partitions (2 or 8), as defined by the RMCME bit.

7.7 Choose One or Two Phases for the Receive Frame

The RPHASE bit (see [Table 7-8](#)) determines whether the receive data frame has one or two phases.

Table 7-8. Register Bit Used to Choose One or Two Phases for the Receive Frame

Register	Bit	Name	Function	Type	Reset Value
RCR2	15	RPHASE	Receive phase number	R/W	0
			Specifies whether the receive frame has 1 or 2 phases.		
			RPHASE = 0		Single-phase frame
			RPHASE = 1		Dual-phase frame

7.8 Set the Receive Word Length(s)

The RWDLEN1 and RWDLEN2 bit fields (see [Table 7-9](#)) determine how many bits are in each serial word in phase 1 and in phase 2, respectively, of the receive data frame.

Table 7-9. Register Bits Used to Set the Receive Word Length(s)

Register	Bit	Name	Function	Type	Reset Value	
RCR1	7-5	RWDLEN1	Receive word length 1	R/W	000	
			Specifies the length of every serial word in phase 1 of the receive frame.			
			RWDLEN1 = 000			8 bits
			RWDLEN1 = 001			12 bits
			RWDLEN1 = 010			16 bits
			RWDLEN1 = 011			20 bits
			RWDLEN1 = 100			24 bits
			RWDLEN1 = 101			32 bits
RWDLEN1 = 11X	Reserved					
RCR2	7-5	RWDLEN2	Receive word length 2	R/W	000	
			If a dual-phase frame is selected, RWDLEN2 specifies the length of every serial word in phase 2 of the frame.			
			RWDLEN2 = 000			8 bits
			RWDLEN2 = 001			12 bits
			RWDLEN2 = 010			16 bits
			RWDLEN2 = 011			20 bits
			RWDLEN2 = 100			24 bits
			RWDLEN2 = 101			32 bits
RWDLEN2 = 11X	Reserved					

7.8.1 Word Length Bits

Each frame can have one or two phases, depending on the value that you load into the RPHASE bit. If a single-phase frame is selected, RWDLEN1 selects the length for every serial word received in the frame. If a dual-phase frame is selected, RWDLEN1 determines the length of the serial words in phase 1 of the frame and RWDLEN2 determines the word length in phase 2 of the frame.

7.9 Set the Receive Frame Length

The RFRLLEN1 and RFRLLEN2 bit fields (see [Table 7-10](#)) determine how many serial words are in phase 1 and in phase 2, respectively, of the receive data frame.

Table 7-10. Register Bits Used to Set the Receive Frame Length

Register	Bit	Name	Function	Type	Reset Value	
RCR1	14-8	RFRLLEN1	Receive frame length 1	R/W	000 0000	
			(RFRLLEN1 + 1) is the number of serial words in phase 1 of the receive frame.			
			RFRLLEN1 = 000 0000			1 word in phase 1
			RFRLLEN1 = 000 0001			2 words in phase 1
			RFRLLEN1 = 111 1111			128 words in phase 1

Table 7-10. Register Bits Used to Set the Receive Frame Length (continued)

Register	Bit	Name	Function	Type	Reset Value
RCR2	14-8	RFRLLEN2	Receive frame length 2	R/W	000 0000
			If a dual-phase frame is selected, (RFRLLEN2 + 1) is the number of serial words in phase 2 of the receive frame.		
			RFRLLEN2 = 000 0000 1 word in phase 2		
			RFRLLEN2 = 000 0001 2 words in phase 2		
			RFRLLEN2 = 111 1111 128 words in phase 2		

7.9.1 Selected Frame Length

The receive frame length is the number of serial words in the receive frame. Each frame can have one or two phases, depending on value that you load into the RPHASE bit.

If a single-phase frame is selected (RPHASE = 0), the frame length is equal to the length of phase 1. If a dual-phase frame is selected (RPHASE = 1), the frame length is the length of phase 1 plus the length of phase 2.

The 7-bit RFRLLEN fields allow up to 128 words per phase. See [Table 7-11](#) for a summary of how to calculate the frame length. This length corresponds to the number of words or logical time slots or channels per frame-synchronization pulse.

Program the RFRLLEN fields with $[w \text{ minus } 1]$, where w represents the number of words per phase. For the example, if you want a phase length of 128 words in phase 1, load 127 into RFRLLEN1.

Table 7-11. How to Calculate the Length of the Receive Frame

RPHASE	RFRLLEN1	RFRLLEN2	Frame Length
0	$0 \leq \text{RFRLLEN1} \leq 127$	Don't care	(RFRLLEN1 + 1) words
1	$0 \leq \text{RFRLLEN1} \leq 127$	$0 \leq \text{RFRLLEN2} \leq 127$	(RFRLLEN1 + 1) + (RFRLLEN2 + 1) words

7.10 Enable/Disable the Receive Frame-Synchronization Ignore Function

The RFIG bit (see [Table 7-12](#)) controls the receive frame-synchronization ignore function.

Table 7-12. Register Bit Used to Enable/Disable the Receive Frame-Synchronization Ignore Function

Register	Bit	Name	Function	Type	Reset Value
RCR2	2	RFIG	Receive frame-synchronization ignore	R/W	0
			RFIG = 0 An unexpected receive frame-synchronization pulse causes the McBSP to restart the frame transfer.		
			RFIG = 1 The McBSP ignores unexpected receive frame-synchronization pulses.		

7.10.1 Unexpected Frame-Synchronization Pulses and the Frame-Synchronization Ignore Function

If a frame-synchronization pulse starts the transfer of a new frame before the current frame is fully received, this pulse is treated as an unexpected frame-synchronization pulse.

When RFIG = 1, reception continues, ignoring the unexpected frame-synchronization pulses.

When RFIG = 0, an unexpected FSR pulse causes the McBSP to discard the contents of RSR[1,2] in favor of the new incoming data. Therefore, if RFIG = 0 and an unexpected frame-synchronization pulse occurs, the serial port:

1. Aborts the current data transfer
2. Sets RSYNCERR in SPCR1 to 1
3. Begins the transfer of a new data word

For more details about the frame-synchronization error condition, see [Section 4.3, Unexpected Receive Frame-Synchronization Pulse](#).

7.10.2 Examples of Effects of RFIG

[Figure 7-1](#) shows an example in which word B is interrupted by an unexpected frame-synchronization pulse when (R/X)FIG = 0. In the case of reception, the reception of B is aborted (B is lost), and a new data word © in this example) is received after the appropriate data delay. This condition is a receive synchronization error, which sets the RSYNCERR bit.

Figure 7-1. Unexpected Frame-Synchronization Pulse With (R/X)FIG = 0

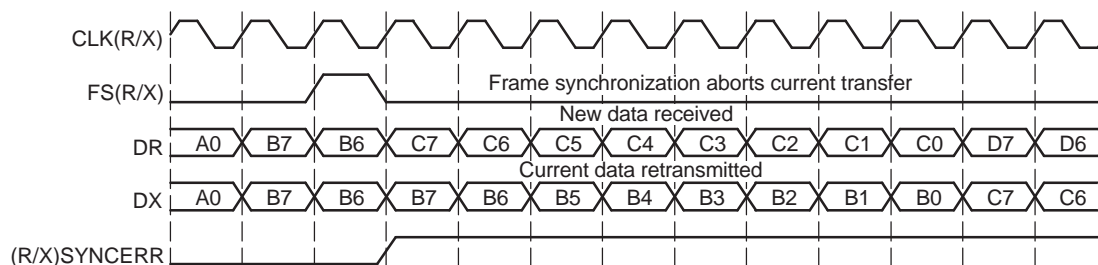

In contrast with [Figure 7-1](#), [Figure 7-2](#) shows McBSP operation when unexpected frame-synchronization signals are ignored (when (R/X)FIG = 1). Here, the transfer of word B is not affected by an unexpected pulse.

Figure 7-2. Unexpected Frame-Synchronization Pulse With (R/X)FIG = 1

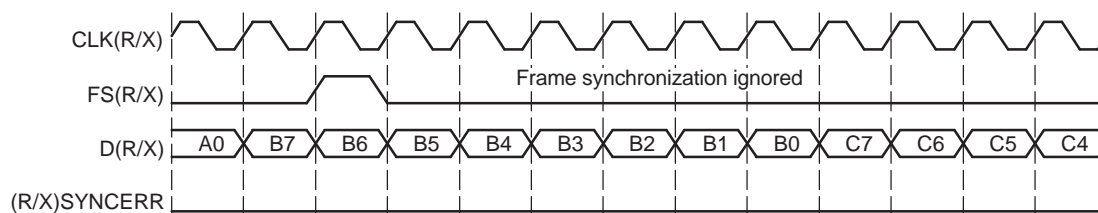

7.11 Set the Receive Companding Mode

The RCOMPAND bits (see [Table 7-13](#)) determine whether companding or another data transfer option is chosen for McBSP reception.

Table 7-13. Register Bits Used to Set the Receive Companding Mode

Register	Bit	Name	Function	Type	Reset Value
RCR2	4-3	RCOMPAND	Receive companding mode	R/W	00
Modes other than 00b are enabled only when the appropriate RWDLEN is 000b, indicating 8-bit data.					
RCOMPAND = 00 No companding, any size data, MSB received first					
RCOMPAND = 01 No companding, 8-bit data, LSB received first (for details, see Section 7.11.4).					
RCOMPAND = 10 μ -law companding, 8-bit data, MSB received first					
RCOMPAND = 11 A-law companding, 8-bit data, MSB received first					

7.11.1 Companding

Companding (COMpressing and exPANDING) hardware allows compression and expansion of data in either μ -law or A-law format. The companding standard employed in the United States and Japan is μ -law. The European companding standard is referred to as A-law. The specifications for μ -law and A-law log PCM are part of the CCITT G.711 recommendation.

A-law and μ -law allow 13 bits and 14 bits of dynamic range, respectively. Any values outside this range are set to the most positive or most negative value. Thus, for companding to work best, the data transferred to and from the McBSP via the CPU or DMA controller must be at least 16 bits wide.

The μ -law and A-law formats both encode data into 8-bit code words. Companded data is always 8 bits wide; the appropriate word length bits (RWDLEN1, RWDLEN2, XWDLEN1, XWDLEN2) must therefore be set to 0, indicating an 8-bit wide serial data stream. If companding is enabled and either of the frame phases does not have an 8-bit word length, companding continues as if the word length is 8 bits.

Figure 7-3 illustrates the companding processes. When companding is chosen for the transmitter, compression occurs during the process of copying data from DXR1 to XSR1. The transmit data is encoded according to the specified companding law (A-law or μ -law). When companding is chosen for the receiver, expansion occurs during the process of copying data from RBR1 to DRR1. The receive data is decoded to 2's-complement format.

Figure 7-3. Companding Processes for Reception and for Transmission

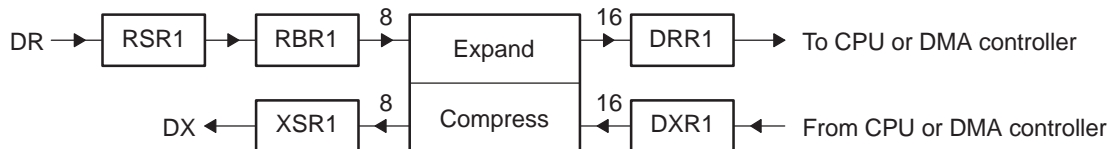

7.11.2 Format of Expanded Data

For reception, the 8-bit compressed data in RBR1 is expanded to left-justified 16-bit data in DRR1. The RJUST bit of SPCR1 is ignored when companding is used.

7.11.3 Companding Internal Data

If the McBSP is otherwise unused (the serial port transmit and receive sections are reset), the companding hardware can compand internal data. See Section 2.2.2, *Capability to Compand Internal Data*.

7.11.4 Option to Receive LSB First

Normally, the McBSP transmits or receives all data with the most significant bit (MSB) first. However, certain 8-bit data protocols (that do not use companded data) require the least significant bit (LSB) to be transferred first. If you set RCOMPAND = 01b in RCR2, the bit ordering of 8-bit words is reversed during reception. Similar to companding, this feature is enabled only if the appropriate word length bits are set to 0, indicating that 8-bit words are to be transferred serially. If either phase of the frame does not have an 8-bit word length, the McBSP assumes the word length is eight bits and LSB-first ordering is done.

7.12 Set the Receive Data Delay

The RDATDLY bits (see Table 7-14) determine the length of the data delay for the receive frame.

Table 7-14. Register Bits Used to Set the Receive Data Delay

Register	Bit	Name	Function	Type	Reset Value
RCR2	1-0	RDATDLY	Receive data delay		00
			RDATDLY = 00	0-bit data delay	
			RDATDLY = 01	1-bit data delay	
			RDATDLY = 10	2-bit data delay	

Table 7-14. Register Bits Used to Set the Receive Data Delay (continued)

Register	Bit	Name	Function	Type	Reset Value
			RDATDLY = 11	Reserved	

7.12.1 Data Delay

The start of a frame is defined by the first clock cycle in which frame synchronization is found to be active. The beginning of actual data reception or transmission with respect to the start of the frame can be delayed if required. This delay is called data delay.

RDATDLY specifies the data delay for reception. The range of programmable data delay is zero to two bit-clocks (RDATDLY = 00b-10b), as described in Table 7-14 and shown in Figure 7-4. In this figure, the data transferred is an 8-bit value with bits labeled B7, B6, B5, and so on. Typically a 1-bit delay is selected, because data often follows a 1-cycle active frame-synchronization pulse.

7.12.2 0-Bit Data Delay

Normally, a frame-synchronization pulse is detected or sampled with respect to an edge of internal serial clock CLK(R/X). Thus, on the following cycle or later (depending on the data delay value), data may be received or transmitted. However, in the case of 0-bit data delay, the data must be ready for reception and/or transmission on the same serial clock cycle.

For reception, this problem is solved because receive data is sampled on the first falling edge of MCLKR where an active-high internal FSR is detected. However, data transmission must begin on the rising edge of the internal CLKX clock that generated the frame synchronization. Therefore, the first data bit is assumed to be present in XSR1, and thus on DX. The transmitter then asynchronously detects the frame-synchronization signal (FSX) going active high and immediately starts driving the first bit to be transmitted on the DX pin.

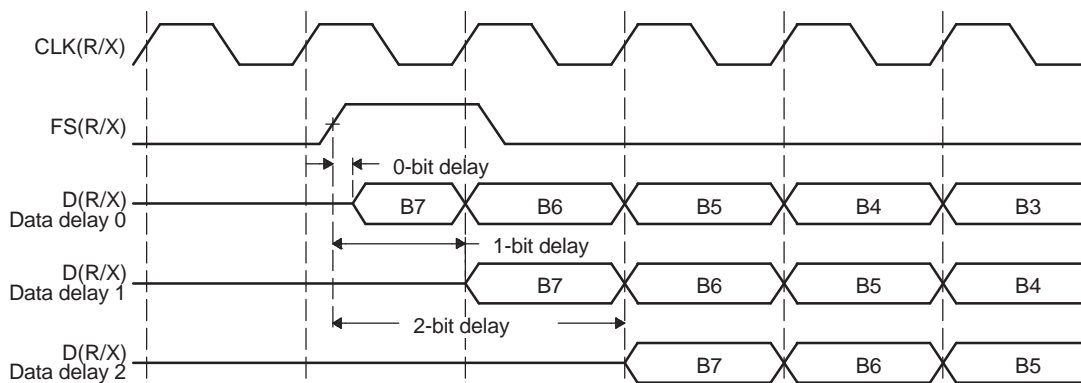
Figure 7-4. Range of Programmable Data Delay

7.12.3 2-Bit Data Delay

A data delay of two bit periods allows the serial port to interface to different types of T1 framing devices where the data stream is preceded by a framing bit. During reception of such a stream with data delay of two bits (framing bit appears after a 1-bit delay and data appears after a 2-bit delay), the serial port essentially discards the framing bit from the data stream, as shown in Figure 7-5. In this figure, the data transferred is an 8-bit value with bits labeled B7, B6, B5, and so on.

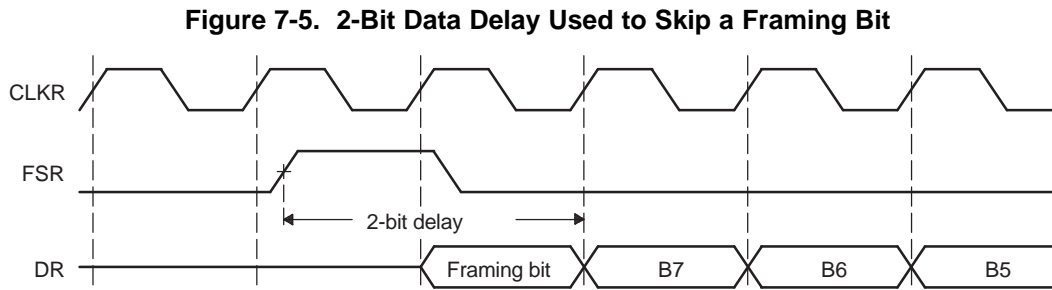

7.13 Set the Receive Sign-Extension and Justification Mode

The RJUST bits (see [Table 7-15](#)) determine whether data received by the McBSP is sign-extended and how it is justified.

Table 7-15. Register Bits Used to Set the Receive Sign-Extension and Justification Mode

Register	Bit	Name	Function	Type	Reset Value
SPCR1	14-13	RJUST	Receive sign-extension and justification mode	R/W	00
			RJUST = 00 Right justify data and zero fill MSBs in DRR[1,2]		
			RJUST = 01 Right justify data and sign extend it into the MSBs in DRR[1,2]		
			RJUST = 10 Left justify data and zero fill LSBs in DRR[1,2]		
			RJUST = 11 Reserved		

7.13.1 Sign-Extension and the Justification

RJUST in SPCR1 selects whether data in RBR[1,2] is right- or left-justified (with respect to the MSB) in DRR[1,2] and whether unused bits in DRR[1,2] are filled with zeros or with sign bits.

[Table 7-16](#) and [Table 7-17](#) show the effects of various RJUST values. The first table shows the effect on an example 12-bit receive-data value ABCh. The second table shows the effect on an example 20-bit receive-data value ABCDEh.

Table 7-16. Example: Use of RJUST Field With 12-Bit Data Value ABCh

RJUST	Justification	Extension	Value in DRR2	Value in DRR1
00b	Right	Zero fill MSBs	0000h	0ABCh
01b	Right	Sign extend data into MSBs	FFFFh	FABCh
10b	Left	Zero fill LSBs	0000h	ABC0h
11b	Reserved	Reserved	Reserved	Reserved

Table 7-17. Example: Use of RJUST Field With 20-Bit Data Value ABCDEh

RJUST	Justification	Extension	Value in DRR2	Value in DRR1
00b	Right	Zero fill MSBs	000Ah	BCDEh
01b	Right	Sign extend data into MSBs	FFFAh	BCDEh
10b	Left	Zero fill LSBs	ABCDh	E000h
11b	Reserved	Reserved	Reserved	Reserved

7.14 Set the Receive Interrupt Mode

The RINTM bits (see [Table 7-18](#)) determine which event generates a receive interrupt request to the CPU.

The receive interrupt (RINT) informs the CPU of changes to the serial port status. Four options exist for configuring this interrupt. The options are set by the receive interrupt mode bits, RINTM, in SPCR1.

Table 7-18. Register Bits Used to Set the Receive Interrupt Mode

Register	Bit	Name	Function	Type	Reset Value
SPCR1	5-4	RINTM	Receive interrupt mode	R/W	00
			RINTM = 00 RINT generated when RRDY changes from 0 to 1. Interrupt on every serial word by tracking the RRDY bit in SPCR1. Regardless of the value of RINTM, RRDY can be read to detect the RRDY = 1 condition.		
			RINTM = 01 RINT generated by an end-of-block or end-of-frame condition in the receive multichannel selection mode. In the multichannel selection mode, interrupt after every 16-channel block boundary has been crossed within a frame and at the end of the frame. For details, see Section 5.8, Using Interrupts Between Block Transfers . In any other serial transfer case, this setting is not applicable and, therefore, no interrupts are generated.		
			RINTM = 10 RINT generated by a new receive frame-synchronization pulse. Interrupt on detection of receive frame-synchronization pulses. This generates an interrupt even when the receiver is in its reset state. This is done by synchronizing the incoming frame-synchronization pulse to the CPU clock and sending it to the CPU via RINT.		
			RINTM = 11 RINT generated when RSYNCERR is set. Interrupt on frame-synchronization error. Regardless of the value of RINTM, RSYNCERR can be read to detect this condition. For information on using RSYNCERR, see Section 4.3, Unexpected Receive Frame-Synchronization Pulse .		

7.15 Set the Receive Frame-Synchronization Mode

The bits described in [Table 7-19](#) determine the source for receive frame synchronization and the function of the FSR pin.

7.15.1 Receive Frame-Synchronization Modes

[Table 7-20](#) shows how you can select various sources to provide the receive frame-synchronization signal and the effect on the FSR pin. The polarity of the signal on the FSR pin is determined by the FSRP bit.

In digital loopback mode (DLB = 1), the transmit frame-synchronization signal is used as the receive frame-synchronization signal.

Also in the clock stop mode, the internal receive clock signal (MCLKR) and the internal receive frame-synchronization signal (FSR) are internally connected to their transmit counterparts, CLKX and FSX.

Table 7-19. Register Bits Used to Set the Receive Frame Synchronization Mode

Register	Bit	Name	Function	Type	Reset Value
PCR	10	FSRM	Receive frame-synchronization mode	R/W	0
			FSRM = 0 Receive frame synchronization is supplied by an external source via the FSR pin.		
			FSRM = 1 Receive frame synchronization is supplied by the sample rate generator. FSR is an output pin reflecting internal FSR, except when GSYNC = 1 in SRGR2.		

Table 7-19. Register Bits Used to Set the Receive Frame Synchronization Mode (continued)

Register	Bit	Name	Function	Type	Reset Value
SRGR2	15	GSYNC	<p>Sample rate generator clock synchronization mode</p> <p>If the sample rate generator creates a frame-synchronization signal (FSG) that is derived from an external input clock, the GSYNC bit determines whether FSG is kept synchronized with pulses on the FSR pin.</p> <p>GSYNC = 0 No clock synchronization is used: CLKG oscillates without adjustment, and FSG pulses every (FPER + 1) CLKG cycles.</p> <p>GSYNC = 1 Clock synchronization is used. When a pulse is detected on the FSR pin:</p> <ul style="list-style-type: none"> • CLKG is adjusted as necessary so that it is synchronized with the input clock on the MCLKR pin. • FSG pulses FSG only pulses in response to a pulse on the FSR pin. The frame-synchronization period defined in FPER is ignored. <p>For more details, see Section 3.3, Synchronizing Sample Rate Generator Outputs to an External Clock.</p>	R/W	0
SPCR1	15	DLB	<p>Digital loopback mode</p> <p>DLB = 0 Digital loopback mode is disabled.</p> <p>DLB = 1 Digital loopback mode is enabled. The receive signals, including the receive frame-synchronization signal, are connected internally through multiplexers to the corresponding transmit signals.</p>	R/W	0
SPCR1	12-11	CLKSTP	<p>Clock stop mode</p> <p>CLKSTP = 0xb Clock stop mode disabled; normal clocking for non-SPI mode.</p> <p>CLKSTP = 10b Clock stop mode enabled without clock delay. The internal receive clock signal (MCLKR) and the internal receive frame-synchronization signal (FSR) are internally connected to their transmit counterparts, CLKX and FSX.</p> <p>CLKSTP = 11b Clock stop mode enabled with clock delay. The internal receive clock signal (MCLKR) and the internal receive frame-synchronization signal (FSR) are internally connected to their transmit counterparts, CLKX and FSX.</p>	R/W	00

Table 7-20. Select Sources to Provide the Receive Frame-Synchronization Signal and the Effect on the FSR Pin

DLB	FSRM	GSYNC	Source of Receive Frame Synchronization	FSR Pin Status
0	0	0 or 1	An external frame-synchronization signal enters the McBSP through the FSR pin. The signal is then inverted as determined by FSRP before being used as internal FSR.	Input
0	1	0	Internal FSR is driven by the sample rate generator frame-synchronization signal (FSG).	Output. FSG is inverted as determined by FSRP before being driven out on the FSR pin.
0	1	1	Internal FSR is driven by the sample rate generator frame-synchronization signal (FSG).	Input. The external frame-synchronization input on the FSR pin is used to synchronize CLKG and generate FSG pulses.
1	0	0	Internal FSX drives internal FSR.	High impedance

Table 7-20. Select Sources to Provide the Receive Frame-Synchronization Signal and the Effect on the FSR Pin (continued)

DLB	FSRM	GSYNC	Source of Receive Frame Synchronization	FSR Pin Status
1	0 or 1	1	Internal FSX drives internal FSR.	Input. If the sample rate generator is running, external FSR is used to synchronize CLKG and generate FSG pulses.
1	1	0	Internal FSX drives internal FSR.	Output. Receive (same as transmit) frame synchronization is inverted as determined by FSRP before being driven out on the FSR pin.

7.16 Set the Receive Frame-Synchronization Polarity

The FSRP bit (see [Table 7-21](#)) determines whether frame-synchronization pulses are active high or active low on the FSR pin.

Table 7-21. Register Bit Used to Set Receive Frame-Synchronization Polarity

Register	Bit	Name	Function	Type	Reset Value
PCR	2	FSRP	Receive frame-synchronization polarity	R/W	0
			FSRP = 0		Frame-synchronization pulse FSR is active high.
			FSRP = 1		Frame-synchronization pulse FSR is active low.

7.16.1 Frame-Synchronization Pulses, Clock Signals, and Their Polarities

Receive frame-synchronization pulses can be generated internally by the sample rate generator (see [Section 3.2](#)) or driven by an external source. The source of frame synchronization is selected by programming the mode bit, FSRM, in PCR. FSR is also affected by the GSYNC bit in SRGR2. For information about the effects of FSRM and GSYNC, see [Section 7.15, Set the Receive Frame-Synchronization Mode](#). Similarly, receive clocks can be selected to be inputs or outputs by programming the mode bit, CLKRM, in the PCR (see [Section 7.17, Set the Receive Clock Mode](#)).

When FSR and FSX are inputs (FSXM = FSRM = 0, external frame-synchronization pulses), the McBSP detects them on the internal falling edge of clock, internal MCLKR, and internal CLKX, respectively. The receive data arriving at the DR pin is also sampled on the falling edge of internal MCLKR. These internal clock signals are either derived from an external source via CLK(R/X) pins or driven by the sample rate generator clock (CLKG) internal to the McBSP.

When FSR and FSX are outputs, implying that they are driven by the sample rate generator, they are generated (transition to their active state) on the rising edge of the internal clock, CLK(R/X). Similarly, data on the DX pin is output on the rising edge of internal CLKX.

FSRP, FSXP, CLKRP, and CLKXP in the pin control register (PCR) configure the polarities of the FSR, FSX, MCLKR, and CLKX signals, respectively. All frame-synchronization signals (internal FSR, internal FSX) that are internal to the serial port are active high. If the serial port is configured for external frame synchronization (FSR/FSX are inputs to McBSP), and FSRP = FSXP = 1, the external active-low frame-synchronization signals are inverted before being sent to the receiver (internal FSR) and transmitter (internal FSX). Similarly, if internal synchronization (FSR/FSX are output pins and GSYNC = 0) is selected, the internal active-high frame-synchronization signals are inverted, if the polarity bit FS(R/X)P = 1, before being sent to the FS(R/X) pin.

On the transmit side, the transmit clock polarity bit, CLKXP, sets the edge used to shift and clock out transmit data. Data is always transmitted on the rising edge of internal CLKX. If CLKXP = 1 and external clocking is selected (CLKXM = 0 and CLKX is an input), the external falling-edge triggered input clock on CLKX is inverted to a rising-edge triggered clock before being sent to the transmitter. If CLKXP = 1, and internal clocking selected (CLKXM = 1 and CLKX is an output pin), the internal (rising-edge triggered) clock, internal CLKX, is inverted before being sent out on the MCLKX pin.

Similarly, the receiver can reliably sample data that is clocked with a rising edge clock (by the transmitter). The receive clock polarity bit, CLKRP, sets the edge used to sample received data. The receive data is always sampled on the falling edge of internal MCLKR. Therefore, if CLKRP = 1 and external clocking is selected (CLKRM = 0 and MCLKR is an input pin), the external rising-edge triggered input clock on MCLKR is inverted to a falling-edge triggered clock before being sent to the receiver. If CLKRP = 1 and internal clocking is selected (CLKRM = 1), the internal falling-edge triggered clock is inverted to a rising-edge triggered clock before being sent out on the MCLKR pin.

MCLKRP = CLKXP in a system where the same clock (internal or external) is used to clock the receiver and transmitter. The receiver uses the opposite edge as the transmitter to ensure valid setup and hold of data around this edge. Figure 7-6 shows how data clocked by an external serial device using a rising edge can be sampled by the McBSP receiver on the falling edge of the same clock.

Figure 7-6. Data Clocked Externally Using a Rising Edge and Sampled by the McBSP Receiver on a Falling Edge

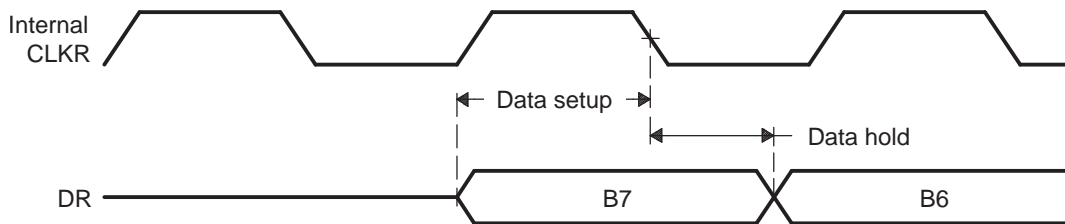

Set the SRG Frame-Synchronization Period and Pulse Width

7.16.2 Frame-Synchronization Period and the Frame-Synchronization Pulse Width

The sample rate generator can produce a clock signal, CLKG, and a frame-synchronization signal, FSG. If the sample rate generator is supplying receive or transmit frame synchronization, you must program the bit fields FPER and FWID.

On FSG, the period from the start of a frame-synchronization pulse to the start of the next pulse is (FPER + 1) CLKG cycles. The 12 bits of FPER allow a frame-synchronization period of 1 to 4096 CLKG cycles, which allows up to 4096 data bits per frame. When GSYNC = 1, FPER is a don't care value.

Each pulse on FSG has a width of (FWID + 1) CLKG cycles. The eight bits of FWID allow a pulse width of 1 to 256 CLKG cycles. It is recommended that FWID be programmed to a value less than the programmed word length.

The values in FPER and FWID are loaded into separate down-counters. The 12-bit FPER counter counts down the generated clock cycles from the programmed value (4095 maximum) to 0. The 8-bit FWID counter counts down from the programmed value (255 maximum) to 0. Table 7-22 shows settings for FPER and FWID.

Figure 7-7 shows a frame-synchronization period of 16 CLKG periods (FPER = 15 or 00001111b) and a frame-synchronization pulse with an active width of 2 CLKG periods (FWID = 1).

Table 7-22. Register Bits Used to Set the SRG Frame-Synchronization Period and Pulse Width

Register	Bit	Name	Function	Type	Reset Value
SRGR2	11-0	FPER	Sample rate generator frame-synchronization period For the frame-synchronization signal FSG, (FPER + 1) determines the period from the start of a frame-synchronization pulse to the start of the next frame-synchronization pulse. Range for (FPER + 1): 1 to 4096 CLKG cycles	R/W	0000 0000 0000
SRGR1	15-8	FWID	Sample rate generator frame-synchronization pulse width This field plus 1 determines the width of each frame-synchronization pulse on FSG.	R/W	0000 0000

Table 7-22. Register Bits Used to Set the SRG Frame-Synchronization Period and Pulse Width (continued)

Register	Bit	Name	Function	Type	Reset Value
			Range for (FWID + 1): 1 to 256 CLKG cycles		

Figure 7-7. Frame of Period 16 CLKG Periods and Active Width of 2 CLKG Periods

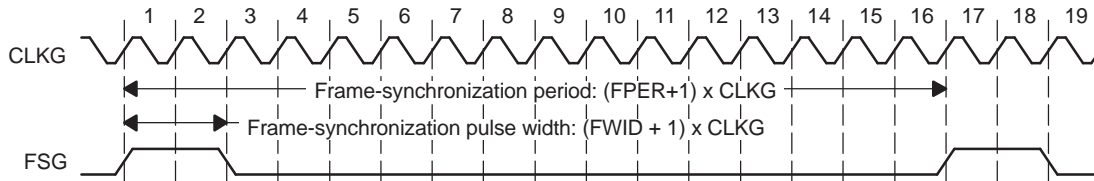

When the sample rate generator comes out of reset, FSG is in its inactive state. Then, when GRST = 1 and FSGM = 1, a frame-synchronization pulse is generated. The frame width value (FWID + 1) is counted down on every CLKG cycle until it reaches 0, at which time FSG goes low. At the same time, the frame period value (FPER + 1) is also counting down. When this value reaches 0, FSG goes high, indicating a new frame.

7.17 Set the Receive Clock Mode

Table 7-23 shows the settings for bits used to set receive clock mode.

Table 7-23. Register Bits Used to Set the Receive Clock Mode

Register	Bit	Name	Function	Type	Reset Value
PCR	8	CLKRM	Receive clock mode	R/W	0
			Case 1: Digital loopback mode not set (DLB = 0) in SPCR1.		
			CLKRM = 0 The MCLKR pin is an input pin that supplies the internal receive clock (MCLKR).		
			CLKRM = 1 Internal MCLKR is driven by the sample rate generator of the McBSP. The MCLKR pin is an output pin that reflects internal MCLKR.		
			Case 2: Digital loopback mode set (DLB = 1) in SPCR1.		
			CLKRM = 0 The MCLKR pin is in the high impedance state. The internal receive clock (MCLKR) is driven by the internal transmit clock (CLKX). Internal CLKX is derived according to the CLKXM bit of PCR.		
			CLKRM = 1 Internal MCLKR is driven by internal CLKX. The MCLKR pin is an output pin that reflects internal MCLKR. Internal CLKX is derived according to the CLKXM bit of PCR.		
SPCR1	15	DLB	Digital loopback mode	R/W	00
			DLB = 0 Digital loopback mode is disabled.		
			DLB = 1 Digital loopback mode is enabled. The receive signals, including the receive frame-synchronization signal, are connected internally through multiplexers to the corresponding transmit signals.		

Table 7-23. Register Bits Used to Set the Receive Clock Mode (continued)

Register	Bit	Name	Function	Type	Reset Value	
SPCR1	12-11	CLKSTP	Clock stop mode	R/W	00	
			CLKSTP = 0xb			Clock stop mode disabled; normal clocking for non-SPI mode.
			CLKSTP = 10b			Clock stop mode enabled without clock delay. The internal receive clock signal (MCLKR) and the internal receive frame-synchronization signal (FSR) are internally connected to their transmit counterparts, CLKX and FSX.
			CLKSTP = 11b		Clock stop mode enabled with clock delay. The internal receive clock signal (MCLKR) and the internal receive frame-synchronization signal (FSR) are internally connected to their transmit counterparts, CLKX and FSX.	

7.17.1 Selecting a Source for the Receive Clock and a Data Direction for the MCLKR Pin

Table 7-24 shows how you can select various sources to provide the receive clock signal and affect the MCLKR pin. The polarity of the signal on the MCLKR pin is determined by the CLKRP bit.

In the digital loopback mode (DLB = 1), the transmit clock signal is used as the receive clock signal.

Also, in the clock stop mode, the internal receive clock signal (MCLKR) and the internal receive frame-synchronization signal (FSR) are internally connected to their transmit counterparts, CLKX and FSX.

Table 7-24. Receive Clock Signal Source Selection

DLB in SPCR1	CLKRM in PCR	Source of Receive Clock	MCLKR Pin Status
0	0	The MCLKR pin is an input driven by an external clock. The external clock signal is inverted as determined by CLKRP before being used.	Input
0	1	The sample rate generator clock (CLKG) drives internal MCLKR.	Output. CLKG, inverted as determined by CLKRP, is driven out on the MCLKR pin.
1	0	Internal CLKX drives internal MCLKR. To configure CLKX, see Section 8.18, Set the Transmit Clock Mode .	High impedance
1	1	Internal CLKX drives internal MCLKR. To configure CLKX, see Section 8.18, Set the Transmit Clock Mode .	Output. Internal MCLKR (same as internal CLKX) is inverted as determined by CLKRP before being driven out on the MCLKR pin.

7.18 Set the Receive Clock Polarity

Table 7-25. Register Bit Used to Set Receive Clock Polarity

Register	Bit	Name	Function	Type	Reset Value	
PCR	0	CLKRP	Receive clock polarity	R/W	0	
			CLKRP = 0			Receive data sampled on falling edge of MCLKR
			CLKRP = 1			Receive data sampled on rising edge of MCLKR

7.18.1 Frame Synchronization Pulses, Clock Signals, and Their Polarities

Receive frame-synchronization pulses can be generated internally by the sample rate generator (see Section 3.2) or driven by an external source. The source of frame synchronization is selected by programming the mode bit, FSRM, in PCR. FSR is also affected by the GSYNC bit in SRGR2. For information about the effects of FSRM and GSYNC, see Section 7.15, *Set the Receive Frame-Synchronization Mode*. Similarly, receive clocks can be selected to be inputs or outputs by programming the mode bit, CLKRM, in the PCR (see Section 7.17, *Set the Receive Clock Mode*).

When FSR and FSX are inputs (FSXM = FSRM = 0, external frame-synchronization pulses), the McBSP detects them on the internal falling edge of clock, internal MCLKR, and internal CLKX, respectively. The receive data arriving at the DR pin is also sampled on the falling edge of internal MCLKR. These internal clock signals are either derived from external source via CLK(R/X) pins or driven by the sample rate generator clock (CLKG) internal to the McBSP.

When FSR and FSX are outputs, implying that they are driven by the sample rate generator, they are generated (transition to their active state) on the rising edge of internal clock, CLK(R/X). Similarly, data on the DX pin is output on the rising edge of internal CLKX.

FSRP, FSXP, CLKRP, and CLKXP in the pin control register (PCR) configure the polarities of the FSR, FSX, MCLKR, and CLKX signals, respectively. All frame-synchronization signals (internal FSR, internal FSX) that are internal to the serial port are active high. If the serial port is configured for external frame synchronization (FSR/FSX are inputs to McBSP) and FSRP = FSXP = 1, the external active-low frame-synchronization signals are inverted before being sent to the receiver (internal FSR) and transmitter (internal FSX). Similarly, if internal synchronization (FSR/FSX are output pins and GSYNC = 0) is selected, the internal active-high frame-synchronization signals are inverted, if the polarity bit FS(R/X)P = 1, before being sent to the FS(R/X) pin.

On the transmit side, the transmit clock polarity bit, CLKXP, sets the edge used to shift and clock out transmit data. Data is always transmitted on the rising edge of internal CLKX. If CLKXP = 1 and external clocking is selected (CLKXM = 0 and CLKX is an input), the external falling-edge triggered input clock on CLKX is inverted to a rising-edge triggered clock before being sent to the transmitter. If CLKXP = 1 and internal clocking is selected (CLKXM = 1 and CLKX is an output pin), the internal (rising-edge triggered) clock, internal CLKX, is inverted before being sent out on the MCLKX pin.

Similarly, the receiver can reliably sample data that is clocked with a rising edge clock (by the transmitter). The receive clock polarity bit, CLKRP, sets the edge used to sample received data. The receive data is always sampled on the falling edge of internal MCLKR. Therefore, if CLKRP = 1 and external clocking is selected (CLKRM = 0 and MCLKR is an input pin), the external rising-edge triggered input clock on MCLKR is inverted to a falling-edge triggered clock before being sent to the receiver. If CLKRP = 1 and internal clocking is selected (CLKRM = 1), the internal falling-edge triggered clock is inverted to a rising-edge triggered clock before being sent out on the MCLKR pin.

CLKRP = CLKXP in a system where the same clock (internal or external) is used to clock the receiver and transmitter. The receiver uses the opposite edge as the transmitter to ensure valid setup and hold of data around this edge. Figure 7-8 shows how data clocked by an external serial device using a rising edge can be sampled by the McBSP receiver on the falling edge of the same clock.

Figure 7-8. Data Clocked Externally Using a Rising Edge and Sampled by the McBSP Receiver on a Falling Edge

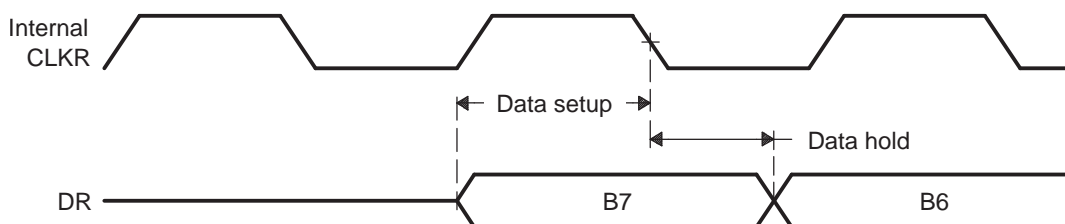

7.19 Set the SRG Clock Divide-Down Value

Table 7-26. Register Bits Used to Set the Sample Rate Generator (SRG) Clock Divide-Down Value

Register	Bit	Name	Function	Type	Reset Value
SRGR1	7-0	CLKGDV	Sample rate generator clock divide-down value The input clock of the sample rate generator is divided by (CLKGDV + 1) to generate the required sample rate generator clock frequency. The default value of CLKGDV is 1 (divide input clock by 2).	R/W	0000 0001

7.19.1 Sample Rate Generator Clock Divider

The first divider stage generates the serial data bit clock from the input clock. This divider stage utilizes a counter, preloaded by CLKGDV, that contains the divide ratio value.

The output of the first divider stage is the data bit clock, which is output as CLKG and which serves as the input for the second and third stages of the divider.

CLKG has a frequency equal to $1/(\text{CLKGDV} + 1)$ of sample rate generator input clock. Thus, the sample generator input clock frequency is divided by a value between 1 and 256. When CLKGDV is odd or equal to 0, the CLKG duty cycle is 50%. When CLKGDV is an even value, $2p$, representing an odd divide-down, the high-state duration is $p + 1$ cycles and the low-state duration is p cycles.

7.20 Set the SRG Clock Synchronization Mode

For more details on using the clock synchronization feature, see [Section 3.3, Synchronizing Sample Rate Generator Outputs to an External Clock](#).

Table 7-27. Register Bit Used to Set the SRG Clock Synchronization Mode

Register	Bit	Name	Function	Type	Reset Value
SRGR2	15	GSYNC	Sample rate generator clock synchronization GSYNC is used only when the input clock source for the sample rate generator is external—on the MCLKR or MCLKX pin. GSYNC = 0 The sample rate generator clock (CLKG) is free running. CLKG oscillates without adjustment, and FSG pulses every (FPER + 1) CLKG cycles. GSYNC = 1 Clock synchronization is performed. When a pulse is detected on the FSR pin: <ul style="list-style-type: none"> • CLKG is adjusted as necessary so that it is synchronized with the input clock on the MCLKR or MCLKX pin. • FSG pulses. FSG only pulses in response to a pulse on the FSR pin. The frame-synchronization period defined in FPER is ignored. 	R/W	0

7.21 Set the SRG Clock Mode (Choose an Input Clock)

Table 7-28. Register Bits Used to Set the SRG Clock Mode (Choose an Input Clock)

Register	Bit	Name	Function	Type	Reset Value
PCR	7	SCLKME	Sample rate generator clock mode	R/W	0
SRGR2	13	CLKSM	SCLKME = 0 Reserved CLKSM = 0 SCLKME = 0 Sample rate generator clock derived from LSPCLK (default) CLKSM = 1	R/W	1

Table 7-28. Register Bits Used to Set the SRG Clock Mode (Choose an Input Clock) (continued)

Register	Bit	Name	Function	Type	Reset Value
			SCLKME = 1	Sample rate generator clock derived from MCLKR pin	
			CLKSM = 0		
			SCLKME = 1	Sample rate generator clock derived from MCLKX pin	
			CLKSM = 1		

7.21.1 SRG Clock Mode

The sample rate generator can produce a clock signal (CLKG) for use by the receiver, the transmitter, or both, but CLKG is derived from an input clock. [Table 7-28](#) shows the four possible sources of the input clock. For more details on generating CLKG, see [Section 3.1.1](#), *Clock Generation in the Sample Rate Generator*.

7.22 Set the SRG Input Clock Polarity

Table 7-29. Register Bits Used to Set the SRG Input Clock Polarity

Register	Bit	Name	Function	Type	Reset Value
PCR	1	CLKXP	MCLKX pin polarity	R/W	0
			CLKXP determines the input clock polarity when the MCLKX pin supplies the input clock (SCLKME = 1 and CLKSM = 1).		
			CLKXP = 0 Rising edge on MCLKX pin generates transitions on CLKG and FSG. CLKXP = 1 Falling edge on MCLKX pin generates transitions on CLKG and FSG.		
PCR	0	CLKRP	MCLKR pin polarity	R/W	0
			CLKRP determines the input clock polarity when the MCLKR pin supplies the input clock (SCLKME = 1 and CLKSM = 0).		
			CLKRP = 0 Falling edge on MCLKR pin generates transitions on CLKG and FSG. CLKRP = 1 Rising edge on MCLKR pin generates transitions on CLKG and FSG.		

7.22.1 Using CLKXP/CLKRP to Choose an Input Clock Polarity

The sample rate generator can produce a clock signal (CLKG) and a frame-synchronization signal (FSG) for use by the receiver, the transmitter, or both. To produce CLKG and FSG, the sample rate generator must be driven by an input clock signal derived from the CPU clock or from an external clock on the CLKX or MCLKR pin. If you use a pin, choose a polarity for that pin by using the appropriate polarity bit (CLKXP for the MCLKX pin, CLKRP for the MCLKR pin). The polarity determines whether the rising or falling edge of the input clock generates transitions on CLKG and FSG.

Transmitter Configuration

To configure the McBSP transmitter, perform the following procedure:

1. Place the McBSP/transmitter in reset (see [Section 8.2](#)).
2. Program the McBSP registers for the desired transmitter operation (see [Section 8.1](#)).
3. Take the transmitter out of reset (see [Section 8.2](#)).

Topic	Page
8.1 Programming the McBSP Registers for the Desired Transmitter Operation	90
8.2 Resetting and Enabling the Transmitter	90
8.3 Set the Transmitter Pins to Operate as McBSP Pins	91
8.4 Enable/Disable the Digital Loopback Mode	91
8.5 Enable/Disable the Clock Stop Mode	92
8.6 Enable/Disable Transmit Multichannel Selection	93
8.7 Choose One or Two Phases for the Transmit Frame	94
8.8 Set the Transmit Word Length(s)	94
8.9 Set the Transmit Frame Length	95
8.10 Enable/Disable the Transmit Frame-Synchronization Ignore Function	96
8.11 Set the Transmit Companding Mode	97
8.12 Set the Transmit Data Delay	98
8.13 Set the Transmit DXENA Mode	100
8.14 Set the Transmit Interrupt Mode	100
8.15 Set the Transmit Frame-Synchronization Mode	101
8.16 Set the Transmit Frame-Synchronization Polarity	102
8.17 Set the SRG Frame-Synchronization Period and Pulse Width	103
8.18 Set the Transmit Clock Mode	104
8.19 Set the Transmit Clock Polarity	104

8.1 Programming the McBSP Registers for the Desired Transmitter Operation

The following is a list of important tasks to be performed when you are configuring the McBSP transmitter. Each task corresponds to one or more McBSP register bit fields.

- Global behavior:
 - Set the transmitter pins to operate as McBSP pins.
 - Enable/disable the digital loopback mode.
 - Enable/disable the clock stop mode.
 - Enable/disable transmit multichannel selection.
- Data behavior:
 - Choose 1 or 2 phases for the transmit frame.
 - Set the transmit word length(s).
 - Set the transmit frame length.
 - Enable/disable the transmit frame-synchronization ignore function.
 - Set the transmit companding mode.
 - Set the transmit data delay.
 - Set the transmit DXENA mode.
 - Set the transmit interrupt mode.
- Frame-synchronization behavior:
 - Set the transmit frame-synchronization mode.
 - Set the transmit frame-synchronization polarity.
 - Set the SRG frame-synchronization period and pulse width.
- Clock behavior:
 - Set the transmit clock mode.
 - Set the transmit clock polarity.
 - Set the SRG clock divide-down value.
 - Set the SRG clock synchronization mode.
 - Set the SRG clock mode (choose an input clock).
 - Set the SRG input clock polarity.

8.2 Resetting and Enabling the Transmitter

The first step of the transmitter configuration procedure is to reset the transmitter, and the last step is to enable the transmitter (to take it out of reset). [Table 8-1](#) describes the bits used for both of these steps.

Table 8-1. Register Bits Used to Place Transmitter in Reset Field Descriptions

Register	Bit	Field	Value	Description
SPCR2	7	FRST	0	Frame-synchronization logic is reset. The sample rate generator does not generate frame-synchronization signal FSG, even if GRST = 1.
			1	Frame-synchronization is enabled. If GRST = 1, frame-synchronization signal FSG is generated after (FPER + 1) number of CLKG clock cycles; all frame counters are loaded with their programmed values.
SPCR2	6	GRST	0	Sample rate generator is reset. If GRST = 0 due to a device reset, CLKG is driven by the CPU clock divided by 2, and FSG is driven low (inactive). If GRST = 0 due to program code, CLKG and FSG are both driven low (inactive).
			1	Sample rate generator is enabled. CLKG is driven according to the configuration programmed in the sample rate generator registers (SRGR[1,2]). If FRST = 1, the generator also generates the frame-synchronization signal FSG as programmed in the sample rate generator registers.

Table 8-1. Register Bits Used to Place Transmitter in Reset Field Descriptions (continued)

Register	Bit	Field	Value	Description
SPCR2	0	XRST		Transmitter reset
			0	The serial port transmitter is disabled and in the reset state.
			1	The serial port transmitter is enabled.

8.2.1 Reset Considerations

The serial port can be reset in the following two ways:

1. A DSP reset ($\overline{\text{XRS}}$ signal driven low) places the receiver, transmitter, and sample rate generator in reset. When the device reset is removed, $\text{GRST} = \text{FRST} = \text{RRST} = \text{XRST} = 0$, keeping the entire serial port in the reset state.
2. The serial port transmitter and receiver can be reset directly using the RRST and XRST bits in the serial port control registers. The sample rate generator can be reset directly using the GRST bit in SPCR2 .
3. When using the DMA, the order in which McBSP events must occur is important. DMA channel and peripheral interrupts must be configured prior to releasing the McBSP transmitter from reset. The reason for this is that an XRDY is fired when $\text{XRST} = 1$. The XRDY signals the DMA to start copying data from the buffer into the transmit register. If the McBSP transmitter is released from reset before the DMA channel and peripheral interrupts are configured, the XRDY signals before the DMA channel can receive the signal; therefore, the DMA does not move the data from the buffer to the transmit register. The DMA PERINTFLG is edge-sensitive and will fail to recognize the XRDY , which is continuously high.

For more details about McBSP reset conditions and effects, see [Section 9.2, Resetting and Initializing a McBSP](#).

8.3 Set the Transmitter Pins to Operate as McBSP Pins

To configure a pin for its McBSP function, you should configure the bits of the GPxMUXn register appropriately. In addition to this, bits 12 and 13 of the PCR register must be set to 0. These bits are defined as reserved.

8.4 Enable/Disable the Digital Loopback Mode

The DLB bit determines whether the digital loopback mode is on. DLB is described in [Table 8-2](#).

Table 8-2. Register Bit Used to Enable/Disable the Digital Loopback Mode

Register	Bit	Name	Function	Type	Reset Value	
SPCR1	15	DLB	Digital loopback mode	R/W	0	
			$\text{DLB} = 0$			Digital loopback mode is disabled.
			$\text{DLB} = 1$			Digital loopback mode is enabled.

8.4.1 Digital Loopback Mode

In the digital loopback mode, the receive signals are connected internally through multiplexers to the corresponding transmit signals, as shown in [Table 8-3](#). This mode allows testing of serial port code with a single DSP device; the McBSP receives the data it transmits.

Table 8-3. Receive Signals Connected to Transmit Signals in Digital Loopback Mode

This Receive Signal	Is Fed Internally by This Transmit Signal
DR (receive data)	DX (transmit data)
FSR (receive frame synchronization)	FSX (transmit frame synchronization)

Table 8-3. Receive Signals Connected to Transmit Signals in Digital Loopback Mode (continued)

This Receive Signal	Is Fed Internally by This Transmit Signal
MCLKR (receive clock)	CLKX (transmit clock)

8.5 Enable/Disable the Clock Stop Mode

The CLKSTP bits determine whether the clock stop mode is on. CLKSTP is described in [Table 8-4](#).

Table 8-4. Register Bits Used to Enable/Disable the Clock Stop Mode

Register	Bit	Name	Function	Type	Reset Value	
SPCR1	12-11	CLKSTP	Clock stop mode		R/W	00
			CLKSTP = 0Xb	Clock stop mode disabled; normal clocking for non-SPI mode.		
			CLKSTP = 10b	Clock stop mode enabled without clock delay		
			CLKSTP = 11b	Clock stop mode enabled with clock delay		

8.5.1 Clock Stop Mode

The clock stop mode supports the SPI master-slave protocol. If you do not plan to use the SPI protocol, you can clear CLKSTP to disable the clock stop mode.

In the clock stop mode, the clock stops at the end of each data transfer. At the beginning of each data transfer, the clock starts immediately (CLKSTP = 10b) or after a half-cycle delay (CLKSTP = 11b). The CLKXP bit determines whether the starting edge of the clock on the MCLKX pin is rising or falling. The CLKRP bit determines whether receive data is sampled on the rising or falling edge of the clock shown on the MCLKR pin.

[Table 8-5](#) summarizes the impact of CLKSTP, CLKXP, and CLKRP on serial port operation. In the clock stop mode, the receive clock is tied internally to the transmit clock, and the receive frame-synchronization signal is tied internally to the transmit frame-synchronization signal.

Table 8-5. Effects of CLKSTP, CLKXP, and CLKRP on the Clock Scheme

Bit Settings	Clock Scheme
CLKSTP = 00b or 01b CLKXP = 0 or 1 CLKRP = 0 or 1	Clock stop mode disabled. Clock enabled for non-SPI mode.
CLKSTP = 10b CLKXP = 0 CLKRP = 0	Low inactive state without delay: The McBSP transmits data on the rising edge of CLKX and receives data on the falling edge of MCLKR.
CLKSTP = 11b CLKXP = 0 CLKRP = 1	Low inactive state with delay: The McBSP transmits data one-half cycle ahead of the rising edge of CLKX and receives data on the rising edge of MCLKR.
CLKSTP = 10b CLKXP = 1 CLKRP = 0	High inactive state without delay: The McBSP transmits data on the falling edge of CLKX and receives data on the rising edge of MCLKR.
CLKSTP = 11b CLKXP = 1 CLKRP = 1	High inactive state with delay: The McBSP transmits data one-half cycle ahead of the falling edge of CLKX and receives data on the falling edge of MCLKR.

8.6 Enable/Disable Transmit Multichannel Selection

For more details, see [Section 5.7](#), *Transmit Multichannel Selection Modes*.

Table 8-6. Register Bits Used to Enable/Disable Transmit Multichannel Selection

Register	Bit	Name	Function	Type	Reset Value
MCR2	1-0	XMCM	Transmit multichannel selection	R/W	00
			XMCM = 00b		
			No transmit multichannel selection mode is on. All channels are enabled and unmasked. No channels can be disabled or masked.		
			XMCM = 01b		
			All channels are disabled unless they are selected in the appropriate transmit channel enable registers (XCERs). If enabled, a channel in this mode is also unmasked.		
			The XMCM bit determines whether 32 channels or 128 channels are selectable in XCERs.		
			XMCM = 10b		
			All channels are enabled, but they are masked unless they are selected in the appropriate transmit channel enable registers (XCERs).		
			The XMCM bit determines whether 32 channels or 128 channels are selectable in XCERs.		
			XMCM = 11b		
			This mode is used for symmetric transmission and reception.		
			All channels are disabled for transmission unless they are enabled for reception in the appropriate receive channel enable registers (RCERs). Once enabled, they are masked unless they are also selected in the appropriate transmit channel enable registers (XCERs).		
			The XMCM bit determines whether 32 channels or 128 channels are selectable in RCERs and XCERs.		

8.7 Choose One or Two Phases for the Transmit Frame

Table 8-7. Register Bit Used to Choose 1 or 2 Phases for the Transmit Frame

Register	Bit	Name	Function	Type	Reset Value
XCR2	15	XPHASE	Transmit phase number Specifies whether the transmit frame has 1 or 2 phases. XPHASE = 0 Single-phase frame XPHASE = 1 Dual-phase frame	R/W	0

8.8 Set the Transmit Word Length(s)

Table 8-8. Register Bits Used to Set the Transmit Word Length(s)

Register	Bit	Name	Function	Type	Reset Value
XCR1	7-5	XWDLEN1	Transmit word length of frame phase 1 XWDLEN1 = 000b 8 bits XWDLEN1 = 001b 12 bits XWDLEN1 = 010b 16 bits XWDLEN1 = 011b 20 bits XWDLEN1 = 100b 24 bits XWDLEN1 = 101b 32 bits XWDLEN1 = 11Xb Reserved	R/W	000
XCR2	7-5	XWDLEN2	Transmit word length of frame phase 2 XWDLEN2 = 000b 8 bits XWDLEN2 = 001b 12 bits XWDLEN2 = 010b 16 bits XWDLEN2 = 011b 20 bits XWDLEN2 = 100b 24 bits XWDLEN2 = 101b 32 bits XWDLEN2 = 11Xb Reserved	R/W	000

8.8.1 Word Length Bits

Each frame can have one or two phases, depending on the value that you load into the RPHASE bit. If a single-phase frame is selected, XWDLEN1 selects the length for every serial word transmitted in the frame. If a dual-phase frame is selected, XWDLEN1 determines the length of the serial words in phase 1 of the frame, and XWDLEN2 determines the word length in phase 2 of the frame.

8.9 Set the Transmit Frame Length

Table 8-9. Register Bits Used to Set the Transmit Frame Length

Register	Bit	Name	Function	Type	Reset Value	
XCR1	14-8	XFRLN1	Transmit frame length 1	R/W	000 0000	
			(XFRLN1 + 1) is the number of serial words in phase 1 of the transmit frame.			
			XFRLN1 = 000 0000			1 word in phase 1
			XFRLN1 = 000 0001			2 words in phase 1
XCR2	14-8	XFRLN2	Transmit frame length 2	R/W	000 0000	
			If a dual-phase frame is selected, (XFRLN2 + 1) is the number of serial words in phase 2 of the transmit frame.			
			XFRLN2 = 000 0000			1 word in phase 2
			XFRLN2 = 000 0001			2 words in phase 2
		XFRLN2 = 111 1111	128 words in phase 2			

8.9.1 Selected Frame Length

The transmit frame length is the number of serial words in the transmit frame. Each frame can have one or two phases, depending on the value that you load into the XPHASE bit.

If a single-phase frame is selected (XPHASE = 0), the frame length is equal to the length of phase 1. If a dual-phase frame is selected (XPHASE = 1), the frame length is the length of phase 1 plus the length of phase 2.

The 7-bit XFRLN fields allow up to 128 words per phase. See [Table 8-10](#) for a summary of how to calculate the frame length. This length corresponds to the number of words or logical time slots or channels per frame-synchronization pulse.

NOTE: Program the XFRLN fields with [*w minus 1*], where *w* represents the number of words per phase. For example, if you want a phase length of 128 words in phase 1, load 127 into XFRLN1.

Table 8-10. How to Calculate Frame Length

XPHASE	XFRLN1	XFRLN2	Frame Length
0	$0 \leq \text{XFRLN1} \leq 127$	Don't care	(XFRLN1 + 1) words
1	$0 \leq \text{XFRLN1} \leq 127$	$0 \leq \text{XFRLN2} \leq 127$	(XFRLN1 + 1) + (XFRLN2 + 1) words

8.10 Enable/Disable the Transmit Frame-Synchronization Ignore Function

Table 8-11. Register Bit Used to Enable/Disable the Transmit Frame-Synchronization Ignore Function

Register	Bit	Name	Function	Type	Reset Value
XCR2	2	XFIG	Transmit frame-synchronization ignore	R/W	0
			XFIG = 0		An unexpected transmit frame-synchronization pulse causes the McBSP to restart the frame transfer.
			XFIG = 1		The McBSP ignores unexpected transmit frame-synchronization pulses.

8.10.1 Unexpected Frame-Synchronization Pulses and Frame-Synchronization Ignore

If a frame-synchronization pulse starts the transfer of a new frame before the current frame is fully transmitted, this pulse is treated as an unexpected frame-synchronization pulse.

When XFIG = 1, normal transmission continues with unexpected frame-synchronization signals ignored.

When XFIG = 0 and an unexpected frame-synchronization pulse occurs, the serial port:

1. Aborts the present transmission
2. Sets XSYNCERR to 1 in SPCR2
3. Reinitiates transmission of the current word that was aborted

For more details about the frame-synchronization error condition, see [Section 4.6, Unexpected Transmit Frame-Synchronization Pulse](#).

8.10.2 Examples Showing the Effects of XFIG

Figure 8-1 shows an example in which word B is interrupted by an unexpected frame-synchronization pulse when (R/X)FIG = 0. In the case of transmission, the transmission of B is aborted (B is lost). This condition is a transmit synchronization error, which sets the XSYNCERR bit. No new data has been written to DXR[1,2]; therefore, the McBSP transmits B again.

Figure 8-1. Unexpected Frame-Synchronization Pulse With (R/X) FIG = 0

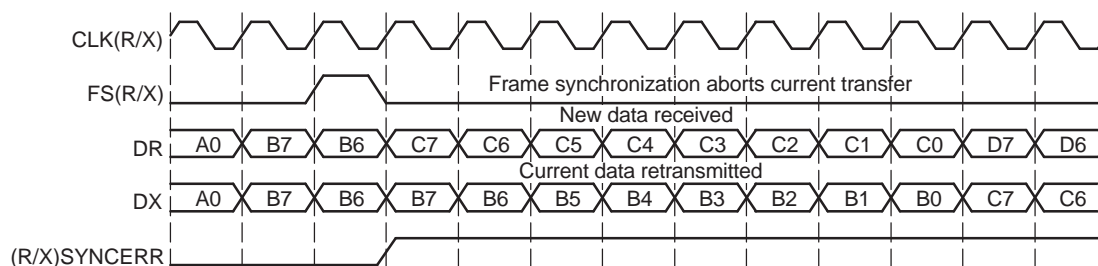

In contrast with Figure 8-1, Figure 8-2 shows McBSP operation when unexpected frame-synchronization signals are ignored (when (R/X)FIG = 1). Here, the transfer of word B is not affected by an unexpected frame-synchronization pulse.

Figure 8-2. Unexpected Frame-Synchronization Pulse With (R/X) FIG = 1

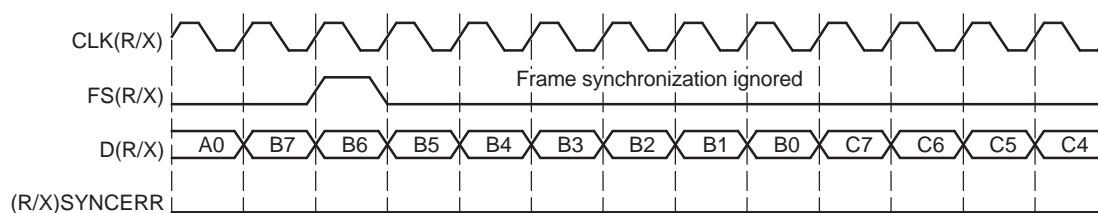

8.11 Set the Transmit Companding Mode

Table 8-12. Register Bits Used to Set the Transmit Companding Mode

Register	Bit	Name	Function	Type	Reset Value
XCR2	4-3	XCOMPAND	Transmit companding mode Modes other than 00b are enabled only when the appropriate XWDLEN is 000b, indicating 8-bit data. XCOMPAND = 00b No companding, any size data, MSB transmitted first XCOMPAND = 01b No companding, 8-bit data, LSB transmitted first (for details, see Section 7.11.4, Option to Receive LSB First) XCOMPAND = 10b μ -law companding, 8-bit data, MSB transmitted first XCOMPAND = 11b A-law companding, 8-bit data, MSB transmitted first	R/W	00

8.11.1 Companding

Companding (COMpressing and exPANDING) hardware allows compression and expansion of data in either μ -law or A-law format. The companding standard employed in the United States and Japan is μ -law. The European companding standard is referred to as A-law. The specifications for μ -law and A-law log PCM are part of the CCITT G.711 recommendation.

A-law and μ -law allow 13 bits and 14 bits of dynamic range, respectively. Any values outside this range are set to the most positive or most negative value. Thus, for companding to work best, the data transferred to and from the McBSP via the CPU or DMA controller must be at least 16 bits wide.

The μ -law and A-law formats both encode data into 8-bit code words. Companded data is always 8 bits wide; the appropriate word length bits (RWDLEN1, RWDLEN2, XWDLEN1, XWDLEN2) must therefore be set to 0, indicating an 8-bit wide serial data stream. If companding is enabled and either of the frame phases does not have an 8-bit word length, companding continues as if the word length is 8 bits.

[Figure 8-3](#) illustrates the companding processes. When companding is chosen for the transmitter, compression occurs during the process of copying data from DXR1 to XSR1. The transmit data is encoded according to the specified companding law (A-law or μ -law). When companding is chosen for the receiver, expansion occurs during the process of copying data from RBR1 to DRR1. The receive data is decoded to twos-complement format.

Figure 8-3. Companding Processes for Reception and for Transmission

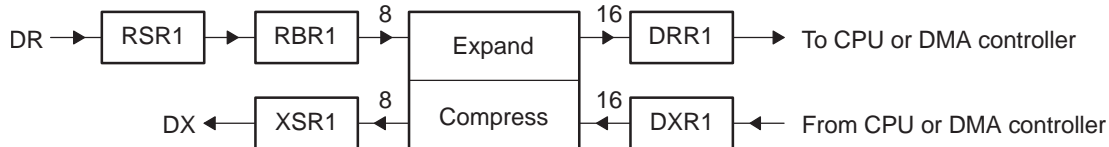

8.11.2 Format for Data To Be Compressed

For transmission using μ -law compression, make sure the 14 data bits are left-justified in DXR1, with the remaining two low-order bits filled with 0s as shown in [Figure 8-4](#).

Figure 8-4. μ -Law Transmit Data Companding Format

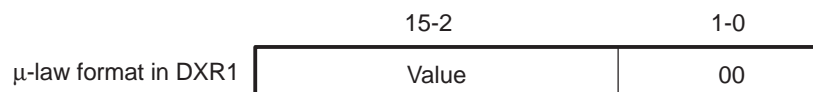

For transmission using A-law compression, make sure the 13 data bits are left-justified in DXR1, with the remaining three low-order bits filled with 0s as shown in [Figure 8-5](#).

Figure 8-5. A-Law Transmit Data Companding Format

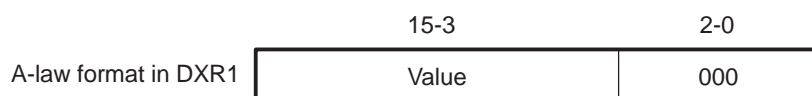

8.11.3 Capability to Compand Internal Data

If the McBSP is otherwise unused (the serial port transmit and receive sections are reset), the companding hardware can compand internal data. See [Section 2.2.2, Capability to Compand Internal Data](#).

8.11.4 Option to Transmit LSB First

Normally, the McBSP transmit or receives all data with the most significant bit (MSB) first. However, certain 8-bit data protocols (that do not use companded data) require the least significant bit (LSB) to be transferred first. If you set XCOMPAND = 01b in XCR2, the bit ordering of 8-bit words is reversed (LSB first) before being sent from the serial port. Similar to companding, this feature is enabled only if the appropriate word length bits are set to 0, indicating that 8-bit words are to be transferred serially. If either phase of the frame does not have an 8-bit word length, the McBSP assumes the word length is eight bits and LSB-first ordering is done.

8.12 Set the Transmit Data Delay

Table 8-13. Register Bits Used to Set the Transmit Data Delay

Register	Bit	Name	Function	Type	Reset Value	
XCR2	1-0	XDATDLY	Transmitter data delay	R/W	00	
			XDATDLY = 00			0-bit data delay
			XDATDLY = 01			1-bit data delay
			XDATDLY = 10			2-bit data delay
			XDATDLY = 11			Reserved

8.12.1 Data Delay

The start of a frame is defined by the first clock cycle in which frame synchronization is found to be active. The beginning of actual data reception or transmission with respect to the start of the frame can be delayed if necessary. This delay is called data delay.

XDATDLY specifies the data delay for transmission. The range of programmable data delay is zero to two bit-clocks (XDATDLY = 00b-10b), as described in [Table 8-13](#) and [Figure 8-6](#). In this figure, the data transferred is an 8-bit value with bits labeled B7, B6, B5, and so on. Typically a 1-bit delay is selected, because data often follows a 1-cycle active frame-synchronization pulse.

Figure 8-6. Range of Programmable Data Delay

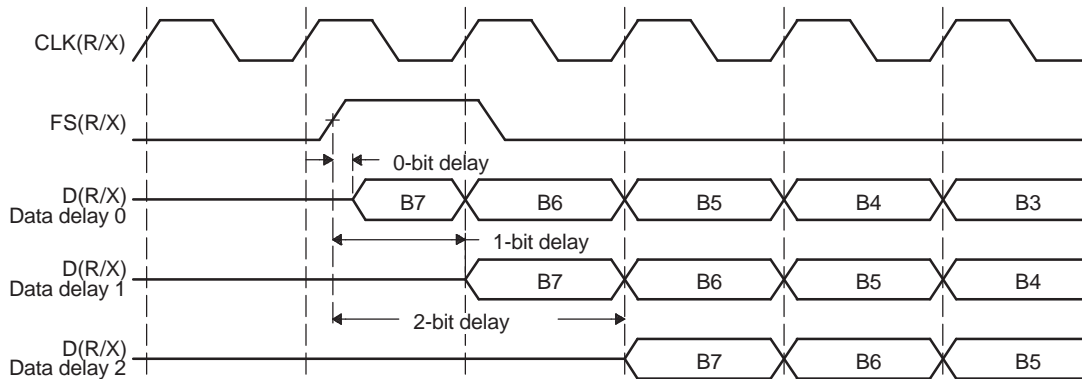

8.12.2 0-Bit Data Delay

Normally, a frame-synchronization pulse is detected or sampled with respect to an edge of serial clock internal CLK(R/X). Thus, on the following cycle or later (depending on the data delay value), data can be received or transmitted. However, in the case of 0-bit data delay, the data must be ready for reception and/or transmission on the same serial clock cycle.

For reception this problem is solved because receive data is sampled on the first falling edge of MCLKR where an active-high internal FSR is detected. However, data transmission must begin on the rising edge of the internal CLKX clock that generated the frame synchronization. Therefore, the first data bit is assumed to be present in XSR1, and thus DX. The transmitter then asynchronously detects the frame synchronization, FSX, going active high and immediately starts driving the first bit to be transmitted on the DX pin.

8.12.3 2-Bit Data Delay

A data delay of two bit-periods allows the serial port to interface to different types of T1 framing devices where the data stream is preceded by a framing bit. During reception of such a stream with data delay of two bits (framing bit appears after a 1-bit delay and data appears after a 2-bit delay), the serial port essentially discards the framing bit from the data stream, as shown in the following figure. In this figure, the data transferred is an 8-bit value with bits labeled B7, B6, B5, and so on.

Figure 8-7. 2-Bit Data Delay Used to Skip a Framing Bit

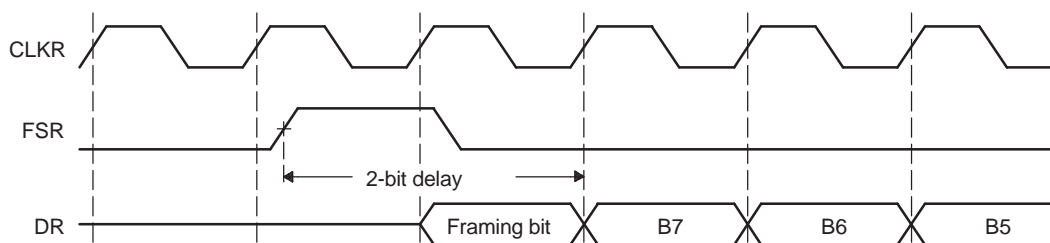

8.13 Set the Transmit DXENA Mode

Table 8-14. Register Bit Used to Set the Transmit DXENA (DX Delay Enabler) Mode

Register	Bit	Name	Function	Type	Reset Value	
SPCR1	7	DXENA	DX delay enabler mode	R/W	0	
			DXENA = 0			DX delay enabler is off.
			DXENA = 1			DX delay enabler is on.

8.13.1 DXENA Mode

The DXENA bit controls the delay enabler on the DX pin. Set DXENA to enable an extra delay for turn-on time. This bit does not control the data itself, so only the first bit is delayed.

If you tie together the DX pins of multiple McBSPs, make sure DXENA = 1 to avoid having more than one McBSP transmit on the data line at one time.

8.14 Set the Transmit Interrupt Mode

The transmitter interrupt (XINT) signals the CPU of changes to the serial port status. Four options exist for configuring this interrupt. The options are set by the transmit interrupt mode bits, XINTM, in SPCR2.

Table 8-15. Register Bits Used to Set the Transmit Interrupt Mode

Register	Bit	Name	Function	Type	Reset Value	
SPCR2	5-4	XINTM	Transmit interrupt mode	R/W	00	
			XINTM = 00			XINT generated when XRDY changes from 0 to 1.
			XINTM = 01			XINT generated by an end-of-block or end-of-frame condition in a transmit multichannel selection mode. In any of the transmit multichannel selection modes, interrupt after every 16-channel block boundary has been crossed within a frame and at the end of the frame. For details, see Section 5.8, Using Interrupts Between Block Transfers . In any other serial transfer case, this setting is not applicable and, therefore, no interrupts are generated.
			XINTM = 10			XINT generated by a new transmit frame-synchronization pulse. Interrupt on detection of each transmit frame-synchronization pulse. This generates an interrupt even when the transmitter is in its reset state. This is done by synchronizing the incoming frame-synchronization pulse to the CPU clock and sending it to the CPU via XINT.
XINTM = 11	XINT generated when XSYNCERR is set. Interrupt on frame-synchronization error. Regardless of the value of XINTM, XSYNCERR can be read to detect this condition. For more information on using XSYNCERR, see Section 4.6, Unexpected Transmit Frame-Synchronization Pulse .					

8.15 Set the Transmit Frame-Synchronization Mode

Table 8-16. Register Bits Used to Set the Transmit Frame-Synchronization Mode

Register	Bit	Name	Function	Type	Reset Value	
PCR	11	FSXM	Transmit frame-synchronization mode	R/W	0	
			FSXM = 0			Transmit frame synchronization is supplied by an external source via the FSX pin.
			FSXM = 1			Transmit frame synchronization is supplied by the McBSP, as determined by the FSGM bit of SRGR2.
SRGR2	12	FSGM	Sample rate generator transmit frame-synchronization mode	R/W	0	
			Used when FSXM = 1 in PCR.			
			FSGM = 0			The McBSP generates a transmit frame-synchronization pulse when the content of DXR[1,2] is copied to XSR[1,2].
		FSGM = 1	The transmitter uses frame-synchronization pulses generated by the sample rate generator. Program the FWID bits to set the width of each pulse. Program the FPER bits to set the frame-synchronization period.			

8.15.1 Transmit Frame-Synchronization Modes

Table 8-17 shows how FSXM and FSGM select the source of transmit frame-synchronization pulses. The three choices are:

- External frame-synchronization input
- Sample rate generator frame-synchronization signal (FSG)
- Internal signal that indicates a DXR-to-XSR copy has been made

Table 8-17 also shows the effect of each bit setting on the FSX pin. The polarity of the signal on the FSX pin is determined by the FSXP bit.

Table 8-17. How FSXM and FSGM Select the Source of Transmit Frame-Synchronization Pulses

FSXM	FSGM	Source of Transmit Frame Synchronization	FSX Pin Status
0	0 or 1	An external frame-synchronization signal enters the McBSP through the FSX pin. The signal is then inverted by FSXP before being used as internal FSX.	Input
1	1	Internal FSX is driven by the sample rate generator frame-synchronization signal (FSG).	Output. FSG is inverted by FSXP before being driven out on FSX pin.
1	0	A DXR-to-XSR copy causes the McBSP to generate a transmit frame-synchronization pulse that is 1 cycle wide.	Output. The generated frame-synchronization pulse is inverted as determined by FSXP before being driven out on FSX pin.

8.15.2 Other Considerations

If the sample rate generator creates a frame-synchronization signal (FSG) that is derived from an external input clock, the GSYNC bit determines whether FSG is kept synchronized with pulses on the FSR pin. For more details, see [Section 3.3, Synchronizing Sample Rate Generator Outputs to an External Clock](#).

In the clock stop mode (CLKSTP = 10b or 11b), the McBSP can act as a master or as a slave in the SPI protocol. If the McBSP is a master and must provide a slave-enable signal (SPISTE) on the FSX pin, make sure that FSXM = 1 and FSGM = 0 so that FSX is an output and is driven active for the duration of each transmission. If the McBSP is a slave, make sure that FSXM = 0 so that the McBSP can receive the slave-enable signal on the FSX pin.

8.16 Set the Transmit Frame-Synchronization Polarity

Table 8-18. Register Bit Used to Set Transmit Frame-Synchronization Polarity

Register	Bit	Name	Function	Type	Reset Value
PCR	3	FSXP	Transmit frame-synchronization polarity	R/W	0
			FSXP = 0 Frame-synchronization pulse FSX is active high.		
			FSXP = 1 Frame-synchronization pulse FSX is active low.		

8.16.1 Frame Synchronization Pulses, Clock Signals, and Their Polarities

Transmit frame-synchronization pulses can be generated internally by the sample rate generator (see [Section 3.2](#)) or driven by an external source. The source of frame synchronization is selected by programming the mode bit, FSXM, in PCR. FSX is also affected by the FSGM bit in SRGR2. For information about the effects of FSXM and FSGM, see [Section 8.15, Set the Transmit Frame-Synchronization Mode](#)). Similarly, transmit clocks can be selected to be inputs or outputs by programming the mode bit, CLKXM, in the PCR (see [Section 8.18, Set the Transmit Clock Mode](#)).

When FSR and FSX are inputs (FSXM = FSRM = 0, external frame-synchronization pulses), the McBSP detects them on the internal falling edge of clock, internal MCLKR, and internal CLKX, respectively. The receive data arriving at the DR pin is also sampled on the falling edge of internal MCLKR. These internal clock signals are either derived from external source via CLK(R/X) pins or driven by the sample rate generator clock (CLKG) internal to the McBSP.

When FSR and FSX are outputs, implying that they are driven by the sample rate generator, they are generated (transition to their active state) on the rising edge of internal clock, CLK(R/X). Similarly, data on the DX pin is output on the rising edge of internal CLKX.

FSRP, FSXP, CLKRP, and CLKXP in the pin control register (PCR) configure the polarities of the FSR, FSX, MCLKR, and CLKX signals, respectively. All frame-synchronization signals (internal FSR, internal FSX) that are internal to the serial port are active high. If the serial port is configured for external frame synchronization (FSR/FSX are inputs to McBSP) and FSRP = FSXP = 1, the external active-low frame-synchronization signals are inverted before being sent to the receiver (internal FSR) and transmitter (internal FSX). Similarly, if internal synchronization (FSR/FSX are output pins and GSYNC = 0) is selected and the polarity bit FS(R/X)P = 1, the internal active-high frame-synchronization signals are inverted before being sent to the FS(R/X) pin.

On the transmit side, the transmit clock polarity bit, CLKXP, sets the edge used to shift and clock out transmit data. Data is always transmitted on the rising edge of internal CLKX. If CLKXP = 1 and external clocking is selected (CLKXM = 0 and CLKX is an input), the external falling-edge triggered input clock on CLKX is inverted to a rising-edge triggered clock before being sent to the transmitter. If CLKXP = 1, and internal clocking selected (CLKXM = 1 and CLKX is an output pin), the internal (rising-edge triggered) clock, internal CLKX, is inverted before being sent out on the MCLKX pin.

Similarly, the receiver can reliably sample data that is clocked with a rising edge clock (by the transmitter). The receive clock polarity bit, CLKRP, sets the edge used to sample received data. The receive data is always sampled on the falling edge of internal MCLKR. Therefore, if CLKRP = 1 and external clocking is selected (CLKRM = 0 and MCLKR is an input pin), the external rising-edge triggered input clock on MCLKR is inverted to a falling-edge triggered clock before being sent to the receiver. If CLKRP = 1 and internal clocking is selected (CLKRM = 1), the internal falling-edge triggered clock is inverted to a rising-edge triggered clock before being sent out on the MCLKR pin.

CLKRP = CLKXP in a system where the same clock (internal or external) is used to clock the receiver and transmitter. The receiver uses the opposite edge as the transmitter to ensure valid setup and hold of data around this edge. [Figure 8-8](#) shows how data clocked by an external serial device using a rising edge can be sampled by the McBSP receiver on the falling edge of the same clock.

Figure 8-8. Data Clocked Externally Using a Rising Edge and Sampled by the McBSP Receiver on a Falling Edge

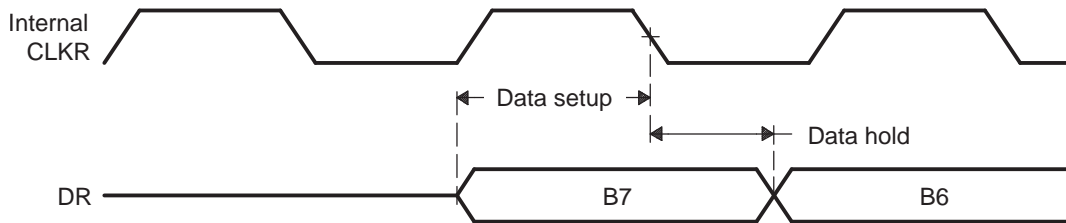

8.17 Set the SRG Frame-Synchronization Period and Pulse Width

Table 8-19. Register Bits Used to Set SRG Frame-Synchronization Period and Pulse Width

Register	Bit	Name	Function	Type	Reset Value
SRGR2	11-0	FPER	Sample rate generator frame-synchronization period For the frame-synchronization signal FSG, (FPER + 1) determines the period from the start of a frame-synchronization pulse to the start of the next frame-synchronization pulse. Range for (FPER + 1): 1 to 4096 CLKG cycles.	R/W	0000 0000 0000
SRGR1	15-8	FWID	Sample rate generator frame-synchronization pulse width This field plus 1 determines the width of each frame-synchronization pulse on FSG. Range for (FWID + 1): 1 to 256 CLKG cycles.	R/W	0000 0000

8.17.1 Frame-Synchronization Period and Frame-Synchronization Pulse Width

The sample rate generator can produce a clock signal, CLKG, and a frame-synchronization signal, FSG. If the sample rate generator is supplying receive or transmit frame synchronization, you must program the bit fields FPER and FWID.

On FSG, the period from the start of a frame-synchronization pulse to the start of the next pulse is (FPER + 1) CLKG cycles. The 12 bits of FPER allow a frame-synchronization period of 1 to 4096 CLKG cycles, which allows up to 4096 data bits per frame. When GSYNC = 1, FPER is a don't care value.

Each pulse on FSG has a width of (FWID + 1) CLKG cycles. The eight bits of FWID allow a pulse width of 1 to 256 CLKG cycles. It is recommended that FWID be programmed to a value less than the programmed word length.

The values in FPER and FWID are loaded into separate down-counters. The 12-bit FPER counter counts down the generated clock cycles from the programmed value (4095 maximum) to 0. The 8-bit FWID counter counts down from the programmed value (255 maximum) to 0.

Figure 8-9 shows a frame-synchronization period of 16 CLKG periods (FPER = 15 or 00001111b) and a frame-synchronization pulse with an active width of 2 CLKG periods (FWID = 1).

Figure 8-9. Frame of Period 16 CLKG Periods and Active Width of 2 CLKG Periods

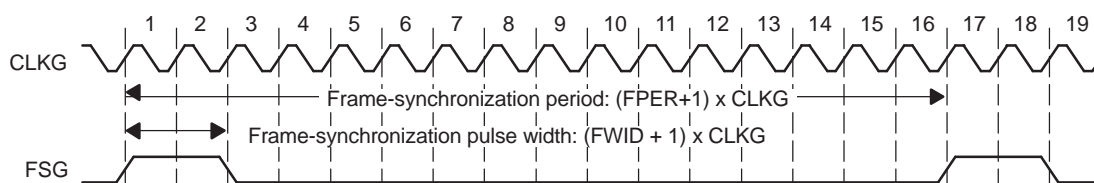

When the sample rate generator comes out of reset, FSG is in its inactive state. Then, when GRST = 1 and FSGM = 1, a frame-synchronization pulse is generated. The frame width value (FWID + 1) is counted down on every CLKG cycle until it reaches 0, at which time FSG goes low. At the same time, the frame period value (FPER + 1) is also counting down. When this value reaches 0, FSG goes high, indicating a new frame.

8.18 Set the Transmit Clock Mode

Table 8-20. Register Bit Used to Set the Transmit Clock Mode

Register	Bit	Name	Function	Type	Reset Value	
PCR	9	CLKXM	Transmit clock mode	R/W	0	
			CLKXM = 0			The transmitter gets its clock signal from an external source via the MCLKX pin.
			CLKXM = 1			The MCLKX pin is an output pin driven by the sample rate generator of the McBSP.

8.18.1 Selecting a Source for the Transmit Clock and a Data Direction for the MCLKX pin

Table 8-21 shows how the CLKXM bit selects the transmit clock and the corresponding status of the MCLKX pin. The polarity of the signal on the MCLKX pin is determined by the CLKXP bit.

Table 8-21. How the CLKXM Bit Selects the Transmit Clock and the Corresponding Status of the MCLKX pin

CLKXM in PCR	Source of Transmit Clock	MCLKX pin Status
0	Internal CLKX is driven by an external clock on the MCLKX pin. CLKX is inverted as determined by CLKXP before being used.	Input
1	Internal CLKX is driven by the sample rate generator clock, CLKG.	Output. CLKG, inverted as determined by CLKXP, is driven out on CLKX.

8.18.2 Other Considerations

If the sample rate generator creates a clock signal (CLKG) that is derived from an external input clock, the GSYNC bit determines whether CLKG is kept synchronized with pulses on the FSR pin. For more details, see Section 3.3, *Synchronizing Sample Rate Generator Outputs to an External Clock*.

In the clock stop mode (CLKSTP = 10b or 11b), the McBSP can act as a master or as a slave in the SPI protocol. If the McBSP is a master, make sure that CLKXM = 1 so that CLKX is an output to supply the master clock to any slave devices. If the McBSP is a slave, make sure that CLKXM = 0 so that CLKX is an input to accept the master clock signal.

8.19 Set the Transmit Clock Polarity

Table 8-22. Register Bit Used to Set Transmit Clock Polarity

Register	Bit	Name	Function	Type	Reset Value	
PCR	1	CLKXP	Transmit clock polarity	R/W	0	
			CLKXP = 0			Transmit data sampled on rising edge of CLKX.
			CLKXP = 1			Transmit data sampled on falling edge of CLKX.

8.19.1 Frame Synchronization Pulses, Clock Signals, and Their Polarities

Transmit frame-synchronization pulses can be either generated internally by the sample rate generator (see Section 3.2) or driven by an external source. The source of frame synchronization is selected by programming the mode bit, FSXM, in PCR. FSX is also affected by the FSGM bit in SRGR2. For information about the effects of FSXM and FSGM, see Section 8.15, *Set the Transmit Frame-Synchronization Mode*. Similarly, transmit clocks can be selected to be inputs or outputs by programming the mode bit, CLKXM, in the PCR (see Section 8.18, *Set the Transmit Clock Mode*).

When FSR and FSX are inputs (FSXM = FSRM = 0, external frame-synchronization pulses), the McBSP detects them on the internal falling edge of clock, internal MCLKR, and internal CLKX, respectively. The receive data arriving at the DR pin is also sampled on the falling edge of internal MCLKR. These internal clock signals are either derived from external source via CLK(R/X) pins or driven by the sample rate generator clock (CLKG) internal to the McBSP.

When FSR and FSX are outputs, implying that they are driven by the sample rate generator, they are generated (transition to their active state) on the rising edge of internal clock, CLK(R/X). Similarly, data on the DX pin is output on the rising edge of internal CLKX.

FSRP, FSXP, CLKRP, and CLKXP in the pin control register (PCR) configure the polarities of the FSR, FSX, MCLKR, and CLKX signals, respectively. All frame-synchronization signals (internal FSR, internal FSX) that are internal to the serial port are active high. If the serial port is configured for external frame synchronization (FSR/FSX are inputs to McBSP), and FSRP = FSXP = 1, the external active-low frame-synchronization signals are inverted before being sent to the receiver (internal FSR) and transmitter (internal FSX). Similarly, if internal synchronization (FSR/FSX are output pins and GSYNC = 0) is selected, the internal active-high frame-synchronization signals are inverted, if the polarity bit FS(R/X)P = 1, before being sent to the FS(R/X) pin.

On the transmit side, the transmit clock polarity bit, CLKXP, sets the edge used to shift and clock out transmit data. Data is always transmitted on the rising edge of internal CLKX. If CLKXP = 1 and external clocking is selected (CLKXM = 0 and CLKX is an input), the external falling-edge triggered input clock on CLKX is inverted to a rising-edge triggered clock before being sent to the transmitter. If CLKXP = 1 and internal clocking is selected (CLKXM = 1 and CLKX is an output pin), the internal (rising-edge triggered) clock, internal CLKX, is inverted before being sent out on the MCLKX pin.

Similarly, the receiver can reliably sample data that is clocked with a rising edge clock (by the transmitter). The receive clock polarity bit, CLKRP, sets the edge used to sample received data. The receive data is always sampled on the falling edge of internal MCLKR. Therefore, if CLKRP = 1 and external clocking is selected (CLKRM = 0 and CLKR is an input pin), the external rising-edge triggered input clock on CLKR is inverted to a falling-edge triggered clock before being sent to the receiver. If CLKRP = 1 and internal clocking is selected (CLKRM = 1), the internal falling-edge triggered clock is inverted to a rising-edge triggered clock before being sent out on the MCLKR pin.

CLKRP = CLKXP in a system where the same clock (internal or external) is used to clock the receiver and transmitter. The receiver uses the opposite edge as the transmitter to ensure valid setup and hold of data around this edge (see Figure 8-8).

Figure 8-10 shows how data clocked by an external serial device using a rising edge can be sampled by the McBSP receiver on the falling edge of the same clock.

Figure 8-10. Data Clocked Externally Using a Rising Edge and Sampled by the McBSP Receiver on a Falling Edge

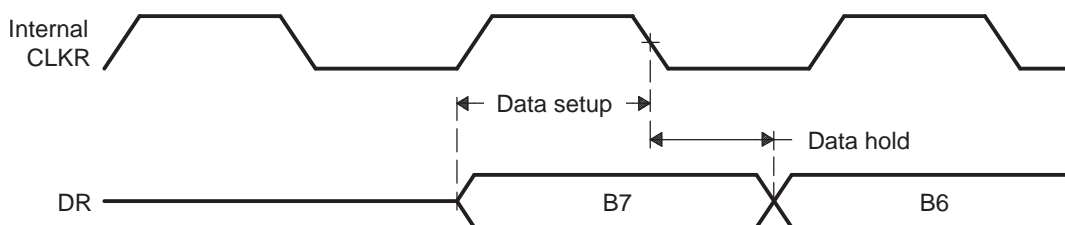

Emulation and Reset Considerations

This section covers the following topics:

- How to program McBSP response to a breakpoint in the high-level language debugger (see [Section 9.1](#))
- How to reset and initialize the various parts of the McBSP (see [Section 9.2](#))

Topic	Page
9.1 McBSP Emulation Mode	108
9.2 Resetting and Initializing McBSPs	108

9.1 McBSP Emulation Mode

FREE and SOFT are special emulation bits in SPCR2 that determine the state of the McBSP when a breakpoint is encountered in the high-level language debugger. If FREE = 1, the clock continues to run upon a software breakpoint and data is still shifted out. When FREE = 1, the SOFT bit is a *don't care*.

If FREE = 0, the SOFT bit takes effect. If SOFT = 0 when breakpoint occurs, the clock stops immediately, aborting a transmission. If SOFT = 1 and a breakpoint occurs while transmission is in progress, the transmission continues until completion of the transfer and then the clock halts. These options are listed in [Table 9-1](#).

The McBSP receiver functions in a similar fashion. If a mode other than the immediate stop mode (SOFT = FREE = 0) is chosen, the receiver continues running and an overrun error is possible.

Table 9-1. McBSP Emulation Modes Selectable with FREE and SOFT Bits of SPCR2

FREE	SOFT	McBSP Emulation Mode
0	0	Immediate stop mode (reset condition) The transmitter or receiver stops immediately in response to a breakpoint.
0	1	Soft stop mode When a breakpoint occurs, the transmitter stops after completion of the current word. The receiver is not affected.
1	0 or 1	Free run mode The transmitter and receiver continue to run when a breakpoint occurs.

9.2 Resetting and Initializing McBSPs

9.2.1 McBSP Pin States: DSP Reset Versus Receiver/Transmitter Reset

[Table 9-2](#) shows the state of McBSP pins when the serial port is reset due to direct receiver or transmitter reset on the 2833x device.

Table 9-2. Reset State of Each McBSP Pin

Pin	Possible State(s) ⁽¹⁾	State Forced by Device Reset	State Forced by Receiver/Transmitter Reset
Receiver reset (RRST = 0 and GRST = 1)			
MDRx	I	GPIO-input	Input
MCLKRx	I/O/Z	GPIO-input	Known state if input; MCLKR running if output
MFSRx	I/O/Z	GPIO-input	Known state if input; FSRP inactive state if output
Transmitter reset (XRST = 0 and GRST = 1)			
MDXx	O/Z	GPIO Input	High impedance
MCLKXx	I/O/Z	GPIO-input	Known state if input; CLKX running if output
MFSXx	I/O/Z	GPIO-input	Known state if input; FSXP inactive state if output

⁽¹⁾ In Possible State(s) column, I = Input, O = Output, Z = High impedance. In the 28x family, at device reset, all I/Os default to GPIO function and generally as inputs.

9.2.2 Device Reset, McBSP Reset, and Sample Rate Generator Reset

When the McBSP is reset in either of the above two ways, the machine is reset to its initial state, including reset of all counters and status bits. The receive status bits include RFULL, RRDY, and RSYNCERR. The transmit status bits include XEMPTY, XRDY, and XSYNCERR.

- Device reset. When the whole DSP is reset (\overline{XRS} signal is driven low), all McBSP pins are in GPIO mode. When the device is pulled out of reset, the clock to the McBSP modules remains disabled.

- **McBSP reset.** When the receiver and transmitter reset bits, RRST and XRST, are loaded with 0s, the respective portions of the McBSP are reset and activity in the corresponding section of the serial port stops. Input-only pins such as MDRx, and all other pins that are configured as inputs are in a known state. The MFSRx and MFSXx pins are driven to their inactive state if they are not outputs. If the MCLKR and MCLKX pins are programmed as outputs, they are driven by CLKG, provided that GRST = 1. Lastly, the MDXx pin is in the high-impedance state when the transmitter and/or the device is reset.

During normal operation, the sample rate generator is reset if the GRST bit is cleared. GRST must be 0 only when neither the transmitter nor the receiver is using the sample rate generator. In this case, the internal sample rate generator clock (CLKG) and its frame-synchronization signal (FSG) are driven inactive low.

When the sample rate generator is not in the reset state (GRST = 1), pins MFSRx and MFSXx are in an inactive state when RRST = 0 and XRST = 0, respectively, even if they are outputs driven by FSG. This ensures that when only one portion of the McBSP is in reset, the other portion can continue operation when GRST = 1 and its frame synchronization is driven by FSG.

- **Sample rate generator reset.** The sample rate generator is reset when GRST is loaded with 0. When neither the transmitter nor the receiver is fed by CLKG and FSG, you can reset the sample rate generator by clearing GRST. In this case, CLKG and FSG are driven inactive low. If you then set GRST, CLKG starts and runs as programmed. Later, if GRST = 1, FSG pulses active high after the programmed number of CLKG cycles has elapsed.

9.2.3 McBSP Initialization Procedure

The serial port initialization procedure is as follows:

1. Make XRST = RRST = GRST = 0 in SPCR[1,2]. If coming out of a device reset, this step is not required.
2. While the serial port is in the reset state, program only the McBSP configuration registers (not the data registers) as required.
3. Wait for two clock cycles. This ensures proper internal synchronization.
4. Set up data acquisition as required (such as writing to DXR[1,2]).
5. Make XRST = RRST = 1 to enable the serial port. Make sure that as you set these reset bits, you do not modify any of the other bits in SPCR1 and SPCR2. Otherwise, you change the configuration you selected in step 2.
6. Set FRST = 1, if internally generated frame synchronization is required.
7. Wait two clock cycles for the receiver and transmitter to become active.

Alternatively, on either write (step 1 or 5), the transmitter and receiver can be placed in or taken out of reset individually by modifying the desired bit.

The above procedure for reset/initialization can be applied in general when the receiver or transmitter must be reset during its normal operation and when the sample rate generator is not used for either operation.

NOTE:

1. The necessary duration of the active-low period of XRST or RRST is at least two MCLKR/CLKX cycles.
 2. The appropriate bits in serial port configuration registers SPCR[1,2], PCR, RCR[1,2], XCR[1,2], and SRGR[1,2] must only be modified when the affected portion of the serial port is in its reset state.
 3. In most cases, the data transmit registers (DXR[1,2]) must be loaded by the CPU or by the DMA controller only when the transmitter is enabled (XRST = 1). An exception to this rule is when these registers are used for companding internal data (see [Section 2.2.2, Capability to Compand Internal Data](#)).
 4. The bits of the channel control registers—MCR[1,2], RCER[A-H], XCER[A-H]—can be modified at any time as long as they are not being used by the current reception/transmission in a multichannel selection mode.
-

9.2.4 Resetting the Transmitter While the Receiver is Running

shows values in the control registers that reset and configure the transmitter while the receiver is running.

Example 9-1. Resetting and Configuring McBSP Transmitter While McBSP Receiver Running

```

SPCR1 = 0001h SPCR2 = 0030h
; The receiver is running with the receive interrupt (RINT) triggered by the
; receiver ready bit (RRDY). The transmitter is in its reset state
. The transmit interrupt (XINT) will be triggered by the transmit frame-sync
; error bit (XSYNCERR). PCR = 0900h
; Transmit frame synchronization is generated internally according to the
; FSGM bit of SRGR2.
; The transmit clock is driven by an external source.
; The receive clock continues to be driven by sample rate generator. The input clock
; of the sample rate generator is supplied by the CPU clock SRGR1 = 0001h SRGR2 = 2000h
; The CPU clock is the input clock for the sample rate generator. The sample
; rate generator divides the CPU clock by 2 to generate its output clock (CLKG).
; Transmit frame synchronization is tied to the automatic copying of data from
; the DXR(s) to the XSR(s). XCR1 = 0740h XCR2 = 8321h
; The transmit frame has two phases. Phase 1 has eight 16-bit words. Phase 2
; has four 12-bit words. There is 1-bit data delay between the start of a
; frame-sync pulse and the first data bit
; transmitted. SPCR2 = 0031h
; The transmitter is taken out of reset.

```

Data Packing Examples

This section shows two ways to implement data packing in the McBSP.

Topic	Page
10.1 Data Packing Using Frame Length and Word Length	112
10.2 Data Packing Using Word Length and the Frame-Synchronization Ignore Function	113

10.1 Data Packing Using Frame Length and Word Length

Frame length and word length can be manipulated to effectively pack data. For example, consider a situation where four 8-bit words are transferred in a single-phase frame as shown in Figure 10-1. In this case:

- (R/X)PHASE = 0: Single-phase frame
- (R/X)FRLLEN1 = 0000011b: 4-word frame
- (R/X)WDLEN1 = 000b: 8-bit words

Four 8-bit data words are transferred to and from the McBSP by the CPU or by the DMA controller. Thus, four reads from DRR1 and four writes to DXR1 are necessary for each frame.

Figure 10-1. Four 8-Bit Data Words Transferred To/From the McBSP

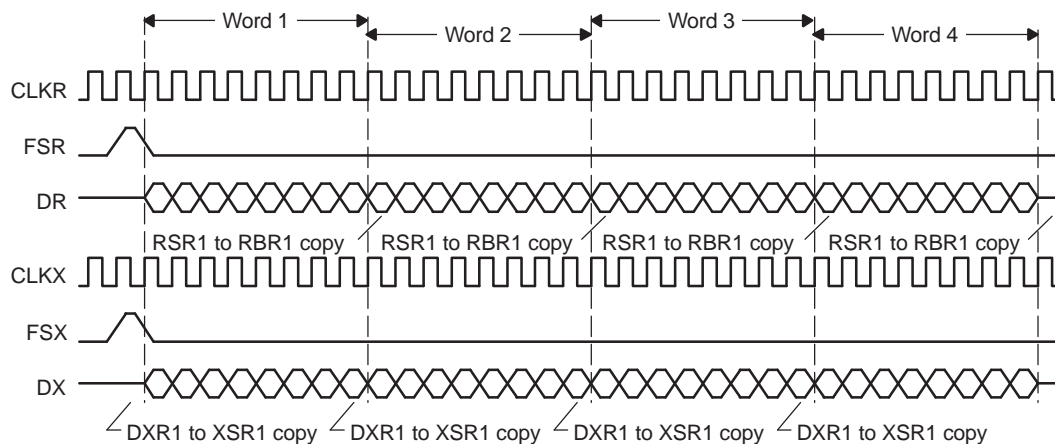

This data can also be treated as a single-phase frame consisting of one 32-bit data word, as shown in Figure 10-2. In this case:

- (R/X)PHASE = 0: Single-phase frame
- (R/X)FRLLEN1 = 0000000b: 1-word frame
- (R/X)WDLEN1 = 101b: 32-bit word

Two 16-bit data words are transferred to and from the McBSP by the CPU or DMA controller. Thus, two reads, from DRR2 and DRR1, and two writes, to DXR2 and DXR1, are necessary for each frame. This results in only half the number of transfers compared to the previous case. This manipulation reduces the percentage of bus time required for serial port data movement.

NOTE: When the word length is larger than 16 bits, make sure you access DRR2/DXR2 before you access DRR1/DXR1. McBSP activity is tied to accesses of DRR1/DXR1. During the reception of 24-bit or 32-bit words, read DRR2 and then read DRR1. Otherwise, the next RBR[1,2]-to-DRR[1,2] copy occurs before DRR2 is read. Similarly, during the transmission of 24-bit or 32-bit words, write to DXR2 and then write to DXR1. Otherwise, the next DXR[1,2]-to-XSR[1,2] copy occurs before DXR2 is loaded with new data.

Figure 10-2. One 32-Bit Data Word Transferred To/From the McBSP

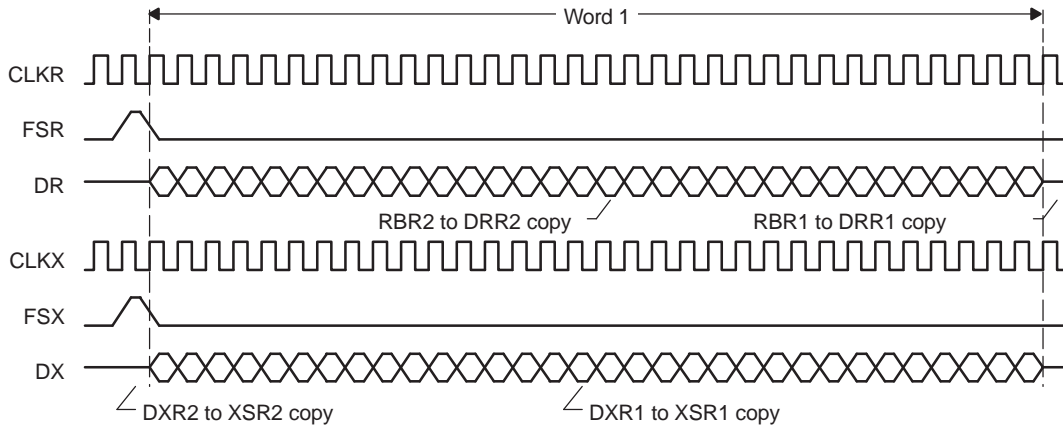

10.2 Data Packing Using Word Length and the Frame-Synchronization Ignore Function

When there are multiple words per frame, you can implement data packing by increasing the word length (defining a serial word with more bits) and by ignoring frame-synchronization pulses. First, consider [Figure 10-3](#), which shows the McBSP operating at the maximum packet frequency. Here, each frame only has a single 8-bit word. Notice the frame-synchronization pulse that initiates each frame transfer for reception and for transmission. For reception, this configuration requires one read operation for each word. For transmission, this configuration requires one write operation for each word.

Figure 10-3. 8-Bit Data Words Transferred at Maximum Packet Frequency

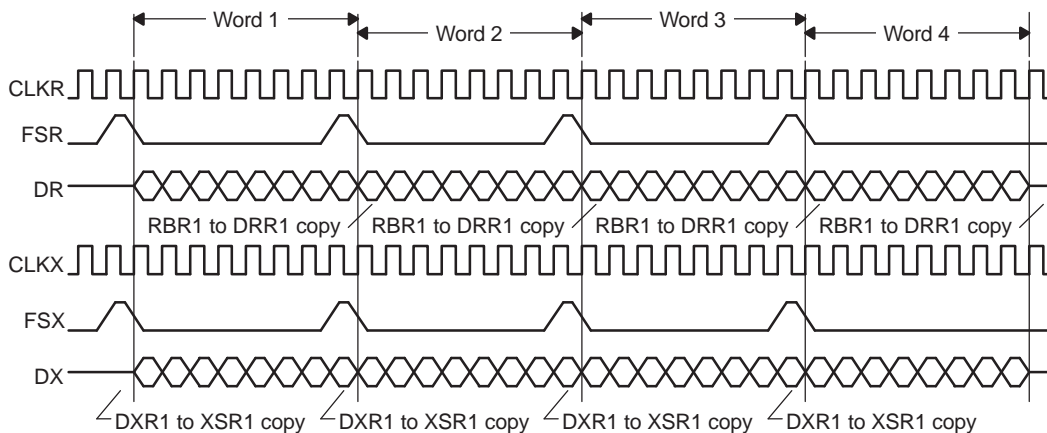

[Figure 10-4](#) shows the McBSP configured to treat this data stream as a continuous 32-bit word. In this example, the McBSP responds to an initial frame-synchronization pulse. However, (R/X)FIG = 1 so that the McBSP ignores subsequent pulses. Only two read transfers or two write transfers are needed every 32 bits. This configuration effectively reduces the required bus bandwidth to half the bandwidth needed to transfer four 8-bit words.

Figure 10-4. Configuring the Data Stream of Figure 10-3 as a Continuous 32-Bit Word

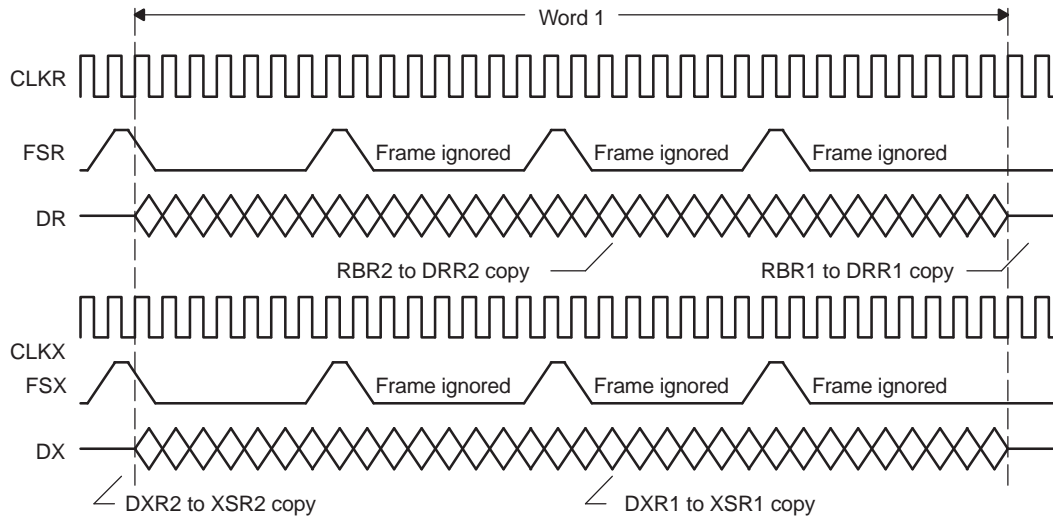

McBSP Registers

This section describes the McBSP registers.

Topic	Page
11.1 Register Summary	116
11.2 Data Receive Registers (DRR[1,2])	116
11.3 Data Transmit Registers (DXR[1,2])	118
11.4 Serial Port Control Registers (SPCR[1,2])	118
11.5 Receive Control Registers (RCR[1, 2])	123
11.6 Transmit Control Registers (XCR1 and XCR2)	125
11.7 Sample Rate Generator Registers (SRGR1 and SRGR2)	128
11.8 Multichannel Control Registers (MCR[1,2])	131
11.9 Pin Control Register (PCR)	135
11.10 Receive Channel Enable Registers (RCERA, RCERB, RCERC, RCERD, RCERE, RCERF, RCERG, RCERH)	137
11.11 Transmit Channel Enable Registers (XCERA, XCERB, XCERC, XCERD, XCERE, XCERF, XCERG, XCERH)	139
11.12 Interrupt Generation	141
11.13 McBSP Modes	143

11.1 Register Summary

Table 11-1 shows the registers accessible on each McBSP. Section 11.2 through Section 11.11 describe the register bits.

Table 11-1. McBSP Register Summary

Name	McBSP-A Address	McBSP-B Address	Type	Reset Value	Description
Data Registers, Receive, Transmit					
DRR2	0x5000	0x5040	R	0x0000	McBSP Data Receive Register 2
DRR1	0x5001	0x5041	R	0x0000	McBSP Data Receive Register 1
DXR2	0x5002	0x5042	W	0x0000	McBSP Data Transmit Register 2
DXR1	0x5003	0x5043	W	0x0000	McBSP Data Transmit Register 1
McBSP Control Registers					
SPCR2	0x5004	0x5044	R/W	0x0000	McBSP Serial Port Control Register 2
SPCR1	0x5005	0x5045	R/W	0x0000	McBSP Serial Port Control Register 1
RCR2	0x5006	0x5046	R/W	0x0000	McBSP Receive Control Register 2
RCR1	0x5007	0x5047	R/W	0x0000	McBSP Receive Control Register 1
XCR2	0x5008	0x5048	R/W	0x0000	McBSP Transmit Control Register 2
XCR1	0x5009	0x5049	R/W	0x0000	McBSP Transmit Control Register 1
SRGR2	0x500A	0x504A	R/W	0x0000	McBSP Sample Rate Generator Register 2
SRGR1	0x500B	0x504B	R/W	0x0000	McBSP Sample Rate Generator Register 1
Multichannel Control Registers					
MCR2	0x500C	0x504C	R/W	0x0000	McBSP Multichannel Register 2
MCR1	0x500D	0x504D	R/W	0x0000	McBSP Multichannel Register 1
RCERA	0x500E	0x504E	R/W	0x0000	McBSP Receive Channel Enable Register Partition A
RCERB	0x500F	0x504F	R/W	0x0000	McBSP Receive Channel Enable Register Partition B
XCERA	0x5010	0x5050	R/W	0x0000	McBSP Transmit Channel Enable Register Partition A
XCERB	0x5011	0x5051	R/W	0x0000	McBSP Transmit Channel Enable Register Partition B
PCR	0x5012	0x5052	R/W	0x0000	McBSP Pin Control Register
RCERC	0x5013	0x5053	R/W	0x0000	McBSP Receive Channel Enable Register Partition C
RCERD	0x5014	0x5054	R/W	0x0000	McBSP Receive Channel Enable Register Partition D
XCERC	0x5015	0x5055	R/W	0x0000	McBSP Transmit Channel Enable Register Partition C
XCERD	0x5016	0x5056	R/W	0x0000	McBSP Transmit Channel Enable Register Partition D
RCERE	0x5017	0x5057	R/W	0x0000	McBSP Receive Channel Enable Register Partition E
RCERF	0x5018	0x5058	R/W	0x0000	McBSP Receive Channel Enable Register Partition F
XCERE	0x5019	0x5059	R/W	0x0000	McBSP Transmit Channel Enable Register Partition E
XCERF	0x501A	0x505A	R/W	0x0000	McBSP Transmit Channel Enable Register Partition F
RCERG	0x501B	0x505B	R/W	0x0000	McBSP Receive Channel Enable Register Partition G
RCERH	0x501C	0x505C	R/W	0x0000	McBSP Receive Channel Enable Register Partition H
XCERG	0x501D	0x505D	R/W	0x0000	McBSP Transmit Channel Enable Register Partition G
XCERH	0x501E	0x505E	R/W	0x0000	McBSP Transmit Channel Enable Register Partition H
MFFINT	0x5023	0x5063	R/W	0x0000	McBSP Interrupt Enable Register

11.2 Data Receive Registers (DRR[1,2])

The CPU or the DMA controller reads received data from one or both of the data receive registers (see Figure 11-1). If the serial word length is 16 bits or smaller, only DRR1 is used. If the serial length is larger than 16 bits, both DRR1 and DRR2 are used and DRR2 holds the most significant bits. Each frame of receive data in the McBSP can have one phase or two phases, each with its own serial word length.

Figure 11-1. Data Receive Registers (DDR2 and DDR1)

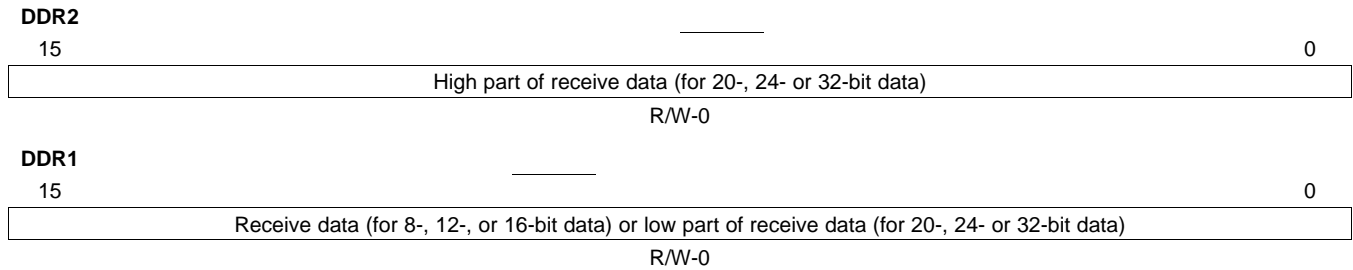

LEGEND: R/W = Read/Write; R = Read only; -n = value after reset

11.2.1 Data Travel From Data Receive Pins to the Registers

If the serial word length is 16 bits or smaller, receive data on the MDRx pin is shifted into receive shift register 1 (RSR1) and then copied into receive buffer register 1 (RBR1). The content of RBR1 is then copied to DDR1, which can be read by the CPU or by the DMA controller. The RSRs and RBRs are not accessible to the user.

If the serial word length is larger than 16 bits, receive data on the MDRx pin is shifted into both of the receive shift registers (RSR2, RSR1) and then copied into both of the receive buffer registers (RBR2, RBR1). The content of the RBRs is then copied into both of the DDRs, which can be read by the CPU or by the DMA controller.

If companding is used during the copy from RBR1 to DDR1 (RCOMPAND = 10b or 11b), the 8-bit compressed data in RBR1 is expanded to a left-justified 16-bit value in DDR1. If companding is disabled, the data copied from RBR[1,2] to DDR[1,2] is justified and bit filled according to the RJUST bits.

11.3 Data Transmit Registers (DXR[1,2])

For transmission, the CPU or the DMA controller writes data to one or both of the data transmit registers (see Figure 11-2). If the serial word length is 16 bits or smaller, only DXR1 is used. If the word length is larger than 16 bits, both DXR1 and DXR2 are used and DXR2 holds the most significant bits. Each frame of transmit data in the McBSP can have one phase or two phases, each with its own serial word length.

Figure 11-2. Data Transmit Registers (DXR2 and DXR1)

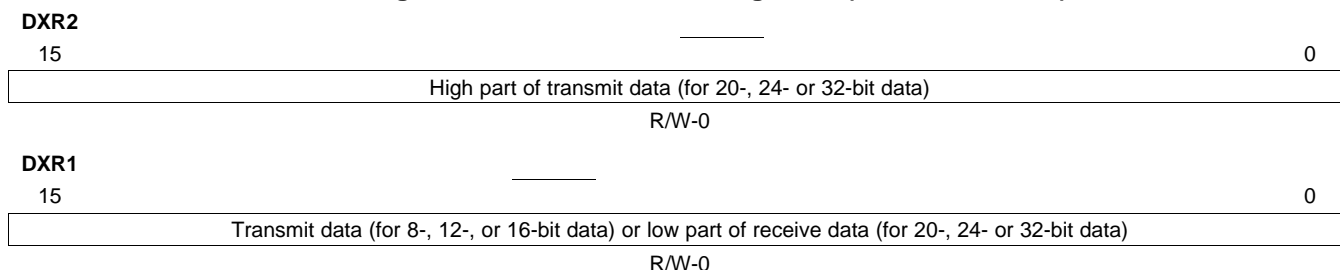

LEGEND: R/W = Read/Write; R = Read only; -n = value after reset

11.3.1 Data Travel From Registers to Data Transmit (DX) Pins

If the serial word length is 16 bits or fewer, data written to DXR1 is copied to transmit shift register 1 (XSR1). From XSR1, the data is shifted onto the DX pin one bit at a time. The XSRs are not accessible.

If the serial word length is more than 16 bits, data written to DXR1 and DXR2 is copied to both transmit shift registers (XSR2, XSR1). From the XSRs, the data is shifted onto the DX pin one bit at a time.

If companding is used during the transfer from DXR1 to XSR1 (XCOMPAND = 10b or 11b), the McBSP compresses the 16-bit data in DXR1 to 8-bit data in the μ -law or A-law format in XSR1. If companding is disabled, the McBSP passes data from the DXR(s) to the XSR(s) without modification.

11.4 Serial Port Control Registers (SPCR[1,2])

Each McBSP has two serial port control registers, SPCR1 (Table 11-2) and SPCR2 (Table 11-3). These registers enable you to:

- Control various McBSP modes: digital loopback mode (DLB), sign-extension and justification mode for reception (RJUST), clock stop mode (CLKSTP), interrupt modes (RINTM and XINTM), emulation mode (FREE and SOFT)
- Turn on and off the DX-pin delay enabler (DXENA)
- Check the status of receive and transmit operations (RSYNCERR, XSYNCERR, RFULL, XEMPTY, RRDY, XRDY)
- Reset portions of the McBSP (RRST, XRST, FRST, GRST)

11.4.1 Serial Port Control 1 Register (SPCR1)

The serial port control 1 register (SPCR1) is shown in Figure 11-3 and described in Table 11-2.

Figure 11-3. Serial Port Control 1 Register (SPCR1)

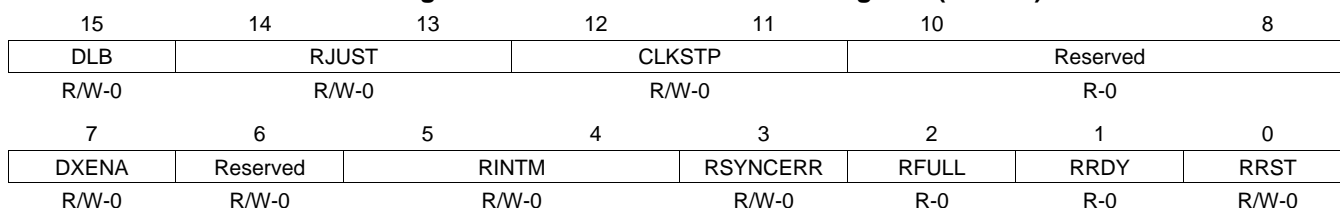

LEGEND: R/W = Read/Write; R = Read only; -n = value after reset

Table 11-2. Serial Port Control 1 Register (SPCR1) Field Descriptions

Bit	Field	Value	Description
15	DLB	0 1	<p>Digital loopback mode bit. DLB disables or enables the digital loopback mode of the McBSP:</p> <p>0 Disabled</p> <p>Internal DR is supplied by the MDRx pin. Internal FSR and internal MCLKR can be supplied by their respective pins or by the sample rate generator, depending on the mode bits FSRM and CLKRM.</p> <p>Internal DX is supplied by the MDXx pin. Internal FSX and internal CLKX are supplied by their respective pins or are generated internally, depending on the mode bits FSXM and CLKXM.</p> <p>1 Enabled</p> <p>Internal receive signals are supplied by internal transmit signals:</p> <p>MDRx connected to MDXx MFSRx connected to MFSXx MCLKR connected to MCLKXx</p> <p>This mode allows you to test serial port code with a single DSP. The McBSP transmitter directly supplies data, frame synchronization, and clocking to the McBSP receiver.</p>
14-13	RJUST	0-3h 0 1h 2h 3h	<p>Receive sign-extension and justification mode bits. During reception, RJUST determines how data is justified and bit filled before being passed to the data receive registers (DRR1, DRR2).</p> <p>RJUST is ignored if you enable a companding mode with the RCOMPAND bits. In a companding mode, the 8-bit compressed data in RBR1 is expanded to left-justified 16-bit data in DRR1.</p> <p>For more details about the effects of RJUST, see Section 7.13, Set the Receive Sign-Extension and Justification Mode</p> <p>0 Right justify the data and zero fill the MSBs.</p> <p>1h Right justify the data and sign-extend the data into the MSBs.</p> <p>2h Left justify the data and zero fill the LSBs.</p> <p>3h Reserved (do not use)</p>
12-11	CLKSTP	0-3h 0-1h 2h 3h	<p>Clock stop mode bits. CLKSTP allows you to use the clock stop mode to support the SPI master-slave protocol. If you will not be using the SPI protocol, you can clear CLKSTP to disable the clock stop mode.</p> <p>In the clock stop mode, the clock stops at the end of each data transfer. At the beginning of each data transfer, the clock starts immediately (CLKSTP = 10b) or after a half-cycle delay (CLKSTP = 11b).</p> <p>For more details, see Section 7.5, Enable/Disable the Clock Stop.</p> <p>0-1h Clock stop mode is disabled.</p> <p>2h Clock stop mode, without clock delay</p> <p>3h Clock stop mode, with half-cycle clock delay</p>
10-8	Reserved	0	Reserved bits (not available for your use). They are read-only bits and return 0s when read.
7	DXENA	0 1	<p>DX delay enabler mode bit. DXENA controls the delay enabler for the DX pin. The enabler creates an extra delay for turn-on time (for the length of the delay, see the device-specific data sheet). For more details about the effects of DXENA, see Section 8.13, Set the Transmit DXENA Mode.</p> <p>0 DX delay enabler off</p> <p>1 DX delay enabler on</p>
6	Reserved	0	Reserved

Table 11-2. Serial Port Control 1 Register (SPCR1) Field Descriptions (continued)

Bit	Field	Value	Description
5-4	RINTM	0-3h 0 1h 2h 3h	<p>Receive interrupt mode bits. RINTM determines which event in the McBSP receiver generates a receive interrupt (RINT) request. If RINT is properly enabled inside the CPU, the CPU services the interrupt request; otherwise, the CPU ignores the request.</p> <p>0 The McBSP sends a receive interrupt (RINT) request to the CPU when the RRDY bit changes from 0 to 1, indicating that receive data is ready to be read (the content of RBR[1,2] has been copied to DRR[1,2]): Regardless of the value of RINTM, you can check RRDY to determine whether a word transfer is complete. The McBSP sends a RINT request to the CPU when 16 enabled bits have been received on the DR pin.</p> <p>1h In the multichannel selection mode, the McBSP sends a RINT request to the CPU after every 16-channel block is received in a frame. Outside of the multichannel selection mode, no interrupt request is sent.</p> <p>2h The McBSP sends a RINT request to the CPU when each receive frame-synchronization pulse is detected. The interrupt request is sent even if the receiver is in its reset state.</p> <p>3h The McBSP sends a RINT request to the CPU when the RSYNCERR bit is set, indicating a receive frame-synchronization error. Regardless of the value of RINTM, you can check RSYNCERR to determine whether a receive frame-synchronization error occurred.</p>
3	RSYNCERR	0 1	<p>Receive frame-sync error bit. RSYNCERR is set when a receive frame-sync error is detected by the McBSP. If RINTM = 11b, the McBSP sends a receive interrupt (RINT) request to the CPU when RSYNCERR is set. The flag remains set until you write a 0 to it or reset the receiver.</p> <p>0 No error</p> <p>1 Receive frame-synchronization error. For more details about this error, see Section 4.3, Unexpected Receive Frame-Synchronization Pulse.</p>
2	RFULL	0 1	<p>Receiver full bit. RFULL is set when the receiver is full with new data and the previously received data has not been read (receiver-full condition). For more details about this condition, see Section 4.2, Overrun in the Receiver.</p> <p>0 No receiver-full condition</p> <p>1 Receiver-full condition: RSR[1,2] and RBR[1,2] are full with new data, but the previous data in DRR[1,2] has not been read.</p>
1	RRDY	0 1	<p>Receiver ready bit. RRDY is set when data is ready to be read from DRR[1,2]. Specifically, RRDY is set in response to a copy from RBR1 to DRR1.</p> <p>If the receive interrupt mode is RINTM = 00b, the McBSP sends a receive interrupt request to the CPU when RRDY changes from 0 to 1.</p> <p>Also, when RRDY changes from 0 to 1, the McBSP sends a receive synchronization event (REVT) signal to the DMA controller.</p> <p>0 Receiver not ready When the content of DRR1 is read, RRDY is automatically cleared.</p> <p>1 Receiver ready: New data can be read from DRR[1,2]. Important: If both DRRs are required (word length larger than 16 bits), the CPU or the DMA controller must read from DRR2 first and then from DRR1. As soon as DRR1 is read, the next RBR-to-DRR copy is initiated. If DRR2 is not read first, the data in DRR2 is lost.</p>
0	RRST	0 1	<p>Receiver reset bit. You can use RRST to take the McBSP receiver into and out of its reset state. This bit has a negative polarity; RRST = 0 indicates the reset state.</p> <p>To read about the effects of a receiver reset, see Section 9.2, Resetting and Initializing a McBSP.</p> <p>0 If you read a 0, the receiver is in its reset state. If you write a 0, you reset the receiver.</p> <p>1 If you read a 1, the receiver is enabled. If you write a 1, you enable the receiver by taking it out of its reset state.</p>

11.4.2 Serial Port Control 2 Register (SPCR2)

The serial port control 2 register (SPCR2) is shown in [Figure 11-4](#) and described in [Table 11-3](#).

Figure 11-4. Serial Port Control 2 Register (SPCR2)

15			10			9	8
Reserved						FREE	SOFT
R-0						R/W-0	R/W-0
7	6	5	4	3	2	1	0
FRST	GRST	XINTM		XSYNCERR	XEMPTY	XRDY	XRST
R/W-0	R/W-0	R/W-0		R/W-0	R-0	R-0	R/W-0

LEGEND: R/W = Read/Write; R = Read only; -n = value after reset

Table 11-3. Serial Port Control 2 Register (SPCR2) Field Descriptions

Bit	Field	Value	Description
15-10	Reserved	0	Reserved bits (not available for your use). They are read-only bits and return 0s when read.
9	FREE		Free run bit. When a breakpoint is encountered in the high-level language debugger, FREE determines whether the McBSP transmit and receive clocks continue to run or whether they are affected as determined by the SOFT bit. When one of the clocks stops, the corresponding data transfer (transmission or reception) stops.
8	SOFT		Soft stop bit. When FREE = 0, SOFT determines the response of the McBSP transmit and receive clocks when a breakpoint is encountered in the high-level language debugger. When one of the clocks stops, the corresponding data transfer (transmission or reception) stops.
7	FRST	0 1	<p>Frame-synchronization logic reset bit. The sample rate generator of the McBSP includes frame-synchronization logic to generate an internal frame-synchronization signal. You can use FRST to take the frame-synchronization logic into and out of its reset state. This bit has a negative polarity; FRST = 0 indicates the reset state.</p> <p>If you read a 0, the frame-synchronization logic is in its reset state. If you write a 0, you reset the frame-synchronization logic. In the reset state, the frame-synchronization logic does not generate a frame-synchronization signal (FSG).</p> <p>If you read a 1, the frame-synchronization logic is enabled. If you write a 1, you enable the frame-synchronization logic by taking it out of its reset state. When the frame-synchronization logic is enabled (FRST = 1) and the sample rate generator as a whole is enabled (GRST = 1), the frame-synchronization logic generates the frame-synchronization signal FSG as programmed.</p>
6	GRST	0 1	<p>Sample rate generator reset bit. You can use GRST to take the McBSP sample rate generator into and out of its reset state. This bit has a negative polarity; GRST = 0 indicates the reset state.</p> <p>To read about the effects of a sample rate generator reset, see Section 9.2, Resetting and Initializing a McBSP.</p> <p>If you read a 0, the sample rate generator is in its reset state. If you write a 0, you reset the sample rate generator. If GRST = 0 due to a reset, CLKG is driven by the CPU clock divided by 2, and FSG is driven low (inactive). If GRST = 0 due to program code, CLKG and FSG are both driven low (inactive).</p> <p>If you read a 1, the sample rate generator is enabled. If you write a 1, you enable the sample rate generator by taking it out of its reset state. When enabled, the sample rate generator generates the clock signal CLKG as programmed in the sample rate generator registers. If FRST = 1, the generator also generates the frame-synchronization signal FSG as programmed in the sample rate generator registers.</p>

Table 11-3. Serial Port Control 2 Register (SPCR2) Field Descriptions (continued)

Bit	Field	Value	Description
5-4	XINTM	0-3h 0 1h 2h 3h	<p>Transmit interrupt mode bits. XINTM determines which event in the McBSP transmitter generates a transmit interrupt (XINT) request. If XINT is properly enabled, the CPU services the interrupt request; otherwise, the CPU ignores the request.</p> <p>The McBSP sends a transmit interrupt (XINT) request to the CPU when the XRDY bit changes from 0 to 1, indicating that transmitter is ready to accept new data (the content of DXR[1,2] has been copied to XSR[1,2]).</p> <p>Regardless of the value of XINTM, you can check XRDY to determine whether a word transfer is complete.</p> <p>The McBSP sends an XINT request to the CPU when 16 enabled bits have been transmitted on the DX pin.</p> <p>In the multichannel selection mode, the McBSP sends an XINT request to the CPU after every 16-channel block is transmitted in a frame.</p> <p>Outside of the multichannel selection mode, no interrupt request is sent.</p> <p>The McBSP sends an XINT request to the CPU when each transmit frame-synchronization pulse is detected. The interrupt request is sent even if the transmitter is in its reset state.</p> <p>The McBSP sends an XINT request to the CPU when the XSYNCERR bit is set, indicating a transmit frame-synchronization error.</p> <p>Regardless of the value of XINTM, you can check XSYNCERR to determine whether a transmit frame-synchronization error occurred.</p>
3	XSYNCERR	0 1	<p>Transmit frame-synchronization error bit. XSYNCERR is set when a transmit frame-synchronization error is detected by the McBSP. If XINTM = 11b, the McBSP sends a transmit interrupt (XINT) request to the CPU when XSYNCERR is set. The flag remains set until you write a 0 to it or reset the transmitter.</p> <p>If XINTM = 11b, writing a 1 to XSYNCERR triggers a transmit interrupt just as if a transmit frame-synchronization error occurred.</p> <p>For details about this error see Section 4.6, Unexpected Transmit Frame-Synchronization Pulse.</p> <p>0 No error</p> <p>1 Transmit frame-synchronization error</p>
2	XEMPTY	0 1	<p>Transmitter empty bit. XEMPTY is cleared when the transmitter is ready to send new data but no new data is available (transmitter-empty condition). This bit has a negative polarity; a transmitter-empty condition is indicated by XEMPTY = 0.</p> <p>0 Transmitter-empty condition</p> <p>Typically this indicates that all the bits of the current word have been transmitted but there is no new data in DXR1. XEMPTY is also cleared if the transmitter is reset and then restarted.</p> <p>For more details about this error condition, see Section 4.5, Underflow in the Transmitter.</p> <p>1 No transmitter-empty condition</p>
1	XRDY	0 1	<p>Transmitter ready bit. XRDY is set when the transmitter is ready to accept new data in DXR[1,2]. Specifically, XRDY is set in response to a copy from DXR1 to XSR1.</p> <p>If the transmit interrupt mode is XINTM = 00b, the McBSP sends a transmit interrupt (XINT) request to the CPU when XRDY changes from 0 to 1.</p> <p>Also, when XRDY changes from 0 to 1, the McBSP sends a transmit synchronization event (XEVT) signal to the DMA controller.</p> <p>0 Transmitter not ready</p> <p>When DXR1 is loaded, XRDY is automatically cleared.</p> <p>1 Transmitter ready: DXR[1,2] is ready to accept new data.</p> <p>If both DXRs are needed (word length larger than 16 bits), the CPU or the DMA controller must load DXR2 first and then load DXR1. As soon as DXR1 is loaded, the contents of both DXRs are copied to the transmit shift registers (XSRs), as described in the next step. If DXR2 is not loaded first, the previous content of DXR2 is passed to the XSR2.</p>

Table 11-3. Serial Port Control 2 Register (SPCR2) Field Descriptions (continued)

Bit	Field	Value	Description
0	XRST		Transmitter reset bit. You can use XRST to take the McBSP transmitter into and out of its reset state. This bit has a negative polarity; XRST = 0 indicates the reset state. To read about the effects of a transmitter reset, see Section 9.2, Resetting and Initializing a McBSP .
		0	If you read a 0, the transmitter is in its reset state. If you write a 0, you reset the transmitter.
		1	If you read a 1, the transmitter is enabled. If you write a 1, you enable the transmitter by taking it out of its reset state.

11.5 Receive Control Registers (RCR[1, 2])

Each McBSP has two receive control registers, RCR1 ([Table 11-4](#)) and RCR2 ([Table 11-6](#)). These registers enable you to:

- Specify one or two phases for each frame of receive data (RPHASE)
- Define two parameters for phase 1 and (if necessary) phase 2: the serial word length (RWDLEN1, RWDLEN2) and the number of words (RFRLN1, RFRLN2)
- Choose a receive companding mode, if any (RCOMPAND)
- Enable or disable the receive frame-synchronization ignore function (RFIG)
- Choose a receive data delay (RDATDLY)

11.5.1 Receive Control Register 1 (RCR1)

The receive control register 1 (RCR1) is shown in [Figure 11-5](#) and described in [Table 11-4](#).

Figure 11-5. Receive Control Register 1 (RCR1)

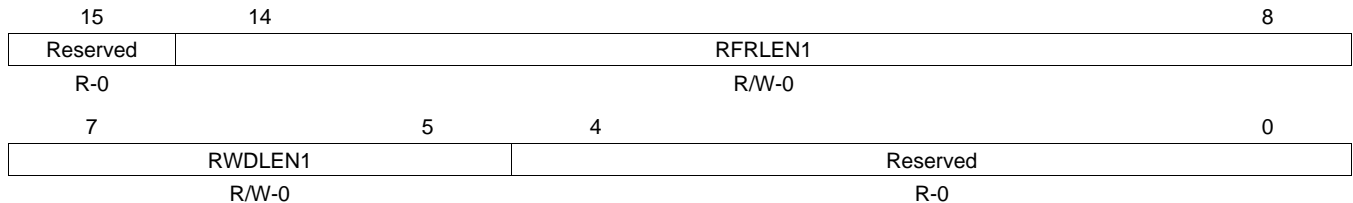

LEGEND: R/W = Read/Write; R = Read only; -n = value after reset

Table 11-4. Receive Control Register 1 (RCR1) Field Descriptions

Bit	Field	Value	Description
15	Reserved	0	Reserved bits (not available for your use). They are read-only bits and return 0s when read.
14-8	RFRLN1	0-7Fh	Receive frame length 1 (1 to 128 words). Each frame of receive data can have one or two phases, depending on value that you load into the RPHASE bit. If a single-phase frame is selected, RFRLN1 in RCR1 selects the number of serial words (8, 12, 16, 20, 24, or 32 bits per word) in the frame. If a dual-phase frame is selected, RFRLN1 determines the number of serial words in phase 1 of the frame, and RFRLN2 in RCR2 determines the number of words in phase 2 of the frame. The 7-bit RFRLN fields allow up to 128 words per phase. See Table 11-5 for a summary of how you determine the frame length. This length corresponds to the number of words or logical time slots or channels per frame-synchronization period. Program the RFRLN fields with $[w \text{ minus } 1]$, where w represents the number of words per phase. For example, if you want a phase length of 128 words in phase 1, load 127 into RFRLN1.

Table 11-4. Receive Control Register 1 (RCR1) Field Descriptions (continued)

Bit	Field	Value	Description
7-5	RWDLEN1	0-7h	Receive word length 1. Each frame of receive data can have one or two phases, depending on the value that you load into the RPHASE bit. If a single-phase frame is selected, RWDLEN1 in RCR1 selects the length for every serial word received in the frame. If a dual-phase frame is selected, RWDLEN1 determines the length of the serial words in phase 1 of the frame, and RWDLEN2 in RCR2 determines the word length in phase 2 of the frame.
		0	8 bits
		1h	12 bits
		2h	16 bits
		3h	20 bits
		4h	24 bits
		5h	32 bits
	6h-7h	Reserved (do not use)	
4-0	Reserved	0	Reserved bits (not available for your use). They are read-only bits and return 0s when read.

Table 11-5. Frame Length Formula for Receive Control 1 Register (RCR1)

RPHASE	RFLEN1	RFLEN2	Frame Length
0	$0 \leq \text{RFLEN1} \leq 127$	Not used	$(\text{RFLEN1} + 1)$ words
1	$0 \leq \text{RFLEN1} \leq 127$	$0 \leq \text{RFLEN2} \leq 127$	$(\text{RFLEN1} + 1) + (\text{RFLEN2} + 1)$ words

11.5.2 Receive Control Register 2 (RCR2)

The receive control register 2 (RCR2) is shown in [Figure 11-6](#) and described in [Table 11-6](#).

Figure 11-6. Receive Control Register 2 (RCR2)

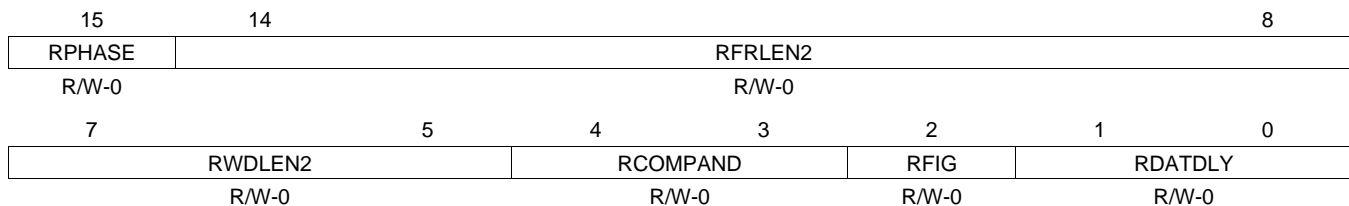

LEGEND: R/W = Read/Write; R = Read only; -n = value after reset

Table 11-6. Receive Control Register 2 (RCR2) Field Descriptions

Bit	Field	Value	Description
15	RPHASE		Receive phase number bit. RPHASE determines whether the receive frame has one phase or two phases. For each phase you can define the serial word length and the number of serial words in the phase. To set up phase 1, program RWDLEN1 (word length) and RFLEN1 (number of words). To set up phase 2 (if there are two phases), program RWDLEN2 and RFLEN2.
		0	Single-phase frame The receive frame has only one phase, phase 1.
		1	Dual-phase frame The receive frame has two phases, phase 1 and phase 2.
14-8		0-7Fh	Receive frame length 2 (1 to 128 words). Each frame of receive data can have one or two phases, depending on value that you load into the RPHASE bit. If a single-phase frame is selected, RFLEN1 in RCR1 selects the number of serial words (8, 12, 16, 20, 24, or 32 bits per word) in the frame. If a dual-phase frame is selected, RFLEN1 determines the number of serial words in phase 1 of the frame, and RFLEN2 in RCR2 determines the number of words in phase 2 of the frame. The 7-bit RFLEN fields allow up to 128 words per phase. See Table 11-7 for a summary of how to determine the frame length. This length corresponds to the number of words or logical time slots or channels per frame-synchronization period. Program the RFLEN fields with $[w \text{ minus } 1]$, where w represents the number of words per phase. For example, if you want a phase length of 128 words in phase 2, load 127 into RFLEN2.

Table 11-6. Receive Control Register 2 (RCR2) Field Descriptions (continued)

Bit	Field	Value	Description
7-5	RWDLEN2	0-7h 0 1h 2h 3h 4h 5h 6h-7h	Receive word length 2. Each frame of receive data can have one or two phases, depending on the value that you load into the RPHASE bit. If a single-phase frame is selected, RWDLEN1 in RCR1 selects the length for every serial word received in the frame. If a dual-phase frame is selected, RWDLEN1 determines the length of the serial words in phase 1 of the frame, and RWDLEN2 in RCR2 determines the word length in phase 2 of the frame. 8 bits 12 bits 16 bits 20 bits 24 bits 32 bits Reserved (do not use)
4-3	RCOMPAND	0-3h 0 1h 2h 3h	Receive companding mode bits. Companding (COMpress and exPAND) hardware allows compression and expansion of data in either μ -law or A-law format. RCOMPAND allows you to choose one of the following companding modes for the McBSP receiver: For more details about these companding modes, see Section 2.2, Companding (Compressing and Expanding) Data . No companding, any size data, MSB received first No companding, 8-bit data, LSB received first μ -law companding, 8-bit data, MSB received first A-law companding, 8-bit data, MSB received first
2	RFIG	0 1	Receive frame-synchronization ignore bit. If a frame-synchronization pulse starts the transfer of a new frame before the current frame is fully received, this pulse is treated as an unexpected frame-synchronization pulse. For more details about the frame-synchronization error condition, see Section 4.3, Unexpected Receive Frame-Synchronization Pulse . Setting RFIG causes the serial port to ignore unexpected frame-synchronization signals during reception. For more details on the effects of RFIG, see Section 7.10.1, Enable/Disable the Receive Frame-Synchronization Ignore Function . 0 Frame-synchronization detect. An unexpected FSR pulse causes the receiver to discard the contents of RSR[1,2] in favor of the new incoming data. The receiver: 1. Aborts the current data transfer 2. Sets RSYNCERR in SPCR1 3. Begins the transfer of a new data word 1 Frame-synchronization ignore. An unexpected FSR pulse is ignored. Reception continues uninterrupted.
1-0	RDATDLY	0-3h 0 1h 2h 3h	Receive data delay bits. RDATDLY specifies a data delay of 0, 1, or 2 receive clock cycles after frame-synchronization and before the reception of the first bit of the frame. For more details, see Section 7.12, Set the Receive Data Delay . 0-bit data delay 1-bit data delay 2-bit data delay Reserved (do not use)

Table 11-7. Frame Length Formula for Receive Control 2 Register (RCR2)

RPHASE	RFRLLEN1	RFRLLEN2	Frame Length
0	$0 \leq \text{RFRLLEN1} \leq 127$	Not used	$(\text{RFRLLEN1} + 1)$ words
1	$0 \leq \text{RFRLLEN1} \leq 127$	$0 \leq \text{RFRLLEN2} \leq 127$	$(\text{RFRLLEN1} + 1) + (\text{RFRLLEN2} + 1)$ words

11.6 Transmit Control Registers (XCR1 and XCR2)

Each McBSP has two transmit control registers, XCR1 ([Table 11-8](#)) and XCR2 ([Table 11-10](#)). These registers enable you to:

- Specify one or two phases for each frame of transmit data (XPHASE)
- Define two parameters for phase 1 and (if necessary) phase 2: the serial word length (XWDLEN1, XWDLEN2) and the number of words (XFRLEN1, XFRLEN2)
- Choose a transmit companding mode, if any (XCOMPAND)
- Enable or disable the transmit frame-sync ignore function (XFIG)
- Choose a transmit data delay (XDATDLY)

11.6.1 Transmit Control 1 Register (XCR1)

The transmit control 1 register (XCR1) is shown in [Figure 11-7](#) and described in [Table 11-8](#).

Figure 11-7. Transmit Control 1 Register (XCR1)

15	14	8
Reserved	XFRLEN1	
R-0	R/W-0	
7	5	4
XWDLEN1		Reserved
R/W-0		R-0
		0

LEGEND: R/W = Read/Write; R = Read only; -n = value after reset

Table 11-8. Transmit Control 1 Register (XCR1) Field Descriptions

Bit	Field	Value	Description														
15	Reserved	0	Reserved bit. Read-only; returns 0 when read.														
14-8	XFRLEN1	0-7Fh	<p>Transmit frame length 1 (1 to 128 words). Each frame of transmit data can have one or two phases, depending on value that you load into the XPHASE bit. If a single-phase frame is selected, XFRLEN1 in XCR1 selects the number of serial words (8, 12, 16, 20, 24, or 32 bits per word) in the frame. If a dual-phase frame is selected, XFRLEN1 determines the number of serial words in phase 1 of the frame and XFRLEN2 in XCR2 determines the number of words in phase 2 of the frame. The 7-bit XFRLEN fields allow up to 128 words per phase. See Table 11-9 for a summary of how you determine the frame length. This length corresponds to the number of words or logical time slots or channels per frame-synchronization period.</p> <p>Program the XFRLEN fields with $[w \text{ minus } 1]$, where w represents the number of words per phase. For example, if you want a phase length of 128 words in phase 1, load 127 into XFRLEN1.</p>														
7-5	XWDLEN1	0-3h	<p>Transmit word length 1. Each frame of transmit data can have one or two phases, depending on the value that you load into the XPHASE bit. If a single-phase frame is selected, XWDLEN1 in XCR1 selects the length for every serial word transmitted in the frame. If a dual-phase frame is selected, XWDLEN1 determines the length of the serial words in phase 1 of the frame and XWDLEN2 in XCR2 determines the word length in phase 2 of the frame.</p> <table border="0" style="margin-left: 20px;"> <tr><td>0</td><td>8 bits</td></tr> <tr><td>1h</td><td>12 bits</td></tr> <tr><td>2h</td><td>16 bits</td></tr> <tr><td>3h</td><td>20 bits</td></tr> <tr><td>4h</td><td>24 bits</td></tr> <tr><td>5h</td><td>32 bits</td></tr> <tr><td>6h-7h</td><td>Reserved (do not use)</td></tr> </table>	0	8 bits	1h	12 bits	2h	16 bits	3h	20 bits	4h	24 bits	5h	32 bits	6h-7h	Reserved (do not use)
0	8 bits																
1h	12 bits																
2h	16 bits																
3h	20 bits																
4h	24 bits																
5h	32 bits																
6h-7h	Reserved (do not use)																
4-0	Reserved	0	Reserved bits. They are read-only bits and return 0s when read.														

Table 11-9. Frame Length Formula for Transmit Control 1 Register (XCR1)

XPHASE	XFRLEN1	XFRLEN2	Frame Length
0	$0 \leq \text{XFRLEN1} \leq 127$	Not used	$(\text{XFRLEN1} + 1)$ words
1	$0 \leq \text{XFRLEN1} \leq 127$	$0 \leq \text{XFRLEN2} \leq 127$	$(\text{XFRLEN1} + 1) + (\text{XFRLEN2} + 1)$ words

11.6.2 Transmit Control 2 Register (XCR2)

The transmit control 2 register (XCR2) is shown in [Figure 11-8](#) and described in [Table 11-10](#).

Figure 11-8. Transmit Control 2 Register (XCR2)

15	14					8
XPHASE		XFRLEN2				
R/W-0		R/W-0				
7	5	4	3	2	1	0
XWDLEN2		XCOMPAND		XFIG	XDATDLY	
R/W-0		R/W-0		R/W-0	R/W-0	

LEGEND: R/W = Read/Write; R = Read only; -n = value after reset

Table 11-10. Transmit Control 2 Register (XCR2) Field Descriptions

Bit	Field	Value	Description
15	XPHASE	0 1	<p>Transmit phase number bit. XPHASE determines whether the transmit frame has one phase or two phases. For each phase you can define the serial word length and the number of serial words in the phase. To set up phase 1, program XWDLEN1 (word length) and XFRLEN1 (number of words). To set up phase 2 (if there are two phases), program XWDLEN2 and XFRLEN2.</p> <p>0 Single-phase frame The transmit frame has only one phase, phase 1.</p> <p>1 Dual-phase frame The transmit frame has two phases, phase 1 and phase 2.</p>
14-8	XFRLEN2	0-7Fh	<p>Transmit frame length 2 (1 to 128 words). Each frame of transmit data can have one or two phases, depending on value that you load into the XPHASE bit. If a single-phase frame is selected, XFRLEN1 in XCR1 selects the number of serial words (8, 12, 16, 20, 24, or 32 bits per word) in the frame. If a dual-phase frame is selected, XFRLEN1 determines the number of serial words in phase 1 of the frame and XFRLEN2 in XCR2 determines the number of words in phase 2 of the frame. The 7-bit XFRLEN fields allow up to 128 words per phase. See Table 11-11 for a summary of how to determine the frame length. This length corresponds to the number of words or logical time slots or channels per frame-synchronization period.</p> <p>Program the XFRLEN fields with $[w \text{ minus } 1]$, where w represents the number of words per phase. For example, if you want a phase length of 128 words in phase 1, load 127 into XFRLEN1.</p>
7-5	XWDLEN2	0-7h 0 1h 2h 3h 4h 5h 6h-7h	<p>Transmit word length 2. Each frame of transmit data can have one or two phases, depending on the value that you load into the XPHASE bit. If a single-phase frame is selected, XWDLEN1 in XCR1 selects the length for every serial word transmitted in the frame. If a dual-phase frame is selected, XWDLEN1 determines the length of the serial words in phase 1 of the frame and XWDLEN2 in XCR2 determines the word length in phase 2 of the frame.</p> <p>0 8 bits 1h 12 bits 2h 16 bits 3h 20 bits 4h 24 bits 5h 32 bits 6h-7h Reserved (do not use)</p>
4-3	XCOMPAND	0-3h 0 1h 2h 3h	<p>Transmit companding mode bits. Companding (COMpress and exPAND) hardware allows compression and expansion of data in either μ-law or A-law format. For more details, see Section 2.2.</p> <p>XCOMPAND allows you to choose one of the following companding modes for the McBSP transmitter. For more details about these companding modes, see Section 2.2.</p> <p>0 No companding, any size data, MSB transmitted first 1h No companding, 8-bit data, LSB transmitted first 2h μ-law companding, 8-bit data, MSB transmitted first 3h A-law companding, 8-bit data, MSB transmitted first</p>

Table 11-10. Transmit Control 2 Register (XCR2) Field Descriptions (continued)

Bit	Field	Value	Description
2	XFIG	0	Transmit frame-synchronization ignore bit. If a frame-synchronization pulse starts the transfer of a new frame before the current frame is fully transmitted, this pulse is treated as an unexpected frame-synchronization pulse. For more details about the frame-synchronization error condition, see Section 4.6 . Setting XFIG causes the serial port to ignore unexpected frame-synchronization pulses during transmission. For more details on the effects of XFIG, see Section 8.10 . Frame-synchronization detect. An unexpected FSX pulse causes the transmitter to discard the content of XSR[1,2]. The transmitter: <ol style="list-style-type: none"> 1. Aborts the present transmission 2. Sets XSYNCERR in SPCR2 3. Begins a new transmission from DXR[1,2]. If new data was written to DXR[1,2] since the last DXR[1,2]-to-XSR[1,2] copy, the current value in XSR[1,2] is lost. Otherwise, the same data is transmitted.
		1	Frame-synchronization ignore. An unexpected FSX pulse is ignored. Transmission continues uninterrupted.
1-0	XDATDLY	0-3h	Transmit data delay bits. XDATDLY specifies a data delay of 0, 1, or 2 transmit clock cycles after frame synchronization and before the transmission of the first bit of the frame. For more details, see Section 8.12 .
		0	0-bit data delay
		1h	1-bit data delay
		2h	2-bit data delay
		3h	Reserved (do not use)

Table 11-11. Frame Length Formula for Transmit Control 2 Register (XCR2)

XPHASE	XFRLLEN1	XFRLLEN2	Frame Length
0	$0 \leq \text{XFRLLEN1} \leq 127$	Not used	$(\text{XFRLLEN1} + 1)$ words
1	$0 \leq \text{XFRLLEN1} \leq 127$	$0 \leq \text{XFRLLEN2} \leq 127$	$(\text{XFRLLEN1} + 1) + (\text{XFRLLEN2} + 1)$ words

11.7 Sample Rate Generator Registers (SRGR1 and SRGR2)

Each McBSP has two sample rate generator registers, SRGR1 ([Table 11-12](#)) and SRGR2 ([Table 11-13](#)). The sample rate generator can generate a clock signal (CLKG) and a frame-synchronization signal (FSG). The registers SRGR1 and SRGR2 enable you to:

- Select the input clock source for the sample rate generator (CLKSM, in conjunction with the SCLKME bit of PCR)
- Divide down the frequency of CLKG (CLKGDV)
- Select whether internally-generated transmit frame-synchronization pulses are driven by FSG or by activity in the transmitter (FSGM).
- Specify the width of frame-synchronization pulses on FSG (FWID) and specify the period between those pulses (FPER)

When an external source (via the MCLKR or MCLKX pin) provides the input clock source for the sample rate generator:

- If the CLKX/MCLKR pin is used, the polarity of the input clock is selected with CLKXP/CLKRP of PCR.
- The GSYNC bit of SRGR2 allows you to make CLKG synchronized to an external frame-synchronization signal on the FSR pin, so that CLKG is kept in phase with the input clock.

11.7.1 Sample Rate Generator 1 Register (SRGR1)

The sample rate generator 1 register is shown in [Figure 11-9](#) and described in [Table 11-12](#).

Figure 11-9. Sample Rate Generator 1 Register (SRGR1)

15	8
FWID	
R/W-0	
7	0
CLKGDV	
R/W-1	

LEGEND: R/W = Read/Write; R = Read only; -n = value after reset

Table 11-12. Sample Rate Generator 1 Register (SRGR1) Field Descriptions

Bit	Field	Value	Description															
15-8	FWID	0-FFh	<p>Frame-synchronization pulse width bits for FSG</p> <p>The sample rate generator can produce a clock signal, CLKG, and a frame-synchronization signal, FSG. For frame-synchronization pulses on FSG, (FWID + 1) is the pulse width in CLKG cycles. The eight bits of FWID allow a pulse width of 1 to 256 CLKG cycles:</p> $0 \leq \text{FWID} \leq 255$ $1 \leq (\text{FWID} + 1) \leq 256 \text{ CLKG cycles}$ <p>The period between the frame-synchronization pulses on FSG is defined by the FPER bits.</p>															
7-0	CLKGDV	0-FFh	<p>Divide-down value for CLKG. The sample rate generator can accept an input clock signal and divide it down according to CLKGDV to produce an output clock signal, CLKG. The frequency of CLKG is:</p> $\text{CLKG frequency} = (\text{Input clock frequency}) / (\text{CLKGDV} + 1)$ <p>The input clock is selected by the SCLKME and CLKSM bits:</p> <table border="1" style="margin-left: 20px;"> <thead> <tr> <th>SCLKME</th> <th>CLKSM</th> <th>Input Clock For Sample Rate Generator</th> </tr> </thead> <tbody> <tr> <td>0</td> <td>0</td> <td>Reserved</td> </tr> <tr> <td>0</td> <td>1</td> <td>LSPCLK</td> </tr> <tr> <td>1</td> <td>0</td> <td>Signal on MCLKR pin</td> </tr> <tr> <td>1</td> <td>1</td> <td>Signal on MCLKX pin</td> </tr> </tbody> </table>	SCLKME	CLKSM	Input Clock For Sample Rate Generator	0	0	Reserved	0	1	LSPCLK	1	0	Signal on MCLKR pin	1	1	Signal on MCLKX pin
SCLKME	CLKSM	Input Clock For Sample Rate Generator																
0	0	Reserved																
0	1	LSPCLK																
1	0	Signal on MCLKR pin																
1	1	Signal on MCLKX pin																

11.7.2 Sample Rate Generator 2 Register (SRGR2)

The sample rate generator 2 register (SRGR2) is shown in [Figure 11-10](#) and described in [Table 11-13](#).

Figure 11-10. Sample Rate Generator 2 Register (SRGR2)

15	14	13	12	11	8
GSYNC	Reserved	CLKSM	FSGM	FPER	
R/W-0	R/W-0	R/W-1	R/W-0	R/W-0	
7	FPER				0
R/W-0					

LEGEND: R/W = Read/Write; R = Read only; -n = value after reset

Table 11-13. Sample Rate Generator 2 Register (SRGR2) Field Descriptions

Bit	Field	Value	Description																		
15	GSYNC	0 1	<p>Clock synchronization mode bit for CLKG. GSYNC is used only when the input clock source for the sample rate generator is external—on the MCLKR pin.</p> <p>When GSYNC = 1, the clock signal (CLKG) and the frame-synchronization signal (FSG) generated by the sample rate generator are made dependent on pulses on the FSR pin.</p> <p>No clock synchronization</p> <p>CLKG oscillates without adjustment, and FSG pulses every (FPER + 1) CLKG cycles.</p> <p>Clock synchronization</p> <ul style="list-style-type: none"> • CLKG is adjusted as necessary so that it is synchronized with the input clock on the MCLKR pin. • FSG pulses. FSG only pulses in response to a pulse on the FSR pin. <p>The frame-synchronization period defined in FPER is ignored.</p> <p>For more details, see Section 3.3, Synchronizing Sample Rate Generator Outputs to an External Clock.</p>																		
14	Reserved		Reserved																		
13	CLKSM	0 1	<p>Sample rate generator input clock mode bit. The sample rate generator can accept an input clock signal and divide it down according to CLKGDV to produce an output clock signal, CLKG. The frequency of CLKG is:)</p> $\text{CLKG frequency} = (\text{input clock frequency}) / (\text{CLKGDV} + 1)$ <p>CLKSM is used in conjunction with the SCLKME bit to determine the source for the input clock.</p> <p>A reset selects the CPU clock as the input clock and forces the CLKG frequency to ½ the LSPCLK frequency.</p> <p>The input clock for the sample rate generator is taken from the MCLKR pin, depending on the value of the SCLKME bit of PCR:</p> <table border="1" style="margin-left: auto; margin-right: auto;"> <thead> <tr> <th>SCLKME</th> <th>CLKSM</th> <th>Input Clock For Sample Rate Generator</th> </tr> </thead> <tbody> <tr> <td>0</td> <td>0</td> <td>Reserved</td> </tr> <tr> <td>1</td> <td>0</td> <td>Signal on MCLKR pin</td> </tr> </tbody> </table> <p>The input clock for the sample rate generator is taken from the LSPCLK or from the MCLKX pin, depending on the value of the SCLKME bit of PCR:</p> <table border="1" style="margin-left: auto; margin-right: auto;"> <thead> <tr> <th>SCLKME</th> <th>CLKSM</th> <th>Input Clock For Sample Rate Generator</th> </tr> </thead> <tbody> <tr> <td>0</td> <td>1</td> <td>LSPCLK</td> </tr> <tr> <td>1</td> <td>1</td> <td>Signal on MCLKX pin</td> </tr> </tbody> </table>	SCLKME	CLKSM	Input Clock For Sample Rate Generator	0	0	Reserved	1	0	Signal on MCLKR pin	SCLKME	CLKSM	Input Clock For Sample Rate Generator	0	1	LSPCLK	1	1	Signal on MCLKX pin
SCLKME	CLKSM	Input Clock For Sample Rate Generator																			
0	0	Reserved																			
1	0	Signal on MCLKR pin																			
SCLKME	CLKSM	Input Clock For Sample Rate Generator																			
0	1	LSPCLK																			
1	1	Signal on MCLKX pin																			
12	FSGM	0 1	<p>Sample rate generator transmit frame-synchronization mode bit. The transmitter can get frame synchronization from the FSX pin (FSXM = 0) or from inside the McBSP (FSXM = 1). When FSXM = 1, the FSGM bit determines how the McBSP supplies frame-synchronization pulses.</p> <p>If FSXM = 1, the McBSP generates a transmit frame-synchronization pulse when the content of DXR[1,2] is copied to XSR[1,2].</p> <p>If FSXM = 1, the transmitter uses frame-synchronization pulses generated by the sample rate generator. Program the FWID bits to set the width of each pulse. Program the FPER bits to set the period between pulses.</p>																		
11-0	FPER	0-FFFh	<p>Frame-synchronization period bits for FSG. The sample rate generator can produce a clock signal, CLKG, and a frame-synchronization signal, FSG. The period between frame-synchronization pulses on FSG is (FPER + 1) CLKG cycles. The 12 bits of FPER allow a frame-synchronization period of 1 to 4096 CLKG cycles:</p> $0 \leq \text{FPER} \leq 4095$ $1 \leq (\text{FPER} + 1) \leq 4096 \text{ CLKG cycles}$ <p>The width of each frame-synchronization pulse on FSG is defined by the FWID bits.</p>																		

11.8 Multichannel Control Registers (MCR[1,2])

Each McBSP has two multichannel control registers. MCR1 (Table 11-14) has control and status bits (with an R prefix) for multichannel selection operation in the receiver. MCR2 (Table 11-15) contains the same type of bits (bit with an X prefix) for the transmitter. These registers enable you to:

- Enable all channels or only selected channels for reception (RMCM)
- Choose which channels are enabled/disabled and masked/unmasked for transmission (XMCM)
- Specify whether two partitions (32 channels at a time) or eight partitions (128 channels at a time) can be used (RMCME for reception, XMCME for transmission)
- Assign blocks of 16 channels to partitions A and B when the 2-partition mode is selected (RPABLK and RPBBLK for reception, XPABLK and XPBBLK for transmission)
- Determine which block of 16 channels is currently involved in a data transfer (RCBLK for reception, XCBLK for transmission)

11.8.1 Multichannel Control 1 Register (MCR1)

The multichannel control 1 register (MCR1) is shown in Figure 11-11 and described in Table 11-14.

Figure 11-11. Multichannel Control 1 Register (MCR1)

15				10				9	8
Reserved								RMCME	RPBBLK
R-0								R/W-0	R/W-0
7		6	5	4	2		1	0	
RPBBLK	RPABLK		RCBLK			Reserved		RMCM	
R/W-0	R/W-0		R-0			R-0		R/W-0	

LEGEND: R/W = Read/Write; R = Read only; -n = value after reset

Table 11-14. Multichannel Control 1 Register (MCR1) Field Descriptions

Bit	Field	Value	Description
15-10	Reserved	0	Reserved bits (not available for your use). They are read-only bits and return 0s when read.
9	RMCME	0	Receive multichannel partition mode bit. RMCME is only applicable if channels can be individually enabled or disabled for reception (RMCM = 1). RMCME determines whether only 32 channels or all 128 channels are to be individually selectable. 2-partition mode Only partitions A and B are used. You can control up to 32 channels in the receive multichannel selection mode (RMCM = 1). Assign 16 channels to partition A with the RPABLK bits. Assign 16 channels to partition B with the RPBBLK bits. You control the channels with the appropriate receive channel enable registers: RCERA: Channels in partition A RCERB: Channels in partition B
		1	8-partition mode All partitions (A through H) are used. You can control up to 128 channels in the receive multichannel selection mode. You control the channels with the appropriate receive channel enable registers: RCERA: Channels 0 through 15 RCERB: Channels 16 through 31 RCERC: Channels 32 through 47 RCERD: Channels 48 through 63 RCERE: Channels 64 through 79 RCERF: Channels 80 through 95 RCERG: Channels 96 through 111 RCERH: Channels 112 through 127

Table 11-14. Multichannel Control 1 Register (MCR1) Field Descriptions (continued)

Bit	Field	Value	Description
8-7	RPBBLK	0-3h	<p>Receive partition B block bits</p> <p>RPBBLK is only applicable if channels can be individually enabled or disabled (RMCM = 1) and the 2-partition mode is selected (RMCME = 0). Under these conditions, the McBSP receiver can accept or ignore data in any of the 32 channels that are assigned to partitions A and B of the receiver.</p> <p>The 128 receive channels of the McBSP are divided equally among 8 blocks (0 through 7). When RPBBLK is applicable, use RPBBLK to assign one of the odd-numbered blocks (1, 3, 5, or 7) to partition B. Use the RPABLK bits to assign one of the even-numbered blocks (0, 2, 4, or 6) to partition A.</p> <p>If you want to use more than 32 channels, you can change block assignments dynamically. You can assign a new block to one partition while the receiver is handling activity in the other partition. For example, while the block in partition A is active, you can change which block is assigned to partition B. The RCBLK bits are regularly updated to indicate which block is active.</p> <p>When XMCM = 11b (for symmetric transmission and reception), the transmitter uses the receive block bits (RPABLK and RPBBLK) rather than the transmit block bits (XPABLK and XPBBLK).</p> <p>0 Block 1: channels 16 through 31 1h Block 3: channels 48 through 63 2h Block 5: channels 80 through 95 3h Block 7: channels 112 through 127</p>
6-5	RPABLK	0-3h	<p>Receive partition A block bits</p> <p>RPABLK is only applicable if channels can be individually enabled or disabled (RMCM = 1) and the 2-partition mode is selected (RMCME = 0). Under these conditions, the McBSP receiver can accept or ignore data in any of the 32 channels that are assigned to partitions A and B of the receiver. See the description for RPBBLK (bits 8-7) for more information about assigning blocks to partitions A and B.</p> <p>0 Block 0: channels 0 through 15 1h Block 2: channels 32 through 47 2h Block 5: channels 64 through 79 3h Block 7: channels 96 through 111</p>
4-2	RCBLK	0-7h	<p>Receive current block indicator. RCBLK indicates which block for 16 channels is involved in the current McBSP reception:</p> <p>0 Block 0: channels 0 through 15 1h Block 1: channels 16 through 31 2h Block 2: channels 32 through 47 3h Block 3: channels 48 through 63 4h Block 4: channels 64 through 79 5h Block 5: channels 80 through 95 6h Block 6: channels 96 through 111 7h Block 7: channels 112 through 127</p>
1	Reserved	0	Reserved bits (not available for your use). They are read-only bits and return 0s when read.
0	RMCM	0 1	<p>Receive multichannel selection mode bit. RMCM determines whether all channels or only selected channels are enabled for reception:</p> <p>0 All 128 channels are enabled. 1 Multichanneled selection mode. Channels can be individually enabled or disabled.</p> <p>The only channels enabled are those selected in the appropriate receive channel enable registers (RCERs). The way channels are assigned to the RCERs depends on the number of receive channel partitions (2 or 8), as defined by the RMCME bit.</p>

11.8.2 Multichannel Control 2 Register (MCR2)

The multichannel control 2 register (MCR2) is shown in [Figure 11-12](#) and described in [Table 11-15](#).

Figure 11-12. Multichannel Control 2 Register (MCR2)

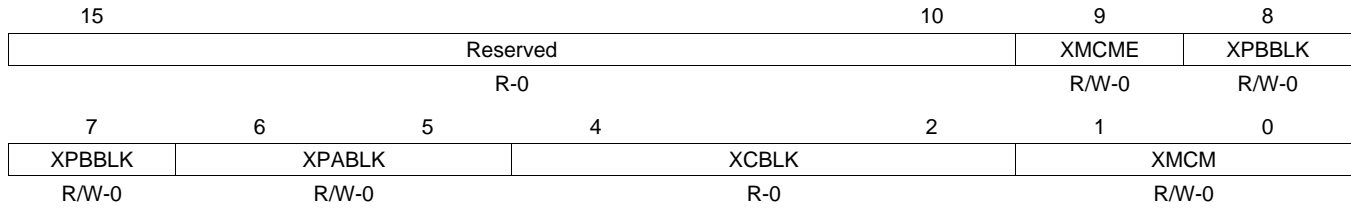

LEGEND: R/W = Read/Write; R = Read only; -n = value after reset

Table 11-15. Multichannel Control 2 Register (MCR2) Field Descriptions

Bit	Field	Value	Description
15-10	Reserved	0	Reserved bits (not available for your use). They are read-only bits and return 0s when read.
9	XMCME	0	Transmit multichannel partition mode bit. XMCME determines whether only 32 channels or all 128 channels are to be individually selectable. XMCME is only applicable if channels can be individually disabled/enabled or masked/unmasked for transmission (XMCM is nonzero). 2-partition mode. Only partitions A and B are used. You can control up to 32 channels in the transmit multichannel selection mode selected with the XMCM bits. If XMCM = 01b or 10b, assign 16 channels to partition A with the XPABLK bits. Assign 16 channels to partition B with the XPBBLK bits. If XMCM = 11b(for symmetric transmission and reception), assign 16 channels to receive partition A with the RPABLK bits. Assign 16 channels to receive partition B with the RPBBLK bits. You control the channels with the appropriate transmit channel enable registers: XCERA: Channels in partition A XCERB: Channels in partition B
		1	8-partition mode. All partitions (A through H) are used. You can control up to 128 channels in the transmit multichannel selection mode selected with the XMCM bits. You control the channels with the appropriate transmit channel enable registers: XCERA: Channels 0 through 15 XCERB: Channels 16 through 31 XCERC: Channels 32 through 47 XCERD: Channels 48 through 63 XCERE: Channels 64 through 79 XCERF: Channels 80 through 95 XCERG: Channels 96 through 111 XCERH: Channels 112 through 127

Table 11-15. Multichannel Control 2 Register (MCR2) Field Descriptions (continued)

Bit	Field	Value	Description																
8-7	XPBBLK	0-3h	<p>Transmit partition B block bits</p> <p>XPBBLK is only applicable if channels can be individually disabled/enabled and masked/unmasked (XMCM is nonzero) and the 2-partition mode is selected (XMCME = 0). Under these conditions, the McBSP transmitter can transmit or withhold data in any of the 32 channels that are assigned to partitions A and B of the transmitter.</p> <p>The 128 transmit channels of the McBSP are divided equally among 8 blocks (0 through 7). When XPBBLK is applicable, use XPBBLK to assign one of the odd-numbered blocks (1, 3, 5, or 7) to partition B, as shown in the following table. Use the XPABLK bit to assign one of the even-numbered blocks (0, 2, 4, or 6) to partition A.</p> <p>If you want to use more than 32 channels, you can change block assignments dynamically. You can assign a new block to one partition while the transmitter is handling activity in the other partition. For example, while the block in partition A is active, you can change which block is assigned to partition B. The XCBLK bits are regularly updated to indicate which block is active.</p> <p>When XMCM = 11b (for symmetric transmission and reception), the transmitter uses the receive block bits (RPABLK and RPBBLK) rather than the transmit block bits (XPABLK and XPBBLK).</p> <table border="0"> <tr> <td>0</td> <td>Block 1: channels 16 through 31</td> </tr> <tr> <td>1h</td> <td>Block 3: channels 48 through 63</td> </tr> <tr> <td>2h</td> <td>Block 5: channels 80 through 95</td> </tr> <tr> <td>3h</td> <td>Block 7: channels 112 through 127</td> </tr> </table>	0	Block 1: channels 16 through 31	1h	Block 3: channels 48 through 63	2h	Block 5: channels 80 through 95	3h	Block 7: channels 112 through 127								
0	Block 1: channels 16 through 31																		
1h	Block 3: channels 48 through 63																		
2h	Block 5: channels 80 through 95																		
3h	Block 7: channels 112 through 127																		
6-5	XPABLK	0-3h	<p>Transmit partition A block bits. XPABLK is only applicable if channels can be individually disabled/enabled and masked/unmasked (XMCM is nonzero) and the 2-partition mode is selected (XMCME = 0). Under these conditions, the McBSP transmitter can transmit or withhold data in any of the 32 channels that are assigned to partitions A and B of the transmitter. See the description for XPBBLK (bits 8-7) for more information about assigning blocks to partitions A and B.</p> <table border="0"> <tr> <td>0</td> <td>Block 0: channels 0 through 15</td> </tr> <tr> <td>1h</td> <td>Block 2: channels 32 through 47</td> </tr> <tr> <td>2h</td> <td>Block 4: channels 64 through 79</td> </tr> <tr> <td>3h</td> <td>Block 6: channels 96 through 111</td> </tr> </table>	0	Block 0: channels 0 through 15	1h	Block 2: channels 32 through 47	2h	Block 4: channels 64 through 79	3h	Block 6: channels 96 through 111								
0	Block 0: channels 0 through 15																		
1h	Block 2: channels 32 through 47																		
2h	Block 4: channels 64 through 79																		
3h	Block 6: channels 96 through 111																		
4-2	XCBLK	0-7h	<p>Transmit current block indicator. XCBLK indicates which block of 16 channels is involved in the current McBSP transmission:</p> <table border="0"> <tr> <td>0</td> <td>Block 0: channels 0 through 15</td> </tr> <tr> <td>1h</td> <td>Block 1: channels 16 through 31</td> </tr> <tr> <td>2h</td> <td>Block 2: channels 32 through 47</td> </tr> <tr> <td>3h</td> <td>Block 3: channels 48 through 63</td> </tr> <tr> <td>4h</td> <td>Block 4: channels 64 through 79</td> </tr> <tr> <td>5h</td> <td>Block 5: channels 80 through 95</td> </tr> <tr> <td>6h</td> <td>Block 6: channels 96 through 111</td> </tr> <tr> <td>7h</td> <td>Block 7: channels 112 through 127</td> </tr> </table>	0	Block 0: channels 0 through 15	1h	Block 1: channels 16 through 31	2h	Block 2: channels 32 through 47	3h	Block 3: channels 48 through 63	4h	Block 4: channels 64 through 79	5h	Block 5: channels 80 through 95	6h	Block 6: channels 96 through 111	7h	Block 7: channels 112 through 127
0	Block 0: channels 0 through 15																		
1h	Block 1: channels 16 through 31																		
2h	Block 2: channels 32 through 47																		
3h	Block 3: channels 48 through 63																		
4h	Block 4: channels 64 through 79																		
5h	Block 5: channels 80 through 95																		
6h	Block 6: channels 96 through 111																		
7h	Block 7: channels 112 through 127																		
1-0	XMCM	0-3h	<p>Transmit multichannel selection mode bits. XMCM determines whether all channels or only selected channels are enabled and unmasked for transmission. For more details on how the channels are affected, see Section 5.7 Transmit Multichannel Selection Modes.</p> <table border="0"> <tr> <td>0</td> <td>No transmit multichannel selection mode is on. All channels are enabled and unmasked. No channels can be disabled or masked.</td> </tr> <tr> <td>1h</td> <td>All channels are disabled unless they are selected in the appropriate transmit channel enable registers (XCERs). If enabled, a channel in this mode is also unmasked. The XMCME bit determines whether 32 channels or 128 channels are selectable in XCERs.</td> </tr> <tr> <td>2h</td> <td>All channels are enabled, but they are masked unless they are selected in the appropriate transmit channel enable registers (XCERs). The XMCME bit determines whether 32 channels or 128 channels are selectable in XCERs.</td> </tr> <tr> <td>3h</td> <td>This mode is used for symmetric transmission and reception. All channels are disabled for transmission unless they are enabled for reception in the appropriate receive channel enable registers (RCERs). Once enabled, they are masked unless they are also selected in the appropriate transmit channel enable registers (XCERs). The XMCME bit determines whether 32 channels or 128 channels are selectable in RCERs and XCERs.</td> </tr> </table>	0	No transmit multichannel selection mode is on. All channels are enabled and unmasked. No channels can be disabled or masked.	1h	All channels are disabled unless they are selected in the appropriate transmit channel enable registers (XCERs). If enabled, a channel in this mode is also unmasked. The XMCME bit determines whether 32 channels or 128 channels are selectable in XCERs.	2h	All channels are enabled, but they are masked unless they are selected in the appropriate transmit channel enable registers (XCERs). The XMCME bit determines whether 32 channels or 128 channels are selectable in XCERs.	3h	This mode is used for symmetric transmission and reception. All channels are disabled for transmission unless they are enabled for reception in the appropriate receive channel enable registers (RCERs). Once enabled, they are masked unless they are also selected in the appropriate transmit channel enable registers (XCERs). The XMCME bit determines whether 32 channels or 128 channels are selectable in RCERs and XCERs.								
0	No transmit multichannel selection mode is on. All channels are enabled and unmasked. No channels can be disabled or masked.																		
1h	All channels are disabled unless they are selected in the appropriate transmit channel enable registers (XCERs). If enabled, a channel in this mode is also unmasked. The XMCME bit determines whether 32 channels or 128 channels are selectable in XCERs.																		
2h	All channels are enabled, but they are masked unless they are selected in the appropriate transmit channel enable registers (XCERs). The XMCME bit determines whether 32 channels or 128 channels are selectable in XCERs.																		
3h	This mode is used for symmetric transmission and reception. All channels are disabled for transmission unless they are enabled for reception in the appropriate receive channel enable registers (RCERs). Once enabled, they are masked unless they are also selected in the appropriate transmit channel enable registers (XCERs). The XMCME bit determines whether 32 channels or 128 channels are selectable in RCERs and XCERs.																		

11.9 Pin Control Register (PCR)

Each McBSP has one pin control register (PCR). [Table 11-16](#) describes the bits of PCR. This register enables you to:

- Choose a frame-synchronization mode for the transmitter (FSXM) and for the receiver (FSRM)
- Choose a clock mode for transmitter (CLKXM) and for the receiver (CLKRM)
- Select the input clock source for the sample rate generator (SCLKME, in conjunction with the CLKSM bit of SRGR2)
- Choose whether frame-synchronization signals are active low or active high (FSXP for transmission, FSRP for reception)
- Specify whether data is sampled on the falling edge or the rising edge of the clock signals (CLKXP for transmission, CLKRP for reception)

The pin control register (PCR) is shown in [Figure 11-13](#) and described in [Table 11-16](#).

Figure 11-13. Pin Control Register (PCR)

15		12		11	10	9	8
Reserved				FSXM	FSRM	CLKXM	CLKRM
R-0				R/W-0	R/W-0	R/W-0	R/W-0
7	6	5	4	3	2	1	0
SCLKME	Reserved	DXSTAT	DRSTAT	FSXP	FSRP	CLKXP	CLKRP
R/W-0	R-0	R/W-0	R-0	R/W-0	R/W-0	R/W-0	R/W-0

LEGEND: R/W = Read/Write; R = Read only; -n = value after reset

Table 11-16. Pin Control Register (PCR) Field Descriptions

Bit	Field	Value	Description
15:12	Reserved	0	Reserved bit (not available for your use). It is a read-only bit and returns a 0 when read.
11	FSXM	0	Transmit frame synchronization is supplied by an external source via the FSX pin.
		1	Transmit frame synchronization is generated internally by the Sample Rate generator, as determined by the FSGM bit of SRGR2.
10	FSRM	0	Receive frame synchronization is supplied by an external source via the FSR pin.
		1	Receive frame synchronization is supplied by the sample rate generator. FSR is an output pin reflecting internal FSR, except when GSYNC = 1 in SRGR2.

Table 11-16. Pin Control Register (PCR) Field Descriptions (continued)

Bit	Field	Value	Description																		
9	CLKXM	<p>0</p> <p>1</p> <p>0</p> <p>1</p>	<p>Transmit clock mode bit. CLKXM determines whether the source for the transmit clock is external or internal, and whether the MCLKX pin is an input or an output. The polarity of the signal on the MCLKX pin is determined by the CLKXP bit.</p> <p>In the clock stop mode (CLKSTP = 10b or 11b), the McBSP can act as a master or as a slave in the SPI protocol. If the McBSP is a master, make sure that CLKX is an output. If the McBSP is a slave, make sure that CLKX is an input.</p> <p>Not in clock stop mode (CLKSTP = 00b or 01b):</p> <p>The transmitter gets its clock signal from an external source via the MCLKX pin.</p> <p>Internal CLKX is driven by the sample rate generator of the McBSP. The MCLKX pin is an output pin that reflects internal CLKX.</p> <p>In clock stop mode (CLKSTP = 10b or 11b):</p> <p>The McBSP is a slave in the SPI protocol. The internal transmit clock (CLKX) is driven by the SPI master via the MCLKX pin. The internal receive clock (MCLKR) is driven internally by CLKX, so that both the transmitter and the receiver are controlled by the external master clock.</p> <p>The McBSP is a master in the SPI protocol. The sample rate generator drives the internal transmit clock (CLKX). Internal CLKX is reflected on the MCLKX pin to drive the shift clock of the SPI-compliant slaves in the system. Internal CLKX also drives the internal receive clock (MCLKR), so that both the transmitter and the receiver are controlled by the internal master clock.</p>																		
8	CLKRM	<p>0</p> <p>1</p> <p>0</p> <p>1</p>	<p>Receive clock mode bit. The role of CLKRM and the resulting effect on the MCLKR pin depend on whether the McBSP is in the digital loopback mode (DLB = 1).</p> <p>The polarity of the signal on the MCLKR pin is determined by the CLKRP bit.</p> <p>Not in digital loopback mode (DLB = 0):</p> <p>The MCLKR pin is an input pin that supplies the internal receive clock (MCLKR).</p> <p>Internal MCLKR is driven by the sample rate generator of the McBSP. The MCLKR pin is an output pin that reflects internal MCLKR.</p> <p>In digital loopback mode (DLB = 1):</p> <p>The MCLKR pin is in the high impedance state. The internal receive clock (MCLKR) is driven by the internal transmit clock (CLKX). CLKX is derived according to the CLKXM bit.</p> <p>Internal MCLKR is driven by internal CLKX. The MCLKR pin is an output pin that reflects internal MCLKR. CLKX is derived according to the CLKXM bit.</p>																		
7	SCLKME		<p>Sample rate generator input clock mode bit. The sample rate generator can produce a clock signal, CLKG. The frequency of CLKG is:</p> $\text{CLKG freq.} = (\text{Input clock frequency}) / (\text{CLKGDV} + 1)$ <p>SCLKME is used in conjunction with the CLKSM bit to select the input clock.</p> <table border="1"> <thead> <tr> <th>SCLKME</th> <th>CLKSM</th> <th>Input Clock For Sample Rate Generator</th> </tr> </thead> <tbody> <tr> <td>0</td> <td>0</td> <td>Reserved</td> </tr> <tr> <td>0</td> <td>1</td> <td>LSPCLK</td> </tr> </tbody> </table> <p>The input clock for the sample rate generator is taken from the MCLKR pin or from the MCLKX pin, depending on the value of the CLKSM bit of SRGR2:</p> <table border="1"> <thead> <tr> <th>SCLKME</th> <th>CLKSM</th> <th>Input Clock For Sample Rate Generator</th> </tr> </thead> <tbody> <tr> <td>1</td> <td>0</td> <td>Signal on MCLKR pin</td> </tr> <tr> <td>1</td> <td>1</td> <td>Signal on MCLKX pin</td> </tr> </tbody> </table>	SCLKME	CLKSM	Input Clock For Sample Rate Generator	0	0	Reserved	0	1	LSPCLK	SCLKME	CLKSM	Input Clock For Sample Rate Generator	1	0	Signal on MCLKR pin	1	1	Signal on MCLKX pin
SCLKME	CLKSM	Input Clock For Sample Rate Generator																			
0	0	Reserved																			
0	1	LSPCLK																			
SCLKME	CLKSM	Input Clock For Sample Rate Generator																			
1	0	Signal on MCLKR pin																			
1	1	Signal on MCLKX pin																			
6	Reseved																				
5	DXSTAT	<p>0</p> <p>1</p>	<p>DX pin bit. When DXSTAT is applicable, you can toggle the signal on DX by writing to DXSTAT.</p> <p>DXSTAT is only applicable when the transmitter is in reset (XRST = 0) and DX is configured for use as a general-purpose output pin.</p> <p>Drive the signal on the DX pin low.</p> <p>Drive the signal on the DX pin high.</p>																		

Table 11-16. Pin Control Register (PCR) Field Descriptions (continued)

Bit	Field	Value	Description
4	DRSTAT		DR pin status bit. When DRSTAT is applicable, it reflects the level on the DR pin. DRSTAT is only applicable when the receiver is in reset (RRST = 0) and DR is configured for use as a general-purpose input pin.
		0	The signal on DR pin is low.
		1	The signal on DR pin is high.
		3	FSXP
0	Transmit frame-synchronization pulses are active high.		
		1	Transmit frame-synchronization pulses are active low.
		2	FSRP
0	Receive frame-synchronization pulses are active high.		
		1	Receive frame-synchronization pulses are active low.
		1	CLKXP
0	Transmit data is sampled on the rising edge of CLKX.		
		1	Transmit data is sampled on the falling edge of CLKX.
		0	CLKRP
0	Receive data is sampled on the falling edge of MCLKR.		
		1	Receive data is sampled on the rising edge of MCLKR.

Table 11-17. Pin Configuration

Pin	Selected as Output When ...	Selected as Input When ...
CLKX	CLKXM = 1	CLKXM = 0
FSX	FSXM = 1	FSXM = 0
CLKR	CLKRM = 1	CLKRM = 0
FSR	FSRM = 1	FSRM = 0

11.10 Receive Channel Enable Registers (RCERA, RCERB, RCERC, RCERD, RCERE, RCERF, RCERG, RCERH)

Each McBSP has eight receive channel enable registers of the format shown in [Figure 11-14](#). There is one enable register for each of the receive partitions: A, B, C, D, E, F, G, and H. [Table 11-18](#) provides a summary description that applies to any bit x of a receive channel enable register.

These memory-mapped registers are only used when the receiver is configured to allow individual enabling and disabling of the channels (RMCM = 1). For more details about the way these registers are used, see [Section 11.10.1, RCERs Used in the Receive Multichannel Selection Mode](#).

The receive channel enable registers (RCERA...RCERH) are shown in [Figure 11-14](#) and described in [Table 11-18](#).

Figure 11-14. Receive Channel Enable Registers (RCERA...RCERH)

15	14	13	12	11	10	9	8
RCE15	RCE14	RCE13	RCE12	RCE11	RCE10	RCE9	RCE8
R/W-0	R/W-0	R/W-0	R/W-0	R/W-0	R/W-0	R/W-0	R/W-0
7	6	5	4	3	2	1	0
RCE7	RCE6	RCE5	RCE4	RCE3	RCE2	RCE1	RCE0
R/W-0	R/W-0	R/W-0	R/W-0	R/W-0	R/W-0	R/W-0	R/W-0

LEGEND: R/W = Read/Write; R = Read only; -n = value after reset

Table 11-18. Receive Channel Enable Registers (RCERA...RCERH) Field Descriptions

Bit	Field	Value	Description
15-0	RCE _x		Receive channel enable bit. For receive multichannel selection mode (RMCM = 1):
		0	Disable the channel that is mapped to RCE _x .
		1	Enable the channel that is mapped to RCE _x .

11.10.1 RCERs Used in the Receive Multichannel Selection Mode

For multichannel selection operation, the assignment of channels to the RCERs depends on whether 32 or 128 channels are individually selectable, as defined by the RMCME bit. For each of these two cases, [Table 11-19](#) shows which block of channels is assigned to each of the RCERs used. For each RCER, the table shows which channel is assigned to each of the bits.

Table 11-19. Use of the Receive Channel Enable Registers

Number of Selectable Channels	Block Assignments		Channel Assignments	
	RCER _x	Block Assigned	Bit in RCER _x	Channel Assigned
32 (RMCME = 0)	RCERA	Channels n to (n + 15) The block of channels is chosen with the RPABLK bits.	RCE0	Channel n
			RCE1	Channel (n + 1)
			RCE2	Channel (n + 2)
			:	:
			RCE15	Channel (n + 15)
	RCERB	Channels m to (m + 15) The block of channels is chosen with the RPBBLK bits.	RCE0	Channel m
			RCE1	Channel (m + 1)
			RCE2	Channel (m + 2)
			:	:
			RCE15	Channel (m + 15)
128 (RMCME = 1)	RCERA	Block 0	RCE0	Channel 0
			RCE1	Channel 1
			RCE2	Channel 2
			:	:
	RCERB	Block 1	RCE15	Channel 15
			RCE0	Channel 16
			RCE1	Channel 17
			RCE2	Channel 18
	RCERC	Block 2	:	:
			RCE15	Channel 31
			RCE0	Channel 32
			RCE1	Channel 33
RCERD	Block 3	RCE2	Channel 34	
		:	:	
		RCE15	Channel 47	
		RCE0	Channel 48	
			RCE1	Channel 49
			RCE2	Channel 50
			:	:
			RCE15	Channel 63

Table 11-19. Use of the Receive Channel Enable Registers (continued)

Number of Selectable Channels	Block Assignments		Channel Assignments	
	RCERx	Block Assigned	Bit in RCERx	Channel Assigned
	RCERE	Block 4	RCE0	Channel 64
			RCE1	Channel 65
			RCE2	Channel 66
			:	:
			RCE15	Channel 79
	RCERF	Block 5	RCE0	Channel 80
			RCE1	Channel 81
			RCE2	Channel 82
			:	:
			RCE15	Channel 95
	RCERG	Block 6	RCE0	Channel 96
			RCE1	Channel 97
			RCE2	Channel 98
			:	:
			RCE15	Channel 111
	RCERH	Block 7	RCE0	Channel 112
			RCE1	Channel 113
			RCE2	Channel 114
			:	:
			RCE15	Channel 127

11.11 Transmit Channel Enable Registers (XCERA, XCERB, XCERC, XCERD, XCERE, XCERF, XCEG, XCEH)

Each McBSP has eight transmit channel enable registers of the form shown in [Figure 11-15](#). There is one for each of the transmit partitions: A, B, C, D, E, F, G, and H. [Table 11-20](#) provides a summary description that applies to each bit XCE_x of a transmit channel enable register.

The XCERs are only used when the transmitter is configured to allow individual disabling/enabling and masking/unmasking of the channels (XMCM is nonzero).

The transmit channel enable registers (XCERA...XCEH) are shown in [Figure 11-15](#) and described in [Table 11-20](#).

Figure 11-15. Transmit Channel Enable Registers (XCERA...XCEH)

15	14	13	12	11	10	9	8
XCE15	XCE14	XCE13	XCE12	XCE11	XCE10	XCE9	XCE8
R/W-0	R/W-0	R/W-0	R/W-0	R/W-0	R/W-0	R/W-0	R/W-0
7	6	5	4	3	2	1	0
XCE7	XCE6	XCE5	XCE4	XCE3	XCE2	XCE1	XCE0
R/W-0	R/W-0	R/W-0	R/W-0	R/W-0	R/W-0	R/W-0	R/W-0

LEGEND: R/W = Read/Write; R = Read only; -n = value after reset

Table 11-20. Transmit Channel Enable Registers (XCERA...XCERH) Field Descriptions

Bit	Field	Value	Description
15-0	XCEx		Transmit channel enable bit. The role of this bit depends on which transmit multichannel selection mode is selected with the XMCM bits. For multichannel selection when XMCM = 01b (all channels disabled unless selected):
		0	Disable and mask the channel that is mapped to XCEx.
		1	Enable and unmask the channel that is mapped to XCEx.
			For multichannel selection when XMCM = 10b (all channels enabled but masked unless selected):
		0	Mask the channel that is mapped to XCEx.
		1	Unmask the channel that is mapped to XCEx.
			For multichannel selection when XMCM = 11b (all channels masked unless selected):
		0	Mask the channel that is mapped to XCEx. Even if the channel is enabled by the corresponding receive channel enable bit, this channel's data cannot appear on the DX pin.
		1	Unmask the channel that is mapped to XCEx. If the channel is also enabled by the corresponding receive channel enable bit, full transmission can occur.

11.11.1 XCERs Used in a Transmit Multichannel Selection Mode

For multichannel selection operation, the assignment of channels to the XCERs depends on whether 32 or 128 channels are individually selectable, as defined by the XMCM bit. These two cases are shown in [Table 11-21](#). The table shows which block of channels is assigned to each XCER that is used. For each XCER, the table shows which channel is assigned to each of the bits.

NOTE: When XMCM = 11b (for symmetric transmission and reception), the transmitter uses the receive channel enable registers (RCERs) to enable channels and uses the XCERs to unmask channels for transmission.

Table 11-21. Use of the Transmit Channel Enable Registers

Number of Selectable Channels	Block Assignments		Channel Assignments			
	XCERx	Block Assigned	Bit in XCERx	Channel Assigned		
32 (XMCM = 0)	XCERA	Channels n to (n + 15) When XMCM = 01b or 10b, the block of channels is chosen with the XPABLK bits. When XMCM = 11b, the block is chosen with the RPABLK bits.	XCE0	Channel n		
			XCE1	Channel (n + 1)		
			XCE2	Channel (n + 2)		
			:	:		
			XCE15	Channel (n + 15)		
			XCERB	Channels m to (m + 15) When XMCM = 01b or 10b, the block of channels is chosen with the XPBBLK bits. When XMCM = 11b, the block is chosen with the RPBBLK bits.	XCE0	Channel m
					XCE1	Channel (m + 1)
					XCE2	Channel (m + 2)
					:	:
					XCE15	Channel (m + 15)

Table 11-21. Use of the Transmit Channel Enable Registers (continued)

Number of Selectable Channels	Block Assignments		Channel Assignments	
	XCERx	Block Assigned	Bit in XCERx	Channel Assigned
128 (XMCME = 1)	XCERA	Block 0	XCE0	Channel 0
			XCE1	Channel 1
			XCE2	Channel 2
			:	:
			XCE15	Channel 15
	XCERB	Block 1	XCE0	Channel 16
			XCE1	Channel 17
			XCE2	Channel 18
			:	:
			XCE15	Channel 31
	XCERC	Block 2	XCE0	Channel 32
			XCE1	Channel 33
			XCE2	Channel 34
			:	:
			XCE15	Channel 47
	XCERD	Block 3	XCE0	Channel 48
			XCE1	Channel 49
			XCE2	Channel 50
			:	:
			XCE15	Channel 63
	XCERE	Block 4	XCE0	Channel 64
			XCE1	Channel 65
			XCE2	Channel 66
			:	:
			XCE15	Channel 79
	XCERF	Block 5	XCE0	Channel 80
			XCE1	Channel 81
			XCE2	Channel 82
:			:	
		XCE15	Channel 95	
XCERG	Block 6	XCE0	Channel 96	
		XCE1	Channel 97	
		XCE2	Channel 98	
		:	:	
		XCE15	Channel 111	
XCERH	Block 7	XCE0	Channel 112	
		XCE1	Channel 113	
		XCE2	Channel 114	
		:	:	
		XCE15	Channel 127	

11.12 Interrupt Generation

McBSP registers can be programmed to receive and transmit data through DRR2/DRR1 and DXR2/DXR1 registers, respectively. The CPU can directly access these registers to move data from memory to these registers. Interrupt signals will be based on these register pair contents and its related flags. MRINT/MXINT will generate CPU interrupts for receive and transmit conditions.

11.12.1 McBSP Receive Interrupt Generation

In the McBSP module, data receive and error conditions generate two sets of interrupt signals. One set is used for the CPU and the other set is for DMA.

Figure 11-16. Receive Interrupt Generation

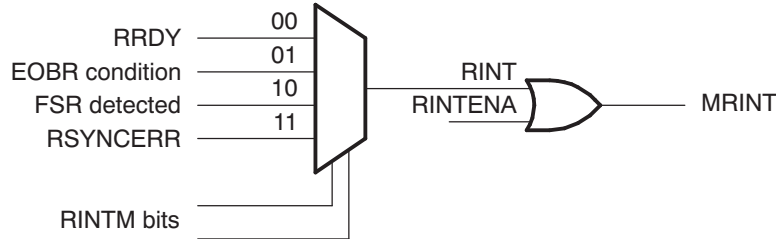

Table 11-22. Receive Interrupt Sources and Signals

McBSP Interrupt Signal	Interrupt Flags	Interrupt Enables in SPCR1	Interrupt Enables	Type of Interrupt	Interrupt Line
		RINTM Bits			
RINT	RRDY	0	RINTENA	Every word receive	MRINT
	EOBR	1	RINTENA	Every 16 channel block boundary	
	FSR	10	RINTENA	On every FSR	
	RSYNCERR	11	RINTENA	Frame sync error	

NOTE: Since X/RINT, X/REVT, and X/RXFFINT share the same CPU interrupt, it is recommended that all applications use one of the above selections for interrupt generation. If multiple interrupt enables are selected at the same time, there is a likelihood of interrupts being masked or not recognized.

11.12.2 McBSP Transmit Interrupt Generation

McBSP module data transmit and error conditions generate two sets of interrupt signals. One set is used for the CPU and the other set is for DMA.

Figure 11-17. Transmit Interrupt Generation

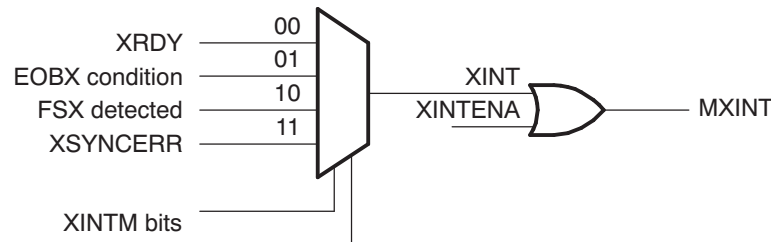

Table 11-23. Transmit Interrupt Sources and Signals

McBSP Interrupt Signal	Interrupt Flags	Interrupt Enables in SPCR1	Interrupt Enables	Type of Interrupt	Interrupt Line
		XINTM Bits			
XINT	XRDY	0	XINTENA	Every word receive	MXINT
	EOBR	1	XINTENA	Every 16-channel block boundary	

Table 11-23. Transmit Interrupt Sources and Signals (continued)

McBSP Interrupt Signal	Interrupt Flags	Interrupt Enables in SPCR1	Interrupt Enables	Type of Interrupt	Interrupt Line
	FSX	10	XINTENA	On every FSX	
	XSYNCERR	11	XINTENA	Frame sync error	

11.12.3 Error Flags

The McBSP has several error flags both on receive and transmit channel. [Table 11-24](#) explains the error flags and their meaning.

Table 11-24. Error Flags

Error Flags	Function
RFULL	Indicates DRR2/DRR1 are not read and RXR register is overwritten
RSYNCERR	Indicates unexpected frame-sync condition, current data reception will abort and restart. Use RINTM bit 11 for interrupt generation on this condition.
XSYNCERR	Indicates unexpected frame-sync condition, current data transmission will abort and restart. Use XINTM bit 11 for interrupt generation on this condition.

11.12.4 McBSP Interrupt Enable Register

Figure 11-18. McBSP Interrupt Enable Register (MFFINT)

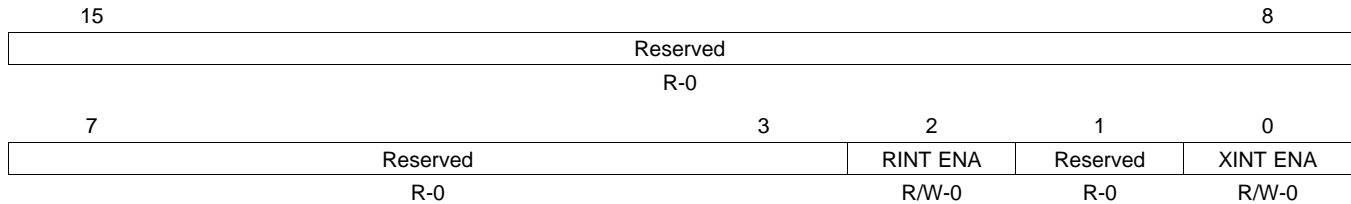

LEGEND: R/W = Read/Write; R = Read only; -n = value after reset

Table 11-25. McBSP Interrupt Enable Register (MFFINT) Field Descriptions

Bit	Field	Value	Description
15:3	Reserved		Reserved
2	RINT ENA	0	Enable for Receive Interrupt Receive interrupt on RRDY is disabled.
		1	Receive interrupt on RRDY is enabled.
1	Reserved		
0	XINT ENA	0	Enable for transmit Interrupt Transmit interrupt on XRDY is disabled.
		1	Transmit interrupt on XRDY is enabled.

11.13 McBSP Modes

McBSP, in its normal mode, communicates with various types of Codecs with variable word size. Apart from this mode, the McBSP uses time-division multiplexed (TDM) data stream while communicating with other McBSPs or serial devices. The multichannel mode provides flexibility while transmitting/receiving selected channels or all the channels in a TDM stream.

[Table 11-26](#) provides a quick reference to McBSP mode selection.

Table 11-26. McBSP Mode Selection

No.	McBSP Word Size	Register Bits Used for Mode Selection				Mode and Function Description
		MCR1 bit 9,0		MCR2 bit 9,1,0		
		RMCME	RMCM	XMCM	XMCM	
1	8/12/16/20/24/32 bit words	0	0	0	0	Normal Mode All types of Codec interface will use this selection
2	8-bit words					Multichannel Mode 2 Partition or 32-channel Mode
		0	1	0	1	All channels are disabled, unless selected in X/RCERA/B
		0	1	0	10	All channels are enabled, but masked unless selected in X/RCERA/B
		0	1	0	11	Symmetric transmit, receive 8 Partition or 128 Channel Mode Transmit/Receive Channels selected by X/RCERA to X/RCERH bits
		1	1	1	1	Multichannel Mode is ON All channels are disabled, unless selected in XCERs
		1	1	1	10	All channels are enabled, but masked unless selected in XCERs
		1	1	1	11	Symmetric transmit, receive
		1	0	1	0	Continuous Mode - Transmit Multi-Channel Mode is OFF All 128 channels are active and enabled

Revision History

This document has been revised to include the following updates.

Table A-1. Changes in this Revision

Location	Additions, Modifications, Deletions
Global	Deleted "I/O-mapped" in regards to registers
Global	Modified SPI signals to TI nomenclature, in graphics and in text
Section 1.3.1	Replaced seven pins with six pins in the first sentence. Deleted the two duplicate paragraphs underneath Figure 1.
Table 2-2	Changed the title of the table to match the section heading.
Section 3.3.1	Removed "therefore, the CLK(R/X) pin must not be driven by any other driving source" from the second bullet.
Figure 3-3 and Figure 3-4	Removed CLKX in these figures.
Table 6-4	Changed CLKGDV to CLKGDV=1
Section 7.2.1	Added "provided the McBSP clock is turned on" to the first list item.
Table 11-16	Changed text to bit 5 and bit 4. Deleted XIOEN=1 for bit 5 and RIOEN=1 for bit 4
Table 11-26	For McBSP Word Size, added 20; so now it is 8/12/16/20/24/32

IMPORTANT NOTICE

Texas Instruments Incorporated and its subsidiaries (TI) reserve the right to make corrections, modifications, enhancements, improvements, and other changes to its products and services at any time and to discontinue any product or service without notice. Customers should obtain the latest relevant information before placing orders and should verify that such information is current and complete. All products are sold subject to TI's terms and conditions of sale supplied at the time of order acknowledgment.

TI warrants performance of its hardware products to the specifications applicable at the time of sale in accordance with TI's standard warranty. Testing and other quality control techniques are used to the extent TI deems necessary to support this warranty. Except where mandated by government requirements, testing of all parameters of each product is not necessarily performed.

TI assumes no liability for applications assistance or customer product design. Customers are responsible for their products and applications using TI components. To minimize the risks associated with customer products and applications, customers should provide adequate design and operating safeguards.

TI does not warrant or represent that any license, either express or implied, is granted under any TI patent right, copyright, mask work right, or other TI intellectual property right relating to any combination, machine, or process in which TI products or services are used. Information published by TI regarding third-party products or services does not constitute a license from TI to use such products or services or a warranty or endorsement thereof. Use of such information may require a license from a third party under the patents or other intellectual property of the third party, or a license from TI under the patents or other intellectual property of TI.

Reproduction of TI information in TI data books or data sheets is permissible only if reproduction is without alteration and is accompanied by all associated warranties, conditions, limitations, and notices. Reproduction of this information with alteration is an unfair and deceptive business practice. TI is not responsible or liable for such altered documentation. Information of third parties may be subject to additional restrictions.

Resale of TI products or services with statements different from or beyond the parameters stated by TI for that product or service voids all express and any implied warranties for the associated TI product or service and is an unfair and deceptive business practice. TI is not responsible or liable for any such statements.

TI products are not authorized for use in safety-critical applications (such as life support) where a failure of the TI product would reasonably be expected to cause severe personal injury or death, unless officers of the parties have executed an agreement specifically governing such use. Buyers represent that they have all necessary expertise in the safety and regulatory ramifications of their applications, and acknowledge and agree that they are solely responsible for all legal, regulatory and safety-related requirements concerning their products and any use of TI products in such safety-critical applications, notwithstanding any applications-related information or support that may be provided by TI. Further, Buyers must fully indemnify TI and its representatives against any damages arising out of the use of TI products in such safety-critical applications.

TI products are neither designed nor intended for use in military/aerospace applications or environments unless the TI products are specifically designated by TI as military-grade or "enhanced plastic." Only products designated by TI as military-grade meet military specifications. Buyers acknowledge and agree that any such use of TI products which TI has not designated as military-grade is solely at the Buyer's risk, and that they are solely responsible for compliance with all legal and regulatory requirements in connection with such use.

TI products are neither designed nor intended for use in automotive applications or environments unless the specific TI products are designated by TI as compliant with ISO/TS 16949 requirements. Buyers acknowledge and agree that, if they use any non-designated products in automotive applications, TI will not be responsible for any failure to meet such requirements.

Following are URLs where you can obtain information on other Texas Instruments products and application solutions:

Products

Audio	www.ti.com/audio
Amplifiers	amplifier.ti.com
Data Converters	dataconverter.ti.com
DLP® Products	www.dlp.com
DSP	dsp.ti.com
Clocks and Timers	www.ti.com/clocks
Interface	interface.ti.com
Logic	logic.ti.com
Power Mgmt	power.ti.com
Microcontrollers	microcontroller.ti.com
RFID	www.ti-rfid.com
OMAP Mobile Processors	www.ti.com/omap
Wireless Connectivity	www.ti.com/wirelessconnectivity

Applications

Communications and Telecom	www.ti.com/communications
Computers and Peripherals	www.ti.com/computers
Consumer Electronics	www.ti.com/consumer-apps
Energy and Lighting	www.ti.com/energy
Industrial	www.ti.com/industrial
Medical	www.ti.com/medical
Security	www.ti.com/security
Space, Avionics and Defense	www.ti.com/space-avionics-defense
Transportation and Automotive	www.ti.com/automotive
Video and Imaging	www.ti.com/video

TI E2E Community Home Page

e2e.ti.com

Mailing Address: Texas Instruments, Post Office Box 655303, Dallas, Texas 75265
Copyright © 2011, Texas Instruments Incorporated