

Single-ended to differential using a two op-amp circuit

Bryan McKay, Art Kay

Input	ADC Differential Input (Vdif)	ADC Common-Mode Input (Vcm)	Digital Output ADS9110
0V	–5V	2.5V	20000 _H
5V	+5V	2.5V	1FFFF _H

Power Supplies			
V+ (op amp)	AVDD	DVDD	REFP
5V	5V	3V	5V

Design Description

This circuit uses two [OPA320](#) op amps to perform a single-ended to differential conversion for driving the [ADS8912B](#) fully-differential ADC. Another approach to solve this problem uses a fully-differential amplifier (FDA). See [Single-Ended to Differential Conversion Using an Op Amp and FDA for Unipolar Signals](#) for the FDA example. Since there are many thousands of different types of op amps available, finding an op amp that meets your specific requirements may be easier than finding a fully-differential amplifier. Most FDAs, for example, do not have as good swing to the rail, offset, bias current, and drift as many precision op amps have. On the other hand, the op-amp approach has an asymmetrical group delay in the inverting and non-inverting paths. Furthermore, FDA amplifiers often have better distortion and ADC drive characteristics. In general, the FDA approach will achieve best SNR and THD, and the op-amp approach will achieve best DC characteristics. Nevertheless, the specific op amp or FDA will impact the comparison of the two typologies.

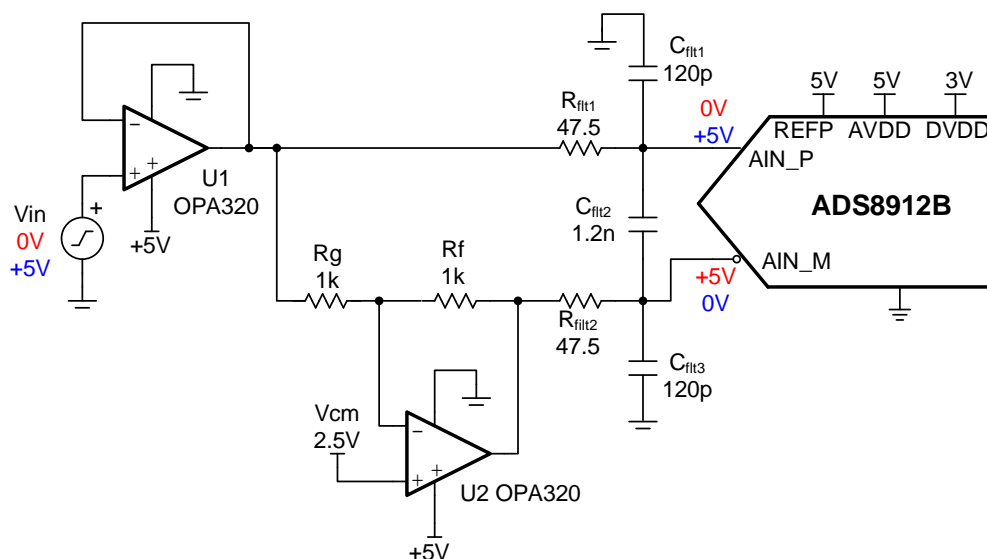

Specifications

Specification	Goal	Calculated	Simulated
Transient ADC Input Settling (1MSPS)	$< 0.5\text{LSB} = 19.1\mu\text{V}$	NA	$5\mu\text{V}$
Input Output Range	NA	NA	$0.1 < V_{\text{IN}} < 4.9\text{V}$ $-4.8\text{V} < V_{\text{OUT}} < 4.8\text{V}$
Noise	NA	$30.5\mu\text{V}_{\text{RMS}}$	$28.4\mu\text{V}_{\text{RMS}}$

Design Notes

1. Use 0.1% resistors for R1 and Rg to minimize gain error and drift on U2.
2. Select COG (NPO) capacitors for C_{filt1} , C_{filt2} , and C_{filt3} to minimize distortion.
3. The [TI Precision Labs – ADC](#) training video series covers methods for selecting the charge bucket circuit R_{filt} and C_{filt} . These component values are dependent on the amplifier bandwidth, data converter sampling rate, and data converter design. The values shown here will give good settling and AC performance for the amplifier and data converter in this example. If you modify this design you will need to select a different RC filter. See the [Introduction to SAR ADC Front-End Component Selection](#) training video for an explanation of how to select the RC filter for best settling and AC performance.

Component Selection

1. Select an op amp to meet the system requirements. Key specifications to consider follow:
 - Swing to rail - For 5-V supply rails it is common to use a rail-to-rail zero crossover distortion device (for example, [OPA320](#), [OPA325](#), and [OPA365](#)).
 - Offset voltage and Drift - One of the advantages of this circuit over the FDA approach is that some op-amps can have very good DC performance.
 - Bandwidth and quiescent current - Another advantage of this circuit over the FDA approach is that a wide range of op-amp bandwidth and related quiescent currents are available. For lower sampling rate a low bandwidth low current op amp may be a good choice.
2. Choose R_g and R_f to minimize noise. The gain of this circuit is always 1, so $R_g = R_f$. The main consideration here is to minimize noise while keeping the load resistance reasonable. Set the resistor noise to be roughly $\frac{1}{3}$ of the amplifier noise. In this example $R_f = R_g = 1\text{k}\Omega$ gives a noise of $2.8\text{nV}/\sqrt{\text{Hz}}$ which is approximately $\frac{1}{3}$ of the $7\text{nV}/\sqrt{\text{Hz}}$ op-amp noise. Also, the maximum load current is 2.5mA ($5\text{V} / 2\text{k}\Omega = 2.5\text{mA}$) which is low compared to the op-amp short-circuit limit (65mA).
3. Find R_{filt} and C_{filt} to allow for settling at 1kSPS. See [Refine the Rfilt and Cfilt Values](#) for the algorithm to select R_{filt} and C_{filt} . The final value of 200k Ω and 510pF proved to settle to well below $\frac{1}{2}$ of a least significant bit (LSB).

DC Transfer Characteristics

The following graph shows the DC transfer characteristics for this circuit (0-V to 5-V single-ended input, -5-V to +5-V fully-differential output). Note that the linear range is limited to about 0.1V from both supply rails (V_{in} linear range approximately 0.1V to 4.9V). The limitation is from the amplifier output swing limit. For improved linear swing the negative and positive supply on the amplifiers would need to be adjusted. See [Low-Power Sensor Measurements: 3.3-V, 1-ksps, 12-bit, Single-Ended, Dual-Supply Circuit](#) for an example on how to do this.

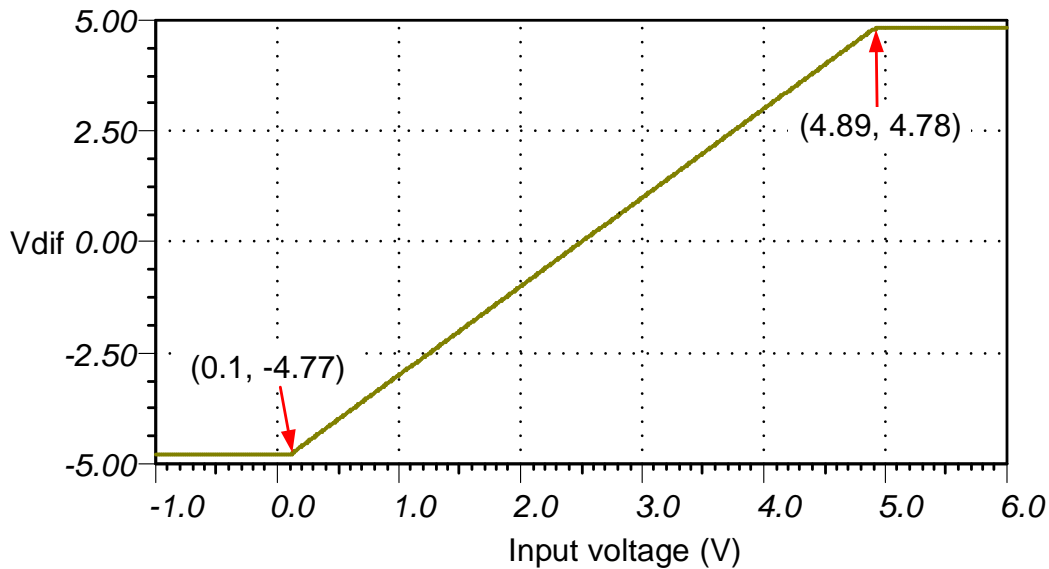

AC Transfer Characteristics

In this case the bandwidth limitation is primarily set by the R_{fit} , C_{fit} values. The amplifier closed loop bandwidth can also impact the overall bandwidth. Note the bandwidth of U2 is half the bandwidth of U1 as its noise gain is two ($BW_{U2} = GBW/G_n = 20MHz/2 = 10MHz$).

$$f_c = \frac{1}{2\pi R \cdot C} = \frac{1}{2\pi(2 \cdot 47.5\Omega) \cdot 1.2nF} = 1.4MHz$$

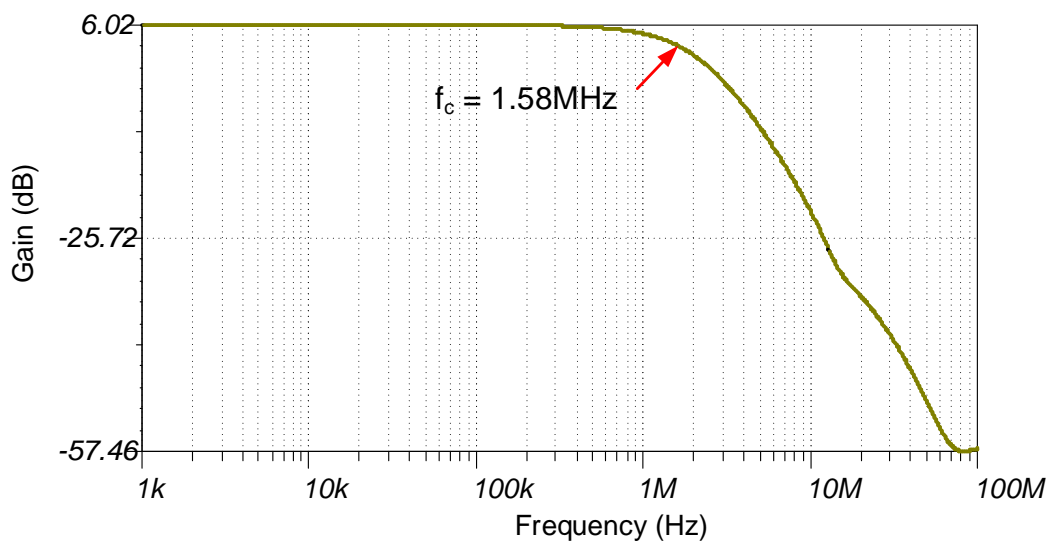

Group Delay (Frequency Domain)

Group delay is the time delay between the applied input signal and the output signal. All amplifiers and filters will have a group delay. Group delay is highlighted for this circuit because the inverting and non-inverting path both have different group delays. This can create distortion for higher frequency signals. See the group delay in time domain plot for additional detail.

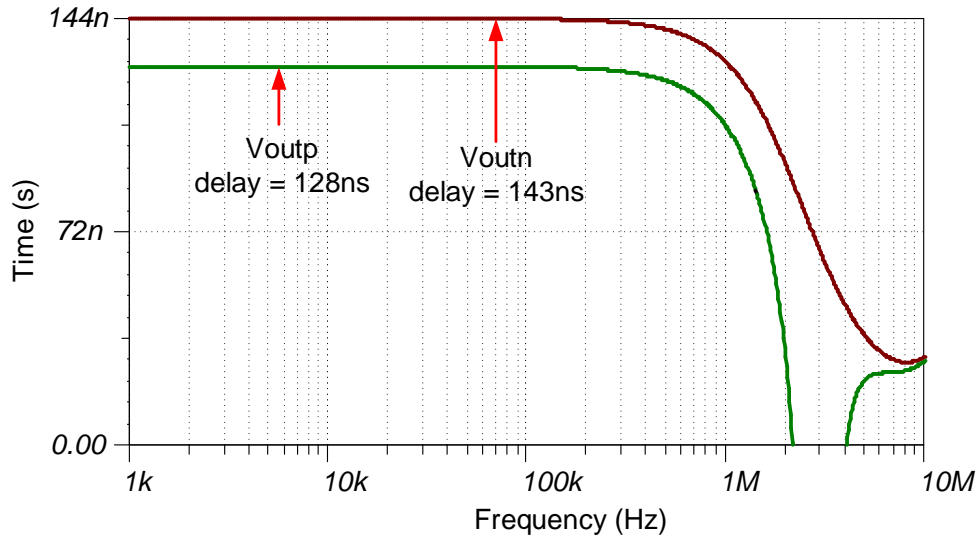

Group Delay (Time Domain)

The following graph shows qualitatively how group delay can effect time domain signals. The errors in this plot are exaggerated to emphasize the effect of group delay. The green signal represents the output on AIN_P and the blue signal represents the inverted output on AIN_N. Ideally, the two signals should track, but the group delay shifts the blue signal to the right. Notice that when signals are moving slowly the error is relatively small and when they are moving rapidly the error is larger. Thus, low frequency signals will have good distortion, and higher frequency signals will have degraded distortion. SPICE does not simulate THD, so for quantitative values measurement is required. However, if the input signal period more than 1,000 times larger than the group delay between the channels than this effect can generally be neglected.

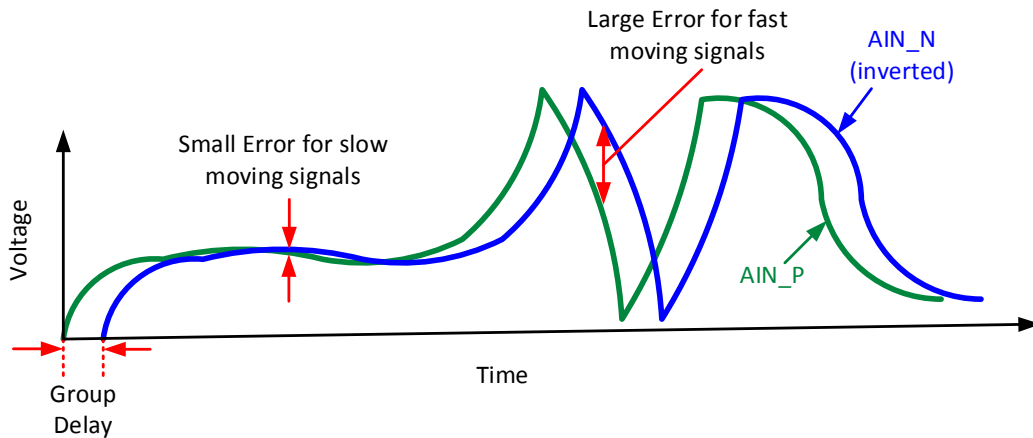

Noise Simulation

The following noise calculation considers the amplifier and resistor noise. Note that the noise from U1 is inverted by U2 and added at the differential output. Since this noise is directly correlated, it adds directly as opposed to root sum square addition usually used for noise sources. Also note that the output filter is approximated as first order but it is a more complex filter. The calculated noise compares well to the simulated noise (calculated = $30.5\mu V_{RMS}$, simulated = $28.4\mu V_{RMS}$).

$$e_{nU1} = e_{n320} + e_{n320} = 7\text{ nV}/\sqrt{\text{Hz}} + 7\text{ nV}/\sqrt{\text{Hz}} = 14\text{ nV}/\sqrt{\text{Hz}} \text{ Note these two sources are correlated}$$

$$R_{eq} = \frac{R_f \cdot R_g}{R_f + R_g} = \frac{1\text{ k}\Omega \cdot 1\text{ k}\Omega}{1\text{ k}\Omega + 1\text{ k}\Omega} = 500\Omega$$

$$e_{nRe q} = \sqrt{4K_n \cdot T_K \cdot R_{eq}} = \sqrt{4(1.38 \cdot 10^{-23}\text{ J/K}) \cdot (298.15) \cdot (500\Omega)} = 2.87\text{ nV}/\sqrt{\text{Hz}}$$

$$e_{nU2} = \sqrt{(e_{nRe q} \cdot G_n)^2 + (e_{n320} \cdot G_n)^2} = \sqrt{(2.87\text{ nV}/\sqrt{\text{Hz}} \cdot 2)^2 + (7\text{ nV}/\sqrt{\text{Hz}} \cdot 2)^2} = 15.1\text{ nV}/\sqrt{\text{Hz}}$$

$$e_{nT} = \sqrt{(e_{nU1})^2 + (e_{nU2})^2} = \sqrt{(14\text{ nV}/\sqrt{\text{Hz}})^2 + (15.1\text{ nV}/\sqrt{\text{Hz}})^2} = 20.6\text{ nV}/\sqrt{\text{Hz}}$$

$$f_c = \frac{1}{2\pi R \cdot C} = \frac{1}{2\pi(2 \cdot 47.5\Omega) \cdot 1.2\text{ nF}} = 1.4\text{ MHz}$$

$$E_{nT} = e_{nT} \cdot \sqrt{1.57 \cdot f_c} = 20.6\text{ nV}/\sqrt{\text{Hz}} \cdot \sqrt{1.57 \cdot 1.4\text{ MHz}} = 30.5\mu V_{RMS}$$

The calculated noise compares well to the simulated noise (calculated = $30.5\mu V_{RMS}$, simulated = $28.4\mu V_{RMS}$). See [Calculating the Total Noise for ADC Systems](#) for detailed theory on this subject.

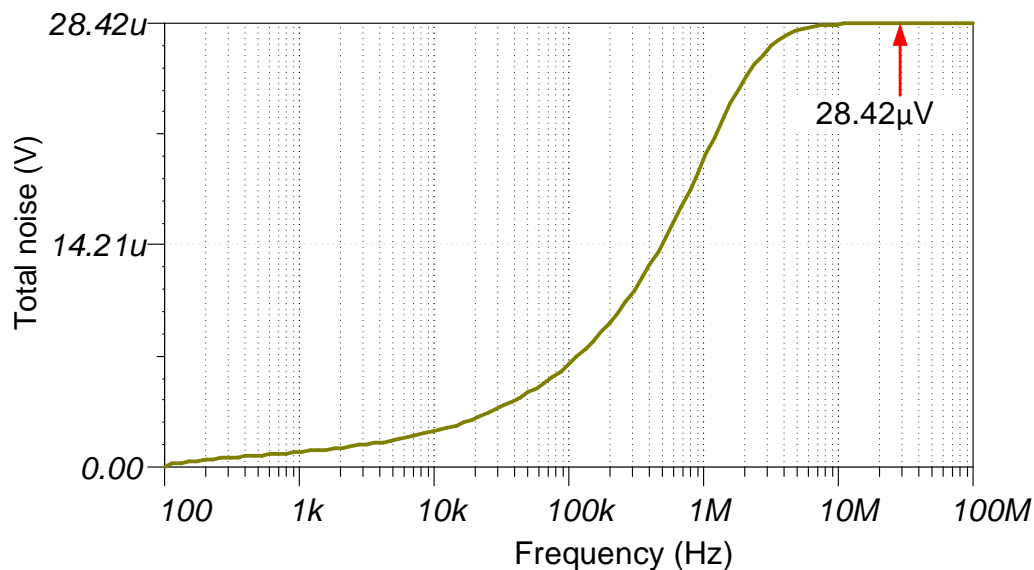

Transient ADC Input Settling Simulation

The following simulation shows settling to a full scale DC input signal at 500kSPS. This type of simulation shows that the sample and hold kickback circuit is properly selected. See [Introduction to SAR ADC Front-End Component Selection](#) for detailed theory on this subject.

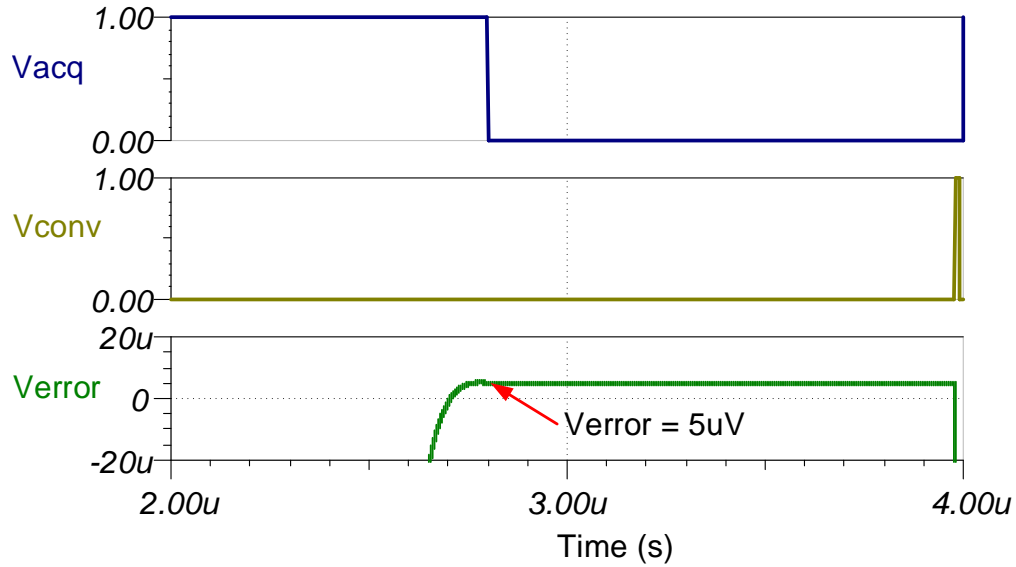

Design Featured Devices

Device	Key Features	Link	Other Possible Devices
ADS8912	18-bit resolution, 500-kSPS sample rate, integrated reference buffer, fully-differential input, Vref input range 2.5V to 5V.	http://www.ti.com/product/ADS8912 B	http://www.ti.com/adcs
OPA320	20-MHz bandwidth, Rail-to-Rail with zero crossover distortion, VosMax = 150 μ V, VosDriftMax = 5 μ V/C, en = 7 nV/ \sqrt Hz	http://www.ti.com/product/OPA320	http://www.ti.com/opamps

Design References

See [Analog Engineer's Circuit Cookbooks](#) for TI's comprehensive circuit library.

Link to Key Files

Source files for this circuit - <http://www.ti.com/lit/zip/SBAC193>.

IMPORTANT NOTICE AND DISCLAIMER

TI PROVIDES TECHNICAL AND RELIABILITY DATA (INCLUDING DATASHEETS), DESIGN RESOURCES (INCLUDING REFERENCE DESIGNS), APPLICATION OR OTHER DESIGN ADVICE, WEB TOOLS, SAFETY INFORMATION, AND OTHER RESOURCES "AS IS" AND WITH ALL FAULTS, AND DISCLAIMS ALL WARRANTIES, EXPRESS AND IMPLIED, INCLUDING WITHOUT LIMITATION ANY IMPLIED WARRANTIES OF MERCHANTABILITY, FITNESS FOR A PARTICULAR PURPOSE OR NON-INFRINGEMENT OF THIRD PARTY INTELLECTUAL PROPERTY RIGHTS.

These resources are intended for skilled developers designing with TI products. You are solely responsible for (1) selecting the appropriate TI products for your application, (2) designing, validating and testing your application, and (3) ensuring your application meets applicable standards, and any other safety, security, or other requirements. These resources are subject to change without notice. TI grants you permission to use these resources only for development of an application that uses the TI products described in the resource. Other reproduction and display of these resources is prohibited. No license is granted to any other TI intellectual property right or to any third party intellectual property right. TI disclaims responsibility for, and you will fully indemnify TI and its representatives against, any claims, damages, costs, losses, and liabilities arising out of your use of these resources.

TI's products are provided subject to TI's Terms of Sale (www.ti.com/legal/termsofsale.html) or other applicable terms available either on ti.com or provided in conjunction with such TI products. TI's provision of these resources does not expand or otherwise alter TI's applicable warranties or warranty disclaimers for TI products.

Mailing Address: Texas Instruments, Post Office Box 655303, Dallas, Texas 75265
Copyright © 2019, Texas Instruments Incorporated