

TAS6424-Q1 Inductor Selection Guide

Gregg Scott

Amplifiers and Actuator Products

ABSTRACT

New technologies in class-D amplifiers change the inductor requirements in the LC filter. The important parameters are discussed to understand their effects on determining the proper inductor needed for high frequency class-D amplifiers.

Contents

1	Inductor Parameters	2
2	Determine the Proper Inductance Value.....	2
3	Selection Guide	7
4	FFT Plots.....	9
5	References	14

List of Figures

1	LC Filter for BD Mode (Half is Shown).....	2
2	Frequency Response of a Type 2 Filter (3.3- μ H Inductor, 1- μ F Capacitor, 4- Ω Load).....	3
3	Inductance vs DC Current	4
4	Temperature Rise vs DC Current.....	4
5	Core Material	5
6	Inductor THD FFT	5
7	THD vs Power.....	6
8	THD+N vs Output Power	7
9	Cyntec VCHW042A MS6	9
10	Cyntec VCMT063T MN5	10
11	Cyntec VAMV6077E-3R3MM2-79	10
12	Murata DFE322520FD-3R3M	11
13	Sagami DBL8087H-3R3M-R1	11
14	Sunlord ASWPA6055S3R3MT9.....	12
15	Taiyo Yuden NRS5040T-3R3M	12
16	TDK SPM6530T-3R3M	13
17	Toko FDSD0420-H-3R3M.....	13
18	Toko DFEG0730D-3R3M	14

List of Tables

1	Inductor Specifications	7
---	-------------------------------	---

1 Inductor Parameters

1.1 Inductance

An inductor is a component that both stores the AC energy passing through it in its magnetic field, as well as resists change to the passing current level. The Inductance value influences the rate of change of current through the inductor.

1.2 DC Resistance (DCR)

This is the DC resistance of the internal conductor and is directly related to DC current losses. This is the largest contributor to efficiency loss in class-D amplifiers.

1.3 Saturation Current

The saturation current is the amount of current specified as a maximum or typical value flowing through the inductor which will induce a specified drop in inductance of the inductor. This is not the maximum current allowed to flow through the inductor. It is a single point on the L vs. I graph.

1.4 Temperature Rise Current

The temperature rise current is the amount of current (Max or Typical) flowing through the inductor which will induce a specified increase in the temperature of the inductor. This is typically specified as a 40°C rise above ambient. This is not the maximum current allowed to flow through the inductor. It is a point on the Temp vs. I graph

1.5 L vs I Graph

Using the L vs I graph or Inductance (L) versus Current (I) graph is helpful in understanding how the inductor will react with audio signals over the power range of the amplifier as well as in a current limit event.

2 Determine the Proper Inductance Value

There are several application notes already written on determining the proper inductance value for class-D amplifiers, such as, [SLOA119](#) and [SLAA701](#). Refer to these documents to learn how to calculate the LC filter values.

The TAS6424-Q1 uses BD modulation, resulting in the single-ended circuit shown in [Figure 1](#) (see [SLAA701](#) for derivation).

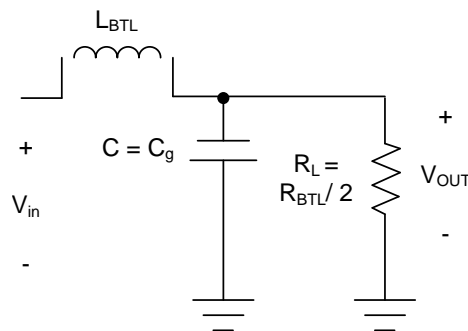

Figure 1. LC Filter for BD Mode (Half is Shown)

The TAS6424 has a switching frequency of up to 2.1 MHz. The higher switching frequency allows for a higher cutoff frequency to be used than with 500 kHz class-D amplifiers. This higher cutoff frequency requires a lower inductance value resulting in an inductor that can be physically smaller.

Using the calculations in the referenced application notes, the values for the LC filter are 3.3- μ H inductor and 1- μ F capacitor on each leg of the device. Assuming a 4- Ω load, this gives a cutoff frequency of 116 kHz. With a 2- Ω load this gives a cutoff frequency of 64 kHz. The capacitor value chosen is optimized for both 4- Ω and 2- Ω loads. This means that the response is slightly overdamped for a 2- Ω load and slightly underdamped for a 4- Ω load as illustrated in Figure 2.

Additionally, the TAS6424-Q1 is designed for a minimum inductance of 2 μ H. Therefore, the inductance must not go below 2 μ H at the highest current that could be delivered by the TAS6424-Q1 in the given system it is implemented.

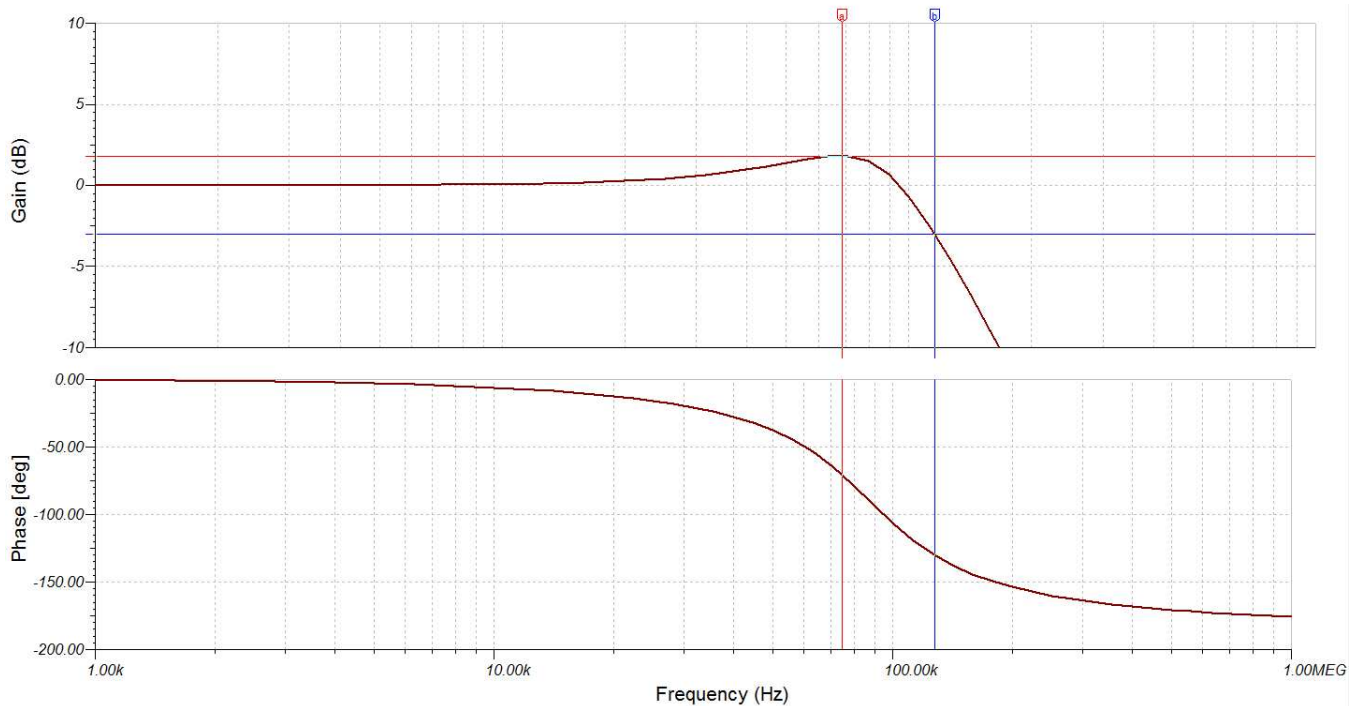

Figure 2. Frequency Response of a Type 2 Filter (3.3- μ H Inductor, 1- μ F Capacitor, 4- Ω Load)

2.1 Inductance vs. DC Current

The graph in [Figure 3](#) shows the relationship between inductance and DC current for a typical 3.3 μH low permeability inductor. The inductance starts falling off as current rises. Conversely, a high permeability switched mode power supply (SMPS) inductor will hold its inductance as current increases and will eventually drop off at saturation. A SMPS needs the inductance to be stable to provide regulation and stability of the system. For audio amplifiers, this is not the case and low permeability inductors provide higher saturation current for a smaller size inductor (this is explained further in the core material section of this app note). The inductance vs. DC current graph is important in inductor choice as the designer must ensure that the inductance does not go below the 2 μH minimum inductance at the highest expected current.

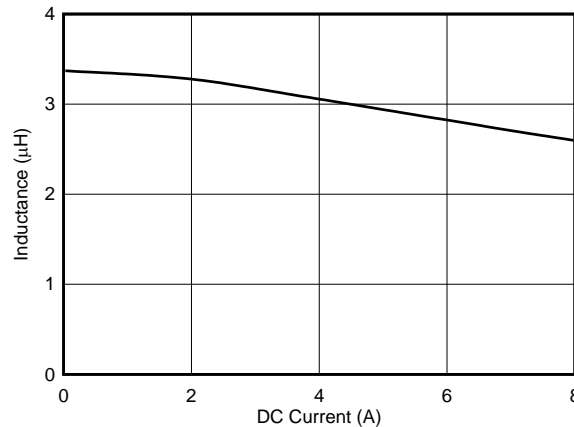

Figure 3. Inductance vs DC Current

2.2 Temp vs. I Graph

The temperature vs. I graph is shown in [Figure 4](#). The temperature rise in the inductor is primarily due to the copper losses in the magnet wire. The wire has a resistance at DC (DCR) and it also has a resistance at higher AC frequencies that increases due to skin effect (ACR). The wire in inductors for the TAS6424-Q1 has a small diameter so the ACR can be neglected. The current rating due to temperature should be decided by the system designer. The temperature rise has a long time constant, so the average current or average power should be used and is system dependent.

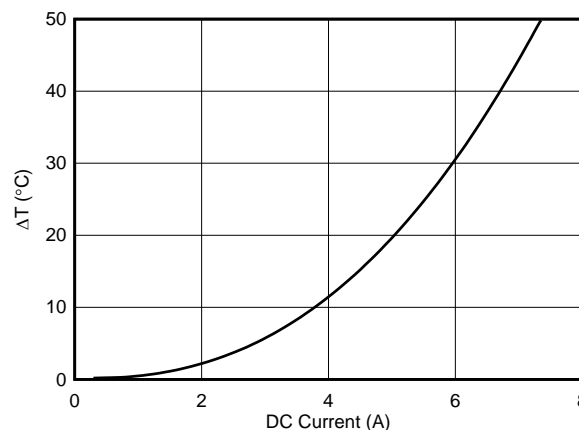

Figure 4. Temperature Rise vs DC Current

The DCR does play a role in the maximum output power that can be delivered to the speaker. In a BTL class-D amplifier there are two inductors in series with the speaker that form a voltage divider. This reduces the signal level at the speaker terminals. The DCR needs to be chosen to allow for the required power level to be delivered to the speaker.

2.3 Core Material

The core material plays the crucial part in how the inductor behaves over the operating current and temperature ranges. It is important to understand the differences and tradeoffs with these materials. The materials can be separated into three types: low, medium, and high permeability (perm). A metal alloy material is classified as a low perm material whereas ferrites fall into medium and high perm.

The metal alloy materials have a low perm, where the inductance starts to drop with current but saturates at a high current. They are also very stable over temperature. Whereas ferrites tend to hold their inductance until they saturate typically at a lower current. Ferrites also are sensitive temperature. As temperature increases the saturation current decreases. Therefore, the filter design must take the worst case temperature into account.

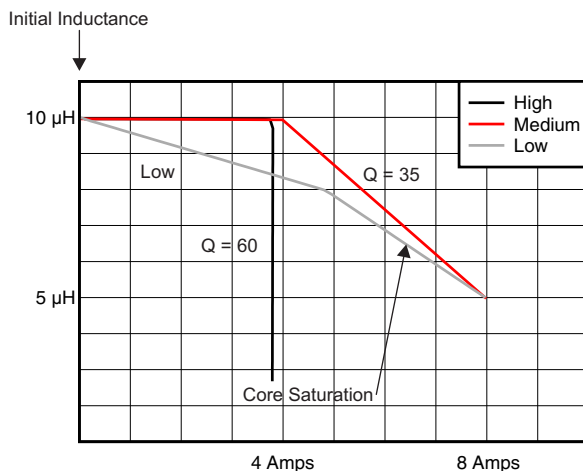

Figure 5. Core Material

A low permeability inductor results in a decreased B field in the inductor core and thus lower harmonics introduced by the inductor. The inductor harmonics are shown in Figure 6. Lower harmonics results in better THD and make low permeability inductors preferable for audio applications. Since low permeability inductors are preferred in this application it is important to consider the decreasing inductance as current is increased. An inductor should be chosen such that the LC filter will not saturate to near zero inductance as the amplifier will see large current spikes and prematurely trip the current limit or the over current shutdown protection.

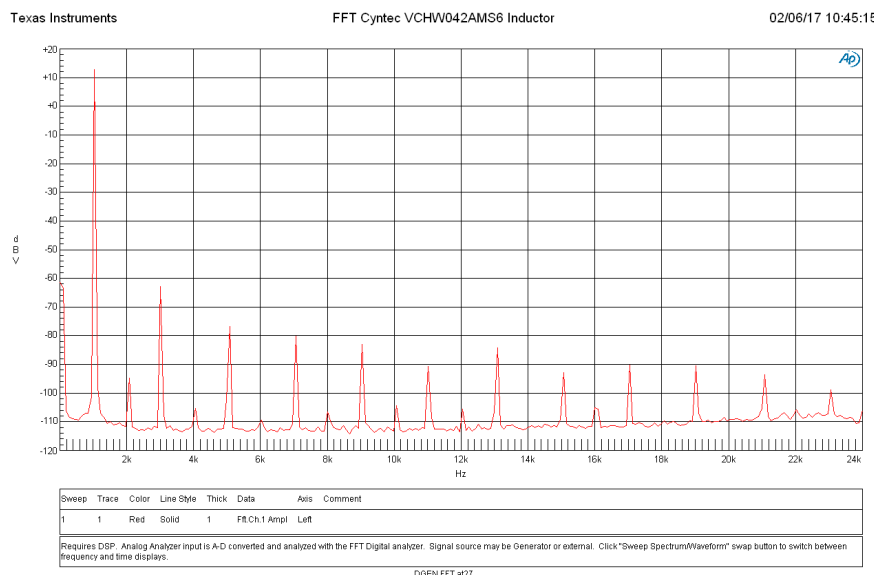

Figure 6. Inductor THD FFT

2.4 Linearity

The linearity of the inductor is not on most inductor datasheets. The linearity is determined by measuring the total harmonic distortion plus noise (THD+n) of the amplifier versus output power. The linearity of the inductor is due to the material that used in the core and the volume of the core material. See [Figure 7](#) for an explanation of the THD+n versus output power curve.

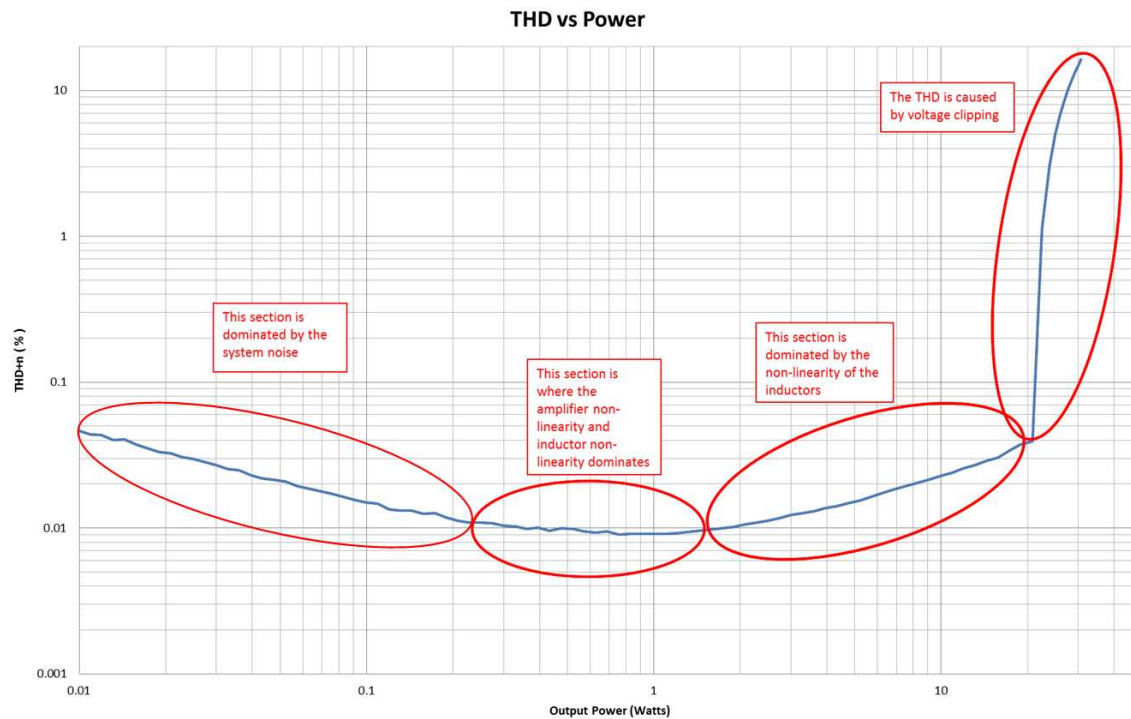

Figure 7. THD vs Power

3 Selection Guide

The selection guide has been created by collecting the datasheets and measuring the THD+n for the inductors. The ranking is determined by the goal of the design. The goals are separated for output power into a load, THD, and physical dimensions.

Table 1. Inductor Specifications

Part Number	Inductance	Dimensions LxWxH (mm)	L _{SAT} (A)	L _{TEMP} (A)	DCR (mΩ)	% THD at 10 W R _L = 4 Ω
Cyntec VCHW042A MS6	3.3μH	4.2 x 4 x 2.1	5.0	4.9	38.0	0.022
Cyntec VCMT063T MN5	3.3μH	7 x 6.6 x 2.8	7.5	7.5	22.5	0.014
Cyntec VAMV06077E-3R3MM2-79	3.3μH x 2	6.9 x 7.6 x 7.3	13	5.7	16.0	0.013
Murata DFE322520FD-3R3M	3.3μH	3.2 x 2.5 x 2	3.9	3.3	51.0	0.023
Sagami DBL8087H-3R3M-R1	3.3μH x 2	8.0 x 8.0 x 9.0	3.9	7.2	18.0	0.005
Sunlord ASWPA6055S3R3MT1	3.3μH	6.0 x 6.0x 5.5	6.6	4.0	21.0	0.007
Taiyo Yuden NRS5040T-3R3M	3.3μH	4.9 x 4.9 x 4.0	4.0	3.3	27.0	0.033
TDK SPM6530T-3R3M	3.3μH	7.1 x 6.5 x 3.0	7.3	6.8	27.0	0.081
Toko FDS0420-H-3R3M	3.3μH	4.2 x4.2 x 2	4.9	3.4	59.0	0.062
Toko DFEG0730D-3R3M	3.3μH	7 x 6.6 x 3	7.1	6.7	24.0	0.022
Würth 784 383 560 33	3.3μH	4.0 x 4.0 x 2.0	5.5	3.6	39.9	0.007

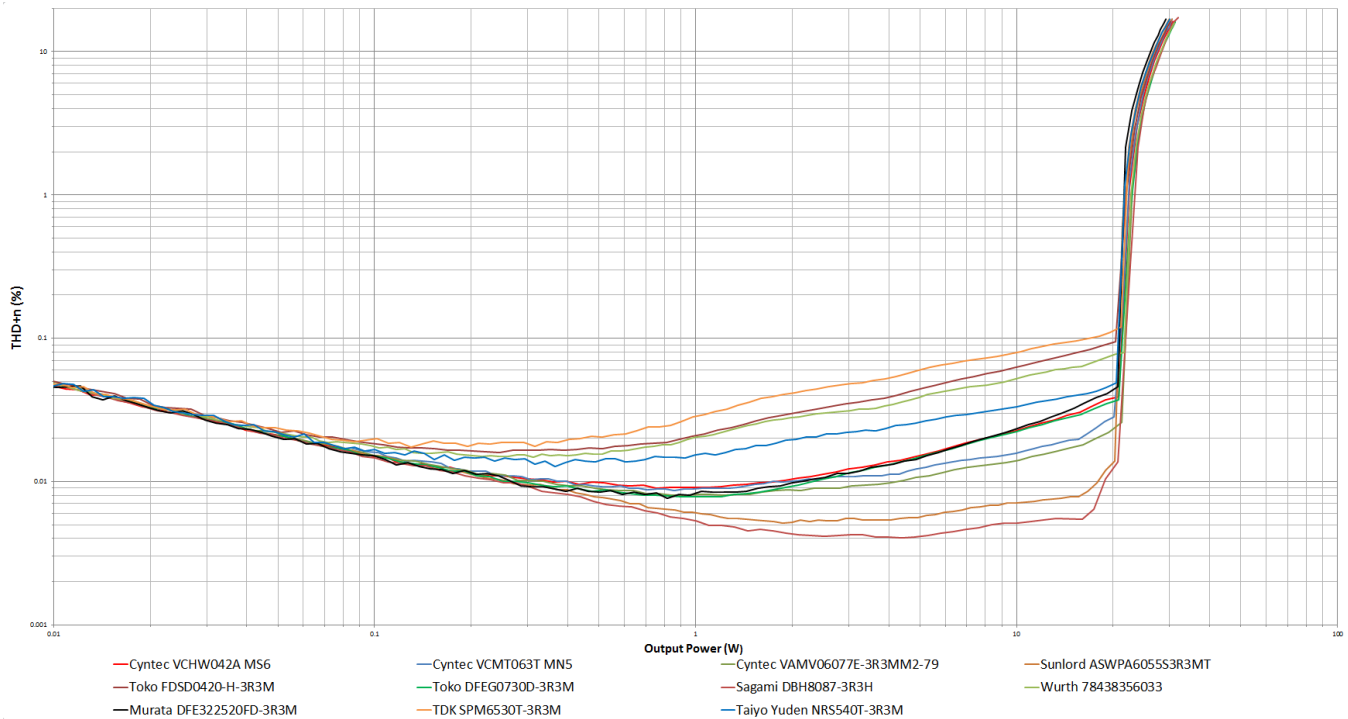

Figure 8. THD+N vs Output Power

3.1 Rank

Ranking is based on the system need. From this data a good all around device is the Cynotec VCMT063T MN5. This device will provide the power and performance for an amplifier driving a 4- Ω or 2- Ω speaker load. For driving a 4- Ω speaker, the power requirement is not as heavily weighted. The Murata DEF322520FD-3R3M inductor has good performance for a small inductor. If absolute performance in THD is needed, then the Sagami DBL8087H-3R3M-R can be used, but with the sacrifice of small size. The price of the inductors has not been part of this study. Usually, the smaller the inductor the lower the cost, but this may not hold true in all cases.

3.1.1 Based on THD:

1. Sagami DBL8087H-3R3M-R
2. Sunlord ASWPA6055S3R3MT
3. Cynotec VAMV06077E-3R3MM2-79
4. Cynotec VCMT063T MN5
5. Toko DFEG0730D-3R3M
6. Murata DFE322520FD-3R3M
7. Cynotec VCHW042A MS6
8. Taiyo Yuden NRS5040T-3R3NMGJV
9. Würth 784 383 560 33
10. Toko FDSD0420-H-3R3M
11. TDK SPM6530T-3R3M

3.1.2 Based on Power (DCR):

1. Sagami DBL8087H-3R3M-R
2. Cynotec VAMV06077E-3R3MM2-79
3. Sunlord ASWPA6055S3R3MT
4. Cynotec VCMT063T MN5
5. Toko DFEG0730D-3R3M
6. Taiyo Yuden NRS5040T-3R3NMGJV
7. TDK SPM6530T-3R3M
8. Cynotec VCHW042A MS6
9. Würth 784 383 560 33
10. Toko FDSD0420-H-3R3M
11. Murata DFE322520FD-3R3M

3.1.3 Size (Smallest to Largest)

1. Murata DFE322520FD-3R3M
2. Würth 784 383 560 33
3. Cynotec VCHW042A MS6
4. Toko FDSD0420-H-3R3M
5. Cynotec VCMT063T MN5
6. Toko DFEG0730D-3R3M
7. Cynotec VAMV06077E-3R3MM2-79
8. Taiyo Yuden NRS5040T-3R3NMGJV
9. Sunlord ASWPA6055S3R3MT
10. TDK SPM6530T-3R3M
11. Sagami DBL8087H-3R3M-R

4 FFT Plots

The FFT plots for each inductor are shown as follows. These plots support the THD measurements used in this app note. Since THD is proportional to the sum of the power of the harmonics, the THD of the inductors can be compared by observing the differences in the magnitude of the harmonics shown in these plots.

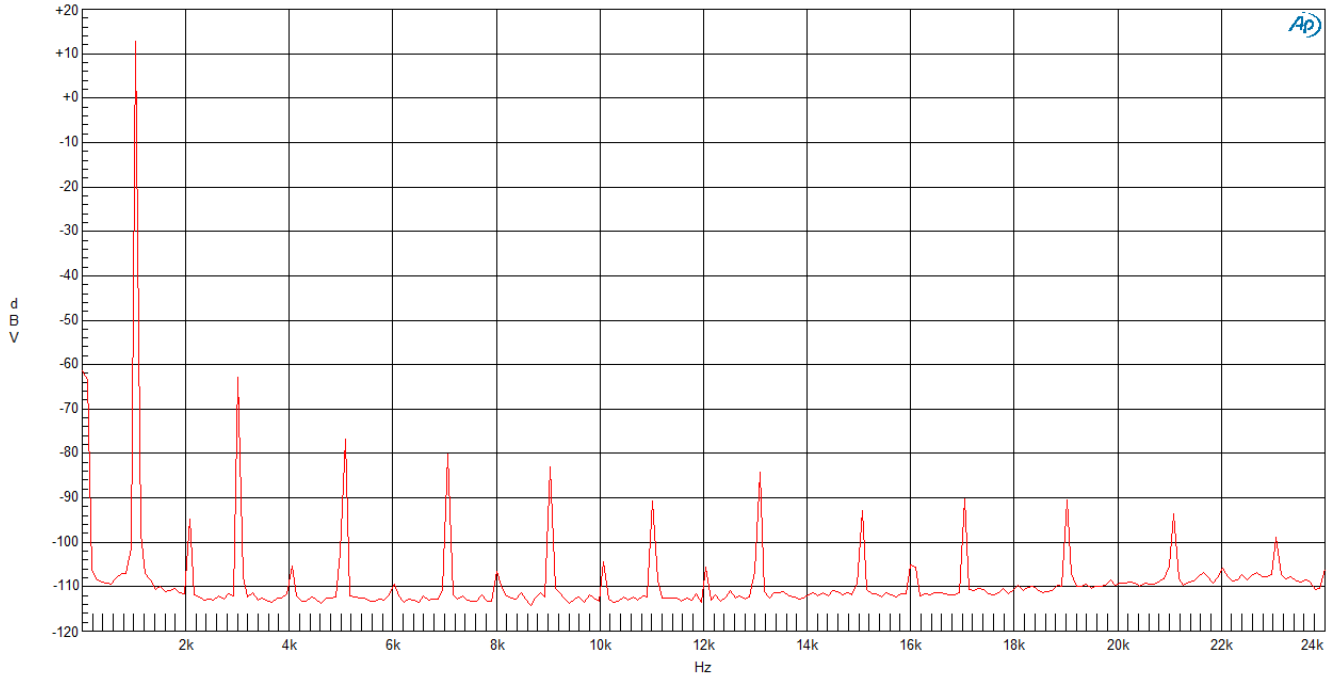

Figure 9. Cyntec VCHW042A MS6

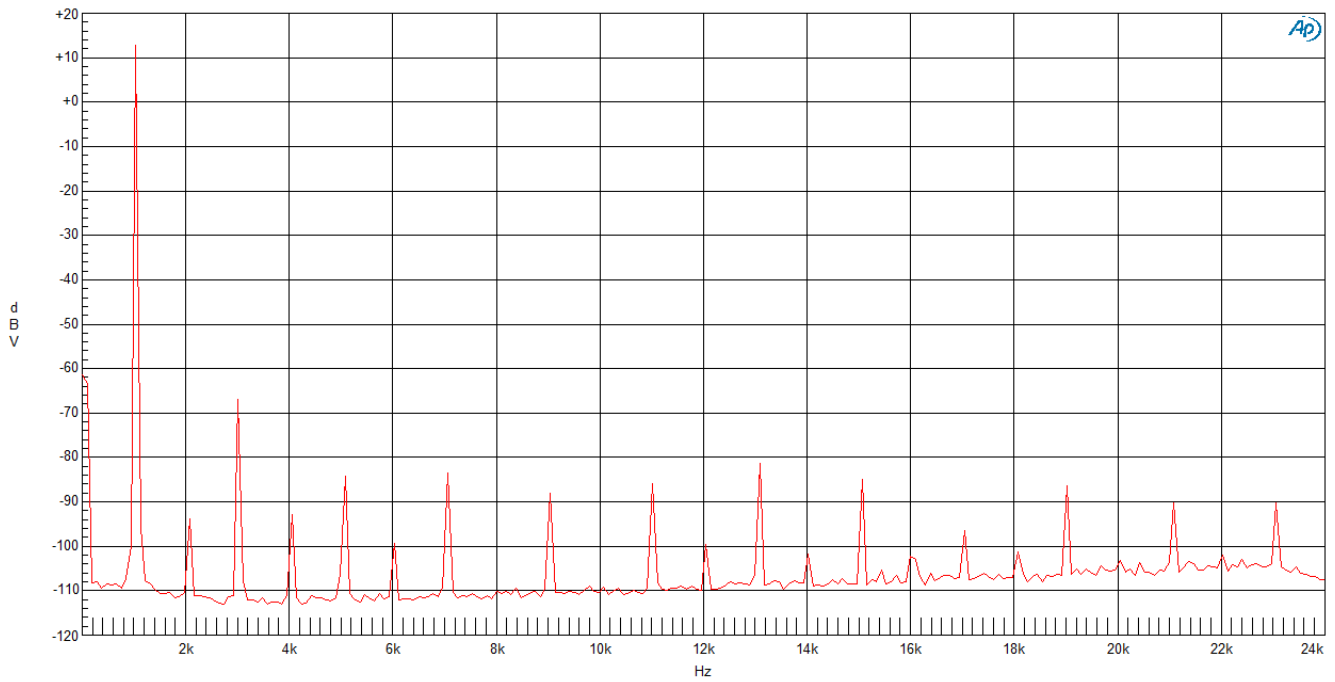

Figure 10. Cyntec VCMT063T MN5

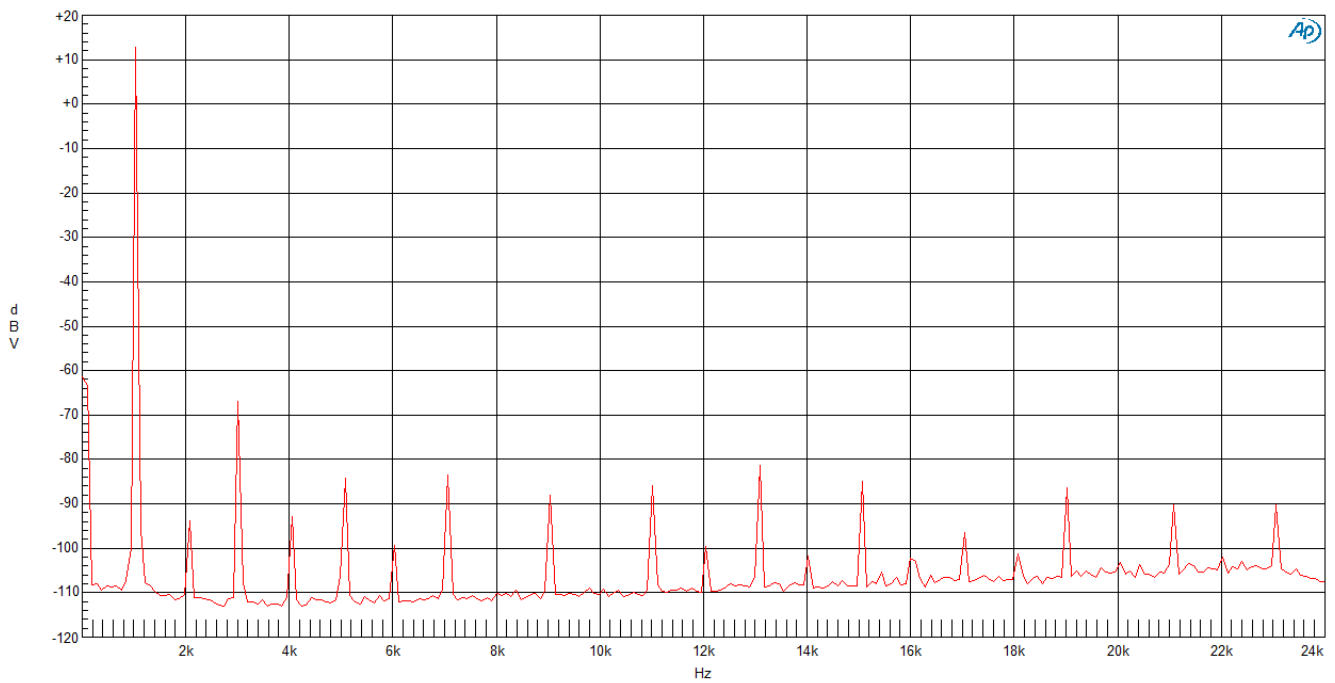

Figure 11. Cyntec VAMV6077E-3R3MM2-79

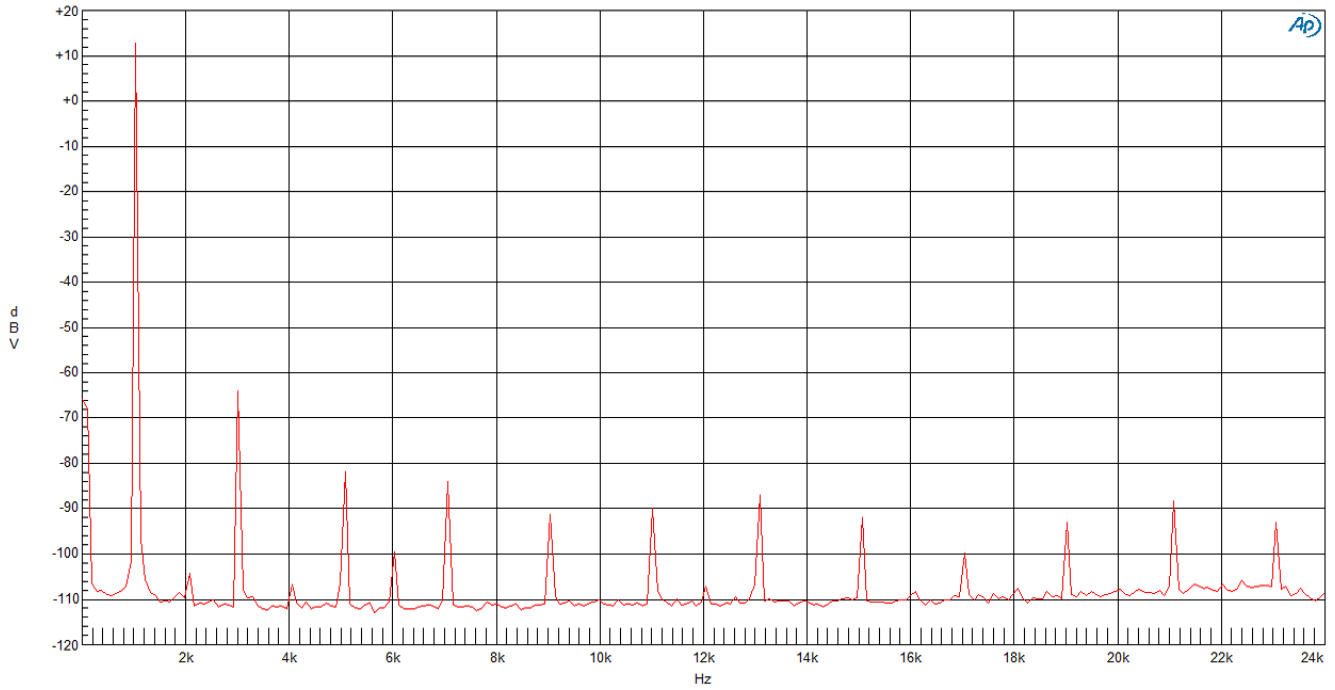

Figure 12. Murata DFE322520FD-3R3M

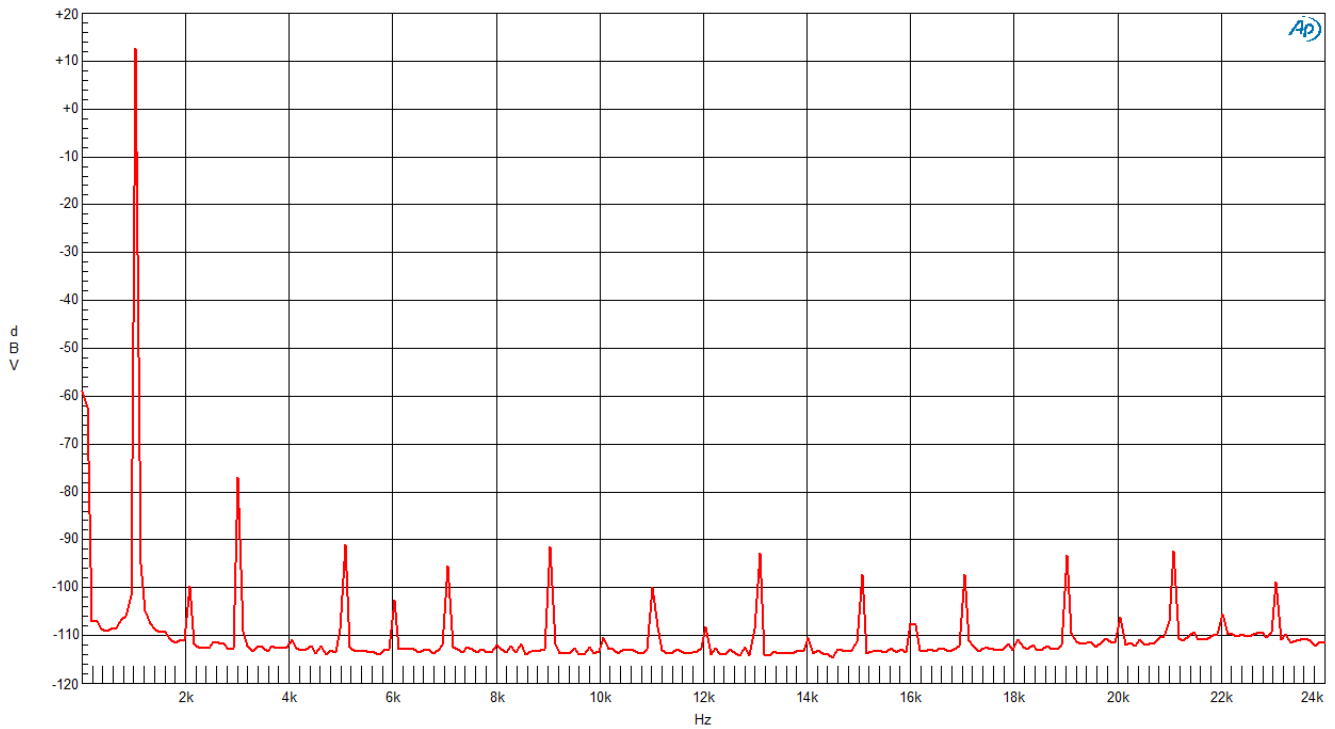

Figure 13. Sagami DBL8087H-3R3M-R1

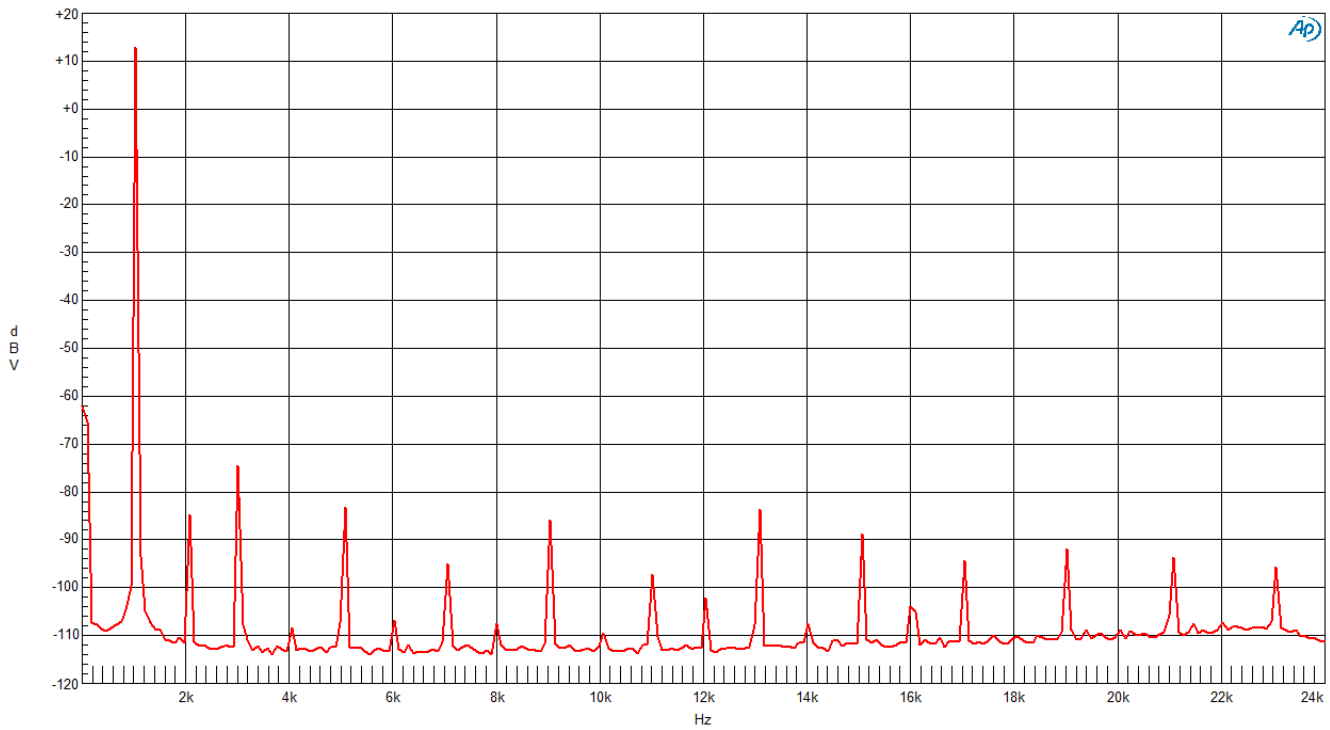

Figure 14. Sunlord ASWPA6055S3R3MT9

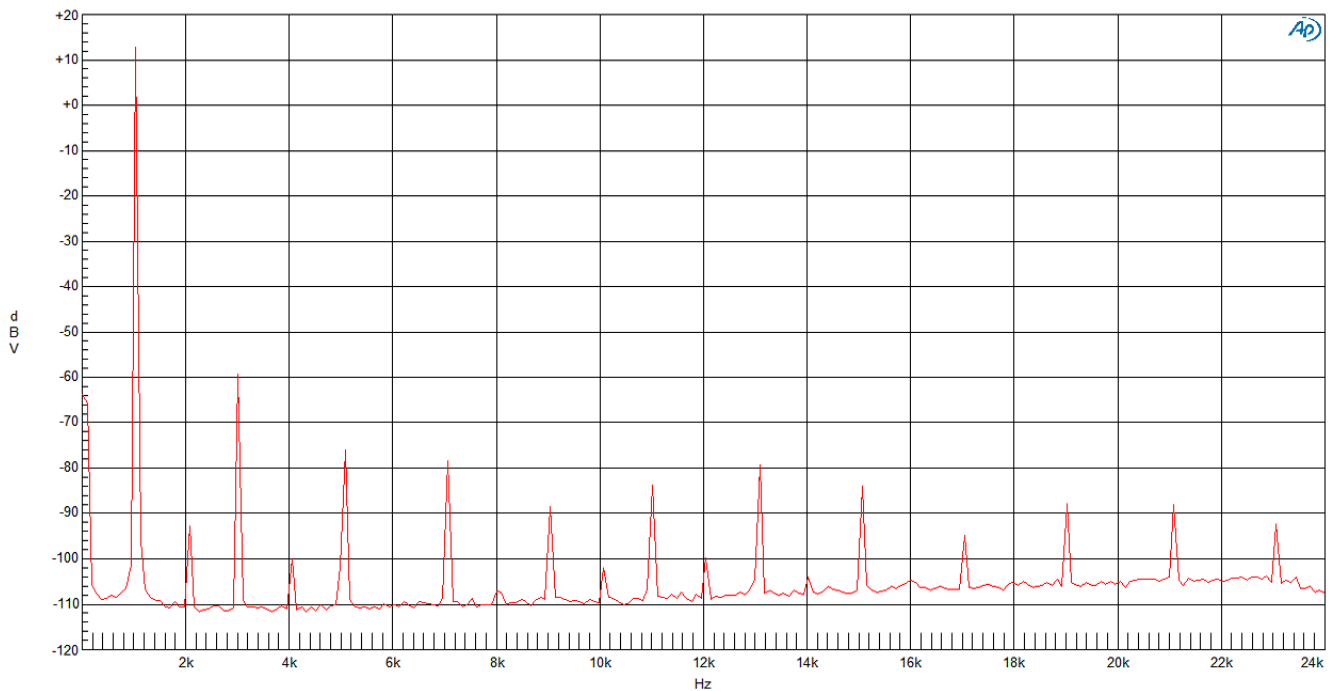

Figure 15. Taiyo Yuden NRS5040T-3R3M

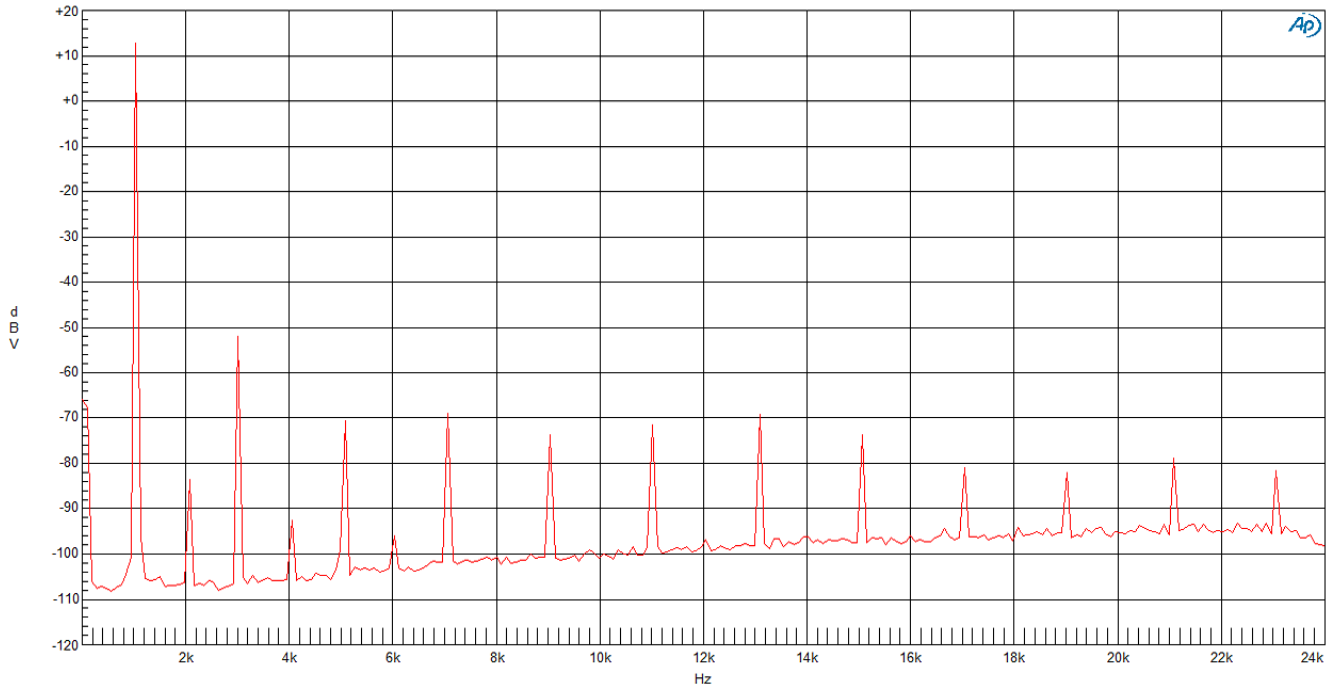

Figure 16. TDK SPM6530T-3R3M

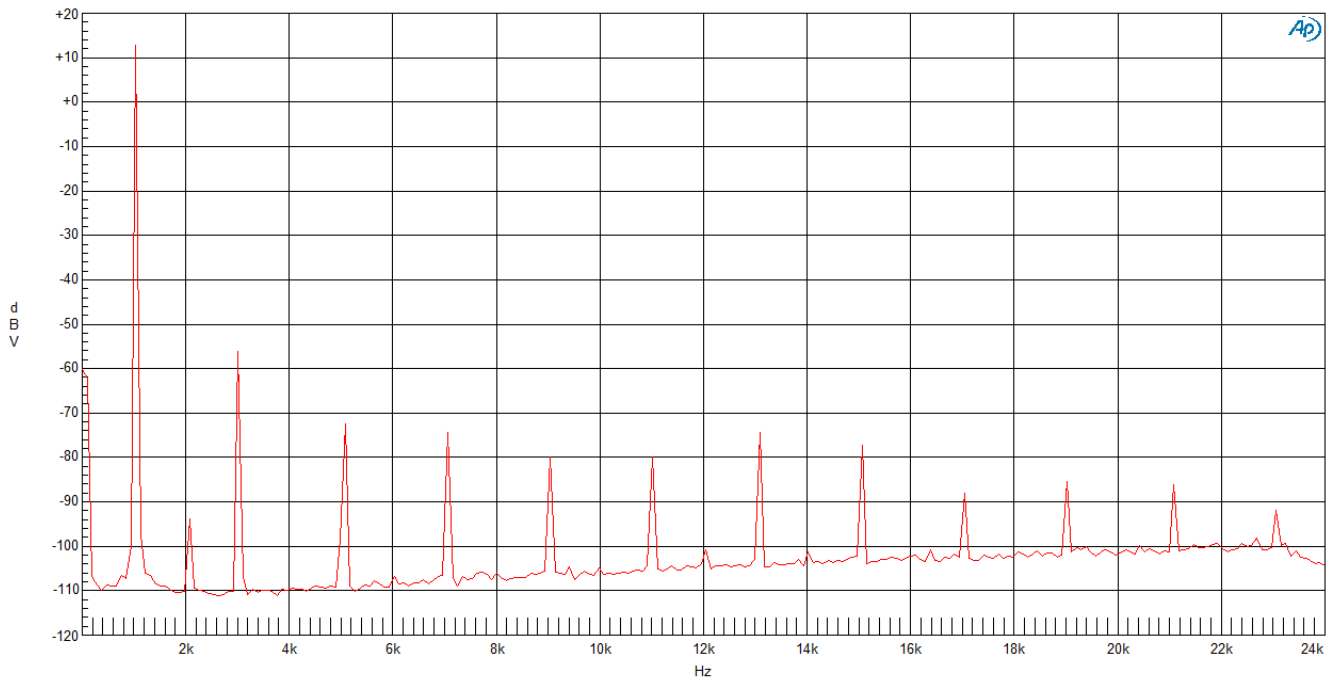

Figure 17. Toko FDS0420-H-3R3M

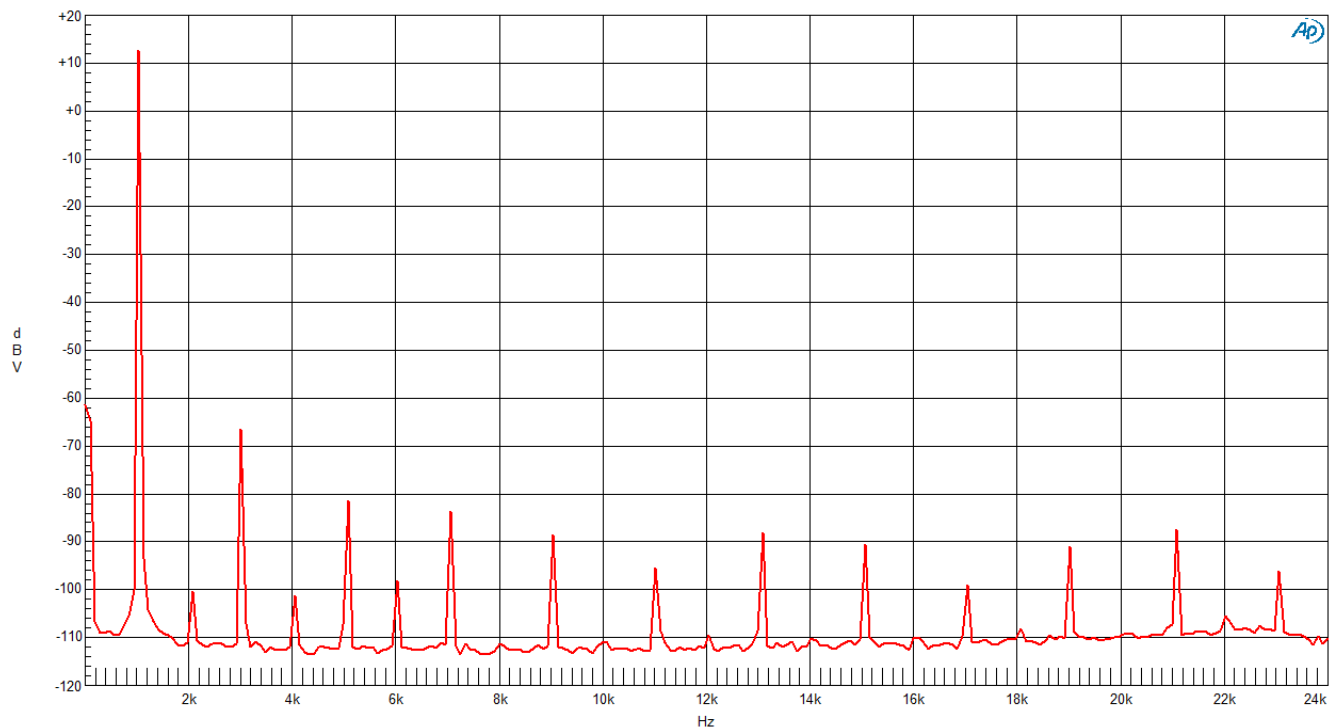

Figure 18. Toko DFEG0730D-3R3M

5 References

Cyntec: <http://www.cyntec.com/productList.aspx?id=7>

Murata: <http://www.murata.com/en-global/products/inductor>

Sagami: <http://www.sagami-elec.co.jp/en/product/list.php?srchtype=cat&cat=07&catk=03>

Sunlord: <http://www.sunlordinc.com/>

Taiyo Yuden: <http://www.t-yuden.com/ut/product/category/inductor/>

TDK: <https://product.tdk.com/info/en/products/inductor/index.html>

Toko: <http://www.toko.co.jp/products/en/index2.html>

Würth: http://www.we-online.com/web/en/all_electronic_components/Start_PB.php

Sumida: <http://products.sumida.com/ProductsInfo/?lang=en>

Coilcraft: www.coilcraft.com

6 Trademarks

All trademarks are the property of their respective owners.

IMPORTANT NOTICE FOR TI DESIGN INFORMATION AND RESOURCES

Texas Instruments Incorporated ("TI") technical, application or other design advice, services or information, including, but not limited to, reference designs and materials relating to evaluation modules, (collectively, "TI Resources") are intended to assist designers who are developing applications that incorporate TI products; by downloading, accessing or using any particular TI Resource in any way, you (individually or, if you are acting on behalf of a company, your company) agree to use it solely for this purpose and subject to the terms of this Notice.

TI's provision of TI Resources does not expand or otherwise alter TI's applicable published warranties or warranty disclaimers for TI products, and no additional obligations or liabilities arise from TI providing such TI Resources. TI reserves the right to make corrections, enhancements, improvements and other changes to its TI Resources.

You understand and agree that you remain responsible for using your independent analysis, evaluation and judgment in designing your applications and that you have full and exclusive responsibility to assure the safety of your applications and compliance of your applications (and of all TI products used in or for your applications) with all applicable regulations, laws and other applicable requirements. You represent that, with respect to your applications, you have all the necessary expertise to create and implement safeguards that (1) anticipate dangerous consequences of failures, (2) monitor failures and their consequences, and (3) lessen the likelihood of failures that might cause harm and take appropriate actions. You agree that prior to using or distributing any applications that include TI products, you will thoroughly test such applications and the functionality of such TI products as used in such applications. TI has not conducted any testing other than that specifically described in the published documentation for a particular TI Resource.

You are authorized to use, copy and modify any individual TI Resource only in connection with the development of applications that include the TI product(s) identified in such TI Resource. NO OTHER LICENSE, EXPRESS OR IMPLIED, BY ESTOPPEL OR OTHERWISE TO ANY OTHER TI INTELLECTUAL PROPERTY RIGHT, AND NO LICENSE TO ANY TECHNOLOGY OR INTELLECTUAL PROPERTY RIGHT OF TI OR ANY THIRD PARTY IS GRANTED HEREIN, including but not limited to any patent right, copyright, mask work right, or other intellectual property right relating to any combination, machine, or process in which TI products or services are used. Information regarding or referencing third-party products or services does not constitute a license to use such products or services, or a warranty or endorsement thereof. Use of TI Resources may require a license from a third party under the patents or other intellectual property of the third party, or a license from TI under the patents or other intellectual property of TI.

TI RESOURCES ARE PROVIDED "AS IS" AND WITH ALL FAULTS. TI DISCLAIMS ALL OTHER WARRANTIES OR REPRESENTATIONS, EXPRESS OR IMPLIED, REGARDING TI RESOURCES OR USE THEREOF, INCLUDING BUT NOT LIMITED TO ACCURACY OR COMPLETENESS, TITLE, ANY EPIDEMIC FAILURE WARRANTY AND ANY IMPLIED WARRANTIES OF MERCHANTABILITY, FITNESS FOR A PARTICULAR PURPOSE, AND NON-INFRINGEMENT OF ANY THIRD PARTY INTELLECTUAL PROPERTY RIGHTS.

TI SHALL NOT BE LIABLE FOR AND SHALL NOT DEFEND OR INDEMNIFY YOU AGAINST ANY CLAIM, INCLUDING BUT NOT LIMITED TO ANY INFRINGEMENT CLAIM THAT RELATES TO OR IS BASED ON ANY COMBINATION OF PRODUCTS EVEN IF DESCRIBED IN TI RESOURCES OR OTHERWISE. IN NO EVENT SHALL TI BE LIABLE FOR ANY ACTUAL, DIRECT, SPECIAL, COLLATERAL, INDIRECT, PUNITIVE, INCIDENTAL, CONSEQUENTIAL OR EXEMPLARY DAMAGES IN CONNECTION WITH OR ARISING OUT OF TI RESOURCES OR USE THEREOF, AND REGARDLESS OF WHETHER TI HAS BEEN ADVISED OF THE POSSIBILITY OF SUCH DAMAGES.

You agree to fully indemnify TI and its representatives against any damages, costs, losses, and/or liabilities arising out of your non-compliance with the terms and provisions of this Notice.

This Notice applies to TI Resources. Additional terms apply to the use and purchase of certain types of materials, TI products and services. These include; without limitation, TI's standard terms for semiconductor products (<http://www.ti.com/sc/docs/stdterms.htm>), [evaluation modules](#), and [samples](http://www.ti.com/sc/docs/sampterm.htm) (<http://www.ti.com/sc/docs/sampterm.htm>).

Mailing Address: Texas Instruments, Post Office Box 655303, Dallas, Texas 75265
Copyright © 2017, Texas Instruments Incorporated