

# **Interfacing a CMOS Sensor to the TMS320DM642 Using Raw Capture Mode**

*Miguel Hernandez IV*
*Device Applications*

## **ABSTRACT**

This document contains information on how to interface the TMS320DM642 to a CMOS Digital Image Sensor in raw capture mode. A complete example is shown, including hardware and software interfaces. The software consists of a set of routines that are compatible with the Video Port Mini-Driver and External Device Control interface. The discussed interface is proven and has been tested from 320x240 at 120 frames per second to 1920x1080 at 19 frames per second. This document is accompanied by example software designed to operate with the TMS320DM642 EVM and is available electronically from the TI website.

## **Contents**

|          |   |           |
|----------|---|-----------|
| <b>1</b> | <b>Introduction</b> .....                               | <b>2</b>  |
| <b>2</b> | <b>CMOS Digital Image Sensor Overview</b> .....         | <b>3</b>  |
|          | 2.1 CMOS Sensor Signal Descriptions .....               | 3         |
|          | 2.2 CMOS Sensor Register Descriptions .....             | 4         |
|          | 2.2.1 Row and Column Size .....                         | 5         |
|          | 2.2.2 Horizontal and Vertical Blanking .....            | 5         |
|          | 2.2.3 Shutter Width .....                               | 5         |
|          | 2.2.4 Pixel Clock Control .....                         | 5         |
|          | 2.2.5 Read Mode 1 .....                                 | 5         |
|          | 2.2.6 Read Mode 2 .....                                 | 5         |
|          | 2.3 Reading and Writing the CMOS Sensor Registers ..... | 6         |
|          | 2.3.1 Sensor Output Data Format .....                   | 7         |
| <b>3</b> | <b>DM642 Video Port Overview</b> .....                  | <b>7</b>  |
|          | 3.1 Video Capture Port Signal Descriptions .....        | 8         |
|          | 3.2 Raw Capture Mode .....                              | 8         |
|          | 3.3 Frame Synchronization .....                         | 9         |
| <b>4</b> | <b>Sensor Interface to the to DM642</b> .....           | <b>10</b> |
|          | 4.1 Hardware Interface .....                            | 10        |
|          | 4.2 Software Interface .....                            | 12        |
|          | 4.2.1 Raw Capture Mode Initialization .....             | 12        |
|          | 4.2.2 Raw Display Mode Initialization .....             | 15        |
|          | 4.2.3 Sensor EDC .....                                  | 17        |
|          | 4.3 Capture and Display Performance .....               | 18        |
| <b>5</b> | <b>Conclusion</b> .....                                 | <b>18</b> |
| <b>6</b> | <b>References</b> .....                                 | <b>19</b> |

Trademarks are the property of their respective owners.

**Appendix A Sensor Daughter Card Schematics for the DM642 EVM ..... 20**
**List of Figures**

|  |    |
|--|----|
| Figure 1. Non-Continuous and Continuous LINE_VALID Formats .....               | 6  |
| Figure 2. I2C Write to Column Size Register (0x04) with the Value 0x027F ..... | 6  |
| Figure 3. I2C Read from Column Size Register (0x04). 0x027F Returned .....     | 7  |
| Figure 4. Bayer Color Pattern .....  | 7  |
| Figure 5. VCxSTRT1 Register .....  | 9  |
| Figure 6. Initializing VCVBLNKP .....  | 10 |
| Figure 7. Sensor Interface to the DM642 .....                                  | 11 |
| Figure 8. Proper LINE_VALID Operation .....                                    | 12 |
| Figure 9. Capture Configuration Structure .....                                | 13 |
| Figure 10. Raw Capture Mode Configuration .....                                | 14 |
| Figure 11. SAA7105 Configuration for SVGA Display .....                        | 16 |
| Figure 12. RGB565 Data Format .....  | 16 |
| Figure 13. Bayer Pattern (4x4) .....   | 17 |
| Figure 14. FVID Object Initialization .....                                    | 17 |

**List of Tables**

|         |   |    |
|---------|---|----|
| Table 1 | Sensor Signal Descriptions .....                                | 4  |
| Table 2 | I2C Sensor Addresses .....                                      | 6  |
| Table 3 | Video Capture Port Signal Descriptions (Raw Capture Mode) ..... | 8  |
| Table 4 | VCxSTOP1 Register Initialization .....                          | 9  |
| Table 5 | VCxSTRT1 Bit Field Descriptions .....                           | 9  |
| Table 6 | Capture and Display Performance .....                           | 18 |

## 1 Introduction

Digital signal processors (DSPs) have become increasingly important in a wide range of video and imaging applications, such as machine vision, medical imaging, security monitoring, digital cameras and printers, and a large number of consumer applications driven by digital video processing including DVDs, digital TV, and video telephony. These applications are characterized by requirements for processing flexibility, sophisticated algorithms, and high data rates. The DM642 is a DSP designed to handle the computational requirements of the above applications.

The Texas Instruments DM642 has three 20-bit video ports that can be configured for different video standards, such as BT.656 or, as in the application this document describes, can be used in raw data capture mode. The video ports are capable of driving encoders for display purposes, or they can capture data from various decoders and video sources. In the application described by this document, the video source will be an MT9T001 CMOS Digital Image Sensor by Micron™ Technology, Inc. This application is applicable to other sensors and video A/D converters having similar interfaces.

The following sections give an overview of the MT9T001 and DM642 video port configured for raw capture mode operation. These sections describe the physical and logical interfaces, and provide a sample application proving the discussed system.

## 2 CMOS Digital Image Sensor Overview

The CMOS Digital Image Sensor used in this document is the MT9T001 by Micron™ Technology, Inc. and will be hereafter referred to as the Sensor. The Sensor is a QXGA-format digital image device with an active imaging pixel array of 2048x1536. The Sensor provides a color resolution of 10 bits per pixel, is able to capture both continuous video and single frames progressively, and is programmable through an I<sup>2</sup>C serial interface. The following sections provide an overview of the Sensor and describe the physical and logical interfaces in the context of a Sensor to DM642 interface in raw capture mode.

### 2.1 CMOS Sensor Signal Descriptions

The following table lists and describes the Sensor input/output (I/O) signals as they pertain to the Sensor to DM642 interface in raw capture mode. Signals generated by the DM642 are inputs; signals generated by the Sensor are outputs; and bidirectional signals are I/O. Note that some Sensor signals are not used and not discussed. For a full signal description, refer to Micron's Data Sheet 2.

**Table 1. Sensor Signal Descriptions**

| <b>Signal</b> |                           |            |   |
|---------------|---------------------------|------------|---|
| <b>Symbol</b> | <b>Name</b>               | <b>I/O</b> | <b>Description</b>  |
| VAAPIX        | Analog pixel power        | –          | Power supply for pixel array, 3.3V  |
| VDD           | Digital power supply      | –          | Power supply for digital block, 3.3V  |
| DGND          | Digital ground            | –          | Isolated ground for digital block.  |
| VAA           | Analog power supply       | –          | Power supply for analog block, 3.3V   |
| AGND          | Analog ground             | –          | Isolated ground for analog block and pixel array.   |
| DOUT[9:0]     | Data out                  | O          | Pixel data output   |
| PIXCLK        | Pixel clock               | O          | Pixel data outputs are valid during the falling/rising edge of this clock. See the Pixel Clock Control register for options. The frequency is equal to that of Master Clock In. |
| LINE_VALID    | Output line valid         | O          | This output is high whenever a line of valid pixel data is available on the data bus (see Read Mode 2 register for options).  |
| FRAME_VALID   | Output frame valid        | O          | Not used and left unconnected.  |
| SDATA         | I <sup>2</sup> C data bus | I/O        | I <sup>2</sup> C data bus   |
| SCLK          | I <sup>2</sup> C clock    | I          | I <sup>2</sup> C clock  |
| /RESET†       | Reset                     | I          | All registers assume factory defaults   |
| /OE           | Output enable             | I          | Enables outputs when active. Tied to ground.  |
| CLK_IN        | Master clock in           | I          | Master clock into Sensor (48 MHz maximum).  |
| GSHT_CTL      | Global shutter control    | I          | Not used and left unconnected.  |
| STROBE        | Output strobe             | O          | Not used and left unconnected.  |
| STANDBY       | Standby                   | I          | Not used and tied to ground.  |
| TRIGGER       | Trigger                   | I          | Not used and left unconnected.  |
| NC            | No connect                | –          | These pins must be left unconnected.  |

† '/' prefix denotes low active signal

## 2.2 CMOS Sensor Register Descriptions

The Sensor is programmed through registers via the I<sup>2</sup>C serial interface. Each register address consists of 8 bits, while register data consists of 16 bits. This section only describes those registers necessary for operation in the context of the Sensor to DM642 interface in raw capture mode. All registers not discussed are operated according to default values, i.e. those values assigned to the registers at reset. For a full register description, see Micron's Data Sheet <sup>2</sup>.

### **2.2.1 Row and Column Size**

These registers control the horizontal and vertical resolution of data to be captured by the Sensor. The Sensor is capable of capturing a maximum resolution of 2048x1536, a minimum resolution of 2x2, and all resolutions in between. The values to be programmed in these registers are the desired resolution minus one (desired – 1), and must be an odd number. For example, if a resolution of 640x480 is desired, 639 and 479 must be programmed in the Column and Row Size registers respectively.

### **2.2.2 Horizontal and Vertical Blanking**

These registers control the blanking time in a row and between frames. Horizontal blanking is defined in terms of pixel clocks (PIXCLK) and vertical blanking is defined in terms of row readout times.

### **2.2.3 Shutter Width**

This register specifies the number of rows of integration and exposure time. The integration time of the pixel is the amount of time the pixels are set to collect charge generated from light. See Micron's Data Sheet 2 for formulas that govern the exposure time.

### **2.2.4 Pixel Clock Control**

This register specifies the operation of the PIXCLK clock output, and consists of three fields: Invert Pixel Clock, Shift Pixel Clock, and Divide Pixel Clock. The field of interest for the Sensor to DM642 interface is the Invert Pixel Clock field. The LINE\_VALID, FRAME\_VALID, and DOUT[9:0] lines are synchronized with the PIXCLK output. This field determines whether the above lines are synchronized to the rising or falling edge of PIXCLK. For the Sensor to DM642 interface discussed in this document, the above lines must be set to the rising edge of PIXCLK. All other fields operate according to their default values.

### **2.2.5 Read Mode 1**

This register specifies the capture operation of the Sensor, and consists of four fields: Snapshot Mode, Strobe Enable, Strobe Width, and Strobe Override. The field of interest for the Sensor to DM642 interface is the Snapshot Mode field. This field determines whether the Sensor captures data continuously (video), or on a frame basis (pictures). For the Sensor to DM642 interface discussed in this document, the Sensor is set to operate continuously. All other fields operate according to their default values.

### **2.2.6 Read Mode 2**

This register specifies the operation of the LINE\_VALID signal with respect to the FRAME\_VALID signal, and consists of three fields: No Bad Frames, Continuous LINE\_VALID, and XOR LINE\_VALID. The field of interest for the Sensor to DM642 interface is the Continuous LINE\_VALID field. This field determines whether the LINE\_VALID signal is output during a vertical blanking period or not. The figure below illustrates the LINE\_VALID operation when reading out four rows of valid data and three vertical blanking rows. The period during which the FRAME\_VALID signal is low denotes a vertical blanking period. The LINE\_VALID\_0 and LINE\_VALID\_1 signals below represent the cases when the bit field in question is cleared and set respectively. For frame synchronization purposes (which will be discussed later in this document), the LINE\_VALID\_0 signal is desired. All other bit fields in this register operate according to their default values.

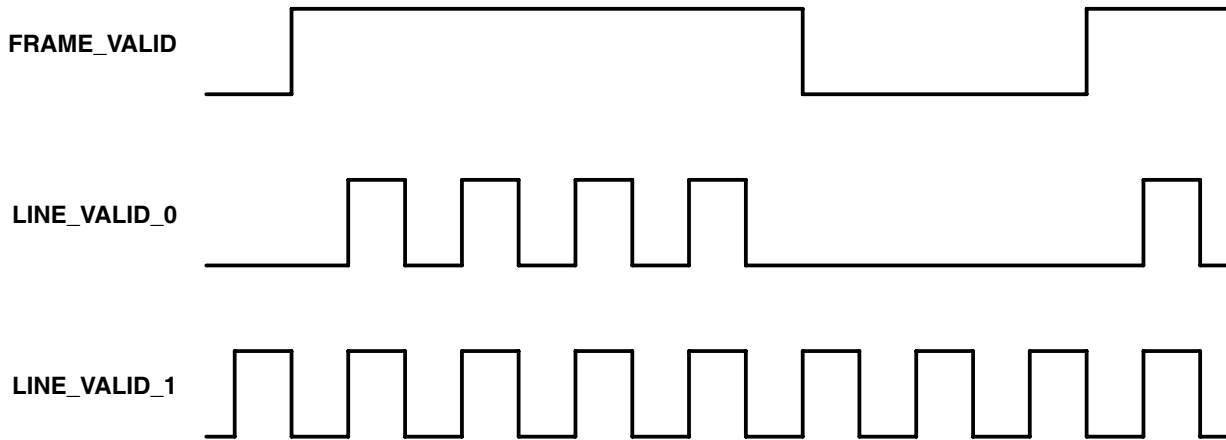

Figure 1. Non-Continuous and Continuous LINE\_VALID Formats

### 2.3 Reading and Writing the CMOS Sensor Registers

All Sensor registers are written and read through the I<sup>2</sup>C serial interface. The I<sup>2</sup>C address of the Sensor is fixed and consists of seven bits of address and 1-bit of read/write direction. The table below shows the read and write addresses of the Sensor.

Table 2. I<sup>2</sup>C Sensor Addresses

| 7 Address Bits (binary) | Direction | Mode  | Final Address (hex) |
|-------------------------|-----------|-------|---------------------|
| 1011 101                | 1         | Read  | 0xBB                |
| 1011 101                | 0         | Write | 0xBA                |

The Sensor data registers are 16 bits wide, so two 8-bit transfers are required when reading or writing a register. A typical write sequence for writing 16 bits to a register is shown in the figure below. The sequence begins with a Start bit followed by the Sensor write address. After the Sensor acknowledges the write address (A), a specific register address is issued, which is the Column Size register in this example. At this point, the Sensor expects to receive two 8-bit data transfers (0x02 and 0x7F) to complete the write process.

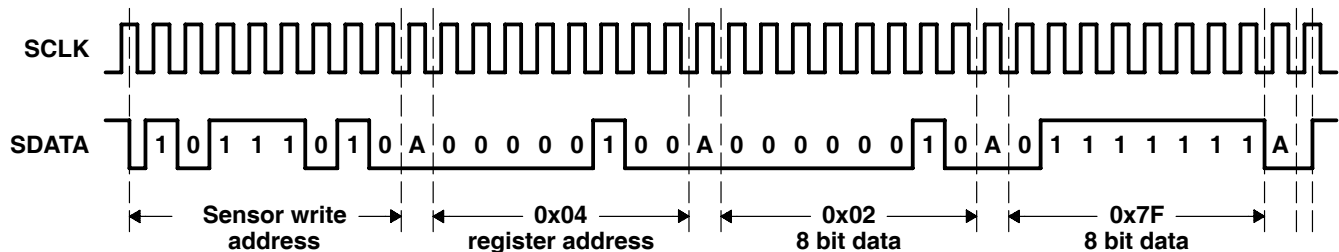

Figure 2. I<sup>2</sup>C Write to Column Size Register (0x04) with the Value 0x027F

The figure below shows a typical read sequence for reading 16 bits from a register. The sequence begins with a Start bit followed by the Sensor write address. After the Sensor acknowledges the write address, a specific register address is issued (Column Size register). A Start bit is generated again and the Sensor read address is issued. At this point, the Sensor will transmit two 8-bit data packets, and the read process ends with a No Acknowledge (N) followed by a Stop bit.

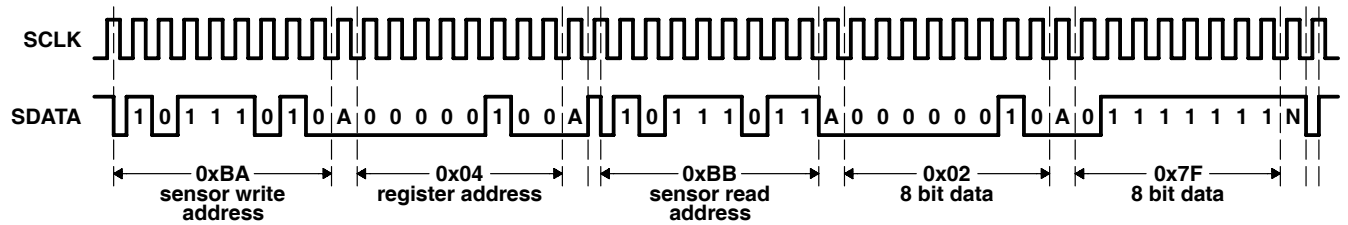

Figure 3. I<sup>2</sup>C Read from Column Size Register (0x04). 0x027F Returned

### 2.3.1 Sensor Output Data Format

The Sensor captures and outputs information in a Bayer color pattern as shown in the following figure which represents a 6x6 captured image. The odd rows are comprised of alternating green and red pixels, and the even rows are comprised of alternating blue and green pixels. Alternatively, the color pattern can be viewed as the even columns made up of alternating green and blue pixels, and the odd columns made up of alternating red and green pixels. Note that the captured image has twice as many green pixels as it does red and blue. Depending on the application, the Bayer color pattern may have to be converted to another format. As will be shown later in this document, the Bayer color pattern must be converted to RGB565 for display on a monitor.

|   |   |   |   |   |   |
|---|---|---|---|---|---|
| G | R | G | R | G | R |
| B | G | B | G | B | G |
| G | R | G | R | G | R |
| B | G | B | G | B | G |
| G | R | G | R | G | R |
| B | G | B | G | B | G |

Figure 4. Bayer Color Pattern

## 3 DM642 Video Port Overview

The Texas Instruments DM642 has three 20-bit video ports that can be configured for different video standards, such as BT.656, or, as in the application this document describes, can be used in raw data capture mode. The video ports are capable of driving encoders for display purposes, or they can capture data from various decoders and video sources. The application described in this document uses a Sensor as the video source. The following sections provide an overview of the video capture port configured for raw capture mode operation and describe the physical and logical interfaces in the context of a Sensor to DM642 interface. For a full description of the DM642 video port and raw capture mode operation, refer to the *TMS320C64x DSP Video Port/VCXO Interpolated Control (VIC) Port Reference Guide* (SPRU629) and the *TMS320DM642 Video/Imaging Fixed-Point Digital Signal Processor Data Manual* (SPRS200).

### 3.1 Video Capture Port Signal Descriptions

The following table lists and describes the video capture port input/output (I/O) signals as they pertain to the Sensor to DM642 interface in raw capture mode. Signals generated by the DM642 are outputs, signals generated by the Sensor are inputs, and bi-directional signals are I/O. Note that some video port signals are not used and not discussed. For a full signal description, refer to the *TMS320C64x DSP Video Port/VCXO Interpolated Control (VIC) Port Reference Guide* (SPRU629) and the *TMS320DM642 Video/Imaging Fixed-Point Digital Signal Processor Data Manual* (SPRS200).

**Table 3. Video Capture Port Signal Descriptions (Raw Capture Mode)**

| Video Port Signal | Usage in Raw |     | Description  |
|-------------------|--------------|-----|--|
|                   | Capture Mode | I/O |  |
| VPxCLK0†          | VCLKINA      | I   | Video port clock line.   |
| VPxCLK1           | VCLKINB      | I   | Not Used.  |
| VPxCTL0           | CAPENA       | I   | Data capture enable. Data is sampled by the video port when this line is active. |
| VPxCTL1           | CAPENB       | I   | Not Used.  |
| VPxCTL2           | FID          | I   | Not Used.  |
| VPxD[9:0]         | –            | I   | Pixel data input lines.  |
| VPxD[19:10]       | –            | I   | Not Used.  |
| SCL‡              | –            | O   | I <sup>2</sup> C clock.  |
| SDA‡              | –            | I/O | I <sup>2</sup> C data line.  |

† 'x' is a general place holder that can represent video port 0, 1, or 2.

‡ Not part of the video port, but used in the Sensor to DM642 interface.

### 3.2 Raw Capture Mode

In order to capture video from the Sensor, the DM642 video port must be configured to operate in raw capture mode. When operating in raw capture mode, no data selection or data interpretation is performed by the DM642. This mode of operation is useful for video data capture from a variety of A/D converters, such as the Sensor described in this document.

While operating in raw capture mode, the DM642 video port supports 8, 10, 16, and 20-bit data word sizes. The 16 and 20-bit raw capture modes are designed to accept data from high resolution A/D converters, such as those used in medical imaging. The Sensor to DM642 interface described in this document can function in both 8 and 10-bit resolutions.

In raw capture mode, the VPxD data lines are sampled by the interface when the CAPEN signal is active. Data is captured at the rate of the clock of the data source. The captured data set size is set by the VCXSTOP and VCYSTOP bit fields in the Video Capture Channel x Field 1 Stop Register (VCxSTOP1). When combined, the VCXSTOP and VCYSTOP fields allow the DM642 to capture up to 2<sup>24</sup> data samples (VCXSTOP sets the lower 12 bits and VCYSTOP sets the upper 12 bits). Capture is complete when the captured data size reaches the combined VCXSTOP and VCYSTOP value. Note that the CAPEN signal must remain inactive for a minimum of two cycles after the VCXSTOP and VCYSTOP counters have expired for proper operation. The table below demonstrates how to initialize the VCxSTOP1 register based on a frame size of 640x480.

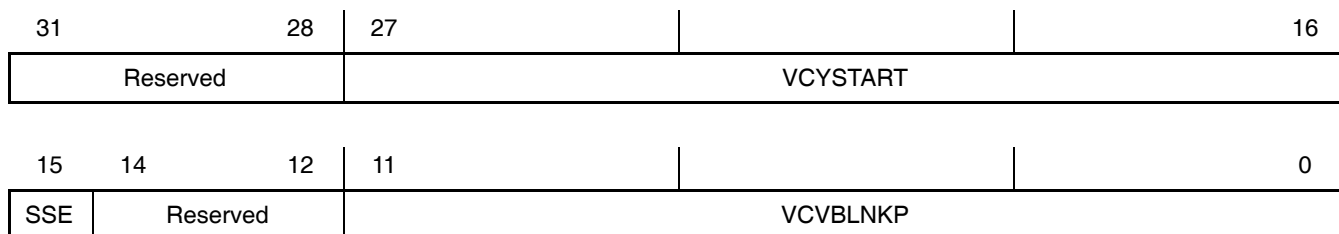

**Table 4. VCxSTOP1 Register Initialization**

| Frame Size | Pixels<br>(decimal) | Pixels (hex) | VCYSTOP<br>(hex) | VCXSTOP<br>(hex) |
|------------|---------------------|--------------|------------------|------------------|
| 640 x 480  | 307200              | 04B000       | 04B              | 000              |

### 3.3 Frame Synchronization

Because raw capture mode operation captures data without interpretation and has no external signals dedicated for horizontal and vertical synchronization, frame synchronization is not possible. However, the video port offers a solution which ensures initial capture synchronization to the beginning of a frame while operating in raw capture mode. This solution lies in the Video Capture Channel x Field 1 Start Register (VCxSTRT1) and consists of the Video Capture Vertical Blanking Period (VCVBLNKP) and Startup Synchronization Enable (SSE) fields. The table below describes the VCxSTRT1 register.

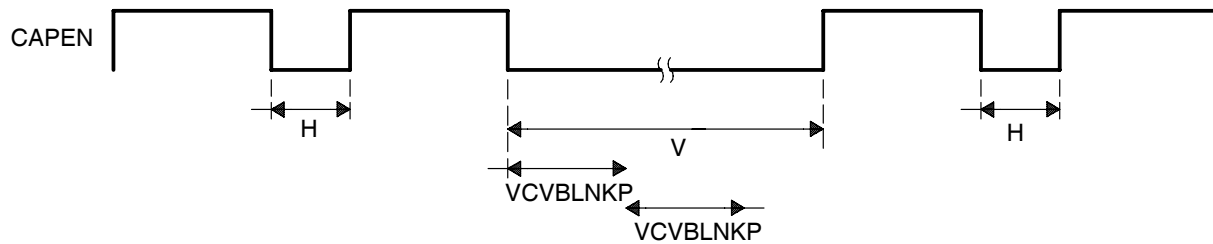

**Figure 5. VCxSTRT1 Register**

**Table 5. VCxSTRT1 Bit Field Descriptions**

| Bit Field | Description   |
|-----------|---|
| Reserved  | Reserved. This location is always read as 0. Values written to this field have no effect.                 |
| VCYSTART  | Not Used in raw capture mode.   |
| SSE       | (1) startup sync is enabled.<br>(0) startup sync is disabled  |
| Reserved  | Reserved. This location is always read as 0. Values written to this field have no effect.                 |
| VCVBLNKP  | This field defines the minimum CAPEN inactive (LOW) time to be interpreted as a vertical blanking period. |

When the SSE bit is set and the video capture port is enabled (VCEN set to 1 in the VCxCTL register), the video port will not start capturing data until after two vertical blanking periods are detected. The length of a single vertical blanking period is defined by the VCVBLNKP field, which is in turn defined with respect to the CAPEN signal, i.e., the VCVBLNKP field defines the minimum CAPEN inactive time to be interpreted as a vertical blanking period. In order to ensure initial capture synchronization to the beginning of a frame, VCVBLNKP must be assigned a value larger than the expected horizontal blanking interval and less than half the expected vertical blanking interval. The figure below highlights this situation.



H = Horizontal blanking interval

V = Vertical blanking interval

**Figure 6. Initializing VCVBLNKP**

**WARNING:**

Frame synchronization is only performed ONCE every time the video capture port is enabled ( $VCEN = 1$ ). A noisy CAPEN signal may cause a loss of frame synchronization. To re-synchronize, the video port must be disabled, then re-enabled.

The method required to setup and operate the video port in raw capture mode will be discussed later in this document.

## 4 Sensor Interface to the to DM642

There are many ways to interface the Sensor to the DM642 EVM in raw capture mode. This section describes one such implementation of this interface. A complete example is shown, including both hardware and software. The software is designed to operate with the Video Port Mini-Driver for the DM642 EVM and is fully compliant with the External Device Control interface (EDC). For more information on the Video Port Mini-Driver and EDC, refer to the application report *The TMS320DM642 Video Port Mini-Driver* (SPRA918).

### 4.1 Hardware Interface

The Sensor can be easily interfaced to the DM642 through the video port. A high level view of this interface is shown in the figure below. This interface is designed for video port channel A operation only. Note that some signals are not used and left unconnected.

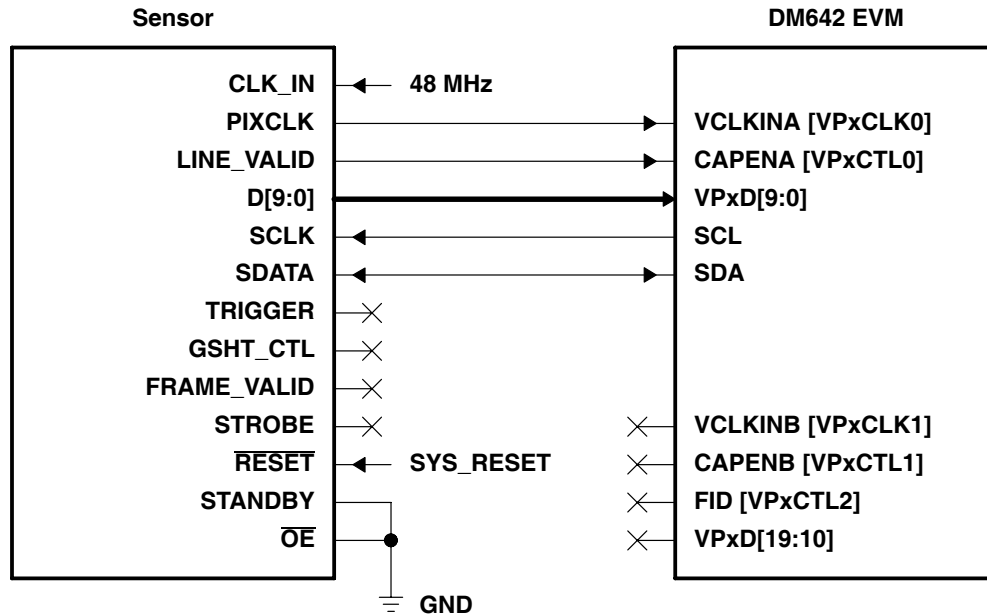

NOTE: /SYS\_RESET is connected to the RESET switch on the DM642 EVM.

**Figure 7. Sensor Interface to the DM642**

The FRAME\_VALID signal on the Sensor is left unconnected because no input exists on the DM642 which can take advantage of this signal. However, the FRAME\_VALID line is not needed since the information necessary for proper operation with the DM642 is carried on the LINE\_VALID signal. Recall that the LINE\_VALID and FRAME\_VALID signals indicate that a line and frame of valid pixel data is available on the data bus. Because the DM642 samples data when CAPEN is active, proper video port and Sensor operation requires that the LINE\_VALID signal be connected to the CAPEN signal.

The software interface must ensure that the LINE\_VALID signal operates according to the non-continuous format. Recall that the Read Mode 2 Sensor register can be configured for different LINE\_VALID formats based on the desired vertical blanking operation. For proper operation, the Read Mode 2 register must be programmed to ensure that the LINE\_VALID signal is inactive during vertical blanking intervals. The figure below illustrates this operation.

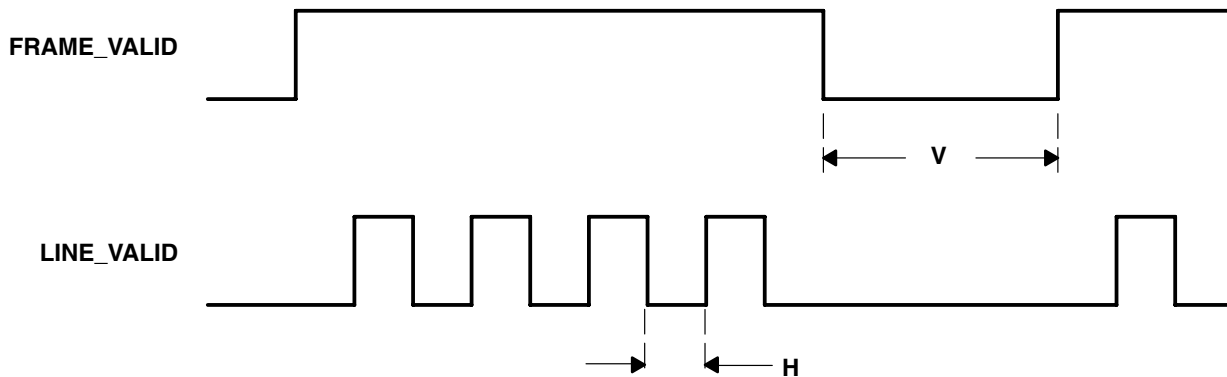

H = Horizontal blanking

V = Vertical blanking

**Figure 8. Proper LINE\_VALID Operation**

In the Sensor to DM642 interface described above, the TRIGGER, STROBE, and GSHT\_CTL signals are not used and left unconnected. In an advanced design, these signals can be used to enable Snapshot Mode operation. In this mode, the TRIGGER signal can be connected to a GPIO on the DM642 and used to initiate the start of a single frame capture, STROBE can be used to turn on a flash, and GSHT\_CTL can be combined with a mechanical shutter to achieve simultaneous exposure of all rows in the image. For more information on Snapshot Mode, refer to Micron's Data Sheet 2.

## 4.2 Software Interface

The software interface performs the functions required to capture and display information from the Sensor, is designed to operate with the Video Port Mini-Driver for the DM642 EVM and is fully compliant with the EDC interface. The Mini-Driver consists of a generic portion which configures both the video port and EDMA for data capture and display, and a board-specific part (EDC) which configures both the Sensor and SAA7105 video encoder for data capture and display respectively. The following section describes the software used for data capture and display from the Sensor. For more information on the Video Port Mini-Driver and EDC, refer to the application report *The TMS320DM642 Video Port Mini-Driver* (SPRA918).

### 4.2.1 Raw Capture Mode Initialization

In order to initialize the video port in raw capture mode, the generic portion of the Mini-Driver had to be modified. As of the writing of this document, the Video Port Mini-Driver does not support raw capture mode. The modified Video Port Mini-Driver with raw capture mode support is included with the software that accompanies this document. This section describes the modified Mini-Driver and outlines the steps necessary to initialize the video port for raw capture mode.

Three files were modified to enable raw capture mode operation: `_vport.h`, `vportcap.h`, and `vportcap.c` (renamed to `vportcap_RAW_support.c`). These modified files are available for download with this document. The modified capture configuration structure is shown in the code segment below.

```

typedef struct {
    Int    cmode;
    Int    fldOp;
    Int    scale;
    Int    resmpl;
    Int    bpk10Bit;
    Int    hCtRst;
    Int    vCtRst;
    Int    fldDect;
    Int    extCtl;
    Int    fldInv;

    /* RAW CAPTURE INITIALIZATION SPECIFIC
    Modify structure to accept Raw Capture mode specific
    parameters for SSE Enable/Disable and VCVBLNKP. */

    Uint16 sse;           /* startup synchronization enable */
    Uint16 vcvblnkp;     /* minimum CAPEN inactive time to be
                           interpreted as a vertical blanking period */

    Uint16 fldXStrt1;
    Uint16 fldYStrt1;
    Uint16 fldXStrt2;
    Uint16 fldYStrt2;
    Uint16 fldXStop1;
    Uint16 fldYStop1;
    Uint16 fldXStop2;
    Uint16 fldYStop2;
    Uint16 thrlD;
    Int    numFrmBufs;
    Int    alignment;
    Int    mergeFlds;
    Int    segId;
    Int    edmaPri;
    Int    irqId;
} VPORTCAP_Params;

```

**Figure 9. Capture Configuration Structure**

Two parameters (Uint16 sse and Uint16 vcvblnkp) were added to the configuration structure to ensure that the SSE and VCVBLNKP fields in the VCxSTRT1 register (described in a previous section) are correctly programmed. All other parameters in the configuration structure are unmodified and are described in the application report *TMS320DM642 Video Port Mini-Driver* (SPRA918). The following are possible settings for the 'sse' and 'vcvblnkp' parameters.

- **sse**: enables or disables startup synchronization
  - VPORTCAP\_SSE\_ENABLE
  - VPORTCAP\_SSE\_DISABLE
- **vcvblnkp**: specifies the minimum CAPEN inactive time to be interpreted as a vertical blanking period.
  - Any value between 0 and 0xFFFF

The code segment below shows the capture configuration structure initialized to enable 8-bit raw capture mode (progressive) for a resolution of 640x480.

```

#define LINE_SZ    640
#define NUM_LINES  480
VPORTCAP_Params EVMDM642_vCapParamsChan = {
    VPORT_MODE_RAW_8BIT,
    VPORT_FLDOP_PROGRESSIVE,
    VPORT_SCALING_DISABLE,                // n/a for raw
    VPORT_RESAMPL_DISABLE,                // n/a for raw
    VPORTCAP_BPK_10BIT_ZERO_EXTENDED,
    VPORTCAP_HRST_SAV,                    // n/a for raw
    VPORTCAP_VRST_EAV_V0,                 // n/a for raw
    VPORTCAP_FLDD_DISABLE,                // n/a for raw
    VPORTCAP_EXC_DISABLE,                 // n/a for raw
    VPORTCAP_FINV_ENABLE,                 // n/a for raw

    /* Raw Mode Specific Parameters */
    VPORTCAP_SSE_ENABLE,                   // Enable Startup Sync
    0xFFFF,                                // VCVBLNKP

    0,                                     // Must set to zero for correct operation
    1,                                     // Must set to one for correct operation
    0,                                     // Must set to zero for correct operation
    1,                                     // Must set to one for correct operation

    LINE_SZ-1,
    NUM_LINES,

    LINE_SZ-1,
    NUM_LINES,

    (LINE_SZ>>3),
    4,
    128,
    VPORT_FLDS_MERGED,
    NULL,
    EDMA_OPT_PRI_HIGH,
    8
};

```

**Figure 10. Raw Capture Mode Configuration**

The following fields are not used for raw capture mode operation and were filled to satisfy the configuration structure size and parameter requirements.

- scale, resmpl, hCtRst, vCtRst, fldDect, extCtl, fldInv

The following fields must be set to zero and one for proper operation.

- fldXStrt1 = 0
- fldYStrt1 = 1
- fldXStrt2 = 0
- fldYStrt2 = 1

The following fields are initialized with the desired capture resolution.

- fldXStop1: number of pixels per line to capture minus one (line size – 1)
- fldYStop1: number of lines to capture
- fldXStop2: number of pixels per line to capture minus one (line size – 1)
- fldYStop2: number of lines to capture

Because the Sensor captures and outputs data according to a progressive scan, the video port is configured to operate accordingly.

- fldOp = VPORT\_FLDOP\_PROGRESSIVE

In order to ensure initial capture synchronization to the beginning of a frame,

- sse = VPORTCAP\_SSE\_ENABLE.

Recall that when the SSE bit is set and the video capture port is enabled (VCEN set to 1 in the VCxCTL register), the video port will not start capturing data until after two vertical blanking periods are detected. The length of a single vertical blanking period is defined by VCVBLNKP, which must be assigned a value larger than the expected horizontal blanking interval and less than half the expected vertical blanking interval. Using the frame timing formulas provided in Micron's Data Sheet 2, a value of 0xFFF was chosen to satisfy this constraint.

All other fields not mentioned are not raw capture mode specific and are initialized according to the definitions and restrictions outlined in the *TMS320DM642 Video Port Mini-Driver* (SPRA918) application report and the *TMS320C64x DSP Video Port/VCXO Interpolated Control (VIC) Port Reference Guide* (SPRU629).

#### **4.2.2 Raw Display Mode Initialization**

To display the information captured from the Sensor, the video display port is configured in raw display mode for display on a computer monitor in SVGA mode using the SAA7105 encoder. Note that the display Video Port Mini-Drivers were not modified since raw display mode with the SAA7105 is supported. See the *TMS320DM642 Video Port Mini-Driver* (SPRA918) application report and the *TMS320C64x DSP Video Port/VCXO Interpolated Control (VIC) Port Reference Guide* (SPRU629) for more information on raw display mode operation, and see the source code that accompanies this document to see the steps required for SVGA display on a monitor. Although raw display is not discussed in this document, the following section discusses the data formatting required for 16-bit display on a monitor.

The SAA7105 video encoder on the DM642 EVM can be configured to drive the display on a monitor. The encoder will generate the necessary RGB and synchronization signals provided that it is correctly configured and is given data in the expected format. Encoder configuration is simple with the SAA7105 EDC provided with the Video Port Mini-Driver. The code segment below shows the configuration structure used to initialize the encoder for SVGA display with data in the RGB565 input format.

```
SAA7105_ConfParams EVMDM642_vDisParamsSAA7105 = {
  SAA7105_AFMT_RGB,           // RGB out to monitor
  SAA7105_MODE_SVGA,         // SVGA mode
  SAA7105_IFMT_RGB565,       // Data in RGB565 format
  TRUE,                       // Slave mode operation
  FALSE,                      // not used in this mode
  INV,                        // I2C handle to be initialized in main().
};
```

**Figure 11. SAA7105 Configuration for SVGA Display**

The RGB565 data format is a 16-bit value that represents one pixel. The upper 5, middle 6, and lower 5 bits make up the red, green, and blue colors respectively. This concept is illustrated in Figure 12.

|      |         |        |       |
|------|---------|--------|-------|
| Bits | [15:11] | [10:5] | [4:0] |
|      | Red     | Green  | Blue  |

**Figure 12. RGB565 Data Format**

Recall that the data output from the Sensor is formatted in a Bayer pattern. Consider the case of 640x480 with 8 bits per pixel of video capture. In this case, each pixel captured by the port will consist of 8 bits and be stored in a Bayer pattern. The data format provided by the Sensor is incompatible with the RGB565 data format expected by the decoder and must be converted. Several methods exist to solve this problem. One such solution is to expand each pixel to include 8 bits of red, green, and blue by interpolation or filtering, then extract the upper 5, 6, and 5 bits of RGB data and store them in one 16-bit memory location. This conversion technique effectively converts one plane of 8-bit 640x480 Bayer pattern data into three planes of 8-bit 640x480 RGB data, then to 1 plane of 16-bit 640x480 RGB565 data.

The method used in the Sensor to DM642 interface discussed in this document avoids the color plane expansion discussed above, but results in a reduction of display resolution. Consider the 4x4 block of Bayer pattern data below. By thinking of each 2x2 block (shaded portion) as a single pixel of 8-bit red, green, and blue data, the upper 5, 6, and 5 bits of red, green (average the two green pixels together), and blue can be extracted and stored into 16-bit memory. The advantage of this algorithm is simplicity, but the disadvantage is a reduction of display resolution. This algorithm reduces both the horizontal and vertical resolutions by half. In the case of 640x480 capture, only 320x240 can be displayed. To circumvent a reduction of desired display resolution, the video port and Sensor can be set to capture twice the desired display resolution. For example, if a display of 640x480 is desired, capture 1280x960. The price of this solution is a potential decrease in capture and display performance in terms of frames per second.



|   |   |   |   |
|---|---|---|---|
| G | R | G | R |
| B | G | B | G |
| G | R | G | R |
| B | G | B | G |

**Figure 13. Bayer Pattern (4x4)**

### 4.2.3 Sensor EDC

This section describes the design and operation of the Sensor EDC used to initialize the Sensor for video capture. The sensor EDC is designed to operate and is fully compliant with the Video Port Mini-Driver. Note that the operation and initialization of the Video Port Mini-Driver is not discussed in this section. For more information, see the application report *TMS320DM642 Video Port Mini-Driver* (SPRA918).

To access and configure the Sensor, three functions are defined:

- `MT9T001_open()`
  - This function opens the Sensor and provides access for single sensor operation on video port 0 or video port 1, or dual sensor operation on both video ports. All configurations operate on channel A only. The method of indicating which video port to operate on is based on the naming convention used to allocate and initialize an FVID channel object. The name used to initialize an FVID object consists of three substrings separated by a '/'. The sample code below illustrates the naming convention required for Sensor identification and operation.

The first substring is used by the driver to identify the video port.

The second substring is used to identify the channel (A or B) on which to operate. For this application, this substring must always be an 'A'.

The third substring is used to identify the video port number that the Sensor is connected to. If the Sensor is on video port 1, this substring must be a '1'; if on video port 0, this substring must be a '0'.

```
// Create object for Sensor on Video Port 1, Channel A Operation
capVideoPort1 = FVID_create("/VP1CAPTURE/A/1", IOM_INPUT, NULL, (Ptr)&CapParamsVP1,
NULL);
// Create object for Sensor on Video Port 0, Channel A Operation
capVideoPort0 = FVID_create("/VP0CAPTURE/A/0", IOM_INPUT, NULL, (Ptr)&CapParamsVP0,
NULL);
```

**Figure 14. FVID Object Initialization**

- `MT9T001_close()`
  - This function closes the Sensor port and places the Sensor in standby mode.
- `MT9T001_ctrl()`
  - This function issues commands to the Sensor. There are three commands supported by this function. Other commands can be added by modifying this function according to the EDC interface standard.

EDC\_RESET – This command resets the Sensor.

EDC\_CONFIG – This command configures the Sensor to one of four capture resolutions: 320x240, 640x480, 1280x720, and 1920x1080. Other capture resolutions can be added by modifying this command.

EDC\_START – This command enables and begins video capture.

### 4.3 Capture and Display Performance

The software example that accompanies this document supports four capture resolutions. Other capture resolutions can be easily added by modifying the source code. The table below shows the four capture resolutions supported along with the capture and display performance in terms of frames per second (fps). The ‘Sensor Out’, ‘Video Port Capture’, and ‘Video Port Display’ columns represent the fps output by the Sensor, captured by the video port, and output to an SVGA monitor. The routine that counts fps is included with the source code that accompanies this document. The values in the ‘Sensor Out’ column were calculated according to the Frame Timing equations documented in the Micron’s Data Sheet 2. The register values for the resolution settings below are also documented in Micron’s Data Sheet 2.

**Table 6. Capture and Display Performance**

| Capture Resolution   | Frame Rate (fps) <sup>†</sup> |                    |                    | Display Resolution   |
|----------------------|-------------------------------|--------------------|--------------------|----------------------|
|                      | Sensor Out                    | Video Port Capture | Video Port Display |                      |
| 320x240 <sup>‡</sup> | 120 <sup>§</sup>              | 119                | 60                 | 160x120              |
| 640x480              | 94                            | 94                 | 60                 | 320x240              |
| 1280x720             | 39                            | 39                 | 39                 | 640x360              |
| 1920x1080            | 19                            | 19                 | 19                 | 800x540 <sup>¶</sup> |

<sup>†</sup> These rates are possible after compiling with file level optimization on MT9T001\_utils.c

<sup>‡</sup> The settings for this resolution are not given in the *CMOS Digital Image Sensor* data sheet. Column Size = 319, Row Size = 239, Shutter Width = 564 (to remove 60Hz flicker), Horizontal Blanking = 21, Vertical Blanking = 15.

<sup>§</sup> The frame rate is low in order to remove 60Hz flicker from artificial lighting conditions. See the *CMOS Digital Image Sensor* data sheet for more details on 60Hz flicker.

<sup>¶</sup> The display resolution after Bayer to RGB565 conversion is 960x540. In SVGA mode, a maximum of 800x600 lines can be displayed. Since 800 is less than 960, only 800 pixels per line are displayed.

## 5 Conclusion

This document describes how to interface the TMS320DM642 to a CMOS Digital Image Sensor in raw capture mode. A complete example is shown, including hardware and software interfaces. The software consists of a set of routines that are compatible with the Video Port Mini-Driver and External Device Control interface. At capture resolutions of 1920x1080, 1280x720, 640x480, and 320x240, the video display port operates at 19, 39, 60, and 60 frames per second respectively. This document is accompanied by example software designed to operate with the TMS320DM642 EVM and is available electronically from the TI website.

## 6 References

1. Jack, Keith. *Video Demystified: A Handbook for the Digital Engineer*. Elsevier Science & Technology Books, April 2001.
2. *MT9T001 3-Megapixel CMOS Digital Image Sensor Data Sheet*, Micron™ Technology, Inc.
3. *PCA9540B 2-Channel I<sup>2</sup>C Multiplexer Data Sheet*, Philips Semiconductors
4. *SN74CBTLV3257 Low-Voltage 4-Bit 1-Of-2 FET Multiplexer/Demultiplexer*, Texas Instruments
5. *TMS320C6000 DSP Inter-Integrated Circuit (I2C) Module Reference Guide (SPRU175)*
6. *TMS320C64x DSP Video Port/VCXO Interpolated Control (VIC) Port Reference Guide (SPRU629)*
7. *TMS320DM642 Video/Imaging Fixed-Point Digital Signal Processor Data Manual (SPRS200)*
8. *The TMS320DM642 Video Port Mini-Driver (SPRA918)*

## Appendix A Sensor Daughter Card Schematics for the DM642 EVM

The following pages contain schematics for a Sensor daughtercard that can interface to the DM642 EVM. This example is applicable to other Sensors and video A/D converters having similar interfaces. The schematics shown can operate with up to two Sensors and provide Sensor data multiplexing to allow for expansion to higher resolution Sensors.

Data multiplexing is controlled by switch 1 (SW1) on the schematic. When the switch is off, the video port can operate in 8, 10, and 20-bit raw capture modes. When the switch is on, the video port can operate in 16-bit raw capture mode. For 16-bit mode operation, the DC\_EXP\_AUDIO\_EN# signal on J3 must be connected to 3.3V. Note that the software provided with this document operates on 8-bit data and assumes single sensor operation on video port 1 by default. For more information on the data multiplexers, see the *SN74CBTLV3257 Multiplexer* Data sheet and the *TMS320C64x DSP Video Port/VCXO Interpolated Control (VIC) Port Reference Guide* (SPRU629)

To provide access for up to two Sensors, a 2-channel I<sup>2</sup>C address multiplexer is used (PCA9540B). Address multiplexing may be necessary since multiple Sensors on a single board may have the same I<sup>2</sup>C address. The multiplexer allows each Sensor to be programmed independently. The necessary address translation is automatically performed in the software and is based on the naming convention used to allocate and initialize an FVID channel object. Refer to the Sensor EDC section in this document for a discussion on FVID channel objects. For more information on the PCA9540B, refer to the *PCA9540B 2-Channel I<sup>2</sup>C Multiplexer* data sheet.



# Micron CMOS Sensor Daughter Card for DM642 Evaluation Module

## Table of Contents

- 1) Contents, Notes, & Revisions
- 2) EMIF DC Interface
- 3) VPO/1 DC Interface
- 4) VP2 DC Interface
- 5) Sensor Connection
- 6) Bus Switches for VPO
- 7) Bus Switches for VP1

**Notes:**

- 1) RESISTANCE VALUES ARE IN OHMS.
- 2) CAPACTRANCE VALUES ARE IN MICRO-PARADS (uP).
- 3) BOARD PROPERTIES
  - A. ROUTE TO WITHIN 10% OF MANHATTAN DISTANCE
  - B. 50 OHM MATCHED IMPEDANCE FOR DIGITAL LINES.
  - C. OUTER LAYERS 0.5 OZ CU & 0.5 OZ AU PLATING
  - D. INNER LAYERS 1.0 OZ CU
  - E. FR4 BOARD MATERIAL
  - F. MINIMUM TRACE WIDTH/SPACING 4/8 MILS
  - G. MINIMUM VIA SIZE 10/19 MIL
  - H. APPROXIMATE BOARD SIZE 3.5 x 5.125 INCHES
  - I. THERMAL RELIEFS SHOULD NOT BE USED

| Revision History |   |         |          |
|------------------|---|---------|----------|
| Rev. #           | Description   | Date    | Approval |
| 0.1              | Preliminary Schematics Completed  | 3/15/04 | JBF      |
| 1.1              | - Fixed DC_EXP_CAPTUREx_ENH# issue with respect to Bus Switches<br>- Fixed Muxing for 16-bit Mode<br>- Added TPs to I2C<br>- Fixed PCA9540B footprint<br>- Adjusted Size of DC<br>- Use Edge Connectors for Camera 0/1 Headers<br>- Added Gnd TPs | 7/14/04 | JBF      |

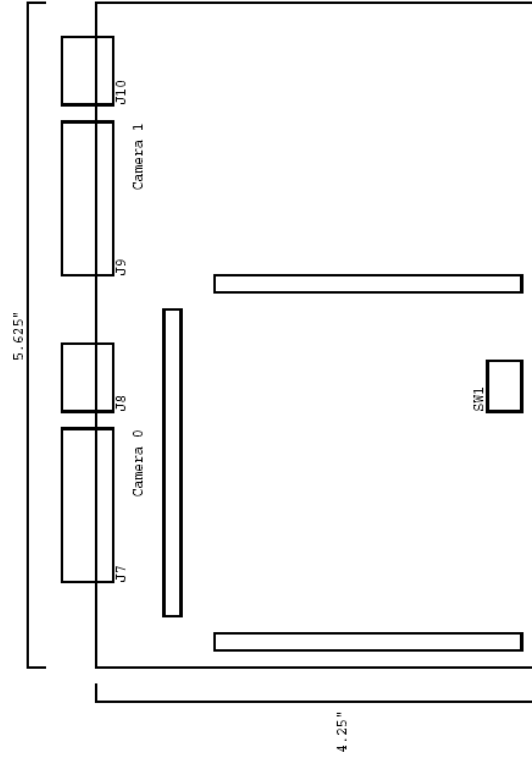

- J7 and J9 are 13x2 Edge Connectors
- J8 and J10 are 7x2 Edge Connectors
- Label J7 and J8 as Camera 0, J9 and J10 as Camera 1

|   |                          |
|---|--------------------------|
| <b>TEXAS INSTRUMENTS</b>                  |                          |
| Title: <b>CMOS Sensor Daughter Card</b>   |                          |
| Description: Contents, Notes, & Revisions |                          |
| Doc. #:                                   | <Doc>                    |
| Rev.:                                     | 1.1                      |
| Page:                                     | 1 of 7                   |
| Date:                                     | Wednesday, July 14, 2004 |

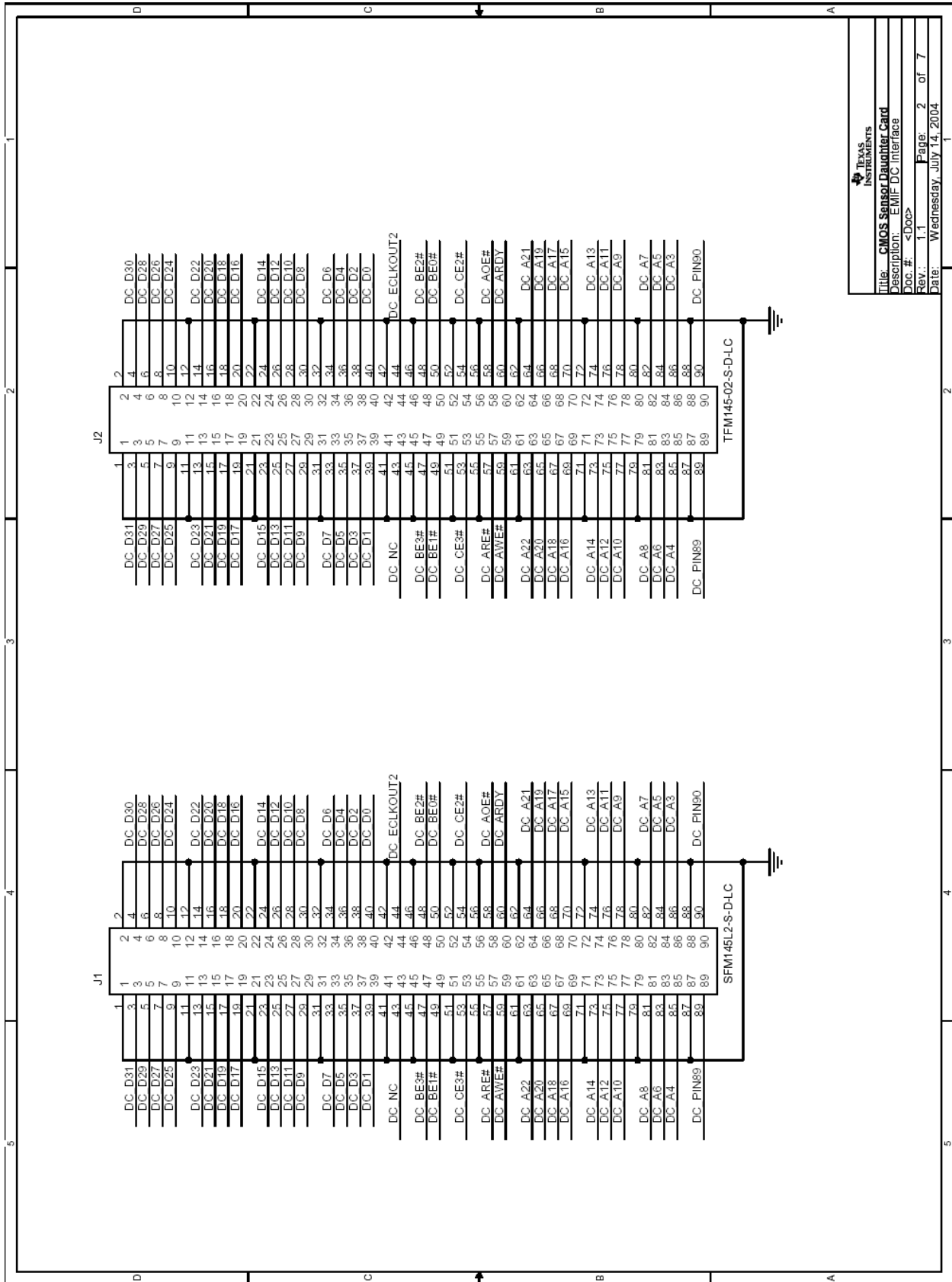

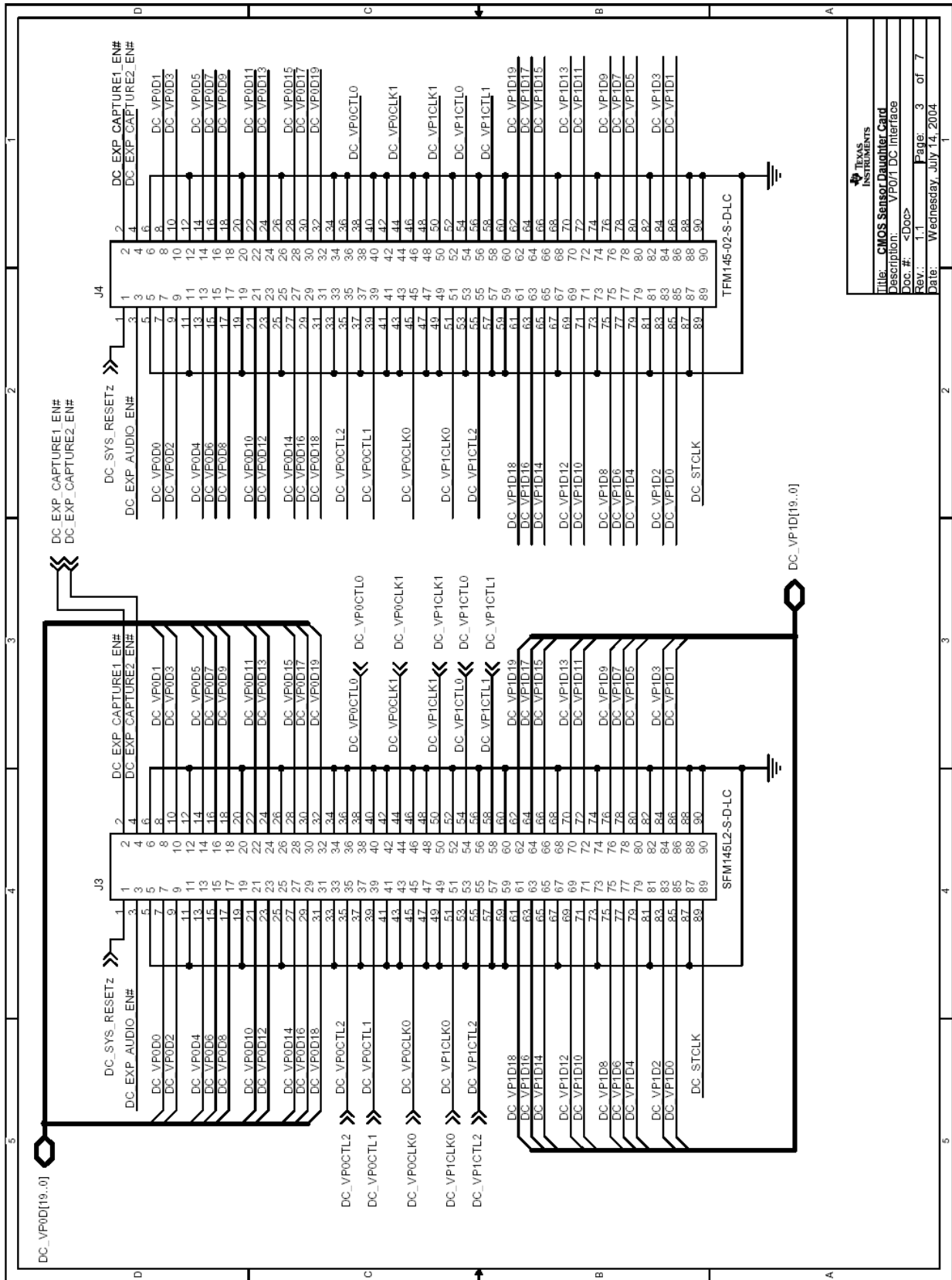

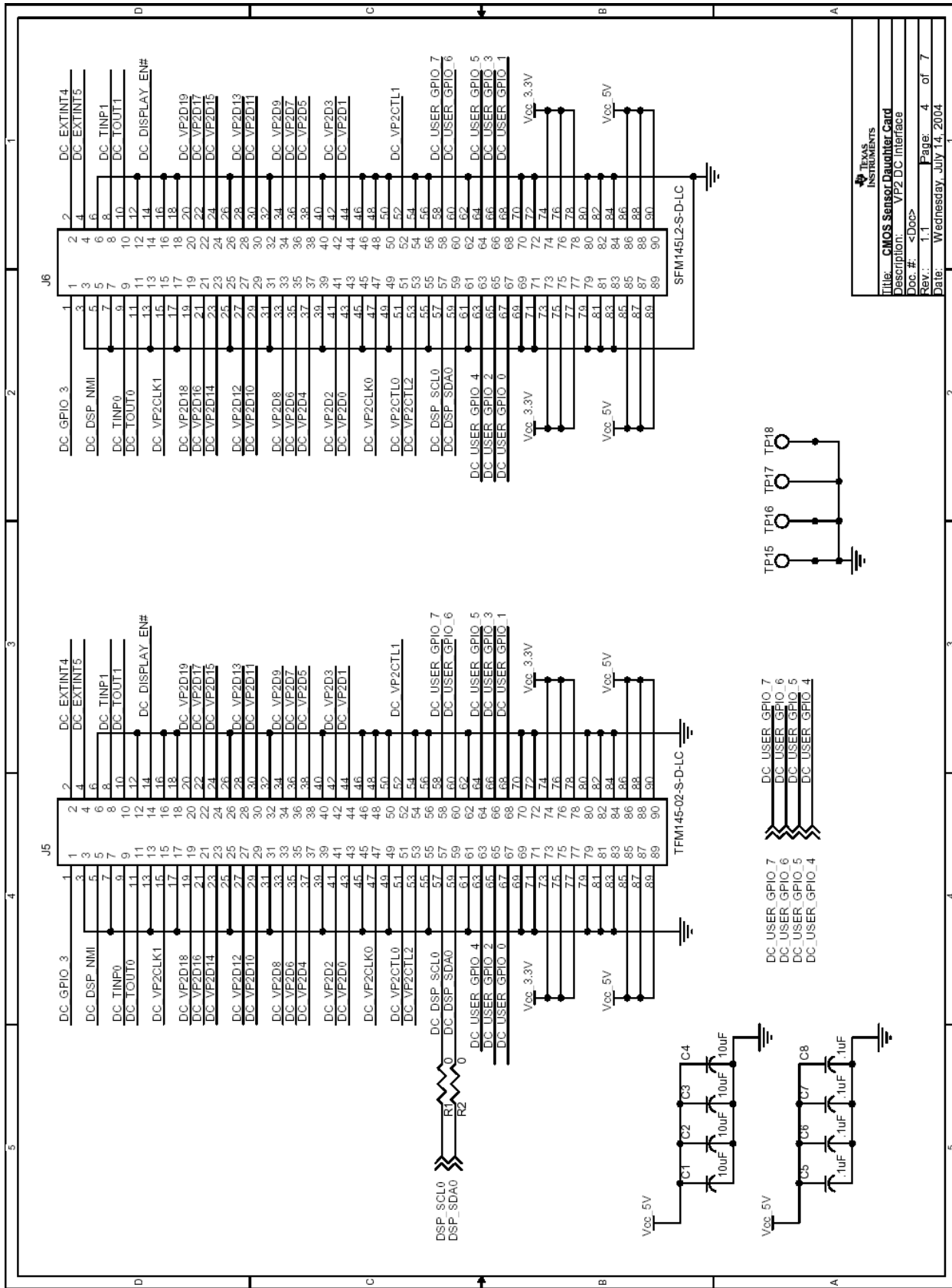

|              |                           |
|--------------|---------------------------|
| Title:       | CMOS Sensor Daughter Card |
| Description: | VP2 DC Interface          |
| Doc. #:      | <Doc>                     |
| Rev.:        | 1.1                       |
| Date:        | Wednesday, July 14, 2004  |
| Page:        | 4 of 7                    |



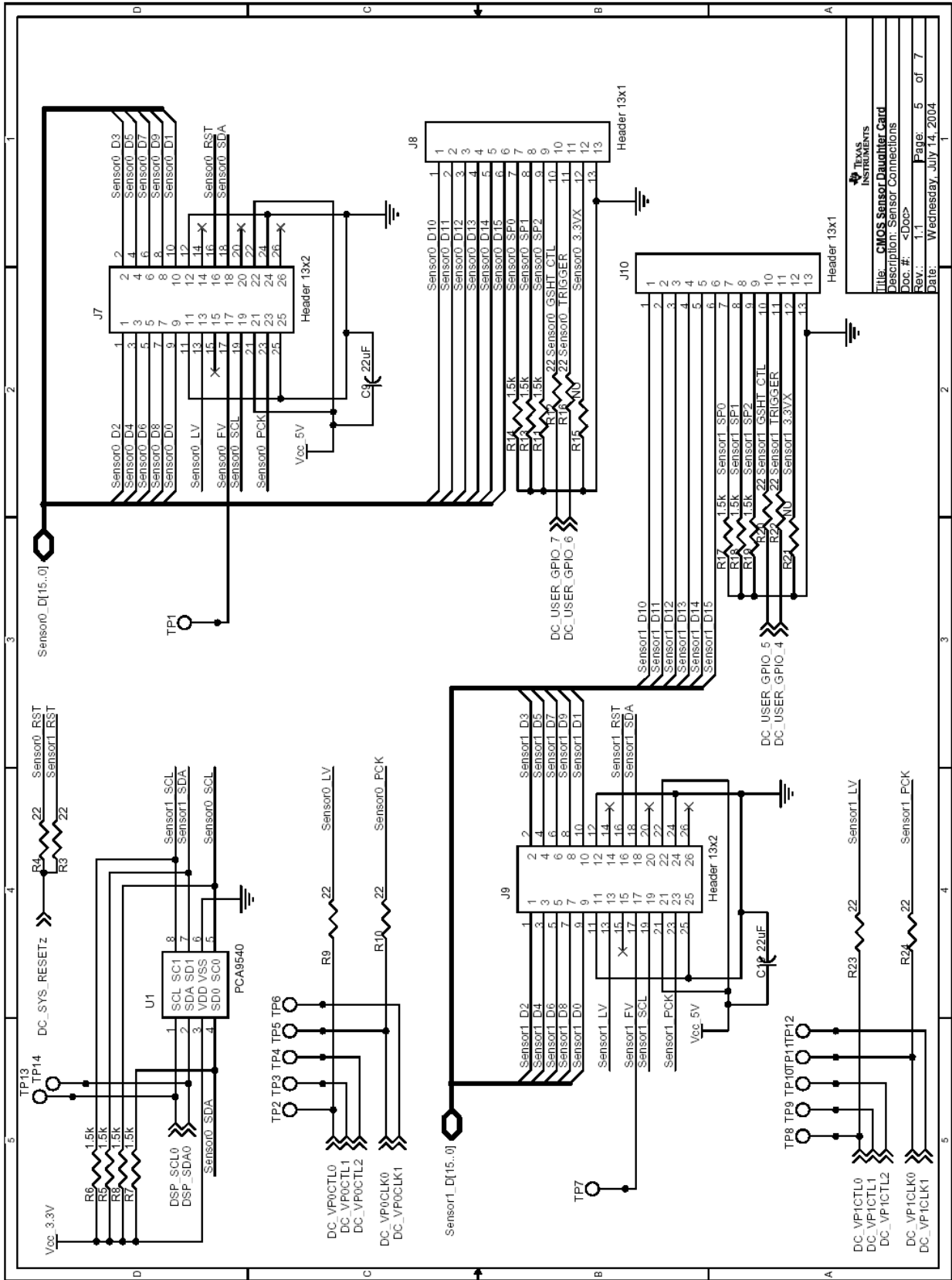

|                                  |       |       |                          |
|----------------------------------|-------|-------|--------------------------|
| Title: CMOS Sensor Daughter Card |       |       |                          |
| Description: Sensor Connections  |       |       |                          |
| Doc. #:                          | <Doc> | Page: | 5 of 7                   |
| Rev.:                            | 1.1   | Date: | Wednesday, July 14, 2004 |

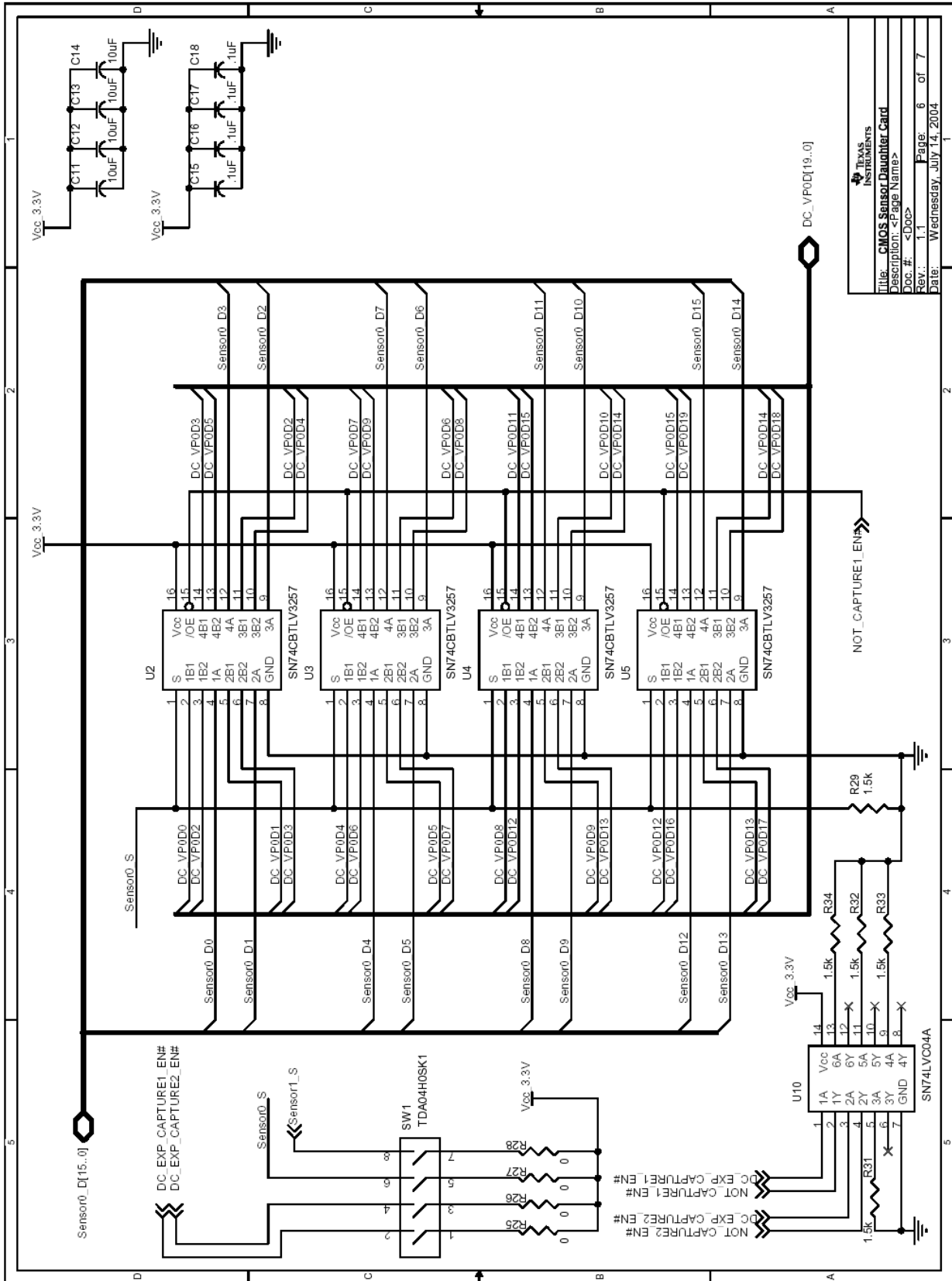

|                                  |                          |
|----------------------------------|--------------------------|
| Texas Instruments                |                          |
| Title: CMOS Sensor Daughter Card |                          |
| Description: <Page Name>         |                          |
| Doc. #:                          | <Doc>                    |
| Rev.:                            | 1.1                      |
| Date:                            | Wednesday, July 14, 2004 |
| Page:                            | 6 of 7                   |

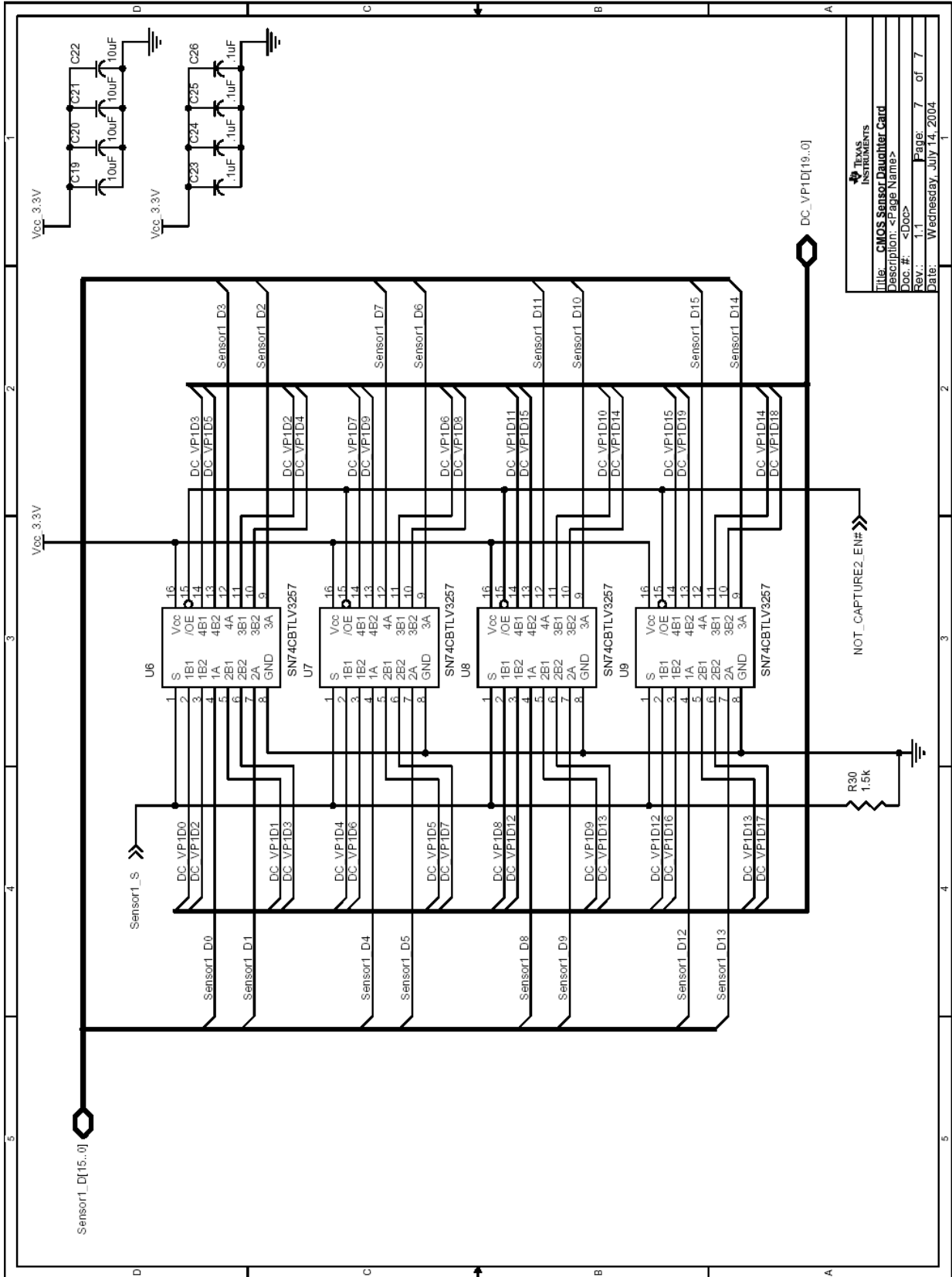

## IMPORTANT NOTICE

Texas Instruments Incorporated and its subsidiaries (TI) reserve the right to make corrections, modifications, enhancements, improvements, and other changes to its products and services at any time and to discontinue any product or service without notice. Customers should obtain the latest relevant information before placing orders and should verify that such information is current and complete. All products are sold subject to TI's terms and conditions of sale supplied at the time of order acknowledgment.

TI warrants performance of its hardware products to the specifications applicable at the time of sale in accordance with TI's standard warranty. Testing and other quality control techniques are used to the extent TI deems necessary to support this warranty. Except where mandated by government requirements, testing of all parameters of each product is not necessarily performed.

TI assumes no liability for applications assistance or customer product design. Customers are responsible for their products and applications using TI components. To minimize the risks associated with customer products and applications, customers should provide adequate design and operating safeguards.

TI does not warrant or represent that any license, either express or implied, is granted under any TI patent right, copyright, mask work right, or other TI intellectual property right relating to any combination, machine, or process in which TI products or services are used. Information published by TI regarding third-party products or services does not constitute a license from TI to use such products or services or a warranty or endorsement thereof. Use of such information may require a license from a third party under the patents or other intellectual property of the third party, or a license from TI under the patents or other intellectual property of TI.

Reproduction of TI information in TI data books or data sheets is permissible only if reproduction is without alteration and is accompanied by all associated warranties, conditions, limitations, and notices. Reproduction of this information with alteration is an unfair and deceptive business practice. TI is not responsible or liable for such altered documentation. Information of third parties may be subject to additional restrictions.

Resale of TI products or services with statements different from or beyond the parameters stated by TI for that product or service voids all express and any implied warranties for the associated TI product or service and is an unfair and deceptive business practice. TI is not responsible or liable for any such statements.

TI products are not authorized for use in safety-critical applications (such as life support) where a failure of the TI product would reasonably be expected to cause severe personal injury or death, unless officers of the parties have executed an agreement specifically governing such use. Buyers represent that they have all necessary expertise in the safety and regulatory ramifications of their applications, and acknowledge and agree that they are solely responsible for all legal, regulatory and safety-related requirements concerning their products and any use of TI products in such safety-critical applications, notwithstanding any applications-related information or support that may be provided by TI. Further, Buyers must fully indemnify TI and its representatives against any damages arising out of the use of TI products in such safety-critical applications.

TI products are neither designed nor intended for use in military/aerospace applications or environments unless the TI products are specifically designated by TI as military-grade or "enhanced plastic." Only products designated by TI as military-grade meet military specifications. Buyers acknowledge and agree that any such use of TI products which TI has not designated as military-grade is solely at the Buyer's risk, and that they are solely responsible for compliance with all legal and regulatory requirements in connection with such use.

TI products are neither designed nor intended for use in automotive applications or environments unless the specific TI products are designated by TI as compliant with ISO/TS 16949 requirements. Buyers acknowledge and agree that, if they use any non-designated products in automotive applications, TI will not be responsible for any failure to meet such requirements.

Following are URLs where you can obtain information on other Texas Instruments products and application solutions:

| <b>Products</b>             |  | <b>Applications</b>        |  |
|-----------------------------|--|----------------------------|--|
| Amplifiers                  | <a href="http://amplifier.ti.com">amplifier.ti.com</a>             | Audio                      | <a href="http://www.ti.com/audio">www.ti.com/audio</a>                                   |
| Data Converters             | <a href="http://dataconverter.ti.com">dataconverter.ti.com</a>     | Automotive                 | <a href="http://www.ti.com/automotive">www.ti.com/automotive</a>                         |
| DLP® Products               | <a href="http://www.dlp.com">www.dlp.com</a>                       | Communications and Telecom | <a href="http://www.ti.com/communications">www.ti.com/communications</a>                 |
| DSP                         | <a href="http://dsp.ti.com">dsp.ti.com</a>                         | Computers and Peripherals  | <a href="http://www.ti.com/computers">www.ti.com/computers</a>                           |
| Clocks and Timers           | <a href="http://www.ti.com/clocks">www.ti.com/clocks</a>           | Consumer Electronics       | <a href="http://www.ti.com/consumer-apps">www.ti.com/consumer-apps</a>                   |
| Interface                   | <a href="http://interface.ti.com">interface.ti.com</a>             | Energy                     | <a href="http://www.ti.com/energy">www.ti.com/energy</a>                                 |
| Logic                       | <a href="http://logic.ti.com">logic.ti.com</a>                     | Industrial                 | <a href="http://www.ti.com/industrial">www.ti.com/industrial</a>                         |
| Power Mgmt                  | <a href="http://power.ti.com">power.ti.com</a>                     | Medical                    | <a href="http://www.ti.com/medical">www.ti.com/medical</a>                               |
| Microcontrollers            | <a href="http://microcontroller.ti.com">microcontroller.ti.com</a> | Security                   | <a href="http://www.ti.com/security">www.ti.com/security</a>                             |
| RFID                        | <a href="http://www.ti-rfid.com">www.ti-rfid.com</a>               | Space, Avionics & Defense  | <a href="http://www.ti.com/space-avionics-defense">www.ti.com/space-avionics-defense</a> |
| RF/IF and ZigBee® Solutions | <a href="http://www.ti.com/lprf">www.ti.com/lprf</a>               | Video and Imaging          | <a href="http://www.ti.com/video">www.ti.com/video</a>                                   |
|                             |  | Wireless                   | <a href="http://www.ti.com/wireless-apps">www.ti.com/wireless-apps</a>                   |