



Nanopower, 1.8V, SOT23 Comparator with Voltage Reference

FEATURES

- **LOW QUIESCENT CURRENT:** 5µA (max)
- **INTEGRATED VOLTAGE REFERENCE:** 1.242V
- **INPUT COMMON-MODE RANGE:**
200mV Beyond Rails
- **VOLTAGE REFERENCE INITIAL ACCURACY:** 1%
- **OPEN-DRAIN LOGIC COMPATIBLE OUTPUT:**
TLV3011
- **PUSH-PULL OUTPUT:** TLV3012
- **LOW-SUPPLY VOLTAGE:** 1.8V to 5.5V
- **FAST RESPONSE TIME:** 6µs Propagation Delay
with 100mV Overdrive (TLV3011: $R_{PULL-UP} = 10k\Omega$)
- **MicroSIZE PACKAGES:** SOT23-6 and SC70-6

APPLICATIONS

- **BATTERY-POWERED LEVEL DETECTION**
- **DATA ACQUISITION**
- **SYSTEM MONITORING**
- **OSCILLATORS**
- **SENSOR SYSTEMS:**
Smoke Detectors, Light Sensors, Alarms

DESCRIPTION

The TLV3011 is a low-power, open-drain output comparator; the TLV3012 is a push-pull output comparator. Both feature an uncommitted on-chip voltage reference. Both have 5µA (max) quiescent current, input common-mode range 200mV beyond the supply rails, and single-supply operation from 1.8V to 5.5V. The integrated 1.242V series voltage reference offers low 100ppm/°C (max) drift, is stable with up to 10nF capacitive load, and can provide up to 0.5mA (typ) of output current.

The TLV3011 and TLV3012 are available in the tiny SOT23-6 package for space-conservative designs. It is also available in the SC70 package for even greater board area savings. Both versions are specified for the temperature range of -40°C to +125°C.

TLV3011 and TLV3012 RELATED PRODUCTS

PRODUCT	FEATURES
TLV349x	1.2µA, 1.8V to 5.5V Push-Pull Comparator
TLV370x	560nA, 2.5V to 16V Push-Pull CMOS Output Comparator
TLV340x	550nA, 2.5V to 16V Open-Drain Comparator

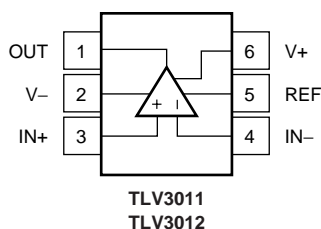

Please be aware that an important notice concerning availability, standard warranty, and use in critical applications of Texas Instruments semiconductor products and disclaimers thereto appears at the end of this data sheet.

All trademarks are the property of their respective owners.

ABSOLUTE MAXIMUM RATINGS⁽¹⁾

Supply Voltage	+7V
Signal Input Terminals, Voltage ⁽²⁾	-0.5V to (V+) + 0.5V
Current ⁽²⁾	±10mA
Output Short-Circuit ⁽³⁾	Continuous
Operating Temperature	-55°C to +150°C
Storage Temperature	-55°C to +150°C
Junction Temperature	+150°C
Lead Temperature (soldering, 10s)	+300°C
ESD Rating (Human Body Model)	2000V

NOTE: (1) Stresses above these ratings may cause permanent damage. Exposure to absolute maximum conditions for extended periods may degrade device reliability. These are stress ratings only, and functional operation of the device at these or any other conditions beyond those specified is not implied.

(2) Input terminals are diode-clamped to the power-supply rails. Input signals that can swing more than 0.5V beyond the supply rails should be current limited to 10mA or less.

(3) Short-circuit to ground.



ELECTROSTATIC DISCHARGE SENSITIVITY

This integrated circuit can be damaged by ESD. Texas Instruments recommends that all integrated circuits be handled with appropriate precautions. Failure to observe proper handling and installation procedures can cause damage.

ESD damage can range from subtle performance degradation to complete device failure. Precision integrated circuits may be more susceptible to damage because very small parametric changes could cause the device not to meet its published specifications.

PACKAGE/ORDERING INFORMATION

For the most current package and ordering information, see the Package Option Addendum located at the end of this data sheet.

PIN CONFIGURATIONS

Top View

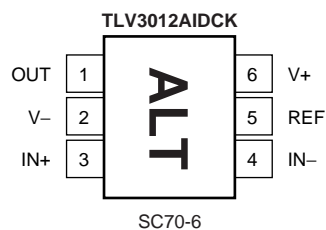
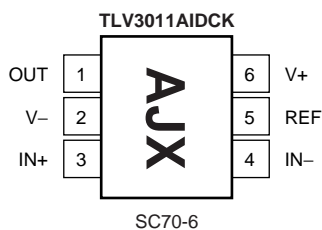
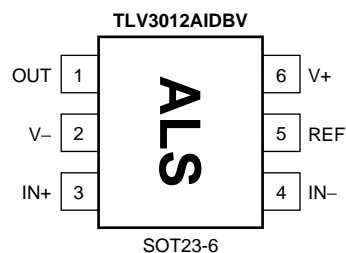
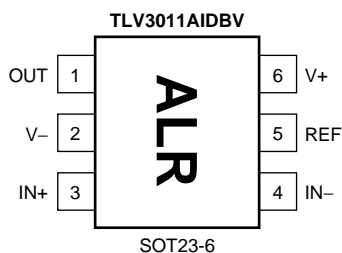

NOTE: Pin 1 is determined by orienting package marking as shown.

ELECTRICAL CHARACTERISTICS: $V_S = +1.8V$ to $+5.5V$

Boldface limits apply over the specified temperature range, $T_A = -40^\circ\text{C}$ to $+125^\circ\mathbf{C}$.

At $T_A = +25^\circ\text{C}$, $V_{OUT} = V_S$, unless otherwise noted; for TLV3011, $R_{PULL-UP} = 10k\Omega$ connected to V_S .

PARAMETER	CONDITION	TLV3011, TLV3012			UNITS
		MIN	TYP	MAX	
OFFSET VOLTAGE Input Offset Voltage vs Temperature vs Power Supply	V_{OS} dV_{OS}/dT PSRR $V_{CM} = 0V, I_O = 0V$ $T_A = -40^\circ\text{C}$ to $+125^\circ\text{C}$ $V_S = 1.8V$ to $5.5V$		0.5 ± 12 100	12 1000	mV $\mu\text{V}/^\circ\text{C}$ $\mu\text{V}/V$
INPUT BIAS CURRENT Input Bias Current Input Offset Current	I_B I_{OS} $V_{CM} = V_S/2$ $V_{CM} = V_S/2$		± 1 ± 1	± 10 ± 10	pA pA
INPUT VOLTAGE RANGE Common-Mode Voltage Range Common-Mode Rejection Ratio	V_{CM} CMRR $V_{CM} = -0.2V$ to $(V+) - 1.5V$ $V_{CM} = -0.2V$ to $(V+) + 0.2V$	$(V-) - 0.2V$ 60 54	74 62	$(V+) + 0.2V$	V dB dB
INPUT IMPEDANCE Common-Mode Differential			$10^{13} \parallel 2$ $10^{13} \parallel 4$		$\Omega \parallel \text{pF}$ $\Omega \parallel \text{pF}$
SWITCHING CHARACTERISTICS Propagation Delay Time, Low-to-High Propagation Delay Time, High-to-Low Rise Time, TLV3011 Rise Time, TLV3012 Fall Time	t_{PLH} t_{PHL} t_R t_F $f = 10\text{kHz}, V_{STEP} = 1V$ Input Overdrive = 10mV Input Overdrive = 100mV Input Overdrive = 10mV Input Overdrive = 100mV $C_L = 10\text{pF}$ $C_L = 10\text{pF}$		12 6 13.5 6.5 See Note 1 100 100		μs μs μs μs ns ns
OUTPUT Voltage Output Low from Rail Voltage Output High From Rail, TLV3012 Short-Circuit Current, TLV3012	V_{OL} $I_{OUT} = -5\text{mA}$ $I_{OUT} = 5\text{mA}$ $V_S = 5V$		160 90	200 200	mV mV
See Typical Characteristics					
VOLTAGE REFERENCE Initial Accuracy Temperature Drift Load Regulation Sourcing Sinking Output Current Line Regulation	V_{OUT} dV_{OUT}/dT dV_{OUT}/dI_{LOAD} I_{LOAD} dV_{OUT}/dV_{IN} $V_{IN} = 5V$ $-40^\circ\text{C} \leq T_A \leq 125^\circ\text{C}$ $0\text{mA} < I_{SOURCE} \leq 0.5\text{mA}$ $0\text{mA} < I_{SINK} \leq 0.5\text{mA}$ $1.8V \leq V_{IN} \leq 5.5V$	1.230	1.242	1.254 ± 1 100	V % ppm/ $^\circ\text{C}$ mV/mA mV/mA mA $\mu\text{V}/V$
NOISE Reference Voltage Noise	$f = 0.1\text{Hz}$ to 10Hz		0.2		mV _{PP}
POWER SUPPLY Specified Voltage Operating Voltage Range Quiescent Current	V_S I_Q $V_S = 5V, V_O = \text{High}$	1.8 1.8		5.5 5.5 5	V V μA
TEMPERATURE RANGE Specified Range Operating Range Storage Range Thermal Resistance, θ_{JA} SOT23-6 SC70-6		-40 -55 -55		+125 +150 +150	$^\circ\text{C}$ $^\circ\text{C}$ $^\circ\text{C}$ $^\circ\text{C}/W$ $^\circ\text{C}/W$

NOTE: (1) t_R dependent on $R_{PULL-UP}$ and C_{LOAD} .

TYPICAL CHARACTERISTICS

At $T_A = +25^\circ\text{C}$, $V_S = +1.8\text{V}$ to $+5.5\text{V}$, $R_{\text{PULL-UP}} = 10\text{k}\Omega$, and Input Overdrive = 100mV , unless otherwise noted.

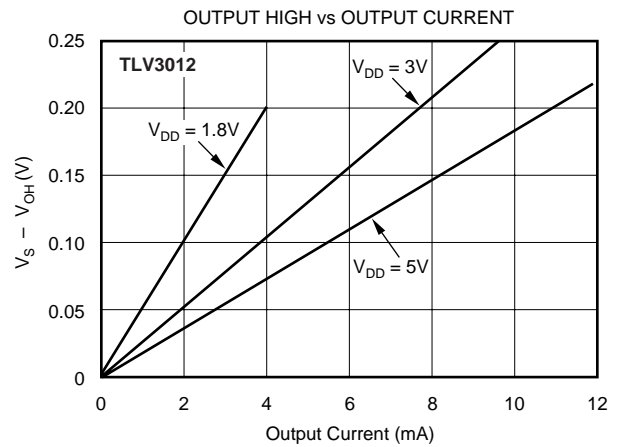
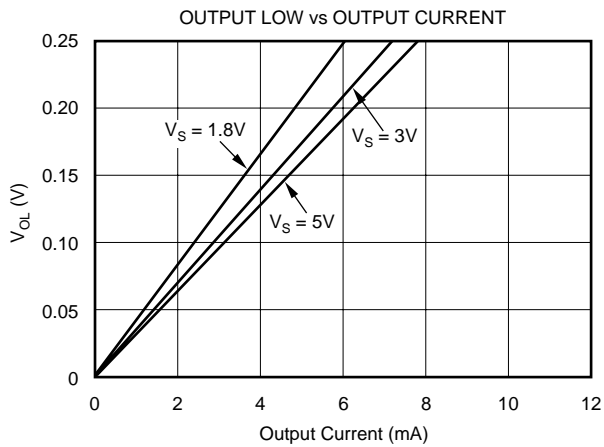
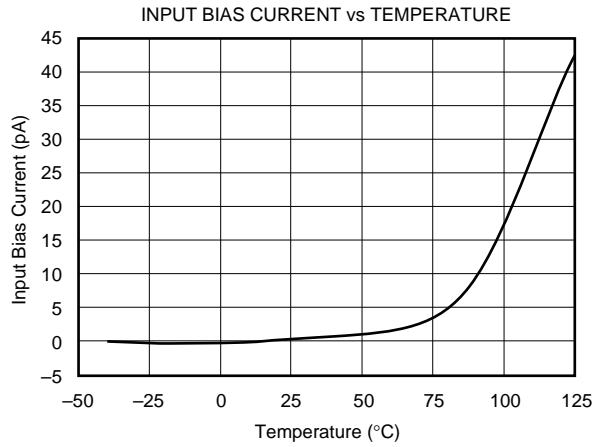
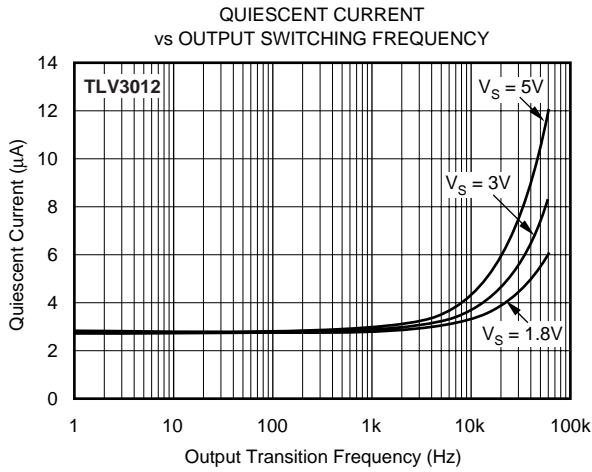
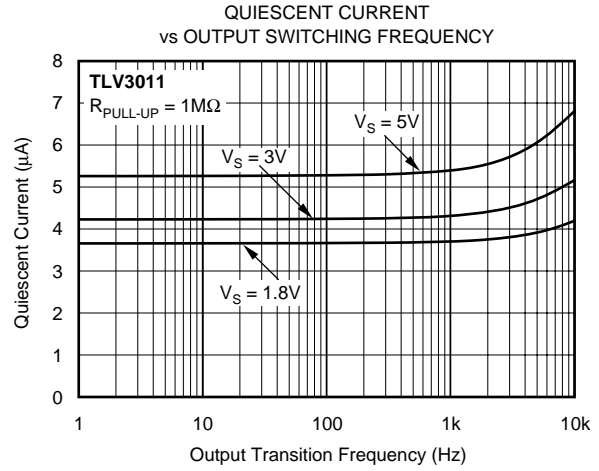
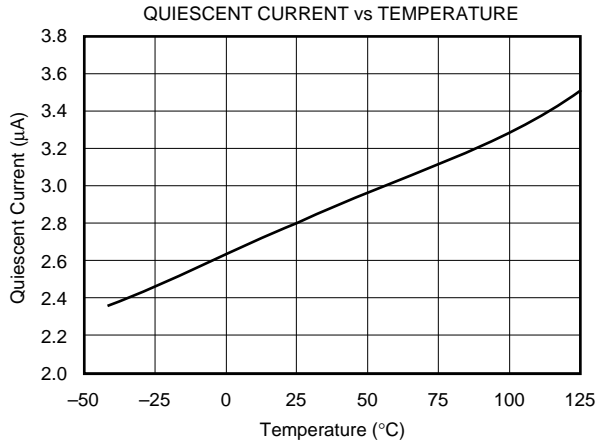

TYPICAL CHARACTERISTICS (Cont.)

At $T_A = +25^\circ\text{C}$, $V_S = +1.8\text{V}$ to $+5.5\text{V}$, $R_{PULL-UP} = 10\text{k}\Omega$, and Input Overdrive = 100mV , unless otherwise noted.

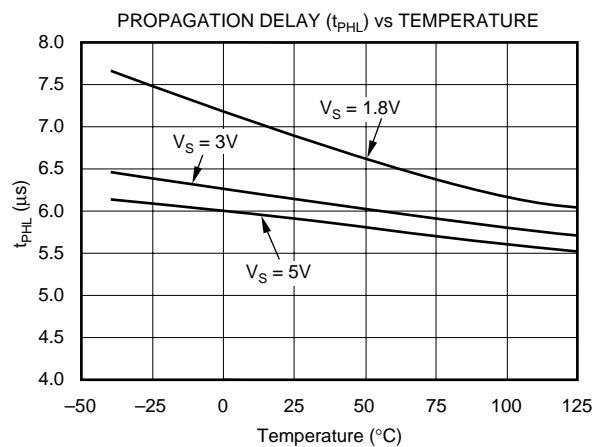
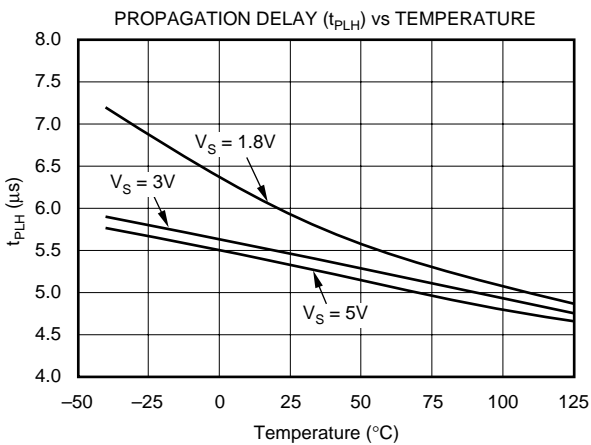
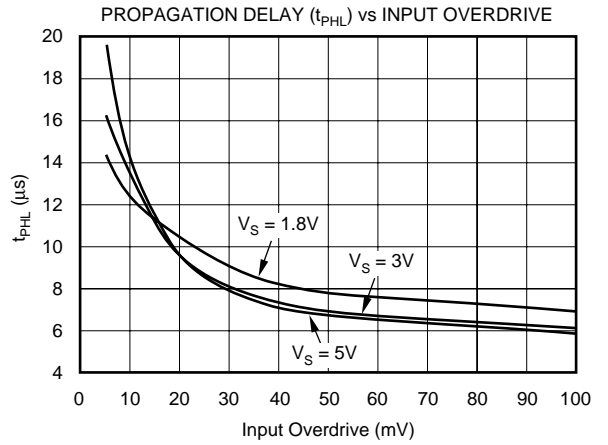
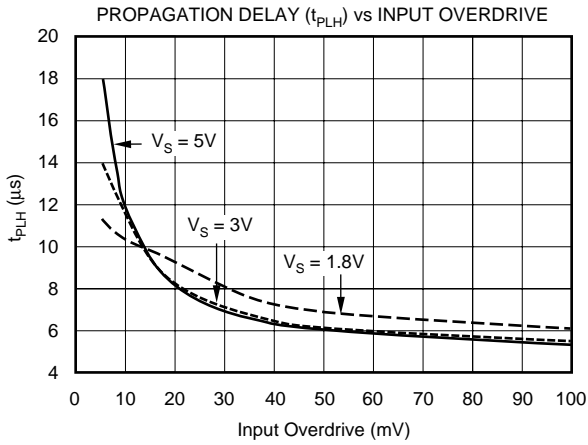
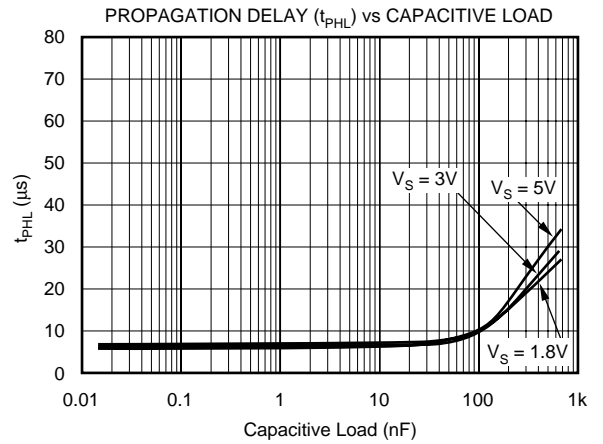
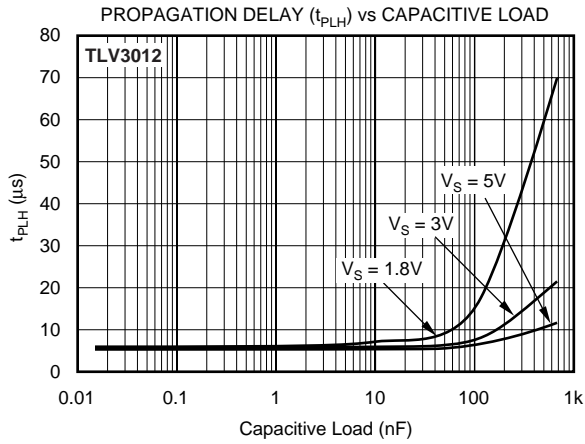

TYPICAL CHARACTERISTICS (Cont.)

At $T_A = +25^\circ\text{C}$, $V_S = +1.8\text{V}$ to $+5.5\text{V}$, $R_{PULL-UP} = 10\text{k}\Omega$, and Input Overdrive = 100mV , unless otherwise noted.

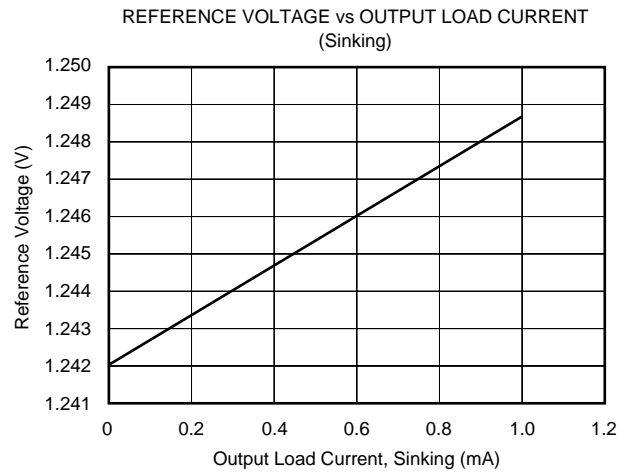
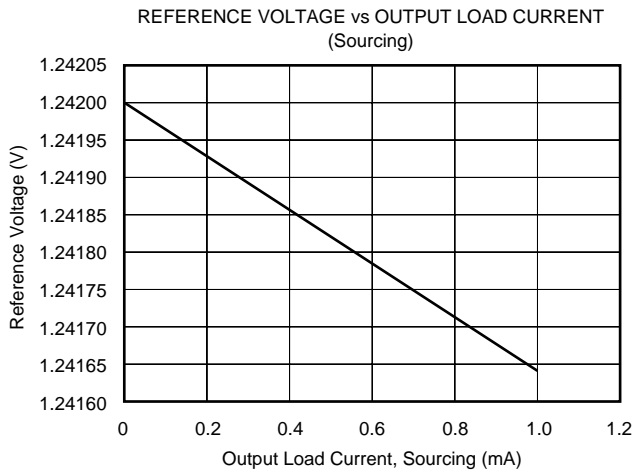
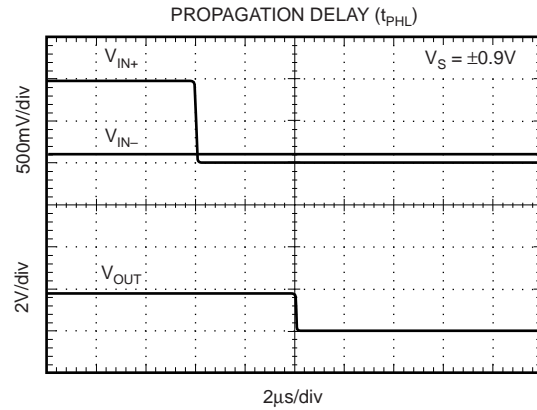
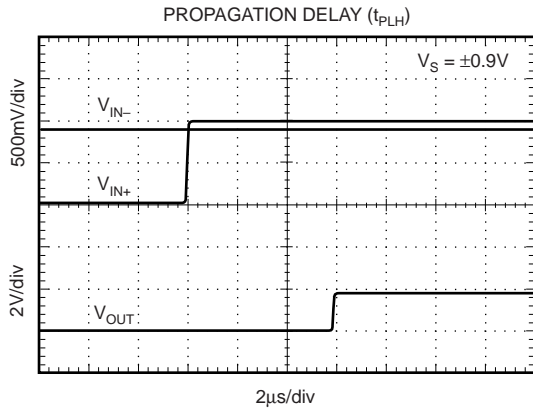
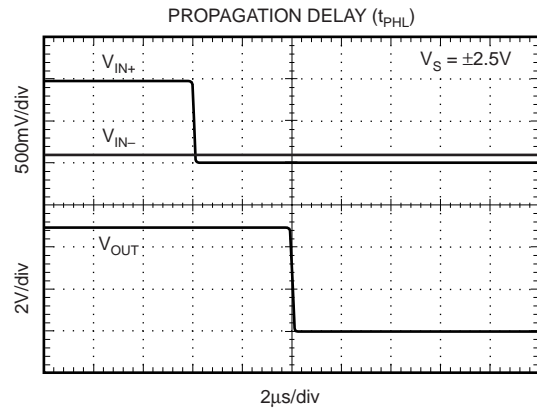
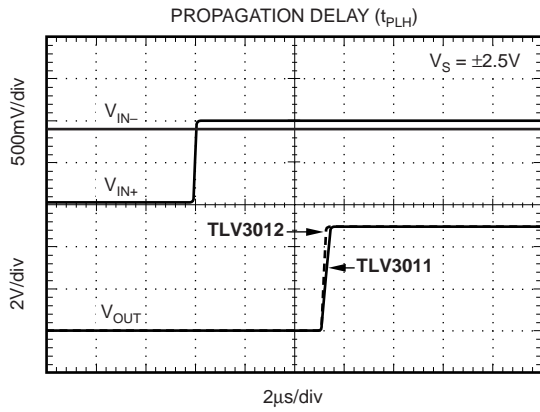

TYPICAL CHARACTERISTICS (Cont.)

At $T_A = +25^\circ\text{C}$, $V_S = +1.8\text{V}$ to $+5.5\text{V}$, $R_{\text{PULL-UP}} = 10\text{k}\Omega$, and Input Overdrive = 100mV , unless otherwise noted.

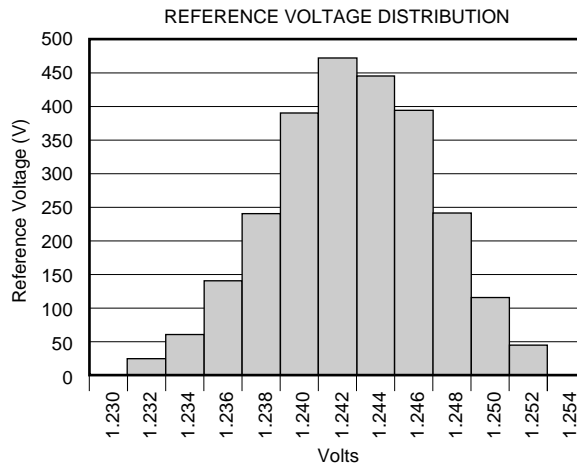
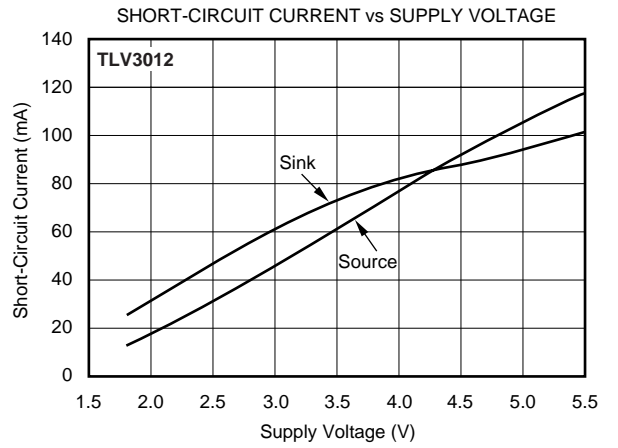
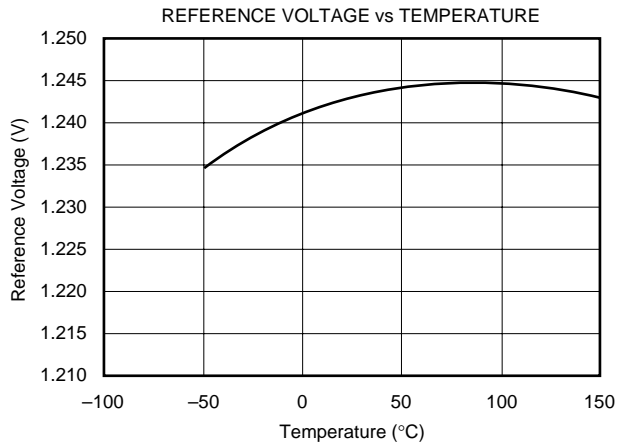

APPLICATIONS INFORMATION

The TLV3011 is a low-power, open-drain comparator with on-chip 1.242V series reference. The open-drain output allows multiple devices to be driven by a single pull-up resistor to accomplish an OR function, making the TLV3011 useful for logic applications.

The TLV3012 comparator with on-chip 1.242V series reference has a push-pull output stage optimal for reduced power budget applications and features no shoot-through current.

A typical supply current of 2.8µA and tiny packaging combine with 1.8V supply requirements to make the TLV3011 and TLV3012 optimal for battery and portable designs.

BOARD LAYOUT

Typical connections for the TLV3011 and TLV3012 are shown in Figure 1. The TLV3011 is an open-drain output device. A pull-up resistor must be connected between the comparator output and supply to enable operation.

To minimize supply noise, power supplies should be capacitively decoupled by a 0.01µF ceramic capacitor in parallel with a 10µF electrolytic capacitor. Comparators are sensitive to input noise, and precautions such as proper grounding (use of ground plane), supply bypassing, and guarding of high-impedance nodes will minimize the effects of noise and help to ensure specified performance.

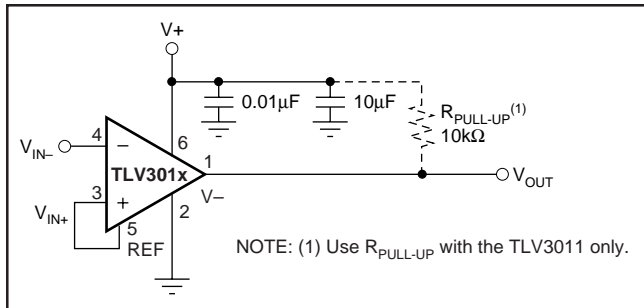

FIGURE 1. Basic Connections of the TLV3011 and TLV3012.

OPEN-DRAIN OUTPUT (TLV3011)

The open-drain output of the TLV3011 is useful in logic applications. The value of the pull-up resistor and supply voltage used will affect current consumption due to additional current drawn when the output is in a low state. This effect can be seen in the typical curve *Quiescent Current vs Output Switching Frequency*.

EXTERNAL HYSTERESIS

Comparator inputs have no noise immunity within the range of specified offset voltage ($\pm 12\text{mV}$). For noisy input signals, the comparator output may display multiple switching as input signals move through the switching threshold. The typical comparator threshold of the TLV3011 and TLV3012 is $\pm 0.5\text{mV}$. To prevent multiple switching within the comparator threshold of the TLV3011 or TLV3012, external hysteresis

may be added by connecting a small amount of feedback to the positive input. Figure 2 shows a typical topology used to introduce hysteresis, described by the equation:

$$V_{\text{HYST}} = \frac{V^+ \times R_1}{R_1 + R_2}$$

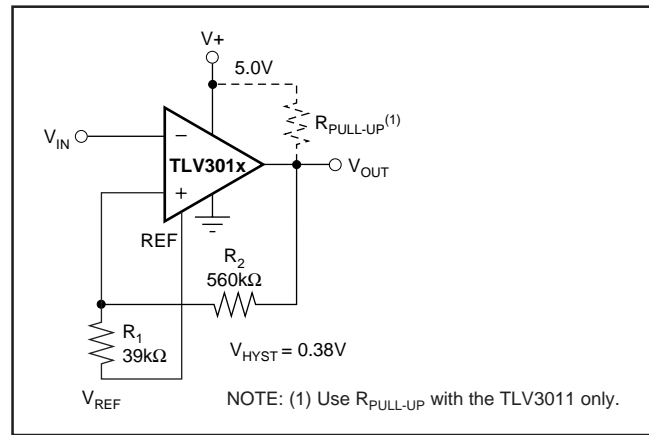

FIGURE 2. Adding Hysteresis.

V_{HYST} will set the value of the transition voltage required to switch the comparator output by increasing the threshold region, thereby reducing sensitivity to noise.

APPLICATIONS

BATTERY LEVEL DETECT

The low power consumption and 1.8V supply voltage of the TLV3011 make it an excellent candidate for battery-powered applications. Figure 3 shows the TLV3011 configured as a low battery level detector for a 3V battery.

$$\text{Battery-Okay Trip Voltage} = 1.242 \frac{R_1 + R_2}{R_2}$$

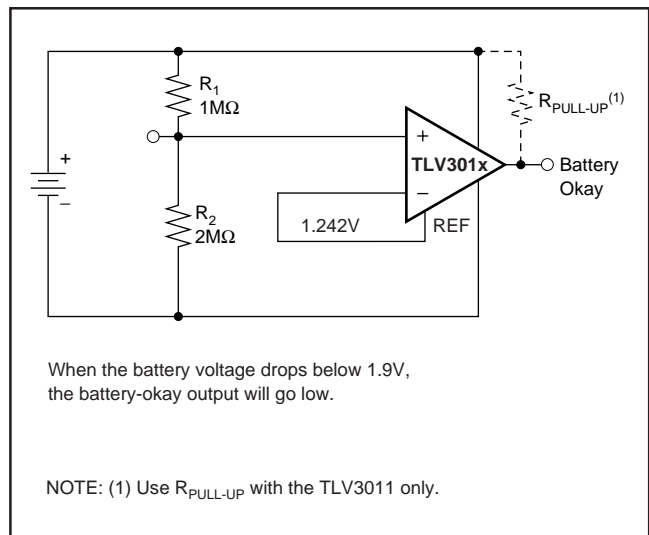

FIGURE 3. TLV3011 Configured as a Low Battery Level Detector.

POWER-ON RESET

The reset circuit shown in Figure 4 provides a time delayed release of reset to the MSP430 microcontroller. Operation of the circuit is based on a stabilization time constant of the supply voltage, rather than on a predetermined voltage value. The negative input is a reference voltage created by the internal voltage reference. The positive input is an RC circuit that provides a power-up delay. When power is applied, the output of the comparator is low, holding the processor in the reset condition. Only after allowing time for the supply voltage to stabilize does the positive input of the comparator become higher than the negative input, resulting in a high output state, releasing the processor for operation. The stabilization time required for the supply voltage is adjustable by the selection of the RC component values. Use of a lower-valued resistor in this portion of the circuit will not increase current consumption because no current flows through the RC circuit after the supply has stabilized.

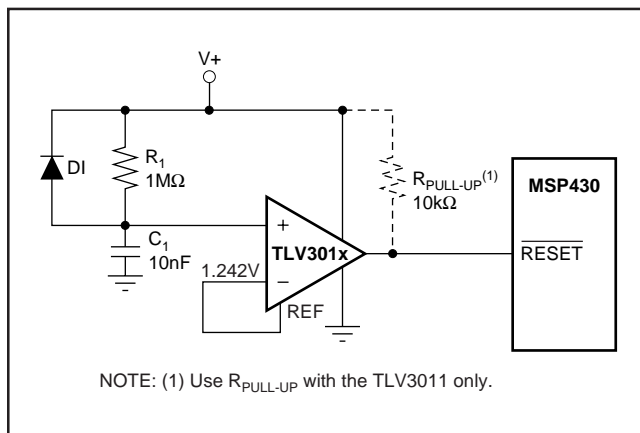

FIGURE 4. The TLV3011 or TLV3012 Configured as a Power Up Reset Circuit for the MSP430.

The reset delay needed depends on the power-up characteristics of the system power supply. R_1 and C_1 are selected to allow enough time for the power supply to stabilize. D_1 provides rapid reset if power is lost. In this example, the $R_1 \cdot C_1$ time constant is 10mS.

RELAXATION OSCILLATOR

The TLV3012 can be configured as a relaxation oscillator as in Figure 5 to provide a simple and inexpensive clock output. The capacitor is charged at a rate of $T = 0.69RC$. It also discharges at a rate of $0.69RC$. Therefore, the period is $T = 1.38RC$. R_1 may be a different value than R_2 .

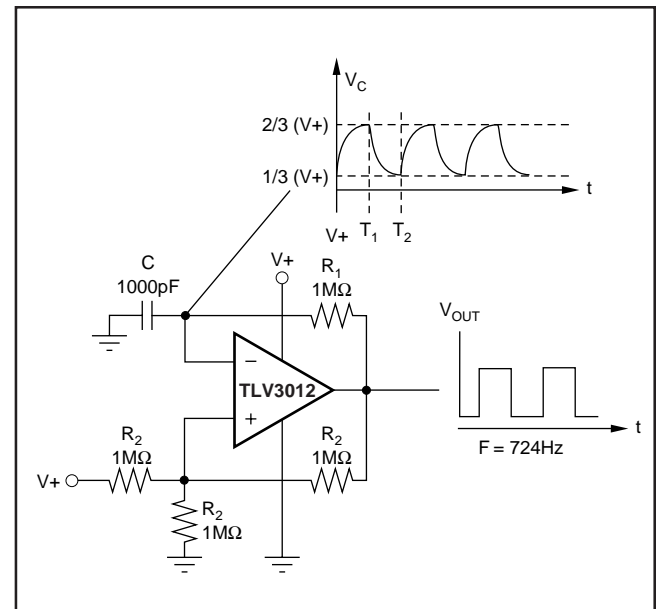

FIGURE 5. TLV3012 Configured as a Relaxation Oscillator.

PACKAGING INFORMATION

Orderable Device	Status (1)	Package Type	Package Drawing	Pins	Package Qty	Eco Plan (2)	Lead/Ball Finish (6)	MSL Peak Temp (3)	Op Temp (°C)	Device Marking (4/5)	Samples
TLV3011AIDBVR	ACTIVE	SOT-23	DBV	6	3000	Green (RoHS & no Sb/Br)	CU NIPDAU	Level-2-260C-1 YEAR	-40 to 125	ALR	Samples
TLV3011AIDBVRG4	ACTIVE	SOT-23	DBV	6	3000	Green (RoHS & no Sb/Br)	CU NIPDAU	Level-2-260C-1 YEAR	-40 to 125	ALR	Samples
TLV3011AIDBVT	ACTIVE	SOT-23	DBV	6	250	Green (RoHS & no Sb/Br)	CU NIPDAU	Level-2-260C-1 YEAR	-40 to 125	ALR	Samples
TLV3011AIDBVTG4	ACTIVE	SOT-23	DBV	6	250	Green (RoHS & no Sb/Br)	CU NIPDAU	Level-2-260C-1 YEAR	-40 to 125	ALR	Samples
TLV3011AIDCKR	ACTIVE	SC70	DCK	6	3000	Green (RoHS & no Sb/Br)	CU NIPDAU	Level-1-260C-UNLIM	-40 to 125	AJX	Samples
TLV3011AIDCKRG4	ACTIVE	SC70	DCK	6	3000	Green (RoHS & no Sb/Br)	CU NIPDAU	Level-1-260C-UNLIM	-40 to 125	AJX	Samples
TLV3011AIDCKT	ACTIVE	SC70	DCK	6	250	Green (RoHS & no Sb/Br)	CU NIPDAU	Level-1-260C-UNLIM	-40 to 125	AJX	Samples
TLV3011AIDCKTG4	ACTIVE	SC70	DCK	6	250	Green (RoHS & no Sb/Br)	CU NIPDAU	Level-1-260C-UNLIM	-40 to 125	AJX	Samples
TLV3012AIDBVR	ACTIVE	SOT-23	DBV	6	3000	Green (RoHS & no Sb/Br)	CU NIPDAU	Level-2-260C-1 YEAR	-40 to 85	ALS	Samples
TLV3012AIDBVRG4	ACTIVE	SOT-23	DBV	6	3000	Green (RoHS & no Sb/Br)	CU NIPDAU	Level-2-260C-1 YEAR	-40 to 85	ALS	Samples
TLV3012AIDBVT	ACTIVE	SOT-23	DBV	6	250	Green (RoHS & no Sb/Br)	CU NIPDAU	Level-2-260C-1 YEAR	-40 to 85	ALS	Samples
TLV3012AIDBVTG4	ACTIVE	SOT-23	DBV	6	250	Green (RoHS & no Sb/Br)	CU NIPDAU	Level-2-260C-1 YEAR	-40 to 85	ALS	Samples
TLV3012AIDCKR	ACTIVE	SC70	DCK	6	3000	Green (RoHS & no Sb/Br)	CU NIPDAU	Level-1-260C-UNLIM	-40 to 85	ALT	Samples
TLV3012AIDCKRG4	ACTIVE	SC70	DCK	6	3000	Green (RoHS & no Sb/Br)	CU NIPDAU	Level-1-260C-UNLIM	-40 to 85	ALT	Samples
TLV3012AIDCKT	ACTIVE	SC70	DCK	6	250	Green (RoHS & no Sb/Br)	CU NIPDAU	Level-1-260C-UNLIM	-40 to 85	ALT	Samples

(1) The marketing status values are defined as follows:

ACTIVE: Product device recommended for new designs.

LIFEBUY: TI has announced that the device will be discontinued, and a lifetime-buy period is in effect.

NRND: Not recommended for new designs. Device is in production to support existing customers, but TI does not recommend using this part in a new design.

PREVIEW: Device has been announced but is not in production. Samples may or may not be available.

OBSOLETE: TI has discontinued the production of the device.

⁽²⁾ **RoHS:** TI defines "RoHS" to mean semiconductor products that are compliant with the current EU RoHS requirements for all 10 RoHS substances, including the requirement that RoHS substance do not exceed 0.1% by weight in homogeneous materials. Where designed to be soldered at high temperatures, "RoHS" products are suitable for use in specified lead-free processes. TI may reference these types of products as "Pb-Free".

RoHS Exempt: TI defines "RoHS Exempt" to mean products that contain lead but are compliant with EU RoHS pursuant to a specific EU RoHS exemption.

Green: TI defines "Green" to mean the content of Chlorine (Cl) and Bromine (Br) based flame retardants meet JS709B low halogen requirements of <=1000ppm threshold. Antimony trioxide based flame retardants must also meet the <=1000ppm threshold requirement.

⁽³⁾ MSL, Peak Temp. - The Moisture Sensitivity Level rating according to the JEDEC industry standard classifications, and peak solder temperature.

⁽⁴⁾ There may be additional marking, which relates to the logo, the lot trace code information, or the environmental category on the device.

⁽⁵⁾ Multiple Device Markings will be inside parentheses. Only one Device Marking contained in parentheses and separated by a "~" will appear on a device. If a line is indented then it is a continuation of the previous line and the two combined represent the entire Device Marking for that device.

⁽⁶⁾ Lead/Ball Finish - Orderable Devices may have multiple material finish options. Finish options are separated by a vertical ruled line. Lead/Ball Finish values may wrap to two lines if the finish value exceeds the maximum column width.

Important Information and Disclaimer: The information provided on this page represents TI's knowledge and belief as of the date that it is provided. TI bases its knowledge and belief on information provided by third parties, and makes no representation or warranty as to the accuracy of such information. Efforts are underway to better integrate information from third parties. TI has taken and continues to take reasonable steps to provide representative and accurate information but may not have conducted destructive testing or chemical analysis on incoming materials and chemicals. TI and TI suppliers consider certain information to be proprietary, and thus CAS numbers and other limited information may not be available for release.

In no event shall TI's liability arising out of such information exceed the total purchase price of the TI part(s) at issue in this document sold by TI to Customer on an annual basis.

OTHER QUALIFIED VERSIONS OF TLV3011, TLV3012 :

● Automotive: [TLV3012-Q1](#)

● Enhanced Product: [TLV3011-EP](#)

NOTE: Qualified Version Definitions:

● Automotive - Q100 devices qualified for high-reliability automotive applications targeting zero defects

● Enhanced Product - Supports Defense, Aerospace and Medical Applications

TAPE AND REEL INFORMATION



QUADRANT ASSIGNMENTS FOR PIN 1 ORIENTATION IN TAPE



*All dimensions are nominal

Device	Package Type	Package Drawing	Pins	SPQ	Reel Diameter (mm)	Reel Width W1 (mm)	A0 (mm)	B0 (mm)	K0 (mm)	P1 (mm)	W (mm)	Pin1 Quadrant
TLV3011AIDBVR	SOT-23	DBV	6	3000	178.0	9.0	3.23	3.17	1.37	4.0	8.0	Q3
TLV3011AIDBVT	SOT-23	DBV	6	250	178.0	9.0	3.23	3.17	1.37	4.0	8.0	Q3
TLV3011AIDCKR	SC70	DCK	6	3000	178.0	9.0	2.4	2.5	1.2	4.0	8.0	Q3
TLV3011AIDCKT	SC70	DCK	6	250	178.0	9.0	2.4	2.5	1.2	4.0	8.0	Q3
TLV3012AIDBVR	SOT-23	DBV	6	3000	178.0	9.0	3.23	3.17	1.37	4.0	8.0	Q3
TLV3012AIDBVT	SOT-23	DBV	6	250	178.0	9.0	3.23	3.17	1.37	4.0	8.0	Q3
TLV3012AIDCKR	SC70	DCK	6	3000	178.0	9.0	2.4	2.5	1.2	4.0	8.0	Q3
TLV3012AIDCKT	SC70	DCK	6	250	178.0	9.0	2.4	2.5	1.2	4.0	8.0	Q3

TAPE AND REEL BOX DIMENSIONS

*All dimensions are nominal

Device	Package Type	Package Drawing	Pins	SPQ	Length (mm)	Width (mm)	Height (mm)
TLV3011AIDBVR	SOT-23	DBV	6	3000	180.0	180.0	18.0
TLV3011AIDBVT	SOT-23	DBV	6	250	180.0	180.0	18.0
TLV3011AIDCKR	SC70	DCK	6	3000	180.0	180.0	18.0
TLV3011AIDCKT	SC70	DCK	6	250	180.0	180.0	18.0
TLV3012AIDBVR	SOT-23	DBV	6	3000	180.0	180.0	18.0
TLV3012AIDBVT	SOT-23	DBV	6	250	180.0	180.0	18.0
TLV3012AIDCKR	SC70	DCK	6	3000	180.0	180.0	18.0
TLV3012AIDCKT	SC70	DCK	6	250	180.0	180.0	18.0

DCK (R-PDSO-G6)

PLASTIC SMALL-OUTLINE PACKAGE



- NOTES:
- A. All linear dimensions are in millimeters.
 - B. This drawing is subject to change without notice.
 - C. Body dimensions do not include mold flash or protrusion. Mold flash and protrusion shall not exceed 0.15 per side.
 - D. Falls within JEDEC MO-203 variation AB.

DCK (R-PDSO-G6)

PLASTIC SMALL OUTLINE



- NOTES:
- All linear dimensions are in millimeters.
 - This drawing is subject to change without notice.
 - Customers should place a note on the circuit board fabrication drawing not to alter the center solder mask defined pad.
 - Publication IPC-7351 is recommended for alternate designs.
 - Laser cutting apertures with trapezoidal walls and also rounding corners will offer better paste release. Customers should contact their board assembly site for stencil design recommendations. Example stencil design based on a 50% volumetric metal load solder paste. Refer to IPC-7525 for other stencil recommendations.

DBV0006A



PACKAGE OUTLINE

SOT-23 - 1.45 mm max height

SMALL OUTLINE TRANSISTOR



4214840/B 03/2018

NOTES:

1. All linear dimensions are in millimeters. Any dimensions in parenthesis are for reference only. Dimensioning and tolerancing per ASME Y14.5M.
2. This drawing is subject to change without notice.
3. Body dimensions do not include mold flash or protrusion. Mold flash and protrusion shall not exceed 0.15 per side.
4. Leads 1,2,3 may be wider than leads 4,5,6 for package orientation.
5. Reference JEDEC MO-178.

EXAMPLE BOARD LAYOUT

DBV0006A

SOT-23 - 1.45 mm max height

SMALL OUTLINE TRANSISTOR



LAND PATTERN EXAMPLE
EXPOSED METAL SHOWN
SCALE:15X

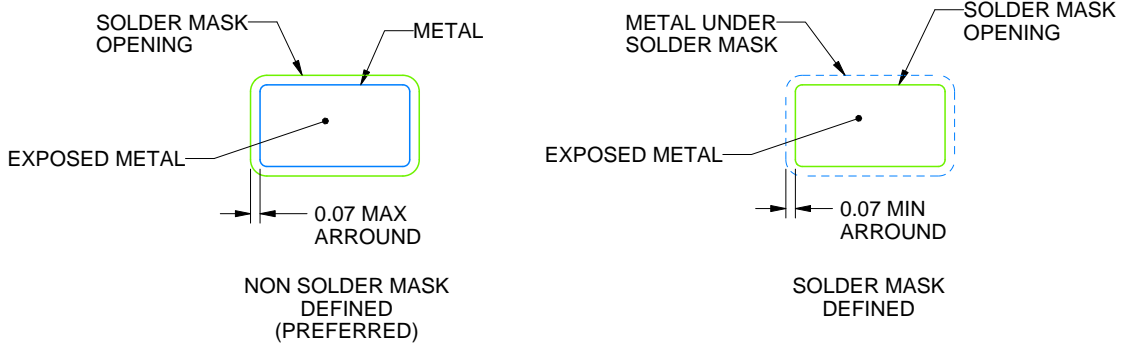

SOLDER MASK DETAILS

4214840/B 03/2018

NOTES: (continued)

- 6. Publication IPC-7351 may have alternate designs.
- 7. Solder mask tolerances between and around signal pads can vary based on board fabrication site.

EXAMPLE STENCIL DESIGN

DBV0006A

SOT-23 - 1.45 mm max height

SMALL OUTLINE TRANSISTOR



SOLDER PASTE EXAMPLE
BASED ON 0.125 mm THICK STENCIL
SCALE:15X

4214840/B 03/2018

NOTES: (continued)

8. Laser cutting apertures with trapezoidal walls and rounded corners may offer better paste release. IPC-7525 may have alternate design recommendations.
9. Board assembly site may have different recommendations for stencil design.

IMPORTANT NOTICE AND DISCLAIMER

TI PROVIDES TECHNICAL AND RELIABILITY DATA (INCLUDING DATASHEETS), DESIGN RESOURCES (INCLUDING REFERENCE DESIGNS), APPLICATION OR OTHER DESIGN ADVICE, WEB TOOLS, SAFETY INFORMATION, AND OTHER RESOURCES "AS IS" AND WITH ALL FAULTS, AND DISCLAIMS ALL WARRANTIES, EXPRESS AND IMPLIED, INCLUDING WITHOUT LIMITATION ANY IMPLIED WARRANTIES OF MERCHANTABILITY, FITNESS FOR A PARTICULAR PURPOSE OR NON-INFRINGEMENT OF THIRD PARTY INTELLECTUAL PROPERTY RIGHTS.

These resources are intended for skilled developers designing with TI products. You are solely responsible for (1) selecting the appropriate TI products for your application, (2) designing, validating and testing your application, and (3) ensuring your application meets applicable standards, and any other safety, security, or other requirements. These resources are subject to change without notice. TI grants you permission to use these resources only for development of an application that uses the TI products described in the resource. Other reproduction and display of these resources is prohibited. No license is granted to any other TI intellectual property right or to any third party intellectual property right. TI disclaims responsibility for, and you will fully indemnify TI and its representatives against, any claims, damages, costs, losses, and liabilities arising out of your use of these resources.

TI's products are provided subject to TI's Terms of Sale (www.ti.com/legal/termsofsale.html) or other applicable terms available either on ti.com or provided in conjunction with such TI products. TI's provision of these resources does not expand or otherwise alter TI's applicable warranties or warranty disclaimers for TI products.

Mailing Address: Texas Instruments, Post Office Box 655303, Dallas, Texas 75265
Copyright © 2019, Texas Instruments Incorporated