

TPS74901 3-A, Low Dropout Linear Regulator With Programmable Soft-Start

1 Features

- V_{OUT} range: 0.8 V to 3.6 V
- Ultra-low V_{IN} range: 0.8 V to 5.5 V
- V_{BIAS} range: 2.7 V to 5.5 V
- Low dropout: 120 mV (typical) at 3 A
- Power-good (PG) output allows supply monitoring or provides a sequencing signal for other supplies
- Accuracy over line, load, and temperature: 2%
- Adjustable start-up in-rush control
- V_{BIAS} permits low V_{IN} operation with good transient response
- Stable with any output capacitor $\geq 2.2 \mu\text{F}$
- Packages:
 - Small, 3-mm \times 3-mm \times 1-mm VSON
 - 5-mm \times 5-mm \times 1-mm VQFN and DDPAK-7
- Active high enable

2 Applications

- [Network attached storage - enterprise](#)
- [Rack servers](#)
- [Network interface cards \(NIC\)](#)
- [Merchant network and server PSU](#)

3 Description

The TPS74901 low-dropout (LDO) linear regulator provides an easy-to-use, robust power management solution for a wide variety of applications. User-programmable soft-start minimizes stress on the input power source by reducing capacitive inrush current during start-up. The soft-start is monotonic and designed for powering many different types of processors and application-specific integrated circuits (ASICs). The enable input and power-good output allow easy sequencing with external regulators. This complete flexibility allows a solution to be configured that meets the sequencing requirements of field-programmable gate arrays (FPGAs), digital signal processors (DSPs), and other applications with special start-up requirements.

A precision reference and error amplifier deliver 2% accuracy over load, line, temperature, and process. The device is stable with any type of capacitor $\geq 2.2 \mu\text{F}$, and the device is fully specified from -40°C to $+125^\circ\text{C}$. The TPS74901 is offered in a small (3 mm \times 3 mm) VSON package and a small (5-mm \times 5-mm) VQFN package, yielding a highly compact total solution size. The device is also available in a DDPAK-7 package.

Package Information

| PART NUMBER | PACKAGE ⁽¹⁾ | BODY SIZE (NOM) |
|-------------|------------------------|---------------------------|
| TPS74901 | RGW (VQFN, 20) | 5.00 mm \times 5.00 mm |
| | KTW (DDPAK/TO-263, 7) | 8.89 mm \times 10.10 mm |
| | DRC (VSON, 10) | 3.00 mm \times 3.00 mm |

- (1) For all available packages, see the orderable addendum at the end of the data sheet.

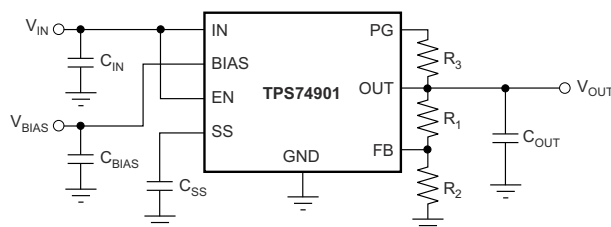

Typical Application Circuit (Adjustable)

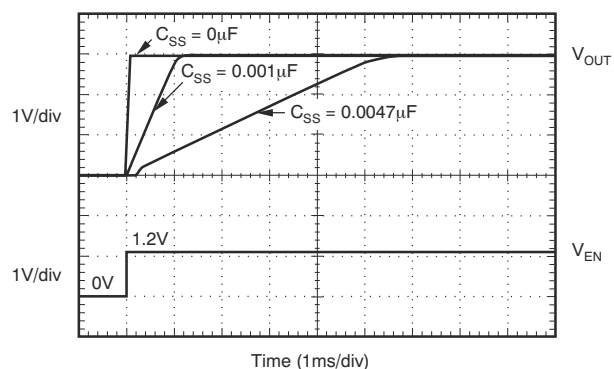

Turn-On Response



Table of Contents

| | | | |
|--|----------|--|-----------|
| 1 Features | 1 | 7 Detailed Description | 17 |
| 2 Applications | 1 | 7.1 Overview..... | 17 |
| 3 Description | 1 | 7.2 Functional Block Diagram..... | 17 |
| 4 Revision History | 2 | 7.3 Feature Description..... | 18 |
| 5 Pin Configuration and Functions | 3 | 7.4 Device Functional Modes..... | 19 |
| 6 Specifications | 4 | 8 Application and Implementation | 20 |
| 6.1 Absolute Maximum Ratings..... | 4 | 8.1 Application Information..... | 20 |
| 6.2 ESD Ratings..... | 4 | 8.2 Typical Application..... | 24 |
| 6.3 Recommended Operating Conditions..... | 4 | 8.3 Power Supply Recommendations..... | 25 |
| 6.4 Thermal Information..... | 5 | 8.4 Layout..... | 25 |
| 6.5 Electrical Characteristics: Other Orderable Devices (non-M3 Suffix)..... | 6 | 9 Device and Documentation Support | 30 |
| 6.6 Electrical Characteristics: Orderable Device (M3 Suffix)..... | 7 | 9.1 Device Support..... | 30 |
| 6.7 Typical Characteristics: I _{OUT} = 50 mA (All Other Orderable Devices, Non-M3 Suffix)..... | 8 | 9.2 Documentation Support..... | 30 |
| 6.8 Typical Characteristics: I _{OUT} = 1 A (All Other Orderable Devices, Non-M3 Suffix)..... | 11 | 9.3 Receiving Notification of Documentation Updates.... | 30 |
| 6.9 Typical Characteristics: I _{OUT} = 50 mA (M3 Suffix).... | 12 | 9.4 Support Resources..... | 30 |
| 6.10 Typical Characteristics: I _{OUT} = 1 A (M3 Suffix)..... | 16 | 9.5 Trademarks..... | 30 |
| | | 9.6 Electrostatic Discharge Caution..... | 30 |
| | | 9.7 Glossary..... | 30 |
| | | 10 Mechanical, Packaging, and Orderable Information | 31 |

4 Revision History

NOTE: Page numbers for previous revisions may differ from page numbers in the current version.

| Changes from Revision I (May 2016) to Revision J (April 2023) | Page |
|--|-------------|
| • Updated the numbering format for tables, figures, and cross-references throughout the document | 1 |
| • Added M3-suffix devices to document..... | 1 |
| • Added links to <i>Applications</i> section..... | 1 |
| • Added M3 suffix <i>Typical Characteristics</i> sections..... | 12 |
| Changes from Revision H (November 2015) to Revision I (May 2016) | Page |
| • Added DRC package to document | 1 |
| • Changed <i>Packages</i> Features bullet | 1 |
| • Added DRC package to <i>Description</i> section..... | 1 |
| • Added DRC (VSON) package to <i>Device Information</i> table..... | 1 |
| • Added DRC package to <i>Pin Configuration and Functions</i> section..... | 3 |

5 Pin Configuration and Functions

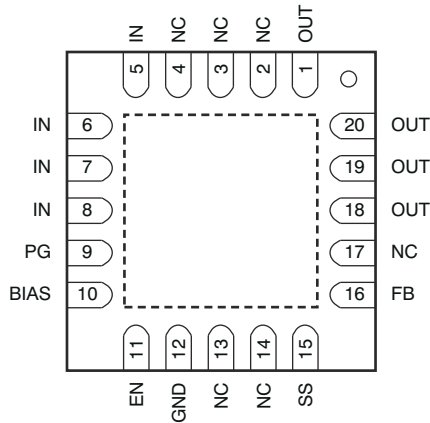

Figure 5-1. RGW Package, 20-Pin VQFN (Top View)

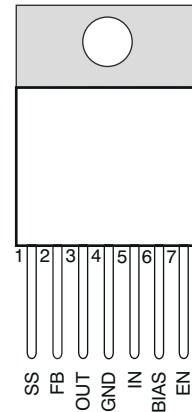

Figure 5-2. KTW Package, 7-Pin DDPACK/TO-263 (Top View)

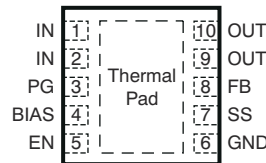

Figure 5-3. DRC Package, 10-Pin VSON With Thermal Pad (Top View)

Table 5-1. Pin Functions

| NAME | PIN | | | TYPE | DESCRIPTION |
|-------------|--------------|---------------------|-------|------|---|
| | DDPAK/TO-263 | VQFN | VSON | | |
| BIAS | 6 | 10 | 4 | I | Bias input voltage for error amplifier, reference, and internal control circuits. |
| EN | 7 | 11 | 5 | I | Enable pin. Driving this pin high enables the regulator. Driving this pin low puts the regulator into shutdown mode. This pin must not be left floating. |
| FB | 2 | 16 | 8 | I | This pin is the feedback connection to the center tap of an external resistor divider network that sets the output voltage. This pin must not be left floating. |
| GND | 4 | 12 | 6 | — | Ground |
| IN | 5 | 5, 6, 7, 8 | 1, 2 | I | Unregulated input to the device. |
| NC | — | 2, 3, 4, 13, 14, 17 | — | — | No connection. This pin can be left floating or connected to GND to allow better thermal contact to the top-side plane. |
| OUT | 3 | 1, 18, 19, 20 | 9, 10 | O | Regulated output voltage. A small capacitor (total typical capacitance $\geq 2.2 \mu\text{F}$, ceramic) is needed from this pin to ground to assure stability. |
| PG | — | 9 | 3 | O | Power-good (PG) is an open-drain, active-high output that indicates the status of V_{OUT} . When V_{OUT} exceeds the PG trip threshold, the PG pin goes into a high-impedance state. When V_{OUT} is below this threshold the pin is driven to a low-impedance state. A pullup resistor from 10 k Ω to 1 M Ω must be connected from this pin to a supply up to 5.5 V. The supply can be higher than the input voltage. Alternatively, the PG pin can be left floating if output monitoring is not necessary. |
| SS | 1 | 15 | 7 | — | Soft-start pin. A capacitor connected on this pin to ground sets the start-up time. If this pin is left floating, the regulator output soft-start ramp time is typically 100 μs . |
| Thermal Pad | — | — | — | — | Solder to the ground plane for increased thermal performance. |

6 Specifications

6.1 Absolute Maximum Ratings

over operating temperature range (unless otherwise noted)⁽¹⁾

| | | MIN | MAX | UNIT |
|-------------------------------------|------------------------------------|-------------------------|-----------------------|------|
| V _{IN} , V _{BIAS} | Input voltage | -0.3 | 6 | V |
| V _{EN} | Enable voltage | -0.3 | 6 | V |
| V _{PG} | Power good voltage | -0.3 | 6 | V |
| I _{PG} | PG sink current | 0 | 1.5 | mA |
| V _{SS} | Soft-start voltage | -0.3 | 6 | V |
| V _{FB} | Feedback voltage | -0.3 | 6 | V |
| V _{OUT} | Output voltage | -0.3 | V _{IN} + 0.3 | V |
| I _{OUT} | Maximum output current | Internally limited | | |
| | Output short-circuit duration | Indefinite | | |
| P _{DISS} | Continuous total power dissipation | See Thermal Information | | |
| T _J | Junction Temperature | -40 | 150 | °C |
| T _{stg} | Storage Temperature | -55 | 150 | |

- (1) Stresses beyond those listed under Absolute Maximum Ratings may cause permanent damage to the device. These are stress ratings only, which do not imply functional operation of the device at these or any other conditions beyond those indicated under Recommended Operating Conditions. Exposure to absolute-maximum-rated conditions for extended periods may affect device reliability.

6.2 ESD Ratings

| | | VALUE | UNIT |
|--------------------|-------------------------|--|-------|
| V _(ESD) | Electrostatic discharge | Human body model (HBM), per ANSI/ESDA/JEDEC JS-001, all pins ⁽¹⁾ | ±2000 |
| | | Charged device model (CDM), per JEDEC specification JESD22-C101, all pins ⁽²⁾ | ±500 |

- (1) JEDEC document JEP155 states that 500-V HBM allows safe manufacturing with a standard ESD control process.
 (2) JEDEC document JEP157 states that 250-V CDM allows safe manufacturing with a standard ESD control process.

6.3 Recommended Operating Conditions

over operating free-air temperature range (unless otherwise noted)

| | | MIN | NOM | MAX | UNIT |
|----------------------------------|--------------------------------|---|-----|-----|------|
| V _{IN} | Input supply voltage | V _{OUT} + V _{DO} (V _{IN}) | | 5.5 | V |
| V _{EN} | Enable supply voltage | | | 5.5 | V |
| V _{BIAS} ⁽¹⁾ | BIAS supply voltage | V _{OUT} + V _{DO} (V _{BIAS}) ⁽²⁾ | | 5.5 | V |
| V _{OUT} | Output voltage | 0.8 | | 3.6 | V |
| I _{OUT} | Output current | 0 | | 3 | A |
| C _{OUT} | Output capacitor | 2.2 | | | μF |
| C _{IN} | Input capacitor ⁽³⁾ | 1 | | | μF |
| C _{BIAS} | Bias capacitor | 0.1 | 1 | | μF |
| T _J | Operating junction temperature | -40 | | 125 | °C |

- (1) BIAS supply is required when V_{IN} is below V_{OUT} + 1.62 V.
 (2) V_{BIAS} has a minimum voltage of 2.7 V or V_{OUT} + V_{DO} (V_{BIAS}), whichever is higher.
 (3) If V_{IN} and V_{BIAS} are connected to the same supply, the recommended minimum capacitor for the supply is 4.7 μF.

6.4 Thermal Information

| THERMAL METRIC ⁽¹⁾ | | TPS749 | | | | UNIT |
|-------------------------------|--|---------------|-----------------|------------|---------------------------|------|
| | | RGW (VQFN) | KTW (TO-263) | DRC (VSON) | DRC (VSON) (M3-Suffix) | |
| | | 20 PINS | 7 PINS | 10 PINS | 10 PINS | |
| R _{θJA} | Junction-to-ambient thermal resistance | 38.1 | 33.8 | 48.1 | 47.2 | °C/W |
| R _{θJC(top)} | Junction-to-case (top) thermal resistance | 36.3 | 35.9 | 60.3 | 63.7 | °C/W |
| R _{θJB} | Junction-to-board thermal resistance | 17.5 | 25 | 22.4 | 19.5 | °C/W |
| ψ _{JT} | Junction-to-top characterization parameter | 0.7 | 6 | 1.0 | 4.2 | °C/W |
| ψ _{JB} | Junction-to-board characterization parameter | 17.6 | 23.6 | 22.6 | 19.4 | °C/W |
| R _{θJC(bot)} | Junction-to-case (bottom) thermal resistance | 6.2 | N/A | 4.3 | 3.3 | °C/W |

- (1) For more information about traditional and new thermal metrics, see the [Semiconductor and IC package thermal metrics application report](#).

6.5 Electrical Characteristics: Other Orderable Devices (non-M3 Suffix)

at $V_{EN} = 1.1\text{ V}$, $V_{IN} = V_{OUT} + 0.3\text{ V}$, $C_{BIAS} = 0.1\text{ }\mu\text{F}$, $C_{IN} = C_{OUT} = 10\text{ }\mu\text{F}$, $C_{NR} = 1\text{ nF}$, $I_{OUT} = 50\text{ mA}$, $V_{BIAS} = 5.0\text{ V}$, and $T_J = -40^\circ\text{C}$ to 125°C , (unless otherwise noted); typical values are at $T_J = 25^\circ\text{C}$

| PARAMETER | | TEST CONDITIONS | MIN | TYP | MAX | UNIT |
|-----------------------------------|--|--|-----------|---------------------|-------|------------------|
| V_{REF} | Internal reference (Adj.) | $T_A = +25^\circ\text{C}$ | 0.798 | 0.802 | 0.806 | V |
| $\Delta V_{OUT} (\Delta V_{IN})$ | Output voltage range | $V_{IN} = 5\text{ V}$, $I_{OUT} = 3\text{ A}$ | V_{REF} | | 3.6 | V |
| | Accuracy (RGW & SON packages) ⁽¹⁾ | $V_{OUT} + 2.2\text{ V} \leq V_{BIAS} \leq 5.5\text{ V}$, $50\text{ mA} \leq I_{OUT} \leq 3\text{ A}$ | -2 | ± 0.5 | 2 | % |
| | Accuracy (KTW package) ⁽¹⁾ | $V_{OUT} + 2.4\text{ V} \leq V_{BIAS} \leq 5.5\text{ V}$, $50\text{ mA} \leq I_{OUT} \leq 3\text{ A}$ | -2 | ± 0.5 | 2 | % |
| $\Delta V_{OUT} (\Delta I_{OUT})$ | Line regulation | $V_{OUT(nom)} + 0.3 \leq V_{IN} \leq 5.5\text{ V}$ | | 0.03 | | %/V |
| V_{OUT} | Load regulation | $50\text{ mA} \leq I_{OUT} \leq 3\text{ A}$ | | 0.09 | | %/A |
| V_{DO} | V_{IN} dropout voltage ⁽²⁾ | $I_{OUT} = 3\text{ A}$, $V_{BIAS} - V_{OUT(nom)} \geq 3.25\text{ V}$ ⁽³⁾ | | 120 | 280 | mV |
| | V_{BIAS} dropout voltage ⁽²⁾ | $I_{OUT} = 3\text{ A}$, $V_{IN} = V_{BIAS}$ | | 1.31 | 1.75 | V |
| I_{CL} | Current limit | $V_{OUT} = 80\% \times V_{OUT(nom)}$, RGW Package | 3.9 | 4.6 | 5.5 | A |
| | | $V_{OUT} = 80\% \times V_{OUT(nom)}$, KTW Package | 3.8 | 4.6 | 5.5 | A |
| I_{BIAS} | BIAS pin current | | | 1 | 2 | mA |
| I_{SHDN} | Shutdown supply current (I_{GND}) | $V_{EN} \leq 0.4\text{ V}$ | | 1 | 50 | μA |
| I_{FB} | Feedback pin current | | -1 | 0.15 | 1 | μA |
| PSRR | Power-supply rejection (V_{IN} to V_{OUT}) | 1 kHz, $I_{OUT} = 1.5\text{ A}$, $V_{IN} = 1.8\text{ V}$, $V_{OUT} = 1.5\text{ V}$ | | 60 | | dB |
| | | 300 kHz, $I_{OUT} = 1.5\text{ A}$, $V_{IN} = 1.8\text{ V}$, $V_{OUT} = 1.5\text{ V}$ | | 30 | | dB |
| | Power-supply rejection (V_{BIAS} to V_{OUT}) | 1 kHz, $I_{OUT} = 1.5\text{ A}$, $V_{IN} = 1.8\text{ V}$, $V_{OUT} = 1.5\text{ V}$ | | 50 | | dB |
| | | 300 kHz, $I_{OUT} = 1.5\text{ A}$, $V_{IN} = 1.8\text{ V}$, $V_{OUT} = 1.5\text{ V}$ | | 30 | | dB |
| V_n | Output noise voltage | $\text{BW} = 100\text{ Hz to } 100\text{ kHz}$, $I_{OUT} = 3\text{ A}$, $C_{SS} = 1\text{ nF}$ | | $25 \times V_{OUT}$ | | μVrms |
| t_{STR} | Minimum start-up time | R_{LOAD} for $I_{OUT} = 1.0\text{ A}$, $C_{SS} = \text{open}$ | | 200 | | μs |
| I_{SS} | Soft-start charging current | $V_{SS} = 0.4\text{ V}$ | | 440 | | nA |
| $V_{EN(hi)}$ | Enable input high level | | 1.1 | | 5.5 | V |
| $V_{EN(lo)}$ | Enable input low level | | 0 | | 0.4 | V |
| $V_{EN(hys)}$ | Enable pin hysteresis | | | 50 | | mV |
| $V_{EN(dg)}$ | Enable pin deglitch time | | | 20 | | μs |
| I_{EN} | Enable pin current | $V_{EN} = 5\text{ V}$ | | 0.1 | 1 | μA |
| V_{IT} | PG trip threshold | V_{OUT} decreasing | 85 | 90 | 94 | $\%V_{OUT}$ |
| V_{HYS} | PG trip hysteresis | | | 3 | | $\%V_{OUT}$ |
| $V_{PG(lo)}$ | PG output low voltage | $I_{PG} = 1\text{ mA}$ (sinking), $V_{OUT} < V_{IT}$ | | | 0.3 | V |
| $I_{PG(lkg)}$ | PG leakage current | $V_{PG} = 5.25\text{ V}$, $V_{OUT} > V_{IT}$ | | 0.1 | 1 | μA |
| T_J | Operating junction temperature | | -40 | | 125 | $^\circ\text{C}$ |
| T_{SD} | Thermal shutdown temperature | Shutdown, temperature increasing | | 165 | | $^\circ\text{C}$ |
| | | Reset, temperature decreasing | | 140 | | $^\circ\text{C}$ |

- (1) Adjustable devices tested at 0.8 V; resistor tolerance is not taken into account.
 (2) Dropout is defined as the voltage from V_{IN} to V_{OUT} when V_{OUT} is 3% below nominal.
 (3) 3.25 V is a test condition of this device and can be adjusted by referring to Figure 6-6.

6.6 Electrical Characteristics: Orderable Device (M3 Suffix)

at $V_{EN} = 1.1\text{ V}$, $V_{IN} = V_{OUT} + 0.3\text{ V}$, $C_{BIAS} = 0.1\text{ }\mu\text{F}$, $C_{IN} = C_{OUT} = 10\text{ }\mu\text{F}$, $C_{NR} = 1\text{ nF}$, $I_{OUT} = 50\text{ mA}$, $V_{BIAS} = 5.0\text{ V}$, and $T_J = -40^\circ\text{C}$ to 125°C , (unless otherwise noted); typical values are at $T_J = 25^\circ\text{C}$

| PARAMETER | | TEST CONDITIONS | MIN | TYP | MAX | UNIT |
|-----------------------------------|--|--|-----------|-----------|-------|---------------------------------|
| V_{REF} | Internal reference (Adj.) | $T_A = +25^\circ\text{C}$ | 0.796 | 0.8 | 0.804 | V |
| V_{OUT} | Output voltage range | $V_{IN} = 5\text{ V}$, $I_{OUT} = 3\text{ A}$ | V_{REF} | | 3.6 | V |
| | Accuracy ⁽¹⁾ | $V_{OUT} + 2.2\text{ V} \leq V_{BIAS} \leq 5.5\text{ V}$, $50\text{ mA} \leq I_{OUT} \leq 3\text{ A}$ | -1 | ± 0.3 | 1 | % |
| $\Delta V_{OUT} (\Delta V_{IN})$ | Line regulation | $V_{OUT(nom)} + 0.3 \leq V_{IN} \leq 5.5\text{ V}$ | | 0.001 | | %/V |
| $\Delta V_{OUT} (\Delta I_{OUT})$ | Load regulation | $50\text{ mA} \leq I_{OUT} \leq 3\text{ A}$ | | 0.09 | | %/A |
| V_{DO} | V_{IN} dropout voltage ⁽²⁾ | $I_{OUT} = 3\text{ A}$, $V_{BIAS} - V_{OUT(nom)} \geq 3.25\text{ V}^{(3)}$ | | 120 | 200 | mV |
| | V_{BIAS} dropout voltage ⁽²⁾ | $I_{OUT} = 3\text{ A}$, $V_{IN} = V_{BIAS}$ | | 1.45 | 1.6 | V |
| I_{CL} | Output current limit | $V_{OUT} = 80\% \times V_{OUT(nom)}$ | 3.9 | | 5.5 | A |
| I_{BIAS} | BIAS pin current | | | 1 | 1.2 | mA |
| I_{SHDN} (smart enable) | Shutdown supply current (I_{GND}) | $V_{EN} \leq 0.4\text{ V}$, $V_{IN} = V_{BIAS} = 5.5\text{ V}$ | | 0.85 | 2.75 | μA |
| I_{FB} | Feedback pin current | | -30 | 0.15 | 30 | nA |
| PSRR | Power-supply rejection (V_{IN} to V_{OUT}) | 1 kHz, $I_{OUT} = 1.5\text{ A}$, $V_{IN} = 1.8\text{ V}$, $V_{OUT} = 1.5\text{ V}$ | | 60 | | dB |
| | | 300 kHz, $I_{OUT} = 1.5\text{ A}$, $V_{IN} = 1.8\text{ V}$, $V_{OUT} = 1.5\text{ V}$ | | 30 | | dB |
| | Power-supply rejection (V_{BIAS} to V_{OUT}) | 1 kHz, $I_{OUT} = 1.5\text{ A}$, $V_{IN} = 1.8\text{ V}$, $V_{OUT} = 1.5\text{ V}$ | | 57 | | dB |
| | | 300 kHz, $I_{OUT} = 1.5\text{ A}$, $V_{IN} = 1.8\text{ V}$, $V_{OUT} = 1.5\text{ V}$ | | 49 | | dB |
| V_n | Output noise voltage | $BW = 100\text{ Hz to }100\text{ kHz}$, $I_{OUT} = 3\text{ A}$, $C_{SS} = 1\text{ nF}$ | | 20 | | $\mu\text{Vrms} \times V_{out}$ |
| t_{STR} | Minimum start-up time | R_{LOAD} for $I_{OUT} = 1.0\text{ A}$, $C_{SS} = \text{open}$ | | 250 | | μs |
| I_{SS} | Soft-start charging current | $V_{SS} = 0.4\text{ V}$ | | 440 | | nA |
| $V_{EN(hi)}$ | Enable input high level | | 1.1 | | 5.5 | V |
| $V_{EN(lo)}$ | Enable input low level | | 0 | | 0.4 | V |
| $V_{EN(hys)}$ | Enable pin hysteresis | | | 50 | | mV |
| $V_{EN(dg)}$ | Enable pin deglitch time | | | 20 | | μs |
| I_{EN} | Enable pin current | $V_{EN} = 5\text{ V}$ | | 0.1 | 0.25 | μA |
| V_{IT} | PG trip threshold | V_{OUT} decreasing | 85 | 90 | 94 | $\%V_{OUT}$ |
| V_{HYS} | PG trip hysteresis | | | 3 | | $\%V_{OUT}$ |
| $V_{PG(lo)}$ | PG output low voltage | $I_{PG} = 1\text{ mA}$ (sinking), $V_{OUT} < V_{IT}$ | | | 0.12 | V |
| $I_{PG(lkg)}$ | PG leakage current | $V_{PG} = 5.25\text{ V}$, $V_{OUT} > V_{IT}$ | | 0.001 | 0.05 | μA |
| T_J | Operating junction temperature | | -40 | | 125 | $^\circ\text{C}$ |
| T_{SD} | Thermal shutdown temperature | Shutdown, temperature increasing | | 165 | | $^\circ\text{C}$ |
| | | Reset, temperature decreasing | | 140 | | |

- (1) Adjustable devices tested at 0.8 V; resistor tolerance is not taken into account.
(2) Dropout is defined as the voltage from V_{IN} to V_{OUT} when V_{OUT} is 3% below nominal.
(3) 3.25 V is a test condition of this device and can be adjusted by referring to Figure 6-29.

6.7 Typical Characteristics: $I_{OUT} = 50 \text{ mA}$ (All Other Orderable Devices, Non-M3 Suffix)

at $T_J = 25^\circ\text{C}$, $V_{IN} = V_{OUT(TYP)} + 0.3 \text{ V}$, $V_{BIAS} = 5 \text{ V}$, $I_{OUT} = 50 \text{ mA}$, $V_{EN} = V_{IN}$, $C_{IN} = 1 \mu\text{F}$, $C_{BIAS} = 4.7 \mu\text{F}$, and $C_{OUT} = 10 \mu\text{F}$ (unless otherwise noted)

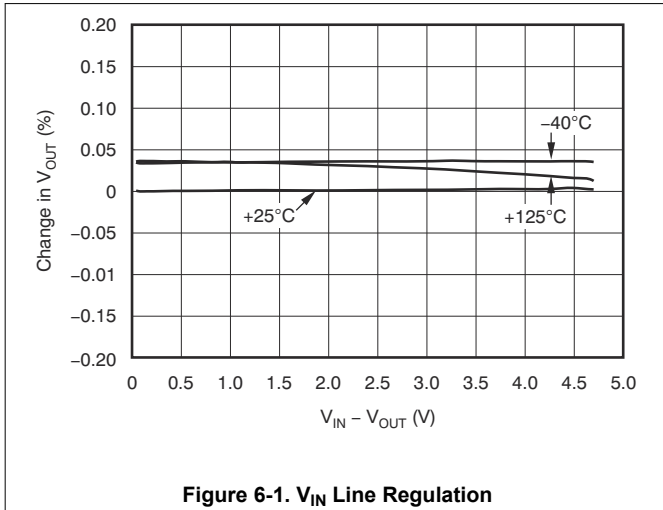

Figure 6-1. V_{IN} Line Regulation

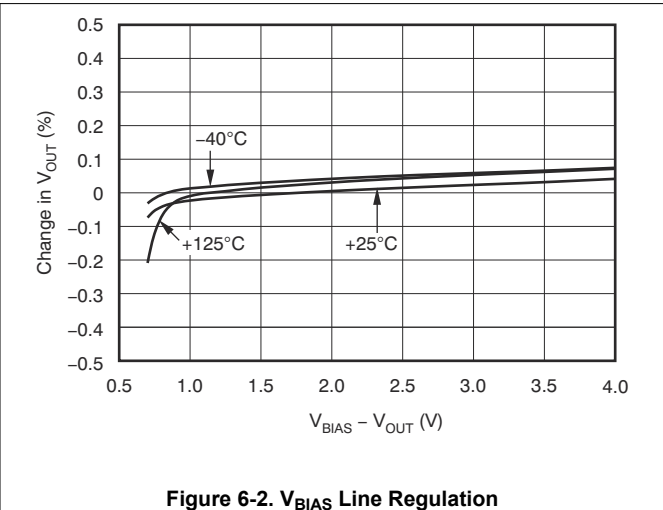

Figure 6-2. V_{BIAS} Line Regulation

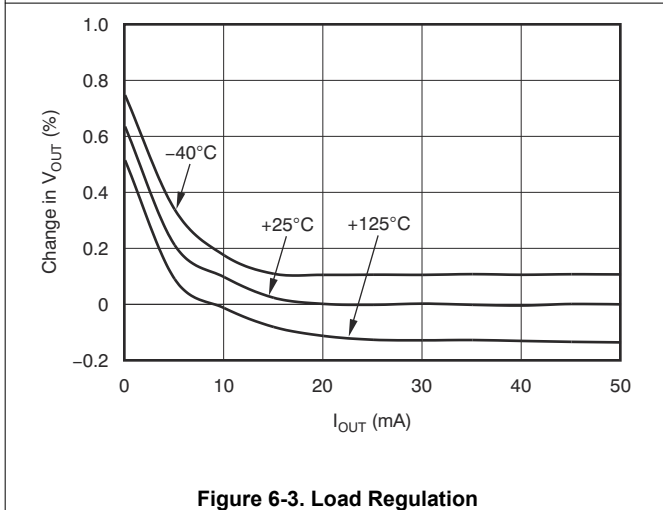

Figure 6-3. Load Regulation

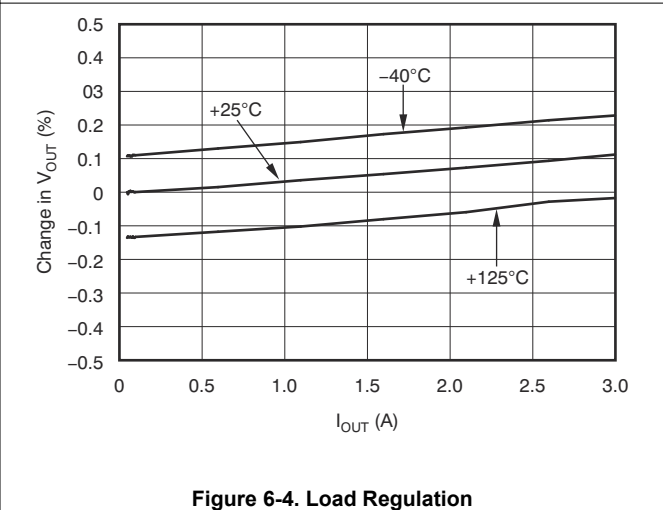

Figure 6-4. Load Regulation

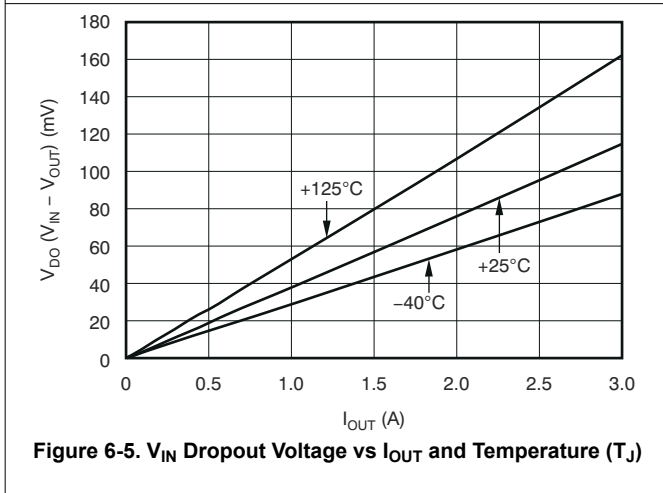

Figure 6-5. V_{IN} Dropout Voltage vs I_{OUT} and Temperature (T_J)

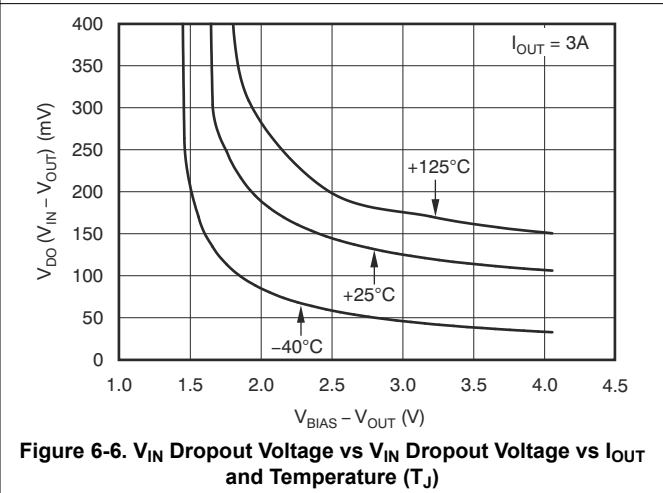

Figure 6-6. V_{IN} Dropout Voltage vs $V_{BIAS} - V_{OUT}$ and Temperature (T_J)

6.7 Typical Characteristics: $I_{OUT} = 50\text{ mA}$ (All Other Orderable Devices, Non-M3 Suffix) (continued)

at $T_J = 25^\circ\text{C}$, $V_{IN} = V_{OUT(TYP)} + 0.3\text{ V}$, $V_{BIAS} = 5\text{ V}$, $I_{OUT} = 50\text{ mA}$, $V_{EN} = V_{IN}$, $C_{IN} = 1\text{ }\mu\text{F}$, $C_{BIAS} = 4.7\text{ }\mu\text{F}$, and $C_{OUT} = 10\text{ }\mu\text{F}$ (unless otherwise noted)

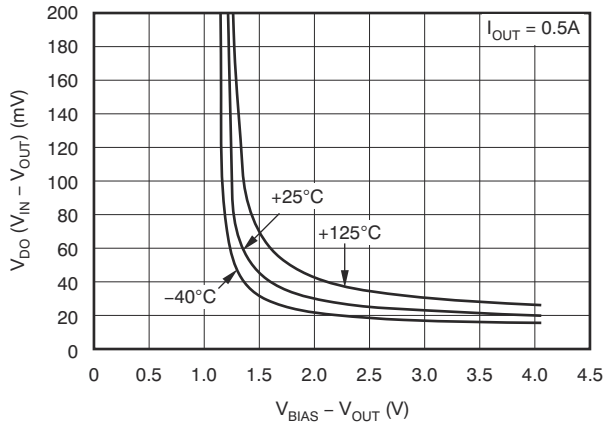

Figure 6-7. V_{IN} Dropout Voltage vs $(V_{BIAS} - V_{OUT})$ and Temperature (T_J)

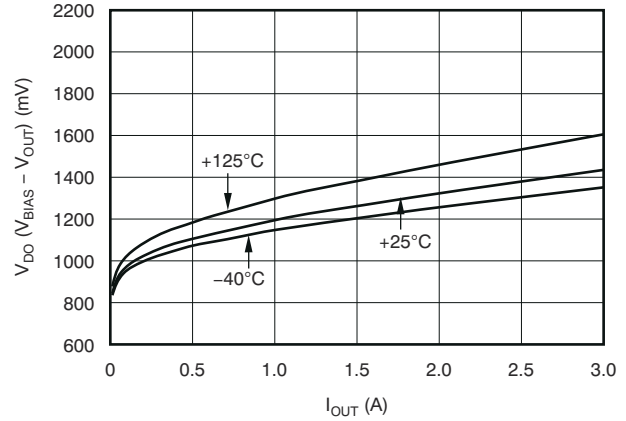

Figure 6-8. V_{BIAS} Dropout Voltage vs I_{OUT} and Temperature (T_J)

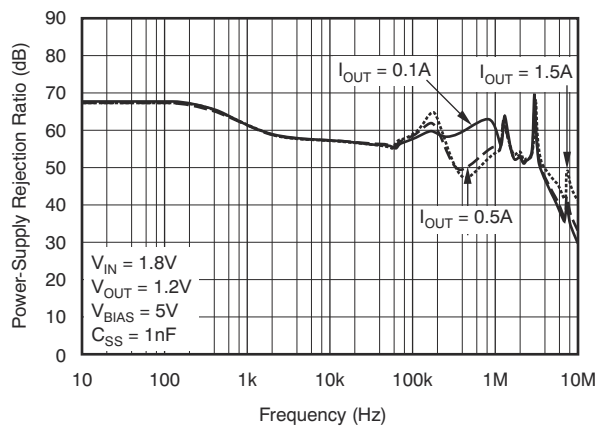

Figure 6-9. V_{BIAS} PSRR vs Frequency

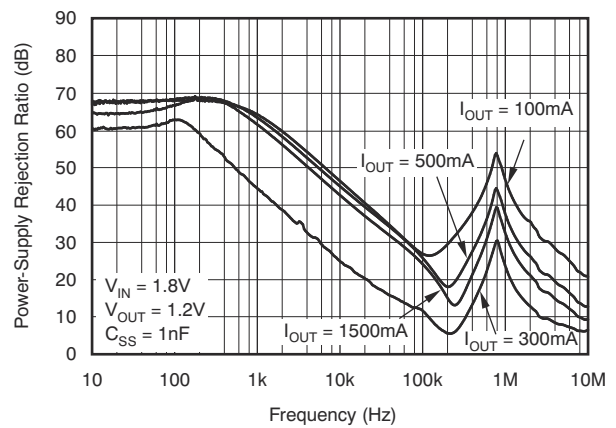

Figure 6-10. V_{IN} PSRR vs Frequency

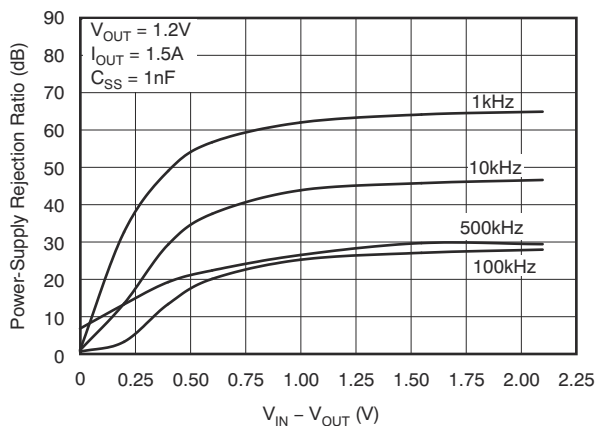

Figure 6-11. V_{IN} PSRR vs $(V_{IN} - V_{OUT})$

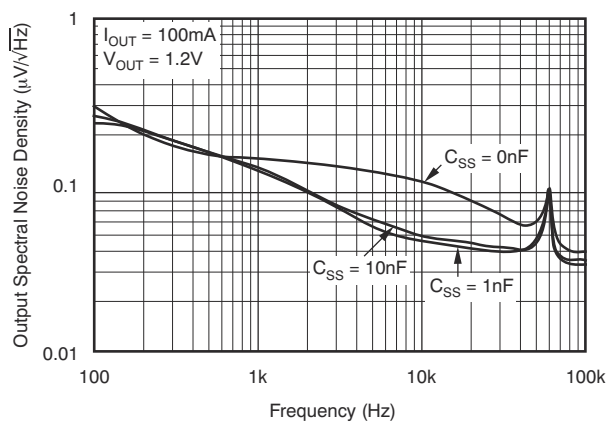

Figure 6-12. Noise Spectral Density

6.7 Typical Characteristics: $I_{OUT} = 50\text{ mA}$ (All Other Orderable Devices, Non-M3 Suffix) (continued)

at $T_J = 25^\circ\text{C}$, $V_{IN} = V_{OUT(TYP)} + 0.3\text{ V}$, $V_{BIAS} = 5\text{ V}$, $I_{OUT} = 50\text{ mA}$, $V_{EN} = V_{IN}$, $C_{IN} = 1\text{ }\mu\text{F}$, $C_{BIAS} = 4.7\text{ }\mu\text{F}$, and $C_{OUT} = 10\text{ }\mu\text{F}$ (unless otherwise noted)

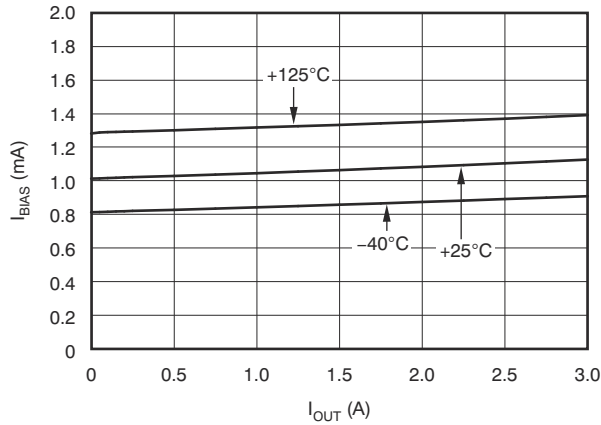

Figure 6-13. BIAS Pin Current vs I_{OUT} and Temperature (T_J)

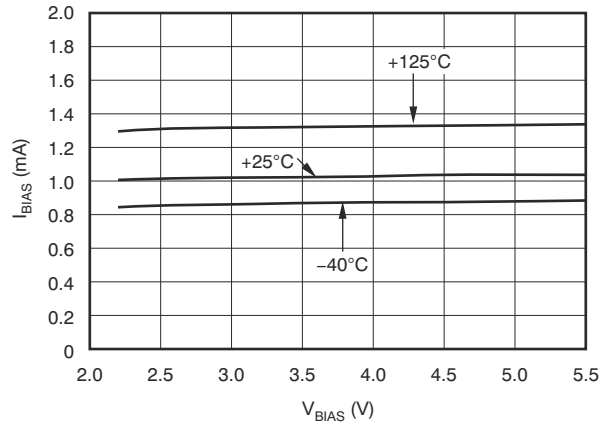

Figure 6-14. BIAS Pin Current vs V_{BIAS} and Temperature (T_J)

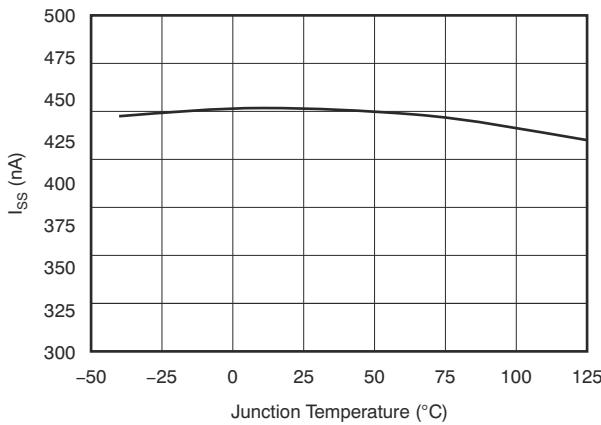

Figure 6-15. Soft-Start Charging Current (I_{SS}) vs Temperature (T_J)

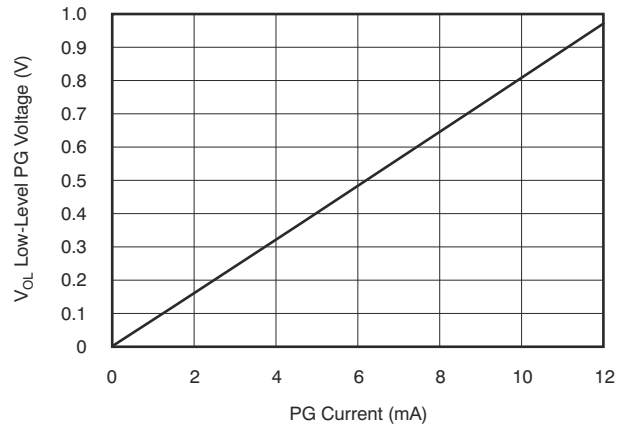

Figure 6-16. Low-Level PG Voltage vs Current

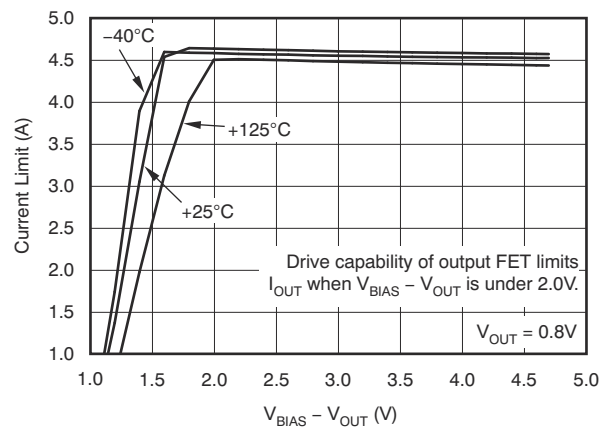

Figure 6-17. Current Limit vs ($V_{BIAS} - V_{OUT}$)

6.8 Typical Characteristics: $I_{OUT} = 1\text{ A}$ (All Other Orderable Devices, Non-M3 Suffix)

at $T_J = 25^\circ\text{C}$, $V_{IN} = V_{OUT(TYP)} + 0.3\text{ V}$, $V_{BIAS} = 5\text{ V}$, $I_{OUT} = 1\text{ A}$, $V_{EN} = V_{IN} = 1.8\text{ V}$, $V_{OUT} = 1.5\text{ V}$, $C_{IN} = 1\ \mu\text{F}$, $C_{BIAS} = 4.7\ \mu\text{F}$, and $C_{OUT} = 10\ \mu\text{F}$ (unless otherwise noted)

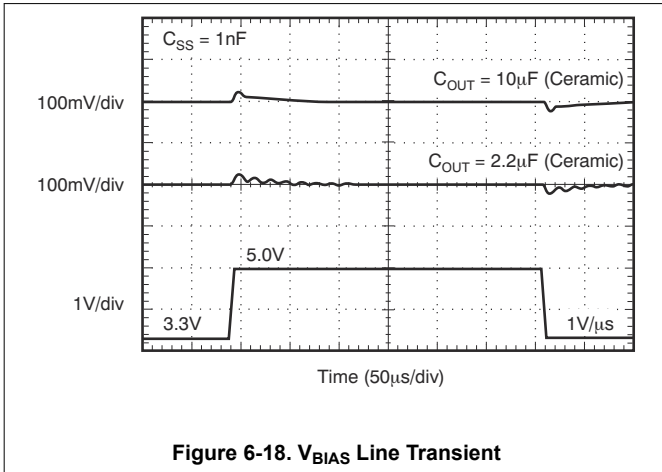

Figure 6-18. V_{BIAS} Line Transient

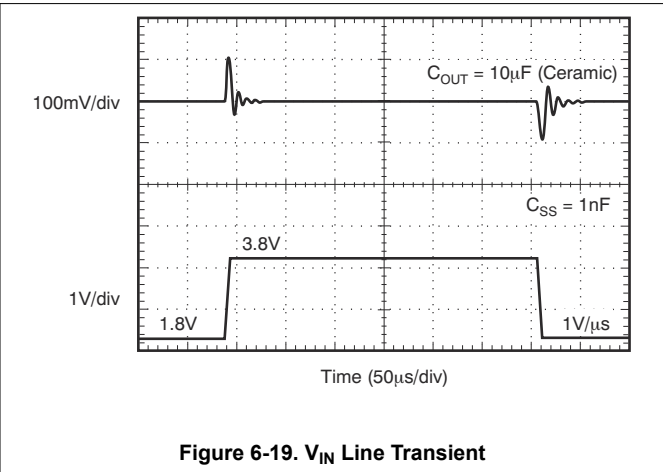

Figure 6-19. V_{IN} Line Transient

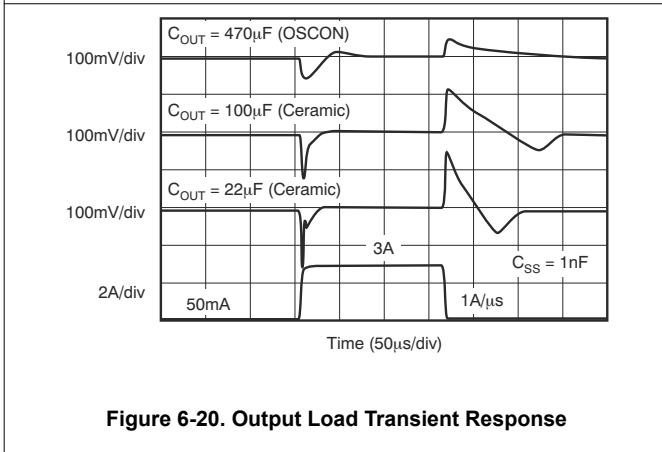

Figure 6-20. Output Load Transient Response

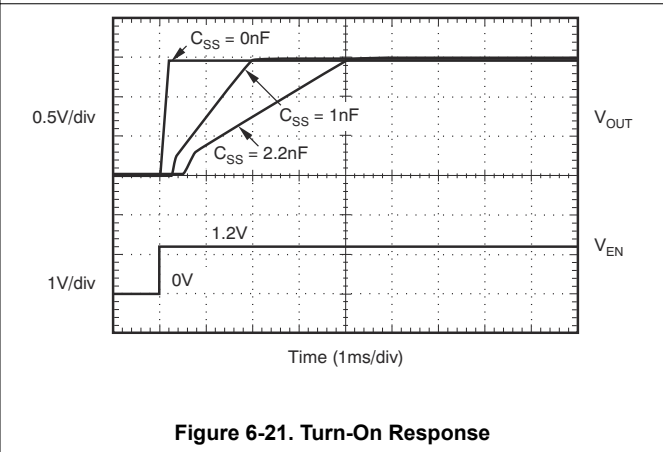

Figure 6-21. Turn-On Response

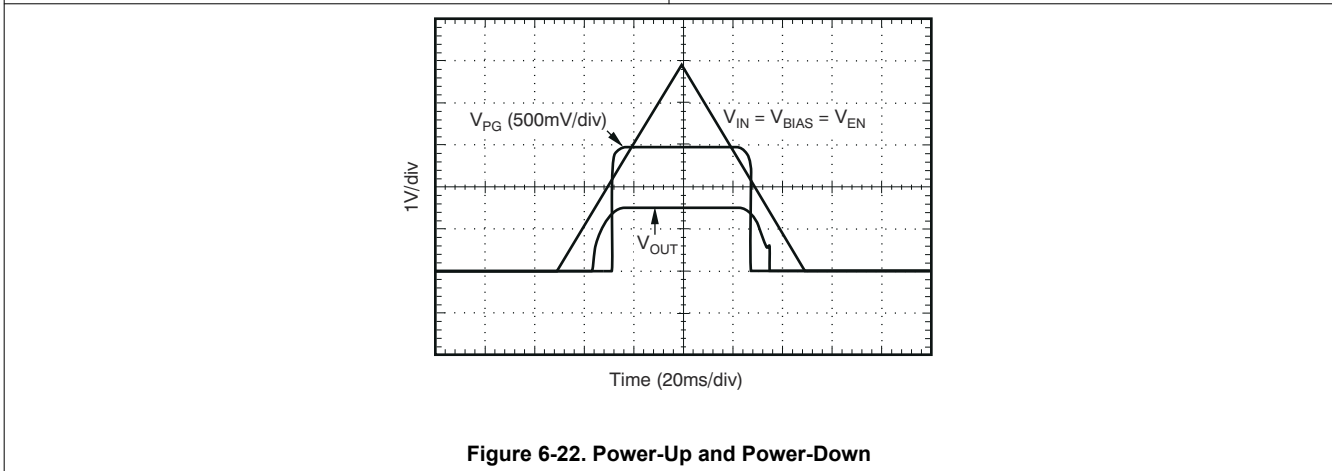
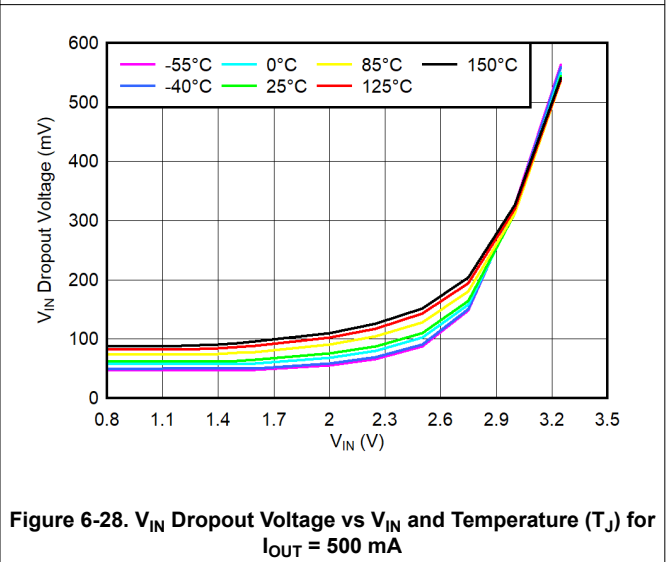
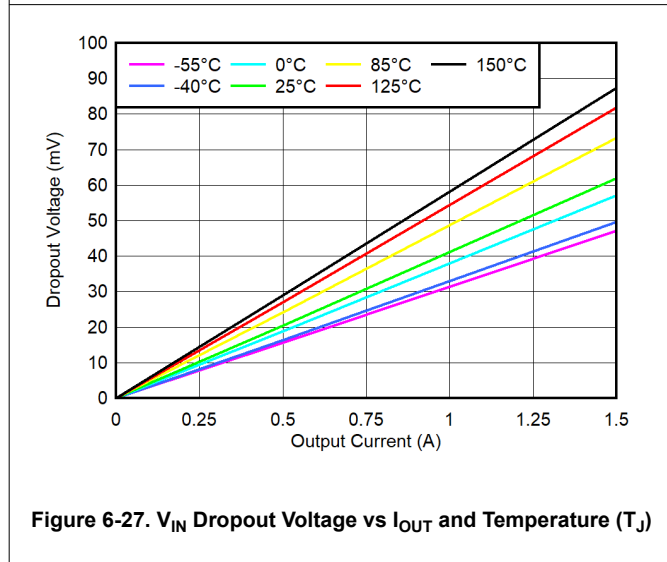
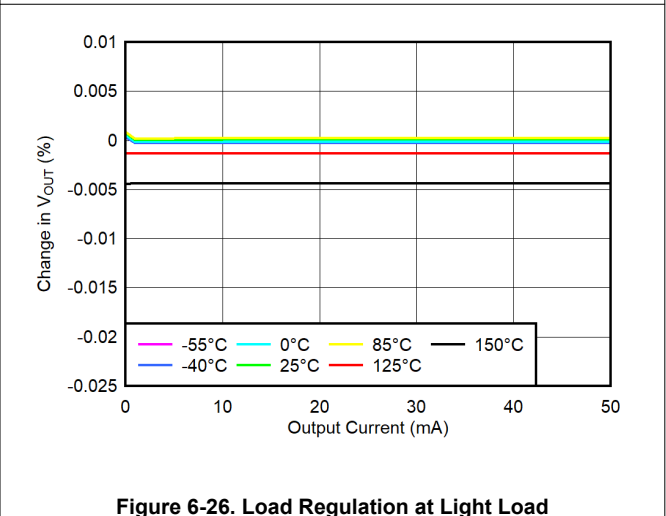
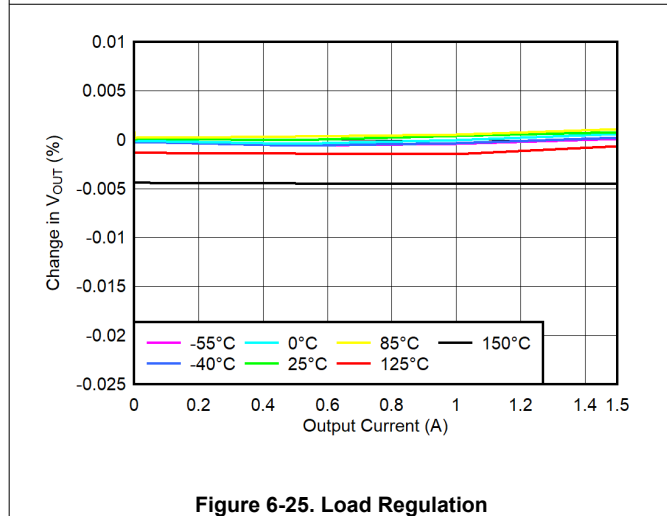
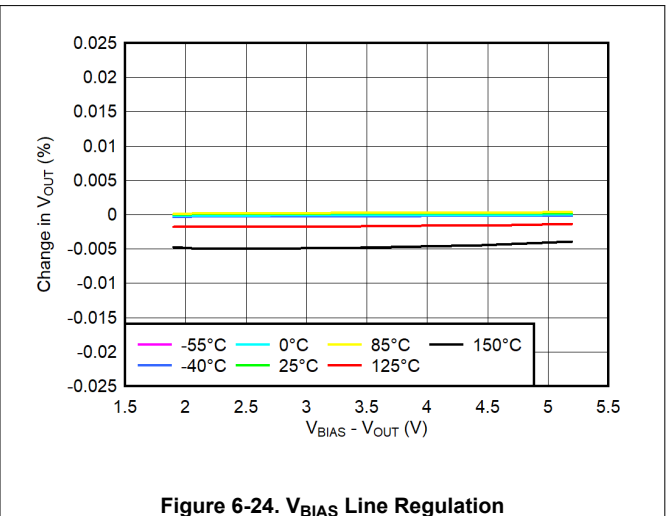
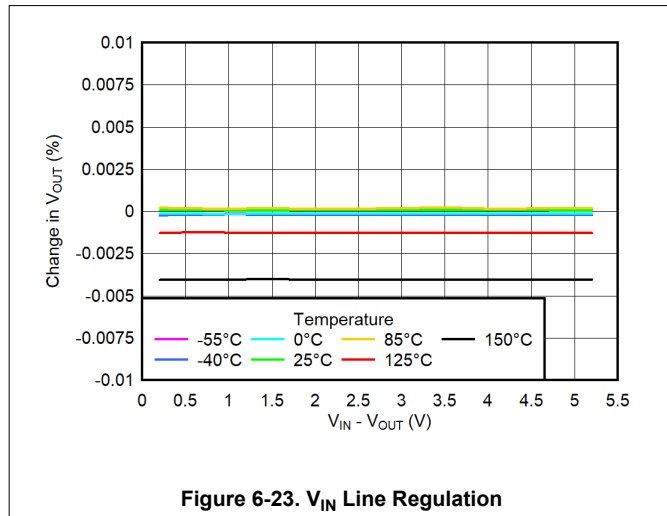

Figure 6-22. Power-Up and Power-Down

6.9 Typical Characteristics: $I_{OUT} = 50 \text{ mA}$ (M3 Suffix)

at $T_J = 25^\circ\text{C}$, $V_{IN} = V_{OUT(nom)} + 0.3 \text{ V}$, $V_{BIAS} = 5 \text{ V}$, $I_{OUT} = 50 \text{ mA}$, $V_{EN} = V_{IN}$, $C_{IN} = 1 \mu\text{F}$, $C_{BIAS} = 4.7 \mu\text{F}$, and $C_{OUT} = 10 \mu\text{F}$ (unless otherwise noted)



6.9 Typical Characteristics: $I_{OUT} = 50 \text{ mA}$ (M3 Suffix) (continued)

at $T_J = 25^\circ\text{C}$, $V_{IN} = V_{OUT(nom)} + 0.3 \text{ V}$, $V_{BIAS} = 5 \text{ V}$, $I_{OUT} = 50 \text{ mA}$, $V_{EN} = V_{IN}$, $C_{IN} = 1 \mu\text{F}$, $C_{BIAS} = 4.7 \mu\text{F}$, and $C_{OUT} = 10 \mu\text{F}$ (unless otherwise noted)

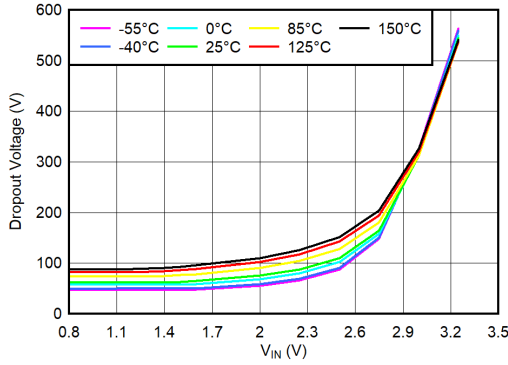

Figure 6-29. V_{IN} Dropout Voltage vs V_{IN} and Temperature (T_J) for $I_{OUT} = 1.5 \text{ A}$

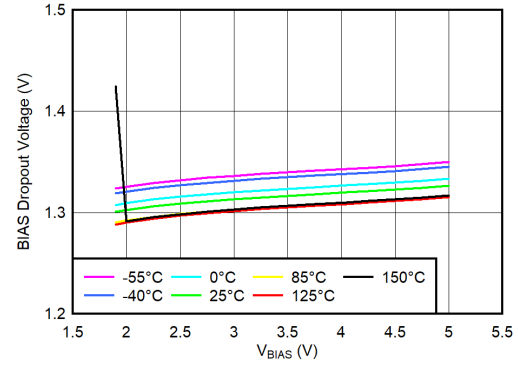

Figure 6-30. V_{IN} Dropout Voltage vs ($V_{BIAS} - V_{OUT}$) and Temperature (T_J)

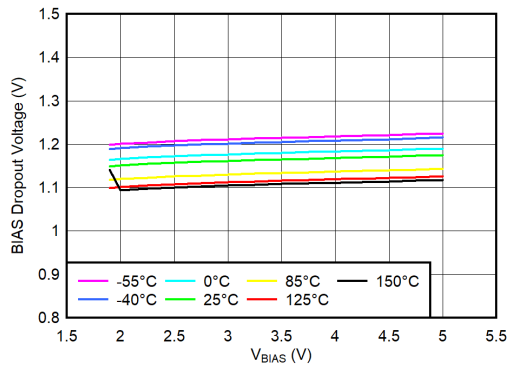

Figure 6-31. V_{IN} Dropout Voltage vs ($V_{BIAS} - V_{OUT}$) and Temperature (T_J)

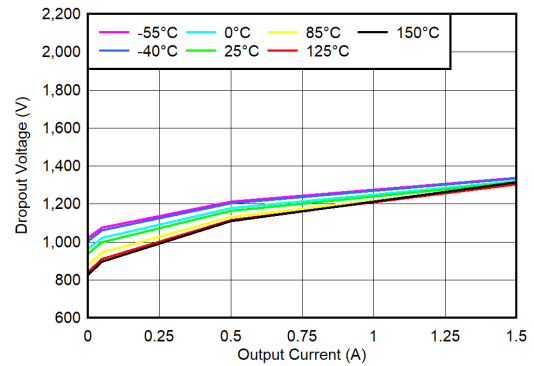

Figure 6-32. V_{BIAS} Dropout Voltage vs I_{OUT} and Temperature (T_J)

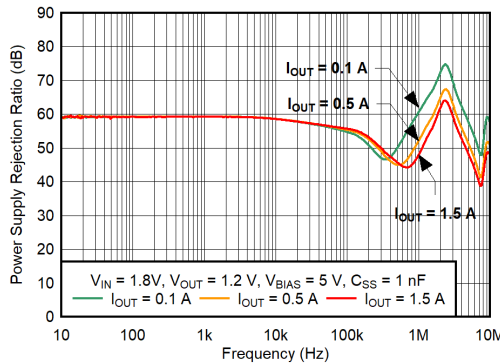

Figure 6-33. V_{BIAS} PSRR vs Frequency

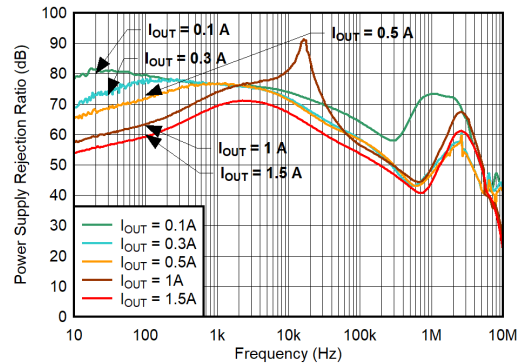

Figure 6-34. V_{IN} PSRR vs Frequency

6.9 Typical Characteristics: I_{OUT} = 50 mA (M3 Suffix) (continued)

at T_J = 25°C, V_{IN} = V_{OUT(nom)} + 0.3 V, V_{BIAS} = 5 V, I_{OUT} = 50 mA, V_{EN} = V_{IN}, C_{IN} = 1 μF, C_{BIAS} = 4.7 μF, and C_{OUT} = 10 μF (unless otherwise noted)

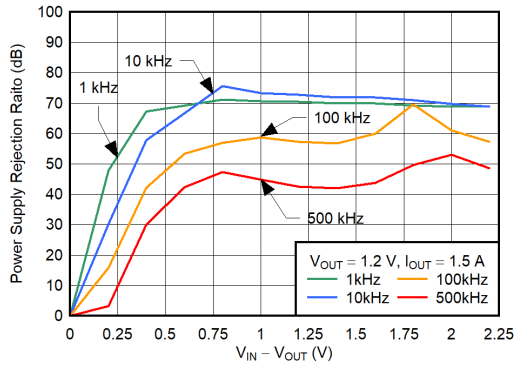

Figure 6-35. V_{IN} PSRR vs (V_{IN} - V_{OUT})

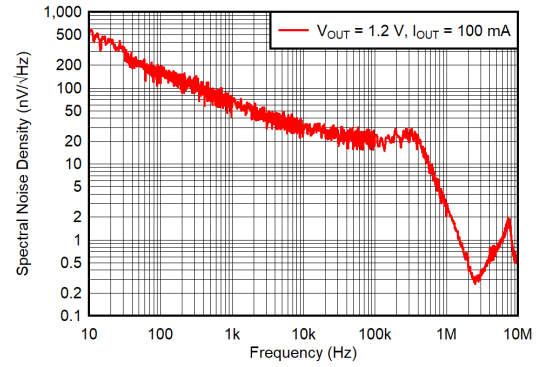

Figure 6-36. Noise Spectral Density

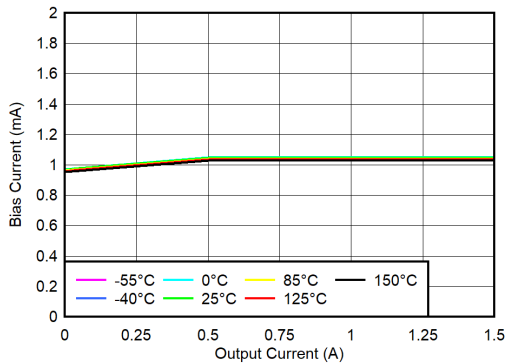

Figure 6-37. BIAS Pin Current vs Output Current and Temperature (T_J)

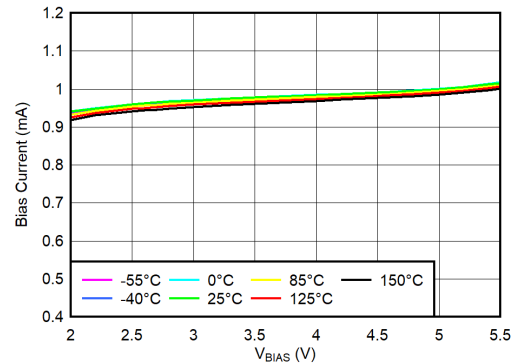

Figure 6-38. BIAS Pin Current vs V_{BIAS} and Temperature (T_J)

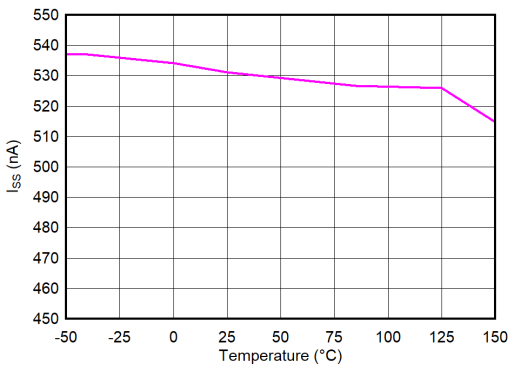

Figure 6-39. Soft-Start Charging Current (I_{SS}) vs Temperature (T_J)

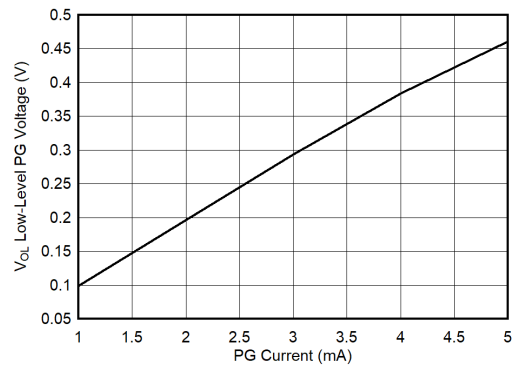

Figure 6-40. Low-Level PG Voltage vs Current

6.9 Typical Characteristics: $I_{OUT} = 50 \text{ mA}$ (M3 Suffix) (continued)

at $T_J = 25^\circ\text{C}$, $V_{IN} = V_{OUT(nom)} + 0.3 \text{ V}$, $V_{BIAS} = 5 \text{ V}$, $I_{OUT} = 50 \text{ mA}$, $V_{EN} = V_{IN}$, $C_{IN} = 1 \mu\text{F}$, $C_{BIAS} = 4.7 \mu\text{F}$, and $C_{OUT} = 10 \mu\text{F}$ (unless otherwise noted)

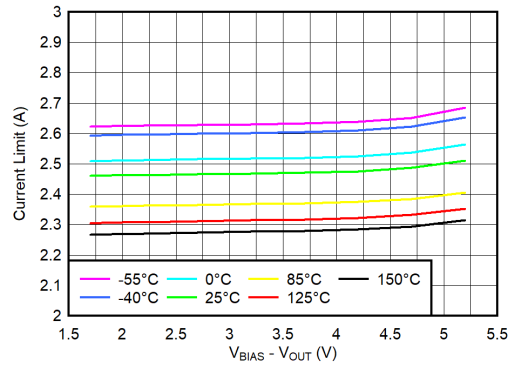

Figure 6-41. Current Limit vs ($V_{BIAS} - V_{OUT}$)

6.10 Typical Characteristics: I_{OUT} = 1 A (M3 Suffix)

at T_J = 25°C, V_{IN} = V_{OUT(nom)} + 0.3 V, V_{BIAS} = 5 V, I_{OUT} = 1 A, V_{EN} = V_{IN} = 1.8 V, V_{OUT} = 1.5 V, C_{IN} = 1 μF, C_{BIAS} = 4.7 μF, and C_{OUT} = 10 μF (unless otherwise noted)

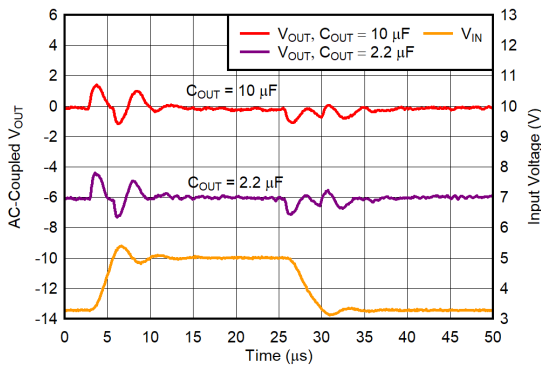

Figure 6-42. V_{BIAS} Line Transient

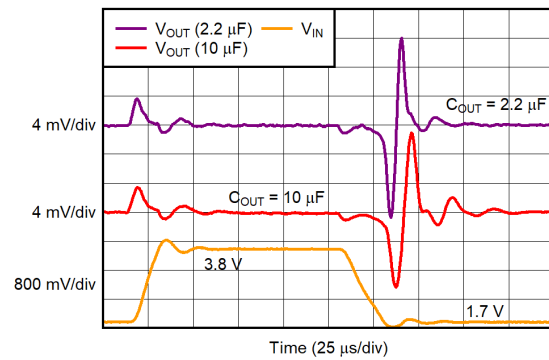

Figure 6-43. V_{IN} Line Transient

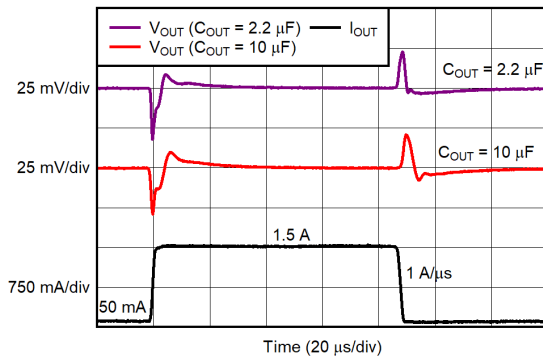

Figure 6-44. Output Load Transient Response

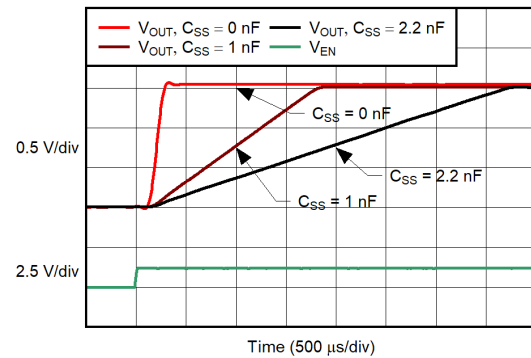

Figure 6-45. Turn-On Response

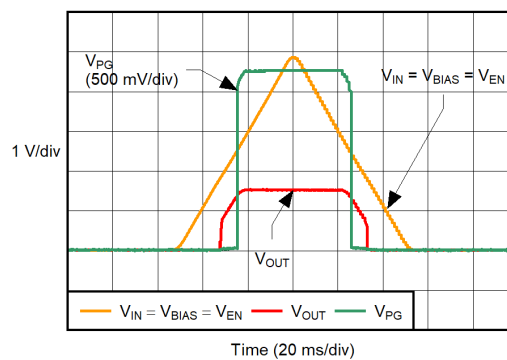

Figure 6-46. Power-Up, Power-Down

7 Detailed Description

7.1 Overview

The TPS74901 is a low-dropout (LDO) regulator that features soft-start capabilities. This regulator uses a low-current bias input to power all internal control circuitry, allowing the NMOS pass transistor to regulate very-low input and output voltages.

Using an NMOS pass transistor offers several critical advantages for many applications. Unlike a p-channel metal-oxide-semiconductor field effect transistor (PMOS) topology device, the output capacitor has little effect on loop stability. This architecture allows the TPS74901 to be stable with any capacitor with a value of 2.2 μF or greater. Transient response is also superior to PMOS topologies, particularly for low V_{IN} applications.

The TPS74901 features a programmable voltage-controlled soft-start circuit that provides a smooth, monotonic start-up and limits start-up inrush currents that can be caused by large capacitive loads. A power-good (PG) output is available to allow supply monitoring and sequencing of other supplies. An enable (EN) pin with hysteresis and deglitch allows slow-ramping signals to be used for sequencing the device. The low V_{IN} and V_{OUT} capability allows for inexpensive, easy-to-design, and efficient linear regulation between the multiple supply voltages often present in processor-intensive systems.

7.2 Functional Block Diagram

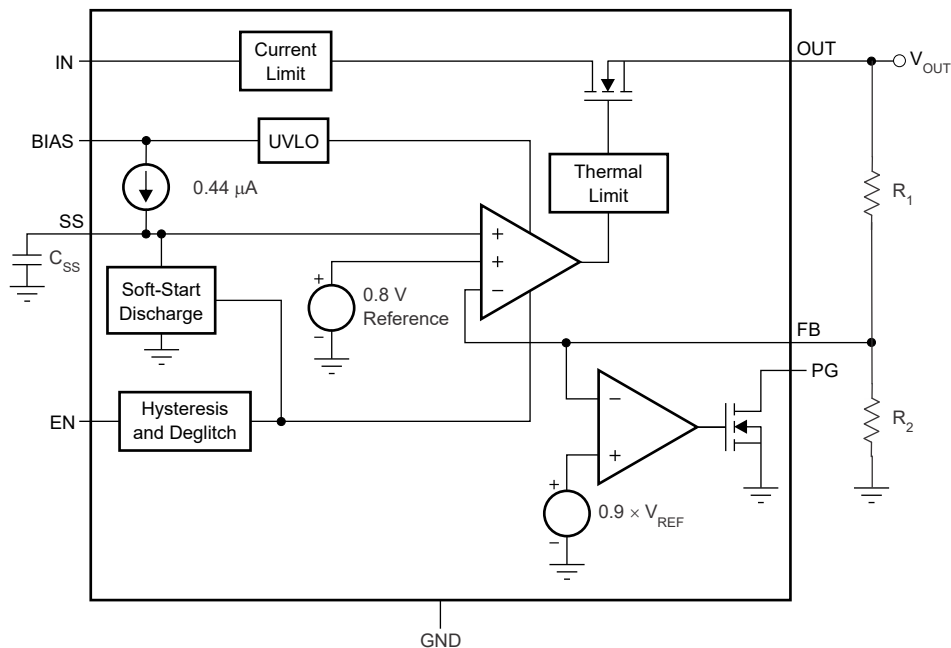

7.3 Feature Description

7.3.1 Enable and Shutdown

The enable (EN) pin is active high and is compatible with standard digital-signaling levels. V_{EN} below 0.4 V turns the regulator off and V_{EN} above 1.1 V turns the regulator on. Unlike many regulators, the enable circuitry has hysteresis and deglitching for use with relatively slowly ramping analog signals. This configuration allows the TPS74901 to be enabled by connecting the output of another supply to the EN pin. The enable circuitry typically has 50 mV of hysteresis and a deglitch circuit to help avoid ON-OFF cycling because of small glitches in the V_{EN} signal.

The enable threshold is typically 0.8 V and varies with temperature and process variations. Temperature variation is approximately -1 mV/°C; process variation accounts for most of the rest of the variation to the 0.4-V and 1.1-V limits. If precise turn-on timing is required, a fast rise-time signal must be used to enable the TPS74901.

If not used, EN can be connected to either IN or BIAS. If EN is connected to IN, then connect EN as close as possible to the largest capacitance on the input to prevent voltage droops on that line from triggering the enable circuit.

7.3.2 Power-Good

The power-good (PG) pin is an open-drain output and can be connected to any 5.5 V or lower rail through an external pullup resistor. This pin requires at least 1.1 V on V_{BIAS} to have a valid output. The PG output is high-impedance when V_{OUT} is greater than $V_{IT} + V_{HYS}$. If V_{OUT} drops below V_{IT} or if V_{BIAS} drops below 1.9 V, the open-drain output turns on and pulls the PG output low. The PG pin also asserts when the device is disabled. The recommended operating condition of PG pin sink current is up to 1 mA, so the pullup resistor for PG must be in the range of 10 k Ω to 1 M Ω . PG is only provided on the VQFN package. If output voltage monitoring is not needed, the PG pin can be left floating.

7.3.3 Internal Current Limit

The TPS74901 features a factory-trimmed, accurate current limit that is flat over temperature and supply voltage. The current limit allows the device to supply surges of up to 4 A and maintain regulation. The current limit responds in approximately 10 μ s to reduce the current during a short-circuit fault.

The internal current-limit protection circuitry of the TPS74901 is designed to protect against overload conditions. This circuitry is not intended to allow operation above the rated current of the device. Continuously running the TPS74901 above the rated current degrades device reliability.

7.3.4 Thermal Protection

Thermal protection disables the output when the junction temperature rises to approximately 160°C, allowing the device to cool. When the junction temperature cools to approximately 140°C, the output circuitry is enabled. Depending on power dissipation, thermal resistance, and ambient temperature the thermal protection circuit can cycle on and off. This cycling limits the dissipation of the regulator, protecting the regulator from damage as a result of overheating.

Activation of the thermal protection circuit indicates excessive power dissipation or inadequate heat sinking. For reliable operation, junction temperature must be limited to 125°C maximum. To estimate the margin of safety in a complete design (including heat sink), increase the ambient temperature until thermal protection is triggered; use worst-case loads and signal conditions. For good reliability, thermal protection must trigger at least 40°C above the maximum expected ambient condition of the application. This condition produces a worst-case junction temperature of 125°C at the highest expected ambient temperature and worst-case load.

The internal protection circuitry of the TPS74901 is designed to protect against overload conditions. This circuitry is not intended to replace proper heat sinking. Continuously running the TPS74901 into thermal shutdown degrades device reliability.

7.4 Device Functional Modes

Table 7-1 lists the conditions that lead to the different modes of operation.

Table 7-1. Device Functional Mode Comparison

| OPERATING MODE | PARAMETER | | | | |
|---|---|-------------------------|--|--------------------|---------------------------|
| | V_{IN} | V_{EN} | V_{BIAS} | I_{OUT} | T_J |
| Normal mode | $V_{IN} > V_{OUT(nom)} + V_{DO} (V_{IN})$ | $V_{EN} > V_{EN(high)}$ | $V_{BIAS} \geq V_{OUT} + V_{DO}(V_{BIAS})$ | $I_{OUT} < I_{CL}$ | $T_J < 125^\circ\text{C}$ |
| Dropout mode | $V_{IN} < V_{OUT(nom)} + V_{DO} (V_{IN})$ | $V_{EN} > V_{EN(high)}$ | $V_{BIAS} < V_{OUT} + V_{DO}(V_{BIAS})$ | — | $T_J < 125^\circ\text{C}$ |
| Disabled mode (any true condition disables the device) | | $V_{EN} < V_{EN(low)}$ | $V_{BIAS} < V_{BIAS(UVLO)}$ | — | $T_J > 165^\circ\text{C}$ |

7.4.1 Normal Operation

The device regulates to the nominal output voltage under the following conditions:

- The input voltage and bias voltage are both at least at the respective minimum specifications
- The enable voltage has previously exceeded the enable rising threshold voltage and has not decreased below the enable falling threshold
- The output current is less than the current limit
- The device junction temperature is less than the maximum specified junction temperature

7.4.2 Dropout Operation

If the input voltage is lower than the nominal output voltage plus the specified dropout voltage, but all other conditions are met for normal operation, the device operates in dropout mode. In this condition, the output voltage is the same as the input voltage minus the dropout voltage. The transient performance of the device is significantly degraded because the pass transistor is in a triode state and no longer controls the current through the LDO. Line or load transients in dropout can result in large output voltage deviations.

7.4.3 Disabled

The device is disabled under the following conditions:

- The input or bias voltages are below the respective minimum specifications
- The enable voltage is less than the enable falling threshold voltage or has not yet exceeded the enable rising threshold
- The device junction temperature is greater than the thermal shutdown temperature

8 Application and Implementation

Note

Information in the following applications sections is not part of the TI component specification, and TI does not warrant its accuracy or completeness. TI's customers are responsible for determining suitability of components for their purposes, as well as validating and testing their design implementation to confirm system functionality.

8.1 Application Information

8.1.1 Input, Output, and BIAS Capacitor Requirements

The device is designed to be stable for all available types of and values of output capacitors $\geq 2.2 \mu\text{F}$. The device is also stable with multiple capacitors in parallel, which can be of any type or value.

The capacitance required on the IN and BIAS pin strongly depends on the input supply source impedance. To counteract any inductance in the input, the minimum recommended capacitor for V_{IN} and V_{BIAS} is $1 \mu\text{F}$. If V_{IN} and V_{BIAS} are connected to the same supply, the recommended minimum capacitor for V_{BIAS} is $4.7 \mu\text{F}$. Good quality, low-ESR capacitors must be used on the input; ceramic X5R and X7R capacitors are preferred. These capacitors must be placed as close as possible to the pins for optimum performance.

8.1.2 Transient Response

The TPS74901 is designed to have excellent transient response for most applications with a small amount of output capacitance. In some cases, the transient response can be limited by the transient response of the input supply. This limitation is especially true in applications where the difference between the input and output is less than 300 mV. In this case, adding additional input capacitance improves the transient response much more than just adding additional output capacitance otherwise does. With a solid input supply, adding additional output capacitance reduces undershoot and overshoot during a transient event; see [Figure 6-20](#) in the [Typical Characteristics](#) section. Because the TPS74901 is stable with output capacitors as low as $2.2 \mu\text{F}$, many applications can need very little capacitance at the LDO output. For these applications, local bypass capacitance for the powered device can be sufficient to meet the transient requirements of the application. This design reduces the total solution cost by avoiding the need to use expensive high-value capacitors at the LDO output.

8.1.3 Dropout Voltage

The TPS74901 offers very low dropout performance, making the device designed for high-current low V_{IN} and low V_{OUT} applications. The low dropout of the TPS74901 allows the device to be used in place of a DC/DC converter and still achieve good efficiencies. This capability provides designers with the power architecture for applications to achieve the smallest, simplest, and lowest-cost solution.

There are two different specifications for dropout voltage with the TPS74901. The first specification (see [Figure 8-1](#)) is referred to as V_{IN} dropout and is used when an external bias voltage is applied to achieve low dropout. This specification assumes that V_{BIAS} is at least 3.25 V above V_{OUT} , which is the case for V_{BIAS} when powered by a 5-V rail with 5% tolerance and with $V_{\text{OUT}} = 1.5 \text{ V}$ (3.25 V is a test condition of this device and can be adjusted by referring to [Figure 6-6](#)). If V_{BIAS} is higher than $V_{\text{OUT}} + 3.25 \text{ V}$, V_{IN} dropout is less than specified.

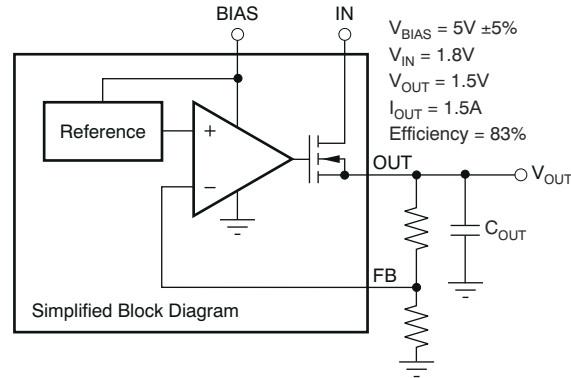

Figure 8-1. Typical Application of the TPS74901 Using an Auxiliary Bias Rail

The second specification (shown in [Figure 8-2](#)) is referred to as V_{BIAS} dropout and is applied to applications where IN and BIAS are tied together. This option allows the device to be used in applications where an auxiliary bias voltage is not available or low dropout is not required. Dropout is limited by BIAS in these applications because V_{BIAS} provides the gate drive to the pass transistor; therefore, V_{BIAS} must be 1.75 V above V_{OUT} . Because of this usage, IN and BIAS tied together easily consume a huge amount of power. Pay attention not to exceed the power rating of the device package.

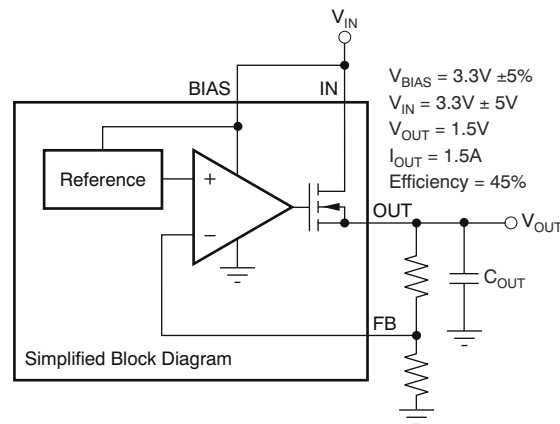

Figure 8-2. Typical Application of the TPS74901 Without an Auxiliary Bias

8.1.4 Output Noise

The TPS74901 provides low-output noise when a soft-start capacitor is used. When the device reaches the end of the soft-start cycle, the soft-start capacitor serves as a filter for the internal reference. By using a 0.001- μ F soft-start capacitor, the output noise is reduced by half and is typically 30 μ V_{RMS} for a 1.2-V output (10 Hz to 100 kHz). Further increasing C_{SS} has little effect on noise. Because most of the output noise is generated by the internal reference, the noise is a function of the set output voltage. The RMS noise with a 0.001- μ F soft-start capacitor is given in [Equation 1](#).

$$V_N(\mu V_{RMS}) = 25 \left(\frac{\mu V_{RMS}}{V} \right) \times V_{OUT}(V) \quad (1)$$

The low-output noise of the TPS74901 makes the device a good choice for powering transceivers, PLLs, or other noise-sensitive circuitry.

8.1.5 Programmable Soft-Start

The TPS74901 features a programmable, monotonic, voltage-controlled soft-start that is set with an external capacitor (C_{SS}). This feature is important for many applications because power-up initialization problems are eliminated when powering FPGAs, DSPs, or other processors. The controlled voltage ramp of the output also reduces peak inrush current during start-up, minimizing start-up transient events to the input power bus.

To achieve a linear and monotonic soft-start, the TPS74901 error amplifier tracks the voltage ramp of the external soft-start capacitor until the voltage exceeds the internal reference. The soft-start ramp time is dependent on the soft-start charging current (I_{SS}), soft-start capacitance (C_{SS}), and the internal reference voltage (V_{REF}), and can be calculated using [Equation 2](#).

$$t_{SS} = \frac{(V_{REF} \times C_{SS})}{I_{SS}} \quad (2)$$

If large output capacitors are used, the device current limit (I_{CL}) and the output capacitor can set the start-up time. In this case, the start-up time is given by [Equation 3](#):

$$t_{SSCL} = \frac{(V_{OUT(NOM)} \times C_{OUT})}{I_{CL(MIN)}} \quad (3)$$

where:

- $V_{OUT(NOM)}$ is the nominal set output voltage
- C_{OUT} is the output capacitance
- $I_{CL(MIN)}$ is the minimum current limit for the device

In applications where monotonic start-up is required, the soft-start time given by [Equation 2](#) must be set to be greater than [Equation 3](#).

The maximum recommended soft-start capacitor is 0.015 μF . Larger soft-start capacitors can be used and do not damage the device; however, the soft-start capacitor discharge circuit can possibly be unable to fully discharge the soft-start capacitor when enabled. Soft-start capacitors larger than 0.015 μF can be a problem in applications where the enable pin must be rapidly pulsed while still requiring the device to soft-start from ground. C_{SS} must be low-leakage; X7R, X5R, or C0G dielectric materials are preferred. See [Table 8-1](#) for suggested soft-start capacitor values.

Table 8-1. Standard Capacitor Values for Programming the Soft-Start Time⁽¹⁾

| C_{SS} | SOFT-START TIME |
|--------------------|-----------------|
| Open | 0.1 ms |
| 270 pF | 0.5 ms |
| 560 pF | 1 ms |
| 2.7 nF | 5 ms |
| 5.6 nF | 10 ms |
| 0.01 μF | 18 ms |

$$(1) \quad t_{SS}(s) = \frac{V_{REF} \times C_{SS}}{I_{SS}} = \frac{0.8V \times C_{SS}(F)}{0.44\mu A} \quad \text{where } t_{SS}(s) = \text{soft-start time in seconds.}$$

8.1.6 Sequencing Requirements

V_{IN} , V_{BIAS} , and V_{EN} can be sequenced in any order without causing damage to the device. However, for the soft-start function to work as intended, certain sequencing rules must be applied. Connecting EN to IN is acceptable for most applications as long as V_{IN} is greater than 1.1 V, and the ramp rate of V_{IN} and V_{BIAS} is faster than the set soft-start ramp rate. If the ramp rate of the input sources is slower than the set soft-start time, the output tracks the slower supply minus the dropout voltage until the set output voltage is reached. If EN is connected to BIAS, the device soft-starts as programmed, provided that V_{IN} is present before V_{BIAS} . If V_{BIAS} and V_{EN} are present before V_{IN} is applied and the set soft-start time has expired, then V_{OUT} tracks V_{IN} . If the soft-start time has not expired, the output tracks V_{IN} until V_{OUT} reaches the value set by the charging soft-start capacitor. [Figure 8-3](#) shows the use of an RC delay circuit to hold off V_{EN} until V_{BIAS} has ramped. This technique can also be used to drive EN from V_{IN} . An external control signal can also be used to enable the device after V_{IN} and V_{BIAS} are present.

Note

When V_{BIAS} and V_{EN} are present and V_{IN} is not supplied, this device outputs approximately 50 μ A of current from OUT. Although this condition does not cause any damage to the device, the output current can charge up the OUT node if total resistance between OUT and GND (including external feedback resistors) is greater than 10 k Ω .

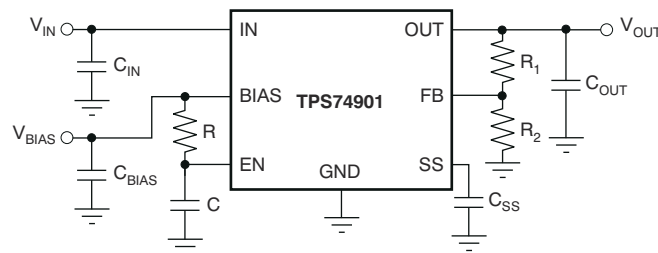

Figure 8-3. Soft-Start Delay Using an RC Circuit on Enable

8.2 Typical Application

Figure 8-4 shows the typical application circuit for the TPS74901 adjustable output device.

R_1 and R_2 can be calculated for any output voltage using the formula shown in Figure 8-4. Table 8-2 lists sample resistor values of common output voltages. To achieve the maximum accuracy specifications, R_2 must be ≤ 4.99 k Ω .

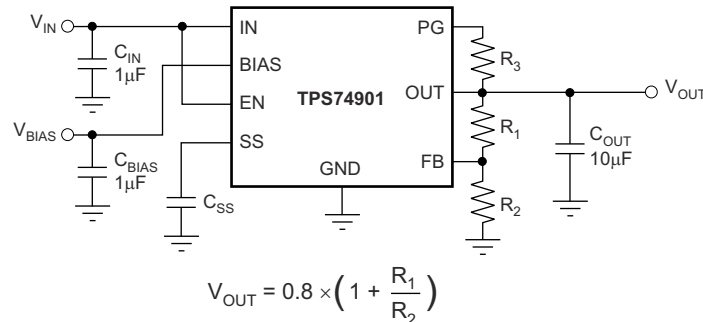

Figure 8-4. Typical Application Circuit for the TPS74901 (Adjustable)

Table 8-2. Standard 1% Resistor Values for Programming the Output Voltage⁽¹⁾

| R_1 (k Ω) | R_2 (k Ω) | V_{OUT} (V) |
|---------------------|---------------------|---------------|
| Short | Open | 0.8 |
| 0.619 | 4.99 | 0.9 |
| 1.13 | 4.53 | 1 |
| 1.37 | 4.42 | 1.05 |
| 1.87 | 4.99 | 1.1 |
| 2.49 | 4.99 | 1.2 |
| 4.12 | 4.75 | 1.5 |
| 3.57 | 2.87 | 1.8 |
| 3.57 | 1.69 | 2.5 |
| 3.57 | 1.15 | 3.3 |

(1) $V_{OUT} = 0.8 \times (1 + R_1 / R_2)$.

8.2.1 Design Requirements

The goal of this design is to create a 1.2-V rail at 3 A with minimal external components from a 1.5-V rail.

8.2.2 Detailed Design Procedure

First choose the bias, which must be at least 1.75 V above the output voltage. A 3.3-V rail is used to achieve this minimum voltage. For a minimal external component count and size, select the minimum capacitor sizes.

$C_{IN} = 1 \mu\text{F}$, $C_{BIAS} = 1 \mu\text{F}$, and a $C_{OUT} = 10 \mu\text{F}$. The C_{OUT} value was chosen to improve transient response. Using Table 8-2, R_1 is set to 2.49 k Ω and R_2 is set to 4.99 k Ω to create a 1.2-V rail. The pullup resistor for PG is set to 10 k Ω .

8.2.3 Application Curves

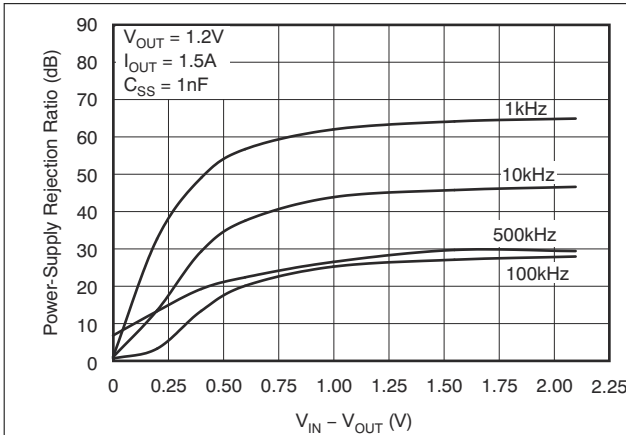

Figure 8-5. V_{IN} PSRR vs $(V_{IN} - V_{OUT})$

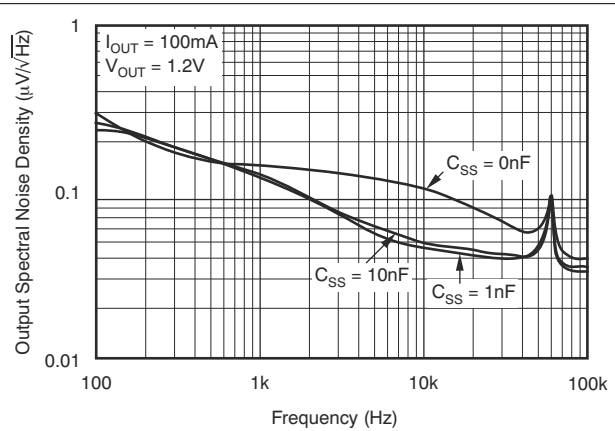

Figure 8-6. Noise Spectral Density

8.3 Power Supply Recommendations

The TPS74901 is designed to operate from an input voltage from 1.1 V to 5.5 V, provided the bias rail is at least 1.75-V higher than the input supply. The bias rail and the input supply must both provide adequate headroom and current for the device to operate normally.

Connect a low-output impedance power supply directly to the IN pin of the TPS74901. This supply must have at least 1 μ F of capacitance near the IN pin for stability. A supply with similar requirements must also be connected directly to the bias rail with a separate 1- μ F or larger capacitor.

If the IN pin is tied to the bias pin, a minimum 4.7 μ F of capacitance is needed for stability.

To increase the overall PSRR of the solution at higher frequencies, use a PI-filter or ferrite bead before the input capacitor.

8.4 Layout

8.4.1 Layout Guidelines

An optimal layout can greatly improve transient performance, PSRR, and noise. To minimize the voltage droop on the input of the device during load transients, connect the capacitance on IN and BIAS as close as possible to the device. This capacitance also minimizes the effects of parasitic inductance and resistance of the input source and can therefore improve stability. To achieve optimal transient performance and accuracy, connect the top side of R_1 in [Figure 8-4](#) as close as possible to the load. If BIAS is connected to IN, connect BIAS as close to the sense point of the input supply as possible. This connection minimizes the voltage droop on BIAS during transient conditions and can improve the turn-on response.

8.4.1.1 Power Dissipation

Knowing the device power dissipation and proper sizing of the thermal plane that is connected to the tab or pad is critical to avoiding thermal shutdown and ensuring reliable operation.

Power dissipation of the device depends on input voltage and load conditions, and can be calculated using [Equation 4](#):

$$P_D = (V_{IN} - V_{OUT}) \times I_{OUT} \quad (4)$$

Power dissipation can be minimized and greater efficiency can be achieved by using the lowest possible input voltage necessary to achieve the required output voltage regulation.

On the VQFN (RGW) package, the primary conduction path for heat is through the exposed pad to the PCB. The pad can be connected to ground or left floating; however, the pad must be attached to an appropriate amount of copper PCB area to ensure the device does not overheat. On the DDPAK (KTW) package, the primary conduction path for heat is through the tab to the PCB. Connect that tab to ground. The maximum junction-to-ambient thermal resistance depends on the maximum ambient temperature, maximum device junction temperature, and power dissipation of the device and can be estimated using [Equation 5](#):

$$R_{\theta JA} = \frac{(+125^{\circ}\text{C} - T_A)}{P_D} \quad (5)$$

Knowing the maximum $R_{\theta JA}$, the minimum amount of PCB copper area needed for appropriate heat sinking can be estimated using [Figure 8-7](#).

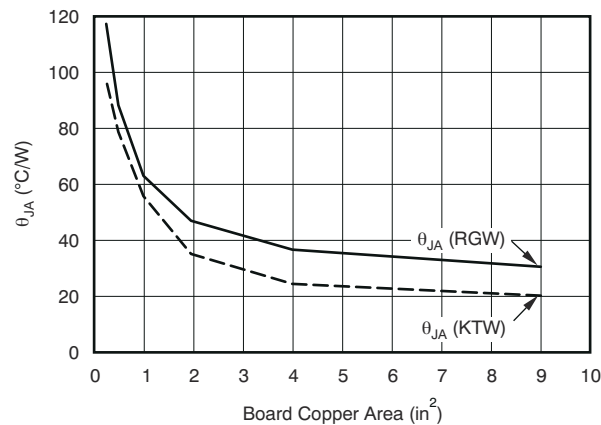

$R_{\theta JA}$ value at board size of 9 in² (that is, 3 inches × 3 inches) is a JEDEC standard.

Figure 8-7. $R_{\theta JA}$ versus Board Size

[Figure 8-7](#) shows the variation of $R_{\theta JA}$ as a function of ground plane copper area in the board. [Figure 8-7](#) is intended only as a guideline to demonstrate the affects of heat spreading in the ground plane; do not use [Figure 8-7](#) to estimate actual thermal performance in real application environments.

Note

When the device is mounted on an application PCB, TI strongly recommends using Ψ_{JT} and Ψ_{JB} , as explained in the [Thermal Considerations](#) section.

8.4.1.2 Thermal Considerations

A better method of estimating the thermal measure comes from using the thermal metrics Ψ_{JT} and Ψ_{JB} , as shown in [Equation 6](#). These metrics are a more accurate representation of the heat transfer characteristics of the die and the package than $R_{\theta JA}$. The junction temperature can be estimated with the corresponding formulas given in [Equation 6](#).

$$\begin{aligned} \Psi_{JT}: T_J &= T_T + \Psi_{JT} \cdot P_D \\ \Psi_{JB}: T_J &= T_B + \Psi_{JB} \cdot P_D \end{aligned} \quad (6)$$

where:

- P_D is the power dissipation shown by [Equation 4](#)
- T_T is the temperature at the center-top of the device package
- T_B is the PCB temperature measured 1 mm away from the device package *on the PCB surface* (see [Figure 8-8](#))

Note

Both T_T and T_B can be measured on actual application boards using a thermo-gun (an infrared thermometer).

For more information about measuring T_T and T_B , see the [Using New Thermal Metrics](#) application note, available for download at www.ti.com.

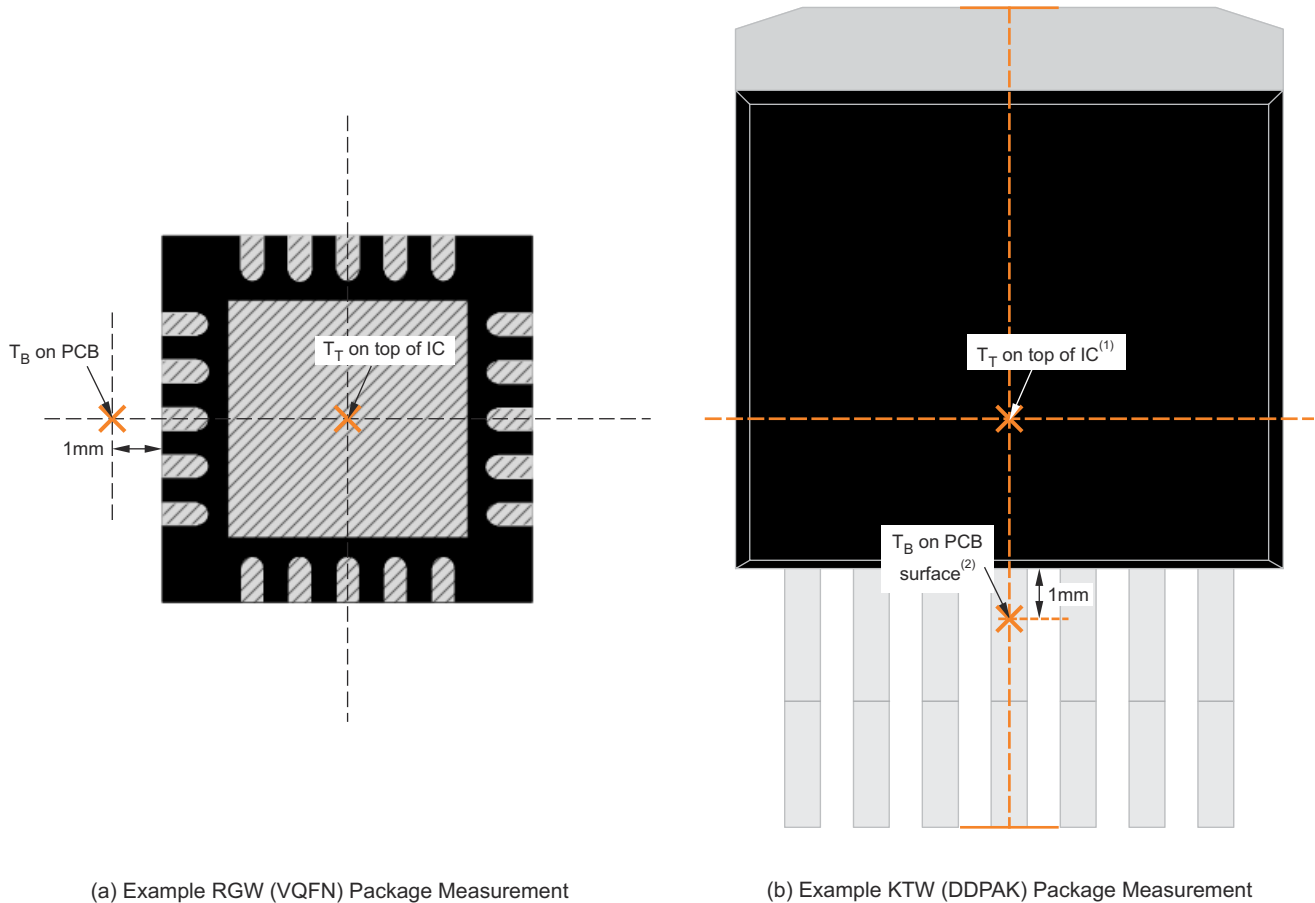

(a) Example RGW (VQFN) Package Measurement

(b) Example KTW (DDPAK) Package Measurement

- A. T_T is measured at the center of both the X- and Y-dimensional axes.
- B. T_B is measured below the package lead on the PCB surface.

Figure 8-8. Measuring Points for T_T and T_B

Compared with $R_{\theta JA}$, the thermal metrics Ψ_{JT} and Ψ_{JB} are less independent of board size but do have a small dependency on board size and layout. Figure 8-9 shows characteristic performance of Ψ_{JT} and Ψ_{JB} versus board size.

Referring to Figure 8-9, the RGW package thermal performance has negligible dependency on board size. The KTW package, however, does have a measurable dependency on board size. This dependency exists because the package shape is not point symmetric to the center of a device. In the KTW package, for example (see Figure 8-8), silicon is not beneath the measuring point of T_T that is the center of the X and Y dimension, so that Ψ_{JT} has a dependency. Also, because of that non-point symmetry, device heat distribution on the PCB is not point symmetric either, so that Ψ_{JB} has a greater dependency on board size and layout.

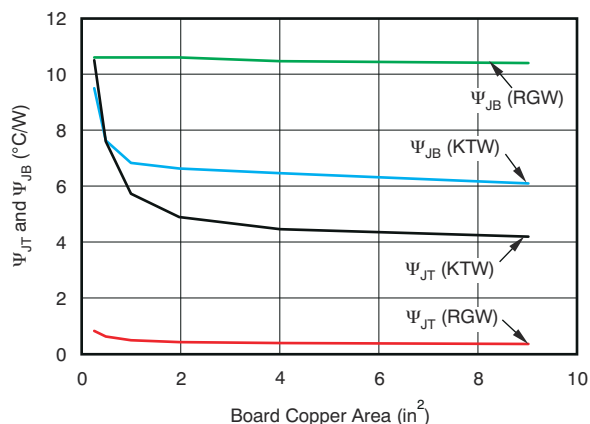

Figure 8-9. Ψ_{JT} and Ψ_{JB} versus Board Size

For a more detailed discussion of why TI does not recommend using $R_{\theta JC(top)}$ to determine thermal characteristics, see the [Using New Thermal Metrics application note](#), available for download at www.ti.com. Also, see the [IC Package Thermal Metrics application note](#) (also available on the TI website) for further information.

8.4.2 Layout Example

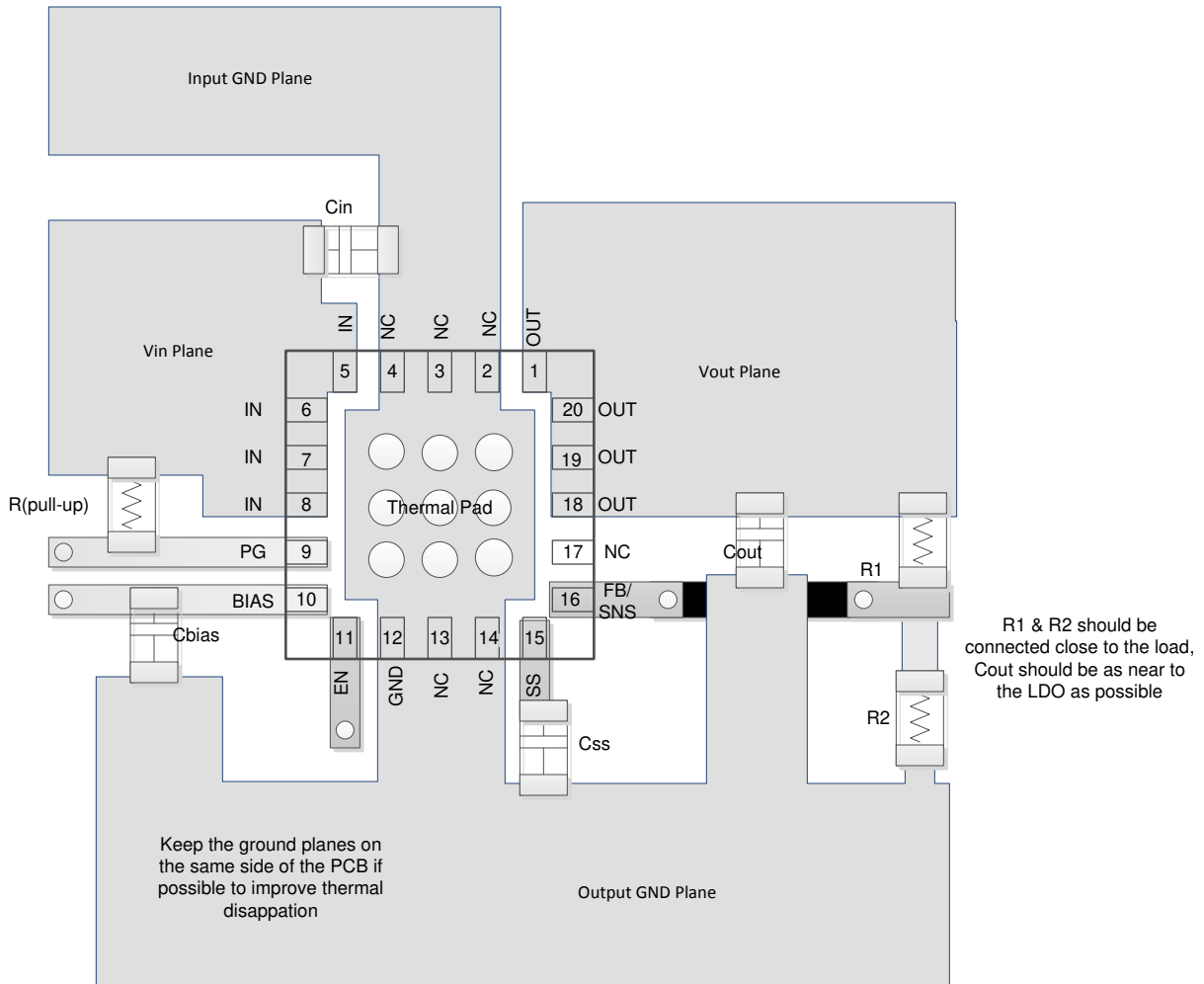

Figure 8-10. Layout Schematic (RGW Package)

9 Device and Documentation Support

9.1 Device Support

9.1.1 Development Support

9.1.1.1 Evaluation Modules

An evaluation module (EVM) is available to assist in the initial circuit performance evaluation using the TPS74901. The [TPS74901EVM-210 evaluation module](#) and related user's guide ([SLVU190](#)) can be requested at the Texas Instruments website through the product folders or purchased directly from the [TI eStore](#).

9.1.1.2 Spice Models

Computer simulation of circuit performance using SPICE is often useful when analyzing the performance of analog circuits and systems. A SPICE model for the TPS74901 is available through the product folders under *Tools & Software*.

9.2 Documentation Support

9.2.1 Related Documentation

For related documentation, see the following:

- Texas Instruments, [Using New Thermal Metrics applicatin note](#)
- Texas Instruments, [Semiconductor and IC Package Thermal Metrics application note](#)
- Texas Instruments, [Ultimate Regulation with Fixed Output Version of TPS742xx/TPS743xx/TPS744xx application note](#)
- Texas Instruments, [Pros and Cons of Using a Feed-Forward Capacitor with a Low Dropout Regulator application note](#)
- Texas Instruments, [TPS74901EVM-210 user's guide](#)

9.3 Receiving Notification of Documentation Updates

To receive notification of documentation updates, navigate to the device product folder on [ti.com](#). Click on *Subscribe to updates* to register and receive a weekly digest of any product information that has changed. For change details, review the revision history included in any revised document.

9.4 Support Resources

[TI E2E™ support forums](#) are an engineer's go-to source for fast, verified answers and design help — straight from the experts. Search existing answers or ask your own question to get the quick design help you need.

Linked content is provided "AS IS" by the respective contributors. They do not constitute TI specifications and do not necessarily reflect TI's views; see TI's [Terms of Use](#).

9.5 Trademarks

TI E2E™ is a trademark of Texas Instruments.

All trademarks are the property of their respective owners.

9.6 Electrostatic Discharge Caution



This integrated circuit can be damaged by ESD. Texas Instruments recommends that all integrated circuits be handled with appropriate precautions. Failure to observe proper handling and installation procedures can cause damage.

ESD damage can range from subtle performance degradation to complete device failure. Precision integrated circuits may be more susceptible to damage because very small parametric changes could cause the device not to meet its published specifications.

9.7 Glossary

[TI Glossary](#) This glossary lists and explains terms, acronyms, and definitions.

10 Mechanical, Packaging, and Orderable Information

The following pages include mechanical, packaging, and orderable information. This information is the most current data available for the designated devices. This data is subject to change without notice and revision of this document. For browser-based versions of this data sheet, refer to the left-hand navigation.

PACKAGING INFORMATION

| Orderable Device | Status (1) | Package Type | Package Drawing | Pins | Package Qty | Eco Plan (2) | Lead finish/ Ball material (6) | MSL Peak Temp (3) | Op Temp (°C) | Device Marking (4/5) | Samples |
|------------------|---------------|------------------|-----------------|------|-------------|-----------------|--------------------------------------|----------------------|--------------|-------------------------|-------------------------|
| TPS74901DRCR | ACTIVE | VSON | DRC | 10 | 3000 | RoHS & Green | NIPDAU | Level-1-260C-UNLIM | -40 to 125 | 11S | Samples |
| TPS74901DRCRM3 | ACTIVE | VSON | DRC | 10 | 3000 | RoHS & Green | NIPDAU | Level-1-260C-UNLIM | -40 to 125 | 11S | Samples |
| TPS74901DRCT | ACTIVE | VSON | DRC | 10 | 250 | RoHS & Green | NIPDAU | Level-1-260C-UNLIM | -40 to 125 | 11S | Samples |
| TPS74901KTWR | ACTIVE | DDPAK/ TO-263 | KTW | 7 | 500 | RoHS & Green | Call TI SN | Level-2-260C-1 YEAR | -40 to 125 | TPS74901 | Samples |
| TPS74901RGWR | ACTIVE | VQFN | RGW | 20 | 3000 | RoHS & Green | NIPDAU | Level-2-260C-1 YEAR | -40 to 125 | TPS 74901 | Samples |
| TPS74901RGWT | ACTIVE | VQFN | RGW | 20 | 250 | RoHS & Green | NIPDAU | Level-2-260C-1 YEAR | -40 to 125 | TPS 74901 | Samples |
| TPS74901RGWTG4 | ACTIVE | VQFN | RGW | 20 | 250 | RoHS & Green | NIPDAU | Level-2-260C-1 YEAR | -40 to 125 | TPS 74901 | Samples |

(1) The marketing status values are defined as follows:

ACTIVE: Product device recommended for new designs.

LIFEBUY: TI has announced that the device will be discontinued, and a lifetime-buy period is in effect.

NRND: Not recommended for new designs. Device is in production to support existing customers, but TI does not recommend using this part in a new design.

PREVIEW: Device has been announced but is not in production. Samples may or may not be available.

OBSOLETE: TI has discontinued the production of the device.

(2) **RoHS:** TI defines "RoHS" to mean semiconductor products that are compliant with the current EU RoHS requirements for all 10 RoHS substances, including the requirement that RoHS substance do not exceed 0.1% by weight in homogeneous materials. Where designed to be soldered at high temperatures, "RoHS" products are suitable for use in specified lead-free processes. TI may reference these types of products as "Pb-Free".

RoHS Exempt: TI defines "RoHS Exempt" to mean products that contain lead but are compliant with EU RoHS pursuant to a specific EU RoHS exemption.

Green: TI defines "Green" to mean the content of Chlorine (Cl) and Bromine (Br) based flame retardants meet JS709B low halogen requirements of <=1000ppm threshold. Antimony trioxide based flame retardants must also meet the <=1000ppm threshold requirement.

(3) MSL, Peak Temp. - The Moisture Sensitivity Level rating according to the JEDEC industry standard classifications, and peak solder temperature.

(4) There may be additional marking, which relates to the logo, the lot trace code information, or the environmental category on the device.

(5) Multiple Device Markings will be inside parentheses. Only one Device Marking contained in parentheses and separated by a "~" will appear on a device. If a line is indented then it is a continuation of the previous line and the two combined represent the entire Device Marking for that device.

⁽⁶⁾ Lead finish/Ball material - Orderable Devices may have multiple material finish options. Finish options are separated by a vertical ruled line. Lead finish/Ball material values may wrap to two lines if the finish value exceeds the maximum column width.

Important Information and Disclaimer:The information provided on this page represents TI's knowledge and belief as of the date that it is provided. TI bases its knowledge and belief on information provided by third parties, and makes no representation or warranty as to the accuracy of such information. Efforts are underway to better integrate information from third parties. TI has taken and continues to take reasonable steps to provide representative and accurate information but may not have conducted destructive testing or chemical analysis on incoming materials and chemicals. TI and TI suppliers consider certain information to be proprietary, and thus CAS numbers and other limited information may not be available for release.

In no event shall TI's liability arising out of such information exceed the total purchase price of the TI part(s) at issue in this document sold by TI to Customer on an annual basis.

TAPE AND REEL INFORMATION

QUADRANT ASSIGNMENTS FOR PIN 1 ORIENTATION IN TAPE

*All dimensions are nominal

| Device | Package Type | Package Drawing | Pins | SPQ | Reel Diameter (mm) | Reel Width W1 (mm) | A0 (mm) | B0 (mm) | K0 (mm) | P1 (mm) | W (mm) | Pin1 Quadrant |
|----------------|--------------|-----------------|------|------|--------------------|--------------------|---------|---------|---------|---------|--------|---------------|
| TPS74901DRCR | VSON | DRC | 10 | 3000 | 330.0 | 12.4 | 3.3 | 3.3 | 1.1 | 8.0 | 12.0 | Q2 |
| TPS74901DRCRM3 | VSON | DRC | 10 | 3000 | 330.0 | 12.4 | 3.3 | 3.3 | 1.1 | 8.0 | 12.0 | Q2 |
| TPS74901DRCT | VSON | DRC | 10 | 250 | 180.0 | 12.4 | 3.3 | 3.3 | 1.1 | 8.0 | 12.0 | Q2 |
| TPS74901RGWR | VQFN | RGW | 20 | 3000 | 330.0 | 12.4 | 5.3 | 5.3 | 1.1 | 8.0 | 12.0 | Q2 |
| TPS74901RGWT | VQFN | RGW | 20 | 250 | 180.0 | 12.4 | 5.3 | 5.3 | 1.1 | 8.0 | 12.0 | Q2 |

TAPE AND REEL BOX DIMENSIONS

*All dimensions are nominal

| Device | Package Type | Package Drawing | Pins | SPQ | Length (mm) | Width (mm) | Height (mm) |
|----------------|--------------|-----------------|------|------|-------------|------------|-------------|
| TPS74901DRCR | VSON | DRC | 10 | 3000 | 367.0 | 367.0 | 35.0 |
| TPS74901DRCRM3 | VSON | DRC | 10 | 3000 | 367.0 | 367.0 | 35.0 |
| TPS74901DRCT | VSON | DRC | 10 | 250 | 210.0 | 185.0 | 35.0 |
| TPS74901RGWR | VQFN | RGW | 20 | 3000 | 367.0 | 367.0 | 35.0 |
| TPS74901RGWT | VQFN | RGW | 20 | 250 | 210.0 | 185.0 | 35.0 |

KTW (R-PSFM-G7)

PLASTIC FLANGE-MOUNT

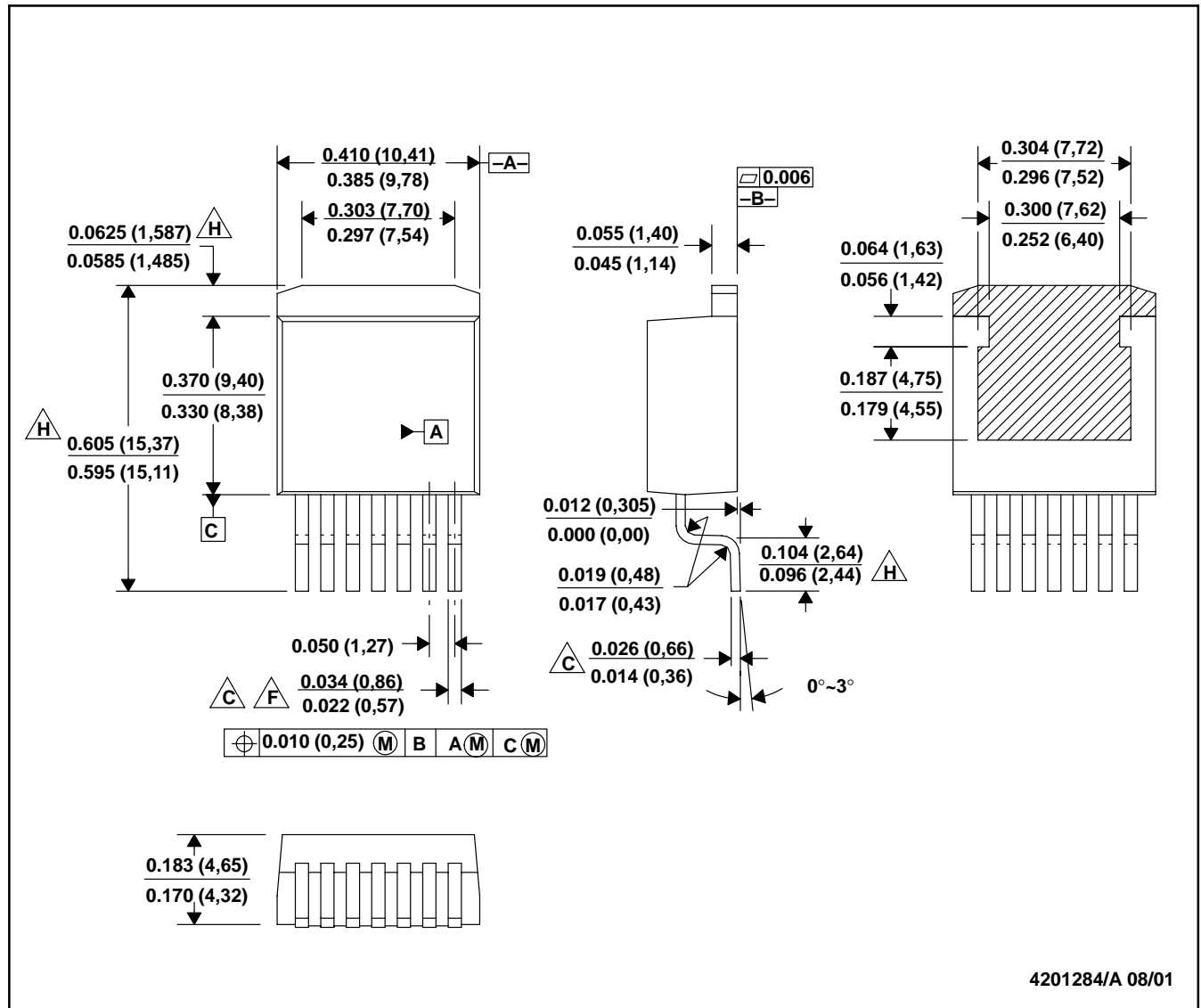

- NOTES: A. All linear dimensions are in inches (millimeters).
 B. This drawing is subject to change without notice.
 $\triangle C$. Lead width and height dimensions apply to the plated lead.
 D. Leads are not allowed above the Datum B.
 E. Stand-off height is measured from lead tip with reference to Datum B.
 $\triangle F$. Lead width dimension does not include dambar protrusion. Allowable dambar protrusion shall not cause the lead width to exceed the maximum dimension by more than 0.003".
 G. Cross-hatch indicates exposed metal surface.
 $\triangle H$. Falls within JEDEC MO-169 with the exception of the dimensions indicated.

GENERIC PACKAGE VIEW

DRC 10

VSON - 1 mm max height

3 x 3, 0.5 mm pitch

PLASTIC SMALL OUTLINE - NO LEAD

This image is a representation of the package family, actual package may vary.
Refer to the product data sheet for package details.



4226193/A

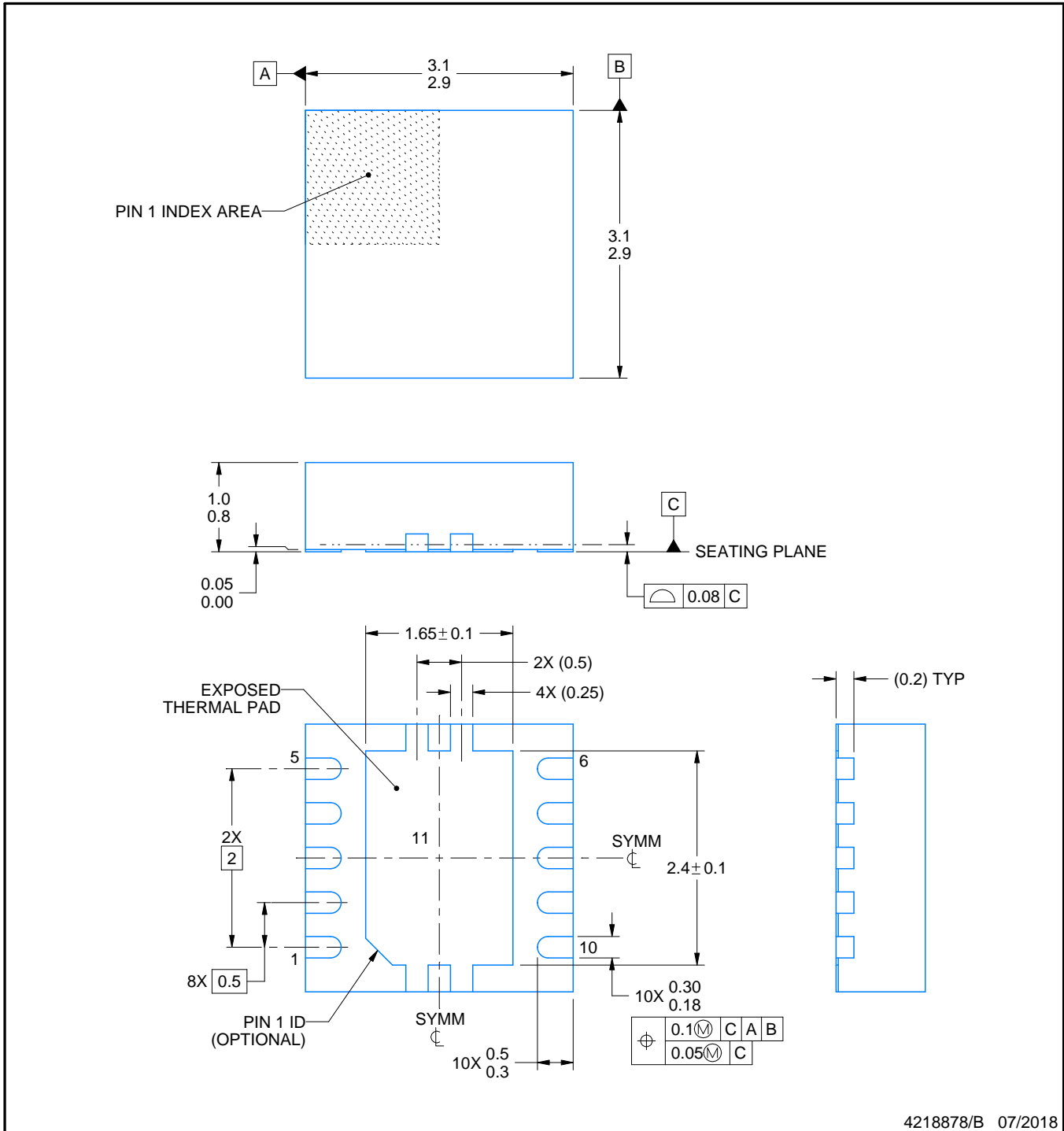

4218878/B 07/2018

NOTES:

1. All linear dimensions are in millimeters. Any dimensions in parenthesis are for reference only. Dimensioning and tolerancing per ASME Y14.5M.
2. This drawing is subject to change without notice.
3. The package thermal pad must be soldered to the printed circuit board for optimal thermal and mechanical performance.

EXAMPLE BOARD LAYOUT

DRC0010J

VSON - 1 mm max height

PLASTIC SMALL OUTLINE - NO LEAD



LAND PATTERN EXAMPLE
EXPOSED METAL SHOWN
SCALE:20X



SOLDER MASK DETAILS

4218878/B 07/2018

NOTES: (continued)

4. This package is designed to be soldered to a thermal pad on the board. For more information, see Texas Instruments literature number SLUA271 (www.ti.com/lit/sluea271).
5. Vias are optional depending on application, refer to device data sheet. If any vias are implemented, refer to their locations shown on this view. It is recommended that vias under paste be filled, plugged or tented.

EXAMPLE STENCIL DESIGN

DRC0010J

VSON - 1 mm max height

PLASTIC SMALL OUTLINE - NO LEAD

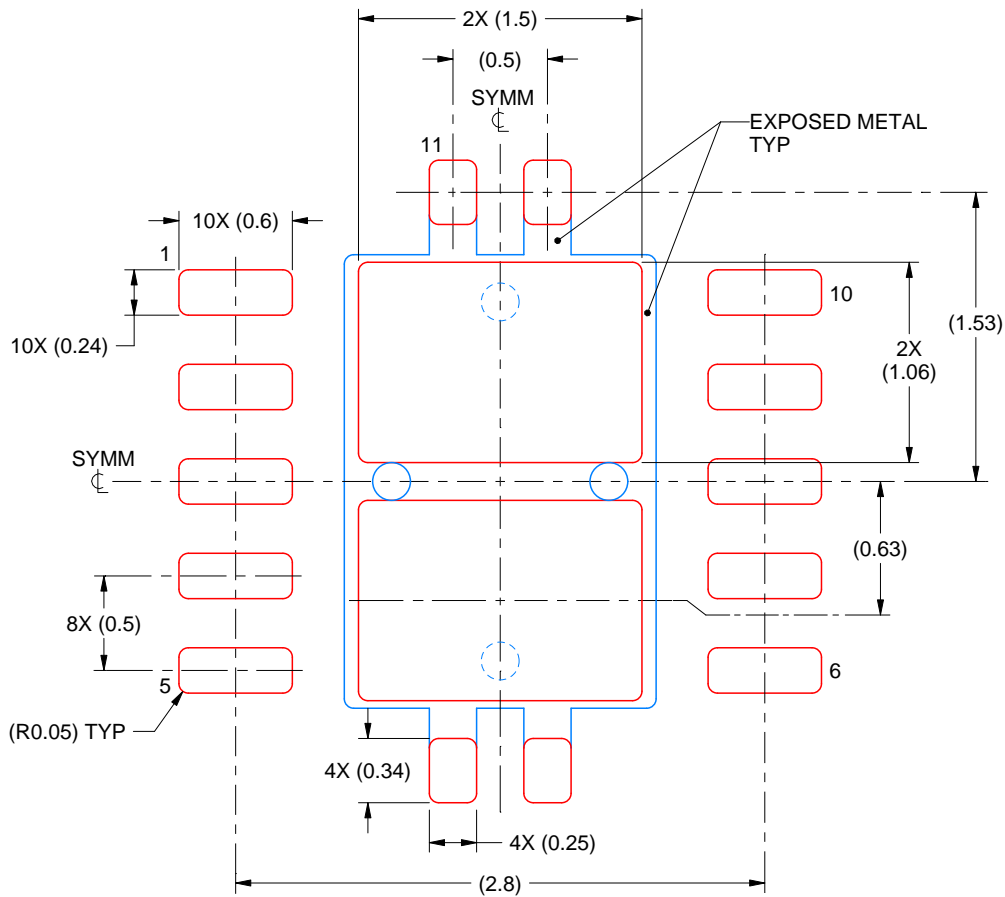

SOLDER PASTE EXAMPLE
BASED ON 0.125 mm THICK STENCIL

EXPOSED PAD 11:
80% PRINTED SOLDER COVERAGE BY AREA
SCALE:25X

4218878/B 07/2018

NOTES: (continued)

6. Laser cutting apertures with trapezoidal walls and rounded corners may offer better paste release. IPC-7525 may have alternate design recommendations.

GENERIC PACKAGE VIEW

RGW 20

VQFN - 1 mm max height

5 x 5, 0.65 mm pitch

PLASTIC QUAD FLATPACK - NO LEAD

This image is a representation of the package family, actual package may vary.
Refer to the product data sheet for package details.

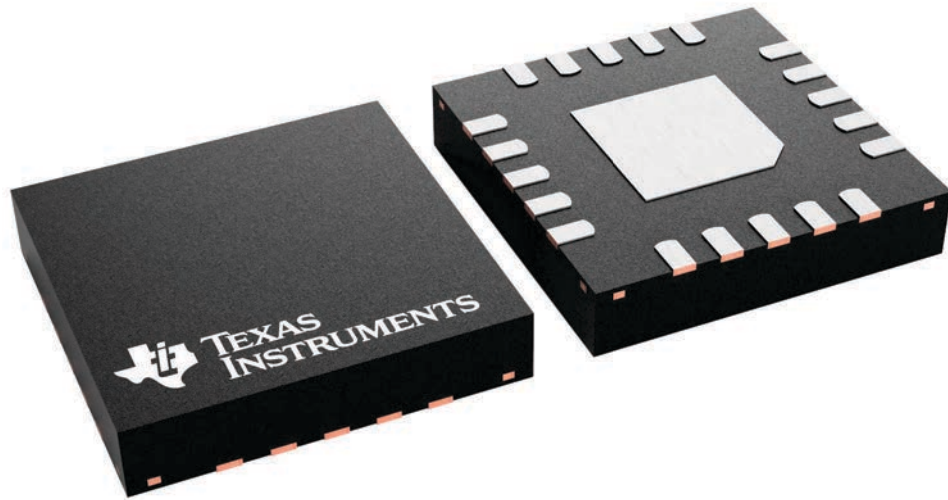

4227157/A

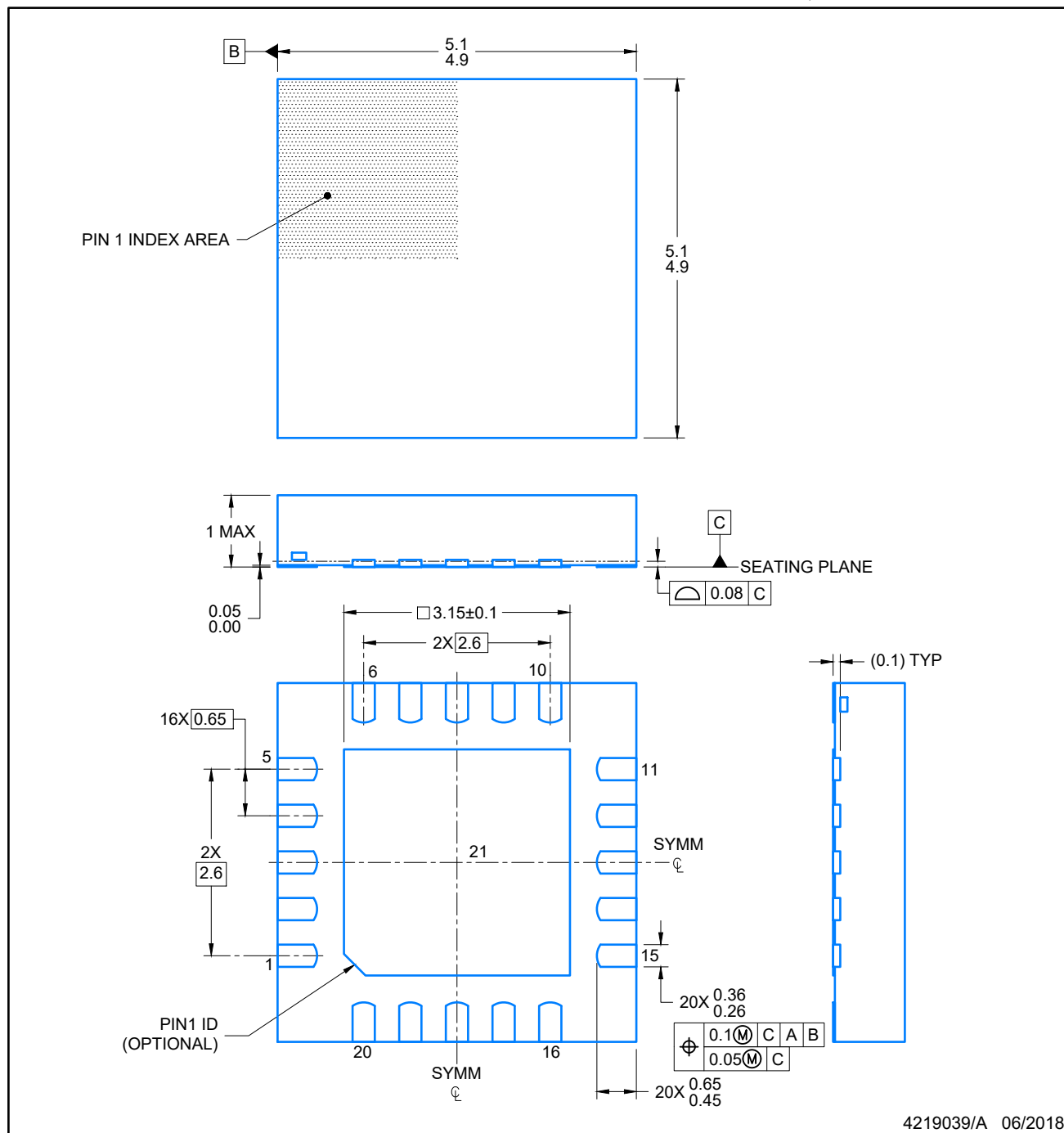

NOTES:

1. All linear dimensions are in millimeters. Any dimensions in parenthesis are for reference only. Dimensioning and tolerancing per ASME Y14.5M.
2. This drawing is subject to change without notice.
3. The package thermal pad must be soldered to the printed circuit board for optimal thermal and mechanical performance.



4219039/A 06/2018

NOTES: (continued)

4. This package is designed to be soldered to a thermal pad on the board. For more information, see Texas Instruments literature number SLUA271 (www.ti.com/lit/sluea271).
5. Vias are optional depending on application, refer to device data sheet. If any vias are implemented, refer to their locations shown on this view. It is recommended that vias under paste be filled, plugged or tented.

EXAMPLE STENCIL DESIGN

VQFN - 1 mm max height

RGW0020A

PLASTIC QUAD FLATPACK-NO LEAD

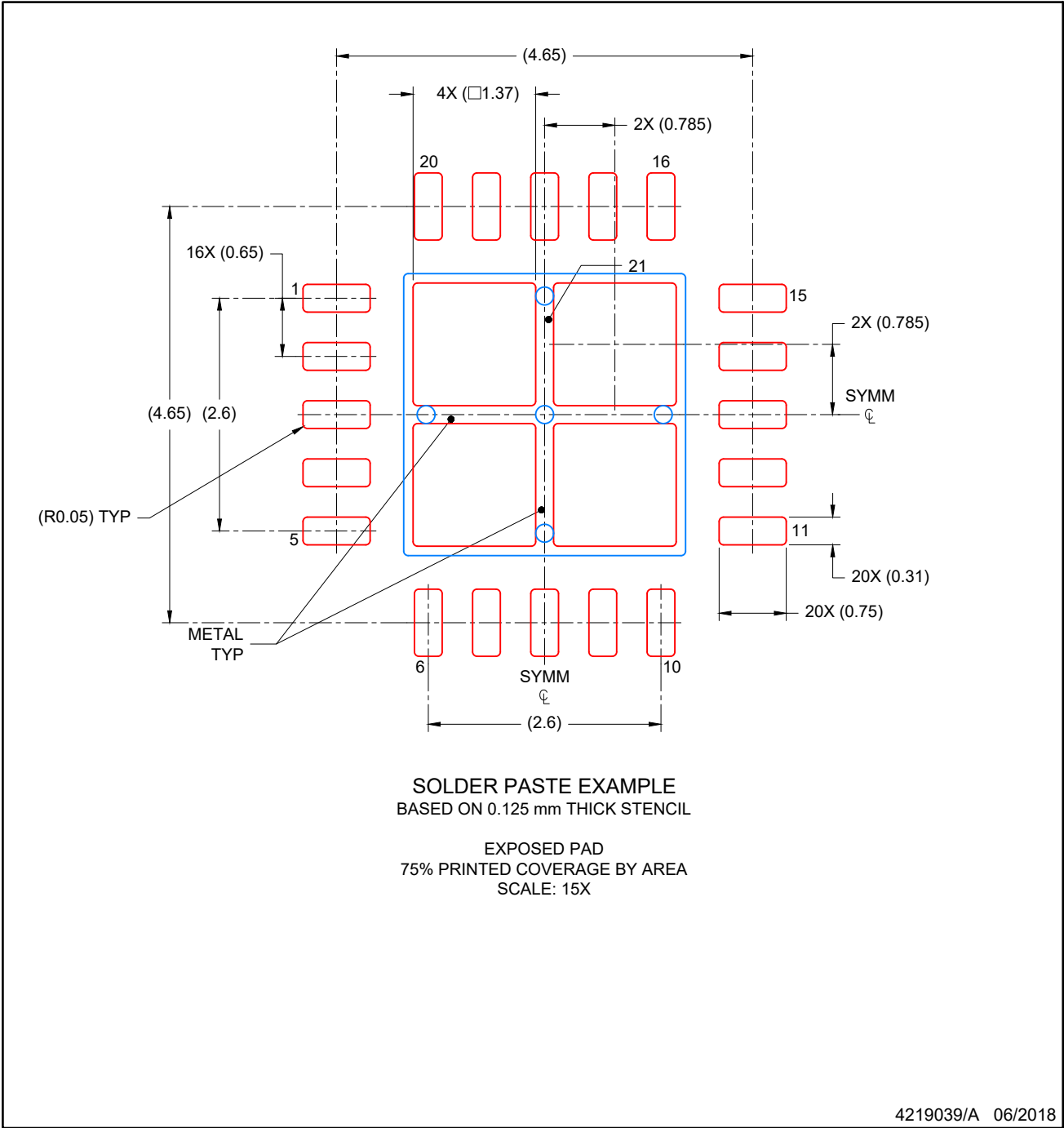

NOTES: (continued)

- 6. Laser cutting apertures with trapezoidal walls and rounded corners may offer better paste release. IPC-7525 may have alternate design recommendations.

IMPORTANT NOTICE AND DISCLAIMER

TI PROVIDES TECHNICAL AND RELIABILITY DATA (INCLUDING DATA SHEETS), DESIGN RESOURCES (INCLUDING REFERENCE DESIGNS), APPLICATION OR OTHER DESIGN ADVICE, WEB TOOLS, SAFETY INFORMATION, AND OTHER RESOURCES "AS IS" AND WITH ALL FAULTS, AND DISCLAIMS ALL WARRANTIES, EXPRESS AND IMPLIED, INCLUDING WITHOUT LIMITATION ANY IMPLIED WARRANTIES OF MERCHANTABILITY, FITNESS FOR A PARTICULAR PURPOSE OR NON-INFRINGEMENT OF THIRD PARTY INTELLECTUAL PROPERTY RIGHTS.

These resources are intended for skilled developers designing with TI products. You are solely responsible for (1) selecting the appropriate TI products for your application, (2) designing, validating and testing your application, and (3) ensuring your application meets applicable standards, and any other safety, security, regulatory or other requirements.

These resources are subject to change without notice. TI grants you permission to use these resources only for development of an application that uses the TI products described in the resource. Other reproduction and display of these resources is prohibited. No license is granted to any other TI intellectual property right or to any third party intellectual property right. TI disclaims responsibility for, and you will fully indemnify TI and its representatives against, any claims, damages, costs, losses, and liabilities arising out of your use of these resources.

TI's products are provided subject to [TI's Terms of Sale](#) or other applicable terms available either on [ti.com](https://www.ti.com) or provided in conjunction with such TI products. TI's provision of these resources does not expand or otherwise alter TI's applicable warranties or warranty disclaimers for TI products.

TI objects to and rejects any additional or different terms you may have proposed.

Mailing Address: Texas Instruments, Post Office Box 655303, Dallas, Texas 75265
Copyright © 2024, Texas Instruments Incorporated