

bq27531-G1 Battery Management Unit Impedance Track™ Fuel Gauge With MaxLife™ Technology for Use With the bq2419x Charger Controller

1 Features

- Battery Fuel Gauge and Charger Controller for 1-Cell Li-Ion Applications
- Resides on System Main Board
- Battery Fuel Gauge Based on Patented Impedance Track™ Technology
 - Models the Battery Discharge Curve for Accurate Time-to-Empty Predictions
 - Automatically Adjusts for Battery Aging, Battery Self-Discharge, and Temperature/Rate Inefficiencies
 - Low-Value Sense Resistor (5 mΩ to 20 mΩ)
- Battery Charger Controller With Customizable Charge Profiles
 - Configurable Charge Voltage and Current Based on Temperature
 - Optional State of Health (SoH) and Multilevel-Based Charge Profiles
- Host-Free Autonomous Battery Management System
 - Reduced Software Overhead Allows for Easy Portability Across Platforms and Shorter OEM Design Cycles
 - Higher Safety and Security
- Intelligent Charging—Customized and Adaptive Charging Profiles
 - Charger Control Based on SoH
 - Temperature Level Charging (TLC)
- Battery Charger Controller for bq2419x Single-Cell Switched-Mode Battery Charger
 - Stand-Alone Charging Solution
 - SHIP Mode Capability
- 400-kHz I²C Interface for Connection to System Microcontroller Port
- In a 15-Pin NanoFree™ Packaging

2 Applications

- Smart Phones, Feature Phones, and Tablets
- Digital Still and Video Cameras
- Handheld Terminals
- MP3 or Multimedia Players

3 Description

The Texas Instruments bq27531-G1 system-side Li-Ion Battery Management Unit is a microcontroller peripheral that provides Impedance Track fuel gauging and charging control for single-cell Li-Ion battery packs. The device requires little system microcontroller firmware development. Together with the bq2419x Single-Cell Switched-Mode Charger, the bq27531-G1 manages an embedded battery (nonremovable) or a removable battery pack.

The bq27531-G1 uses the patented Impedance Track algorithm for fuel gauging, and provides information such as remaining battery capacity (mAh), state-of-charge (%), run time to empty (minimum), battery voltage (mV), temperature (°C), and state of health (%).

Battery fuel gauging with the bq27531-G1 requires only PACK+ (P+), PACK– (P–), and Thermistor (T) connections to a removable battery pack or embedded battery circuit. The CSP option is a 15-pin package in the dimensions of 2.61 mm x 1.96 mm with a 0.5-mm lead pitch, which is ideal for space-constrained applications.

Device Information⁽¹⁾

PART NUMBER	PACKAGE	BODY SIZE (NOM)
bq27531-G1	DSBGA (15)	2.61 mm x 1.96 mm

(1) For all available packages, see the orderable addendum at the end of the data sheet.

Simplified Schematic

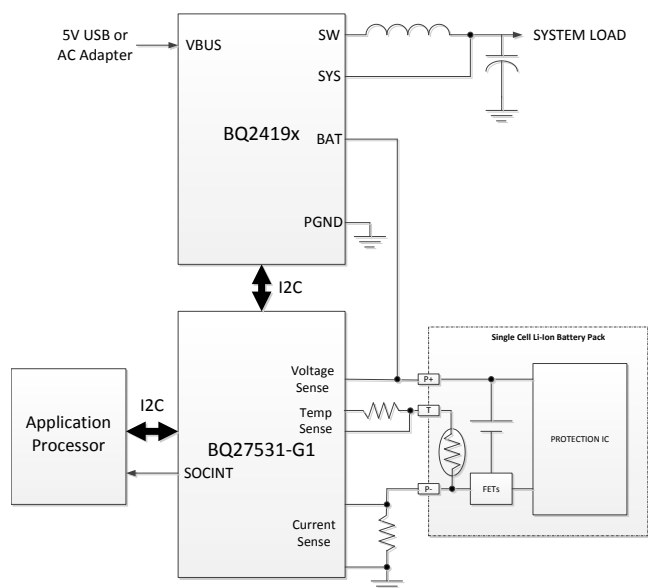

Table of Contents

1 Features	1	7.14 Typical Characteristics	8
2 Applications	1	8 Detailed Description	9
3 Description	1	8.1 Overview	9
4 Revision History	2	8.2 Functional Block Diagram	10
5 Device Options	3	8.3 Feature Description	11
6 Pin Configuration and Functions	3	8.4 Device Functional Modes	12
7 Specifications	4	8.5 Programming	16
7.1 Absolute Maximum Ratings	4	9 Application and Implementation	21
7.2 ESD Ratings	4	9.1 Application Information	21
7.3 Recommended Operating Conditions	4	9.2 Typical Application	21
7.4 Thermal Information	4	10 Power Supply Recommendations	26
7.5 Electrical Characteristics: Supply Current	5	10.1 Power Supply Decoupling	26
7.6 Digital Input and Output DC Characteristics	5	11 Layout	26
7.7 Power-On Reset	5	11.1 Layout Guidelines	26
7.8 2.5-V LDO Regulator	5	11.2 Layout Example	27
7.9 Internal Clock Oscillators	5	12 Device and Documentation Support	28
7.10 ADC (Temperature and Cell Measurement) Characteristics	6	12.1 Documentation Support	28
7.11 Integrating ADC (Coulomb Counter) Characteristics	6	12.2 Community Resources	28
7.12 Data Flash Memory Characteristics	6	12.3 Trademarks	28
7.13 I ² C-Compatible Interface Communication Timing Characteristics	7	12.4 Electrostatic Discharge Caution	28
		12.5 Glossary	28
		13 Mechanical, Packaging, and Orderable Information	28

4 Revision History

Changes from Revision B (September 2015) to Revision C	Page
• Changed ESD Ratings	4

Changes from Revision A (June 2015) to Revision B	Page
• Changed a <i>Pin Functions</i> description to correct the TRM link	3
• Changed Figure 6	13
• Added Figure 7	14

5 Device Options

PART NUMBER	FIRMWARE VERSION	COMMUNICATION FORMAT
bq27531YZFR-G1	1.02 (0x0102)	I ² C
bq27531YZFT-G1		

6 Pin Configuration and Functions

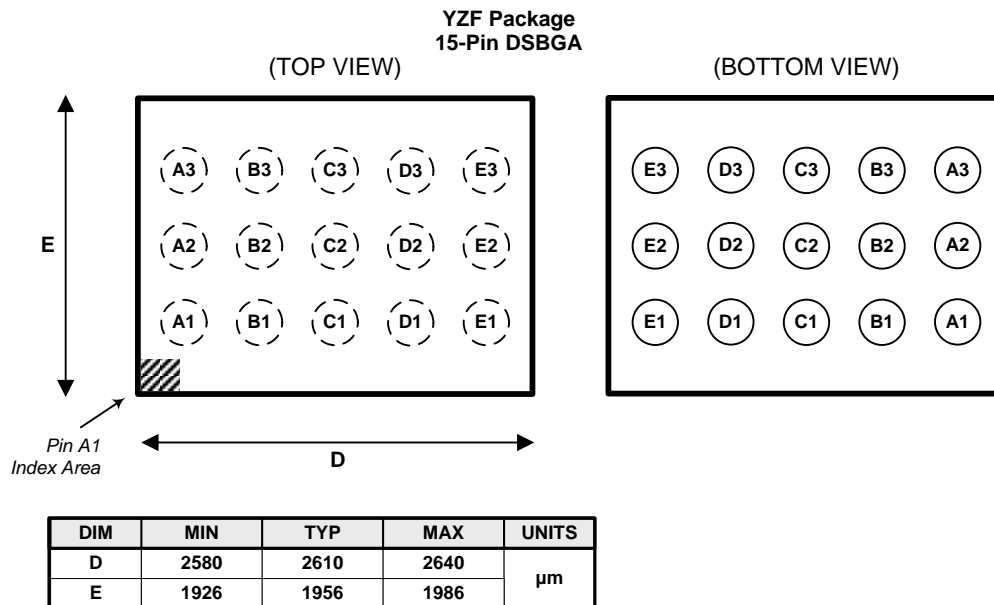

Pin Functions

PIN		I/O ⁽¹⁾	DESCRIPTION
NAME	NO.		
BAT	E2	I	Cell voltage measurement input. ADC input. Recommend 4.8 V maximum for conversion accuracy.
BI/TOUT	E3	I/O	Battery insertion detection input. Power pin for pack thermistor network. Thermistor multiplexer control pin. Use with pullup resistor >1 MΩ (1.8 MΩ typical).
BSDA	C3	I/O	Battery Charger data line for chipset communication. Push-pull output.
B_SCL	B2	O	Battery Charger clock output line for chipset communication. Push-pull output.
CE	D2	I	Chip Enable. Internal LDO is disconnected from REGIN when driven low. Note: CE has an internal ESD protection diode connected to REGIN. Recommend maintaining $V_{CE} \leq V_{REGIN}$ under all conditions.
REGIN	E1	P	Regulator input. Decouple with 0.1-μF ceramic capacitor to Vss.
SCL	A3	I	Slave I ² C serial communications clock input line for communication with system (Master). Open-drain I/O. Use with 10-kΩ pullup resistor (typical).
SDA	B3	I/O	Slave I ² C serial communications data line for communication with system (Master). Open-drain I/O. Use with 10-kΩ pullup resistor (typical).
SOC_INT	A2	I/O	SOC state interrupts output. Generates a pulse as described in the <i>bq27531-G1 Technical Reference Manual (SLUUA96)</i> . Open-drain output.
SRN	B1	IA	Analog input pin connected to the internal coulomb counter where SRN is nearest the Vss connection. Connect to 5-mΩ to 20-mΩ sense resistor.
SRP	A1	IA	Analog input pin connected to the internal coulomb counter where SRP is nearest the PACK– connection. Connect to 5-mΩ to 20-mΩ sense resistor.
TS	D3	IA	Pack thermistor voltage sense (use 103AT-type thermistor). ADC input.
V _{CC}	D1	P	Regulator output and bq27531-G1 power. Decouple with 1-μF ceramic capacitor to Vss.
V _{SS}	C1, C2	P	Device ground

(1) I/O = Digital input/output, IA = Analog input, P = Power connection

7 Specifications

7.1 Absolute Maximum Ratings

 over operating free-air temperature range (unless otherwise noted)⁽¹⁾

		MIN	MAX	UNIT
V _{REGIN}	Regulator input	-0.3	5.5	V
		-0.3	6.0 ⁽²⁾	
V _{CE}	CE input pin	-0.3	V _{REGIN} + 0.3	V
V _{CC}	Supply voltage	-0.3	2.75	V
V _{IOD}	Open-drain I/O pins (SDA, SCL, SOC_INT)	-0.3	5.5	V
V _{BAT}	BAT input pin	-0.3	5.5	V
		-0.3	6.0 ⁽²⁾	
V _I	Input voltage to all other pins (BI/TOUT, TS, SRP, SRN, BSDA, BSCL)	-0.3	V _{CC} + 0.3	V
T _A	Operating free-air temperature	-40	85	°C

- (1) Stresses beyond those listed under *Absolute Maximum Ratings* may cause permanent damage to the device. These are stress ratings only, which do not imply functional operation of the device at these or any other conditions beyond those indicated under *Recommended Operating Conditions*. Exposure to absolute-maximum-rated conditions for extended periods may affect device reliability.
- (2) Condition not to exceed 100 hours at 25°C lifetime.

7.2 ESD Ratings

		VALUE	UNIT
V _(ESD)	Electrostatic discharge	Human body model (HBM), per ANSI/ESDA/JEDEC JS-001, BAT pin ⁽¹⁾	±1500
		Human-body model (HBM), per ANSI/ESDA/JEDEC JS-001, All other pins ⁽¹⁾	±2000
		Charged device model (CDM), per JEDEC specification JESD22-C101 ⁽²⁾	±250

(1) JEDEC document JEP155 states that 500-V HBM allows safe manufacturing with a standard ESD control process.

(2) JEDEC document JEP157 states that 250-V CDM allows safe manufacturing with a standard ESD control process.

7.3 Recommended Operating Conditions

 T_A = -40°C to 85°C, V_{REGIN} = V_{BAT} = 3.6 V (unless otherwise noted)

		MIN	NOM	MAX	UNIT
V _{REGIN}	Supply voltage	No operating restrictions		2.8	V
		No flash writes		2.45	
C _{REGIN}	External input capacitor for internal LDO between REGIN and V _{SS}	Nominal capacitor values specified. Recommend a 5% ceramic X5R type capacitor located close to the device.		0.1	µF
C _{LDO25}	External output capacitor for internal LDO between V _{CC} and V _{SS}	0.47	1		µF
t _{PUCD}	Power-up communication delay			250	ms

7.4 Thermal Information

THERMAL METRIC ⁽¹⁾		bq27531-G1		UNIT
		YZF [DSBGA]		
		15 PINS		
R _{θJA}	Junction-to-ambient thermal resistance	70		°C/W
R _{θJC(top)}	Junction-to-case(top) thermal resistance	17		°C/W
R _{θJB}	Junction-to-board thermal resistance	20		°C/W
Ψ _{JT}	Junction-to-top characterization parameter	1		°C/W
Ψ _{JB}	Junction-to-board characterization parameter	18		°C/W
R _{θJC(bot)}	Junction-to-case(bottom) thermal resistance	N/A		°C/W

- (1) For more information about traditional and new thermal metrics, see the *Semiconductor and IC Package Thermal Metrics* application report, [SPRA953](#).

7.5 Electrical Characteristics: Supply Current

 $T_A = 25^\circ\text{C}$ and $V_{\text{REGIN}} = V_{\text{BAT}} = 3.6\text{ V}$ (unless otherwise noted)

PARAMETER		TEST CONDITIONS	MIN	TYP	MAX	UNIT
$I_{\text{CC}}^{(1)}$	NORMAL operating mode current	Fuel gauge in NORMAL mode $I_{\text{LOAD}} > \textit{Sleep current}$		118		μA
$I_{\text{SLP+}}^{(1)}$	SLEEP+ operating mode current	Fuel gauge in SLEEP+ mode $I_{\text{LOAD}} < \textit{Sleep current}$		62		μA
$I_{\text{SLP}}^{(1)}$	Low-power storage mode current	Fuel gauge in SLEEP mode $I_{\text{LOAD}} < \textit{Sleep current}$		23		μA
$I_{\text{HIB}}^{(1)}$	HIBERNATE operating mode current	Fuel gauge in HIBERNATE mode $I_{\text{LOAD}} < \textit{Hibernate current}$		8		μA

(1) Specified by design. Not production tested.

7.6 Digital Input and Output DC Characteristics

 $T_A = -40^\circ\text{C}$ to 85°C , typical values at $T_A = 25^\circ\text{C}$ and $V_{\text{REGIN}} = 3.6\text{ V}$ (unless otherwise noted)

PARAMETER		TEST CONDITIONS	MIN	TYP	MAX	UNIT
V_{OL}	Output voltage, low (SCL, SDA, SOC_INT, BSDA, BSCL)	$I_{\text{OL}} = 3\text{ mA}$			0.4	V
$V_{\text{OH(PP)}}$	Output voltage, high (BSDA, BSCL)	$I_{\text{OH}} = -1\text{ mA}$	$V_{\text{CC}} - 0.5$			V
$V_{\text{OH(OD)}}$	Output voltage, high (SDA, SCL, SOC_INT)	External pullup resistor connected to V_{CC}	$V_{\text{CC}} - 0.5$			
V_{IL}	Input voltage, low (SDA, SCL)		-0.3		0.6	V
	Input voltage, low (BI/TOUT)	BAT INSERT CHECK mode active	-0.3		0.6	
V_{IH}	Input voltage, high (SDA, SCL)		1.2			V
	Input voltage, high (BI/TOUT)	BAT INSERT CHECK mode active	1.2	$V_{\text{CC}} + 0.3$		
$V_{\text{IL(CE)}}$	Input voltage, low (CE)	$V_{\text{REGIN}} = 2.8\text{ V}$ to 4.5 V			0.8	V
$V_{\text{IH(CE)}}$	Input voltage, high (CE)		2.65			
$I_{\text{IKG}}^{(1)}$	Input leakage current (I/O pins)				0.3	μA

(1) Specified by design. Not production tested.

7.7 Power-On Reset

 $T_A = -40^\circ\text{C}$ to 85°C , typical values at $T_A = 25^\circ\text{C}$ and $V_{\text{REGIN}} = 3.6\text{ V}$ (unless otherwise noted)

PARAMETER		TEST CONDITIONS	MIN	TYP	MAX	UNIT
$V_{\text{IT+}}$	Positive-going battery voltage input at V_{CC}		2.05	2.15	2.20	V
V_{HYS}	Power-on reset hysteresis			115		mV

7.8 2.5-V LDO Regulator

 $T_A = -40^\circ\text{C}$ to 85°C , $C_{\text{LDO25}} = 1\text{ }\mu\text{F}$, $V_{\text{REGIN}} = 3.6\text{ V}$ (unless otherwise noted)

PARAMETER		TEST CONDITION	MIN	TYP	MAX	UNIT
V_{REG25}	Regulator output voltage (V_{CC})	$2.8\text{ V} \leq V_{\text{REGIN}} \leq 4.5\text{ V}$, $I_{\text{OUT}} \leq 16\text{ mA}^{(1)}$	2.3	2.5	2.6	V
		$2.45\text{ V} \leq V_{\text{REGIN}} < 2.8\text{ V}$ (low battery), $I_{\text{OUT}} \leq 3\text{ mA}$	2.3			

(1) LDO output current, I_{OUT} , is the total load current. LDO regulator must be used to power internal fuel gauge only.

7.9 Internal Clock Oscillators

 $T_A = -40^\circ\text{C}$ to 85°C , $2.4\text{ V} < V_{\text{CC}} < 2.6\text{ V}$; typical values at $T_A = 25^\circ\text{C}$ and $V_{\text{CC}} = 2.5\text{ V}$ (unless otherwise noted)

PARAMETER		TEST CONDITIONS	MIN	TYP	MAX	UNIT
f_{OSC}	High-frequency oscillator			8.389		MHz
f_{LOSC}	Low-frequency oscillator			32.768		kHz

7.10 ADC (Temperature and Cell Measurement) Characteristics

 $T_A = -40^\circ\text{C}$ to 85°C , $2.4\text{ V} < V_{CC} < 2.6\text{ V}$; typical values at $T_A = 25^\circ\text{C}$ and $V_{CC} = 2.5\text{ V}$ (unless otherwise noted)

PARAMETER	TEST CONDITIONS	MIN	TYP	MAX	UNIT
V_{ADC1}	Input voltage (TS)	$V_{\text{SS}} - 0.125$		2	V
V_{ADC2}	Input voltage (BAT)	$V_{\text{SS}} - 0.125$		5	V
$V_{\text{IN(ADC)}}$	Input voltage	0.05		1	V
G_{TEMP}	Internal temperature sensor voltage gain		-2		mV/°C
$t_{\text{ADC_CONV}}$	Conversion time			125	ms
	Resolution	14		15	bits
$V_{\text{OS(ADC)}}$	Input offset		1		mV
$Z_{\text{ADC1}}^{(1)}$	Effective input resistance (TS)	8			MΩ
$Z_{\text{ADC2}}^{(1)}$	Effective input resistance (BAT)	bq27531-G1 not measuring cell voltage		8	MΩ
		bq27531-G1 measuring cell voltage		100	kΩ
$I_{\text{lkq(ADC)}}^{(1)}$	Input leakage current			0.3	μA

(1) Specified by design. Not tested in production.

7.11 Integrating ADC (Coulomb Counter) Characteristics

 $T_A = -40^\circ\text{C}$ to 85°C , $2.4\text{ V} < V_{CC} < 2.6\text{ V}$; typical values at $T_A = 25^\circ\text{C}$ and $V_{CC} = 2.5\text{ V}$ (unless otherwise noted)

PARAMETER	TEST CONDITIONS	MIN	TYP	MAX	UNIT
V_{SR}	Input voltage, $V_{\text{(SRP)}}$ and $V_{\text{(SRN)}}$	$V_{\text{SR}} = V_{\text{(SRP)}} - V_{\text{(SRN)}}$	-0.125	0.125	V
$t_{\text{SR_CONV}}$	Conversion time		1		s
	Resolution	14		15	bits
$V_{\text{OS(SR)}}$	Input offset		10		μV
INL	Integral nonlinearity error		±0.007%	±0.034%	FSR
$Z_{\text{IN(SR)}}^{(1)}$	Effective input resistance	2.5			MΩ
$I_{\text{lkq(SR)}}^{(1)}$	Input leakage current			0.3	μA

(1) Specified by design. Not tested in production.

7.12 Data Flash Memory Characteristics

 $T_A = -40^\circ\text{C}$ to 85°C , $2.4\text{ V} < V_{CC} < 2.6\text{ V}$; typical values at $T_A = 25^\circ\text{C}$ and $V_{CC} = 2.5\text{ V}$ (unless otherwise noted)

PARAMETER	TEST CONDITIONS	MIN	TYP	MAX	UNIT
$t_{\text{DR}}^{(1)}$	Data retention	10			Years
	Flash-programming write cycles ⁽¹⁾	20000			Cycles
$t_{\text{WORDPROG}}^{(1)}$	Word programming time			2	ms
$I_{\text{CCPROG}}^{(1)}$	Flash-write supply current		5	10	mA
$t_{\text{DFERASE}}^{(1)}$	Data flash master erase time	200			ms
$t_{\text{IFERASE}}^{(1)}$	Instruction flash master erase time	200			ms
$t_{\text{PGERASE}}^{(1)}$	Flash page erase time	20			ms

(1) Specified by design. Not production tested.

7.13 I²C-Compatible Interface Communication Timing Characteristics

T_A = -40°C to 85°C, 2.4 V < V_{CC} < 2.6 V; typical values at T_A = 25°C and V_{CC} = 2.5 V (unless otherwise noted)

PARAMETER	MIN	NOM	MAX	UNIT
t _r			300	ns
t _f			300	ns
t _{w(H)}	600			ns
t _{w(L)}	1.3			μs
t _{su(STA)}	600			ns
t _{d(STA)}	600			ns
t _{su(DAT)}	100			ns
t _{h(DAT)}	0			ns
t _{su(STOP)}	600			ns
t _(BUF)	66			μs
f _{SCL}			400	kHz

(1) If the clock frequency (f_{SCL}) is > 100 kHz, use 1-byte write commands for proper operation. All other transactions types are supported at 400 kHz. (See [I²C Interface](#) and [I²C Command Waiting Time](#)).

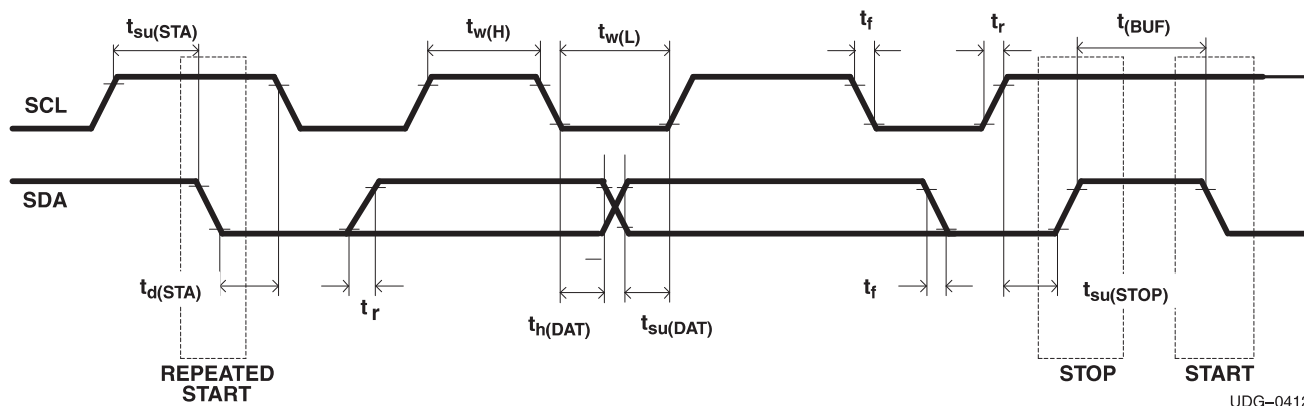

Figure 1. I²C-Compatible Interface Timing Diagrams

7.14 Typical Characteristics

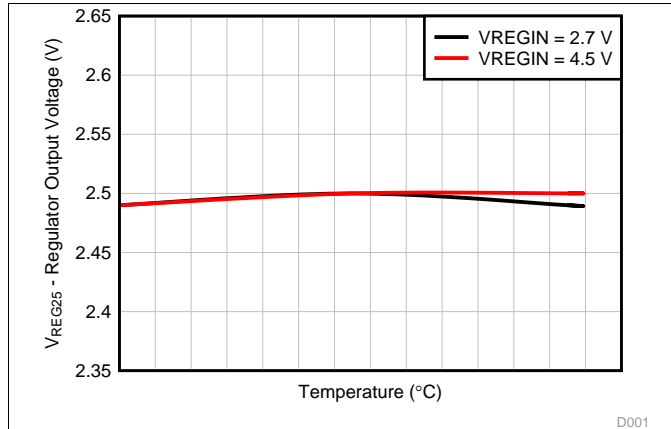

Figure 2. Regulator Output Voltage vs Temperature

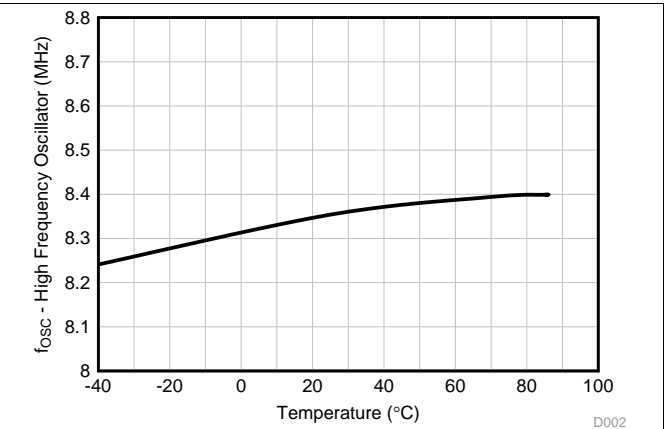

Figure 3. High-Frequency Oscillator Frequency vs Temperature

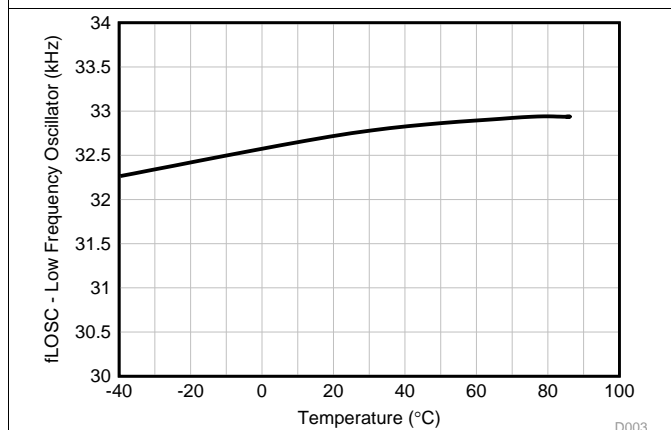

Figure 4. Low-Frequency Oscillator Frequency vs Temperature

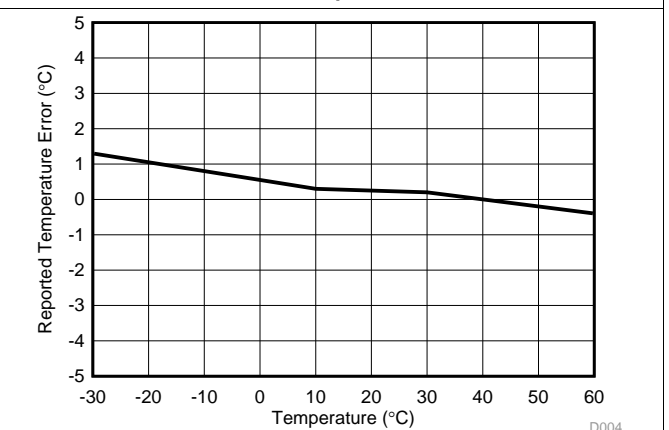

Figure 5. Reported Internal Temperature Measurement vs Temperature

8 Detailed Description

8.1 Overview

The fuel gauge accurately predicts the battery capacity and other operational characteristics of a single, Li-based, rechargeable cell. It can be interrogated by a system processor to provide cell information, such as remaining capacity and state-of-charge (SOC) as well as SOC interrupt signal to the host.

The fuel gauge can control a bq2419x Charger IC without the intervention from an application system processor. Using the bq27531-G1 and bq2419x chipset, batteries can be charged with the typical constant-current, constant-voltage (CCCV) profile or charged using a Multi-Level Charging (MLC) algorithm.

NOTE

Formatting conventions used in this document:

Commands: italics with parentheses and no breaking spaces, for example, *Control()*

Data flash: italics, bold, and breaking spaces, for example, ***Design Capacity***

Register bits and flags: brackets and italics, for example, *[TDA]*

Data flash bits: brackets, italics and bold, for example, ***[LED1]***

Modes and states: ALL CAPITALS, for example, UNSEALED mode

8.3 Feature Description

Information is accessed through a series of commands, called *Standard Commands*. Further capabilities are provided by the additional *Extended Commands* set. Both sets of commands, indicated by the general format *Command()*, are used to read and write information contained within the control and status registers, as well as its data flash locations. Commands are sent from system to gauge using the I²C serial communications engine, and can be executed during application development, pack manufacture, or end-equipment operation.

Cell information is stored in nonvolatile flash memory. Many of these data flash locations are accessible during application development. They cannot, generally, be accessed directly during end-equipment operation. Access to these locations is achieved by either use of the companion evaluation software, through individual commands, or through a sequence of data-flash access commands. To access a desired data flash location, the correct data flash subclass and offset must be known.

The key to the high-accuracy gas gauging prediction is the TI proprietary Impedance Track algorithm. This algorithm uses cell measurements, characteristics, and properties to create SOC predictions that can achieve less than 1% error across a wide variety of operating conditions and over the lifetime of the battery.

The fuel gauge measures the charging and discharging of the battery by monitoring the voltage across a small-value series sense resistor (5 to 20 mΩ, typical) located between the system VSS and the battery PACK-terminal. When a cell is attached to the fuel gauge, cell impedance is computed, based on cell current, cell open-circuit voltage (OCV), and cell voltage under loading conditions.

The external temperature sensing is optimized with the use of a high-accuracy negative temperature coefficient (NTC) thermistor with $R_{25} = 10.0 \text{ k}\Omega \pm 1\%$, $B_{25/85} = 3435 \text{ K} \pm 1\%$ (such as Semitec NTC 103AT). The fuel gauge can also be configured to use its internal temperature sensor. When an external thermistor is used, a 18.2-kΩ pullup resistor between the BI/TOUT and TS pins is also required. The fuel gauge uses temperature to monitor the battery-pack environment, which is used for fuel gauging and cell protection functionality.

To minimize power consumption, the fuel gauge has different power modes: NORMAL, SLEEP, SLEEP+, HIBERNATE, and BAT INSERT CHECK. The fuel gauge passes automatically between these modes, depending upon the occurrence of specific events, though a system processor can initiate some of these modes directly.

For complete operational details, see the *bq27531-G1 Technical Reference Manual (SLUUA96)*.

8.3.1 Functional Description

The fuel gauge measures the cell voltage, temperature, and current to determine battery SOC. The fuel gauge monitors the charging and discharging of the battery by sensing the voltage across a small-value resistor (5 mΩ to 20 mΩ, typical) between the SRP and SRN pins and in series with the cell. By integrating charge passing through the battery, the battery SOC is adjusted during battery charge or discharge.

The total battery capacity is found by comparing states of charge before and after applying the load with the amount of charge passed. When an application load is applied, the impedance of the cell is measured by comparing the OCV obtained from a predefined function for present SOC with the measured voltage under load. Measurements of OCV and charge integration determine chemical SOC and chemical capacity (Q_{max}). The initial Q_{max} values are taken from a cell manufacturer's data sheet multiplied by the number of parallel cells. It is also used for the value in **Design Capacity**. The fuel gauge acquires and updates the battery-impedance profile during normal battery usage. It uses this profile, along with SOC and the Q_{max} value, to determine *FullChargeCapacity()* and *StateOfCharge()*, specifically for the present load and temperature. *FullChargeCapacity()* is reported as capacity available from a fully-charged battery under the present load and temperature until *Voltage()* reaches the **Terminate Voltage**. *NominalAvailableCapacity()* and *FullAvailableCapacity()* are the uncompensated (no or light load) versions of *RemainingCapacity()* and *FullChargeCapacity()*, respectively.

The fuel gauge has two flags accessed by the *Flags()* function that warn when the battery SOC has fallen to critical levels. When *RemainingCapacity()* falls below the first capacity threshold as specified in **SOC1 Set Threshold**, the [SOC1] (State of Charge Initial) flag is set. The flag is cleared once *RemainingCapacity()* rises above **SOC1 Clear Threshold**.

When the voltage is discharged to **Terminate Voltage**, the SOC will be set to 0.

8.4 Device Functional Modes

8.4.1 Power Modes

The fuel gauge has different power modes:

- **BAT INSERT CHECK:** The BAT INSERT CHECK mode is a powered-up, but low-power halted, state where the fuel gauge resides when no battery is inserted into the system.
- **NORMAL:** In NORMAL mode, the fuel gauge is fully powered and can execute any allowable task.
- **SLEEP:** In SLEEP mode, the fuel gauge turns off the high-frequency oscillator and exists in a reduced- power state, periodically taking measurements and performing calculations.
- **SLEEP+:** In SLEEP+ mode, both low-frequency and high-frequency oscillators are active. Although the SLEEP+ mode has higher current consumption than the SLEEP mode, it is also a reduced power mode.
- **HIBERNATE:** In HIBERNATE mode, the fuel gauge is in a low power state, but can be woken up by communication or certain I/O activity.

The relationship between these modes is shown in [Figure 6](#) and [Figure 7](#).

8.4.1.1 BAT INSERT CHECK Mode

This mode is a halted-CPU state that occurs when an adapter, or other power source, is present to power the fuel gauge (and system), yet no battery has been detected. When battery insertion is detected, a series of initialization activities begin, which include: OCV measurement, setting the *Flags()* [BAT_DET] bit, and selecting the appropriate battery profiles.

Some commands, issued by a system processor, can be processed while the fuel gauge is halted in this mode. The gauge wakes up to process the command, then returns to the halted state awaiting battery insertion.

8.4.1.2 NORMAL Mode

The fuel gauge is in NORMAL mode when not in any other power mode. During this mode, *AverageCurrent()*, *Voltage()*, and *Temperature()* measurements are taken, and the interface data set is updated. Decisions to change states are also made. This mode is exited by activating a different power mode.

Because the gauge consumes the most power in NORMAL mode, the Impedance Track algorithm minimizes the time the fuel gauge remains in this mode.

8.4.1.3 SLEEP Mode

SLEEP mode is entered automatically if the feature is enabled (**Op Config [SLEEP] = 1**) and *AverageCurrent()* is below the programmable level **Sleep Current**. Once entry into SLEEP mode has been qualified, but prior to entering it, the fuel gauge performs a coulomb counter autocalibration to minimize offset.

During SLEEP mode, the fuel gauge periodically takes data measurements and updates its data set. However, a majority of its time is spent in an idle condition.

The fuel gauge exits SLEEP mode if any entry condition is broken, specifically when:

- *AverageCurrent()* rises above **Sleep Current**, or
- A current in excess of I_{WAKE} through R_{SENSE} is detected.

In the event that a battery is removed from the system while a charger is present (and powering the gauge), Impedance Track updates are not necessary. Hence, the fuel gauge enters a state that checks for battery insertion and does not continue executing the Impedance Track algorithm.

Device Functional Modes (continued)

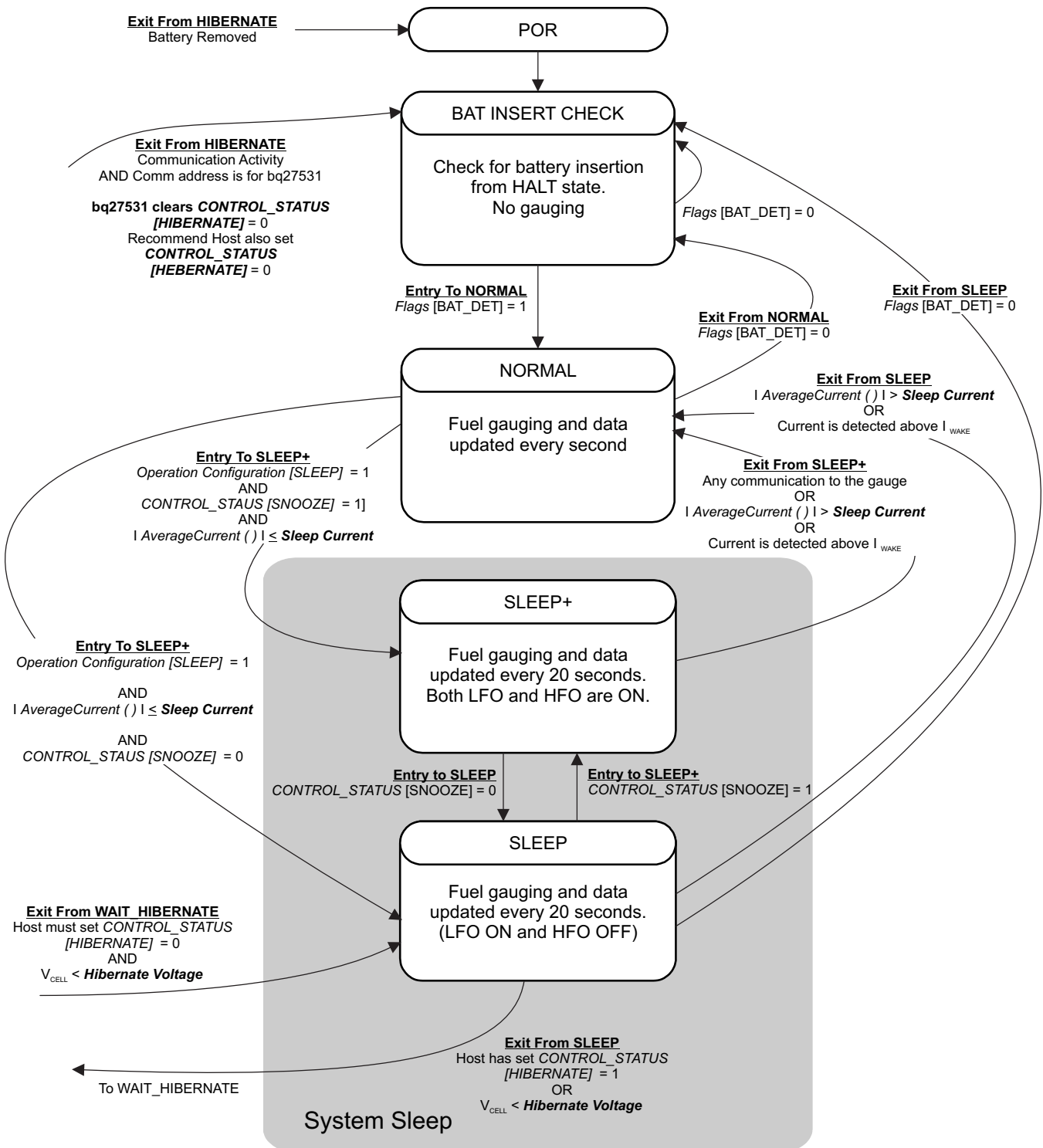

Figure 6. Power Mode Diagram—System Sleep

Device Functional Modes (continued)

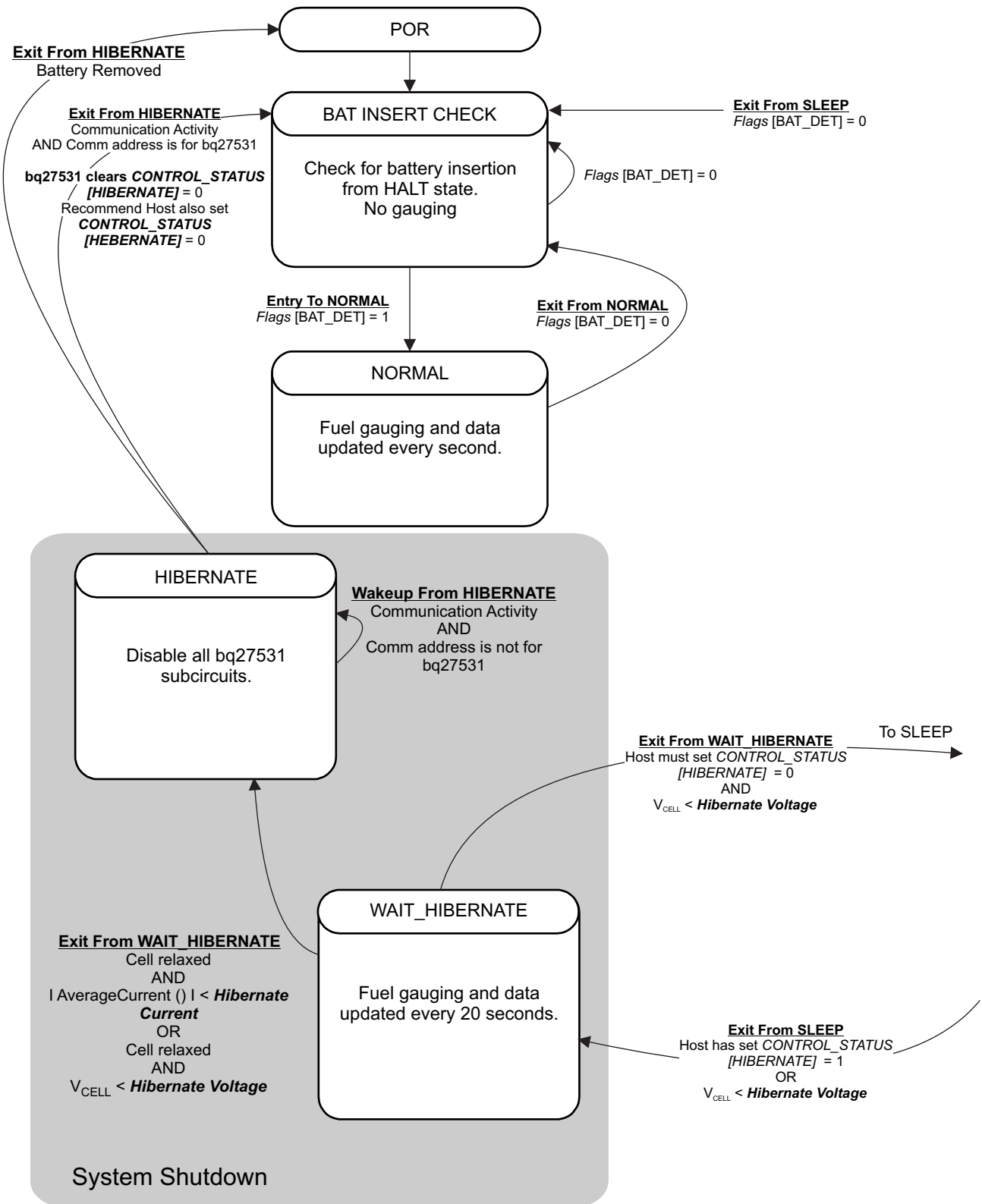

Figure 7. Power Mode Diagram—System Shutdown

Device Functional Modes (continued)

8.4.2 SLEEP+ Mode

Compared to the SLEEP mode, SLEEP+ mode has the high-frequency oscillator in operation. The communication delay could be eliminated. The SLEEP+ mode is entered automatically if the feature is enabled (*CONTROL_STATUS [SNOOZE] = 1*) and *AverageCurrent()* is below the programmable level **Sleep Current**.

During SLEEP+ mode, the fuel gauge periodically takes data measurements and updates its data set. However, a majority of its time is spent in an idle condition.

The fuel gauge exits SLEEP+ mode if any entry condition is broken, specifically when:

- Any communication activity with the gauge, or
- *AverageCurrent()* rises above **Sleep Current**, or
- A current in excess of I_{WAKE} through R_{SENSE} is detected.

8.4.3 HIBERNATE Mode

HIBERNATE mode should be used when the system equipment needs to enter a low-power state, and minimal gauge power consumption is required. This mode is ideal when system equipment is set to its own HIBERNATE, SHUTDOWN, or OFF mode.

Before the fuel gauge can enter HIBERNATE mode, the system must set the *CONTROL_STATUS [HIBERNATE]* bit. The gauge waits to enter HIBERNATE mode until it has taken a valid OCV measurement and the magnitude of the average cell current has fallen below **Hibernate Current**. The gauge can also enter HIBERNATE mode if the cell voltage falls below **Hibernate Voltage** and a valid OCV measurement has been taken. The gauge remains in HIBERNATE mode until the system issues a direct I 2 C command to the gauge or a POR occurs. Any I 2 C communication that is not directed to the gauge does not wake the gauge.

It is the responsibility of the system to wake the fuel gauge after it has gone into HIBERNATE mode. After waking, the gauge can proceed with the initialization of the battery information (OCV, profile selection, and so forth).

8.5 Programming

8.5.1 Data Commands

8.5.1.1 Standard Data Commands

The bq27531-G1 uses a series of 2-byte standard commands to enable system reading and writing of battery information. Each standard command has an associated command-code pair, as indicated in [Table 1](#). Because each command consists of two bytes of data, two consecutive I²C transmissions must be executed both to initiate the command function, and to read or write the corresponding two bytes of data. Additional details are found in the *bq27531-G1 Technical Reference Manual* ([SLUUA96](#)).

Table 1. Standard Commands

NAME	COMMAND CODE	UNIT	SEALED ACCESS	UNSEALED ACCESS
<i>Control()</i>	0x00 and 0x01	NA	R/W	R/W
<i>AtRate()</i>	0x02 and 0x03	mA	R/W	R/W
<i>AtRateTimeToEmpty()</i>	0x04 and 0x05	Minutes	R	R/W
<i>Temperature()</i>	0x06 and 0x07	0.1 K	R/W	R/W
<i>Voltage()</i>	0x08 and 0x09	mV	R	R/W
<i>Flags()</i>	0x0A and 0x0B	Hex	R	R/W
<i>NominalAvailableCapacity()</i>	0x0C and 0x0D	mAh	R	R/W
<i>FullAvailableCapacity()</i>	0x0E and 0x0F	mAh	R	R/W
<i>RemainingCapacity()</i>	0x10 and 0x11	mAh	R	R/W
<i>FullChargeCapacity()</i>	0x12 and 0x13	mAh	R	R/W
<i>AverageCurrent()</i>	0x14 and 0x15	mA	R	R/W
<i>TimeToEmpty()</i>	0x16 and 0x17	Minutes	R	R/W
<i>RemainingCapacityUnfiltered()</i>	0x18 and 0x19	mAh	R	R/W
<i>StandbyCurrent()</i>	0x1A and 0x1B	mA	R	R/W
<i>RemainingCapacityFiltered()</i>	0x1C and 0x1D	mAh	R	R/W
<i>ProgChargingCurrent()</i>	0x1E and 0x1F	mA	R ⁽¹⁾	R ⁽¹⁾
<i>ProgChargingVoltage()</i>	0x20 and 0x21	mV	R ⁽¹⁾	R ⁽¹⁾
<i>FullChargeCapacityUnfiltered()</i>	0x22 and 0x23	mAh	R	R/W
<i>AveragePower()</i>	0x24 and 0x25	mW	R	R/W
<i>FullChargeCapacityFiltered()</i>	0x26 and 0x27	mAh	R	R/W
<i>StateOfHealth()</i>	0x28 and 0x29	%/num	R	R/W
<i>CycleCount()</i>	0x2A and 0x2B	Counters	R	R/W
<i>StateOfCharge()</i>	0x2C and 0x2D	%	R	R/W
<i>TrueSOC()</i>	0x2E and 0x2F	%	R	R/W
<i>InstantaneousCurrentReading()</i>	0x30 and 0x31	mA	R	R/W
<i>InternalTemperature()</i>	0x32 and 0x33	0.1 K	R	R/W
<i>ChargingLevel()</i>	0x34 and 0x35	Num	R	R
<i>LevelTaperCurrent()</i>	0x6E and 0x6F	mA	R	R
<i>CalcChargingCurrent()</i>	0x70 and 0x71	mA	R	R
<i>CalcChargingVoltage()</i>	0x72 and 0x73	V	R	R

(1) Only writeable when **Charger Options [BYPASS]** is set.

8.5.1.1.1 Control(): 0x00/0x01

Issuing a *Control()* command requires a subsequent 2-byte subcommand. These additional bytes specify the particular control function desired. The *Control()* command allows the system to control specific features of the bq27531-G1 during normal operation and additional features when the device is in different access modes, as described in [Table 2](#). Additional details are found in the *bq27531-G1 Technical Reference Manual (SLUUA96)*.

Table 2. Control() Subcommands

CNTL FUNCTION	CNTL DATA	SEALED ACCESS	DESCRIPTION
CONTROL_STATUS	0x0000	Yes	Reports the status of hibernate, IT, and so forth
DEVICE_TYPE	0x0001	Yes	Reports the device type (for example, 0x0531 for bq27531)
FW_VERSION	0x0002	Yes	Reports the firmware version on the device type
HW_VERSION	0x0003	Yes	Reports the hardware version of the device type
PREV_MACWRITE	0x0007	Yes	Returns previous MAC subcommand code
CHEM_ID	0x0008	Yes	Reports the chemical identifier of the Impedance Track configuration
BOARD_OFFSET	0x0009	No	Forces the device to measure and store the board offset
CC_OFFSET	0x000a	No	Forces the device to measure the internal CC offset
CC_OFFSET_SAVE	0x000b	No	Forces the device to store the internal CC offset
OCV_CMD	0x000c	Yes	Request the gauge to take a OCV measurement
BAT_INSERT	0x000d	Yes	Forces the BAT_DET bit set when the [BIE] bit is 0
BAT_REMOVE	0x000e	Yes	Forces the BAT_DET bit clear when the [BIE] bit is 0
SET_HIBERNATE	0x0011	Yes	Forces CONTROL_STATUS [HIBERNATE] to 1
CLEAR_HIBERNATE	0x0012	Yes	Forces CONTROL_STATUS [HIBERNATE] to 0
SET_SLEEP+	0x0013	Yes	Forces CONTROL_STATUS [SNOOZE] to 1
CLEAR_SLEEP+	0x0014	Yes	Forces CONTROL_STATUS [SNOOZE] to 0
OTG_ENABLE	0x0015	Yes	Commands the bq2419x into USB On The Go mode
OTG_DISABLE	0x0016	Yes	Disables OTG mode at the bq2419x
DIV_CUR_ENABLE	0x0017	Yes	Makes the programmed charge current to be half of what is calculated by the gauge charging algorithm.
CHG_ENABLE	0x001A	Yes	Enable charger. Charge will continue as dictated by gauge charging algorithm.
CHG_DISABLE	0x001B	Yes	Disable charger (Set \overline{CE} bit of bq2419x)
GG_CHGRCTL_ENABLE	0x001C	Yes	Enables the gas gauge to control the charger while continuously resetting the charger watchdog
GG_CHGRCTL_DISABLE	0x001D	Yes	The gas gauge stops resetting the charger watchdog
DIV_CUR_DISABLE	0x001E	Yes	Makes the programmed charge current to be same as what is calculated by the gauge charging algorithm.
DF_VERSION	0x001F	Yes	Returns the data flash version
SEALED	0x0020	No	Places device in SEALED access mode
IT_ENABLE	0x0021	No	Enables the Impedance Track algorithm
RESET	0x0041	No	Forces a full reset of the bq27531-G1
SHIPMODE_ENABLE	0x0050	Yes	Commands the bq2419x to turn off BATFET after a delay time programmed in data flash so that system load does not draw power from battery
SHIPMODE_DISABLE	0x0051	Yes	Commands the bq2419x to disregard turning off BATFET before delay time or turns on commands BATFET to turn on if an VBUS had power during the SHIPMODE enabling process

8.5.1.2 Charger Data Commands

The charger registers are mapped to a series of single byte Charger Data Commands to enable system reading and writing of battery charger registers. During charger power up, the registers are initialized to Charger Reset State. The fuel gauge can change the values of these registers during the System Reset State.

Each of the bits in the Charger Data Commands can be read/write. It is important to note that System Access can be different from the read/write access as defined in bq2419x charger hardware. The fuel gauge may block write access to the charger hardware when the bit function is controlled by the fuel gauge exclusively. For example, the [VREGx] bits of *Chrgr_Voltage_Reg4* are controlled by the fuel gauge and cannot be modified by system.

The bq27531 reads the corresponding registers of *System_Stat_Reg8()* and *Fault_Reg9()* every second to mirror the charger status. Other registers in the bq2419x are read when registers are modified by the bq27531.

Table 3. Charger Data Commands

NAME		COMMAND CODE	bq2419x CHARGER MEMORY LOCATION	SEALED ACCESS	UNSEALED ACCESS	REFRESH RATE
<i>ChargerStatus()</i>	CHGRSTAT	0x74	NA	R	R	Every second
<i>Chrgr_InCtrl_Reg0()</i>	CHGR0	0x75	0x00	R/W	R/W	Data Change
<i>Chrgr_POR_Config_Reg1()</i>	CHGR1	0x76	0x01	R/W	R/W	Data Change
<i>Chrgr_Current_Reg2()</i>	CHGR2	0x77	0x02	R/W	R/W	Data Change
<i>Chrgr_PreTerm_Reg3()</i>	CHGR3	0x78	0x03	R/W	R/W	Data Change
<i>Chrgr_Voltage_Reg4()</i>	CHGR4	0x79	0x04	R/W	R/W	Data Change
<i>Chrgr_TermTimer_Reg5()</i>	CHGR5	0x7a	0x05	R/W	R/W	Data Change
<i>Chrgr_IRThermal_Reg6()</i>	CHGR6	0x7b	0x06	R/W	R/W	Data Change
<i>Chrgr_OpCtrl_Reg7()</i>	CHGR7	0x7c	0x07	R/W	R/W	Data Change
<i>Chrgr_Status_Reg8()</i>	CHGR8	0x7d	0x08	R/W	R/W	Every Second
<i>Chrgr_Fault_Reg9()</i>	CHGR9	0x7e	0x09	R/W	R/W	Every Second
<i>Chrgr_Rev_RegA()</i>	CHGRA	0x7f	0x0a	R/W	R/W	Data Change

8.5.2 Communications

8.5.2.1 I²C Interface

The fuel gauge supports the standard I²C read, incremental read, quick read, one-byte write, and incremental write functions. The 7-bit device address (ADDR) is the most significant 7 bits of the hex address and is fixed as 1010101. The first 8 bits of the I²C protocol are, therefore, 0xAA or 0xAB for write or read, respectively.

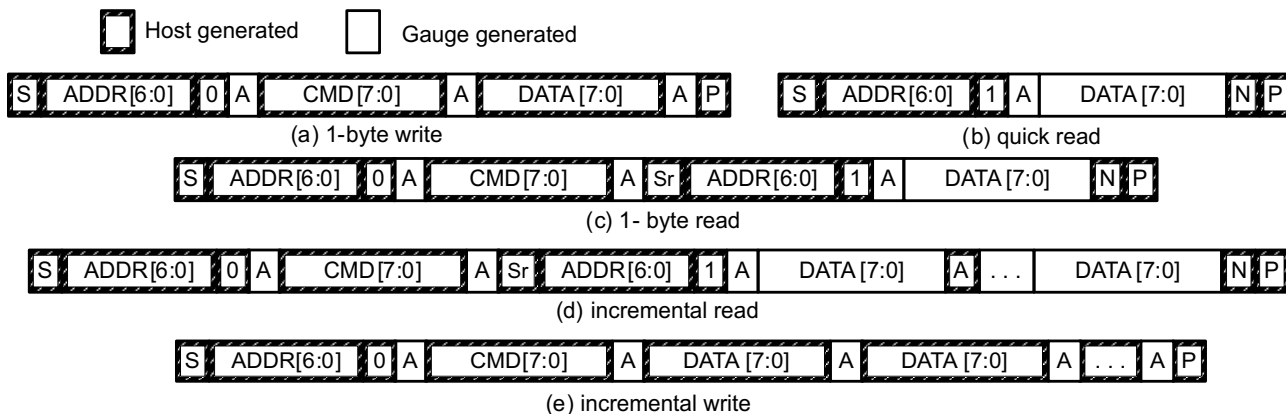

(S = Start, Sr = Repeated Start, A = Acknowledge, N = No Acknowledge, and P = Stop).

Figure 8. Supported I²C Formats

The quick read returns data at the address indicated by the address pointer. The address pointer, a register internal to the I²C communication engine, increments whenever data is acknowledged by the bq27531-G1 or the I²C master. “Quick writes” function in the same manner and are a convenient means of sending multiple bytes to consecutive command locations (such as two-byte commands that require two bytes of data).

The following command sequences are not supported:

Attempt to write a read-only address (NACK after data sent by master):

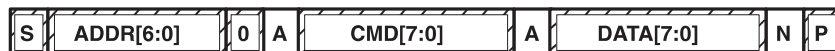

Figure 9. Attempt to Write a Read-Only Address

Attempt to read an address above 0x6B (NACK command):



Figure 10. Attempt to Read an Address Above 0x6B

8.5.2.2 I²C Time-Out

The I²C engine releases both SDA and SCL if the I²C bus is held low for 2 seconds. If the bq27531-G1 is holding the lines, releasing them frees them for the master to drive the lines. If an external condition is holding either of the lines low, the I²C engine enters the low-power SLEEP mode.

8.5.2.3 I²C Command Waiting Time

To ensure proper operation at 400 kHz, a $t_{(BUF)} \geq 66 \mu s$ bus-free waiting time must be inserted between all packets addressed to the bq27531-G1. In addition, if the SCL clock frequency (f_{SCL}) is > 100 kHz, use individual 1-byte write commands for proper data flow control. The following diagram shows the standard waiting time required between issuing the control subcommand the reading the status result. For read-write standard command, a minimum of 2 seconds is required to get the result updated. For read-only standard commands, there is no waiting time required, but the host must not issue any standard command more than two times per second. Otherwise, the gauge could result in a reset issue due to the expiration of the watchdog timer.

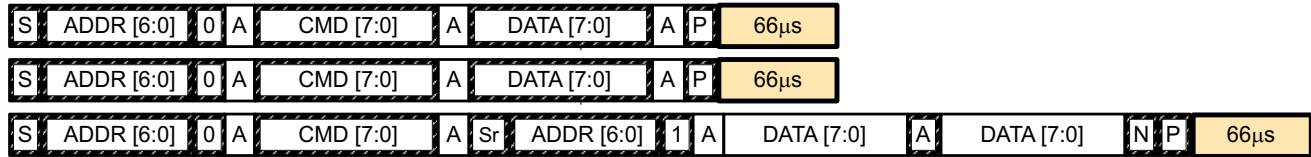

Waiting time inserted between two 1-byte write packets for a subcommand and reading results
(required for $100 \text{ kHz} < f_{SCL} \leq 400 \text{ kHz}$)

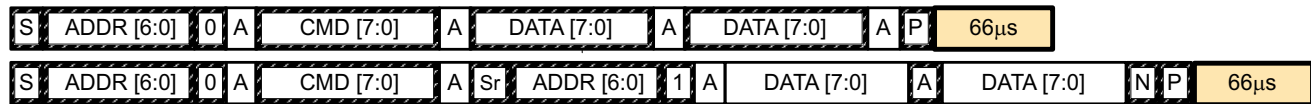

Waiting time inserted between incremental 2-byte write packet for a subcommand and reading results
(acceptable for $f_{SCL} \leq 100 \text{ kHz}$)

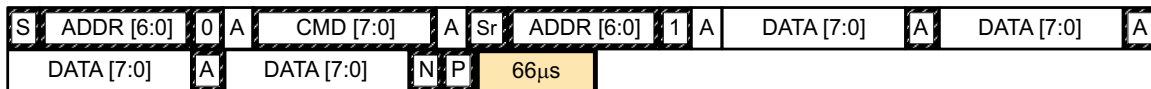

Waiting time inserted after incremental read

Figure 11. I²C Command Waiting Time

8.5.2.4 I²C Clock Stretching

A clock stretch can occur during all modes of fuel gauge operation. In SLEEP and HIBERNATE modes, a short clock stretch occurs on all I²C traffic as the device must wake up to process the packet. In the other modes (BAT INSERT CHECK, NORMAL, SLEEP+) clock stretching only occurs for packets addressed for the fuel gauge. The majority of clock stretch periods are small as the I²C interface performs normal data flow control. However, less frequent yet more significant clock stretch periods may occur as blocks of Data Flash are updated. The following table summarizes the approximate clock stretch duration for various fuel gauge operating conditions.

Table 4. I²C Clock Stretching

GAUGING MODE	OPERATING CONDITION/COMMENT	APPROXIMATE DURATION
SLEEP HIBERNATE	Clock stretch occurs at the beginning of all traffic as the device wakes up.	$\leq 4 \text{ ms}$
BAT INSERT CHECK NORMAL SLEEP+	Clock stretch occurs within the packet for flow control (after a start bit, ACK or first data bit).	$\leq 4 \text{ ms}$
	Normal Ra table Data Flash updates.	24 ms
	Data Flash block writes.	72 ms
	Restored Data Flash block write after loss of power.	116 ms
	End of discharge Ra table Data Flash update.	144 ms

Typical Application (continued)

9.2.1 Design Requirements

Several key parameters must be updated to align with a given application's battery characteristics. For highest accuracy gauging, it is important to follow-up this initial configuration with a learning cycle to optimize resistance and maximum chemical capacity (Q_{max}) values prior to sealing and shipping systems to the field. Successful and accurate configuration of the fuel gauge for a target application can be used as the basis for creating a "golden" gas gauge (.fs) file that can be written to all gauges, assuming identical pack design and Li-ion cell origin (chemistry, lot, and so on). Calibration data is included as part of this golden GG file to cut down on system production time. If going this route, TI recommends averaging the voltage and current measurement calibration data from a large sample size and use these in the golden file. [Table 5](#) lists the items that must be configured to achieve reliable protection and accurate gauging with minimal initial configuration.

Table 5. Key Data Flash Parameters for Configuration

NAME	DEFAULT	UNIT	RECOMMENDED SETTING
Design Capacity	2425	mAh	Set based on the nominal pack capacity as interpreted from cell manufacturer's datasheet. If multiple parallel cells are used, must be set to N × Cell Capacity.
Reserve Capacity-mAh	0	mAh	Set to desired runtime remaining (in seconds/3600) × typical applied load between reporting 0% SOC and reaching Terminate Voltage , if needed.
Cycle Count Threshold	900	mAh	Set to 90% of configured Design Capacity .
Chem ID	1202	hex	Must be configured using TI-supplied Battery Management Studio software. Default open-circuit voltage and resistance tables are also updated in conjunction with this step. Do not attempt to manually update reported Device Chemistry as this does not change all chemistry information. Always update chemistry using the appropriate evaluation software tool.
Load Mode	0	—	Set to applicable load model, 0 for constant current or 1 for constant power.
Load Select	1	—	Set to load profile which most closely matches typical system load.
Q _{max} Cell 0	2425	mAh	Set to initial configured value for Design Capacity. The gauge will update this parameter automatically after the optimization cycle and for every regular Q _{max} update thereafter.
V at Chg Term Cell 0	4200	mV	Set to nominal cell voltage for a fully charged cell. The gauge will update this parameter automatically each time full charge termination is detected.
Terminate Voltage	3200	mV	Set to empty point reference of battery based on system needs. Typical is between 3000 and 3200 mV.
R _a Max Delta	44	mΩ	Set to 15% of Cell0 R _a 4 resistance after an optimization cycle is completed.
Charging Voltage	4200	mV	Set based on nominal charge voltage for the battery in normal conditions (25°C, and so forth). Used as the reference point for offsetting by Taper Voltage for full charge termination detection.
Taper Current	121	mA	Set to the nominal taper current of the charger + taper current tolerance to ensure that the gauge will reliably detect charge termination.
Taper Voltage	100	mV	Sets the voltage window for qualifying full charge termination. Can be set tighter to avoid or wider to ensure possibility of reporting 100% SOC in outer JEITA temperature ranges that use derated charging voltage.
Dsg Current Threshold	60	mA	Sets threshold for gauge detecting battery discharge. Must be set lower than minimal system load expected in the application and higher than Quit Current .
Chg Current Threshold	75	mA	Sets the threshold for detecting battery charge. Can be set higher or lower depending on typical trickle charge current used. Also must be set higher than Quit Current .
Quit Current	40	mA	Sets threshold for gauge detecting battery relaxation. Can be set higher or lower depending on typical standby current and exhibited in the end system.
Avg I Last Run	-299	mA	Current profile used in capacity simulations at onset of discharge or at all times if Load Select = 0. Must be set to nominal system load. Is automatically updated by the gauge every cycle.
Avg P Last Run	-1131	mW	Power profile used in capacity simulations at onset of discharge or at all times if Load Select = 0. Must be set to nominal system power. Is automatically updated by the gauge every cycle.
Sleep Current	10	mA	Sets the threshold at which the fuel gauge enters SLEEP mode. Take care in setting above typical standby currents else entry to SLEEP may be unintentionally blocked.

Typical Application (continued)
Table 5. Key Data Flash Parameters for Configuration (continued)

NAME	DEFAULT	UNIT	RECOMMENDED SETTING
Charge T0	0	°C	Sets the boundary between charging inhibit and charging with T0 parameters.
Charge T1	10	°C	Sets the boundary between charging with T0 and T1 parameters.
Charge T2	45	°C	Sets the boundary between charging with T1 and T2 parameters.
Charge T3	50	°C	Sets the boundary between charging with T2 and T3 parameters.
Charge T4	60	°C	Sets the boundary between charging with T3 and T4 parameters.
Charge Current T0	50	% Des Cap	Sets the charge current parameter for T0.
Charge Current T1	100	% Des Cap	Sets the charge current parameter for T1.
Charge Current T2	100	% Des Cap	Sets the charge current parameter for T2.
Charge Current T3	100	% Des Cap	Sets the charge current parameter for T3.
Charge Current T4	0	% Des Cap	Sets the charge current parameter for T4.
Charge Voltage T0	262	16 mV	Sets the charge voltage parameter for T0.
Charge Voltage T1	262	16 mV	Sets the charge voltage parameter for T1.
Charge Voltage T2	259	16 mV	Sets the charge voltage parameter for T2.
Charge Voltage T3	256	16 mV	Sets the charge voltage parameter for T3.
Charge Voltage T4	0	16 mV	Sets the charge voltage parameter for T4.
Chg Temp Hys	5	°C	Adds temperature hysteresis for boundary crossings to avoid oscillation if temperature is changing by a degree or so on a given boundary.
Chg Disabled Regulation V	4200	mV	Sets the voltage threshold for voltage regulation to system when charge is disabled. TI recommends programming to same value as Charging Voltage and maximum charge voltage that is obtained from Charge Voltage Tn parameters.
CC Gain	10	mΩ	Calibrate this parameter using TI-supplied evaluation software and calibration procedure in the TRM. Determines conversion of coulomb counter measured sense resistor voltage to current.
CC Delta	10	mΩ	Calibrate this parameter using TI-supplied evaluation software and calibration procedure in the TRM. Determines conversion of coulomb counter measured sense resistor voltage to passed charge.
CC Offset	-1418	Counts	Calibrate this parameter using TI-supplied evaluation software and calibration procedure in the TRM. Determines native offset of coulomb counter hardware that must be removed from conversions.
Board Offset	0	Counts	Calibrate this parameter using TI-supplied evaluation software and calibration procedure in the TRM. Determines native offset of the printed-circuit-board parasitics that must be removed from conversions.
Pack V Offset	0	mV	Calibrate this parameter using TI-supplied evaluation software and calibration procedure in the TRM. Determines voltage offset between cell tab and ADC input node to incorporate back into or remove from measurement, depending on polarity.

9.2.2 Detailed Design Procedure

9.2.2.1 BAT Voltage Sense Input

A ceramic capacitor at the input to the BAT pin is used to bypass AC voltage ripple to ground, greatly reducing its influence on battery voltage measurements. It proves most effective in applications with load profiles that exhibit high-frequency current pulses (that is, cell phones) but is recommended for use in all applications to reduce noise on this sensitive high-impedance measurement node.

9.2.2.2 SRP and SRN Current Sense Inputs

The filter network at the input to the coulomb counter is intended to improve differential mode rejection of voltage measured across the sense resistor. These components must be placed as close as possible to the coulomb counter inputs and the routing of the differential traces length-matched to best minimize impedance mismatch-induced measurement errors.

9.2.2.3 Sense Resistor Selection

Any variation encountered in the resistance present between the SRP and SRN pins of the fuel gauge will affect the resulting differential voltage, and derived current, it senses. As such, TI recommends selecting a sense resistor with minimal tolerance and temperature coefficient of resistance (TCR) characteristics. The standard recommendation based on best compromise between performance and price is a 1% tolerance, 100-ppm drift sense resistor with a 1-W power rating.

9.2.2.4 TS Temperature Sense Input

Similar to the BAT pin, a ceramic decoupling capacitor for the TS pin is used to bypass AC voltage ripple away from the high-impedance ADC input, minimizing measurement error. Another helpful advantage is that the capacitor provides additional ESD protection, because the TS input to system may be accessible in systems that use removable battery packs. The capacitor must be placed as close as possible to the respective input pin for optimal filtering performance.

9.2.2.5 Thermistor Selection

The fuel gauge temperature sensing circuitry is designed to work with a negative temperature coefficient-type (NTC) thermistor with a characteristic 10-k Ω resistance at room temperature (25°C). The default curve-fitting coefficients configured in the fuel gauge specifically assume a 103AT-2 type thermistor profile and so that is the default recommendation for thermistor selection purposes. Moving to a separate thermistor resistance profile (for example, JT-2 or others) requires an update to the default thermistor coefficients in data flash to ensure highest accuracy temperature measurement performance.

9.2.2.6 REGIN Power Supply Input Filtering

A ceramic capacitor is placed at the input to the fuel gauge internal LDO to increase power supply rejection (PSR) and improve effective line regulation. It ensures that voltage ripple is rejected to ground instead of coupling into the internal supply rails of the fuel gauge.

9.2.2.7 V_{CC} LDO Output Filtering

A ceramic capacitor is also needed at the output of the internal LDO to provide a current reservoir for fuel gauge load peaks during high peripheral utilization. It acts to stabilize the regulator output and reduce core voltage ripple inside of the fuel gauge.

9.2.3 Application Curves

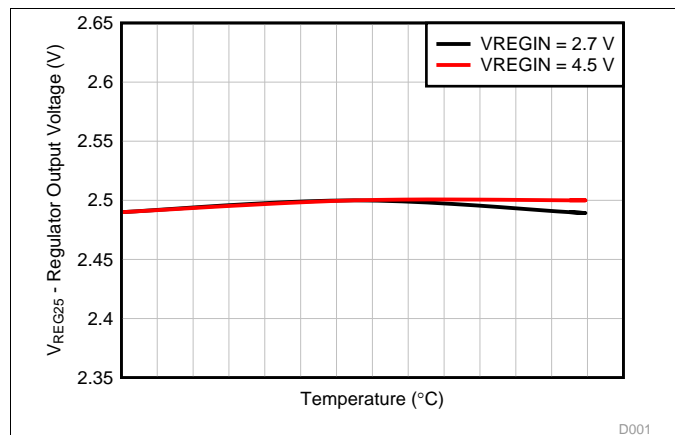

Figure 13. Regulator Output Voltage vs Temperature

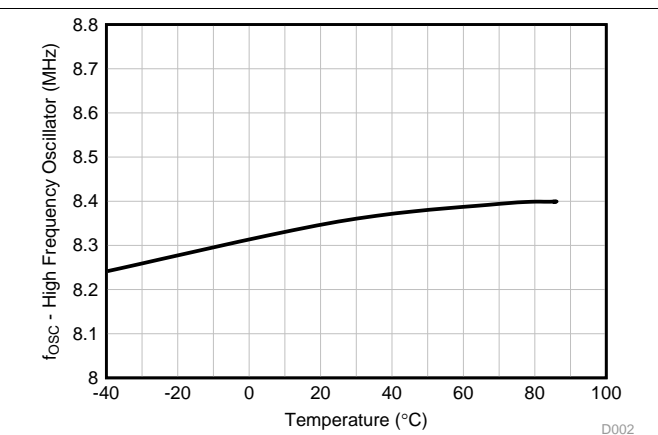

Figure 14. High-Frequency Oscillator Frequency vs Temperature

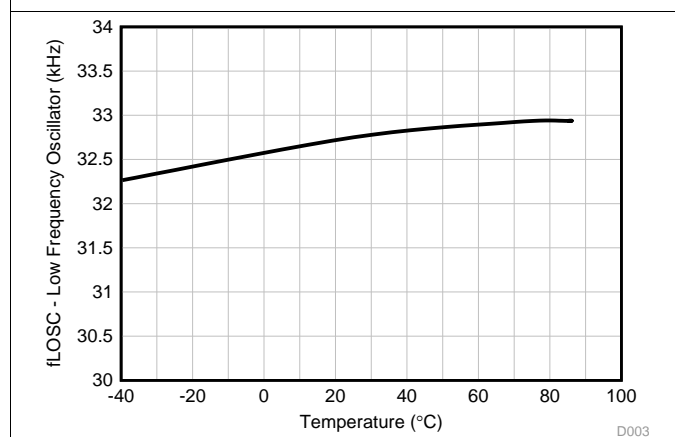

Figure 15. Low-Frequency Oscillator Frequency vs Temperature

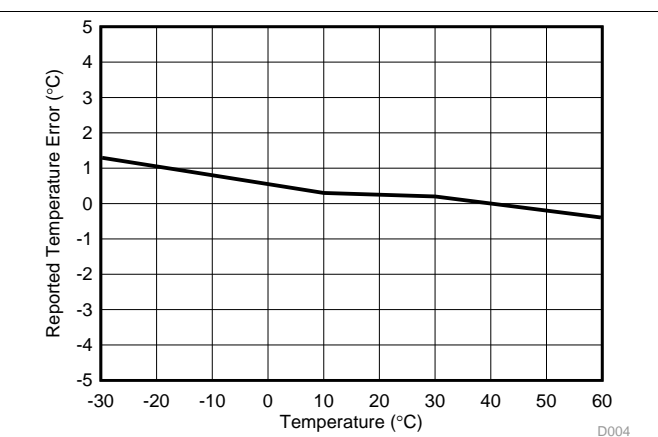

Figure 16. Reported Internal Temperature Measurement vs Temperature

10 Power Supply Recommendations

10.1 Power Supply Decoupling

Both the REGIN input pin and the VCC output pin require low equivalent series resistance (ESR) ceramic capacitors placed as close as possible to the respective pins to optimize ripple rejection and provide a stable and dependable power rail that is resilient to line transients. A 0.1- μ F capacitor at the REGIN and a 1- μ F capacitor at V_{CC} will suffice for satisfactory device performance.

11 Layout

11.1 Layout Guidelines

11.1.1 Sense Resistor Connections

Kelvin connections at the sense resistor are just as critical as those for the battery terminals themselves. The differential traces must be connected at the inside of the sense resistor pads and not anywhere along the high-current trace path to prevent false increases to measured current that could result when measuring between the sum of the sense resistor and trace resistance between the tap points. In addition, the routing of these leads from the sense resistor to the input filter network and finally into the SRP and SRN pins needs to be as closely matched in length as possible else additional measurement offset could occur. It is further recommended to add copper trace or pour-based "guard rings" around the perimeter of the filter network and coulomb counter inputs to shield these sensitive pins from radiated EMI into the sense nodes. This prevents differential voltage shifts that could be interpreted as real current change to the fuel gauge. All of the filter components need to be placed as close as possible to the coulomb counter input pins.

11.1.2 Thermistor Connections

The thermistor sense input must include a ceramic bypass capacitor placed as close to the TS input pin as possible. The capacitor helps to filter measurements of any stray transients as the voltage bias circuit pulses periodically during temperature sensing windows.

11.1.3 High-Current and Low-Current Path Separation

For best possible noise performance, it is extremely important to separate the low-current and high-current loops to different areas of the board layout. The fuel gauge and all support components must be situated on one side of the boards and tap off of the high-current loop (for measurement purposes) at the sense resistor. Routing the low-current ground around instead of under high-current traces will further help to improve noise rejection.

11.2 Layout Example

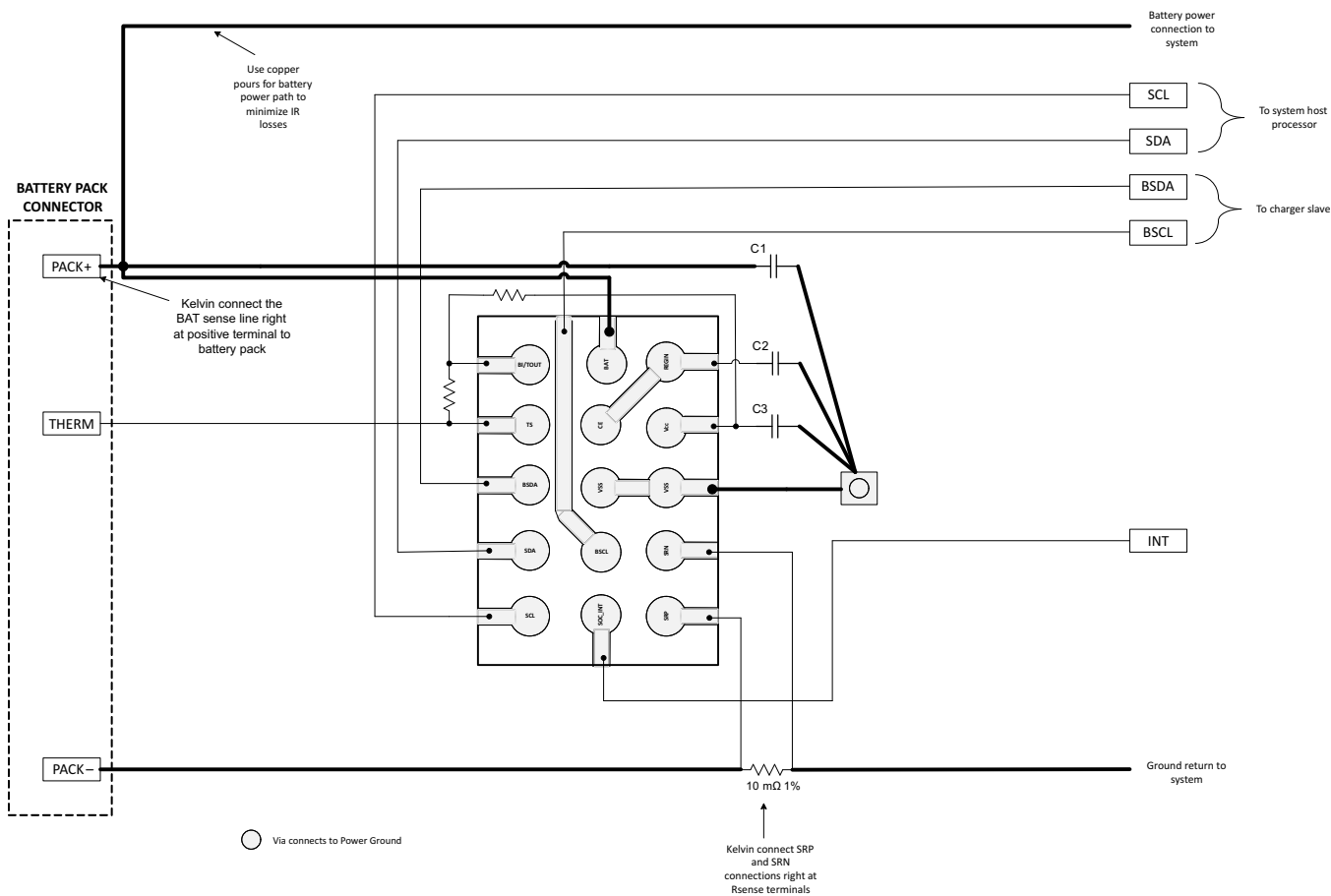

Figure 17. Layout Schematic

12 Device and Documentation Support

12.1 Documentation Support

12.1.1 Related Documentation

To obtain a copy of any of the following TI documents, go to the TI website at www.ti.com.

- *bq27531-G1 Technical Reference Manual User's Guide* ([SLUUA96](#))
- *bq27531EVM with bq27531 Battery Management Unit Impedance Track™ Fuel Gauge and bq24192 4.5-A, Switch-Mode Battery Charger for Single-Cell Applications User's Guide* ([SLUUA90](#))

12.2 Community Resources

The following links connect to TI community resources. Linked contents are provided "AS IS" by the respective contributors. They do not constitute TI specifications and do not necessarily reflect TI's views; see TI's [Terms of Use](#).

TI E2E™ Online Community *TI's Engineer-to-Engineer (E2E) Community*. Created to foster collaboration among engineers. At e2e.ti.com, you can ask questions, share knowledge, explore ideas and help solve problems with fellow engineers.

Design Support *TI's Design Support* Quickly find helpful E2E forums along with design support tools and contact information for technical support.

12.3 Trademarks

Impedance Track, MaxLife, NanoFree, E2E are trademarks of Texas Instruments. All other trademarks are the property of their respective owners.

12.4 Electrostatic Discharge Caution



These devices have limited built-in ESD protection. The leads should be shorted together or the device placed in conductive foam during storage or handling to prevent electrostatic damage to the MOS gates.

12.5 Glossary

[SLYZ022](#) — *TI Glossary*.

This glossary lists and explains terms, acronyms, and definitions.

13 Mechanical, Packaging, and Orderable Information

The following pages include mechanical, packaging, and orderable information. This information is the most current data available for the designated devices. This data is subject to change without notice and revision of this document. For browser-based versions of this data sheet, refer to the left-hand navigation.

PACKAGING INFORMATION

Orderable Device	Status (1)	Package Type	Package Drawing	Pins	Package Qty	Eco Plan (2)	Lead finish/ Ball material (6)	MSL Peak Temp (3)	Op Temp (°C)	Device Marking (4/5)	Samples
BQ27531YZFR-G1	ACTIVE	DSBGA	YZF	15	3000	RoHS & Green	SNAGCU	Level-1-260C-UNLIM	-40 to 85	BQ27531	Samples
BQ27531YZFT-G1	ACTIVE	DSBGA	YZF	15	250	RoHS & Green	SNAGCU	Level-1-260C-UNLIM	-40 to 85	BQ27531	Samples

(1) The marketing status values are defined as follows:

ACTIVE: Product device recommended for new designs.

LIFEBUY: TI has announced that the device will be discontinued, and a lifetime-buy period is in effect.

NRND: Not recommended for new designs. Device is in production to support existing customers, but TI does not recommend using this part in a new design.

PREVIEW: Device has been announced but is not in production. Samples may or may not be available.

OBSOLETE: TI has discontinued the production of the device.

(2) **RoHS:** TI defines "RoHS" to mean semiconductor products that are compliant with the current EU RoHS requirements for all 10 RoHS substances, including the requirement that RoHS substance do not exceed 0.1% by weight in homogeneous materials. Where designed to be soldered at high temperatures, "RoHS" products are suitable for use in specified lead-free processes. TI may reference these types of products as "Pb-Free".

RoHS Exempt: TI defines "RoHS Exempt" to mean products that contain lead but are compliant with EU RoHS pursuant to a specific EU RoHS exemption.

Green: TI defines "Green" to mean the content of Chlorine (Cl) and Bromine (Br) based flame retardants meet JS709B low halogen requirements of <=1000ppm threshold. Antimony trioxide based flame retardants must also meet the <=1000ppm threshold requirement.

(3) MSL, Peak Temp. - The Moisture Sensitivity Level rating according to the JEDEC industry standard classifications, and peak solder temperature.

(4) There may be additional marking, which relates to the logo, the lot trace code information, or the environmental category on the device.

(5) Multiple Device Markings will be inside parentheses. Only one Device Marking contained in parentheses and separated by a "~" will appear on a device. If a line is indented then it is a continuation of the previous line and the two combined represent the entire Device Marking for that device.

(6) Lead finish/Ball material - Orderable Devices may have multiple material finish options. Finish options are separated by a vertical ruled line. Lead finish/Ball material values may wrap to two lines if the finish value exceeds the maximum column width.

Important Information and Disclaimer:The information provided on this page represents TI's knowledge and belief as of the date that it is provided. TI bases its knowledge and belief on information provided by third parties, and makes no representation or warranty as to the accuracy of such information. Efforts are underway to better integrate information from third parties. TI has taken and continues to take reasonable steps to provide representative and accurate information but may not have conducted destructive testing or chemical analysis on incoming materials and chemicals. TI and TI suppliers consider certain information to be proprietary, and thus CAS numbers and other limited information may not be available for release.

In no event shall TI's liability arising out of such information exceed the total purchase price of the TI part(s) at issue in this document sold by TI to Customer on an annual basis.

TAPE AND REEL INFORMATION

QUADRANT ASSIGNMENTS FOR PIN 1 ORIENTATION IN TAPE

*All dimensions are nominal

Device	Package Type	Package Drawing	Pins	SPQ	Reel Diameter (mm)	Reel Width W1 (mm)	A0 (mm)	B0 (mm)	K0 (mm)	P1 (mm)	W (mm)	Pin1 Quadrant
BQ27531YZFR-G1	DSBGA	YZF	15	3000	180.0	8.4	2.1	2.76	0.81	4.0	8.0	Q1
BQ27531YZFT-G1	DSBGA	YZF	15	250	180.0	8.4	2.1	2.76	0.81	4.0	8.0	Q1

TAPE AND REEL BOX DIMENSIONS

*All dimensions are nominal

Device	Package Type	Package Drawing	Pins	SPQ	Length (mm)	Width (mm)	Height (mm)
BQ27531YZFR-G1	DSBGA	YZF	15	3000	182.0	182.0	20.0
BQ27531YZFT-G1	DSBGA	YZF	15	250	182.0	182.0	20.0

YZF0015

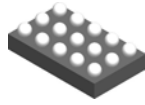

PACKAGE OUTLINE

DSBGA - 0.625 mm max height

DIE SIZE BALL GRID ARRAY

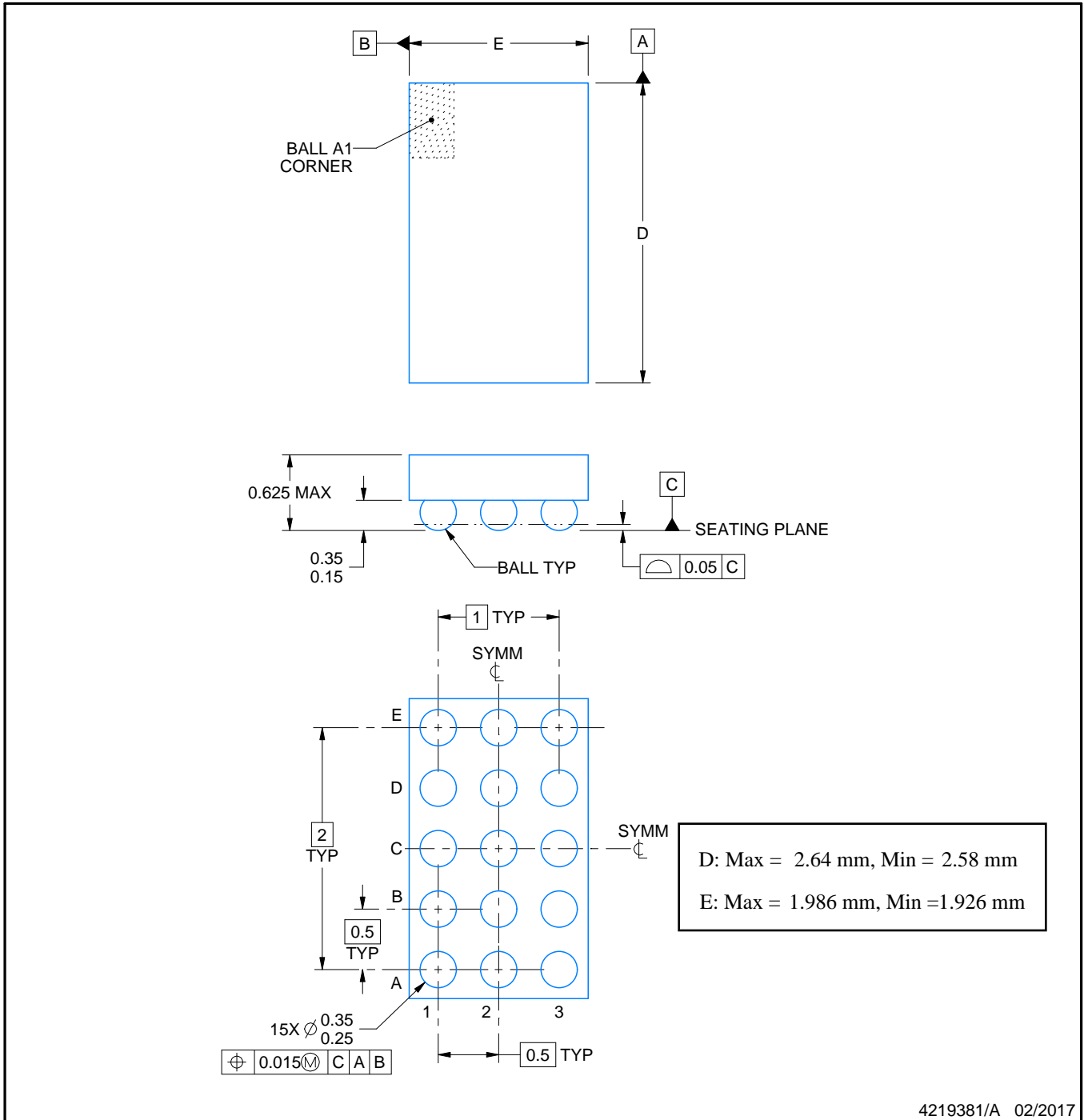

4219381/A 02/2017

NOTES:

NanoFree is a trademark of Texas Instruments.

1. All linear dimensions are in millimeters. Any dimensions in parenthesis are for reference only. Dimensioning and tolerancing per ASME Y14.5M.
2. This drawing is subject to change without notice.
3. NanoFree™ package configuration.

EXAMPLE BOARD LAYOUT

YZF0015

DSBGA - 0.625 mm max height

DIE SIZE BALL GRID ARRAY

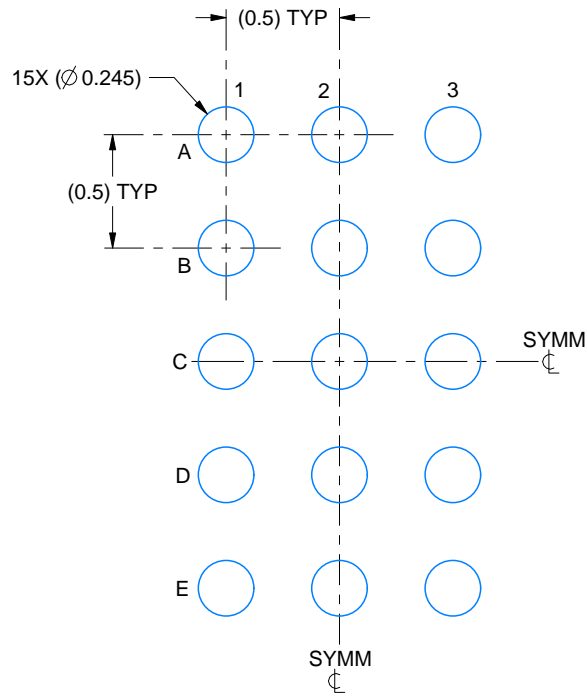

LAND PATTERN EXAMPLE
EXPOSED METAL SHOWN
SCALE:30X

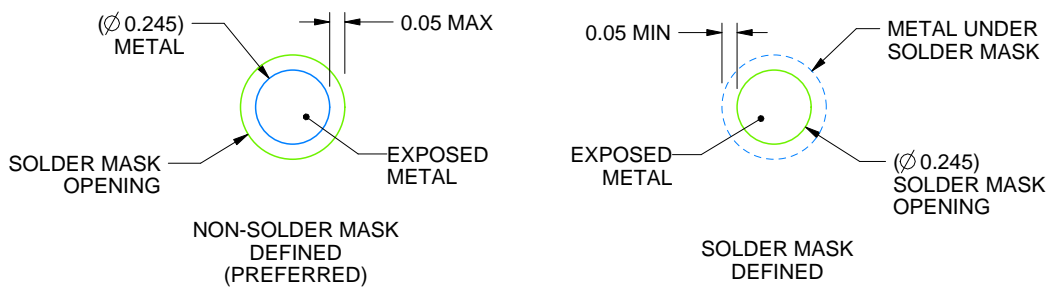

SOLDER MASK DETAILS
NOT TO SCALE

4219381/A 02/2017

NOTES: (continued)

- Final dimensions may vary due to manufacturing tolerance considerations and also routing constraints. For more information, see Texas Instruments literature number SNVA009 (www.ti.com/lit/snva009).

EXAMPLE STENCIL DESIGN

YZF0015

DSBGA - 0.625 mm max height

DIE SIZE BALL GRID ARRAY

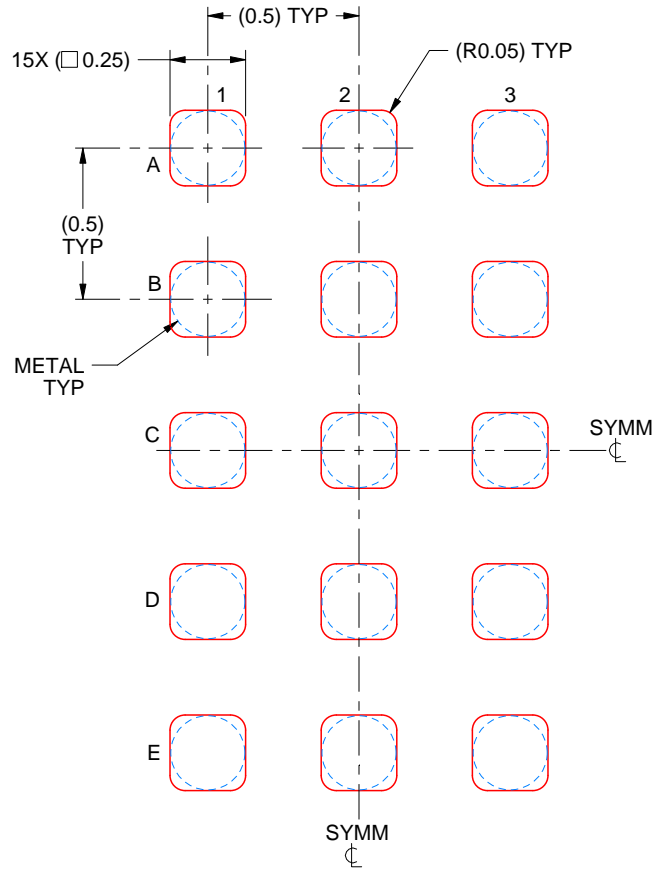

SOLDER PASTE EXAMPLE
BASED ON 0.1 mm THICK STENCIL
SCALE:40X

4219381/A 02/2017

NOTES: (continued)

5. Laser cutting apertures with trapezoidal walls and rounded corners may offer better paste release.

IMPORTANT NOTICE AND DISCLAIMER

TI PROVIDES TECHNICAL AND RELIABILITY DATA (INCLUDING DATA SHEETS), DESIGN RESOURCES (INCLUDING REFERENCE DESIGNS), APPLICATION OR OTHER DESIGN ADVICE, WEB TOOLS, SAFETY INFORMATION, AND OTHER RESOURCES "AS IS" AND WITH ALL FAULTS, AND DISCLAIMS ALL WARRANTIES, EXPRESS AND IMPLIED, INCLUDING WITHOUT LIMITATION ANY IMPLIED WARRANTIES OF MERCHANTABILITY, FITNESS FOR A PARTICULAR PURPOSE OR NON-INFRINGEMENT OF THIRD PARTY INTELLECTUAL PROPERTY RIGHTS.

These resources are intended for skilled developers designing with TI products. You are solely responsible for (1) selecting the appropriate TI products for your application, (2) designing, validating and testing your application, and (3) ensuring your application meets applicable standards, and any other safety, security, regulatory or other requirements.

These resources are subject to change without notice. TI grants you permission to use these resources only for development of an application that uses the TI products described in the resource. Other reproduction and display of these resources is prohibited. No license is granted to any other TI intellectual property right or to any third party intellectual property right. TI disclaims responsibility for, and you will fully indemnify TI and its representatives against, any claims, damages, costs, losses, and liabilities arising out of your use of these resources.

TI's products are provided subject to [TI's Terms of Sale](#) or other applicable terms available either on [ti.com](https://www.ti.com) or provided in conjunction with such TI products. TI's provision of these resources does not expand or otherwise alter TI's applicable warranties or warranty disclaimers for TI products.

TI objects to and rejects any additional or different terms you may have proposed.

Mailing Address: Texas Instruments, Post Office Box 655303, Dallas, Texas 75265
Copyright © 2023, Texas Instruments Incorporated