

TPS3123 Ultra-Low Voltage Processor Supervisory Circuits

1 Features

- Minimum supply voltage of 0.75 V
- Supply voltage supervision range:
 - 1.2 V, 1.5 V, 1.8 V (TPS312x)
 - 3 V (TPS3125 devices only)
 - Other versions on request
- Power-on reset generator with fixed delay time of 180 ms
- Manual reset input (TPS3123/5/6/8)
- Watchdog timer retriggers the $\overline{\text{RESET}}$ output at $V_{\text{DD}} \geq V_{\text{IT}}$
- Supply current of 14 μA (Typ)
- Small SOT23-5 package
- Temperature range of -40°C to $+85^{\circ}\text{C}$
- Reset output available in Push-Pull (Active Low and High) and Open-Drain (Active-Low)

2 Applications

- [Portable / battery-powered equipment](#)
- [Wireless communication systems](#)
- [Factory automation](#)
- [Servers](#)
- [Building automation](#)

3 Description

The TPS312x family of voltage supervisory circuits provides voltage monitoring down to 1.2V rails and timing supervision, primarily for DSP and processor-based systems. All devices in the family monitor the power rail and assert $\overline{\text{RESET}}$ output when the power rail is under the threshold voltage target (V_{IT}). The threshold voltage is programmed into the device to minimize external components. Built-in hysteresis prevents false triggering. The $\overline{\text{RESET}}$ output is not valid for supply voltage (V_{DD}) under 0.75 V. The TPS312x family includes devices with active high output for use as disable during malfunction and active low outputs for most systems where high output indicates properly functioning system.

The TPS3123/3124/3128 also include the watchdog timer functionality to monitor timely digital pulses from the processor and issue an alert if the expected pulse does not arrive on time due to potential software freeze or hang. Such integration of supply rail monitoring and the watch dog timer feature is very helpful in always on systems, such as Factory Automation and Communications Infrastructure.

In addition the TPS3123/5/6/8 devices incorporate a manual reset input, MR, to force RESET triggered by an event unrelated to the voltage rail monitoring of the pulses monitored by the watch dog timer. A low level at MR causes RESET to become active. The TPS3124 devices do not have the input MR, but include a high-level output RESET same as the TPS3125 and TPS3126 devices.

All devices in the family are available in a 5-pin SOT23-5 package and are characterized for operation over a temperature range of -40°C to $+85^{\circ}\text{C}$.

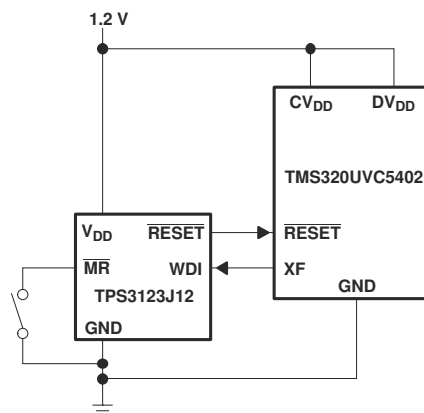

Typical Low-Voltage DSP Application



Table of Contents

1 Features	1	7.5 Electrical Characteristics.....	6
2 Applications	1	7.6 Timing Requirements.....	7
3 Description	1	7.7 Switching Characteristics.....	7
4 Revision History	2	7.8 Timing Diagrams	8
5 Device Comparison	3	7.9 Typical Characteristics.....	9
6 Pin Configuration and Functions	4	8 Detailed Description	12
7 Specifications	5	8.1 Overview.....	12
7.1 Absolute Maximum Ratings.....	5	8.2 Functional Block Diagram.....	12
7.2 ESD Ratings for TPS3123.....	5	8.3 Feature Description.....	12
7.3 Recommended Operating Conditions.....	5	8.4 Device Functional Modes.....	13
7.4 Dissipation Rating Table.....	5	9 Device and Documentation Support	14

4 Revision History

NOTE: Page numbers for previous revisions may differ from page numbers in the current version.

Changes from Revision E (August 2011) to Revision F (December 2020)	Page
• Updated the numbering format for tables, figures, and cross-references throughout the document.....	1
• Updated the description to highlight benefits of the key features.....	1
• Moved table of the details on package, threshold and top mark to the device and documentation support section in the back, leaving only the nomenclature and the topology summary here in this device comparison table section.....	3
• Moved pin out figures from first page to this new pin configuration section and added pin function table.....	4
• Added this missing section on ESD ratings.....	5
• Moved Timing Diagrams to section of their own and added legend for the letters on the diagrams.....	8
• Moved and updated device overview, block diagram and function mode table to this newly created section and added subsections for detailed feature descriptions for MR, output topology (active high/low, push-pull/open-drain and watchdog timer).....	12

Changes from Revision D (December 2006) to Revision E (August 2011)	Page
• Removed <i>TPS3128E12DBVR</i> from list of orderable devices in Section 5	3

5 Device Comparison

Figure 5-1 shows the device naming nomenclature to compare the different device variants. See Section 9 for ordering information on various variants of TPS3123/3124/3125/3126/ and TPS3128.

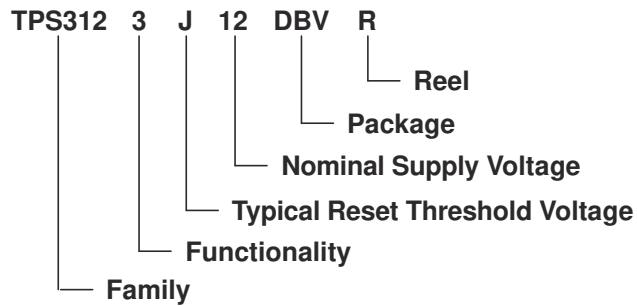
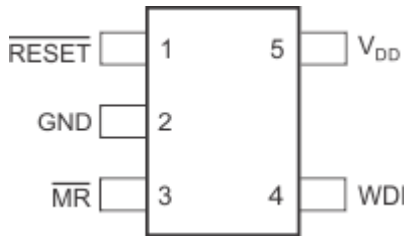

Figure 5-1. Device Naming Nomenclature

Table 5-1. Reset Output Topologies

DEVICES	OPEN DRAIN	PUSH-PULL
TPS3123		X
TPS3124		X
TPS3125		X
TPS3126	X	
TPS3128	X	

6 Pin Configuration and Functions



**Figure 6-1. TPS3123 / TPS3128: DBV PACKAGE
5-Pin SOT-23
Top View**

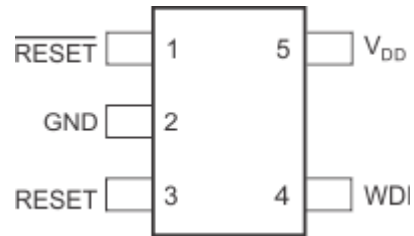

**Figure 6-2. TPS3124: DBV PACKAGE
5-Pin SOT-23
Top View**

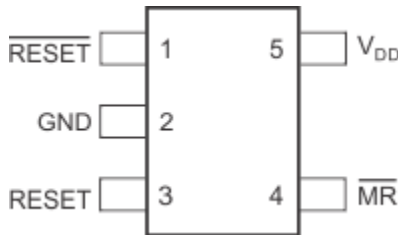

**Figure 6-3. TPS3125 / TPS3126: DBV PACKAGE
5-Pin SOT-23
Top View**

Table 6-1. Pin Functions

PIN				I/O	DESCRIPTION
PIN NUMBER	TPS3123 TPS3128	TPS3124	TPS3125 TPS3126		
1	RESET	RESET	RESET	O	Active-Low Output Reset Signal: This pin is driven to a logic low when VDD voltage falls below the negative voltage threshold (V_{IT-}). RESET remains low (asserted) for the delay time period (t_D) after VDD voltage rises above $V_{IT+} = V_{IT-} + V_{HYS}$.
2	GND	GND	GND	-	GROUND
3	MR	-	-	I	Manual Reset: Pull this pin to a logic low to assert a reset signal in the RESET output pin. After MR pin is left floating or pulls to logic high, the RESET output deasserts to the nominal state after the reset delay time (t_D) expires.
3	-	RESET	RESET	O	Active-High Output Reset Signal: This pin is driven to a logic high when VDD voltage falls below the negative voltage threshold (V_{IT-}). RESET remains high (asserted) for the delay time period (t_D) after VDD voltage rises above $V_{IT+} = V_{IT-} + V_{HYS}$.
4	WDI	WDI	MR	I	Watchdog timer input: If WDI remains high or low longer than the timeout period, then reset is triggered. The timer clears when reset is asserted or when WDI sees a rising edge or a falling edge. If unused, the WDI connection must be high impedance to prevent it from causing a reset event.
5	VDD	VDD	VDD	I	Input Supply Voltage: Supply voltage pin. Good analog design practice is to place a 0.1- μ F ceramic capacitor close to this pin.

7 Specifications

7.1 Absolute Maximum Ratings

over operating free-air temperature range (unless otherwise noted)⁽¹⁾

	UNIT
Manual reset, \overline{MR}	-0.3 V to $V_{DD} + 0.6$ V
\overline{RESET}	-0.3 V to $V_{DD} + 0.6$ V
V_{DD} Supply voltage	3.6 V
WDI Watchdog input	-0.3 V to $V_{DD} + 0.6$ V
I_{OL} Maximum low output current	5 mA
I_{OH} Maximum high output current	-5 mA
I_{IK} Input clamp current ($V_I < 0$ or $V_I > V_{DD}$)	± 10 mA
I_{OK} Output clamp current ($V_O < 0$ or $V_O > V_{DD}$)	± 10 mA
Continuous total power dissipation	See Dissipation Rating Table
T_A Operating free-air temperature range,	-40°C to +85°C
T_{stg} Storage temperature range,	-65°C to +150°C
Soldering temperature	+260°C
Open drain RESET outputs	-0.3 V to $V_{DD} + 0.3$ V

- (1) Stresses beyond those listed under *Absolute Maximum Ratings* may cause permanent damage to the device. These are stress ratings only, and functional operation of the device at these or any other conditions beyond those indicated under *Recommended Operating Conditions* is not implied. Exposure to absolute-maximum-rated conditions for extended periods may affect device reliability.

7.2 ESD Ratings for TPS3123

	VALUE	UNIT
$V_{(ESD)}$ Electrostatic discharge	Human-body model (HBM), per ANSI/ESDA/JEDEC JS-001 ⁽¹⁾	± 4000
	Charged-device model (CDM), per JEDEC specification JESD22-C101 ⁽²⁾	± 1000

- (1) JEDEC document JEP155 states that 500-V HBM allows safe manufacturing with a standard ESD control process.
(2) JEDEC document JEP157 states that 250-V CDM allows safe manufacturing with a standard ESD control process.

7.3 Recommended Operating Conditions

at specified temperature range.

	MIN	MAX	UNIT
V_{DD} Supply voltage	$T_A = 0^\circ\text{C}$ to +85°C	0.75	3.3
	$T_A = -40^\circ\text{C}$ to +85°C	0.85	3.3
V_{DD} Manual reset voltage	0.0	$V_{DD} + 0.3$	V
V_{WD1} Watchdog input voltage	0	$V_{DD} + 0.3$	V
V_{IH} High-level input voltage	$0.7 \times V_{DD}$		V
V_{IL} Low-level input voltage		$0.3 \times V_{DD}$	V
$\Delta t/\Delta V$ Input transition rise and fall rate at WDI		1	$\mu\text{s}/\text{V}$
T_A Operating free-air temperature range	40	+85	°C

7.4 Dissipation Rating Table

PACKAGE	$T_A \leq +25^\circ\text{C}$ POWER RATING	DERATING FACTOR ABOVE $T_A = +25^\circ\text{C}$	$T_A = +70^\circ\text{C}$ POWER RATING	$T_A = +85^\circ\text{C}$ POWER RATING
DBV	437 mW	3.5 mW/°C	280 mW	227 mW

7.5 Electrical Characteristics

over recommended operating free-air temperature range (unless otherwise noted).

PARAMETER		TEST CONDITIONS		MIN	TYP	MAX	UNIT	
R_{MR}	MR pullup resistor (internal)				27		k Ω	
I_{IH}	High-level input current	WDI	$WDI = V_{DD} = 3.3\text{ V}$	1		1	μA	
		MR	$MR = 0.7 \times V_{DD}$, $V_{DD} = 3.3\text{ V}$	20		55		
I_{IL}	Low-level input current	WDI	$WDI = 0\text{ V}$, $V_{DD} = 3.3\text{ V}$	1		1	μA	
		MR	$MR = 0\text{ V}$, $V_{DD} = 3.3\text{ V}$	80		170		
I_{OH}	High-level output current (leakage into RESET pin)	TPS3126-xx, TPS3128-xx	$V_{DD} = V_{OH} = 3.3\text{ V}$			200	nA	
V_{OH}	High-level output voltage (TPS3123/4/5 only)	RESET	$V_{DD} = 1.5\text{ V}$, $I_{OH} = -1\text{ mA}$	0.8 × V_{DD}			V	
			$V_{DD} = 3.3\text{ V}$, $I_{OH} = -4.5\text{ mA}$					
		RESET	$V_{DD} = 0.75\text{ V}$, $I_{OH} = -8\text{ }\mu\text{A}$					
			$V_{DD} = 1.5\text{ V}$, $I_{OH} = -1\text{ mA}$					
V_{OL}	Low-level output voltage	RESET	$V_{DD} = 0.75\text{ V}$, $I_{OL} = 15\text{ }\mu\text{A}$	0.2 × V_{DD}			V	
			$V_{DD} = 1.5\text{ V}$, $I_{OL} = 1.4\text{ mA}$					
		RESET	$V_{DD} = 1.5\text{ V}$, $I_{OL} = 1.4\text{ mA}$					
			$V_{DD} = 3.3\text{ V}$, $I_{OL} = 3\text{ mA}$					0.4
V_{IT-}	Negative-going input threshold voltage ⁽¹⁾	TPS312xJ12	$T_A = -40^\circ\text{C to } +85^\circ\text{C}$	1.04	1.08	1.12	V	
		TPS312xG15		1.35	1.40	1.45		
		TPS312xJ18		1.56	1.62	1.68		
		TPS312xL30		2.57	2.64	2.71		
		TPS312xE12		1.10	1.14	1.18		
		TPS312xE15		1.38	1.43	1.48		
		TPS312xE18		1.65	1.71	1.77		
V_{HYS}	Hysteresis at V_{DD} input		$1\text{ V} < V_{IT-} < 1.4\text{ V}$		15		mV	
			$1.4\text{ V} < V_{IT-} < 2\text{ V}$		20			
			$2\text{ V} < V_{IT-} < 3\text{ V}$		30			
I_{DD}	Supply current	TPS3123-xx TPS3124-xx TPS3128-xx	WDI = V_{DD} , MR unconnected	$V_{DD} = 0.75\text{ V}$		14	μA	
				$V_{DD} = 3.3\text{ V}$		22		30
		TPS3125-xx TPS3126-xx ⁽²⁾	MR unconnected	$V_{DD} = 0.75\text{ V}$		14		
				$V_{DD} = 3.3\text{ V}$		18		25
C_i	Input capacitance at MR, WDI		$V_i = 0\text{ V to } 3.3\text{ V}$		5		pF	

(1) To ensure best stability of the threshold voltage, a bypass capacitor (ceramic, 0.1 μF) should be placed near the supply terminal.

(2) The supply current during delay time t_d is typical 5 μA higher.

7.6 Timing Requirements

 at $R_L = 1\text{ M}\Omega$, $C_L = 50\text{ pF}$, $T_A = +25^\circ\text{C}$.

PARAMETER		TEST CONDITIONS	MIN	TYP	MAX	UNIT
t_w Pulse width	At V_{DD}	$V_{IH} = V_{IT-} + 0.2\text{ V}$, $V_{IL} = V_{IT-} - 0.2\text{ V}$	6			μs
	At $\overline{\text{MR}}$	$V_{DD} \geq V_{IT-} + 0.2\text{ V}$, $V_{IL} = 0.3 \times V_{DD}$, $V_{IH} = 0.7 \times V_{DD}$	1			
	At WDI		0.1			

7.7 Switching Characteristics

 at $R_L = 1\text{ M}\Omega$, $C_L = 50\text{ pF}$, $T_A = +25^\circ\text{C}$.

PARAMETER		TEST CONDITIONS	MIN	TYP	MAX	UNIT
t_{out} Watchdog time out		$V_{DD} \geq V_{IT-} + 0.2\text{ V}$, See timing diagram	0.8	1.4	2.1	s
t_d Delay time		$V_{DD} > V_{IT-} + 0.2\text{ V}$, See timing diagram	100	180	260	ms
t_{PHL} Propagation delay time, high-to-low-level output	MR to RESET delay (TPS3123/5/6/8)	$V_{DD} \geq V_{IT-} + 0.2\text{ V}$, $V_{IL} = 0.2 \times V_{DD}$, $V_{IH} = 0.8 \times V_{DD}$			0.1	μs
t_{PLH} Propagation delay time, low-to-high-level output	$\overline{\text{MR}}$ to RESET delay (TPS3125/6)				0.1	
t_{PHL} Propagation delay time, high-to-low-level output	V_{DD} to RESET delay	$V_{IL} = V_{IT-} - 0.2\text{ V}$, $V_{IH} = V_{IT-} + 0.2\text{ V}$			10	μs
t_{PLH} Propagation delay time, low-to-high-level output	V_{DD} to RESET delay (TPS3124/5/6)				10	

7.8 Timing Diagrams

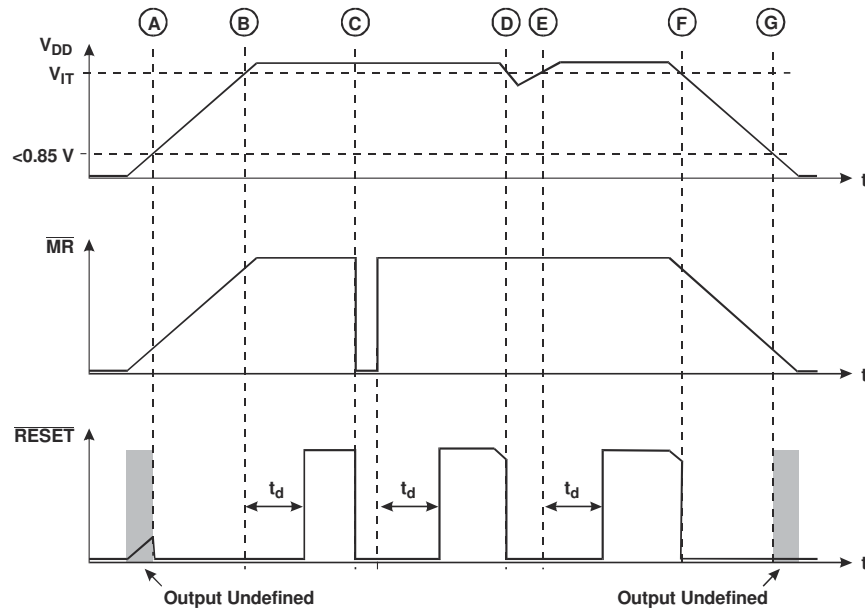

Figure 7-1. Timing Diagram TPS3123/5/6/8

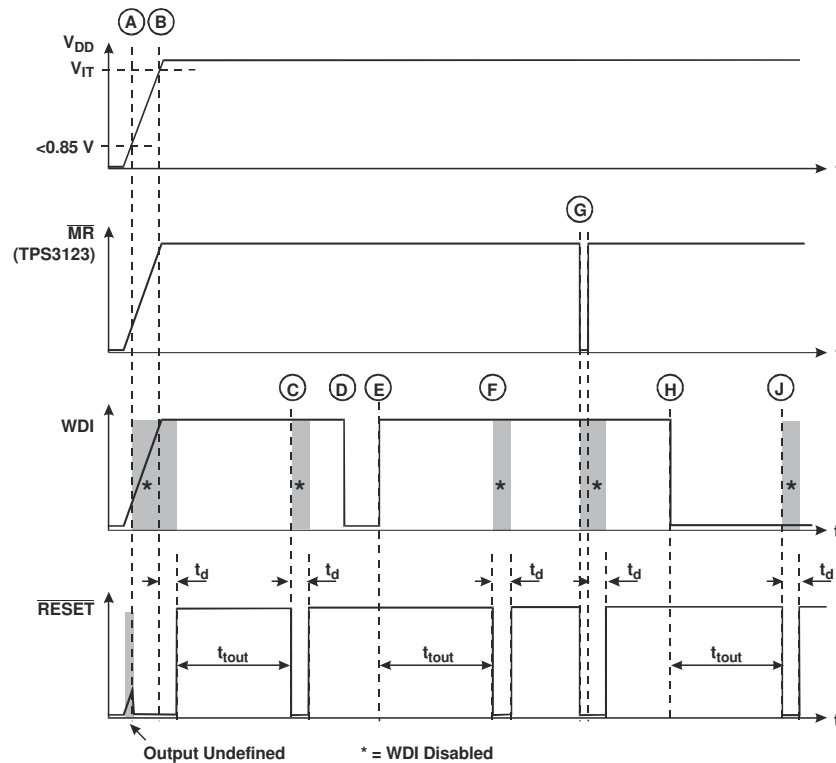
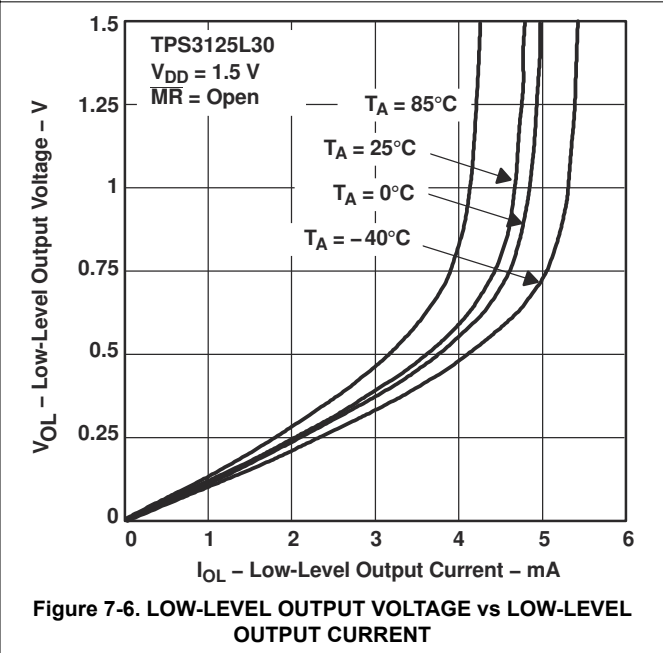
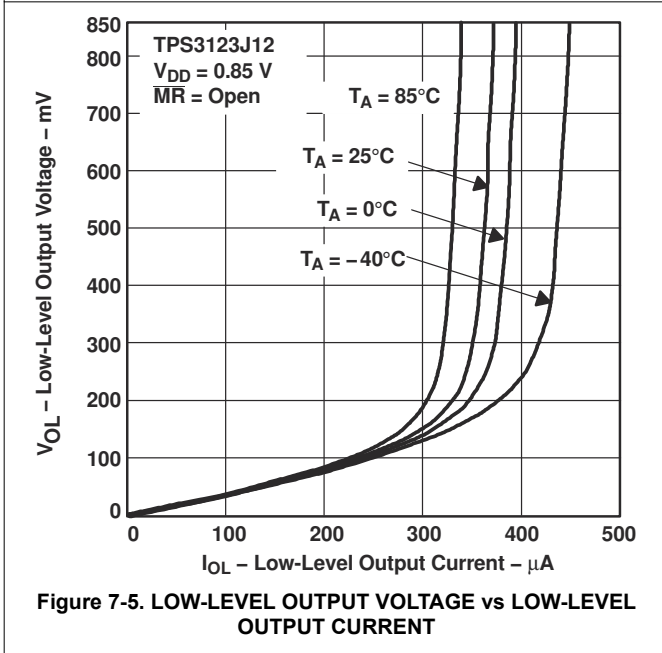
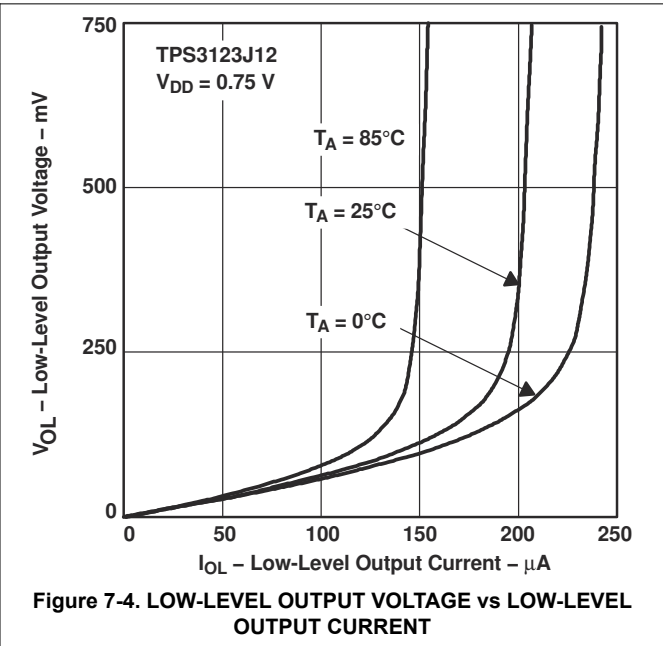
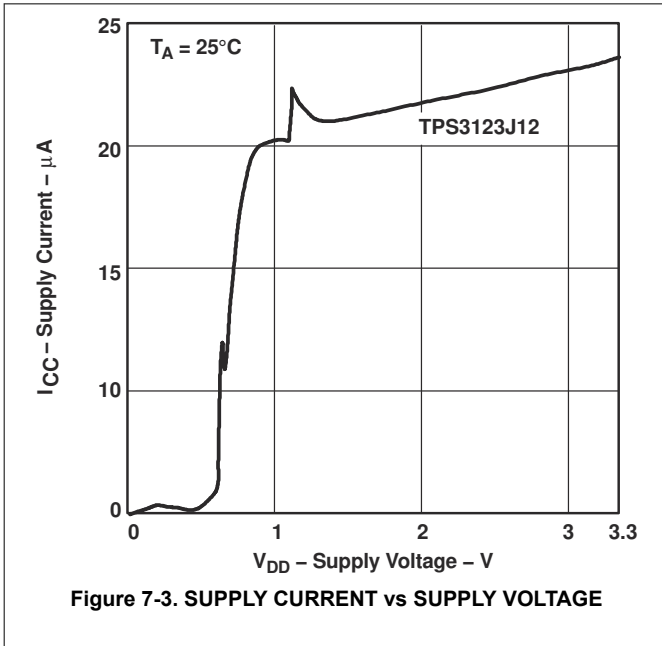

Figure 7-2. Timing Diagram TPS3123/4/8

Note

A=Min VDD, B=VDD threshold, C,F,J=Watch Dog timeout, D,E,H=Watch Dog retriggered, G=Manual Reset

7.9 Typical Characteristics



7.9 Typical Characteristics (continued)

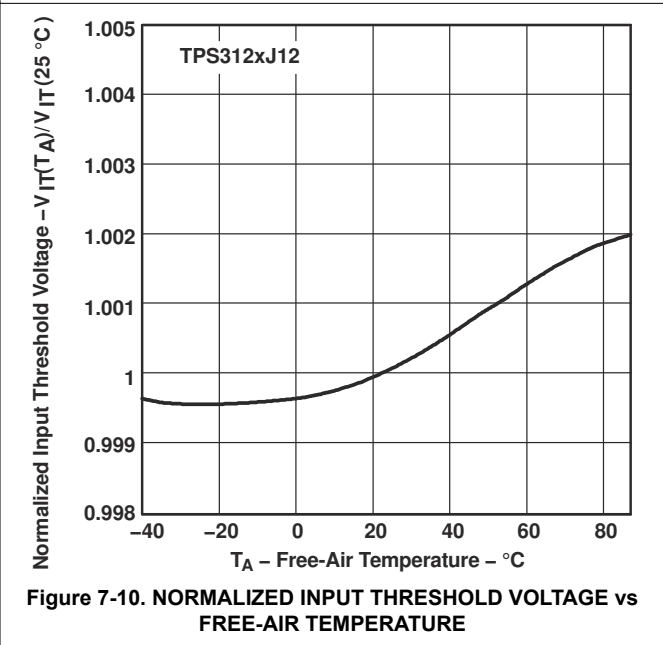
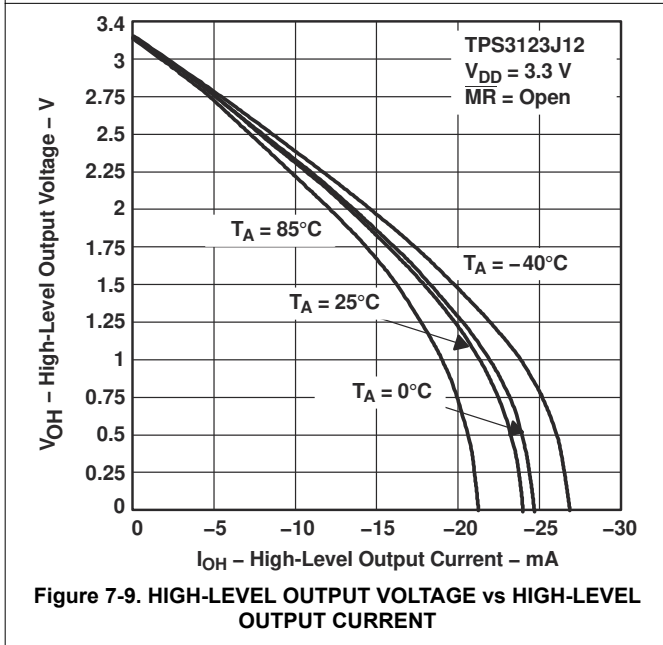
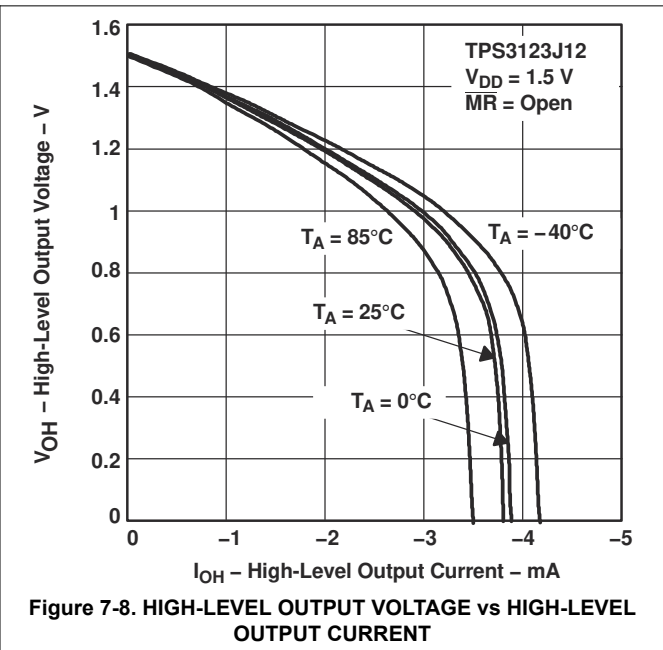
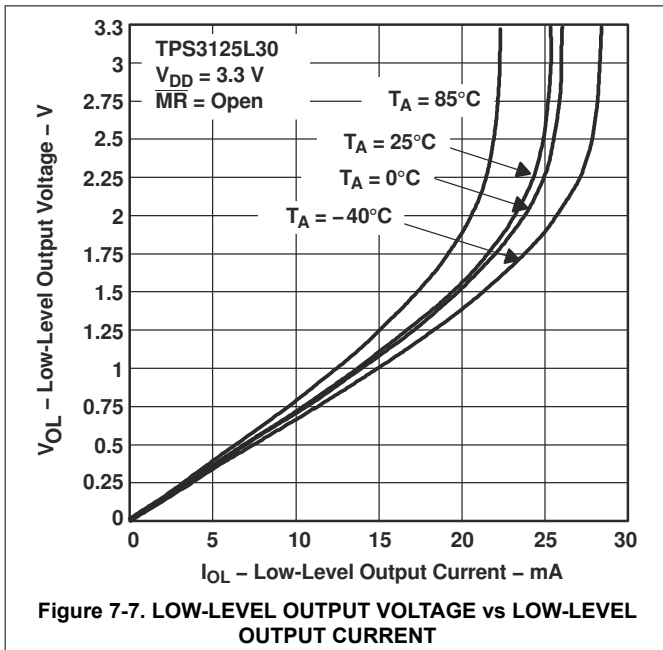

7.9 Typical Characteristics (continued)

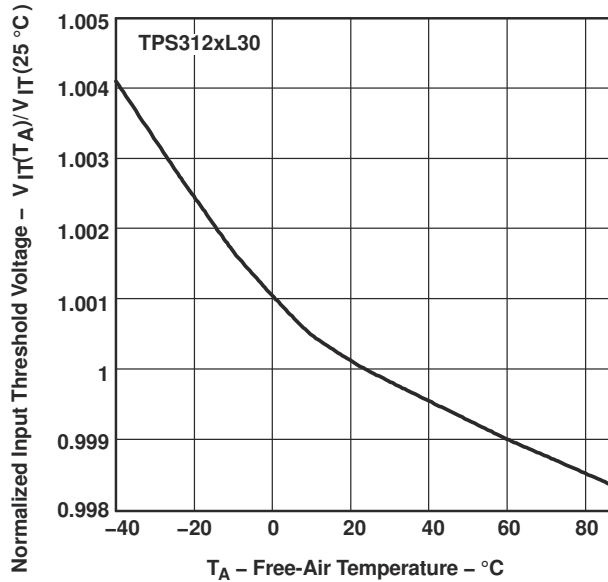

Figure 7-11. NORMALIZED INPUT THRESHOLD VOLTAGE vs FREE-AIR TEMPERATURE

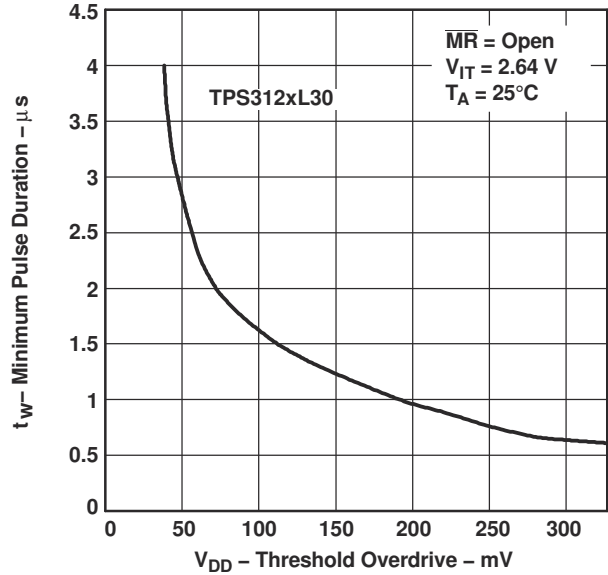

Figure 7-12. MINIMUM PULSE DURATION vs THRESHOLD OVERDRIVE

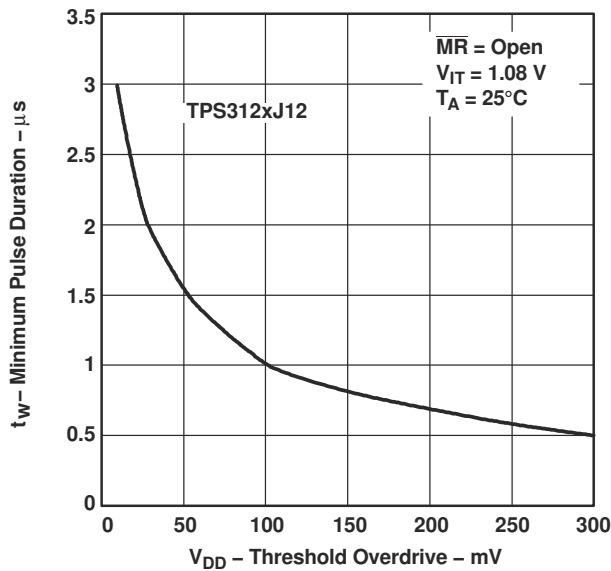

Figure 7-13. MINIMUM PULSE DURATION vs THRESHOLD OVERDRIVE

8 Detailed Description

8.1 Overview

The TPS312x family of supervisors provide circuit initialization and timing supervision. Optional configurations include devices with active-high and active-low output signals (TPS3124/3125/3126), devices with a watchdog timer (TPS3123/3124/3128), and devices with manual reset (\overline{MR}) pins (TPS3123/3125/3126/3128). \overline{RESET} output is valid when the supply voltage, V_{DD} , is above 0.75 V. For devices with active-low output logic, the device monitors V_{DD} and keeps \overline{RESET} low as long as V_{DD} remains below the negative threshold voltage, V_{IT-} . For devices with active-high output logic, \overline{RESET} remains high as long as V_{DD} remains below V_{IT-} . An internal timer delays the return of the output to the inactive state (high) to ensure proper system reset. The delay time, t_d , starts after V_{DD} rises above the positive threshold voltage ($V_{IT-} + V_{HYS}$). When the supply voltage drops below V_{IT-} , the output becomes active (low) again. All the devices of this family have a fixed-sense threshold voltage, V_{IT-} , set by an internal voltage divider, so no external components are required.

The TPS312x family is designed to monitor voltages listed on Table 9-2. For devices with the manual reset functionality, a low level at \overline{MR} causes \overline{RESET} to become active. For devices with the watch dog timer functionality, when the supervising system fails to retrigger the watchdog circuit within the time-out interval $t_{out} = 0.8$ s, \overline{RESET} output becomes active for the time period (t_d). This event also reinitializes the watchdog timer. The devices are available in a 5-pin SOT-23 package and are characterized for operation over a temperature range of -40°C to 85°C .

8.2 Functional Block Diagram

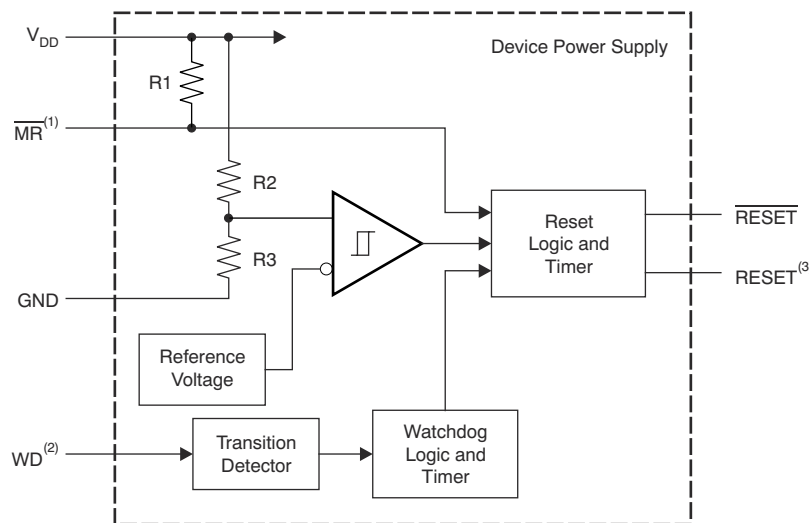

- NOTES:
 (1) TPS3123/5/6/8
 (2) TPS3123/4/8
 (3) TPS3124/5/6

Figure 8-1. FUNCTIONAL BLOCK DIAGRAM

8.3 Feature Description

8.3.1 Manual Reset (\overline{MR})

The \overline{MR} input allows an external logic signal from processors, logic circuits, and/or discrete sensors to force a reset signal regardless of V_{DD} with respect to V_{IT-} or the state of the watchdog timer. A low level at \overline{MR} causes the reset signals to become active.

8.3.2 Active-High or Active-Low Output

All TPS312x devices have an active-low logic output ($\overline{\text{RESET}}$), while the TPS3124/3125/3126 devices also include an active-high logic output (RESET).

8.3.3 Push-Pull or Open-Drain Output

All TPS312x devices, except for TPS3126/3128, have push-pull outputs. TPS3126/3128 devices have an open-drain output.

8.3.4 Watchdog Timer (WDI)

The TPS3123, TPS3124, and TPS3128 devices have a watchdog timer that must be periodically triggered by either a positive or negative transition at WDI to avoid a reset signal being issued. When the supervising system fails to retrigger the watchdog circuit within the time-out interval, t_{out} , $\overline{\text{RESET}}$ becomes active for the time period t_d . This event also reinitializes the watchdog timer.

8.4 Device Functional Modes

Table 8-1 lists the functional modes of the TPS312x devices.

Table 8-1. Device Functional Modes Table

TPS3123/8			TPS3124			TPS3125/6			
MR	VDD > V _{IT}	$\overline{\text{RESET}}$	VDD > V _{IT}	$\overline{\text{RESET}}$	RESET	MR	VDD > V _{IT}	$\overline{\text{RESET}}$	RESET
L	0	L	0	L	H	L	0	L	H
L	1	L	1	H	L	L	1	L	H
H	0	L				H	0	L	H
H	1	H				H	1	H	L

9 Device and Documentation Support

Table 9-1. Ordering Information Application Specific Versions ⁽¹⁾

DEVICE NAME	NOMINAL SUPPLY VOLTAGE, V_{NOM}	DEVICE NAME	TYPICAL RESET THRESHOLD VOLTAGE- V_{IT-}
TPS312xx12DBV	1.2 V	TPS312xAxxDBV	$V_{NOM} -1\%$
TPS312xx15DBV	1.5 V	TPS312xBxxDBV	$V_{NOM} -2\%$
TPS312xx18DBV	1.8 V	TPS312xCxxDBV	$V_{NOM} -3\%$
TPS312xx30DBV	3.0 V	TPS312xDxxDBV	$V_{NOM} -4\%$
		TPS312xExxDBV	$V_{NOM} -5\%$
		TPS312xFxxDBV	$V_{NOM} -6\%$
		TPS312xGxxDBV	$V_{NOM} -7\%$
		TPS312xHxxDBV	$V_{NOM} -8\%$
		TPS312xIxxDBV	$V_{NOM} -9\%$
		TPS312xJxxDBV	$V_{NOM} -10\%$
		TPS312xKxxDBV	$V_{NOM} -11\%$
		TPS312xLxxDBV	$V_{NOM} -12\%$
		TPS312xMxxDBV	$V_{NOM} -13\%$
		TPS312xNxxDBV	$V_{NOM} -14\%$
		TPS312xOxxDBV	$V_{NOM} -15\%$

- For the application-specific versions contact Texas Instruments for availability, lead time, and minimum order quantities.

Table 9-2. Package Information, Standard Versions ^{(1) (2)}

T_A	DEVICE NAME		THRESHOLD VOLTAGE	MARKING
-40°C to +85°C	TPS3123J12DBVR ⁽³⁾	TPS3123J12DBVT ⁽⁴⁾	1.08 V	PBNI
	TPS3123G15DBVR ⁽³⁾	TPS3123G15DBVT ⁽⁴⁾	1.40 V	PBOI
	TPS3123J18DBVR ⁽³⁾	TPS3123J18DBVT ⁽⁴⁾	1.62 V	PBPI
	TPS3124J12DBVR ⁽³⁾	TPS3124J12DBVT ⁽⁴⁾	1.08 V	PBQI
	TPS3124G15DBVR ⁽³⁾	TPS3124G15DBVT ⁽⁴⁾	1.40 V	PBRI
	TPS3124J18DBVR ⁽³⁾	TPS3124J18DBVT ⁽⁴⁾	1.62 V	PBSI
	TPS3125J12DBVR ⁽³⁾	TPS3125J12DBVT ⁽⁴⁾	1.08 V	PBTI
	TPS3125G15DBVR ⁽³⁾	TPS3125G15DBVT ⁽⁴⁾	1.40 V	PBUI
	TPS3125J18DBVR ⁽³⁾	TPS3125J18DBVT ⁽⁴⁾	1.62 V	PBVI
	TPS3125L30DBVR ⁽³⁾	TPS3125L30DBVT ⁽⁴⁾	2.64 V	PBXI
	TPS3126E12DBVR ⁽³⁾	TPS3126E12DBVT ⁽⁴⁾	1.14 V	PFOI
	TPS3126E15DBVR ⁽³⁾	TPS3126E15DBVT ⁽⁴⁾	1.43 V	PFPI
	TPS3126E18DBVR ⁽³⁾	TPS3126E18DBVT ⁽⁴⁾	1.71 V	PFQI
	TPS3128E15DBVR ⁽³⁾	TPS3128E15DBVT ⁽⁴⁾	1.43 V	PFSI
TPS3128E18DBVR ⁽³⁾	TPS3128E18DBVT ⁽⁴⁾	1.71 V	PFTI	

- Other versions available. Contact Texas Instruments for details; minimum order quantities apply.
- For the most current package and ordering information see the Package Option Addendum at the end of this document, or visit the device product folder at www.ti.com.
- The DBVR passive indicates tape and reel of 3000 parts.
- The DBVT passive indicates tape and reel of 250 parts.

PACKAGING INFORMATION

Orderable Device	Status (1)	Package Type	Package Drawing	Pins	Package Qty	Eco Plan (2)	Lead finish/ Ball material (6)	MSL Peak Temp (3)	Op Temp (°C)	Device Marking (4/5)	Samples
TPS3123J12DBVR	ACTIVE	SOT-23	DBV	5	3000	RoHS & Green	NIPDAU	Level-1-260C-UNLIM	-40 to 85	PBNI	Samples
TPS3123J18DBVR	ACTIVE	SOT-23	DBV	5	3000	RoHS & Green	NIPDAU	Level-1-260C-UNLIM	-40 to 85	PBPI	Samples
TPS3123J18DBVT	LIFEBUY	SOT-23	DBV	5	250	RoHS & Green	NIPDAU	Level-1-260C-UNLIM	-40 to 85	PBPI	
TPS3124G15DBVR	ACTIVE	SOT-23	DBV	5	3000	RoHS & Green	NIPDAU	Level-1-260C-UNLIM	-40 to 85	PBRI	Samples
TPS3124J12DBVR	ACTIVE	SOT-23	DBV	5	3000	RoHS & Green	NIPDAU	Level-1-260C-UNLIM	-40 to 85	PBQI	Samples
TPS3124J18DBVR	ACTIVE	SOT-23	DBV	5	3000	RoHS & Green	NIPDAU	Level-1-260C-UNLIM	-40 to 85	PBSI	Samples
TPS3125G15DBVR	ACTIVE	SOT-23	DBV	5	3000	RoHS & Green	NIPDAU	Level-1-260C-UNLIM	-40 to 85	PBUI	Samples
TPS3125J12DBVR	ACTIVE	SOT-23	DBV	5	3000	RoHS & Green	NIPDAU	Level-1-260C-UNLIM	-40 to 85	PBTI	Samples
TPS3125J18DBVR	ACTIVE	SOT-23	DBV	5	3000	RoHS & Green	NIPDAU	Level-1-260C-UNLIM	-40 to 85	PBVI	Samples
TPS3125J18DBVT	LIFEBUY	SOT-23	DBV	5	250	RoHS & Green	NIPDAU	Level-1-260C-UNLIM	-40 to 85	PBVI	
TPS3125L30DBVR	ACTIVE	SOT-23	DBV	5	3000	RoHS & Green	NIPDAU	Level-1-260C-UNLIM	-40 to 85	PBXI	Samples
TPS3125L30DBVT	LIFEBUY	SOT-23	DBV	5	250	RoHS & Green	NIPDAU	Level-1-260C-UNLIM	-40 to 85	PBXI	
TPS3126E12DBVR	ACTIVE	SOT-23	DBV	5	3000	RoHS & Green	NIPDAU	Level-1-260C-UNLIM	-40 to 85	PFOI	Samples
TPS3126E12DBVT	LIFEBUY	SOT-23	DBV	5	250	RoHS & Green	NIPDAU	Level-1-260C-UNLIM	-40 to 85	PFOI	
TPS3126E15DBVR	ACTIVE	SOT-23	DBV	5	3000	RoHS & Green	NIPDAU	Level-1-260C-UNLIM	-40 to 85	PFPI	Samples
TPS3126E15DBVT	LIFEBUY	SOT-23	DBV	5	250	RoHS & Green	NIPDAU	Level-1-260C-UNLIM	-40 to 85	PFPI	
TPS3126E18DBVR	ACTIVE	SOT-23	DBV	5	3000	RoHS & Green	NIPDAU	Level-1-260C-UNLIM	-40 to 85	PFQI	Samples
TPS3126E18DBVT	LIFEBUY	SOT-23	DBV	5	250	RoHS & Green	NIPDAU	Level-1-260C-UNLIM	-40 to 85	PFQI	
TPS3128E12DBVT	ACTIVE	SOT-23	DBV	5	250	RoHS & Green	NIPDAU	Level-1-260C-UNLIM	-40 to 85	PFRI	Samples
TPS3128E15DBVR	ACTIVE	SOT-23	DBV	5	3000	RoHS & Green	NIPDAU	Level-1-260C-UNLIM	-40 to 85	PFSI	Samples
TPS3128E15DBVT	LIFEBUY	SOT-23	DBV	5	250	RoHS & Green	NIPDAU	Level-1-260C-UNLIM	-40 to 85	PFSI	
TPS3128E18DBVR	ACTIVE	SOT-23	DBV	5	3000	RoHS & Green	NIPDAU	Level-1-260C-UNLIM	-40 to 85	PFTI	Samples

Orderable Device	Status (1)	Package Type	Package Drawing	Pins	Package Qty	Eco Plan (2)	Lead finish/ Ball material (6)	MSL Peak Temp (3)	Op Temp (°C)	Device Marking (4/5)	Samples
TPS3128E18DBVT	LIFEBUY	SOT-23	DBV	5	250	RoHS & Green	NIPDAU	Level-1-260C-UNLIM	-40 to 85	PFTI	

(1) The marketing status values are defined as follows:

ACTIVE: Product device recommended for new designs.

LIFEBUY: TI has announced that the device will be discontinued, and a lifetime-buy period is in effect.

NRND: Not recommended for new designs. Device is in production to support existing customers, but TI does not recommend using this part in a new design.

PREVIEW: Device has been announced but is not in production. Samples may or may not be available.

OBSOLETE: TI has discontinued the production of the device.

(2) **RoHS:** TI defines "RoHS" to mean semiconductor products that are compliant with the current EU RoHS requirements for all 10 RoHS substances, including the requirement that RoHS substance do not exceed 0.1% by weight in homogeneous materials. Where designed to be soldered at high temperatures, "RoHS" products are suitable for use in specified lead-free processes. TI may reference these types of products as "Pb-Free".

RoHS Exempt: TI defines "RoHS Exempt" to mean products that contain lead but are compliant with EU RoHS pursuant to a specific EU RoHS exemption.

Green: TI defines "Green" to mean the content of Chlorine (Cl) and Bromine (Br) based flame retardants meet JS709B low halogen requirements of <=1000ppm threshold. Antimony trioxide based flame retardants must also meet the <=1000ppm threshold requirement.

(3) MSL, Peak Temp. - The Moisture Sensitivity Level rating according to the JEDEC industry standard classifications, and peak solder temperature.

(4) There may be additional marking, which relates to the logo, the lot trace code information, or the environmental category on the device.

(5) Multiple Device Markings will be inside parentheses. Only one Device Marking contained in parentheses and separated by a "~" will appear on a device. If a line is indented then it is a continuation of the previous line and the two combined represent the entire Device Marking for that device.

(6) Lead finish/Ball material - Orderable Devices may have multiple material finish options. Finish options are separated by a vertical ruled line. Lead finish/Ball material values may wrap to two lines if the finish value exceeds the maximum column width.

Important Information and Disclaimer:The information provided on this page represents TI's knowledge and belief as of the date that it is provided. TI bases its knowledge and belief on information provided by third parties, and makes no representation or warranty as to the accuracy of such information. Efforts are underway to better integrate information from third parties. TI has taken and continues to take reasonable steps to provide representative and accurate information but may not have conducted destructive testing or chemical analysis on incoming materials and chemicals. TI and TI suppliers consider certain information to be proprietary, and thus CAS numbers and other limited information may not be available for release.

In no event shall TI's liability arising out of such information exceed the total purchase price of the TI part(s) at issue in this document sold by TI to Customer on an annual basis.

TAPE AND REEL INFORMATION

QUADRANT ASSIGNMENTS FOR PIN 1 ORIENTATION IN TAPE

*All dimensions are nominal

Device	Package Type	Package Drawing	Pins	SPQ	Reel Diameter (mm)	Reel Width W1 (mm)	A0 (mm)	B0 (mm)	K0 (mm)	P1 (mm)	W (mm)	Pin1 Quadrant
TPS3123J12DBVR	SOT-23	DBV	5	3000	180.0	9.0	3.15	3.2	1.4	4.0	8.0	Q3
TPS3123J18DBVR	SOT-23	DBV	5	3000	180.0	9.0	3.15	3.2	1.4	4.0	8.0	Q3
TPS3123J18DBVT	SOT-23	DBV	5	250	180.0	9.0	3.15	3.2	1.4	4.0	8.0	Q3
TPS3124G15DBVR	SOT-23	DBV	5	3000	180.0	9.0	3.15	3.2	1.4	4.0	8.0	Q3
TPS3124J12DBVR	SOT-23	DBV	5	3000	180.0	9.0	3.15	3.2	1.4	4.0	8.0	Q3
TPS3124J18DBVR	SOT-23	DBV	5	3000	180.0	9.0	3.15	3.2	1.4	4.0	8.0	Q3
TPS3125G15DBVR	SOT-23	DBV	5	3000	180.0	9.0	3.15	3.2	1.4	4.0	8.0	Q3
TPS3125J12DBVR	SOT-23	DBV	5	3000	180.0	9.0	3.15	3.2	1.4	4.0	8.0	Q3
TPS3125J18DBVR	SOT-23	DBV	5	3000	180.0	9.0	3.15	3.2	1.4	4.0	8.0	Q3
TPS3125J18DBVT	SOT-23	DBV	5	250	180.0	9.0	3.15	3.2	1.4	4.0	8.0	Q3
TPS3125L30DBVR	SOT-23	DBV	5	3000	180.0	9.0	3.15	3.2	1.4	4.0	8.0	Q3
TPS3125L30DBVT	SOT-23	DBV	5	250	180.0	9.0	3.15	3.2	1.4	4.0	8.0	Q3
TPS3126E12DBVR	SOT-23	DBV	5	3000	180.0	9.0	3.15	3.2	1.4	4.0	8.0	Q3
TPS3126E12DBVT	SOT-23	DBV	5	250	180.0	9.0	3.15	3.2	1.4	4.0	8.0	Q3
TPS3126E15DBVR	SOT-23	DBV	5	3000	180.0	9.0	3.15	3.2	1.4	4.0	8.0	Q3
TPS3126E15DBVT	SOT-23	DBV	5	250	180.0	9.0	3.15	3.2	1.4	4.0	8.0	Q3

Device	Package Type	Package Drawing	Pins	SPQ	Reel Diameter (mm)	Reel Width W1 (mm)	A0 (mm)	B0 (mm)	K0 (mm)	P1 (mm)	W (mm)	Pin1 Quadrant
TPS3126E18DBVR	SOT-23	DBV	5	3000	180.0	9.0	3.15	3.2	1.4	4.0	8.0	Q3
TPS3126E18DBVT	SOT-23	DBV	5	250	180.0	9.0	3.15	3.2	1.4	4.0	8.0	Q3
TPS3128E12DBVT	SOT-23	DBV	5	250	180.0	9.0	3.15	3.2	1.4	4.0	8.0	Q3
TPS3128E15DBVR	SOT-23	DBV	5	3000	180.0	9.0	3.15	3.2	1.4	4.0	8.0	Q3
TPS3128E15DBVT	SOT-23	DBV	5	250	180.0	9.0	3.15	3.2	1.4	4.0	8.0	Q3
TPS3128E18DBVR	SOT-23	DBV	5	3000	180.0	9.0	3.15	3.2	1.4	4.0	8.0	Q3
TPS3128E18DBVT	SOT-23	DBV	5	250	180.0	9.0	3.15	3.2	1.4	4.0	8.0	Q3

TAPE AND REEL BOX DIMENSIONS

*All dimensions are nominal

Device	Package Type	Package Drawing	Pins	SPQ	Length (mm)	Width (mm)	Height (mm)
TPS3123J12DBVR	SOT-23	DBV	5	3000	182.0	182.0	20.0
TPS3123J18DBVR	SOT-23	DBV	5	3000	182.0	182.0	20.0
TPS3123J18DBVT	SOT-23	DBV	5	250	182.0	182.0	20.0
TPS3124G15DBVR	SOT-23	DBV	5	3000	182.0	182.0	20.0
TPS3124J12DBVR	SOT-23	DBV	5	3000	182.0	182.0	20.0
TPS3124J18DBVR	SOT-23	DBV	5	3000	182.0	182.0	20.0
TPS3125G15DBVR	SOT-23	DBV	5	3000	182.0	182.0	20.0
TPS3125J12DBVR	SOT-23	DBV	5	3000	182.0	182.0	20.0
TPS3125J18DBVR	SOT-23	DBV	5	3000	182.0	182.0	20.0
TPS3125J18DBVT	SOT-23	DBV	5	250	182.0	182.0	20.0
TPS3125L30DBVR	SOT-23	DBV	5	3000	182.0	182.0	20.0
TPS3125L30DBVT	SOT-23	DBV	5	250	182.0	182.0	20.0
TPS3126E12DBVR	SOT-23	DBV	5	3000	182.0	182.0	20.0
TPS3126E12DBVT	SOT-23	DBV	5	250	182.0	182.0	20.0
TPS3126E15DBVR	SOT-23	DBV	5	3000	182.0	182.0	20.0
TPS3126E15DBVT	SOT-23	DBV	5	250	182.0	182.0	20.0
TPS3126E18DBVR	SOT-23	DBV	5	3000	182.0	182.0	20.0
TPS3126E18DBVT	SOT-23	DBV	5	250	182.0	182.0	20.0

Device	Package Type	Package Drawing	Pins	SPQ	Length (mm)	Width (mm)	Height (mm)
TPS3128E12DBVT	SOT-23	DBV	5	250	182.0	182.0	20.0
TPS3128E15DBVR	SOT-23	DBV	5	3000	182.0	182.0	20.0
TPS3128E15DBVT	SOT-23	DBV	5	250	182.0	182.0	20.0
TPS3128E18DBVR	SOT-23	DBV	5	3000	182.0	182.0	20.0
TPS3128E18DBVT	SOT-23	DBV	5	250	182.0	182.0	20.0

DBV0005A



PACKAGE OUTLINE

SOT-23 - 1.45 mm max height

SMALL OUTLINE TRANSISTOR



4214839/J 02/2024

NOTES:

1. All linear dimensions are in millimeters. Any dimensions in parenthesis are for reference only. Dimensioning and tolerancing per ASME Y14.5M.
2. This drawing is subject to change without notice.
3. Reference JEDEC MO-178.
4. Body dimensions do not include mold flash, protrusions, or gate burrs. Mold flash, protrusions, or gate burrs shall not exceed 0.25 mm per side.
5. Support pin may differ or may not be present.

EXAMPLE BOARD LAYOUT

DBV0005A

SOT-23 - 1.45 mm max height

SMALL OUTLINE TRANSISTOR



LAND PATTERN EXAMPLE
EXPOSED METAL SHOWN
SCALE:15X



SOLDER MASK DETAILS

4214839/J 02/2024

NOTES: (continued)

- 6. Publication IPC-7351 may have alternate designs.
- 7. Solder mask tolerances between and around signal pads can vary based on board fabrication site.

EXAMPLE STENCIL DESIGN

DBV0005A

SOT-23 - 1.45 mm max height

SMALL OUTLINE TRANSISTOR



SOLDER PASTE EXAMPLE
BASED ON 0.125 mm THICK STENCIL
SCALE:15X

4214839/J 02/2024

NOTES: (continued)

8. Laser cutting apertures with trapezoidal walls and rounded corners may offer better paste release. IPC-7525 may have alternate design recommendations.
9. Board assembly site may have different recommendations for stencil design.

IMPORTANT NOTICE AND DISCLAIMER

TI PROVIDES TECHNICAL AND RELIABILITY DATA (INCLUDING DATA SHEETS), DESIGN RESOURCES (INCLUDING REFERENCE DESIGNS), APPLICATION OR OTHER DESIGN ADVICE, WEB TOOLS, SAFETY INFORMATION, AND OTHER RESOURCES "AS IS" AND WITH ALL FAULTS, AND DISCLAIMS ALL WARRANTIES, EXPRESS AND IMPLIED, INCLUDING WITHOUT LIMITATION ANY IMPLIED WARRANTIES OF MERCHANTABILITY, FITNESS FOR A PARTICULAR PURPOSE OR NON-INFRINGEMENT OF THIRD PARTY INTELLECTUAL PROPERTY RIGHTS.

These resources are intended for skilled developers designing with TI products. You are solely responsible for (1) selecting the appropriate TI products for your application, (2) designing, validating and testing your application, and (3) ensuring your application meets applicable standards, and any other safety, security, regulatory or other requirements.

These resources are subject to change without notice. TI grants you permission to use these resources only for development of an application that uses the TI products described in the resource. Other reproduction and display of these resources is prohibited. No license is granted to any other TI intellectual property right or to any third party intellectual property right. TI disclaims responsibility for, and you will fully indemnify TI and its representatives against, any claims, damages, costs, losses, and liabilities arising out of your use of these resources.

TI's products are provided subject to [TI's Terms of Sale](#) or other applicable terms available either on [ti.com](https://www.ti.com) or provided in conjunction with such TI products. TI's provision of these resources does not expand or otherwise alter TI's applicable warranties or warranty disclaimers for TI products.

TI objects to and rejects any additional or different terms you may have proposed.

Mailing Address: Texas Instruments, Post Office Box 655303, Dallas, Texas 75265
Copyright © 2024, Texas Instruments Incorporated