

TPS2290x Ultra-Small Low-Input-Voltage Low r_{ON} Load Switch

1 Features

- Input Voltage: 1.1 V to 3.6 V
- Ultralow ON-State Resistance
 - $r_{ON} = 66 \text{ m}\Omega$ at $V_{IN} = 3.6 \text{ V}$
 - $r_{ON} = 75 \text{ m}\Omega$ at $V_{IN} = 2.5 \text{ V}$
 - $r_{ON} = 90 \text{ m}\Omega$ at $V_{IN} = 1.8 \text{ V}$
 - $r_{ON} = 135 \text{ m}\Omega$ at $V_{IN} = 1.2 \text{ V}$
- 500-mA Maximum Continuous Switch Current
- Quiescent Current $< 1 \mu\text{A}$
- Shutdown Current $< 1 \mu\text{A}$
- Low Control Input Threshold Enables Use of 1.2-V, 1.8-V, 2.5-V, and 3.3-V Logic
- Controlled Slew Rate (5 μs Maximum at 3.6 V)
- Quick Output Discharge (TPS22904 Only)
- ESD Performance Tested Per JESD 22
 - 2000-V Human Body Model (A114-B, Class II)
 - 1000-V Charged-Device Model (C101)
- 4-Terminal Wafer Chip-Scale Package (WCSP)
 - 0.8 mm \times 0.8 mm, 0.4-mm Pitch, 0.5-mm Height

2 Applications

- PDAs
- Cell Phones
- GPS Devices
- MP3 Players
- Digital Cameras
- Peripheral Ports
- Portable Instrumentation

3 Description

The TPS22903 and TPS22904 are ultra-small, low r_{ON} single channel load switches with controlled turnon. The device contains a P-channel MOSFET that can operate over an input voltage range of 1.1 V to 3.6 V. The switch is controlled by an on and off input (ON), which is capable of interfacing directly with low-voltage control signals. In TPS22904, a 85- Ω on-chip load resistor is added for output quick discharge when switch is turned off.

TPS22903 and TPS22904 are available in a space-saving 4-terminal WCSP 0.4-mm pitch (YFP). The devices are characterized for operation over the free-air temperature range of -40°C to 85°C .

Device Information⁽¹⁾

PART NUMBER	PACKAGE	BODY SIZE (NOM)
TPS22903	DSBGA (4)	0.80 mm \times 0.80 mm
TPS22904		

(1) For all available packages, see the orderable addendum at the end of the data sheet.

Simplified Schematic

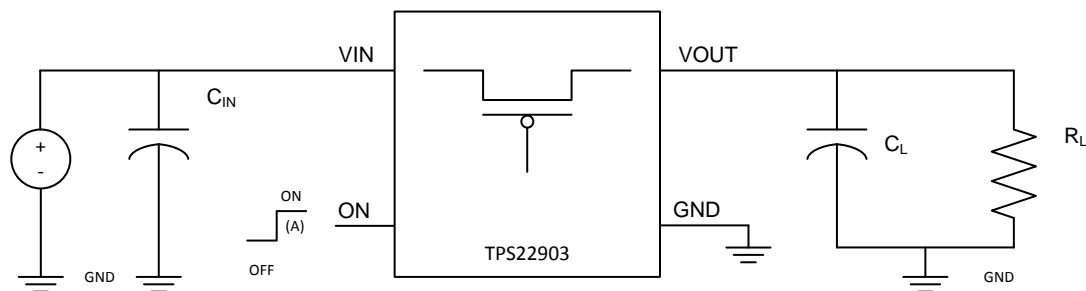

Table of Contents

1 Features	1	9.2 Functional Block Diagram	12
2 Applications	1	9.3 Feature Description	12
3 Description	1	9.4 Device Functional Modes	12
4 Revision History	2	10 Application and Implementation	13
5 Device Comparison Table	3	10.1 Application Information	13
6 Pin Configuration and Functions	3	10.2 Typical Application	13
7 Specifications	3	11 Power Supply Recommendations	15
7.1 Absolute Maximum Ratings	3	12 Layout	15
7.2 ESD Ratings	4	12.1 Layout Guidelines	15
7.3 Recommended Operating Conditions	4	12.2 Layout Example	15
7.4 Thermal Information	4	13 Device and Documentation Support	16
7.5 Electrical Characteristics	4	13.1 Related Links	16
7.6 Switching Characteristics	5	13.2 Community Resources	16
7.7 Typical Characteristics	6	13.3 Trademarks	16
8 Parameter Measurement Information	11	13.4 Electrostatic Discharge Caution	16
9 Detailed Description	12	13.5 Glossary	16
9.1 Overview	12	14 Mechanical, Packaging, and Orderable Information	16

4 Revision History

Changes from Revision C (April 2010) to Revision D

Page

• Added <i>Pin Configuration and Functions</i> section, <i>ESD Ratings</i> table, <i>Feature Description</i> section, <i>Device Functional Modes</i> , <i>Application and Implementation</i> section, <i>Power Supply Recommendations</i> section, <i>Layout</i> section, <i>Device and Documentation Support</i> section, and <i>Mechanical, Packaging, and Orderable Information</i> section	1
• Removed <i>Ordering Information</i> table	1
• Renamed <i>Feature List</i> table to <i>Device Comparison</i> table	3

5 Device Comparison Table

DEVICE	r _{ON} TYPICAL AT 3.6 V	SLEW RATE AT 3.6 V	QUICK OUTPUT DISCHARGE ⁽¹⁾	MAXIMUM OUTPUT CURRENT	ENABLE
TPS22903	66 mΩ	5 μs max	No	500 mA	Active high
TPS22904	66 mΩ	5 μs max	Yes	500 mA	Active high

(1) This feature discharges the output of the switch to ground through a 85-Ω resistor, preventing the output from floating.

6 Pin Configuration and Functions

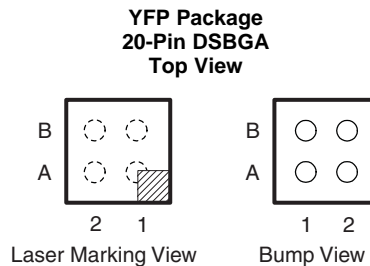

Pin Functions

PIN		I/O	DESCRIPTION
BALL NO.	NAME		
A1	V _{IN}	I	Input of the switch, bypass this input with a ceramic capacitor to ground
A2	V _{OUT}	O	Output of the switch
B1	ON	I	Switch control input, active high, do not leave floating
B2	GND	—	Ground

7 Specifications

7.1 Absolute Maximum Ratings

over operating free-air temperature range (unless otherwise noted)⁽¹⁾

		MIN	MAX	UNIT
V _{IN}	Input voltage	-0.3	4	V
V _{OUT}	Output voltage		V _{IN} + 0.3	V
V _{ON}	Input voltage	-0.3	4	V
P _D	Power dissipation at T _A = 25°C		0.48	W
I _{MAX}	Maximum continuous switch current		0.5	A
T _A	Operating free-air temperature	-40	85	°C
T _{lead}	Maximum lead temperature (10-s soldering time)		300	°C
T _{stg}	Storage temperature	-65	150	°C

(1) Stresses beyond those listed under *Absolute Maximum Ratings* may cause permanent damage to the device. These are stress ratings only, which do not imply functional operation of the device at these or any other conditions beyond those indicated under *Recommended Operating Conditions*. Exposure to absolute-maximum-rated conditions for extended periods may affect device reliability.

7.2 ESD Ratings

		VALUE	UNIT
$V_{(ESD)}$ Electrostatic discharge	Human body model (HBM), per ANSI/ESDA/JEDEC JS-001 ⁽¹⁾	±2000	V
	Charged-device model (CDM), per JEDEC specification JESD22-C101 ⁽²⁾	±1000	

(1) JEDEC document JEP155 states that 500-V HBM allows safe manufacturing with a standard ESD control process.

(2) JEDEC document JEP157 states that 250-V CDM allows safe manufacturing with a standard ESD control process.

7.3 Recommended Operating Conditions

over operating free-air temperature range (unless otherwise noted)

		MIN	MAX	UNIT
V_{IN}	Input voltage	1.1	3.6	V
V_{OUT}	Output voltage		V_{IN}	V
V_{IH}	High-level input voltage, ON	0.85	3.6	V
V_{IL}	Low-level input voltage, ON		0.4	V
C_{IN}	Input capacitor	1		μF

7.4 Thermal Information

THERMAL METRIC ⁽¹⁾		TPS22903	UNIT
		YFP (DSBGA)	
		20 PINS	
$R_{\theta JA}$	Junction-to-ambient thermal resistance	192.6	°C/W
$R_{\theta JC(top)}$	Junction-to-case (top) thermal resistance	2.3	°C/W
$R_{\theta JB}$	Junction-to-board thermal resistance	35.8	°C/W
Ψ_{JT}	Junction-to-top characterization parameter	11.8	°C/W
Ψ_{JB}	Junction-to-board characterization parameter	35.6	°C/W
$R_{\theta JC(bot)}$	Junction-to-case (bottom) thermal resistance	—	°C/W

(1) For more information about traditional and new thermal metrics, see the *Semiconductor and IC Package Thermal Metrics* application report, [SPRA953](#).

7.5 Electrical Characteristics

$V_{IN} = 1.1\text{ V to }3.6\text{ V}$, $T_A = -40^\circ\text{C to }85^\circ\text{C}$ (unless otherwise noted)

PARAMETER	TEST CONDITIONS	T_A	MIN	TYP ⁽¹⁾	MAX	UNIT				
I_{IN}	Quiescent current	$I_{OUT} = 0$, $V_{IN} = V_{ON}$	Full		1	μA				
$I_{IN(OFF)}$	OFF-state supply current	$V_{ON} = \text{GND}$, $OUT = \text{Open}$	Full		1	μA				
$I_{IN(LEAKAGE)}$	OFF-state switch current	$V_{ON} = \text{GND}$, $V_{OUT} = 0$	Full		1	μA				
r_{ON}	ON-state resistance	$I_{OUT} = -200\text{ mA}$	$V_{IN} = 3.6\text{ V}$	25°C	66	90	mΩ			
				Full		95				
			$V_{IN} = 2.5\text{ V}$	25°C	75	95				
				Full		110				
			$V_{IN} = 1.8\text{ V}$	25°C	90	115				
				Full		125				
			$V_{IN} = 1.2\text{ V}$	25°C	135	175				
				Full		185				
			$V_{IN} = 1.1\text{ V}$	25°C	157	275				
				Full		300				
			r_{PD}	Output pulldown resistance	$V_{IN} = 3.3\text{ V}$, $V_{ON} = 0$ (TPS22904 only), $I_{OUT} = 30\text{ mA}$			85	135	Ω
			I_{ON}	ON-state input leakage current	$V_{ON} = 1.1\text{ V to }3.6\text{ V or GND}$	Full			1	μA

(1) Typical values are at $V_{IN} = 3.3\text{ V}$ and $T_A = 25^\circ\text{C}$.

7.6 Switching Characteristics

 $V_{IN} = 3.6\text{ V}$, $T_A = -40^\circ\text{C}$ to 85°C (unless otherwise noted)

PARAMETER		TEST CONDITIONS	TPS22903			TPS22904			UNIT
			MIN	TYP ⁽¹⁾	MAX	MIN	TYP ⁽¹⁾	MAX	
t_{ON}	Turnon time	$I_{OUT} = 100\text{ mA}$, $C_L = 0.1\ \mu\text{F}$		0.9	1.5		0.9	1.5	μs
t_{OFF}	Turnoff time	$I_{OUT} = 100\text{ mA}$, $C_L = 0.1\ \mu\text{F}$		5.8	8		5.3	7	μs
t_r	V_{OUT} rise time	$I_{OUT} = 100\text{ mA}$, $C_L = 0.1\ \mu\text{F}$		0.80	5		0.8	5	μs
t_f	V_{OUT} fall time	$I_{OUT} = 100\text{ mA}$, $C_L = 0.1\ \mu\text{F}$		8.3	10		5.8	7	μs

 (1) Typical values are at $T_A = 25^\circ\text{C}$.

7.7 Typical Characteristics

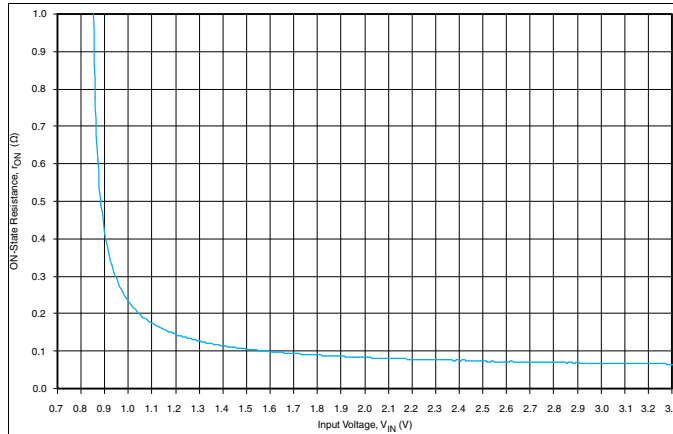

Figure 1. r_{ON} vs V_{IN}

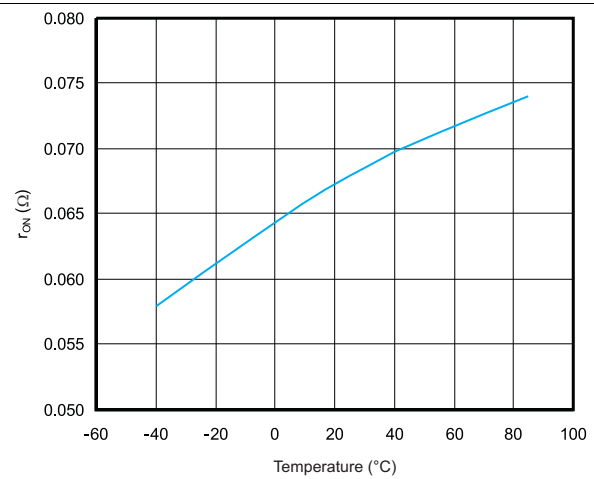

Figure 2. r_{ON} vs Temperature ($V_{IN} = 3.3\text{ V}$)

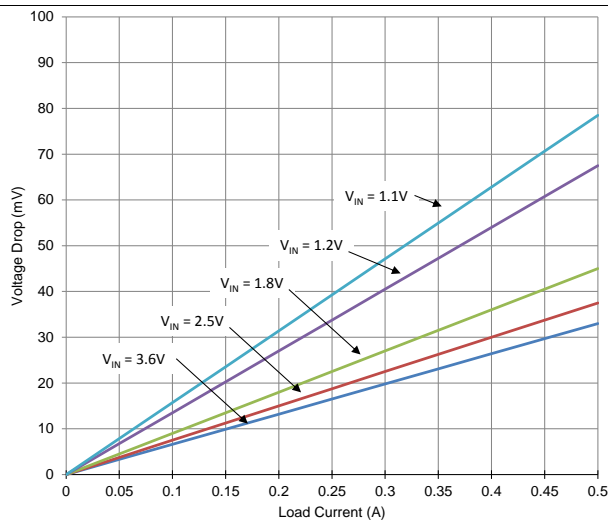

Figure 3. Voltage Drop vs Load Current

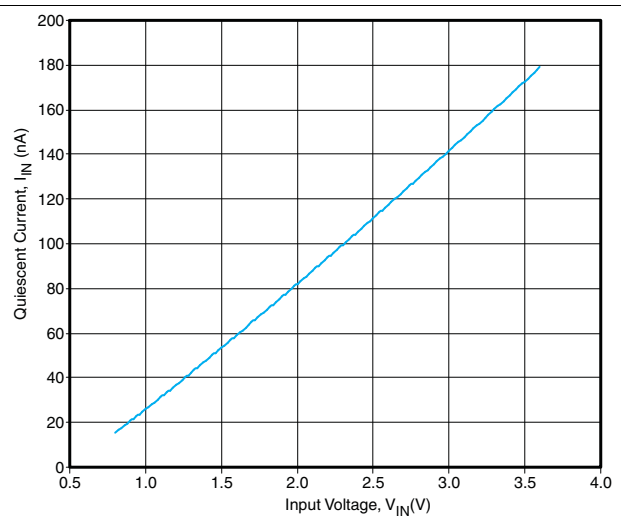

Figure 4. Quiescent Current vs V_{IN}
($V_{ON} = V_{IN}$, $I_{OUT} = 0$)

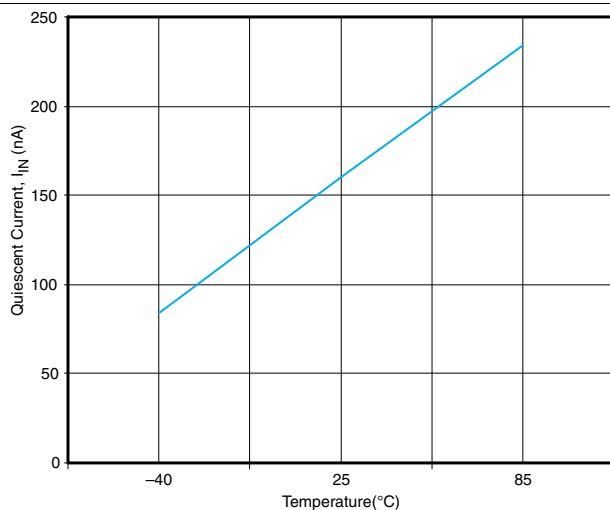

Figure 5. Quiescent Current vs Temperature
($V_{IN} = 3.3\text{ V}$, $I_{OUT} = 0$)

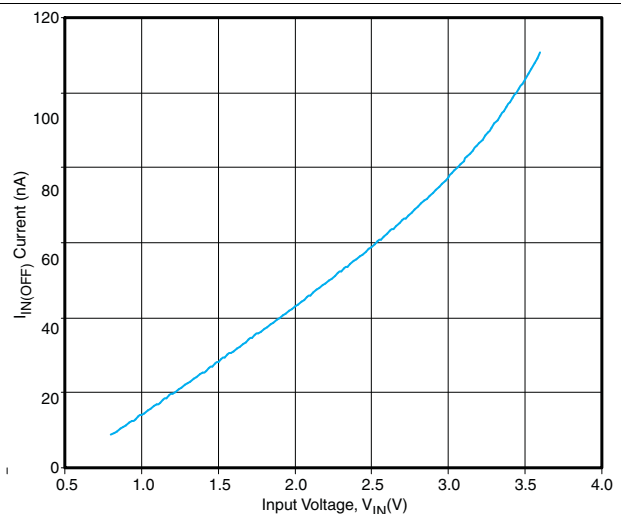

Figure 6. $I_{IN(OFF)}$ vs V_{IN} ($V_{ON} = 0\text{ V}$)

Typical Characteristics (continued)

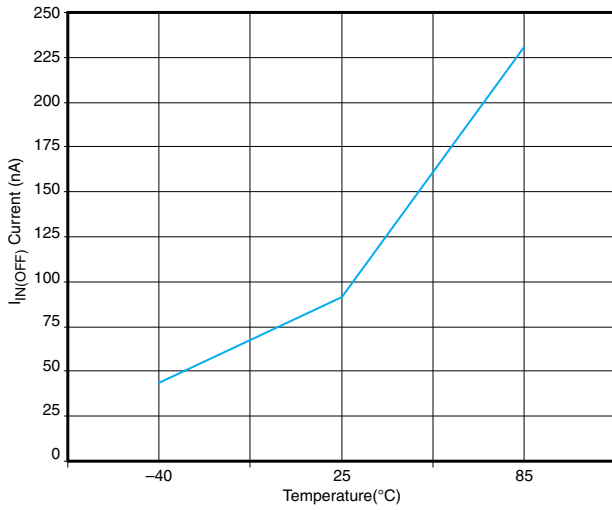

Figure 7. $I_{IN(OFF)}$ vs Temperature ($V_{IN} = 3.3\text{ V}$)

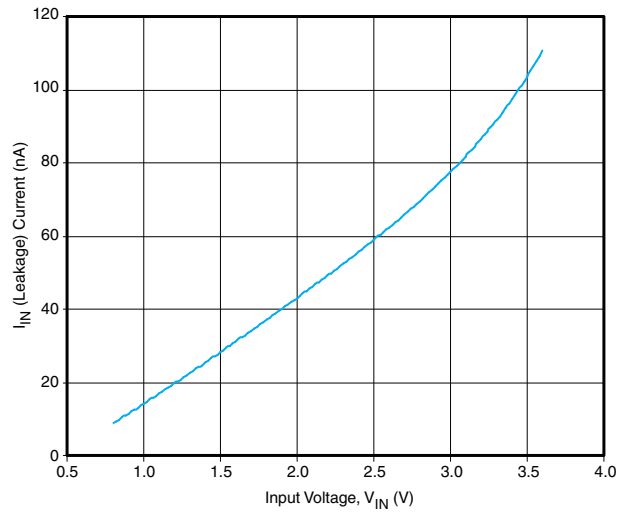

Figure 8. $I_{IN(Leakage)}$ vs V_{IN} ($I_{OUT} = 0$)

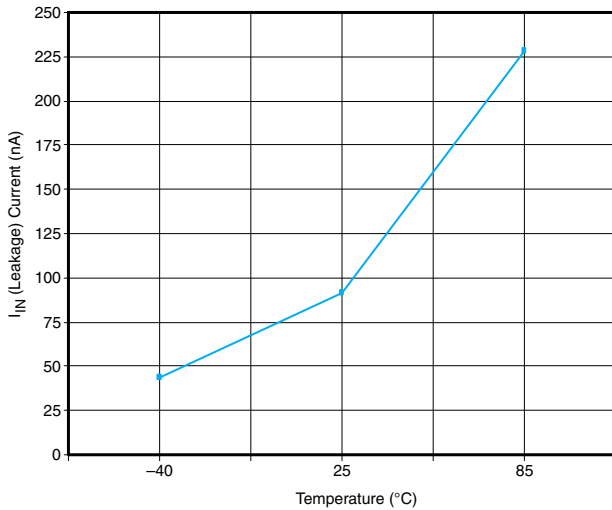

Figure 9. I_{IN} (Leakage) vs Temperature ($V_{IN} = 3.3\text{ V}$)

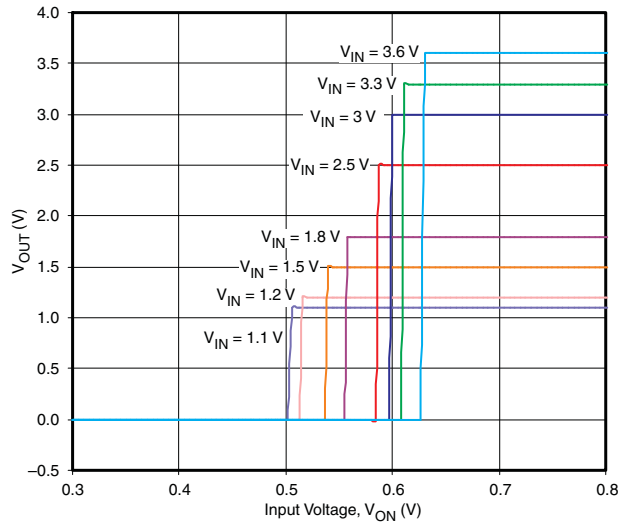

Figure 10. ON-Input Threshold

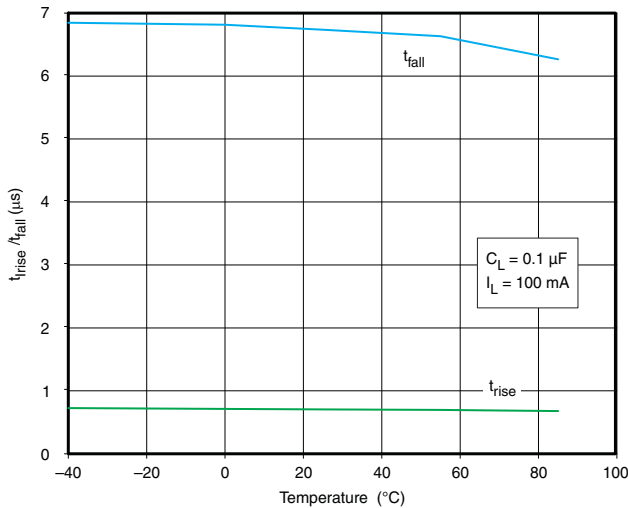

Figure 11. t_{rise} (TPS22903/4) / t_{fall} (TPS22903) vs Temperature ($V_{IN} = 3.3\text{ V}$)

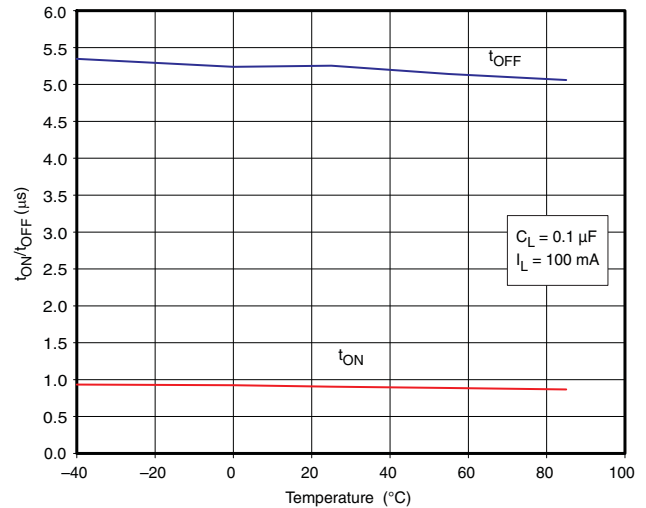
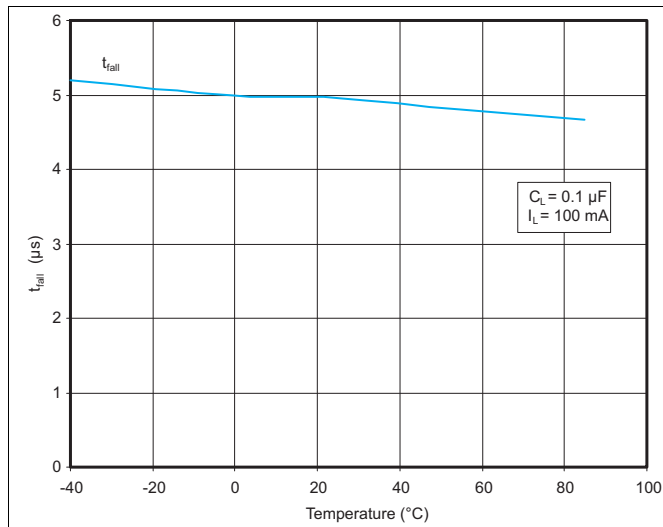
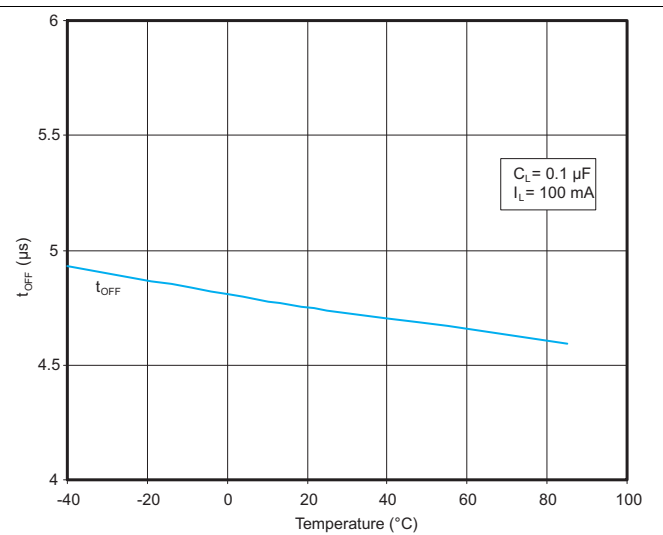
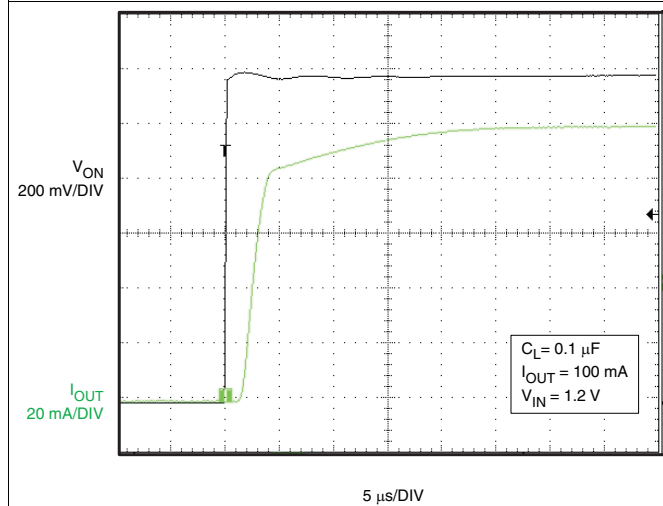
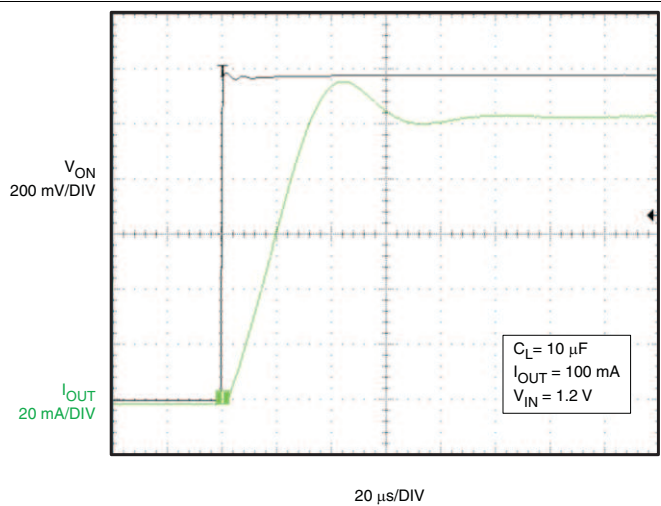
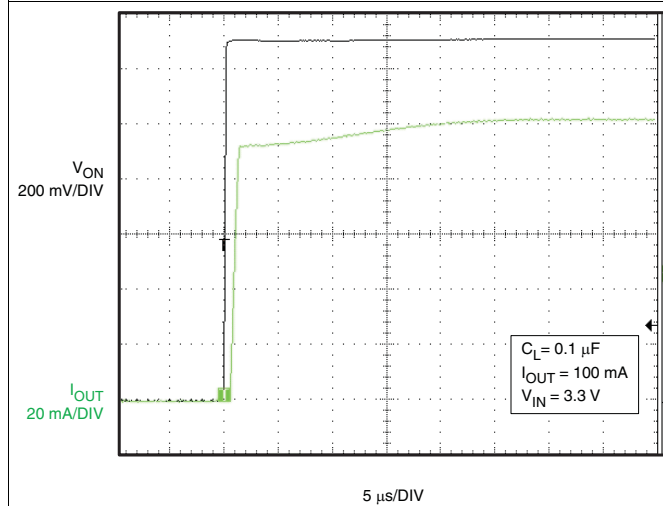
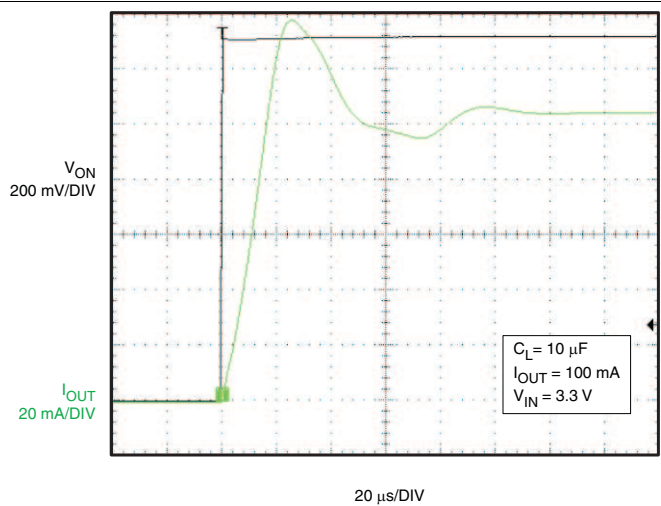

Figure 12. t_{ON} (TPS22903/4) / t_{OFF} (TPS22903) vs Temperature ($V_{IN} = 3.3\text{ V}$)

Typical Characteristics (continued)

Figure 13. t_{rfall} (TPS22904) vs Temperature ($V_{IN} = 3.3$ V)

Figure 14. t_{OFF} (TPS22904) vs Temperature ($V_{IN} = 3.3$ V)

Figure 15. t_{ON} Response

Figure 16. t_{ON} Response

Figure 17. t_{ON} Response

Figure 18. t_{ON} Response

Typical Characteristics (continued)

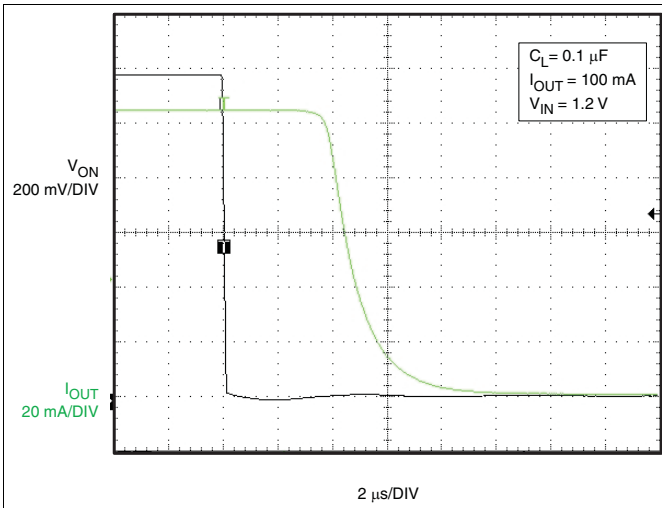

Figure 19. t_{OFF} Response (TPS22903)

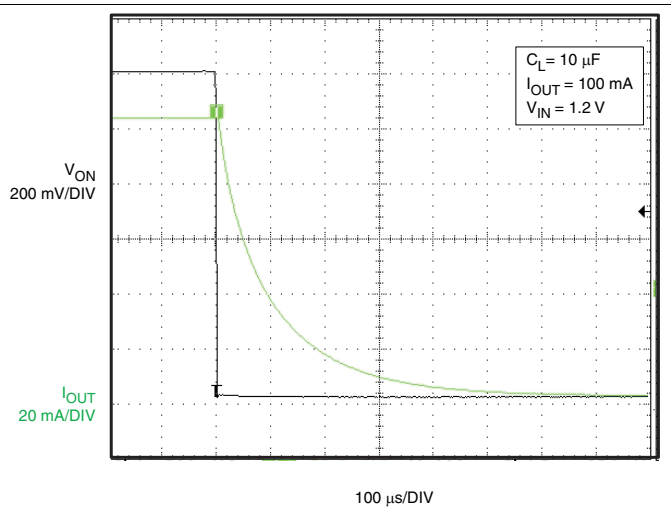

Figure 20. t_{OFF} Response (TPS22903)

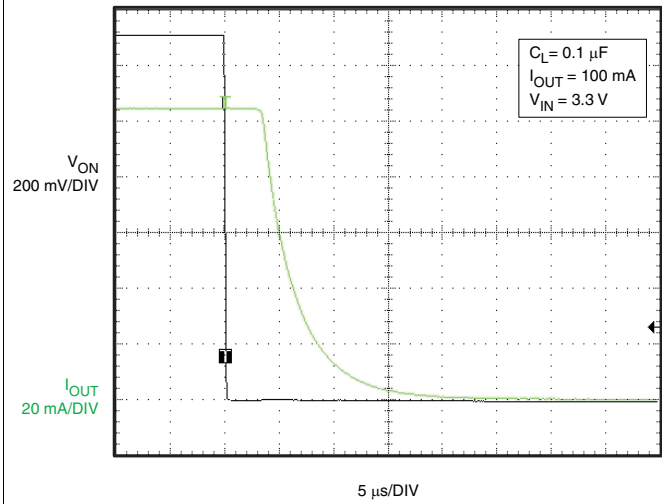

Figure 21. t_{OFF} Response (TPS22903)

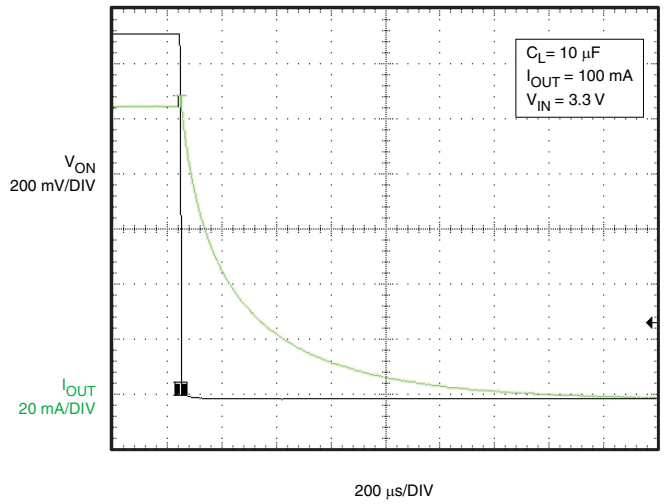

Figure 22. t_{OFF} Response (TPS22903)

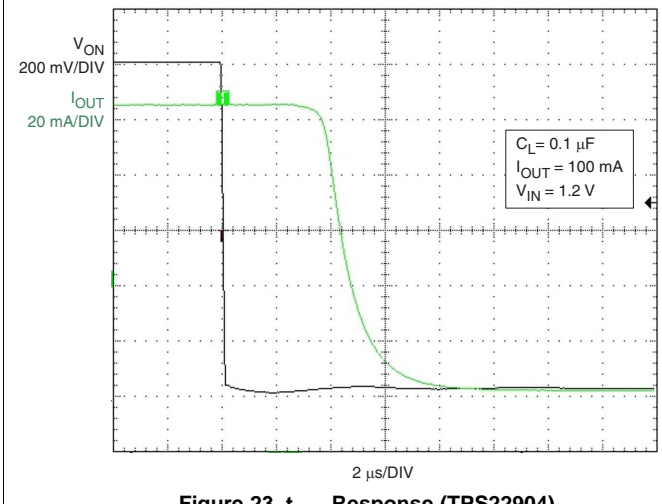

Figure 23. t_{OFF} Response (TPS22904)

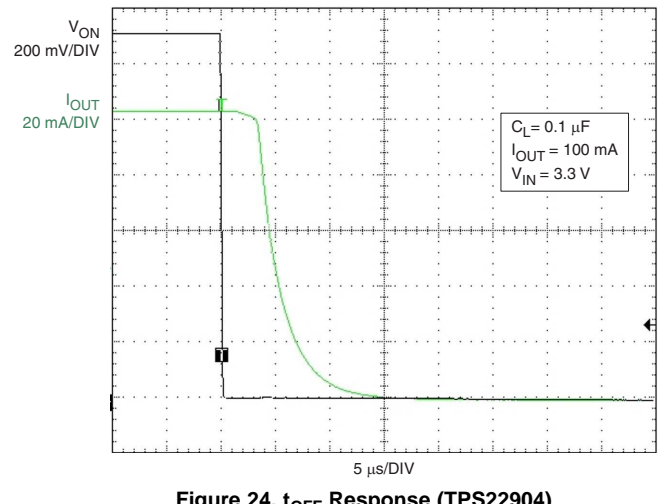
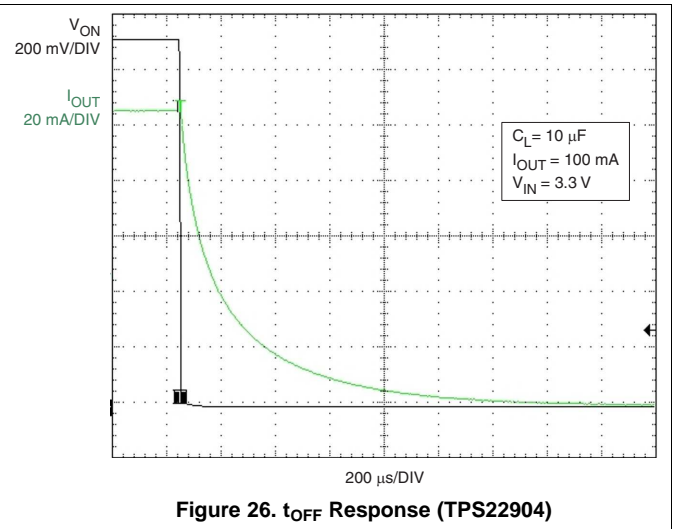
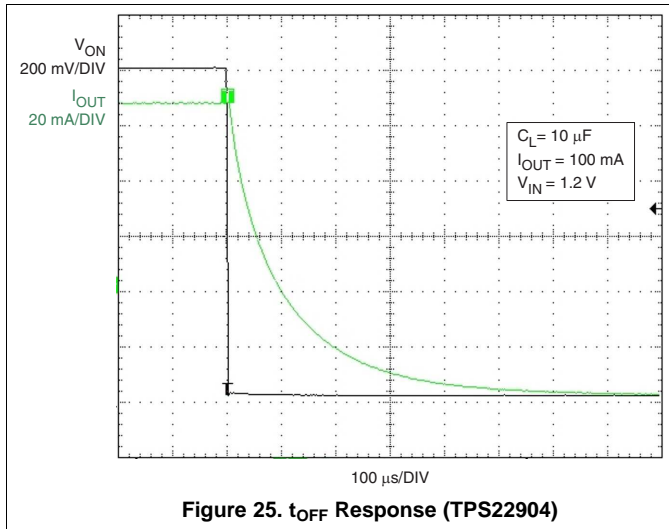
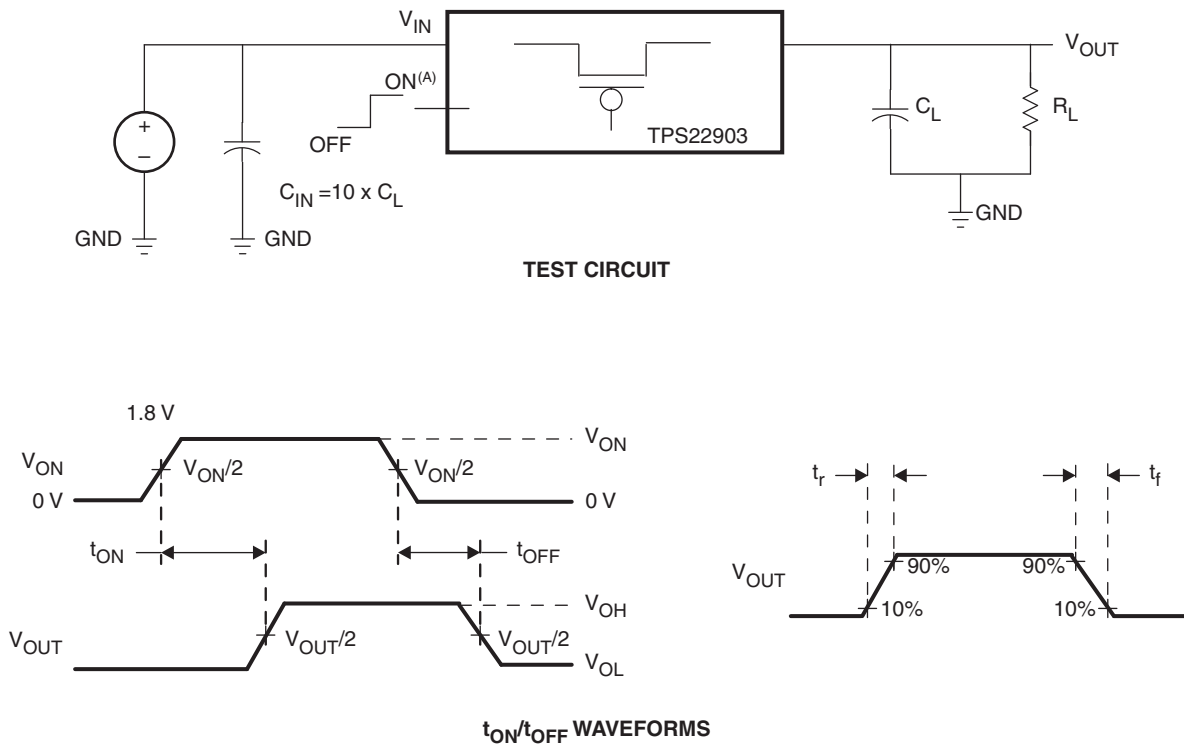

Figure 24. t_{OFF} Response (TPS22904)

Typical Characteristics (continued)



8 Parameter Measurement Information



A. t_{rise} and t_{fall} of the control signal is 100 ns.

Figure 27. Test Circuit and t_{ON}/t_{OFF} Waveforms

9 Detailed Description

9.1 Overview

The TPS22903 and TPS22904 are single-channel load switches with controlled turnon.

The devices contain a P-channel MOSFET that can operate over an input voltage range of 1.1 V to 3.6 V. The switch is controlled by an on and off input (ON), which is capable of interfacing directly with low-voltage control signals. In TPS22904, a 85-Ω on-chip load resistor is added for output quick discharge when switch is turned off. Both devices are available in a space-saving 4-terminal WCSP 0.4-mm pitch (YFP).

9.2 Functional Block Diagram

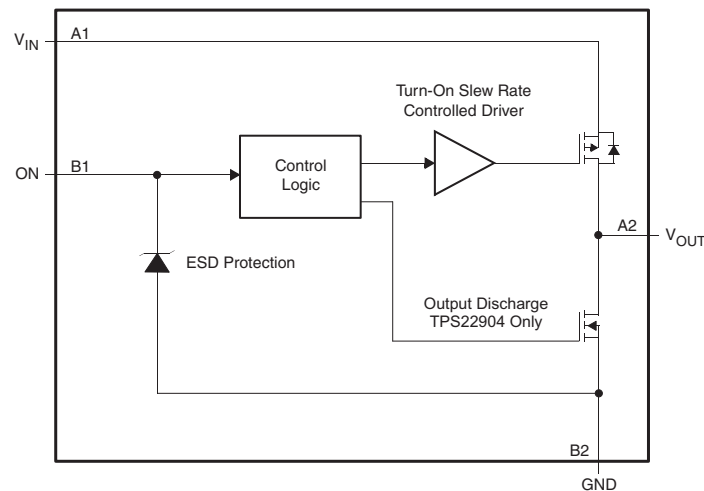

9.3 Feature Description

9.3.1 ON/OFF Control

The ON pin controls the state of the switch. Activating ON continuously holds the switch in the ON-state as there is no fault. ON is active-high and has a low threshold, making it capable of interfacing with low voltage signals. The ON pin is compatible with standard GPIO logic thresholds. It can be used with any microcontroller with 1.2-V, 1.8-V, 2.5-V, or 3.3-V GPIOs.

9.4 Device Functional Modes

Table 1 lists the VOUT pin connections as determined by the ON pin.

Table 1. Functional Table

ON (CONTROL INPUT)	V _{IN} TO V _{OUT}	V _{OUT} TO GND (TPS22904 ONLY)
L	OFF	ON
H	ON	OFF

10 Application and Implementation

NOTE

Information in the following applications sections is not part of the TI component specification, and TI does not warrant its accuracy or completeness. TI's customers are responsible for determining suitability of components for their purposes. Customers should validate and test their design implementation to confirm system functionality.

10.1 Application Information

10.1.1 Input Capacitor (Optional)

To limit the voltage drop on the input supply caused by transient in-rush currents when the switch turns on into a discharged load capacitor or short-circuit, a capacitor needs to be placed between V_{IN} and GND. A 1- μ F ceramic capacitor, C_{IN} , placed close to the pins, is usually sufficient. Higher values of C_{IN} can be used to further reduce the voltage drop during high-current application. When switching heavy loads, TI recommends to have an input capacitor about 10 times higher than the output capacitor to avoid excessive voltage drop.

10.1.2 Output Capacitor (Optional)

Due to the integral body diode in the PMOS switch, a C_{IN} greater than C_L is highly recommended. A C_L greater than C_{IN} can cause V_{OUT} to exceed V_{IN} when the system supply is removed. This could result in current flow through the body diode from V_{OUT} to V_{IN} .

10.2 Typical Application

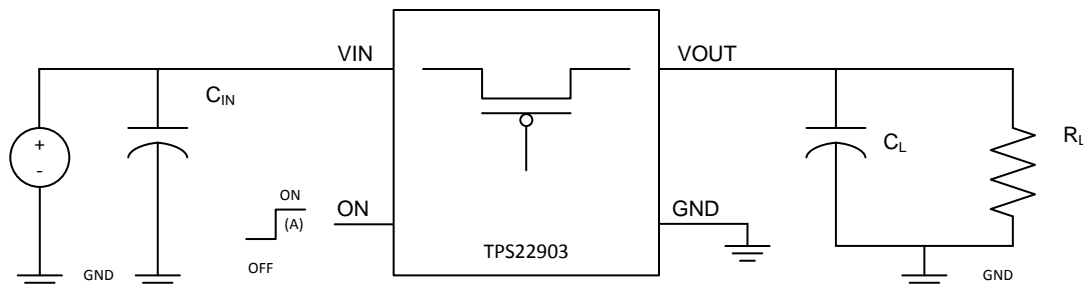

Figure 28. Typical Application Schematic

10.2.1 Design Requirements

Table 2 lists the design parameters for the TPS22903 device.

Table 2. Design Parameters

DESIGN PARAMETER	EXAMPLE VALUE
V_{IN}	1.8 V
Load Current	0.3 A
Ambient Temperature	25°C

10.2.2 Detailed Design Procedure

10.2.2.1 V_{IN} to V_{OUT} Voltage Drop

The voltage drop from V_{IN} to V_{OUT} is determined by the ON-resistance of the device and the load current. R_{ON} can be found in [Electrical Characteristics](#) and is dependent on temperature. When the value of R_{ON} is found, [Equation 1](#) can be used to calculate the voltage drop across the device:

$$\Delta V = I_{LOAD} \times R_{ON}$$

where

- ΔV = Voltage drop across the device
 - I_{LOAD} = Load current
 - R_{ON} = ON-resistance of the device
- (1)

At $V_{IN} = 1.8\text{ V}$, the TPS22903/4 has an R_{ON} value of $90\text{ m}\Omega$. Using this value and the defined load current, the above equation can be evaluated:

$$\Delta V = 0.30\text{ A} \times 90\text{ m}\Omega$$

where

- $\Delta V = 27\text{ mV}$
- (2)

Therefore, the voltage drop across the device will be 27 mV .

10.2.3 Application Curve

Figure 29 shows the expected voltage drop across the device for different load currents and input voltages.

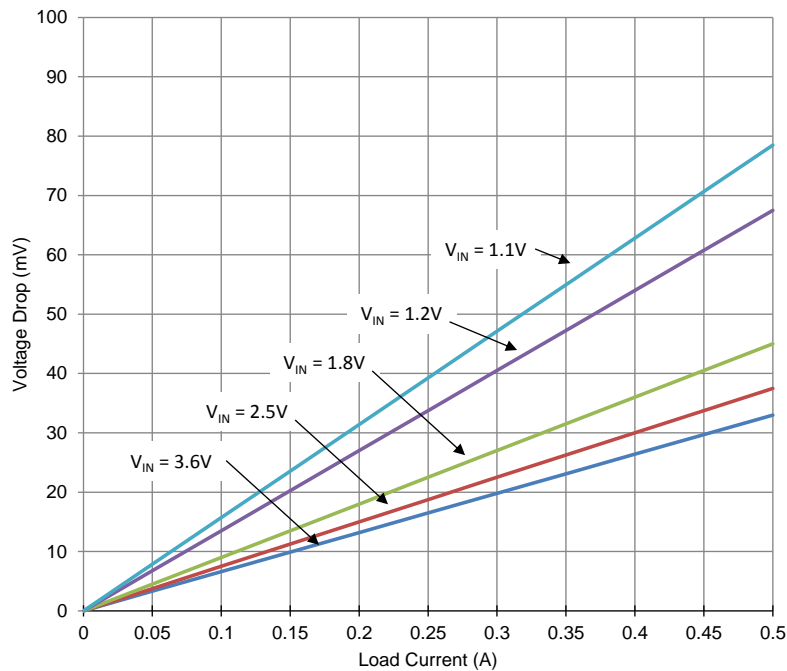

Figure 29. Voltage Drop vs Load Current

11 Power Supply Recommendations

The device is designed to operate with a V_{IN} range of 1.1 V to 3.6 V. This supply must be well regulated and placed as close to the device terminals as possible. It must also be able to withstand all transient and load currents, using a recommended input capacitance of 1 μF if necessary. If the supply is more than a few inches from the device terminals, additional bulk capacitance may be required in addition to the ceramic bypass capacitors. If additional bulk capacitance is required, an electrolytic, tantalum, or ceramic capacitor of 10 μF may be sufficient.

12 Layout

12.1 Layout Guidelines

For best performance, all traces should be as short as possible. To be most effective, the input and output capacitors should be placed close to the device to minimize the effects that parasitic trace inductances may have on normal and short-circuit operation. Using wide traces for V_{IN} , V_{OUT} , and GND helps minimize the parasitic electrical effects along with minimizing the case-to-ambient thermal impedance.

12.2 Layout Example

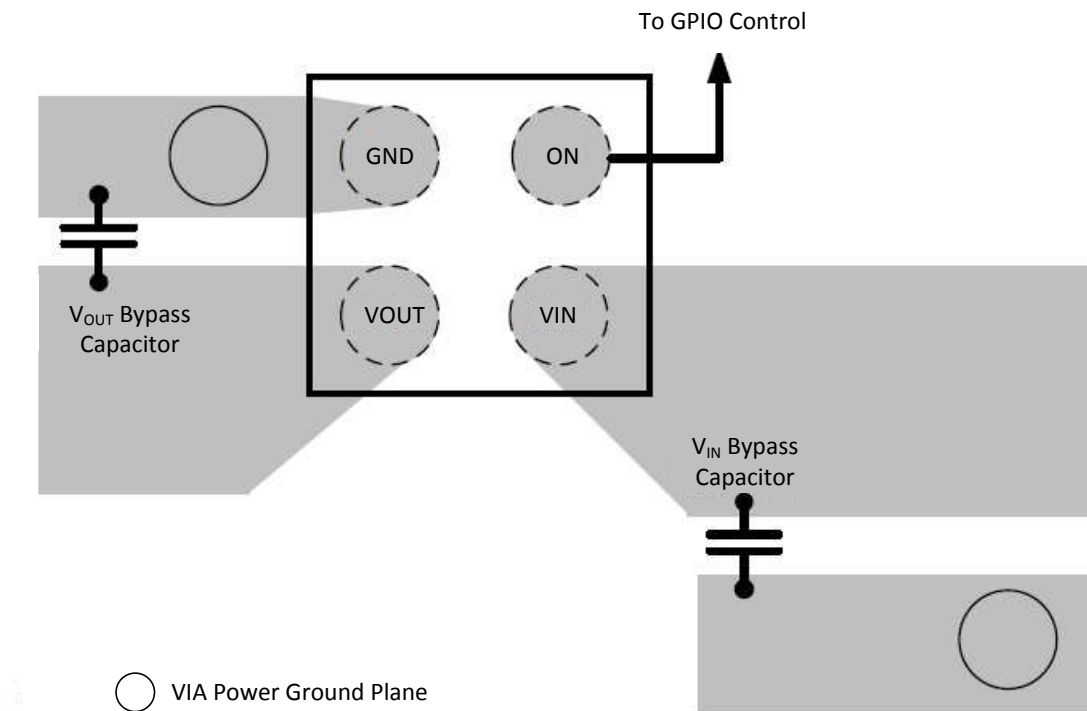

Figure 30. Layout Example Recommendation

13 Device and Documentation Support

13.1 Related Links

The table below lists quick access links. Categories include technical documents, support and community resources, tools and software, and quick access to sample or buy.

Table 3. Related Links

PARTS	PRODUCT FOLDER	SAMPLE & BUY	TECHNICAL DOCUMENTS	TOOLS & SOFTWARE	SUPPORT & COMMUNITY
TPS22903	Click here	Click here	Click here	Click here	Click here
TPS22904	Click here	Click here	Click here	Click here	Click here

13.2 Community Resources

The following links connect to TI community resources. Linked contents are provided "AS IS" by the respective contributors. They do not constitute TI specifications and do not necessarily reflect TI's views; see TI's [Terms of Use](#).

TI E2E™ Online Community *TI's Engineer-to-Engineer (E2E) Community*. Created to foster collaboration among engineers. At e2e.ti.com, you can ask questions, share knowledge, explore ideas and help solve problems with fellow engineers.

Design Support *TI's Design Support* Quickly find helpful E2E forums along with design support tools and contact information for technical support.

13.3 Trademarks

E2E is a trademark of Texas Instruments.
All other trademarks are the property of their respective owners.

13.4 Electrostatic Discharge Caution



These devices have limited built-in ESD protection. The leads should be shorted together or the device placed in conductive foam during storage or handling to prevent electrostatic damage to the MOS gates.

13.5 Glossary

SLYZ022 — *TI Glossary*.

This glossary lists and explains terms, acronyms, and definitions.

14 Mechanical, Packaging, and Orderable Information

The following pages include mechanical, packaging, and orderable information. This information is the most current data available for the designated devices. This data is subject to change without notice and revision of this document. For browser-based versions of this data sheet, refer to the left-hand navigation.

PACKAGING INFORMATION

Orderable Device	Status (1)	Package Type	Package Drawing	Pins	Package Qty	Eco Plan (2)	Lead finish/ Ball material (6)	MSL Peak Temp (3)	Op Temp (°C)	Device Marking (4/5)	Samples
TPS22904YFPR	ACTIVE	DSBGA	YFP	4	3000	RoHS & Green	SNAGCU	Level-1-260C-UNLIM	-40 to 85	4R (2, N)	Samples
TPS22904YFPT	ACTIVE	DSBGA	YFP	4	250	RoHS & Green	SNAGCU	Level-1-260C-UNLIM	-40 to 85	4R (2, N)	Samples

(1) The marketing status values are defined as follows:

ACTIVE: Product device recommended for new designs.

LIFEBUY: TI has announced that the device will be discontinued, and a lifetime-buy period is in effect.

NRND: Not recommended for new designs. Device is in production to support existing customers, but TI does not recommend using this part in a new design.

PREVIEW: Device has been announced but is not in production. Samples may or may not be available.

OBSOLETE: TI has discontinued the production of the device.

(2) **RoHS:** TI defines "RoHS" to mean semiconductor products that are compliant with the current EU RoHS requirements for all 10 RoHS substances, including the requirement that RoHS substance do not exceed 0.1% by weight in homogeneous materials. Where designed to be soldered at high temperatures, "RoHS" products are suitable for use in specified lead-free processes. TI may reference these types of products as "Pb-Free".

RoHS Exempt: TI defines "RoHS Exempt" to mean products that contain lead but are compliant with EU RoHS pursuant to a specific EU RoHS exemption.

Green: TI defines "Green" to mean the content of Chlorine (Cl) and Bromine (Br) based flame retardants meet JS709B low halogen requirements of <=1000ppm threshold. Antimony trioxide based flame retardants must also meet the <=1000ppm threshold requirement.

(3) MSL, Peak Temp. - The Moisture Sensitivity Level rating according to the JEDEC industry standard classifications, and peak solder temperature.

(4) There may be additional marking, which relates to the logo, the lot trace code information, or the environmental category on the device.

(5) Multiple Device Markings will be inside parentheses. Only one Device Marking contained in parentheses and separated by a "~" will appear on a device. If a line is indented then it is a continuation of the previous line and the two combined represent the entire Device Marking for that device.

(6) Lead finish/Ball material - Orderable Devices may have multiple material finish options. Finish options are separated by a vertical ruled line. Lead finish/Ball material values may wrap to two lines if the finish value exceeds the maximum column width.

Important Information and Disclaimer:The information provided on this page represents TI's knowledge and belief as of the date that it is provided. TI bases its knowledge and belief on information provided by third parties, and makes no representation or warranty as to the accuracy of such information. Efforts are underway to better integrate information from third parties. TI has taken and continues to take reasonable steps to provide representative and accurate information but may not have conducted destructive testing or chemical analysis on incoming materials and chemicals. TI and TI suppliers consider certain information to be proprietary, and thus CAS numbers and other limited information may not be available for release.

In no event shall TI's liability arising out of such information exceed the total purchase price of the TI part(s) at issue in this document sold by TI to Customer on an annual basis.

TAPE AND REEL INFORMATION

QUADRANT ASSIGNMENTS FOR PIN 1 ORIENTATION IN TAPE



*All dimensions are nominal

Device	Package Type	Package Drawing	Pins	SPQ	Reel Diameter (mm)	Reel Width W1 (mm)	A0 (mm)	B0 (mm)	K0 (mm)	P1 (mm)	W (mm)	Pin1 Quadrant
TPS22904YFPR	DSBGA	YFP	4	3000	178.0	9.2	0.89	0.89	0.58	4.0	8.0	Q1
TPS22904YFPT	DSBGA	YFP	4	250	178.0	9.2	0.89	0.89	0.58	4.0	8.0	Q1

TAPE AND REEL BOX DIMENSIONS

*All dimensions are nominal

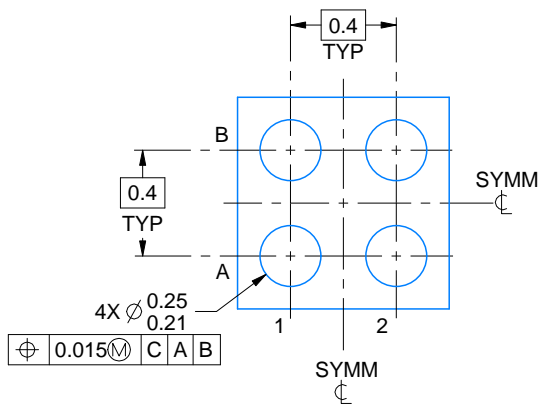
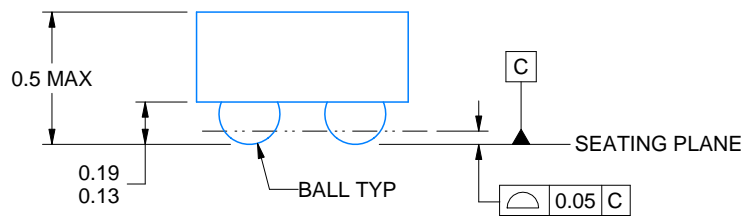
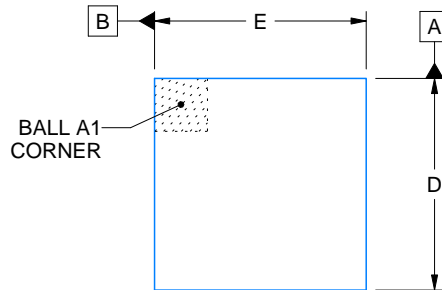
Device	Package Type	Package Drawing	Pins	SPQ	Length (mm)	Width (mm)	Height (mm)
TPS22904YFPR	DSBGA	YFP	4	3000	220.0	220.0	35.0
TPS22904YFPT	DSBGA	YFP	4	250	220.0	220.0	35.0



D: Max = 0.79 mm, Min = 0.73 mm
 E: Max = 0.79 mm, Min = 0.73 mm

4223507/A 01/2017

NOTES:

1. All linear dimensions are in millimeters. Any dimensions in parenthesis are for reference only. Dimensioning and tolerancing per ASME Y14.5M.
2. This drawing is subject to change without notice.

EXAMPLE BOARD LAYOUT

YFP0004

DSBGA - 0.5 mm max height

DIE SIZE BALL GRID ARRAY

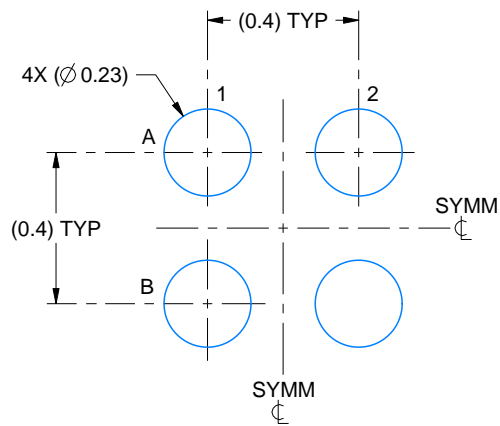

LAND PATTERN EXAMPLE
EXPOSED METAL SHOWN
SCALE:50X

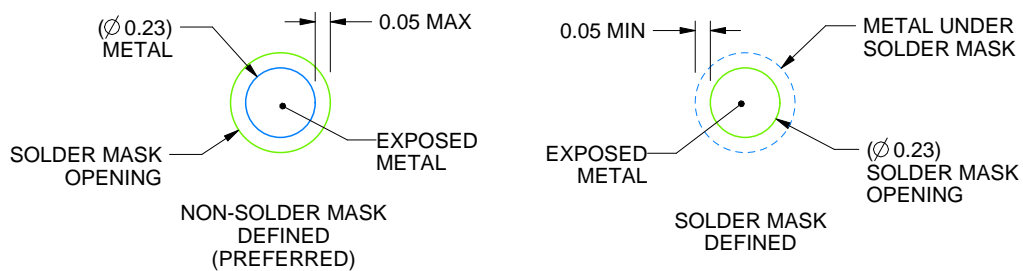

SOLDER MASK DETAILS
NOT TO SCALE

4223507/A 01/2017

NOTES: (continued)

- Final dimensions may vary due to manufacturing tolerance considerations and also routing constraints. For more information, see Texas Instruments literature number SNVA009 (www.ti.com/lit/snva009).

EXAMPLE STENCIL DESIGN

YFP0004

DSBGA - 0.5 mm max height

DIE SIZE BALL GRID ARRAY

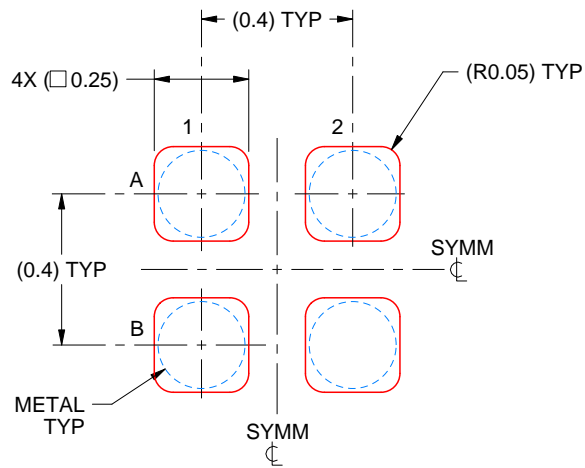

SOLDER PASTE EXAMPLE
BASED ON 0.1 mm THICK STENCIL
SCALE:50X

4223507/A 01/2017

NOTES: (continued)

4. Laser cutting apertures with trapezoidal walls and rounded corners may offer better paste release.

IMPORTANT NOTICE AND DISCLAIMER

TI PROVIDES TECHNICAL AND RELIABILITY DATA (INCLUDING DATA SHEETS), DESIGN RESOURCES (INCLUDING REFERENCE DESIGNS), APPLICATION OR OTHER DESIGN ADVICE, WEB TOOLS, SAFETY INFORMATION, AND OTHER RESOURCES "AS IS" AND WITH ALL FAULTS, AND DISCLAIMS ALL WARRANTIES, EXPRESS AND IMPLIED, INCLUDING WITHOUT LIMITATION ANY IMPLIED WARRANTIES OF MERCHANTABILITY, FITNESS FOR A PARTICULAR PURPOSE OR NON-INFRINGEMENT OF THIRD PARTY INTELLECTUAL PROPERTY RIGHTS.

These resources are intended for skilled developers designing with TI products. You are solely responsible for (1) selecting the appropriate TI products for your application, (2) designing, validating and testing your application, and (3) ensuring your application meets applicable standards, and any other safety, security, regulatory or other requirements.

These resources are subject to change without notice. TI grants you permission to use these resources only for development of an application that uses the TI products described in the resource. Other reproduction and display of these resources is prohibited. No license is granted to any other TI intellectual property right or to any third party intellectual property right. TI disclaims responsibility for, and you will fully indemnify TI and its representatives against, any claims, damages, costs, losses, and liabilities arising out of your use of these resources.

TI's products are provided subject to [TI's Terms of Sale](#) or other applicable terms available either on [ti.com](https://www.ti.com) or provided in conjunction with such TI products. TI's provision of these resources does not expand or otherwise alter TI's applicable warranties or warranty disclaimers for TI products.

TI objects to and rejects any additional or different terms you may have proposed.

Mailing Address: Texas Instruments, Post Office Box 655303, Dallas, Texas 75265
Copyright © 2023, Texas Instruments Incorporated