

## 4.5-V to 18-V Input, High Current, Synchronous Step Down Three DC-DC Converter with Integrated FET and 2 Power Switches

Check for Samples: [TPS65288](#)

### FEATURES

- **Wide Input Supply Voltage Range:**  
4.5 V - 18 V
- **0.8-V, 1% Accuracy Reference**
- **Continuous Loading:**  
3 A (Buck1), 2 A (Buck2 and 3)
- **Maximum Current:**  
3.5 A (Buck 1), 2.5 A (Buck2 and 3)
- **300-kHz – 2.2-MHz Switching Frequency Set By External Resistor**
- **External Enable Pins With Built-In Current Source for Easy Sequencing**
- **External Soft Start Pins**
- **Adjustable Cycle-by-Cycle Current Limit Set by External Resistor**
- **Current-Mode Control With Simple Compensation Circuit**
- **Pulse Skipping Mode to Achieve High Light Load Efficiency, Allowing for an Output Ripple Better than 2%**
- **Forced PWM Mode**
- **Support Pre-Biased Outputs**
- **Power Good Supervisor and Reset Generator**
- **2 USB Power Switches current limiting at typical 1.2A (0.8/1.0/1.4/1.6/1.8/2.0/2.2A Available with Manufacture Trim Options)**
- **Small, Thermally Efficient 40-Pin 6-mm x 6-mm RHA (QFN) package**
- **-40°C to 125°C Junction Temperature Range**

### DESCRIPTION/ORDERING INFORMATION

TPS65288 is a power management IC with three step-down buck converters. Both high-side and low-side MOSFETs are integrated to provide fully synchronous conversion with higher efficiency. The converters are designed to simplify its application while giving the designer the option to optimize their usage according to the target application.

The converters can operate in 5-, 9-, 12- or 15-V systems. The output voltage can be set externally using a resistor divider to any value between 0.8 V and the input supply minus the resistive drops on the converter path. Each converter features enable pin that allows a delayed start-up for sequencing purposes, soft start pin that allows adjustable soft-start time by choosing the soft-start capacitor, and a current limit (RLIM) pin that enables designer to adjust current limit by selecting an external resistor and optimize the choice of inductor. All converters operate in 'hiccup mode': Once an over-current lasting more than 10 ms is sensed in any of the converters, they will shut down for 10 ms and then the start-up sequencing will be tried again. If the overload has been removed, the converter will ramp up and operate normally. If this is not the case the converter will see another over-current event and shuts down again repeating the cycle (hiccup) until the failure is cleared. If an overload condition lasts for less than 10 ms, only the relevant converter affected will shut-down and re-start and no global hiccup mode will occur.

The switching frequency of the converters is set by an external resistor connected to ROSC pin. The switching regulators are designed to operate from 300 kHz to 2.2 MHz. The converters operate with 180° phase between them to minimize the input filter requirements. All converters have peak current mode control which simplifies external frequency compensation.

The device has a built-in slope compensation ramp. The slope compensation can prevent sub harmonic oscillations in peak current mode control. A traditional type II compensation network can stabilize the system and achieve fast transient response. Moreover, an optional capacitor in parallel with the upper resistor of the feedback divider provides one more zero and makes the crossover frequency over 100 kHz.

All converters feature an automatic low power pulse skipping mode (PSM) which improves efficiency during light loads and standby operation, while guaranteeing a very low output ripple, allowing for a value of less than 2% at low output voltages.



Please be aware that an important notice concerning availability, standard warranty, and use in critical applications of Texas Instruments semiconductor products and disclaimers thereto appears at the end of this data sheet.

The device incorporates an overvoltage transient protection circuit to minimize voltage overshoot. The OVP feature minimizes the output overshoot by implementing a circuit to compare the FB pin voltage to OVP threshold which is 106% of the internal voltage reference. If the FB pin voltage is greater than the OVTP threshold, the high side MOSFET is disabled preventing current from flowing to the output and minimizing output overshoot. When the FB voltage drops lower than the OVP lower threshold which is 104%, the high side MOSFET is allowed to turn on the next clock cycle.

TPS65288 features a supervisor circuit which monitors each buck's output and the PGOOD pin is asserted once sequencing is done. The PGOOD pin is an open drain output. The PGOOD pin is pulled low when any buck converter is pulled below 85% of the nominal output voltage. The PGOOD is pulled up when all converter outputs are more than 90% of its nominal output voltage. The default reset time is 100 ms. The polarity of the PGOOD is active high.

The 2 USB switches provide up to 1.2A of current as required by downstream USB devices. When the output load exceeds the current-limit threshold or a short is present, the PMU limits the output current to a safe level by switching into a constant-current mode and pulling the over current logic output low. When continuous heavy overloads or short circuits increase the power dissipation in the switch, causing the junction temperature to rise, a thermal warning protection circuit shuts off the USB switch and allows the buck converters to carry on operating.

The device implements an internal thermal shutdown to protect itself if the junction temperature exceeds 160°C. The thermal shutdown forces the device to stop operating when the junction temperature exceeds thermal trip threshold. Once the die temperature decreases below 140°C, the device reinitiates the power up sequence. The thermal shutdown hysteresis is 20°C.

#### ORDERING INFORMATION<sup>(1)</sup>

| T <sub>A</sub> | PACKAGE <sup>(2)</sup> |              | PART NUMBER  | TOP-SIDE MARKING |
|----------------|------------------------|--------------|--------------|------------------|
| -40°C to 125°C | 40-Pin (QFN) - RHA     | Reel of 2500 | TPS65288RHAR | TPS65288         |

(1) For the most current packaging and ordering information, see the Package Option Addendum at the end of this document, or see the TI web site at [www.ti.com](http://www.ti.com).

(2) Package drawings, thermal data, and symbolization are available at [www.ti.com/packaging](http://www.ti.com/packaging).



This integrated circuit can be damaged by ESD. Texas Instruments recommends that all integrated circuits be handled with appropriate precautions. Failure to observe proper handling and installation procedures can cause damage.

ESD damage can range from subtle performance degradation to complete device failure. Precision integrated circuits may be more susceptible to damage because very small parametric changes could cause the device not to meet its published specifications.

**FUNCTIONAL BLOCK DIAGRAM**

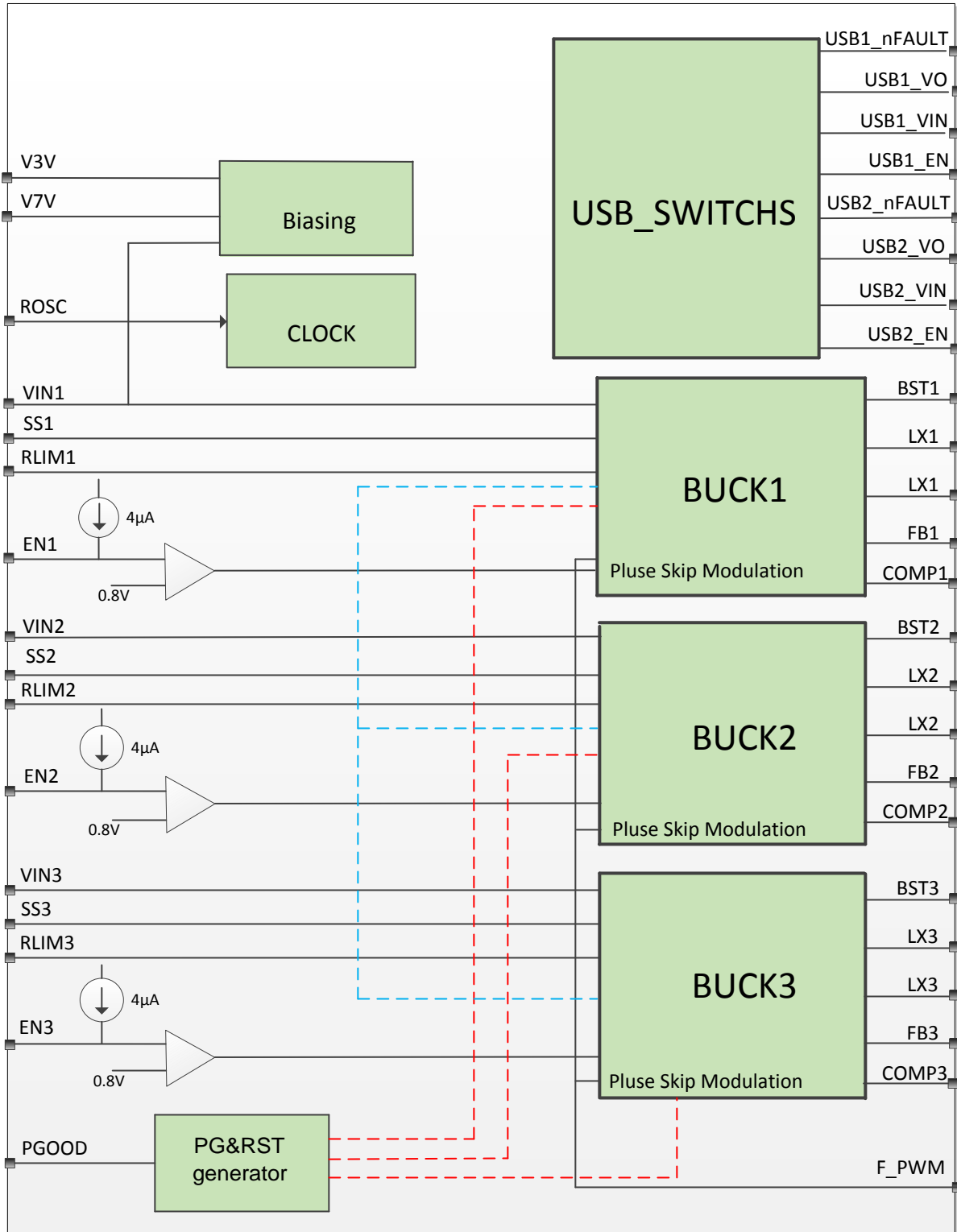

TYPICAL APPLICATION

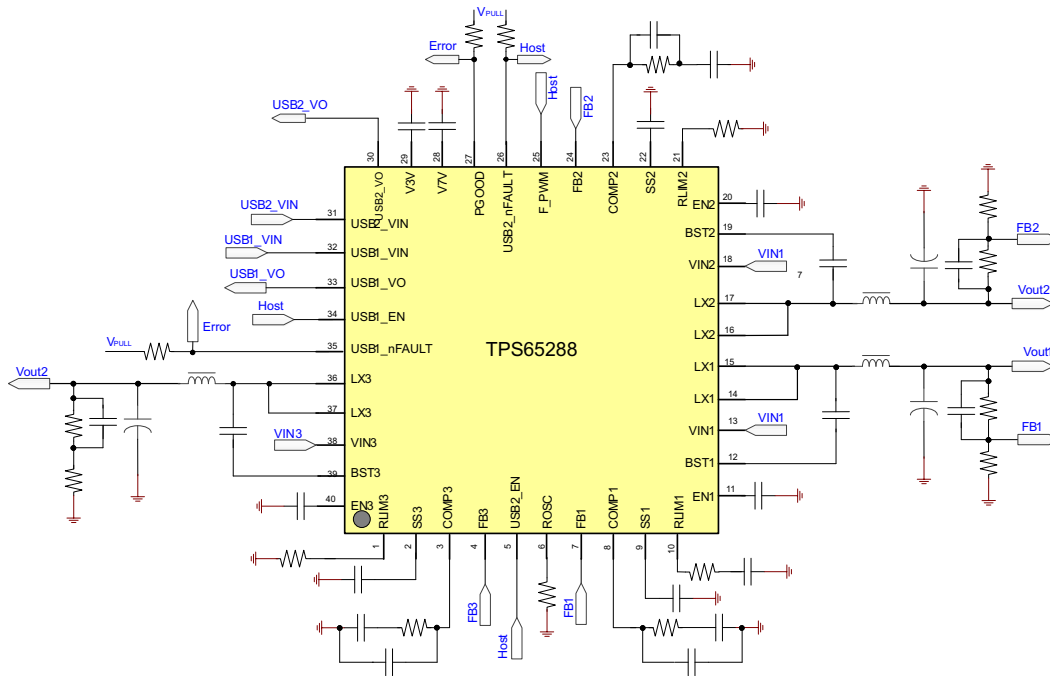

PIN OUT

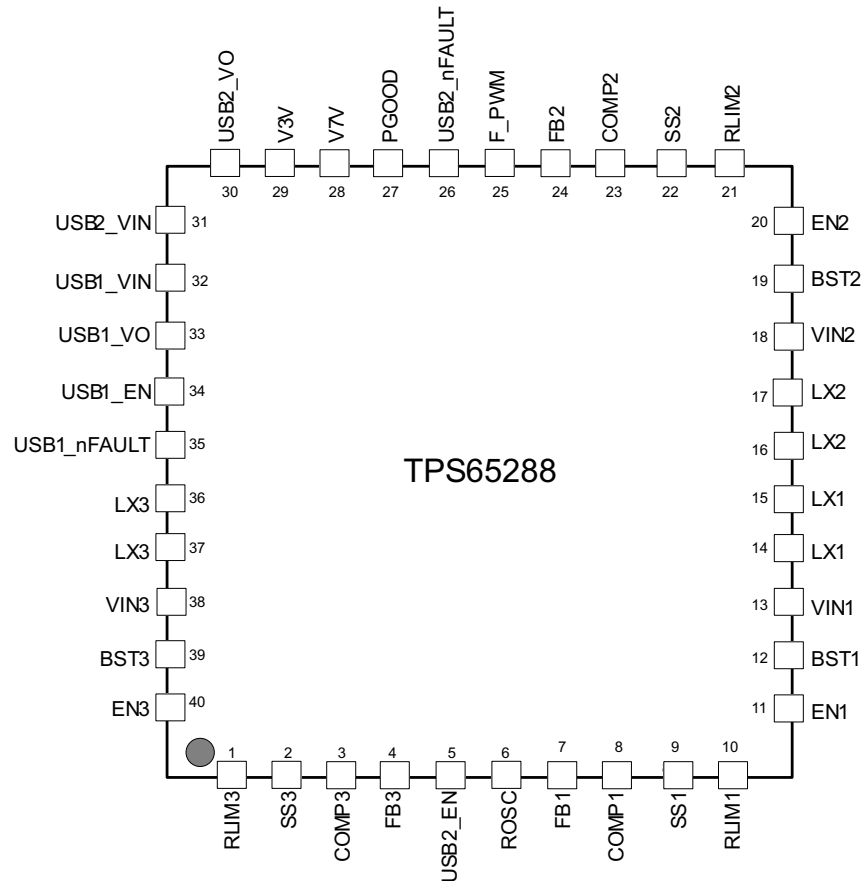

**TERMINAL FUNCTIONS**

| NAME        | NO.    | I/O | DESCRIPTION  |
|-------------|--------|-----|--|
| RLIM3       | 1      | I   | Current limit setting for Buck3. Fit a resistor from this pin to ground to set the peak current limit on the output inductor.                              |
| SS3         | 2      | I   | Soft start pin for Buck3. Fit a small ceramic capacitor to this pin to set the converter soft start time.  |
| COMP3       | 3      | O   | Compensation for Buck3. Fit a series RC circuit to this pin to complete the compensation circuit of this converter.  |
| FB3         | 4      | I   | Feedback pin for Buck3. Connect a divider set to 0.8 V from the output of the converter to ground.   |
| USB2_EN     | 5      | I   | Enable input, high turns on the switch   |
| ROSC        | 6      | I   | Oscillator set. This resistor sets the frequency of internal autonomous clock.   |
| FB1         | 7      | I   | Feedback pin for Buck1. Connect a divider set to 0.8 V from the output of the converter to ground.   |
| COMP1       | 8      | O   | Compensation pin for Buck1. Fit a series RC circuit to this pin to complete the compensation circuit of this converter.                                    |
| SS1         | 9      | I   | Soft-start pin for Buck1. Fit a small ceramic capacitor to this pin to set the converter soft-start time.  |
| RLIM1       | 10     | I   | Current limit setting pin for Buck1. Fit a resistor from this pin to ground to set the peak current limit on the output inductor.                          |
| EN1         | 11     | I   | Enable pin for Buck1. A high signal on this pin enables the regulator Buck. For a delayed start-up add a small ceramic capacitor from this pin to ground.  |
| BST1        | 12     |     | Bootstrap capacitor for Buck1. Fit a 47-nF ceramic capacitor from this pin to the switching node.  |
| VIN1        | 13     | I   | Input supply for Buck1. Fit a 10- $\mu$ F ceramic capacitor close to this pin.   |
| LX1         | 14, 15 | O   | Switching node for Buck1   |
| LX2         | 16, 17 | O   | Switching node for Buck2   |
| VIN2        | 18     | I   | Input supply for Buck2. Fit a 10- $\mu$ F ceramic capacitor close to this pin.   |
| BST2        | 19     |     | Bootstrap capacitor for Buck2. Fit a 47-nF ceramic capacitor from this pin to the switching node.  |
| EN2         | 20     | I   | Enable pin for Buck2. A high signal on this pin enables the regulator. For a delayed start-up add a small ceramic capacitor from this pin to ground.       |
| RLIM2       | 21     | I   | Current limit setting pin for Buck2. Fit a resistor from this pin to ground to set the peak current limit on the output inductor.                          |
| SS2         | 22     | I   | Soft-start pin for Buck2. Fit a small ceramic capacitor to this pin to set the converter soft-start time.  |
| COMP2       | 23     | O   | Compensation pin for Buck2. Fit a series RC circuit to this pin to complete the compensation circuit of this converter.                                    |
| FB2         | 24     | I   | Feedback input for Buck2. Connect a divider set to 0.8 V from the output of the converter to ground.   |
| F_PWM       | 25     | I   | Forces PWM operation in all converters when set high. If low converters will operate in automatic PFM/PWM mode.  |
| USB2_nFAULT | 26     | O   | USB2 fault flag output, open drain, active low. Asserted when over current or over temperature condition is detected in the switch.                        |
| PGOOD       | 27     | O   | Power good. Open drain output asserted low after all converters and sequenced and within regulation. Polarity is factory selectable (active high default). |
| V7V         | 28     | O   | Internal supply. Connect a 4.7- $\mu$ F to 10- $\mu$ F ceramic capacitor from this pin to ground.  |
| V3V         | 29     | O   | Internal supply. Connect a 3.3- $\mu$ F to 10- $\mu$ F ceramic capacitor from this pin to ground.  |
| USB2_VO     | 30     | O   | USB switch output  |
| USB2_VIN    | 31     | I   | USB switch input supply  |
| USB1_VIN    | 32     | I   | USB switch Input supply  |
| USB1_VO     | 33     | O   | USB switch output  |

**TERMINAL FUNCTIONS (continued)**

| NAME        | NO.    | I/O | DESCRIPTION  |
|-------------|--------|-----|--|
| USB1_EN     | 34     | I   | Enable input, high turns on the switch   |
| USB1_nFAULT | 35     | O   | USB1 fault flag output, open drain, active low. Asserted when overcurrent or overtemperature condition is detected in the switch.                    |
| LX3         | 36, 37 | O   | Switching node for Buck3   |
| VIN3        | 38     | I   | Input supply for Buck3. Fit a 10- $\mu$ F ceramic capacitor close to this pin.   |
| BST3        | 39     |     | Bootstrap capacitor for Buck3. Fit a 47-nF ceramic capacitor from this pin to the switching node.  |
| EN3         | 40     | I   | Enable pin for Buck3. A high signal on this pin enables the converter. For a delayed start-up add a small ceramic capacitor from this pin to ground. |
| PowerPAD    |        |     | PowerPAD. Connect to system ground for electrical and thermal connection.  |

**ABSOLUTE MAXIMUM RATINGS <sup>(1)</sup>**

over operating free-air temperature range (unless otherwise noted, all voltages are with respect to GND)

|                  |  |             |    |
|------------------|--|-------------|----|
|                  | Voltage range at VIN1, VIN2, VIN3, LX1, LX2, LX3   | -0.3 to 20  | V  |
|                  | Voltage range at LX1, LX2, LX3 (maximum withstand voltage transient < 10 ns)   | -3 to 20    | V  |
|                  | Voltage at BST1, BST2, BST3 referenced to LX pin   | -0.3 to 7   | V  |
|                  | Voltage at V7V, COMP1, COMP2, COMP3, USB1_VIN, USB1_VO, USB2_VIN, USB2_VO, USB1_EN, USB2_EN, USB1_nFAULT, USB2_nFAULT, PGOOD | -0.3 to 7   | V  |
|                  | Voltage at V3V, RLIM1, RLIM2, RLIM3, SS1, SS2, SS3, FB1, FB2, FB3, ROSC, EN1, EN2, EN3, F_PWM                                | -0.3 to 3.6 | V  |
| T <sub>J</sub>   | Operating junction temperature range   | -40 to 125  | °C |
| T <sub>STG</sub> | Storage temperature range  | -55 to 150  | °C |

- (1) Stresses beyond those listed under "absolute maximum ratings" may cause permanent damage to the device. These are stress ratings only, and functional operation of the device at these or any other conditions beyond those indicated under "recommended operating conditions" is not implied. Exposure to absolute-maximum-rated conditions for extended periods may affect device reliability.

**RECOMMENDED OPERATING CONDITIONS**

over operating free-air temperature range (unless otherwise noted)

|                                     | MIN | NOM | MAX | UNIT |
|-------------------------------------|-----|-----|-----|------|
| VIN Input operating voltage         | 4.5 |     | 18  | V    |
| T <sub>A</sub> Junction temperature | -40 |     | 85  | °C   |

**ELECTROSTATIC DISCHARGE (ESD) PROTECTION <sup>(1)</sup>**

|                           | MIN  | MAX | UNIT |
|---------------------------|------|-----|------|
| Human body model (HBM)    | 2000 |     | V    |
| Charge device model (CDM) | 500  |     | V    |

- (1) USB1\_Vo, USB2\_Vo pins' human body model (HBM) ESD protection rating 4KV, and machine model (MM) rating 200V.

**PACKAGE DISSIPATION RATINGS <sup>(1)</sup>**

| PACKAGE | $\theta_{JA}$ (°C/W) | T <sub>A</sub> = 25°C<br>POWER RATING (W) | T <sub>A</sub> = 55°C<br>POWER RATING (W) | T <sub>A</sub> = 85°C<br>POWER RATING (W) |
|---------|----------------------|---|---|---|
| RHA     | 30                   | 3.33                                      | 2.3                                       | 1.3                                       |

- (1) Based on JEDEC 51.5 HIGH K environment measured on a 76.2 x 114 x 0.6-mm board with the following layer arrangement:  
(a) Top layer: 2 Oz Cu, 6.7% coverage  
(b) Layer 2: 1 Oz Cu, 90% coverage  
(c) Layer 3: 1 Oz Cu, 90% coverage  
(d) Bottom layer: 2 Oz Cu, 20% coverage

## ELECTRICAL CHARACTERISTICS

$T_J = -40^{\circ}\text{C}$  to  $125^{\circ}\text{C}$ ,  $V_{IN} = 12\text{ V}$ ,  $f_{SW} = 500\text{ kHz}$  (unless otherwise noted)

| PARAMETER  |  | TEST CONDITIONS  | MIN            | TYP  | MAX            | UNIT             |
|--|--|--|----------------|------|----------------|------------------|
| <b>INPUT SUPPLY UVLO AND INTERNAL SUPPLY VOLTAGE</b>                                       |  |  |                |      |                |                  |
| $V_{IN}$   | Input voltage range                                  |  | 4.5            |      | 18             | V                |
| $I_{DDSDN}$  | Shutdown   | EN pin = low for all converters  |                | 180  |                | $\mu\text{A}$    |
| $I_{DDQ}$  | Quiescent (push-button pull-up current not included) | Converters enabled, no load<br>Buck1 = 1.2 V<br>Buck2 = 1.8 V<br>Buck3 = 3.3 V<br>$T_A = 25^{\circ}\text{C}$ , $F\_PWM = \text{Low}$ |                | 700  |                | $\mu\text{A}$    |
|  | Quiescent, forced PWM                                | Converters enabled, no load<br>$F\_PWM = \text{High}$  |                | 24   |                | mA               |
| UVLO   | $V_{IN}$ under voltage lockout                       | Rising $V_{IN}$  |                | 4.22 |                | V                |
|  |  | Falling $V_{IN}$   |                | 4.1  |                |                  |
| $UVLO_{DEGLITCH}$  |  | Both edges   |                | 110  |                | $\mu\text{s}$    |
| V3p3   | Internal biasing supply                              |  |                | 3.3  |                | V                |
| V7V  | Internal biasing supply                              |  |                | 6.25 |                | V                |
| $V7V_{UVLO}$   | UVLO for internal V7V rail                           | Rising V7V   |                | 3.8  |                | V                |
|  |  | Falling V7V  |                | 3.6  |                |                  |
| $V7V_{UVLO\_DEGLITCH}$   |  | Falling edge   |                | 120  |                | $\mu\text{s}$    |
| <b>BUCK CONVERTERS (ENABLE CIRCUIT, CURRENT LIMIT, SOFT-START AND SWITCHING FREQUENCY)</b> |  |  |                |      |                |                  |
| $V_{IH\_ENx}$  | Enable threshold high                                | V3p3 = 3.2 V - 3.4 V,<br>$V_{ENx}$ rising  | 0.66 x<br>V3p3 |      |                | V                |
| $V_{IL\_ENx}$  | Enable threshold low                                 | V3p3 = 3.2 V - 3.4 V,<br>$V_{ENx}$ falling   |                |      | 0.33 x<br>V3p3 | V                |
| $V_{IH\_F\_PWM}$   | Enable threshold high                                | V3p3 = 3.2 V - 3.4 V,<br>$V_{ENx}$ rising  | 0.66 x<br>V3p3 |      |                | V                |
| $V_{IL\_F\_PWM}$   | Enable threshold low                                 | V3p3 = 3.2 V - 3.4 V,<br>$V_{ENx}$ falling   |                |      | 0.33 x<br>V3p3 | V                |
| $I_{CH\_EN}$   | Pull up current enable pin                           |  |                | 4    |                | $\mu\text{A}$    |
| $t_D$  | Discharge time enable pins                           | Power-up   |                | 10   |                | ms               |
| $I_{SS}$   | Soft-start pin current source                        |  |                | 5    |                | $\mu\text{A}$    |
| $F_{SW\_BK}$   | Converter switching frequency range                  | Set externally with resistor   | 0.3            |      | 2.2            | MHz              |
| $f_{SW\_TOL}$  | Internal oscillator accuracy                         | $f_{SW} = 800\text{ kHz}$  | -10            |      | 10             | %                |
| <b>FEEDBACK, REGULATION, OUTPUT STAGE</b>  |  |  |                |      |                |                  |
| $V_{FB}$   | Feedback voltage                                     | $V_{IN} = 12\text{ V}$ , $T_A = 25^{\circ}\text{C}$  | -1%            | 0.8  | 1%             | V                |
|  |  | $V_{IN} = 4.5\text{ V}$ to $18\text{ V}$   | -2%            | 0.8  | 2%             |                  |
| $t_{ON\_MIN}$  | Minimum on time (current sense blanking)             |  |                |      | 135            | ns               |
| $I_{LIMIT1}$   | Peak inductor current limit range                    |  | 0.75           |      | 4              | A                |
| $I_{LIMIT2}$   | Peak inductor current limit range                    |  | 0.75           |      | 3              | A                |
| $I_{LIMIT3}$   | Peak inductor current limit range                    |  | 0.75           |      | 3              | A                |
| <b>MOSFET (BUCK 1)</b>   |  |  |                |      |                |                  |
| H.S. Switch  | On resistance of high side FET on CH1                | $25^{\circ}\text{C}$ , $BOOT = 6.5\text{ V}$   |                | 95   |                | $\text{m}\Omega$ |
| L.S. Switch  | On resistance of low side FET on CH1                 | $25^{\circ}\text{C}$ , $V_{IN} = 12\text{ V}$  |                | 50   |                | $\text{m}\Omega$ |



**ELECTRICAL CHARACTERISTICS (continued)**
 $T_J = -40^{\circ}\text{C}$  to  $125^{\circ}\text{C}$ ,  $V_{IN} = 12\text{ V}$ ,  $f_{SW} = 500\text{ kHz}$  (unless otherwise noted)

| PARAMETER                         |  | TEST CONDITIONS   | MIN                | TYP | MAX                | UNIT |
|-----------------------------------|--|---|--------------------|-----|--------------------|------|
| <b>MOSFET (BUCK 2)</b>            |  |   |                    |     |                    |      |
| H.S. Switch                       | On resistance of high side FET on CH2        | 25°C, BOOT = 6.5 V  |                    | 120 |                    | mΩ   |
| L.S. Switch                       | On resistance of low side FET on CH2         | 25°C, VIN = 12 V  |                    | 80  |                    | mΩ   |
| <b>MOSFET (BUCK 3)</b>            |  |   |                    |     |                    |      |
| H.S. Switch                       | On resistance of high side FET on CH3        | 25°C, BOOT = 6.5 V  |                    | 120 |                    | mΩ   |
| L.S. Switch                       | On resistance of low side FET on CH3         | 25°C, VIN = 12 V  |                    | 80  |                    | mΩ   |
| <b>ERROR AMPLIFIER</b>            |  |   |                    |     |                    |      |
| $g_M$                             | Error amplifier transconductance             | -2 μA < ICOMP < 2 μA  |                    | 130 |                    | μS   |
| $g_{m_{PS1}}$                     | COMP to ILX gm of Buck1 <sup>(1)</sup>       | $I_{LX} = 0.5\text{ A}$   |                    | 10  |                    | A/V  |
| $g_{m_{PS2}}$                     | COMP to ILX gm of Buck2 and 3 <sup>(1)</sup> | $I_{LX} = 0.5\text{ A}$   |                    | 8   |                    | A/V  |
| <b>POWER GOOD RESET GENERATOR</b> |  |   |                    |     |                    |      |
| $V_{UV\_BUCKX}$                   | Threshold voltage for buck under voltage     | Output falling  |                    | 85  |                    | %    |
|                                   |  | Output rising (PG will be asserted)   |                    | 90  |                    |      |
| $t_{UV\_deglitch}$                | Deglintch time (both edges)                  |   |                    | 11  |                    | ms   |
| $t_{ON\_HICCUP}$                  | Hiccup mode ON time                          | $V_{UV\_BUCKX}$ asserted  |                    | 14  |                    | ms   |
| $t_{OFF\_HICCUP}$                 | Hiccup mode OFF time                         | All converters disabled. Once $t_{OFF\_HICCUP}$ elapses, all converters will go through sequencing again. |                    | 20  |                    | ms   |
| $VOV\_BUCKX$                      | Threshold voltage for buck over voltage      | Output rising (high side FET will be forced off)  |                    | 106 |                    | %    |
|                                   |  | Output falling (high side FET will be allowed to switch )   |                    | 104 |                    |      |
| $t_{RP}$                          | minimum reset period                         | Measured after the later of Buck1 or Buck3 power-up successfully  |                    | 100 |                    | ms   |
| <b>USB SWITCHES</b>               |  |   |                    |     |                    |      |
| $V_{IN\_USB}$                     | USB input voltage range                      |   | 2.5                |     | 6                  | V    |
| $V_{IH\_USB\_EN}$                 | USB_EN high level input voltage              | $V_{3p3} = 3.2\text{-}3.4\text{ V}$ , $V_{USB\_EN}$ rising  | 0.66x<br>$V_{3p3}$ |     |                    | V    |
| $V_{IL\_USB\_EN}$                 | USB_EN low level input voltage               | $V_{3p3} = 3.2\text{-}3.4\text{ V}$ , $V_{USB\_EN}$ falling   |                    |     | 0.33x<br>$V_{3p3}$ | V    |
| $R_{DS\_USB}$                     | Static drain-source on-state resistance      | $USB\_VIN = 5\text{ V}$ and $I_{o\_USB} = 0.5\text{ A}$ , $T_J = 2\text{ }^{\circ}\text{C}$               |                    | 135 |                    | mΩ   |
| $I_{CS\_USB}$                     | USB current limit                            | Increasing $USB\_Vo$ current $di/dt < 1\text{ A/s}$   |                    | 1.2 |                    | A    |
| $V_{USBx\_nFAULT}$                | $USBx\_nFAULT$ output voltage low            | $I_{USB\_nFAULT} = 1\text{ mA}$   |                    | 150 |                    | mV   |
| $T_{USB\_TRIP}$                   | USB thermal trip point                       | Rising temperature  |                    | 130 |                    | °C   |
| $T_{USB\_HYST}$                   | USB thermal trip hysteresis                  | Hysteresis  |                    | 20  |                    | °C   |
| $T_{D\_on}$                       | Turn-on delay time                           | $USB\_IN = 5\text{ V}$ , $C_L = 10\text{ }\mu\text{F}$ , $R_L = 100\text{ }\Omega$                        |                    | 1.1 |                    | ms   |
| $T_{D\_off}$                      | Turn-off delay time                          |   |                    | 1.6 |                    | ms   |
| $T_{IOS}$                         | Response time to short circuit               | $USB\_IN = 5\text{ V}$  |                    | 2   |                    | μs   |
| $T_{DEGLITCH(OCP)}$               | Switch over current fault deglitch           | Fault assertion or de-assertion due to over-current condition   |                    | 8.8 |                    | ms   |

(1) Specified by design.

**ELECTRICAL CHARACTERISTICS (continued)**

$T_J = -40^{\circ}\text{C}$  to  $125^{\circ}\text{C}$ ,  $V_{IN} = 12\text{ V}$ ,  $f_{SW} = 500\text{ kHz}$  (unless otherwise noted)

| PARAMETER                                       | TEST CONDITIONS                        | MIN | TYP | MAX | UNIT               |
|---|--|-----|-----|-----|--------------------|
| $R_{DIS}$ Discharge resistance                  | USB_IN = 5 V,<br>USB1_EN/USB2_EN = 0 V |     | 130 |     | $\Omega$           |
| <b>THERMAL SHUTDOWN</b>                         |  |     |     |     |                    |
| $T_{TRIP}$ Thermal shut down trip point         | Rising temperature                     |     | 160 |     | $^{\circ}\text{C}$ |
| $T_{HYST}$ Thermal shut down hysteresis         | Device re-starts                       |     | 20  |     | $^{\circ}\text{C}$ |
| $T_{TRIP\_DEGLITCH}$ Thermal shut down deglitch |  |     | 110 |     | $\mu\text{s}$      |

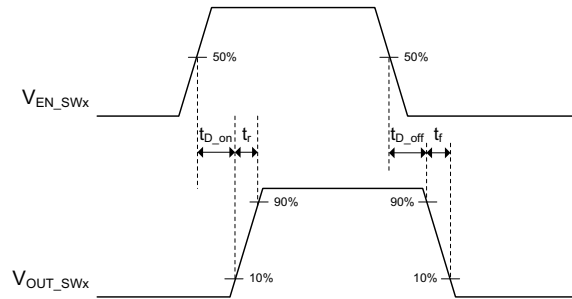

**Figure 1. Power Switches Test Circuit and Voltage Waveforms**

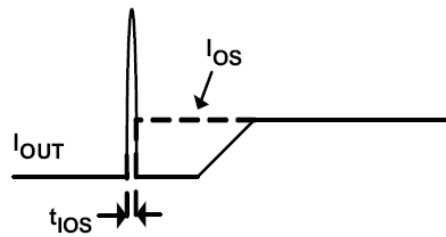

**Figure 2. Response Time to Short Circuit Waveform**

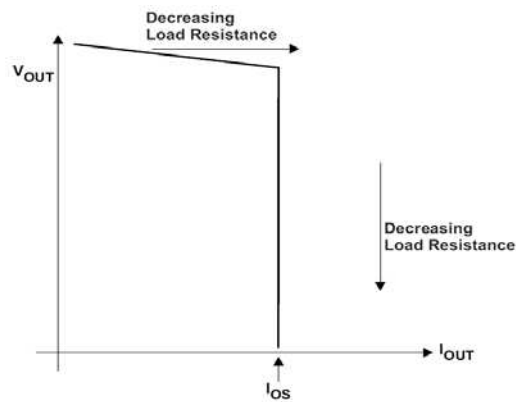

**Figure 3. Output Voltage vs Current Limit Threshold**

TYPICAL CHARACTERISTICS

$T_A = 25^\circ\text{C}$ ,  $V_{IN} = 12\text{ V}$ , Buck1 = 1.2 V, Buck2 = 1.8 V, Buck3 = 3.3 V,  $L = 4.7\ \mu\text{H}$ ,  $f_{SW} = 500\text{ kHz}$  (unless otherwise noted)

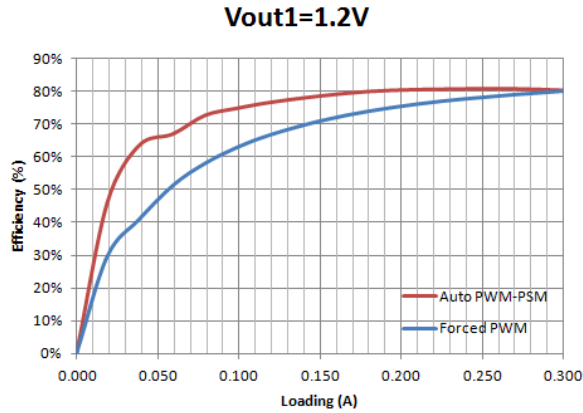

Figure 4. Buck1 1.2V Efficiency, Forced PWM and PSM

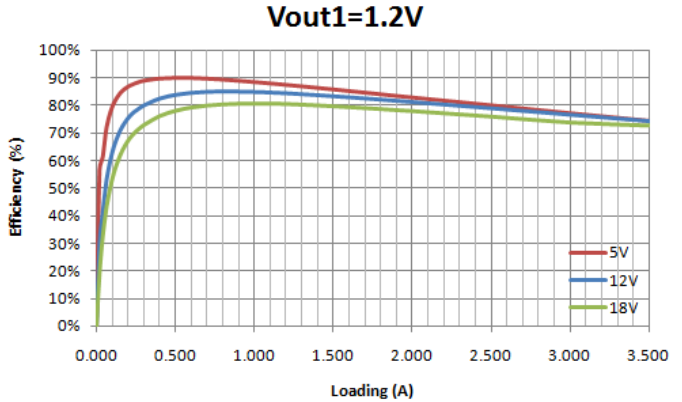

Figure 5. Buck1 1.2V Efficiency, Forced PWM

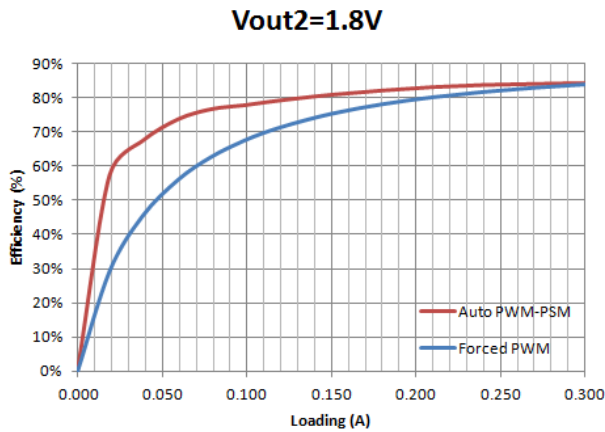

Figure 6. Buck2 1.8V Efficiency, Forced PWM and PSM

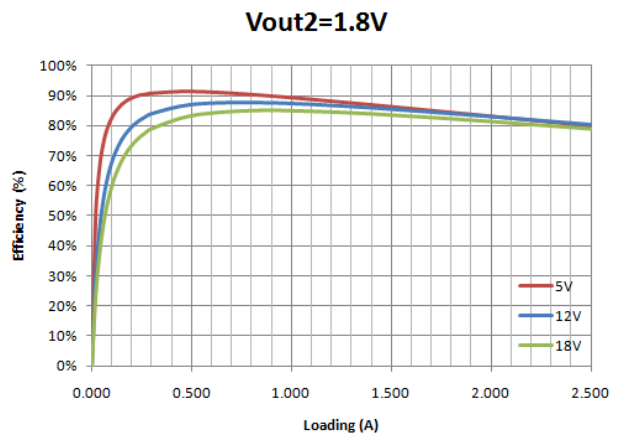

Figure 7. Buck2 1.8V Efficiency, Forced PWM

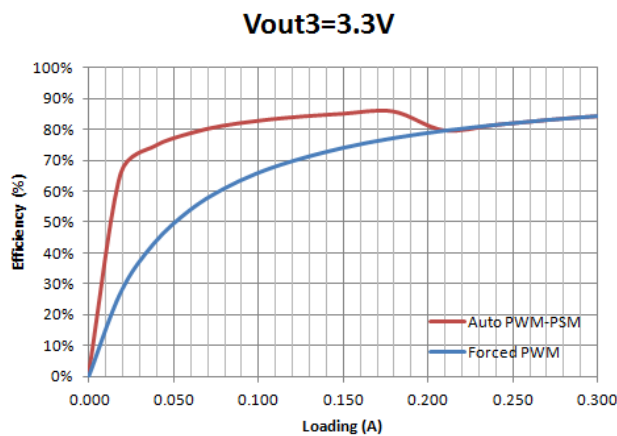

Figure 8. Buck3 3.3V Efficiency, Forced PWM and PSM

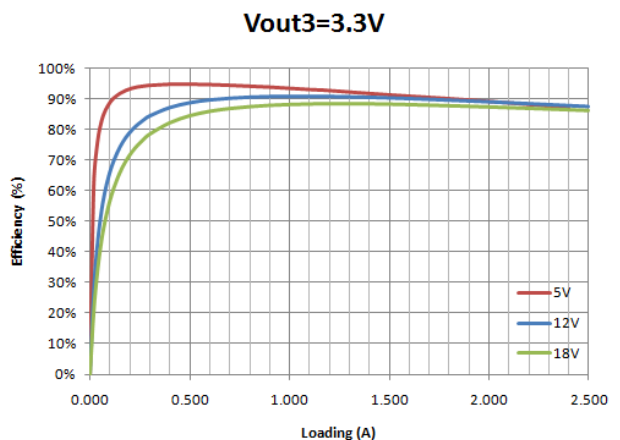

Figure 9. Buck3 3.3V Efficiency, Forced PWM

**TYPICAL CHARACTERISTICS (continued)**

$T_A = 25^\circ\text{C}$ ,  $V_{IN} = 12\text{ V}$ , Buck1 = 1.2 V, Buck2 = 1.8 V, Buck3 = 3.3 V,  $L = 4.7\ \mu\text{H}$ ,  $f_{SW} = 500\text{ kHz}$  (unless otherwise noted)

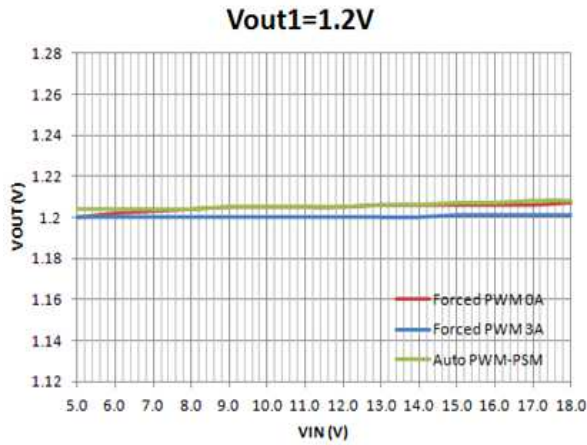

Figure 10. Line Regulation: Buck1 @ 1.2V, 1% Resistor Feedback

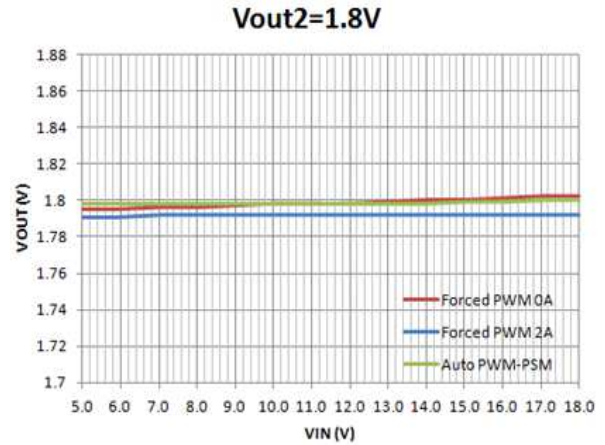

Figure 11. Line Regulation: Buck2 @ 1.8V, 1% Resistor Feedback

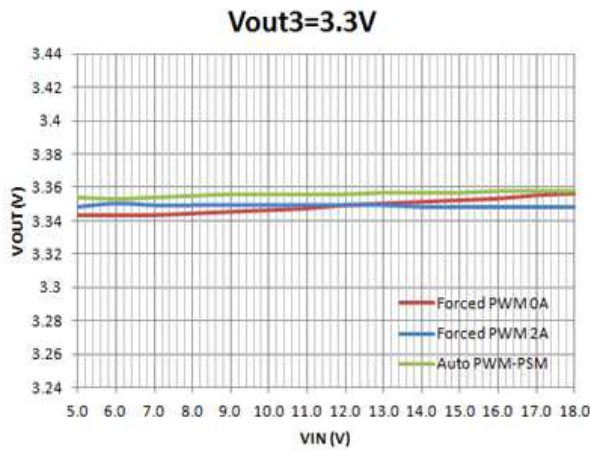

Figure 12. Line Regulation: Buck3 @ 3.3V, 1% Resistor Feedback

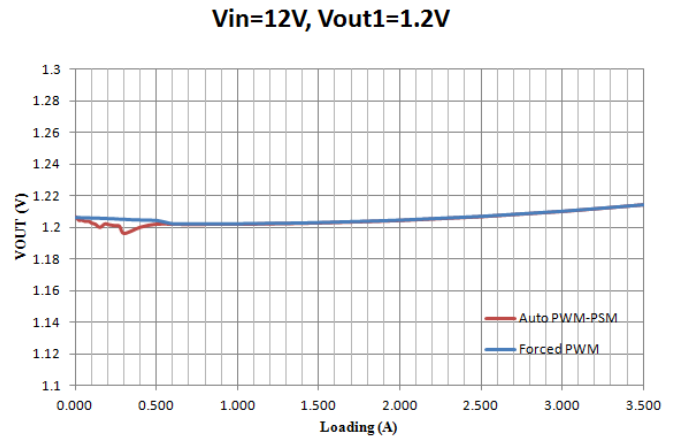

Figure 13. Load Regulation: Buck1 @ 1.2V, 1% Resistor Feedback

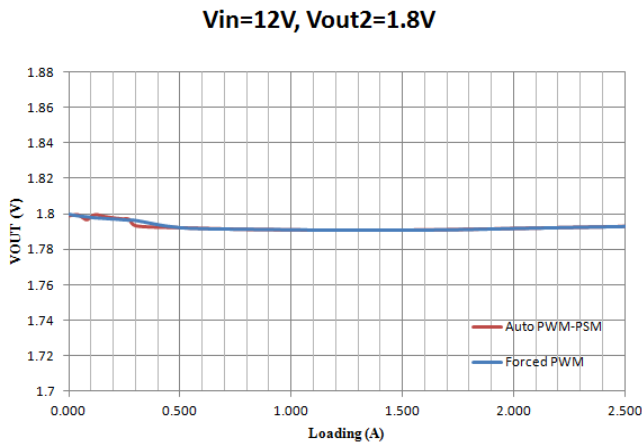

Figure 14. Load Regulation: Buck2 @ 1.8V, 1% Resistor Feedback

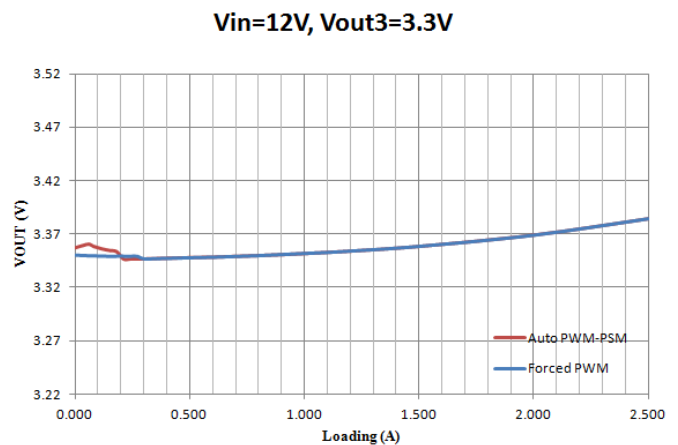

Figure 15. Load Regulation: Buck3 @ 3.3V, 1% Resistor Feedback

**TYPICAL CHARACTERISTICS (continued)**

$T_A = 25^\circ\text{C}$ ,  $V_{IN} = 12\text{ V}$ , Buck1 = 1.2 V, Buck2 = 1.8 V, Buck3 = 3.3 V,  $L = 4.7\ \mu\text{H}$ ,  $f_{SW} = 500\text{ kHz}$  (unless otherwise noted)

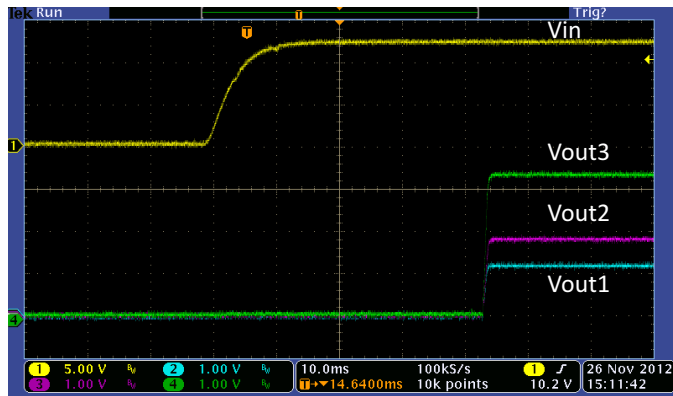

Figure 16. Power-Up All Converters, No Load

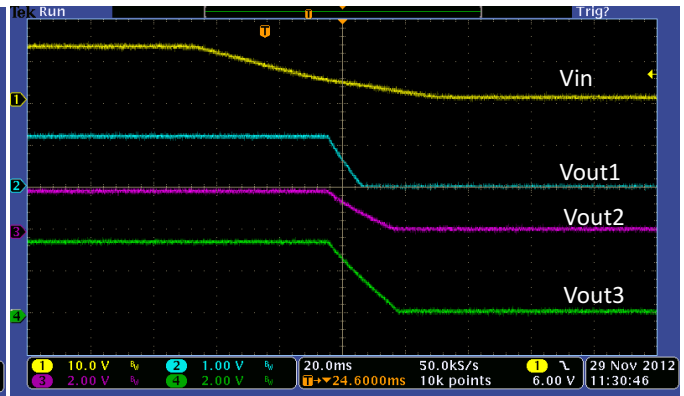

Figure 17. Power-Down All Converters, No Load

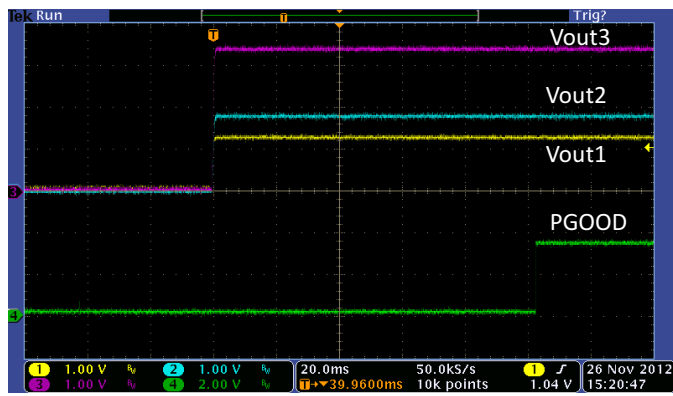

Figure 18. Power-Up All Converters and PGOOD, No Load

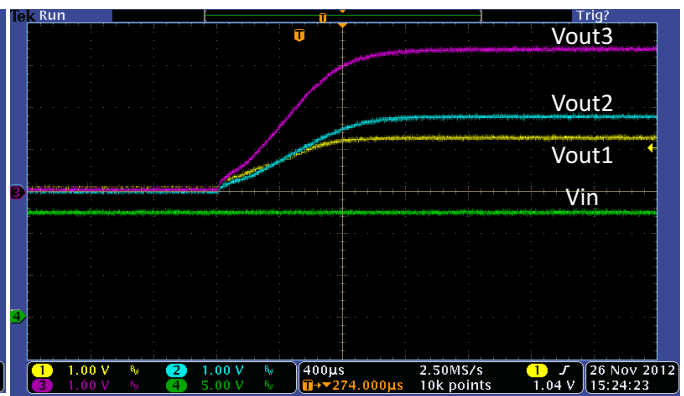

Figure 19. Detail of Start-Up 4.7nF Fitted to All Enable Pins

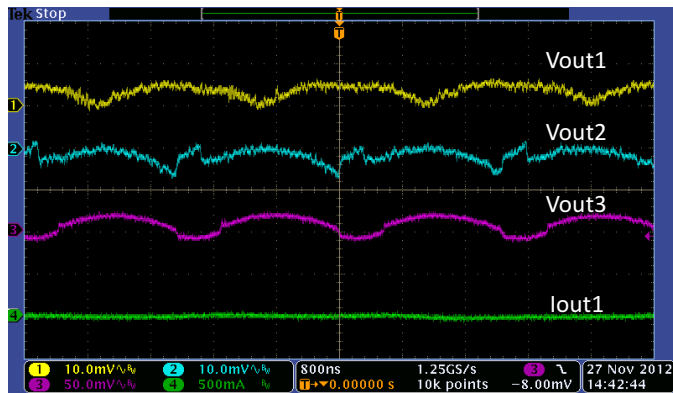

Figure 20. Ripple, Buck1 = 0A, Buck2 = 0A, Buck3 = 0A

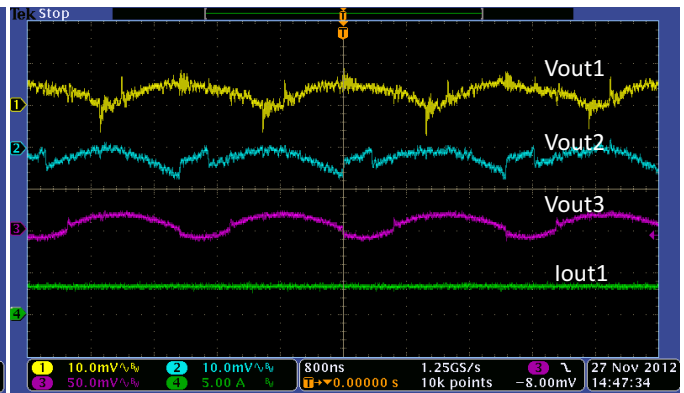

Figure 21. Transient Response Buck1  
Ripple, Buck1 = 3A, Buck2 = 2A, Buck3 = 2A

**TYPICAL CHARACTERISTICS (continued)**

$T_A = 25^\circ\text{C}$ ,  $V_{IN} = 12\text{ V}$ , Buck1 = 1.2 V, Buck2 = 1.8 V, Buck3 = 3.3 V,  $L = 4.7\ \mu\text{H}$ ,  $f_{SW} = 500\text{ kHz}$  (unless otherwise noted)



Figure 22. Transient Response Buck1@1.2V, 1-3A Step,  $C_o = 68\ \mu\text{F}$



Figure 23. Transient Response Buck2@1.8V, 1-2A Step,  $C_o = 47\ \mu\text{F}$

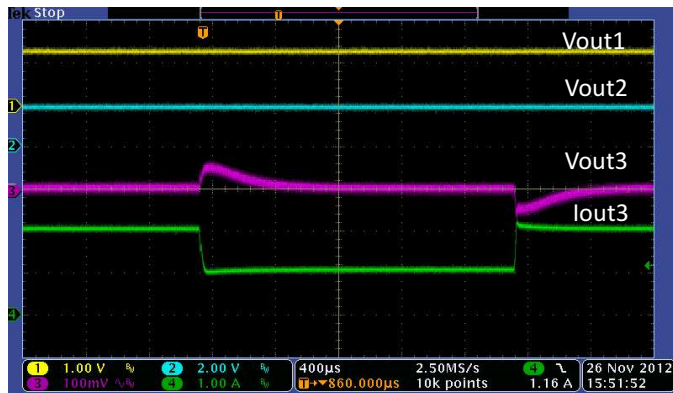

Figure 24. Transient Response Buck3@3.3 V, 1-2A Step,  $C_o = 22\ \mu\text{F}$

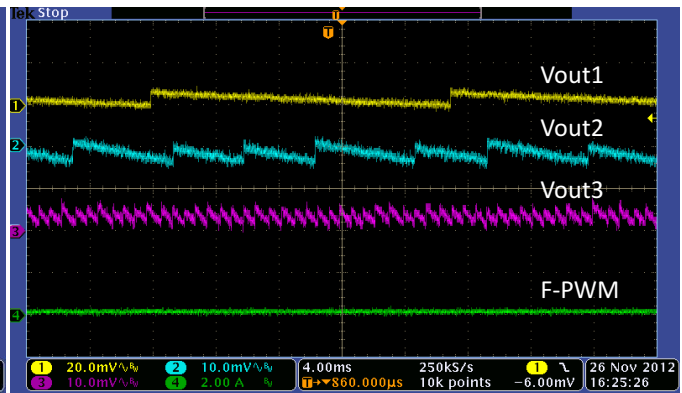

Figure 25. PSM Operation 1.2V, 1.8V, 3.3V

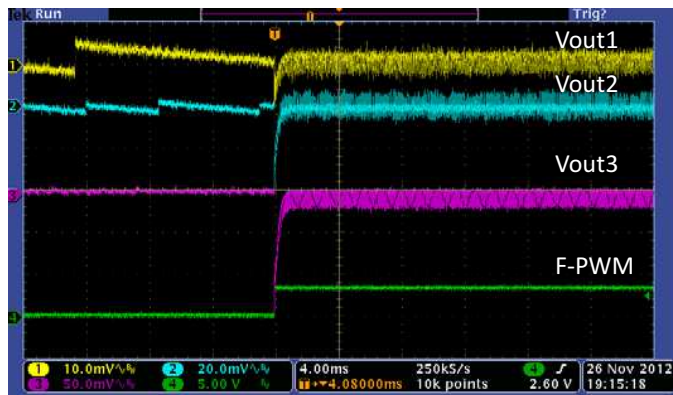

Figure 26. PSM/PWM Transition (Pin 25 Pulled High)

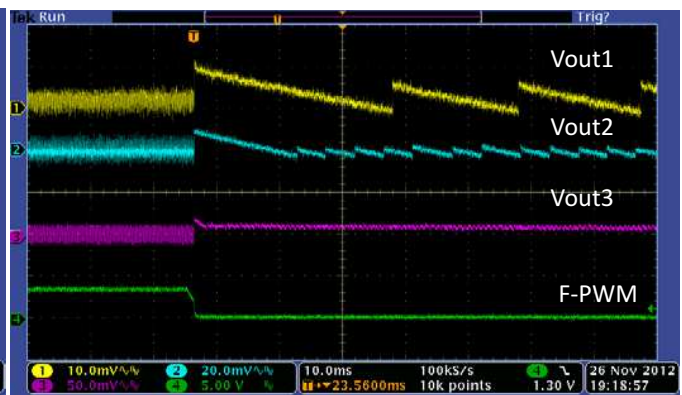

Figure 27. PSM/PWM Transition (Pin 25 Pulled Low)

**TYPICAL CHARACTERISTICS (continued)**

$T_A = 25^\circ\text{C}$ ,  $V_{IN} = 12\text{ V}$ , Buck1 = 1.2 V, Buck2 = 1.8 V, Buck3 = 3.3 V,  $L = 4.7\ \mu\text{H}$ ,  $f_{SW} = 500\text{ kHz}$  (unless otherwise noted)

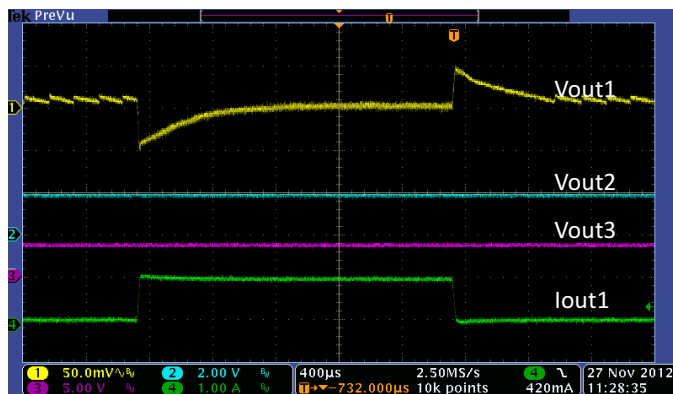

Figure 28. Buck1 Dynamic Transition from PSM to PWM,  $C=68\ \mu\text{F}$

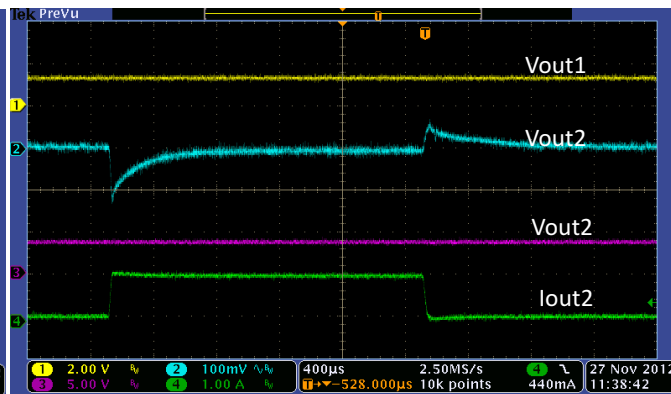

Figure 29. Buck2 Dynamic Transition from PSM to PWM  $C=47\ \mu\text{F}$

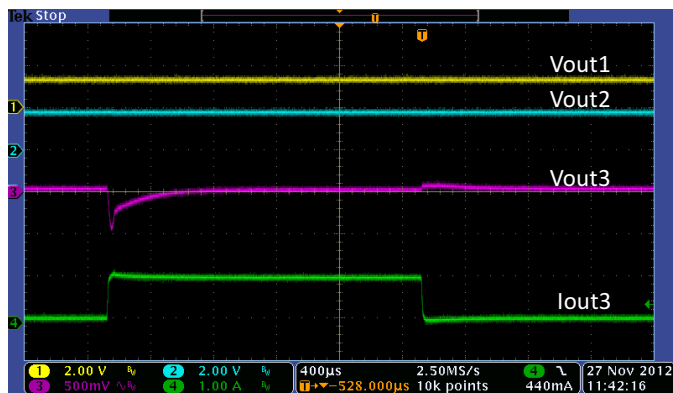

Figure 30. Buck3 Dynamic Transition from PSM to PWM,  $C=22\ \mu\text{F}$

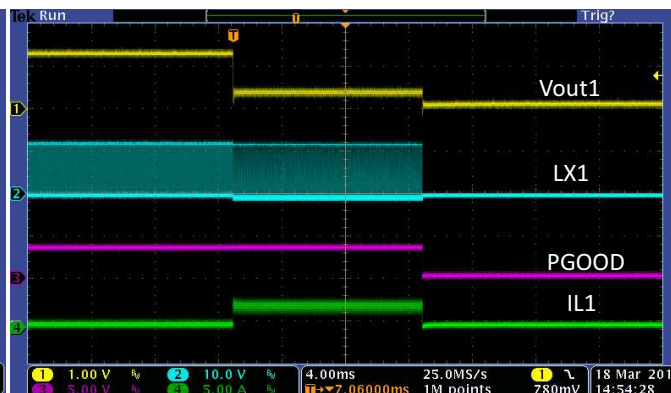

Figure 31. Over Current Protection PGOOD Buck1=1.2V

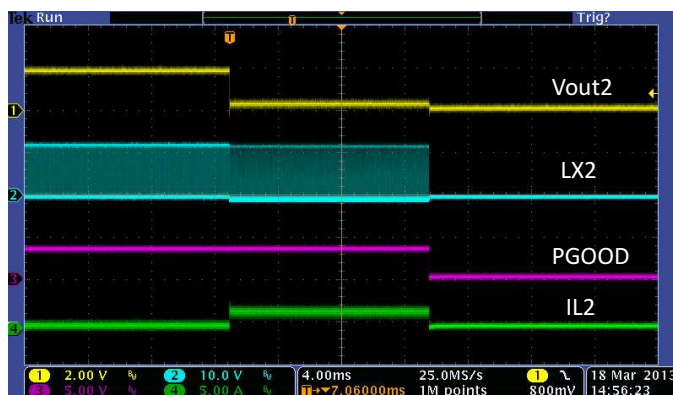

Figure 32. Over Current Protection and PGOOD Buck2=1.8V

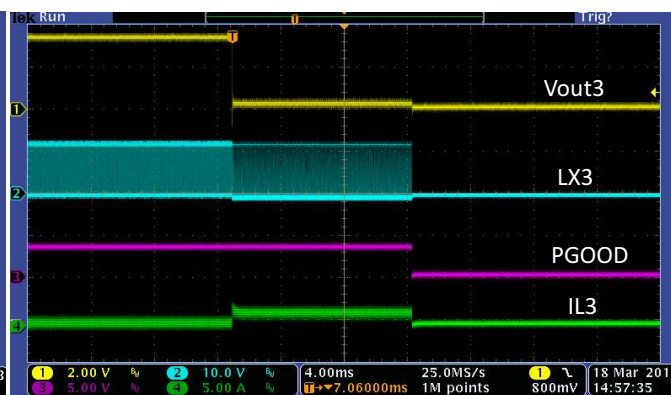

Figure 33. Over Current Protection and PGOOD Buck3=3.3V

TYPICAL CHARACTERISTICS (continued)

$T_A = 25^\circ\text{C}$ ,  $V_{IN} = 12\text{ V}$ , Buck1 = 1.2 V, Buck2 = 1.8 V, Buck3 = 3.3 V,  $L = 4.7\ \mu\text{H}$ ,  $f_{SW} = 500\text{ kHz}$  (unless otherwise noted)

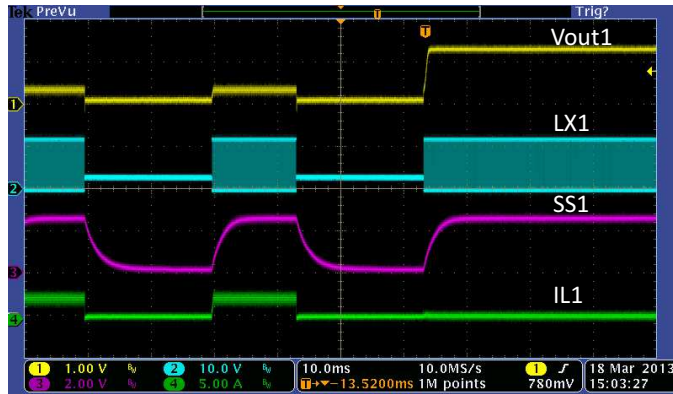

Figure 34. Hiccup Recover, Buck1=1.2V



Figure 35. Hiccup Recover, Buck2=1.8V

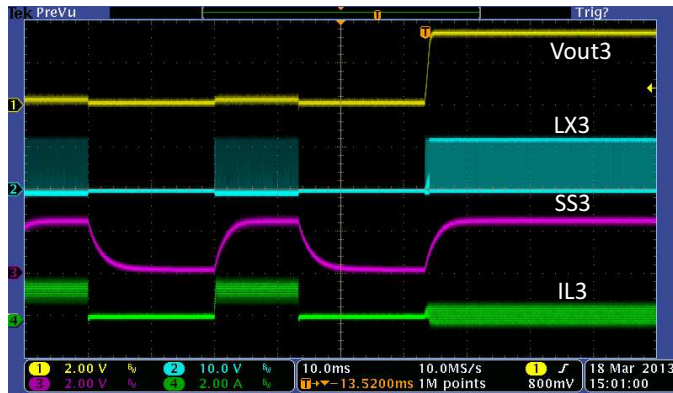

Figure 36. Hiccup Recover, Buck3=3.3V

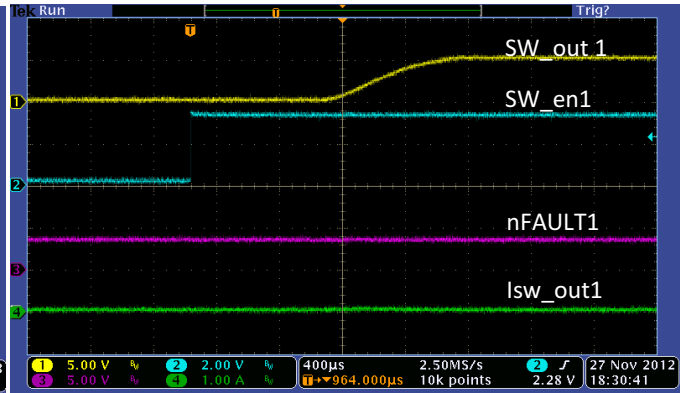

Figure 37. USB Switch1 Start-Up No Load

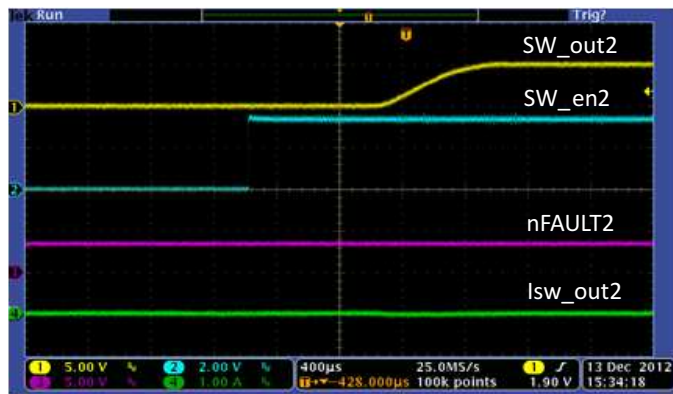

Figure 38. USB Switch2 Start-Up No Load

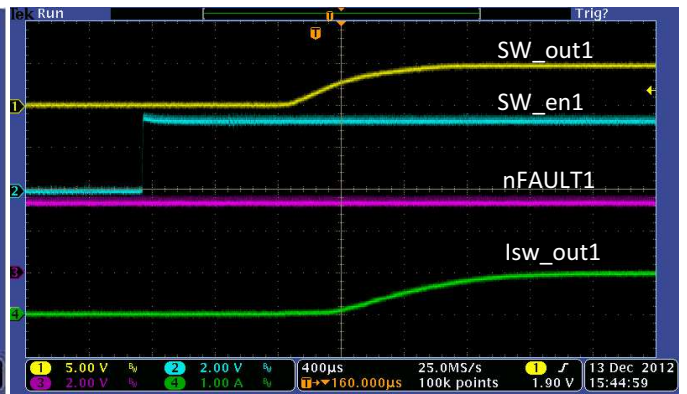

Figure 39. USB Switch1 Start-Up 1A Load



**TYPICAL CHARACTERISTICS (continued)**

$T_A = 25^\circ\text{C}$ ,  $V_{IN} = 12\text{ V}$ , Buck1 = 1.2 V, Buck2 = 1.8 V, Buck3 = 3.3 V,  $L = 4.7\ \mu\text{H}$ ,  $f_{SW} = 500\text{ kHz}$  (unless otherwise noted)



Figure 40. USB Switch2 Start-Up 1A Load

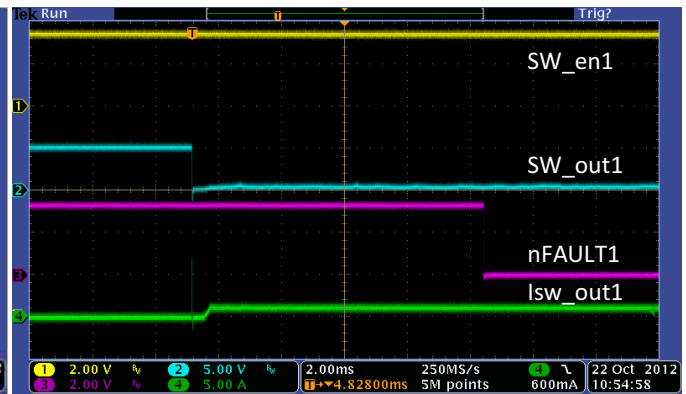

Figure 41. USB Switch1 Current Limit Operation



Figure 42. USB Switch2 Current Limit Operation

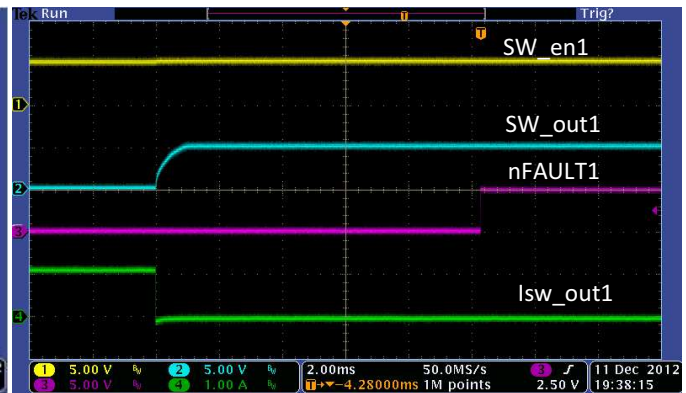

Figure 43. USB Switch1 Current Limit Recovery



Figure 44. USB Switch2 Current Limit Recovery

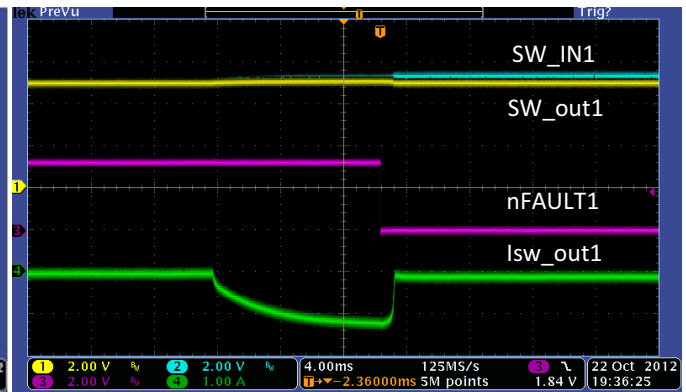

Figure 45. USB Switch1 Output Reverse Protection

**TYPICAL CHARACTERISTICS (continued)**

$T_A = 25^\circ\text{C}$ ,  $V_{IN} = 12\text{ V}$ , Buck1 = 1.2 V, Buck2 = 1.8 V, Buck3 = 3.3 V,  $L = 4.7\ \mu\text{H}$ ,  $f_{SW} = 500\text{ kHz}$  (unless otherwise noted)

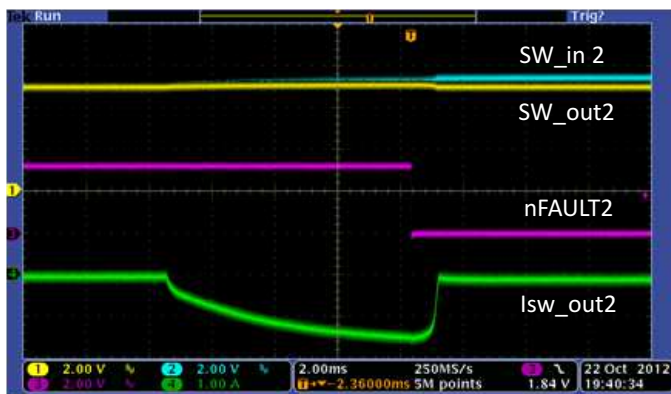

Figure 46. USB Switch2 Output Reverse Protection

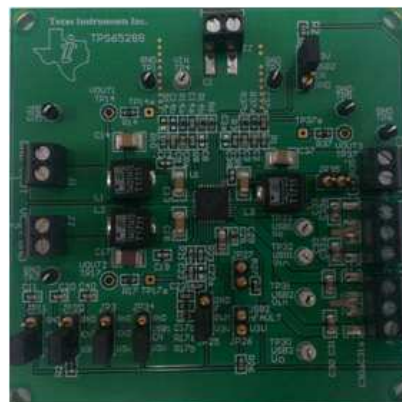

Figure 47. EVM Layout

DETAILED DESCRIPTION

Adjustable Switching Frequency

To select the internal switching frequency, connect a resistor from ROSC to ground. Figure 48 shows the required resistance for a given switching frequency.

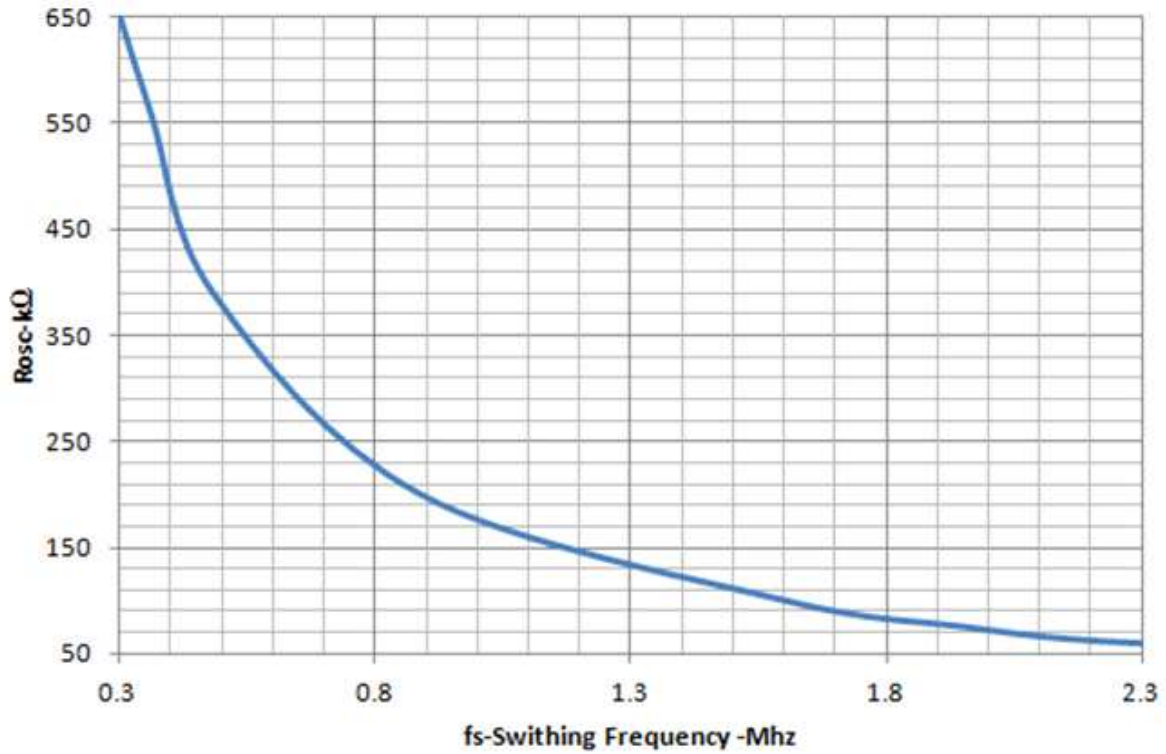

Figure 48. ROSC vs Switching Frequency

$$R_{OSC}(k\Omega) = 169.5 \cdot f_{SW}^{-1.221} \tag{1}$$

## Output Inductor Selection

To calculate the value of the output inductor, use [Equation 2](#).

$$L_o = \frac{V_{in} - V_{out}}{I_o \cdot K_{ind}} \cdot \frac{V_{out}}{V_{in} \cdot f_{sw}} \quad (2)$$

$K_{IND}$  is a coefficient that represents the amount of inductor ripple current relative to the maximum output current. In general,  $K_{IND}$  is normally from 0.1 to 0.3 for the majority of applications. A value of 0.1 will improve the efficiency at light load, while a value of 0.3 will provide the lowest possible cost solution. The ripple current is:

$$I_{ripple} = \frac{V_{in} - V_{out}}{L_o} \cdot \frac{V_{out}}{V_{in} \cdot f_{sw}} \quad (3)$$

## Output Capacitor

There are two primary considerations for selecting the value of the output capacitor. The output capacitors are selected to meet load transient and output ripple's requirements. If a minimum transient specification is required use the following equation:

$$C_o > \frac{\Delta I_{OUT}^2 \cdot L_o}{V_{out} \cdot \Delta V_{out}} \quad (4)$$

The following equation calculates the minimum output capacitance needed to meet the output voltage ripple specification.

$$C_o > \frac{1}{8 \cdot f_{sw}} \cdot \frac{1}{\frac{V_{RIPPLE}}{I_{RIPPLE}}} \quad (5)$$

Where  $f_{SW}$  is the switching frequency,  $V_{RIPPLE}$  is the maximum allowable output voltage ripple, and  $I_{RIPPLE}$  is the inductor ripple current.

## Input Capacitor

A minimum 10- $\mu$ F X7R/X5R ceramic input capacitor is recommended to be added between VIN and GND of each converter. The input capacitor must handle the RMS ripple current shown in the following equation.

$$I_{cirms} = I_{out} \cdot \sqrt{\frac{V_{out}}{V_{in \min}} \cdot \frac{(V_{in \min} - V_{out})}{V_{in \min}}} \quad (6)$$

## Bootstrap Capacitor

The device has two integrated boot regulators and requires a small ceramic capacitor between the BST and LX pins to provide the gate drive voltage for the high side MOSFET. The value of the ceramic capacitor should be 0.047  $\mu$ F. A ceramic capacitor with an X7R or X5R grade dielectric is recommended because of the stable characteristics over temperature and voltage.

## Delayed Start-Up

If a delayed start-up is required on any of the buck converters fit a ceramic capacitor to the ENx pins. The delay added is ~1.67 ms per nF connected to the pin. Note that the EN pins have a weak 1 M $\Omega$  pull-up to the 3V3 rail.

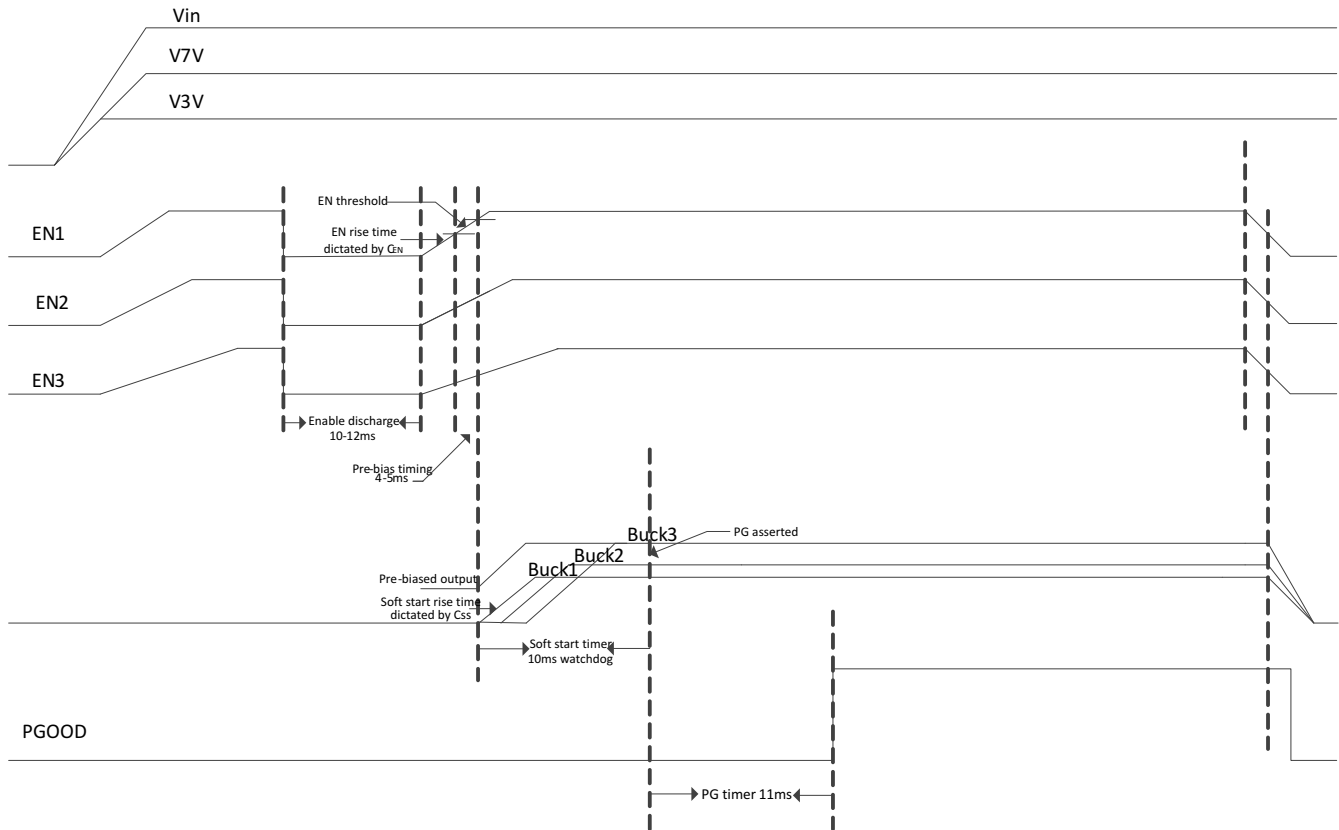

Figure 49. Delayed Start-Up

### Out-of-Phase Operation

In order to reduce input ripple current, buck 1 and buck 2 operate 180 degree out-of-phase. This enables the system having less input ripple, then to lower component cost, save board space and reduce EMI.

### Soft-Start Time

The device has an internal pull-up current source of 5  $\mu\text{A}$  that charges an external soft-start capacitor to implement a slow start time. Equation 7 shows how to select a soft-start capacitor based on an expected slow start time. The voltage reference ( $V_{REF}$ ) is 0.8 V and the soft-start charge current ( $I_{SS}$ ) is 5  $\mu\text{A}$ . The soft-start circuit requires 1 nF per around 167  $\mu\text{s}$  to be connected at the SS pin. A 0.8-ms soft-start time is implemented for all converters fitting 4.7 nF to the relevant SS pin.

$$T_{ss}(ms) = V_{REF}(V) \cdot \left( \frac{C_{ss}(nF)}{I_{ss}(\mu A)} \right) \quad (7)$$

The Power Good circuit for the bucks has a 11-ms watchdog. Therefore the soft-start time should be lower than this value. It is recommended not to exceed 5 ms.

### Adjusting the Output Voltage

The output voltage is set with a resistor divider from the output node to the FB pin. It is recommended to use 1% tolerance or better divider resistors. In order to improve efficiency at light load, start with a value close to 40 kΩ for the R1 resistor and use Equation 8 to calculate R2.

$$R2 = R1 \cdot \left( \frac{0.8V}{V_o - 0.8V} \right) \tag{8}$$

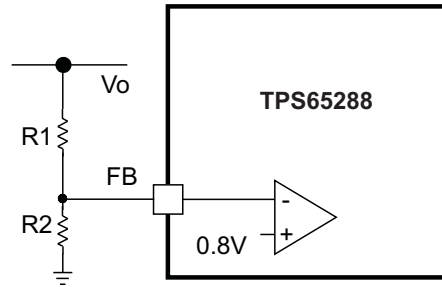

Figure 50. Voltage Divider Circuit

### Loop Compensation

TPS65288 is a current mode control DC/DC converter. The error amplifier is a transconductance amplifier with a  $g_M$  of 130  $\mu A/V$ . A typical compensation circuit could be type II ( $R_C$  and  $C_C$ ) to have a phase margin between 60° and 90°, or type III ( $R_C$  and  $C_C$  and  $C_{ff}$  to improve the converter transient response.  $C_{Roll}$  adds a high frequency pole to attenuate high-frequency noise when needed. It may also prevent noise coupling from other rails if there is possibility of cross coupling in between rails when layout is very compact.

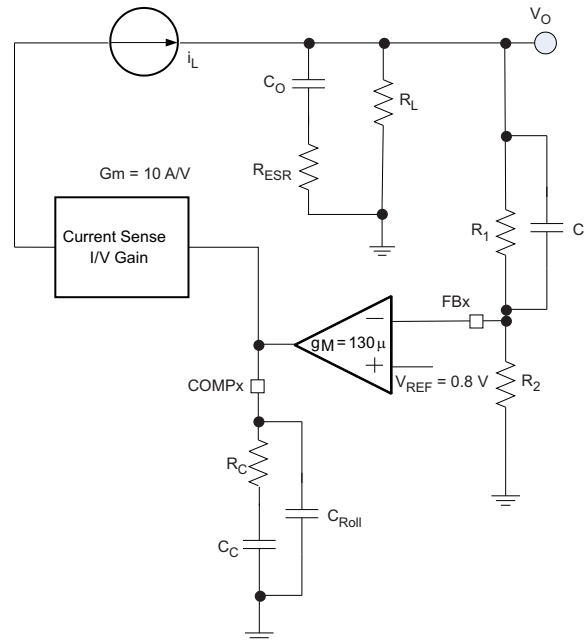

Figure 51. Loop Compensation Scheme

To calculate the external compensation components follow the following steps:

|  | TYPE II CIRCUIT   | TYPE III CIRCUIT  |
|--|---|---|
| Select switching frequency that is appropriate for application depending on L, C sizes, output ripple, EMI concerns and etc. Switching frequencies around 500 kHz yield best trade off between performance and cost. When using smaller L and C, switching frequency can be increased. To optimize efficiency, switching frequency can be lowered. |   | Type III circuit recommended for switching frequencies higher than 500 kHz.           |
| Select cross over frequency ( $f_c$ ) to be at least 1/5 to 1/10 of switching frequency ( $f_s$ ).   | Suggested<br>$f_c = f_s/10$   | Suggested<br>$f_c = f_s/10$   |
| Set and calculate $R_c$ .  | $R_c = \frac{2\pi \cdot f_c \cdot V_o \cdot C_o}{g_M \cdot V_{ref} \cdot g_{m_{ps}}}$ | $R_c = \frac{2\pi \cdot f_c \cdot V_o \cdot C_o}{g_M \cdot V_{ref} \cdot g_{m_{ps}}}$ |
| Calculate $C_c$ by placing a compensation zero at or before the converter dominant pole<br>$f_p = \frac{1}{C_o \cdot R_L \cdot 2\pi}$  | $C_c = \frac{R_L \cdot C_o}{R_c}$   | $C_c = \frac{R_L \cdot C_o}{R_c}$   |
| Add $C_{Roll}$ if needed to remove large signal coupling to high impedance CMP node. Make sure that<br>$f_{p_{Roll}} = \frac{1}{2 \cdot \pi \cdot R_c \cdot C_{Roll}}$<br>is at least twice the cross over frequency.  | $C_{Roll} = \frac{R_{e_{sr}} \cdot C_o}{R_c}$   | $C_{Roll} = \frac{R_{e_{sr}} \cdot C_o}{R_c}$   |
| Calculate $C_{ff}$ compensation zero at low frequency to boost the phase margin at the crossover frequency. Make sure that the zero frequency ( $f_{z_{ff}}$ ) is smaller than equivalent soft-start frequency ( $1/T_{ss}$ ).   | NA  | $C_{ff} = \frac{1}{2 \cdot \pi \cdot f_{z_{ff}} \cdot R_1}$                           |

## Slope Compensation

The device has a built-in slope compensation ramp. The slope compensation can prevent sub harmonic oscillations in peak current mode control.

## Power Good

The PGOOD pin is an open drain output. The PGOOD pin is pulled low when any buck converter is pulled below 85% of the nominal output voltage. The PGOOD is pulled up when both buck converters' outputs are more than 90% of its nominal output voltage.

The default reset time is 100 ms. The polarity of the PGOOD is active high.

### Current Limit Protection

The TPS65288 current limit trip is set by the following formulae:

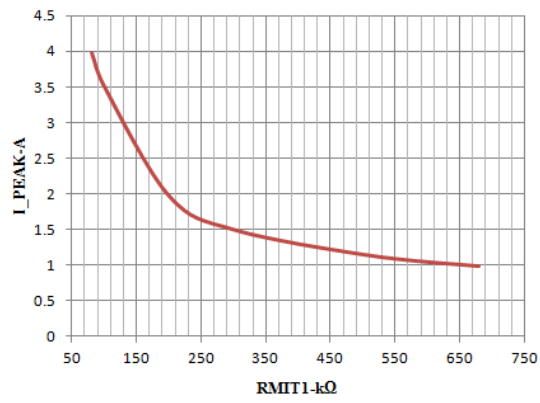
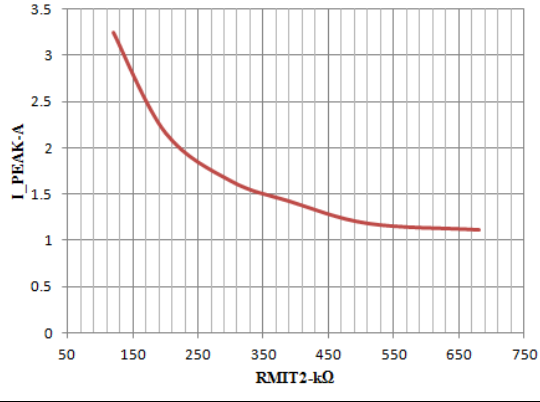
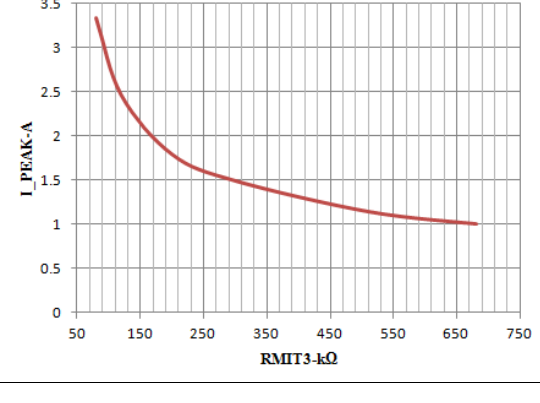
|  |      | TYPE II CIRCUIT  |
|--|------|--|
| $I_{LIM1}(A) = \frac{268.5}{RLIM1(k\Omega)} + 0.613$ | (9)  |    |
| $I_{LIM2}(A) = \frac{324.8}{RLIM1(k\Omega)} + 0.543$ | (10) |   |
| $I_{LIM3}(A) = \frac{208.7}{RLIM2(k\Omega)} + 0.731$ | (11) |  |

All converters operate in hiccup mode: Once an over-current lasting more than 11 ms is sensed in any of the converters, they will shut down for 11 ms and then the start-up sequencing will be tried again. If the overload has been removed, the converter will ramp up and operate normally. If this is not the case the converter will see another over-current event and shuts-down again repeating the cycle (hiccup) until the failure is cleared.

If an overload condition lasts for less than 11 ms, only the relevant converter affected will shut-down and re-start and no global hiccup mode will occur.



## Overvoltage Transient Protection

The device incorporates an overvoltage transient protection (OVP) circuit to minimize voltage overshoot. The OVP feature minimizes the output overshoot by implementing a circuit to compare the FB pin voltage to OVTP threshold which is 106% of the internal voltage reference. If the FB pin voltage is greater than the OVTP threshold, the high side MOSFET is disabled preventing current from flowing to the output and minimizing output overshoot. When the FB voltage drops lower than the OVTP threshold which is 104%, the high side MOSFET is allowed to turn on the next clock cycle.

## Low Power/Pulse Skipping Operation

When a buck synchronous converter operates at light load or standby conditions, the switching losses are the dominant source of power losses. Under these load conditions, TPS65288 uses a pulse skipping modulation technique to reduce the switching losses by keeping the power transistors in the off-state for several switching cycles, while maintaining a regulated output voltage. Figure 52 shows the output voltage and load plus the inductor current.

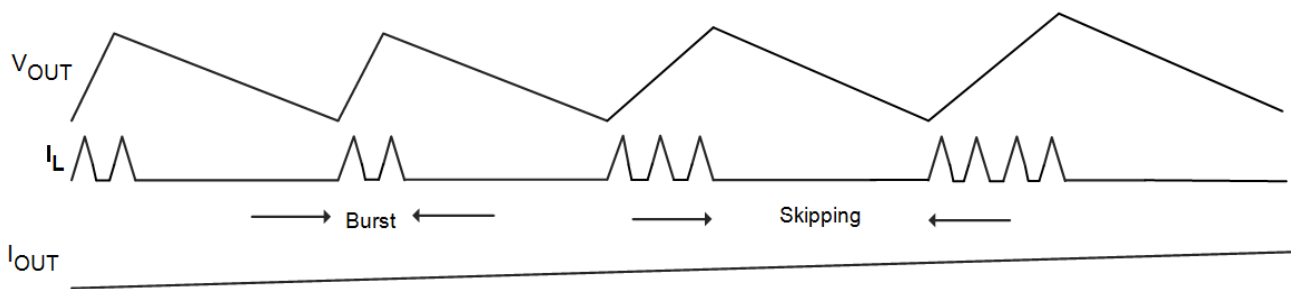

Figure 52. Low Power/Pulse Skipping

During the burst mode, the converter continuously charges up the output capacitor until the output voltage reaches a certain limit threshold. The operation of the converter in this interval is equivalent to the peak inductor current mode control. In each switch period, the main switch is turned on until the inductor current reaches the peak current limit threshold. As the load increases the number of pulses increases to make sure that the output voltage stays within regulation limits. When the load is very light the low power controller has a zero crossing detector to allow the low side mosfet to operate even in light load conditions. The transistor is not disabled at light loads. A zero crossing detection circuit will disable it when inductor current reverses. During the whole process the body diode does not conduct but is used as blocking diode only.

During the skipping interval, the upper and lower transistors are turned off and the converter stays in idle mode. The output capacitors are discharged by the load current until the moment when the output voltage drops to a low threshold.

The choice of output filter will influence the performance of the low power circuit. The maximum ripple during low power mode can be calculated as:

$$V_{OUT\_RIPPLE} = \frac{K_{RIP} T_S}{C_{OUT}} \quad (12)$$

Where  $K_{RIP}$  is 1.4 for Buck1 and 0.7 for Buck2 and Buck3.  $T_S$  can be calculated as:

$$T_S = \frac{0.35}{\left[ \left( \frac{V_{IN} - V_{OUT}}{L} \right) \frac{V_{OUT}}{V_{IN}} \right]} \quad (13)$$

## USB Switches

The USB switches are enabled (active high) with the USB\_ENx pin. The switches have a typical resistance of 135 mΩ. If a continuous short-circuit condition is applied to the USB switch output, the USB switch will shut-down once its temperature reaches 130°C, allowing for the buck converters to operate unaffected. Once the USB switch cools down it will restart automatically.

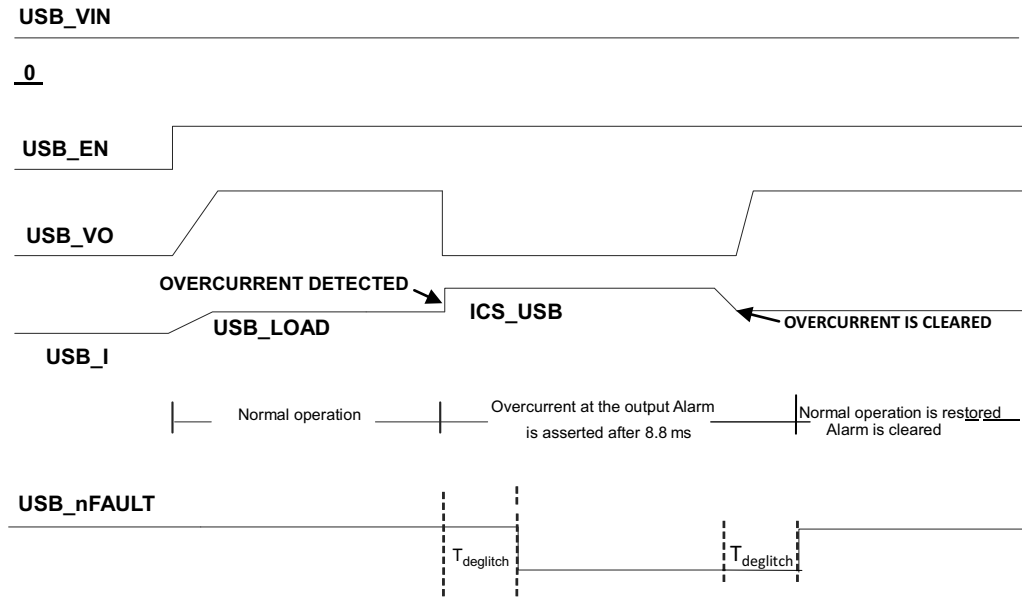

Figure 53. USB Switches

## Thermal Shutdown

The device implements an internal thermal shutdown to protect itself if the junction temperature exceeds 160°C. The thermal shutdown forces the device to stop switching when the junction temperature exceeds thermal trip threshold. Once the die temperature decreases below 140°C, the device reinitiates the power up sequence. The thermal shutdown hysteresis is 20°C.

## 3.3-V and 6.5 LDO Regulators

The following ceramic capacitor (X7R/X5R) should be connected as close as possible to the described pins:



- 4.7 μF to 10 μF for V7V pin 28
- 3.3 μF to 10 μF for V3V pin 29

## Layout Recommendation

Layout is a critical portion of PMIC designs.

- Place tracing for output voltage and LX on the top layer and an inner power plane for VIN.
- Fit also on the top layer connections for the remaining pins of the PMIC and a large top side area filled with ground.
- The top layer ground area should be connected to the internal ground layer(s) using vias at the input bypass capacitor, the output filter capacitor and directly under the TPS65288 device to provide a thermal path from the PowerPad land to ground.
- For operation at full rated load, the top side ground area together with the internal ground plane, must provide adequate heat dissipating area.
- There are several signals paths that conduct fast changing currents or voltages that can interact with stray inductance or parasitic capacitance to generate noise or degrade the power supplies performance. To help eliminate these problems, the VIN pin should be bypassed to ground with a low ESR ceramic bypass capacitor with X5R or X7R dielectric. Care should be taken to minimize the loop area formed by the bypass capacitor connections, the VIN pins, and the ground connections. Since the LX connection is the switching node, the output inductor should be located close to the LX pins, and the area of the PCB conductor minimized to prevent excessive capacitive coupling.
- The output filter capacitor ground should use the same power ground trace as the VIN input bypass capacitor. Try to minimize this conductor length while maintaining adequate width.
- The compensation should be as close as possible to the CMPx pins. The CMPx and ROOSC pins are sensitive to noise so the components associated to these pins should be located as close as possible to the IC and routed with minimal lengths of trace.

**PACKAGING INFORMATION**

| Orderable Device | Status<br>(1) | Package Type | Package Drawing | Pins | Package Qty | Eco Plan<br>(2) | Lead finish/<br>Ball material<br>(6) | MSL Peak Temp<br>(3) | Op Temp (°C) | Device Marking<br>(4/5) | Samples   |
|------------------|---------------|--------------|-----------------|------|-------------|-----------------|--------------------------------------|----------------------|--------------|-------------------------|---|
| TPS65288RHAR     | ACTIVE        | VQFN         | RHA             | 40   | 2500        | RoHS & Green    | NIPDAU                               | Level-3-260C-168 HR  | -40 to 125   | TPS<br>65288            |  |
| TPS65288RHAT     | ACTIVE        | VQFN         | RHA             | 40   | 250         | RoHS & Green    | NIPDAU                               | Level-3-260C-168 HR  | -40 to 125   | TPS<br>65288            |  |

(1) The marketing status values are defined as follows:

**ACTIVE:** Product device recommended for new designs.

**LIFEBUY:** TI has announced that the device will be discontinued, and a lifetime-buy period is in effect.

**NRND:** Not recommended for new designs. Device is in production to support existing customers, but TI does not recommend using this part in a new design.

**PREVIEW:** Device has been announced but is not in production. Samples may or may not be available.

**OBsolete:** TI has discontinued the production of the device.

(2) **RoHS:** TI defines "RoHS" to mean semiconductor products that are compliant with the current EU RoHS requirements for all 10 RoHS substances, including the requirement that RoHS substance do not exceed 0.1% by weight in homogeneous materials. Where designed to be soldered at high temperatures, "RoHS" products are suitable for use in specified lead-free processes. TI may reference these types of products as "Pb-Free".

**RoHS Exempt:** TI defines "RoHS Exempt" to mean products that contain lead but are compliant with EU RoHS pursuant to a specific EU RoHS exemption.

**Green:** TI defines "Green" to mean the content of Chlorine (Cl) and Bromine (Br) based flame retardants meet JS709B low halogen requirements of <=1000ppm threshold. Antimony trioxide based flame retardants must also meet the <=1000ppm threshold requirement.

(3) MSL, Peak Temp. - The Moisture Sensitivity Level rating according to the JEDEC industry standard classifications, and peak solder temperature.

(4) There may be additional marking, which relates to the logo, the lot trace code information, or the environmental category on the device.

(5) Multiple Device Markings will be inside parentheses. Only one Device Marking contained in parentheses and separated by a "~" will appear on a device. If a line is indented then it is a continuation of the previous line and the two combined represent the entire Device Marking for that device.

(6) Lead finish/Ball material - Orderable Devices may have multiple material finish options. Finish options are separated by a vertical ruled line. Lead finish/Ball material values may wrap to two lines if the finish value exceeds the maximum column width.

**Important Information and Disclaimer:**The information provided on this page represents TI's knowledge and belief as of the date that it is provided. TI bases its knowledge and belief on information provided by third parties, and makes no representation or warranty as to the accuracy of such information. Efforts are underway to better integrate information from third parties. TI has taken and continues to take reasonable steps to provide representative and accurate information but may not have conducted destructive testing or chemical analysis on incoming materials and chemicals. TI and TI suppliers consider certain information to be proprietary, and thus CAS numbers and other limited information may not be available for release.

In no event shall TI's liability arising out of such information exceed the total purchase price of the TI part(s) at issue in this document sold by TI to Customer on an annual basis.



**TAPE AND REEL INFORMATION**

**QUADRANT ASSIGNMENTS FOR PIN 1 ORIENTATION IN TAPE**

\*All dimensions are nominal

| Device       | Package Type | Package Drawing | Pins | SPQ  | Reel Diameter (mm) | Reel Width W1 (mm) | A0 (mm) | B0 (mm) | K0 (mm) | P1 (mm) | W (mm) | Pin1 Quadrant |
|--------------|--------------|-----------------|------|------|--------------------|--------------------|---------|---------|---------|---------|--------|---------------|
| TPS65288RHAR | VQFN         | RHA             | 40   | 2500 | 330.0              | 16.4               | 6.3     | 6.3     | 1.1     | 12.0    | 16.0   | Q2            |
| TPS65288RHAT | VQFN         | RHA             | 40   | 250  | 180.0              | 16.4               | 6.3     | 6.3     | 1.1     | 12.0    | 16.0   | Q2            |

**TAPE AND REEL BOX DIMENSIONS**

\*All dimensions are nominal

| Device       | Package Type | Package Drawing | Pins | SPQ  | Length (mm) | Width (mm) | Height (mm) |
|--------------|--------------|-----------------|------|------|-------------|------------|-------------|
| TPS65288RHAR | VQFN         | RHA             | 40   | 2500 | 367.0       | 367.0      | 38.0        |
| TPS65288RHAT | VQFN         | RHA             | 40   | 250  | 210.0       | 185.0      | 35.0        |

## GENERIC PACKAGE VIEW

**RHA 40**

**VQFN - 1 mm max height**

6 x 6, 0.5 mm pitch

PLASTIC QUAD FLATPACK - NO LEAD

This image is a representation of the package family, actual package may vary.  
Refer to the product data sheet for package details.



4225870/A



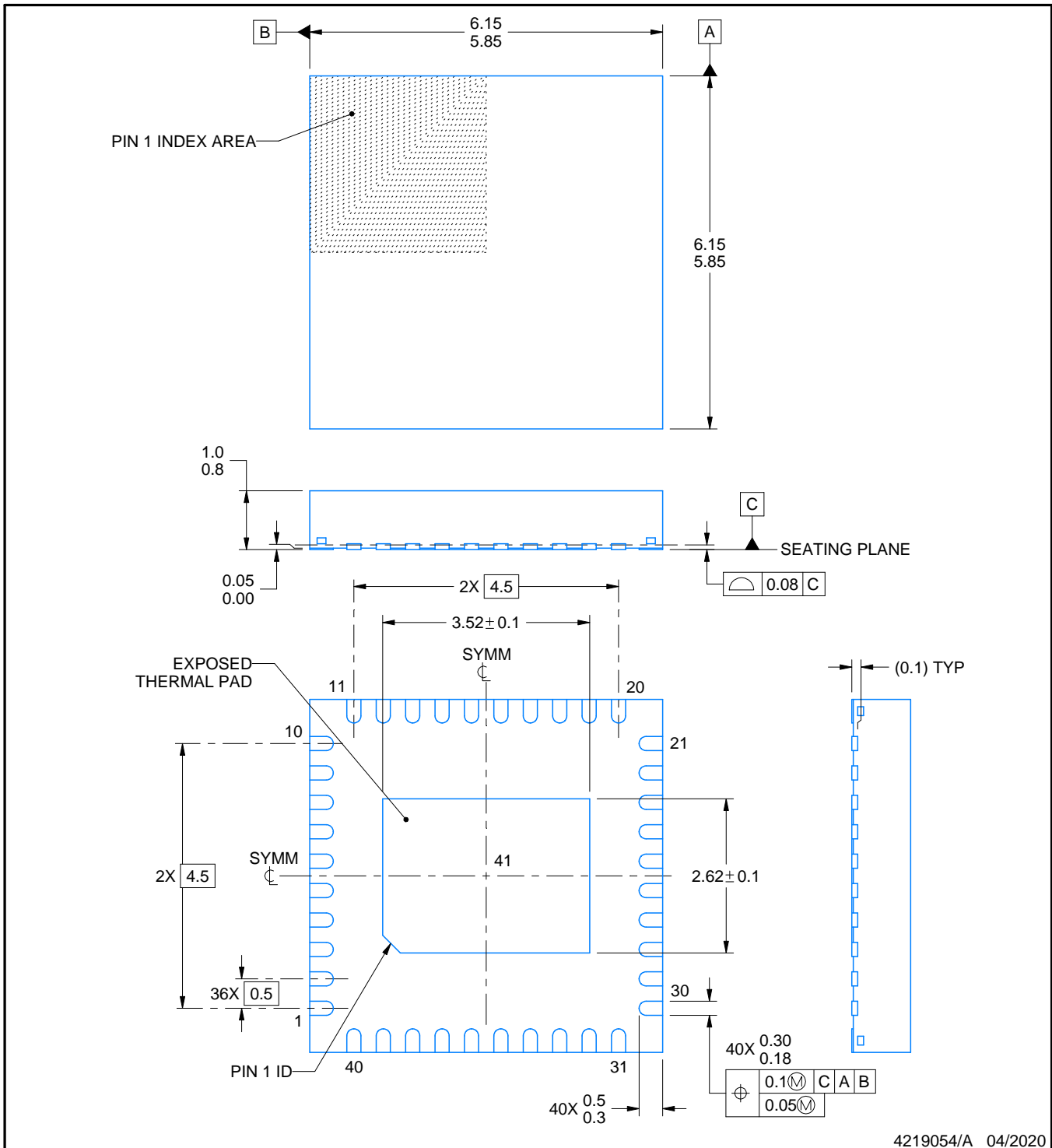
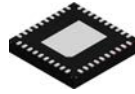

4219054/A 04/2020

NOTES:

1. All linear dimensions are in millimeters. Any dimensions in parenthesis are for reference only. Dimensioning and tolerancing per ASME Y14.5M.
2. This drawing is subject to change without notice.
3. The package thermal pad must be soldered to the printed circuit board for thermal and mechanical performance.

# EXAMPLE BOARD LAYOUT

RHA0040E

VQFN - 1 mm max height

PLASTIC QUAD FLATPACK - NO LEAD

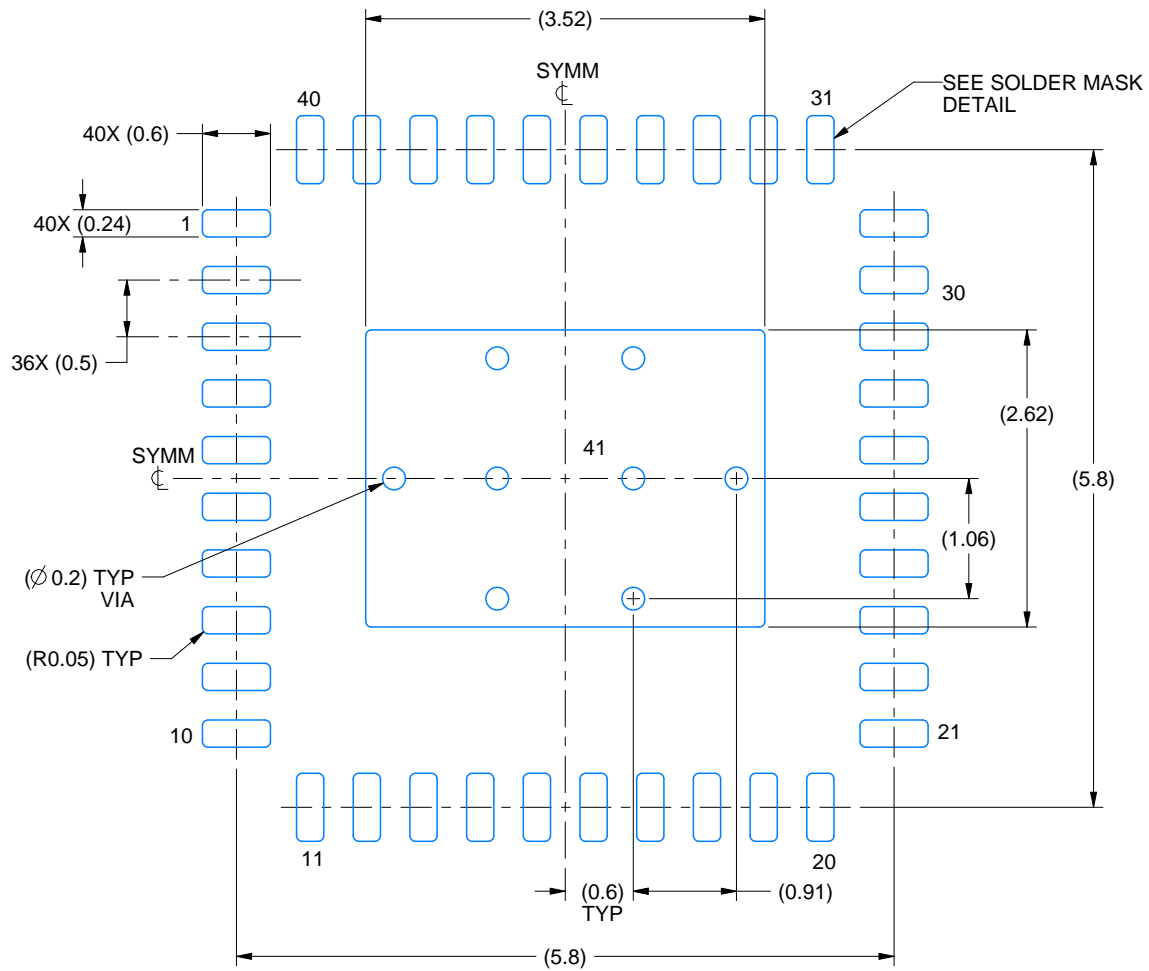

LAND PATTERN EXAMPLE  
EXPOSED METAL SHOWN  
SCALE: 15X

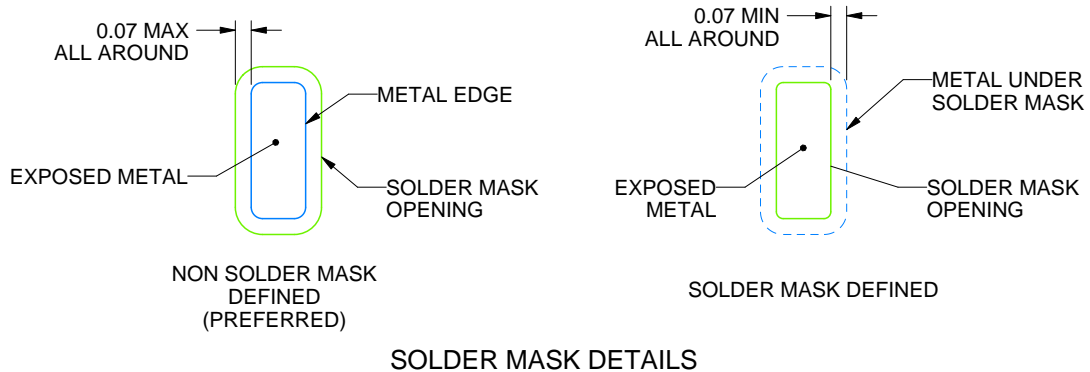

4219054/A 04/2020

NOTES: (continued)

4. This package is designed to be soldered to a thermal pad on the board. For more information, see Texas Instruments literature number SLUA271 ([www.ti.com/lit/sluea271](http://www.ti.com/lit/sluea271)).
5. Vias are optional depending on application, refer to device data sheet. If any vias are implemented, refer to their locations shown on this view. It is recommended that vias under paste be filled, plugged or tented.

# EXAMPLE STENCIL DESIGN

RHA0040E

VQFN - 1 mm max height

PLASTIC QUAD FLATPACK - NO LEAD

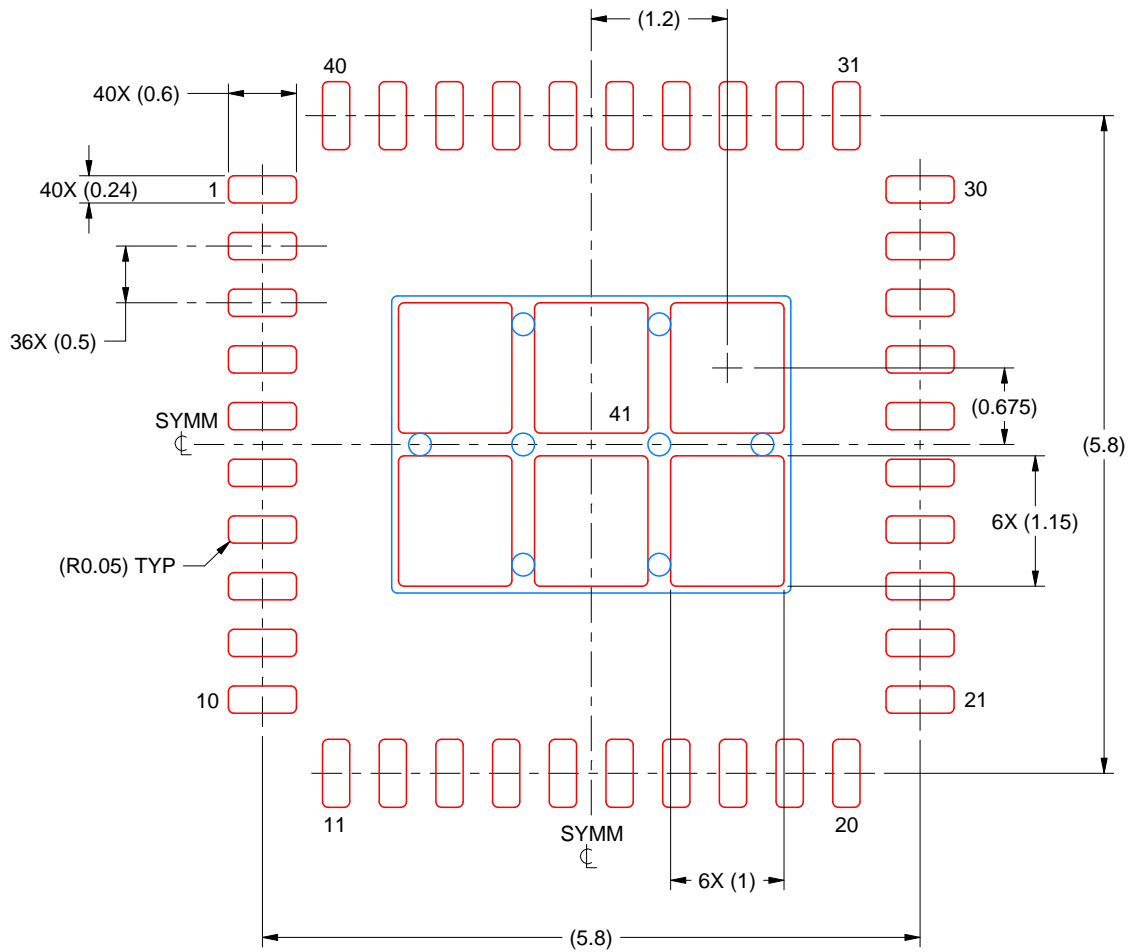

SOLDER PASTE EXAMPLE  
 BASED ON 0.125 MM THICK STENCIL  
 SCALE: 15X

EXPOSED PAD 41  
 75% PRINTED SOLDER COVERAGE BY AREA UNDER PACKAGE

4219054/A 04/2020

NOTES: (continued)

6. Laser cutting apertures with trapezoidal walls and rounded corners may offer better paste release. IPC-7525 may have alternate design recommendations.

## IMPORTANT NOTICE AND DISCLAIMER

TI PROVIDES TECHNICAL AND RELIABILITY DATA (INCLUDING DATASHEETS), DESIGN RESOURCES (INCLUDING REFERENCE DESIGNS), APPLICATION OR OTHER DESIGN ADVICE, WEB TOOLS, SAFETY INFORMATION, AND OTHER RESOURCES "AS IS" AND WITH ALL FAULTS, AND DISCLAIMS ALL WARRANTIES, EXPRESS AND IMPLIED, INCLUDING WITHOUT LIMITATION ANY IMPLIED WARRANTIES OF MERCHANTABILITY, FITNESS FOR A PARTICULAR PURPOSE OR NON-INFRINGEMENT OF THIRD PARTY INTELLECTUAL PROPERTY RIGHTS.

These resources are intended for skilled developers designing with TI products. You are solely responsible for (1) selecting the appropriate TI products for your application, (2) designing, validating and testing your application, and (3) ensuring your application meets applicable standards, and any other safety, security, or other requirements. These resources are subject to change without notice. TI grants you permission to use these resources only for development of an application that uses the TI products described in the resource. Other reproduction and display of these resources is prohibited. No license is granted to any other TI intellectual property right or to any third party intellectual property right. TI disclaims responsibility for, and you will fully indemnify TI and its representatives against, any claims, damages, costs, losses, and liabilities arising out of your use of these resources.

TI's products are provided subject to TI's Terms of Sale (<https://www.ti.com/legal/termsofsale.html>) or other applicable terms available either on [ti.com](https://www.ti.com) or provided in conjunction with such TI products. TI's provision of these resources does not expand or otherwise alter TI's applicable warranties or warranty disclaimers for TI products.

Mailing Address: Texas Instruments, Post Office Box 655303, Dallas, Texas 75265  
Copyright © 2021, Texas Instruments Incorporated