

DS15EA101 0.15 to 1.5 Gbps Adaptive Cable Equalizer with LOS Detection

Check for Samples: [DS15EA101](#)

FEATURES

- Automatic Equalization of Coaxial, Twin-Ax and Twisted Pair Cables
- High Data Rates: 150 Mbps to 1.5+ Gbps
- Up to 35 dB of Boost at 750 MHz
- LOS Detection and Output Enable
- Single-Ended or Differential Input
- 50Ω Differential Outputs
- Low Power Operation, 210 mW (typ) at 1.5 Gbps
- Industrial -40°C to +85°C Temperature
- Space-Saving 4 x 4 mm WQFN-16 Package

APPLICATIONS

- Cable Extention Applications
- Security Cameras
- Remote LCDs and LED Panels
- Data Recovery Equalization

DESCRIPTION

The DS15EA101 is an adaptive equalizer optimized for equalizing data transmitted over copper cables. The DS15EA101 operates over a wide range of data rates from 150 Mbps to 1.5+ Gbps and automatically adapts to equalize any cable length from zero meters to lengths that attenuate the signal by 35 dB at 750 MHz.

The DS15EA101 allows either single-ended or differential input drive. This enables equalization of coaxial cables as well as differential twin-ax and twisted pair cables.

Additional features include an LOS output and an output enable which, when tied together, disable the output when no signal is present.

The DS15EA101 is powered from a single 3.3V supply and consumes 210 mW at 1.5 Gbps. It operates over the full -40°C to +85°C industrial temperature range and is available in a space saving 4 x 4 mm WQFN-16 package which allows for high density placement of components in multi-channel applications.

Typical Application

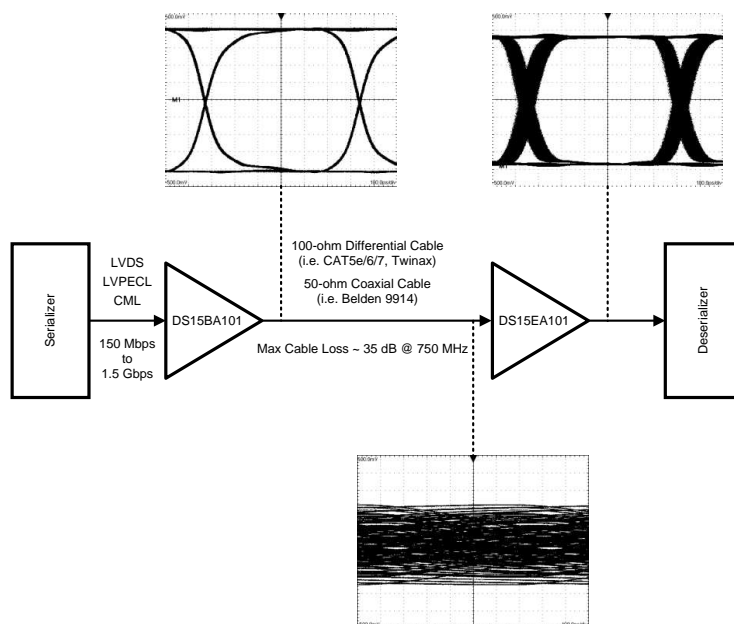

Please be aware that an important notice concerning availability, standard warranty, and use in critical applications of Texas Instruments semiconductor products and disclaimers thereto appears at the end of this data sheet.

All trademarks are the property of their respective owners.



These devices have limited built-in ESD protection. The leads should be shorted together or the device placed in conductive foam during storage or handling to prevent electrostatic damage to the MOS gates.

Absolute Maximum Ratings⁽¹⁾

Supply Voltage	-0.5V to 3.6V
Input Voltage (all inputs)	-0.3V to $V_{CC}+0.3V$
Storage Temperature Range	-65°C to +150°C
Junction Temperature	+150°C
Lead Temperature (Soldering 4 Sec)	+260°C
Package Thermal Resistance θ_{JA} RGH0016A θ_{JC} RGH0016A	+42.1°C/W +8.2°C/W
ESD Rating (HBM)	8 kV
ESD Rating (MM)	250V

- (1) "Absolute Maximum Ratings" are those parameter values beyond which the life and operation of the device cannot be ensured. The stating herein of these maximums shall not be construed to imply that the device can or should be operated at or beyond these values. The table of [Electrical Characteristics](#) specifies acceptable device operating conditions.

Recommended Operating Conditions

Supply Voltage (V_{CC})	3.3V $\pm 5\%$
Input Coupling Capacitance	1.0 μF
Loop Capacitor (Connected between CAP+ and CAP-)	1.0 μF
Operating Free Air Temperature (T_A)	-40°C to +85°C

DC Electrical Characteristics

Over Supply Voltage and Operating Temperature ranges, unless otherwise specified ⁽¹⁾ ⁽²⁾.

Symbol	Parameter	Conditions	Reference	Min	Typ	Max	Units
V_{CM}	Input Common Mode Voltage		IN+, IN-		1.9		V
V_{IN}	Input Voltage					⁽³⁾ ⁽⁴⁾ 950	mV _{P-P}
V_{OS}	Output Common Mode Voltage		OUT+, OUT-		$V_{CC} - V_{OUT}/2$		V
V_{OUT}	Output Voltage Swing	50 Ω load, differential			750		mV _{P-P}
V_{LOS}	LOS Output Voltage	Valid signal not present	LOS	2.6			V
		Valid signal present				0.4	V
$V_{IN(EN)}$	\overline{EN} Input Voltage	Min to disable outputs	\overline{EN}	3.0			V
		Max to enable outputs				0.8	V
I_{CC}	Supply Current	⁽⁵⁾			63	77	mA

- (1) Current flow into device pins is defined as positive. Current flow out of device pins is defined as negative. All voltages are stated referenced to 0 volts.
 (2) Typical values are stated for $V_{CC} = +3.3V$ and $T_A = +25^\circ C$.
 (3) Specification is ensured by characterization.
 (4) The maximum input voltage amplitude assumes a DC-balanced signal.
 (5) Supply current depends on the amount of cable being equalized. The current is highest for short cable and decreases as the cable length is increased.

AC Electrical Characteristics

Over Supply Voltage and Operating Temperature ranges, unless otherwise specified ⁽¹⁾.

Symbol	Parameter	Conditions	Reference	Min	Typ	Max	Units
BR _{IN}	Input Data Rate		IN+, IN-	150		1500	Mbps
t _{TRJ}	Total Residual Jitter @ BER-12 ⁽²⁾	1.5 Gbps 25m CAT5e (Belden 1700A), ⁽¹⁾			0.25		UI
		1.0 Gbps 50m CAT5e (Belden 1700A), ⁽¹⁾			0.25		UI
		0.5 Gbps 100m CAT5e (Belden 1700A), ⁽¹⁾			0.25		UI
		1.5 Gbps 50m CAT7 (Siemon Tera), ⁽¹⁾			0.25		UI
		1.5 Gbps 75m CAT7 (Siemon Tera), ⁽¹⁾			0.30		UI
		1.0 Gbps 100m CAT7 (Siemon Tera), ⁽¹⁾			0.40		UI
		1.5 Gbps 200m Belden 9914, ⁽¹⁾			0.25		UI
t _{TLH}	Transition Time from Low to High	20% – 80%, ⁽³⁾	OUT+, OUT-		100	220	ps
t _{THL}	Transition Time from High to Low	20% – 80%, ⁽³⁾			100	220	ps
R _{OUT}	Output Resistance	single-ended, ⁽⁴⁾			50		Ω

(1) Typical values are stated for V_{CC} = +3.3V and T_A = +25°C.

(2) The total residual jitter at BER-12 was calculated as DJ+14.1xRJ, where DJ is deterministic jitter and RJ is random jitter. The jitter is expressed as a portion of a unit interval (UI). One UI is a reciprocal of a bit rate (or data rate). For example, a 1.5 Gbps (gigabit per second) signal has 1 / (1.5 Gb/s) = 666.67 ps (picosecond) unit interval. A 0.25 UI jitter is equivalent to 0.25 x 666.67 ps = 166.67 ps.

(3) Specification is ensured by characterization.

(4) Specification is ensured by design.

CONNECTION DIAGRAM

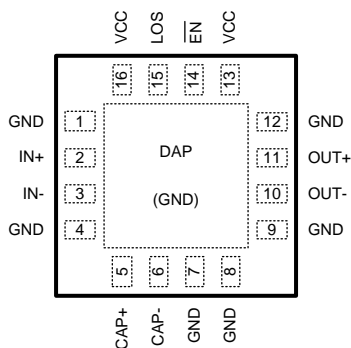

16-Pad WQFN
Package Number RGH0016A

PIN DESCRIPTIONS

Pin #	Name	Description
1	GND	Ground pin.
2	IN+	Non-inverting input pin.
3	IN-	Inverting input pin.
4	GND	Ground pin.
5	CAP+	Loop filter positive pin.
6	CAP-	Loop filter negative pin.
7	GND	Ground pin.
8	GND	Ground pin.
9	GND	Ground pin.
10	OUT-	Inverting output pin.
11	OUT+	Non-inverting output pin.
12	GND	Ground pin.
13	VCC	Power supply pin.
14	$\overline{\text{EN}}$	Output enable pin.
15	LOS	Los of signal circuitry output pin.
16	VCC	Power supply pin.

DEVICE OPERATION

Input Interfacing

The DS15EA101 accepts either differential or single-ended input. The input must be AC coupled. Transformer coupling is not supported. If the signal is differential, its amplitude must be 800 mVp-p $\pm 10\%$ (400 mV single-ended). If the signal is single-ended, its amplitude must be 800 mV $\pm 10\%$.

Output Interfacing

The DS15EA101 uses current mode outputs. They are internally terminated with 50 Ω . The following two figures illustrate typical DC-coupled interface to common differential receivers and assume that the receivers have high impedance inputs. While most receivers have an input common mode voltage range that can accommodate CML signals, it is recommended to check respective receiver's datasheet prior to implementing the suggested interface implementations.

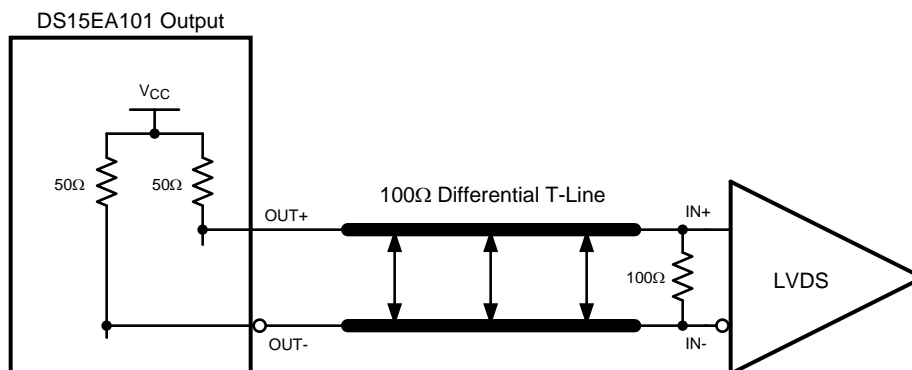

Figure 1. Typical DS15EA101 Output DC-Coupled Interface to an LVDS Receiver

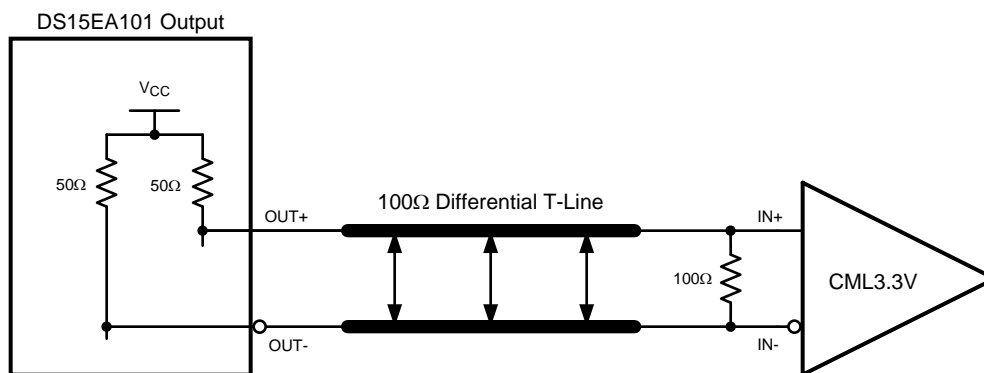

Figure 2. Typical DS15EA101 Output DC-Coupled Interface to a CML Receiver

Cable Extender Application

The DS15EA101 together with the DS15BA101 form a cable extender chipset optimized for extending serial data streams from serializer/deserializer (SerDes) pairs and field programmable gate arrays (FPGAs) over 100 Ω differential (i.e. CAT5e/6/7 and twinax) and 50 Ω coaxial cables. Setting correct DS15BA101 output amplitude and proper cable termination are keys for optimal operation. The following two figures show recommended chipset configuration for 100 Ω differential and 50 Ω coaxial cables.

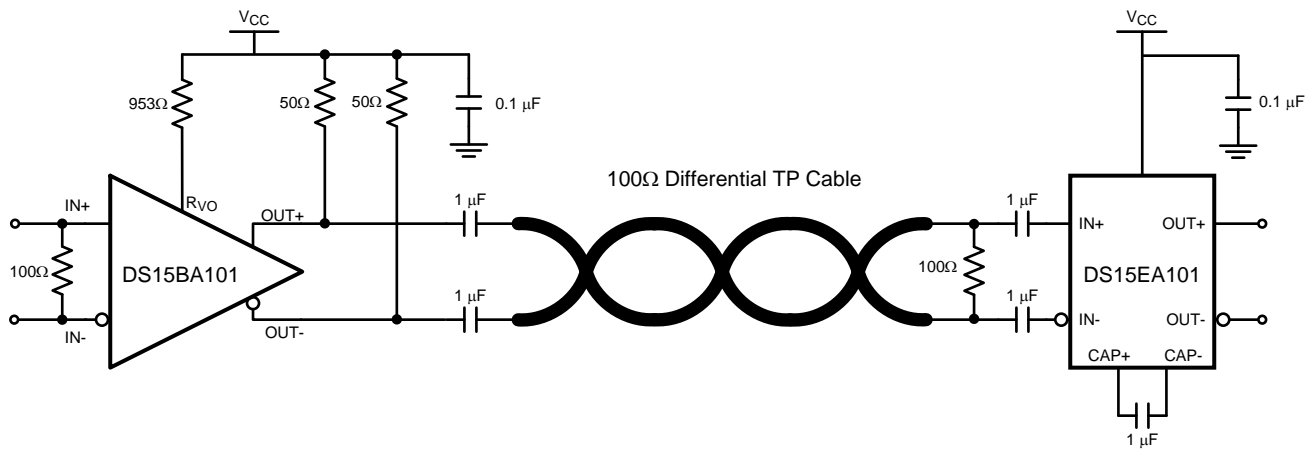

Figure 3. Cable Extender Chipset Connection Diagram for 100Ω Differential Cables

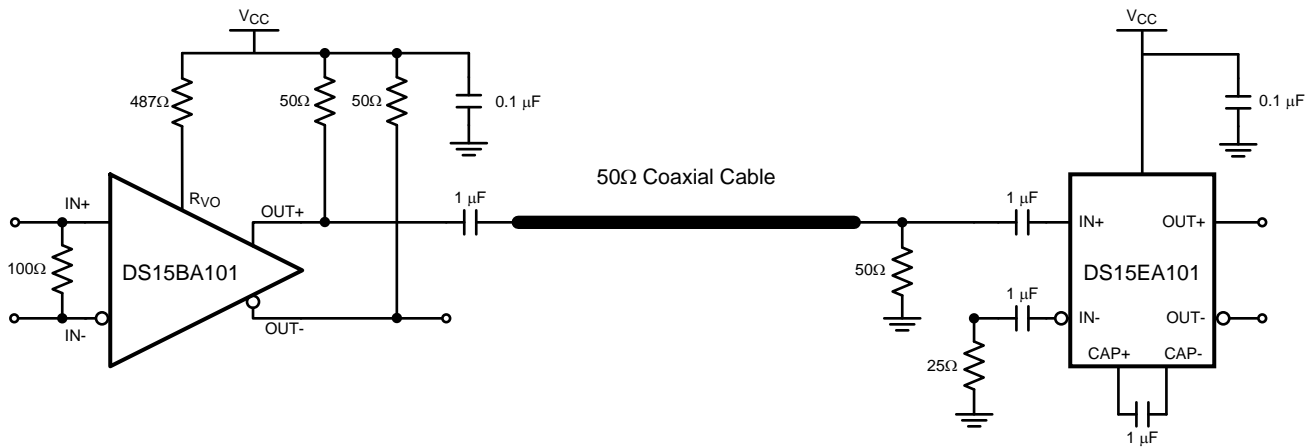

Figure 4. Cable Extender Chipset Connection Diagram for 50Ω Coaxial Cables

Reference Design

There is a complete reference design (P/N: DriveCable02EVK) available for evaluation of the cable extender chipset (DS15BA101 and DS15EA101).

For more information visit <http://www.ti.com/tool/drivecable02evk>

Typical Performance

Maximum Data Rate as a Function of CAT7 (Siemon CAT7 Tera) Length

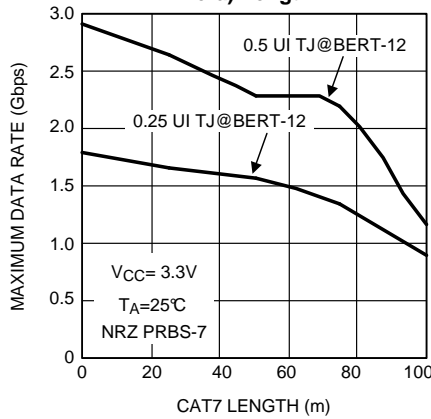

Figure 5.

Maximum Data Rate as a Function of CAT5e (Belden 1700A) Length

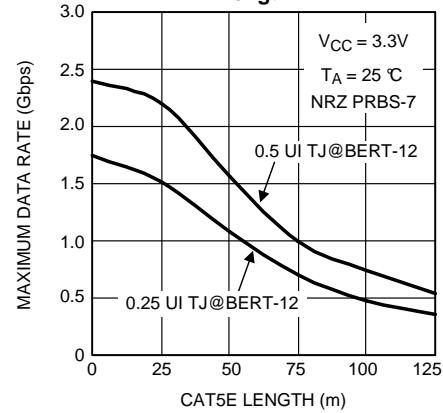

Figure 6.

Maximum Data Rate as a Function of 50Ω Coaxial (Belden 9914) Length

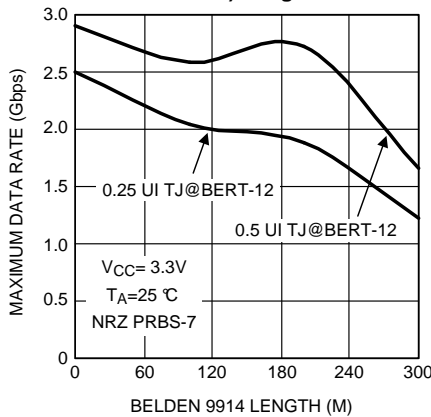

Figure 7.

Residual Jitter as a Function of Data Rate and Temperature for the Chipset with 50m CAT5e

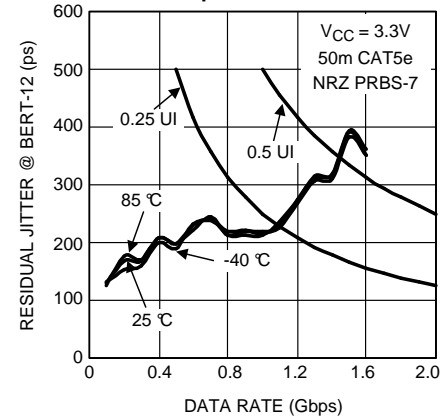

Figure 8.

Residual Jitter as a Function of Data Rate and Temperature for the Chipset with 75m CAT5e

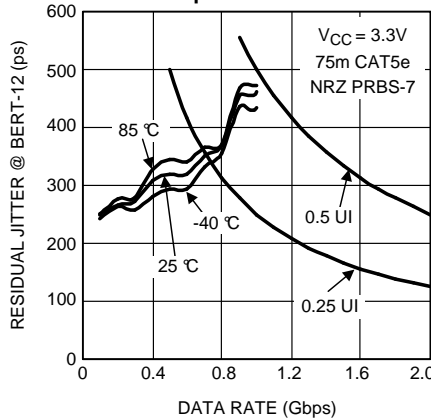

Figure 9.

Residual Jitter as a Function of Data Rate and Temperature for the Chipset with 100m CAT5e

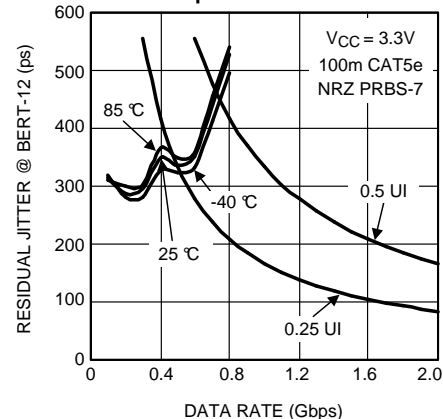

Figure 10.

Typical Performance (continued)

A 1.5 Gbps NRZ PRBS-7 After 25m CAT5e
V:100 mV / DIV, H:100 ps / DIV

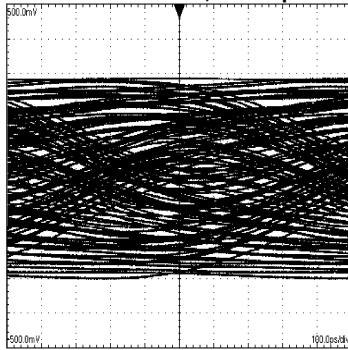

Figure 11.

An Equalized 1.5 Gbps NRZ PRBS-7 After 25m CAT5e
V:100 mV / DIV, H:100 ps / DIV

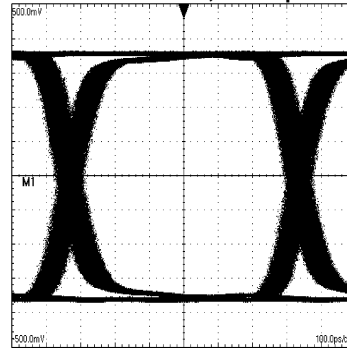

Figure 12.

A 1.0 Gbps NRZ PRBS-7 After 50m CAT5e
V:100 mV / DIV, H:150 ps / DIV

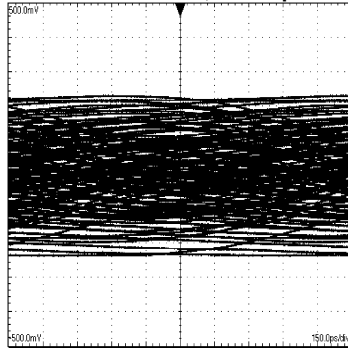

Figure 13.

An Equalized 1.0 Gbps NRZ PRBS-7 After 50m CAT5e
V:100 mV / DIV, H:150 ps / DIV

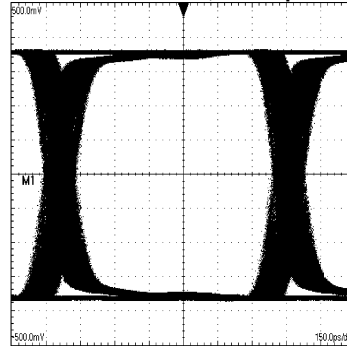

Figure 14.

A 0.5 Gbps NRZ PRBS-7 After 100m CAT5e
V:100 mV / DIV, H:400 ps / DIV

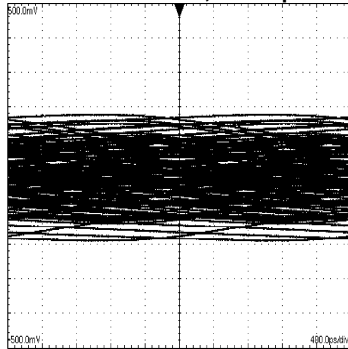

Figure 15.

An Equalized 0.5 Gbps NRZ PRBS-7 After 100m CAT5e
V:100 mV / DIV, H:400 ps / DIV

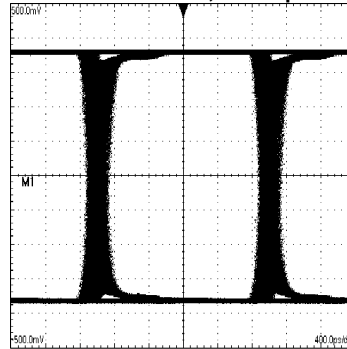

Figure 16.

Typical Performance (continued)

A 1.5 Gbps NRZ PRBS-7 After 50m CAT7
V:100 mV / DIV, H:100 ps / DIV

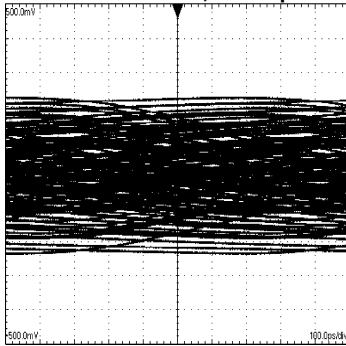

Figure 17.

An Equalized 1.5 Gbps NRZ PRBS-7 After 50m CAT7
V:100 mV / DIV, H:100 ps / DIV

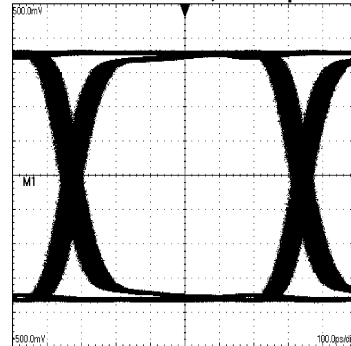

Figure 18.

An Equalized 1.5 Gbps NRZ PRBS-7 After 75m CAT7
V:100 mV / DIV, H:100 ps / DIV

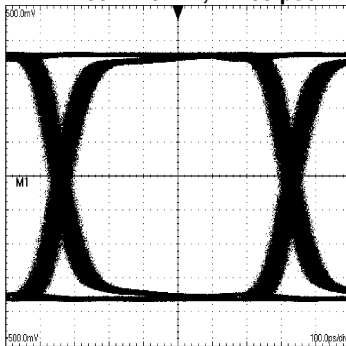

Figure 19.

A 1.5 Gbps NRZ PRBS-7 After 75m CAT7
V:100 mV / DIV, H:100 ps / DIV

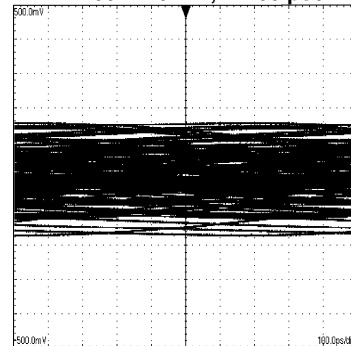

Figure 20.

A 1.0 Gbps NRZ PRBS-7 After 100m CAT7
V:100 mV / DIV, H:150 ps / DIV

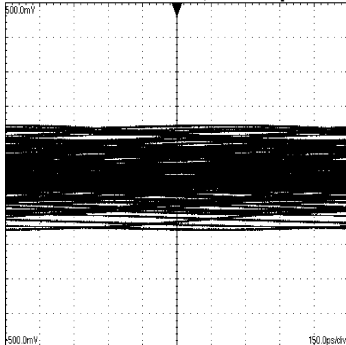

Figure 21.

An Equalized 1.0 Gbps NRZ PRBS-7 After 100m CAT7
V:100 mV / DIV, H:150 ps / DIV

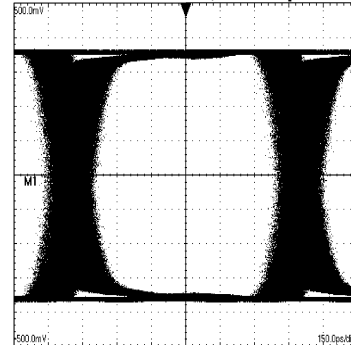

Figure 22.

Typical Performance (continued)

A 1.5 Gbps NRZ PRBS-7 After 200m Belden 9914
V:100 mV / DIV, H:100 ps / DIV

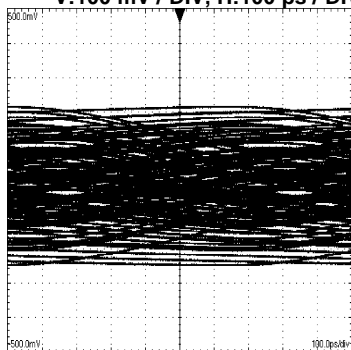

Figure 23.

An Equalized 1.5 Gbps NRZ PRBS-7 After 200m Belden 9914, V:100 mV / DIV, H:100 ps / DIV

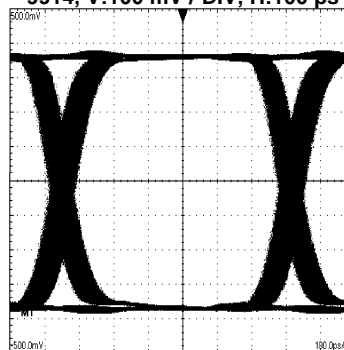

Figure 24.

REVISION HISTORY

Changes from Revision G (April 2013) to Revision H	Page
<hr/> <ul style="list-style-type: none">• Changed layout of National Data Sheet to TI format	<hr/> 10

PACKAGING INFORMATION

Orderable Device	Status (1)	Package Type	Package Drawing	Pins	Package Qty	Eco Plan (2)	Lead finish/ Ball material (6)	MSL Peak Temp (3)	Op Temp (°C)	Device Marking (4/5)	Samples
DS15EA101SQ/NOPB	ACTIVE	WQFN	RGH	16	1000	RoHS & Green	SN	Level-3-260C-168 HR	-40 to 85	15EA101	Samples
DS15EA101SQE/NOPB	ACTIVE	WQFN	RGH	16	250	RoHS & Green	SN	Level-3-260C-168 HR	-40 to 85	15EA101	Samples

(1) The marketing status values are defined as follows:

ACTIVE: Product device recommended for new designs.

LIFEBUY: TI has announced that the device will be discontinued, and a lifetime-buy period is in effect.

NRND: Not recommended for new designs. Device is in production to support existing customers, but TI does not recommend using this part in a new design.

PREVIEW: Device has been announced but is not in production. Samples may or may not be available.

OBsolete: TI has discontinued the production of the device.

(2) **RoHS:** TI defines "RoHS" to mean semiconductor products that are compliant with the current EU RoHS requirements for all 10 RoHS substances, including the requirement that RoHS substance do not exceed 0.1% by weight in homogeneous materials. Where designed to be soldered at high temperatures, "RoHS" products are suitable for use in specified lead-free processes. TI may reference these types of products as "Pb-Free".

RoHS Exempt: TI defines "RoHS Exempt" to mean products that contain lead but are compliant with EU RoHS pursuant to a specific EU RoHS exemption.

Green: TI defines "Green" to mean the content of Chlorine (Cl) and Bromine (Br) based flame retardants meet JS709B low halogen requirements of <=1000ppm threshold. Antimony trioxide based flame retardants must also meet the <=1000ppm threshold requirement.

(3) MSL, Peak Temp. - The Moisture Sensitivity Level rating according to the JEDEC industry standard classifications, and peak solder temperature.

(4) There may be additional marking, which relates to the logo, the lot trace code information, or the environmental category on the device.

(5) Multiple Device Markings will be inside parentheses. Only one Device Marking contained in parentheses and separated by a "~" will appear on a device. If a line is indented then it is a continuation of the previous line and the two combined represent the entire Device Marking for that device.

(6) Lead finish/Ball material - Orderable Devices may have multiple material finish options. Finish options are separated by a vertical ruled line. Lead finish/Ball material values may wrap to two lines if the finish value exceeds the maximum column width.

Important Information and Disclaimer:The information provided on this page represents TI's knowledge and belief as of the date that it is provided. TI bases its knowledge and belief on information provided by third parties, and makes no representation or warranty as to the accuracy of such information. Efforts are underway to better integrate information from third parties. TI has taken and continues to take reasonable steps to provide representative and accurate information but may not have conducted destructive testing or chemical analysis on incoming materials and chemicals. TI and TI suppliers consider certain information to be proprietary, and thus CAS numbers and other limited information may not be available for release.

In no event shall TI's liability arising out of such information exceed the total purchase price of the TI part(s) at issue in this document sold by TI to Customer on an annual basis.

TAPE AND REEL INFORMATION

QUADRANT ASSIGNMENTS FOR PIN 1 ORIENTATION IN TAPE

*All dimensions are nominal

Device	Package Type	Package Drawing	Pins	SPQ	Reel Diameter (mm)	Reel Width W1 (mm)	A0 (mm)	B0 (mm)	K0 (mm)	P1 (mm)	W (mm)	Pin1 Quadrant
DS15EA101SQ/NOPB	WQFN	RGH	16	1000	178.0	12.4	4.3	4.3	1.3	8.0	12.0	Q1
DS15EA101SQE/NOPB	WQFN	RGH	16	250	178.0	12.4	4.3	4.3	1.3	8.0	12.0	Q1

TAPE AND REEL BOX DIMENSIONS

*All dimensions are nominal

Device	Package Type	Package Drawing	Pins	SPQ	Length (mm)	Width (mm)	Height (mm)
DS15EA101SQ/NOPB	WQFN	RGH	16	1000	208.0	191.0	35.0
DS15EA101SQE/NOPB	WQFN	RGH	16	250	208.0	191.0	35.0

RGH (S-PQFP-N16)

PLASTIC QUAD FLATPACK

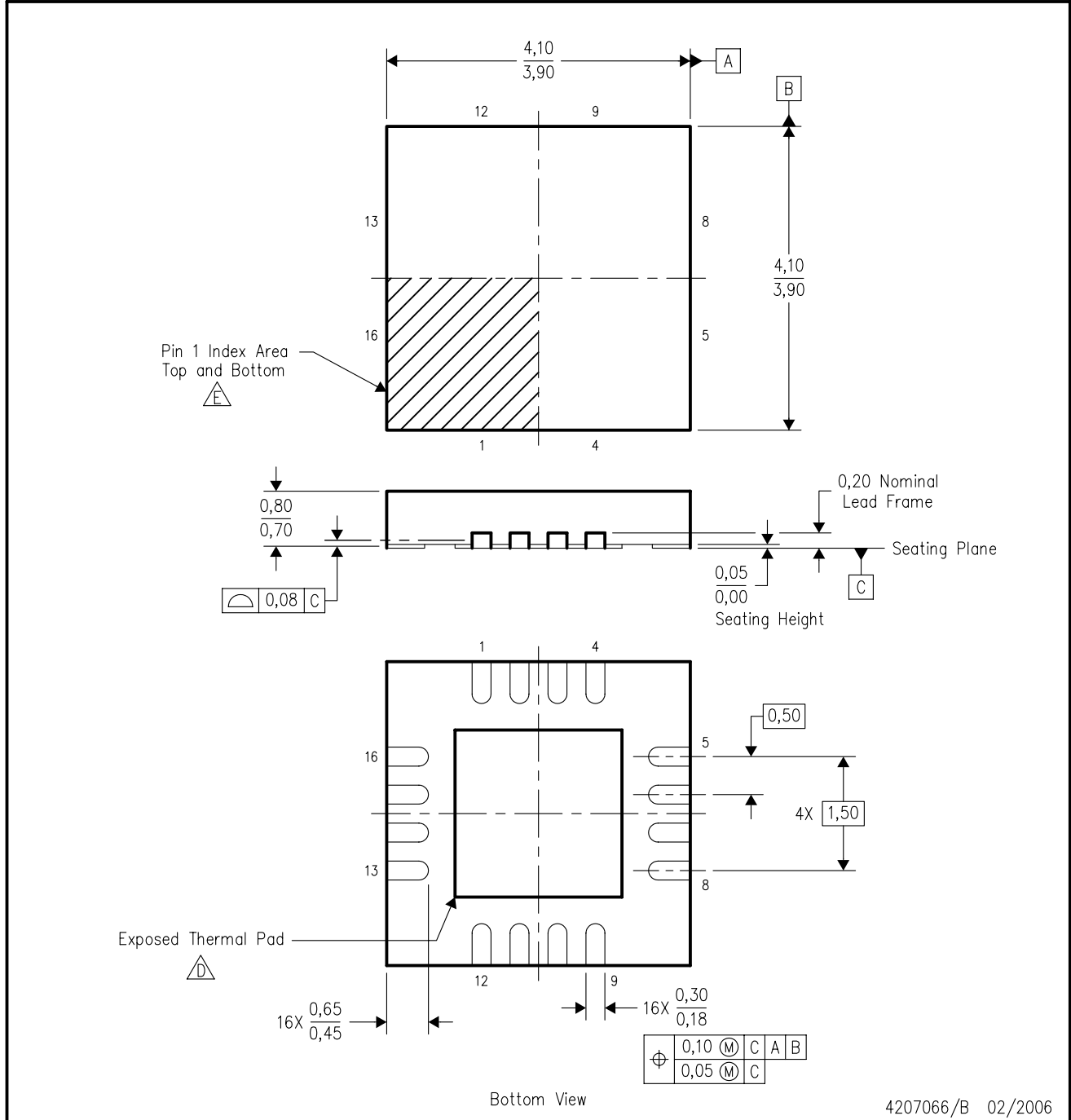

4207066/B 02/2006

- NOTES:
- A. All linear dimensions are in millimeters. Dimensioning and tolerancing per ASME Y14.5M-1994.
 - B. This drawing is subject to change without notice.
 - C. QFN (Quad Flatpack No-Lead) package configuration.
 - The package thermal pad must be soldered to the board for thermal and mechanical performance. See the Product Data Sheet for details regarding the exposed thermal pad dimensions.
 - Pin 1 identifiers are located on both top and bottom of the package and within the zone indicated. The Pin 1 identifiers are either a molded, marked, or metal feature.
 - F. Complies to JEDEC MO-220 variation WGGD-4.

IMPORTANT NOTICE AND DISCLAIMER

TI PROVIDES TECHNICAL AND RELIABILITY DATA (INCLUDING DATA SHEETS), DESIGN RESOURCES (INCLUDING REFERENCE DESIGNS), APPLICATION OR OTHER DESIGN ADVICE, WEB TOOLS, SAFETY INFORMATION, AND OTHER RESOURCES "AS IS" AND WITH ALL FAULTS, AND DISCLAIMS ALL WARRANTIES, EXPRESS AND IMPLIED, INCLUDING WITHOUT LIMITATION ANY IMPLIED WARRANTIES OF MERCHANTABILITY, FITNESS FOR A PARTICULAR PURPOSE OR NON-INFRINGEMENT OF THIRD PARTY INTELLECTUAL PROPERTY RIGHTS.

These resources are intended for skilled developers designing with TI products. You are solely responsible for (1) selecting the appropriate TI products for your application, (2) designing, validating and testing your application, and (3) ensuring your application meets applicable standards, and any other safety, security, regulatory or other requirements.

These resources are subject to change without notice. TI grants you permission to use these resources only for development of an application that uses the TI products described in the resource. Other reproduction and display of these resources is prohibited. No license is granted to any other TI intellectual property right or to any third party intellectual property right. TI disclaims responsibility for, and you will fully indemnify TI and its representatives against, any claims, damages, costs, losses, and liabilities arising out of your use of these resources.

TI's products are provided subject to [TI's Terms of Sale](#) or other applicable terms available either on [ti.com](https://www.ti.com) or provided in conjunction with such TI products. TI's provision of these resources does not expand or otherwise alter TI's applicable warranties or warranty disclaimers for TI products.

TI objects to and rejects any additional or different terms you may have proposed.

Mailing Address: Texas Instruments, Post Office Box 655303, Dallas, Texas 75265
Copyright © 2023, Texas Instruments Incorporated