

# LMZ12001 1-A SIMPLE SWITCHER® Power Module With 20-V Maximum Input Voltage

## 1 Features

- Integrated Shielded Inductor
- Simple PCB Layout
- Flexible Start-up Sequencing Using External Soft-start Capacitor and Precision Enable
- Protection Against Inrush Currents and Faults Such as Input UVLO and Output Short Circuit
- Junction Temperature Range  $-40^{\circ}\text{C}$  to  $125^{\circ}\text{C}$
- Single Exposed Pad and Standard Pinout for Easy Mounting and Manufacturing
- Fast Transient Response for FPGAs and ASICs
- Low Output Voltage Ripple
- Pin-to-Pin Compatible With Family Devices:
  - LMZ14203/2/1 (42-V Maximum 3 A, 2 A, 1 A)
  - LMZ12003/2/1 (20-V Maximum 3 A, 2 A, 1 A)
- Fully WEBENCH® Power Designer Enabled
- Electrical Specifications
  - 6-W Maximum Total Power Output
  - Up to 1-A Output Current
  - Input Voltage Range 4.5 V to 20 V
  - Output Voltage Range 0.8 V to 6 V
  - Efficiency up to 92%
- Performance Benefits
  - Operates at High Ambient Temperature with no Thermal Derating
  - High Efficiency Reduces System Heat Generation
  - Low Radiated Emissions (EMI) Tested to EN5022 Class B Standard
  - Low External Component Count

## 2 Applications

- Point-of-load Conversions from 5-V and 12-V Input Rail
- Time-Critical Projects
- Space Constrained High Thermal Requirement Applications
- Negative Output Voltage Applications (See AN-2027 [SNVA425](#))

## 3 Description

The LMZ12001 SIMPLE SWITCHER® power module is an easy-to-use step-down DC-DC solution capable of driving up to 1-A load with exceptional power conversion efficiency, line and load regulation, and output accuracy. The LMZ12001 is available in an innovative package that enhances thermal performance and allows for hand or machine soldering.

The LMZ12001 can accept an input voltage rail between 4.5 V and 20 V and can deliver an adjustable and highly accurate output voltage as low as 0.8 V. The LMZ12001 only requires three external resistors and four external capacitors to complete the power solution. The LMZ12001 is a reliable and robust design with the following protection features: thermal shutdown, input undervoltage lockout, output overvoltage protection, short circuit protection, output current limit, and the device allows start-up into a prebiased output. A single resistor adjusts the switching frequency up to 1 MHz.

### Device Information<sup>(1)(2)</sup>

PART NUMBER	PACKAGE	BODY SIZE (NOM)
LMZ12001	NDW (7)	10.16 mm x 9.85 mm

(1) For all available packages, see the orderable addendum at the end of the data sheet.

(2) Peak reflow temperature equals  $245^{\circ}\text{C}$ . See [SNAA214](#) for more details.

### Simplified Application Schematic

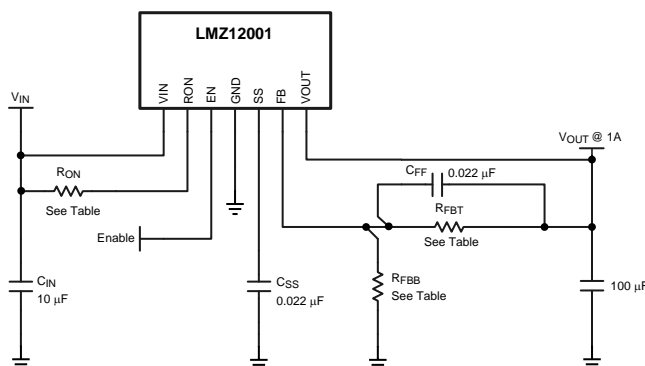

### Efficiency 5-V Input at 25°C

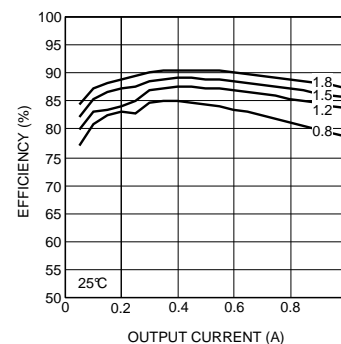

## Table of Contents

<b>1</b>	<b>Features</b> .....	<b>1</b>	<b>8</b>	<b>Application and Implementation</b> .....	<b>14</b>
<b>2</b>	<b>Applications</b> .....	<b>1</b>	8.1	Application Information.....	14
<b>3</b>	<b>Description</b> .....	<b>1</b>	8.2	Typical Application .....	14
<b>4</b>	<b>Revision History</b> .....	<b>2</b>	<b>9</b>	<b>Power Supply Recommendations</b> .....	<b>20</b>
<b>5</b>	<b>Pin Configuration and Functions</b> .....	<b>3</b>	<b>10</b>	<b>Layout</b> .....	<b>20</b>
<b>6</b>	<b>Specifications</b> .....	<b>3</b>	10.1	Layout Guidelines .....	20
6.1	Absolute Maximum Ratings .....	3	10.2	Layout Examples.....	21
6.2	ESD Ratings.....	3	10.3	Power Dissipation and Thermal Considerations...	22
6.3	Recommended Operating Conditions.....	4	10.4	Power Module SMT Guidelines .....	23
6.4	Thermal Information .....	4	<b>11</b>	<b>Device and Documentation Support</b> .....	<b>24</b>
6.5	Electrical Characteristics.....	4	11.1	Device Support.....	24
6.6	Typical Characteristics .....	6	11.2	Documentation Support .....	24
<b>7</b>	<b>Detailed Description</b> .....	<b>12</b>	11.3	Community Resources.....	24
7.1	Overview .....	12	11.4	Trademarks .....	24
7.2	Functional Block Diagram .....	12	11.5	Electrostatic Discharge Caution.....	24
7.3	Feature Description.....	12	11.6	Glossary .....	24
7.4	Device Functional Modes.....	13	<b>12</b>	<b>Mechanical, Packaging, and Orderable Information</b> .....	<b>25</b>

## 4 Revision History

NOTE: Page numbers for previous revisions may differ from page numbers in the current version.

Changes from Revision G (October 2013) to Revision H	Page
• Added <i>Pin Configuration and Functions</i> section, <i>ESD Ratings</i> table, <i>Feature Description</i> section, <i>Device Functional Modes</i> , <i>Application and Implementation</i> section, <i>Power Supply Recommendations</i> section, <i>Layout</i> section, <i>Device and Documentation Support</i> section, and <i>Mechanical, Packaging, and Orderable Information</i> section .....	1
• Removed Easy-To-Use 7-Pin Package PFM 7-Pin Package image.....	1

Changes from Revision F (March 2013) to Revision G	Page
• Deleted 12 mil.....	5
• Changed 10 mills .....	20
• Changed 10 mills.....	23
• Added <i>Power Module SMT Guidelines</i> .....	23

## 5 Pin Configuration and Functions

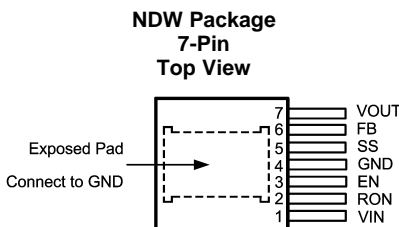

### Pin Functions

PIN		TYPE	DESCRIPTION
NAME	NO.		
EN	3	Analog	Enable — Input to the precision enable comparator. Rising threshold is 1.18-V nominal; 90-mV hysteresis nominal. Maximum recommended input level is 6.5 V.
EP	—	Ground	Exposed Pad — Internally connected to pin 4. Used to dissipate heat from the package during operation. Must be electrically connected to pin 4 external to the package.
FB	6	Analog	Feedback — Internally connected to the regulation, overvoltage, and short circuit comparators. The regulation reference point is 0.8 V at this input pin. Connected the feedback resistor divider between the output and ground to set the output voltage.
GND	4	Ground	Ground — Reference point for all stated voltages. Must be externally connected to EP.
RON	2	Analog	ON-Time Resistor — An external resistor from $V_{IN}$ to this pin sets the ON-time of the application. Typical values range from 25 k $\Omega$ to 124 k $\Omega$ .
SS	5	Analog	Soft-Start — An internal 8- $\mu$ A current source charges an external capacitor to produce the soft-start function. This node is discharged at 200 $\mu$ A during disable, overcurrent, thermal shutdown and internal UVLO conditions.
VIN	1	Power	Supply input — Nominal operating range is 4.5 V to 20 V. A small amount of internal capacitance is contained within the package assembly. Additional external input capacitance is required between this pin and exposed pad.
VOUT	7	Power	Output Voltage — Output from the internal inductor. Connect the output capacitor between this pin and exposed pad.

## 6 Specifications

### 6.1 Absolute Maximum Ratings

over operating free-air temperature range (unless otherwise noted) <sup>(1)(2)(3)</sup>

	MIN	MAX	UNIT
VIN, RON to GND	-0.3	25	V
EN, FB, SS to GND	-0.3	7	V
Junction Temperature		150	°C
Peak Reflow Case Temperature (30 sec)		245	°C
Storage Temperature, $T_{stg}$	-65	150	°C

- Stresses beyond those listed under *Absolute Maximum Ratings* may cause permanent damage to the device. These are stress ratings only, which do not imply functional operation of the device at these or any other conditions beyond those indicated under *Recommended Operating Conditions*. Exposure to absolute-maximum-rated conditions for extended periods may affect device reliability.
- If Military/Aerospace specified devices are required, please contact the Texas Instruments Sales Office/ Distributors for availability and specifications.
- For soldering specifications, refer to the following document: [SNOA549](#)

### 6.2 ESD Ratings

	VALUE	UNIT
$V_{(ESD)}$ Electrostatic discharge Human body model (HBM), per ANSI/ESDA/JEDEC JS-001 <sup>(1)</sup>	±2000	V

- JEDEC document JEP155 states that 500-V HBM allows safe manufacturing with a standard ESD control process.

# LMZ12001

SNVS651H – JANUARY 2010 – REVISED AUGUST 2015

www.ti.com

## 6.3 Recommended Operating Conditions

over operating free-air temperature range (unless otherwise noted)

	MIN	MAX	UNIT
V <sub>IN</sub>	4.5	20	V
EN	0	6.5	V
Operation junction temperature	-40	125	°C

## 6.4 Thermal Information

THERMAL METRIC <sup>(1)</sup>		LMZ12001		UNIT
		NDW		
		7 PINS		
R <sub>θJA</sub>	Junction-to-ambient thermal resistance	4-layer JEDEC Printed-Circuit-Board, No air flow		19.3
		2-layer JEDEC Printed-Circuit-Board, No air flow		21.5
R <sub>θJC(top)</sub>	Junction-to-case (top) thermal resistance			1.9

(1) For more information about traditional and new thermal metrics, see the *Semiconductor and IC Package Thermal Metrics* application report, [SPRA953](#).

## 6.5 Electrical Characteristics

Limits in standard type are for T<sub>J</sub> = 25°C unless otherwise specified. Minimum and Maximum limits are specified through test, design or statistical correlation. Typical values represent the most likely parametric norm at T<sub>J</sub> = 25°C, and are provided for reference purposes only. Unless otherwise stated the following conditions apply: V<sub>IN</sub> = 12 V, V<sub>OUT</sub> = 1.8 V<sup>(1)</sup>.

PARAMETER	TEST CONDITIONS		MIN <sup>(2)</sup>	TYP <sup>(3)</sup>	MAX <sup>(2)</sup>	UNIT
<b>SYSTEM PARAMETERS</b>						
<b>ENABLE CONTROL</b>						
V <sub>EN</sub>	EN threshold trip point	V <sub>EN</sub> rising	1.18			V
			apply over the junction temperature (T <sub>J</sub> ) range of -40°C to +125°C		1.25	
V <sub>EN-HYS</sub>	EN threshold hysteresis	V <sub>EN</sub> falling	90			mV
<b>SOFT-START</b>						
I <sub>SS</sub>	SS source current	V <sub>SS</sub> = 0 V	8			μA
			apply over the junction temperature (T <sub>J</sub> ) range of -40°C to +125°C		11	
I <sub>SS-DIS</sub>	SS discharge current		-200			μA
<b>CURRENT LIMIT</b>						
I <sub>CL</sub>	Current limit threshold	DC average	2			A
			apply over the junction temperature (T <sub>J</sub> ) range of -40°C to +125°C		3	
<b>ON/OFF TIMER</b>						
t <sub>ON-MIN</sub>	ON timer minimum pulse width		150			ns
t <sub>OFF</sub>	OFF timer pulse width		260			ns

- (1) EN 55022:2006, +A1:2007, FCC Part 15 Subpart B: 2007. See AN-2024 and layout for information on device under test.
- (2) Minimum and Maximum limits are 100% production tested at 25°C. Limits over the operating temperature range are specified through correlation using Statistical Quality Control (SQC) methods. Limits are used to calculate Average Outgoing Quality Level (AOQL).
- (3) Typical numbers are at 25°C and represent the most likely parametric norm.

## Electrical Characteristics (continued)

Limits in standard type are for  $T_J = 25^\circ\text{C}$  unless otherwise specified. Minimum and Maximum limits are specified through test, design or statistical correlation. Typical values represent the most likely parametric norm at  $T_J = 25^\circ\text{C}$ , and are provided for reference purposes only. Unless otherwise stated the following conditions apply:  $V_{IN} = 12\text{ V}$ ,  $V_{OUT} = 1.8\text{ V}^{(1)}$ .

PARAMETER		TEST CONDITIONS	MIN <sup>(2)</sup>	TYP <sup>(3)</sup>	MAX <sup>(2)</sup>	UNIT
<b>REGULATION AND OVERVOLTAGE COMPARATOR</b>						
$V_{FB}$	In-regulation feedback voltage	$V_{SS} >+ 0.8\text{ V}$ $T_J = -40^\circ\text{C}$ to $125^\circ\text{C}$ $I_O = 1\text{ A}$	apply over the junction temperature ( $T_J$ ) range of $-40^\circ\text{C}$ to $+125^\circ\text{C}$		0.798	V
			0.777	0.818		
		$V_{SS} >+ 0.8\text{ V}$ $T_J = 25^\circ\text{C}$ $I_O = 10\text{ mA}$	0.786	0.802	0.818	
$V_{FB-OV}$	Feedback overvoltage protection threshold			0.92		V
$I_{FB}$	Feedback input bias current			5		nA
$I_Q$	Non-switching input current	$V_{FB} = 0.86\text{ V}$		1		mA
$I_{SD}$	Shutdown quiescent current	$V_{EN} = 0\text{ V}$		25		$\mu\text{A}$
<b>THERMAL CHARACTERISTICS<sup>(4)</sup></b>						
$T_{SD}$	Thermal shutdown	Rising		165		$^\circ\text{C}$
$T_{SD-HYST}$	Thermal shutdown hysteresis	Falling		15		$^\circ\text{C}$
<b>PERFORMANCE PARAMETERS</b>						
$\Delta V_O$	Output voltage ripple			8		mV <sub>PP</sub>
$\Delta V_O/\Delta V_{IN}$	Line regulation	$V_{IN} = 8\text{ V}$ to $20\text{ V}$ , $I_O = 1\text{ A}$		0.01%		
$\Delta V_O/\Delta V_{IN}$	Load regulation	$V_{IN} = 12\text{ V}$		1.5		mV/A
$\eta$	Efficiency	$V_{IN} = 12\text{ V}$ , $V_O = 1.8\text{ V}$ , $I_O = 1\text{ A}$		85%		

(4) Theta JA measured on a 1.705-in x 3.0-in 4-layer board, with 1-oz. copper, thirty five thermal vias, no air flow, and 1-W power dissipation. Refer to PCB layout diagrams.

## 6.6 Typical Characteristics

Unless otherwise specified, the following conditions apply:  $V_{IN} = 12\text{ V}$ ;  $C_{IN} = 10\text{-}\mu\text{F X7R Ceramic}$ ;  $C_O = 100\text{-}\mu\text{F X7R Ceramic}$ ;  $T_A = 25\text{ C}$  for efficiency curves and waveforms.

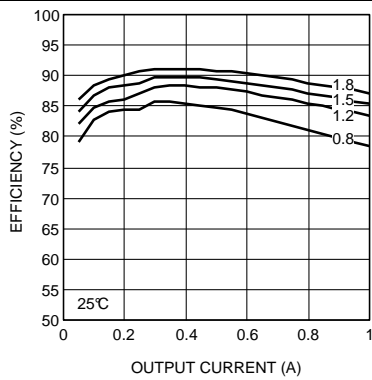

**Figure 1. Efficiency 4.5-V Input at 25°C**

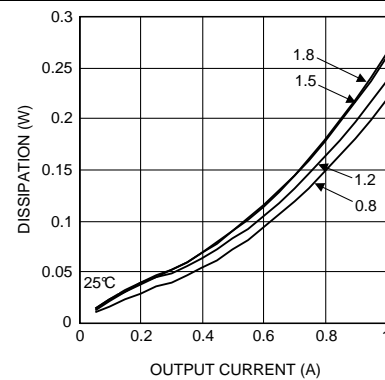

**Figure 2. Dissipation 4.5-V Input at 25°C**

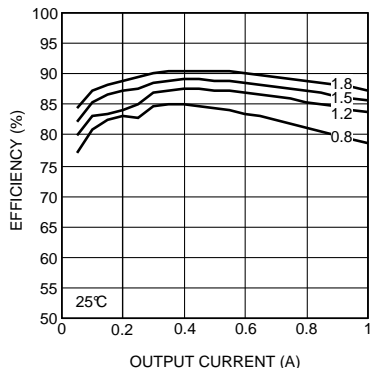

**Figure 3. Efficiency 5-V Input at 25°C**

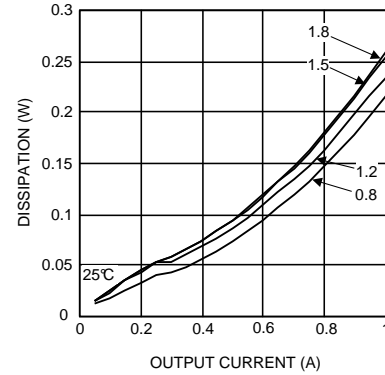

**Figure 4. Dissipation 5-V Input at 25°C**

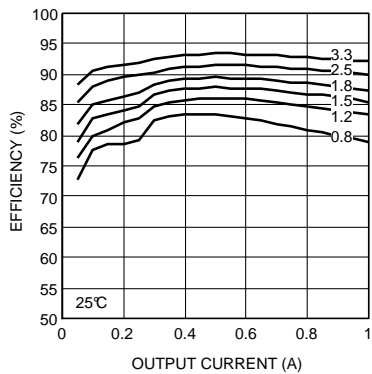

**Figure 5. Efficiency 6-V Input at 25°C**

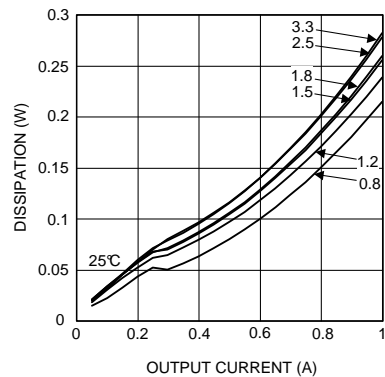

**Figure 6. Dissipation 6-V Input at 25°C**

Typical Characteristics (continued)

Unless otherwise specified, the following conditions apply:  $V_{IN} = 12\text{ V}$ ;  $C_{IN} = 10\text{-}\mu\text{F X7R Ceramic}$ ;  $C_O = 100\text{-}\mu\text{F X7R Ceramic}$ ;  $T_A = 25\text{ C}$  for efficiency curves and waveforms.

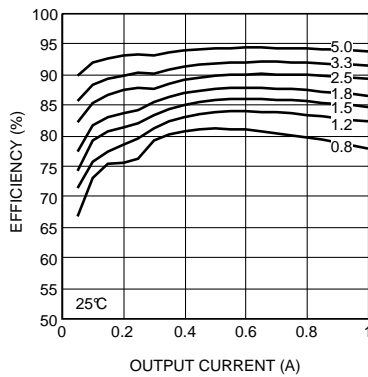

Figure 7. Efficiency 8-V Input at 25°C

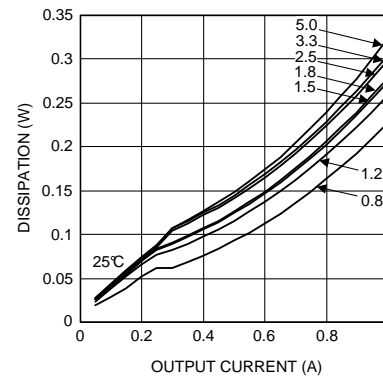

Figure 8. Dissipation 8-V Input at 25°C

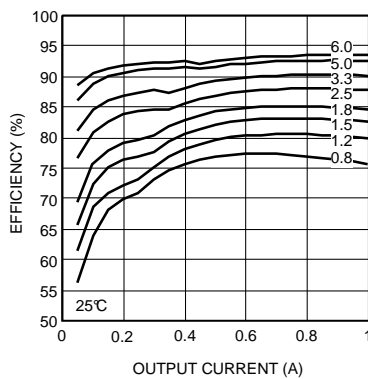

Figure 9. Efficiency 12-V Input at 25°C

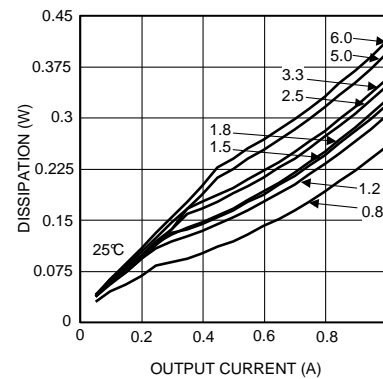

Figure 10. Dissipation 12-V Input at 25°C

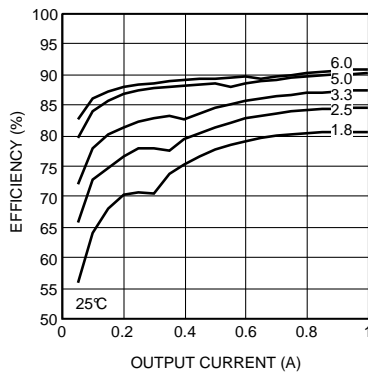

Figure 11. Efficiency 20-V Input at 25°C

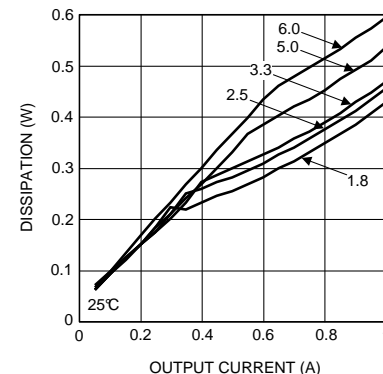
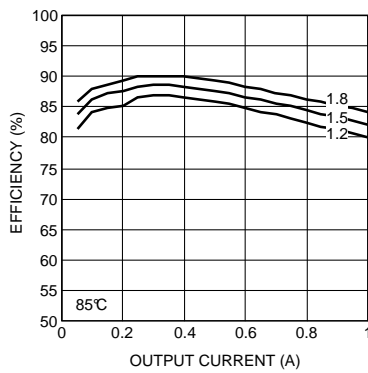

Figure 12. Dissipation 20-V Input at 25°C

**Typical Characteristics (continued)**

Unless otherwise specified, the following conditions apply:  $V_{IN} = 12\text{ V}$ ;  $C_{IN} = 10\text{-}\mu\text{F X7R Ceramic}$ ;  $C_O = 100\text{-}\mu\text{F X7R Ceramic}$ ;  $T_A = 25\text{ C}$  for efficiency curves and waveforms.



**Figure 13. Efficiency 4.5-V Input at 85°C**

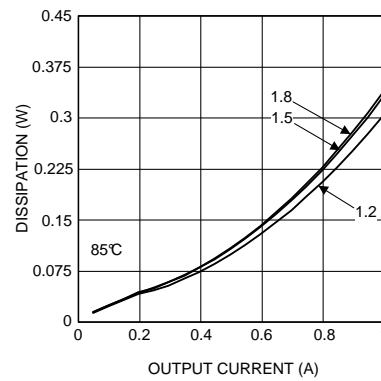

**Figure 14. Dissipation 4.5-V Input at 85°C**

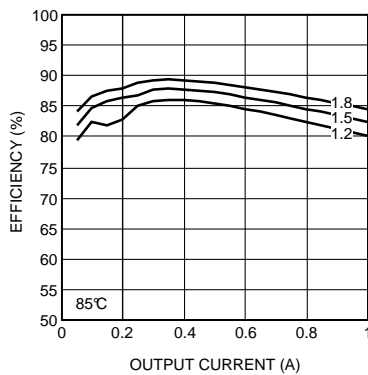

**Figure 15. Efficiency 5-V Input at 85°C**

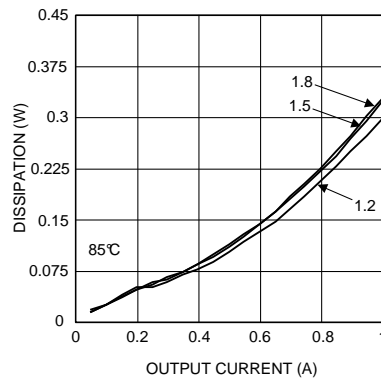

**Figure 16. Dissipation 5-V Input at 85°C**

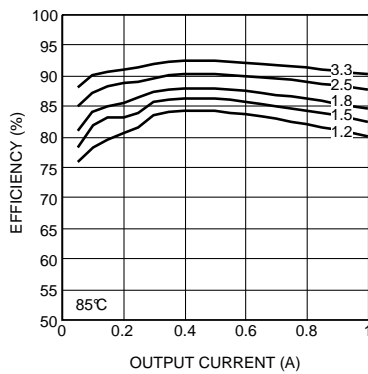

**Figure 17. Efficiency 6-V Input at 85°C**

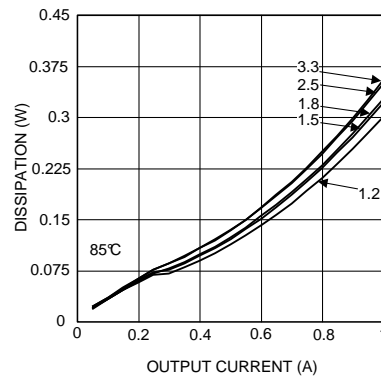
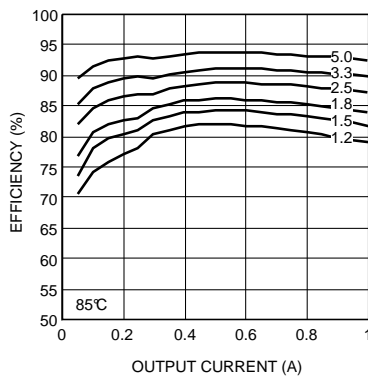

**Figure 18. Dissipation 6-V Input at 85°C**



**Typical Characteristics (continued)**

Unless otherwise specified, the following conditions apply:  $V_{IN} = 12\text{ V}$ ;  $C_{IN} = 10\text{-}\mu\text{F X7R Ceramic}$ ;  $C_O = 100\text{-}\mu\text{F X7R Ceramic}$ ;  $T_A = 25\text{ C}$  for efficiency curves and waveforms.



**Figure 19. Efficiency 8-V Input at 85°C**

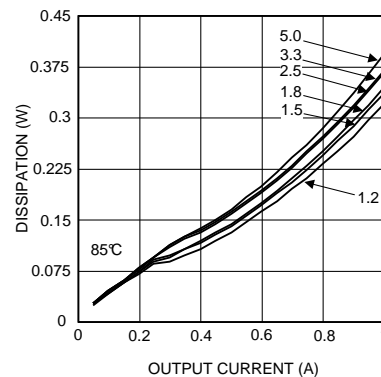

**Figure 20. Dissipation 8-V Input at 85°C**

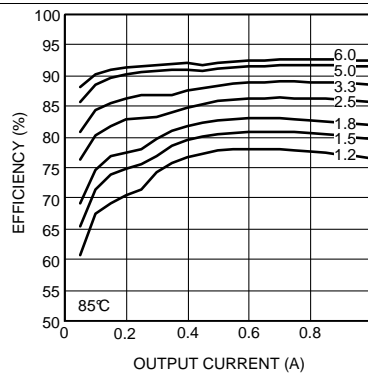

**Figure 21. Efficiency 12-V Input at 85°C**

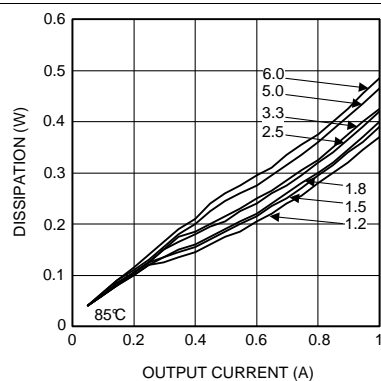

**Figure 22. Dissipation 12-V Input at 85°C**

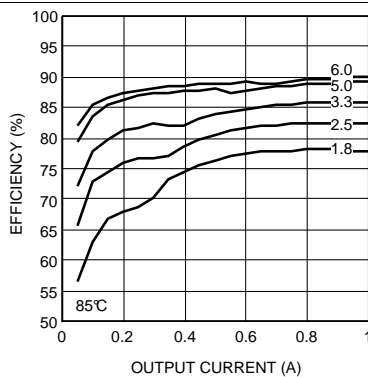

**Figure 23. Efficiency 20-V Input at 85°C**

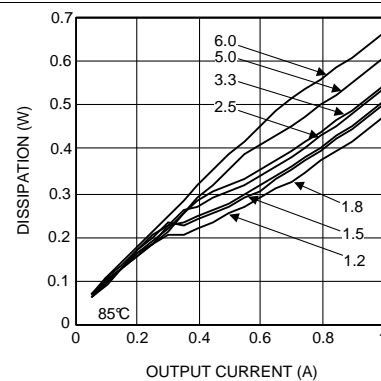

**Figure 24. Dissipation 20-V Input at 85°C**

**Typical Characteristics (continued)**

Unless otherwise specified, the following conditions apply:  $V_{IN} = 12\text{ V}$ ;  $C_{IN} = 10\text{-}\mu\text{F X7R Ceramic}$ ;  $C_O = 100\text{-}\mu\text{F X7R Ceramic}$ ;  $T_A = 25\text{ C}$  for efficiency curves and waveforms.

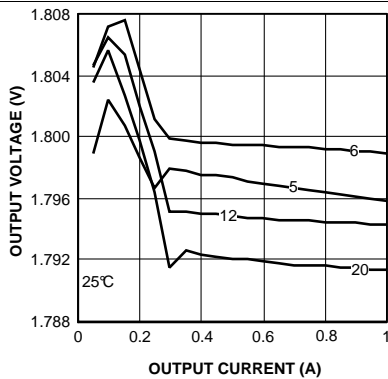

Figure 25. Line and Load Regulation at 25°C

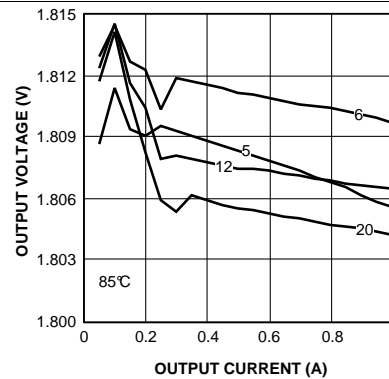

Figure 26. Line and Load Regulation at 85°C

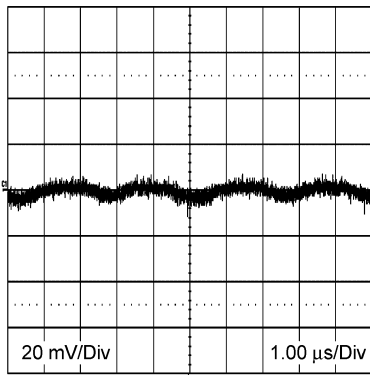

Figure 27. Output Ripple  
12  $V_{IN}$  3.3  $V_O$  1 A

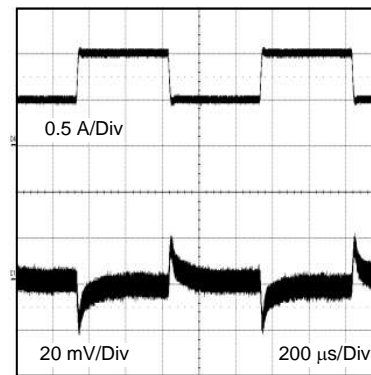

Figure 28. Transient Response  
12  $V_{IN}$  3.3  $V_O$  0.6-A to 1-A Step

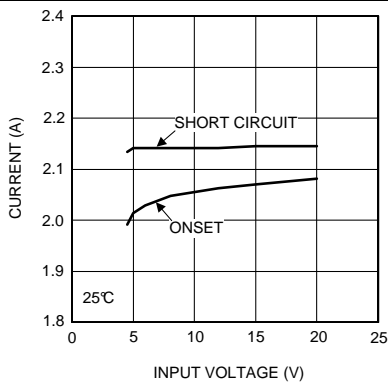

Figure 29. Current Limit 1.8  $V_{OUT}$  at 25°C

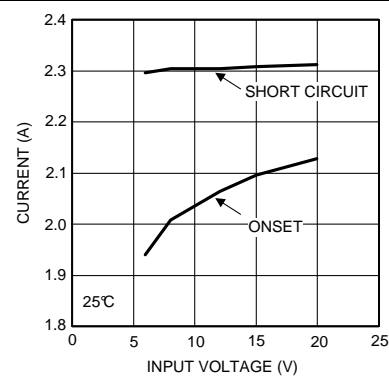
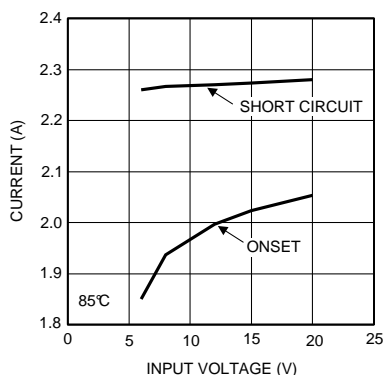

Figure 30. Current Limit 3.3  $V_{OUT}$  at 25°C

**Typical Characteristics (continued)**

Unless otherwise specified, the following conditions apply:  $V_{IN} = 12\text{ V}$ ;  $C_{IN} = 10\text{-}\mu\text{F X7R Ceramic}$ ;  $C_O = 100\text{-}\mu\text{F X7R Ceramic}$ ;  $T_A = 25\text{ C}$  for efficiency curves and waveforms.



**Figure 31. Current Limit 3.3 V<sub>OUT</sub> at 85°C**

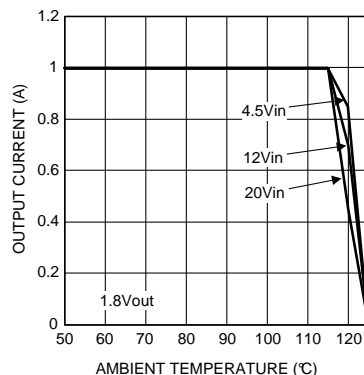

**Figure 32. Thermal Derating V<sub>OUT</sub> = 1.8 V**

## 7 Detailed Description

### 7.1 Overview

The LMZ12001 power module is an easy-to-use step-down DC-DC solution capable of driving up to 1-A load with exceptional power conversion efficiency, line and load regulation, and output accuracy.

### 7.2 Functional Block Diagram

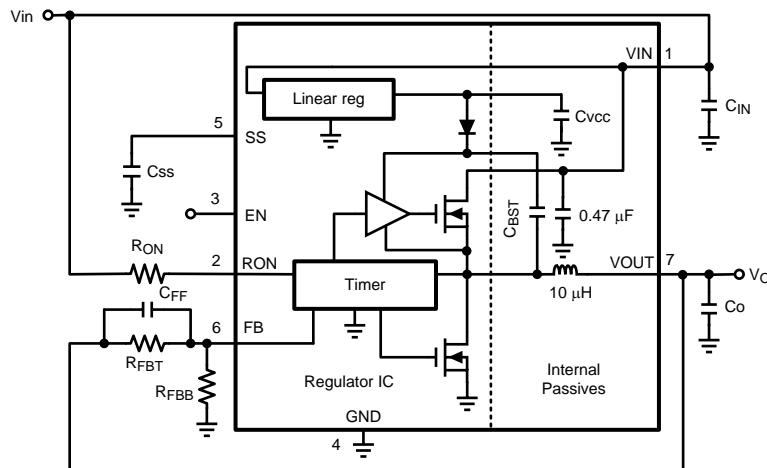

### 7.3 Feature Description

#### 7.3.1 COT Control Circuit Overview

Constant ON-time control is based on a comparator and an ON-time one-shot, with the output voltage feedback compared with an internal 0.8-V reference. If the feedback voltage is below the reference, the main MOSFET is turned on for a fixed ON-time determined by a programming resistor  $R_{ON}$ .  $R_{ON}$  is connected to  $V_{IN}$  such that ON-time is reduced with increasing input supply voltage. Following this ON-time, the main MOSFET remains off for a minimum of 260 ns. If the voltage on the feedback pin falls below the reference level again the ON-time cycle is repeated. Regulation is achieved in this manner.

#### 7.3.2 Output Overvoltage Comparator

The voltage at FB is compared to a 0.92-V internal reference. If FB rises above 0.92 V the ON-time is immediately terminated. This condition is known as overvoltage protection (OVP). It can occur if the input voltage is increased very suddenly or if the output load is decreased very suddenly. Once OVP is activated, the top MOSFET ON-times will be inhibited until the condition clears. Additionally, the synchronous MOSFET will remain on until inductor current falls to zero.

#### 7.3.3 Current Limit

Current limit detection is carried out during the OFF-time by monitoring the current in the synchronous MOSFET. Referring to the [Functional Block Diagram](#), when the top MOSFET is turned off, the inductor current flows through the load, the PGND pin and the internal synchronous MOSFET. If this current exceeds 1.5 A (typical) the current limit comparator disables the start of the next ON-time period. The next switching cycle will occur only if the FB input is less than 0.8 V and the inductor current has decreased below 1.5 A. Inductor current is monitored during the period of time the synchronous MOSFET is conducting. So long as inductor current exceeds 1.5 A, further ON-time intervals for the top MOSFET will not occur. Switching frequency is lower during current limit due to the longer OFF-time. It should also be noted that current limit is dependent on both duty cycle and temperature as illustrated in the graphs in the [Typical Characteristics](#) section.

## Feature Description (continued)

### 7.3.4 Thermal Protection

The junction temperature of the LMZ12001 should not be allowed to exceed its maximum ratings. Thermal protection is implemented by an internal Thermal Shutdown circuit which activates at 165°C (typical) causing the device to enter a low power standby state. In this state the main MOSFET remains off causing  $V_O$  to fall, and additionally the CSS capacitor is discharged to ground. Thermal protection helps prevent catastrophic failures for accidental device overheating. When the junction temperature falls back below 145°C (typical hysteresis = 20°C) the SS pin is released,  $V_O$  rises smoothly, and normal operation resumes.

Applications requiring maximum output current especially those at high input voltage may require application derating at elevated temperatures.

### 7.3.5 Zero Coil Current Detection

The current of the lower (synchronous) MOSFET is monitored by a zero coil current detection circuit which inhibits the synchronous MOSFET when its current reaches zero until the next ON-time. This circuit enables the DCM operating mode, which improves efficiency at light loads.

### 7.3.6 Prebiased Start-Up

The LMZ12001 will properly start up into a prebiased output. This start-up situation is common in multiple rail logic applications where current paths may exist between different power rails during the start-up sequence. The following scope capture shows proper behavior during this event.

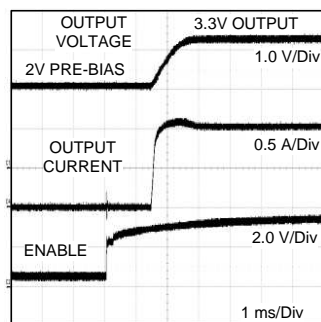

**Figure 33. Prebiased Start-Up**

## 7.4 Device Functional Modes

### 7.4.1 Discontinuous Conduction and Continuous Conduction Modes

At light load the regulator will operate in discontinuous conduction mode (DCM). With load currents above the critical conduction point, it will operate in continuous conduction mode (CCM). When operating in DCM the switching cycle begins at zero amp inductor current; increases up to a peak value, and then recedes back to zero before the end of the OFF-time. Note that during the period of time that inductor current is zero, all load current is supplied by the output capacitor. The next ON-time period starts when the voltage on the at the FB pin falls below the internal reference. The switching frequency is lower in DCM and varies more with load current as compared to CCM. Conversion efficiency in DCM is maintained because conduction and switching losses are reduced with the smaller load and lower switching frequency. The switching frequency is lower in DCM and varies more with load current as compared to CCM. Conversion efficiency in DCM is maintained because conduction and switching losses are reduced with the smaller load and lower switching frequency.

## 8 Application and Implementation

### NOTE

Information in the following applications sections is not part of the TI component specification, and TI does not warrant its accuracy or completeness. TI's customers are responsible for determining suitability of components for their purposes. Customers should validate and test their design implementation to confirm system functionality.

### 8.1 Application Information

The LMZ12001 is a step-down DC-to-DC power module. It is typically used to convert a higher DC voltage to a lower DC voltage with a maximum output current of 1 A. The following design procedure can be used to select components for the LMZ12001. Alternately, the WEBENCH software may be used to generate complete designs.

When generating a design, the WEBENCH software uses iterative design procedure and accesses comprehensive databases of components. Please go to [www.ti.com](http://www.ti.com) for more details

### 8.2 Typical Application

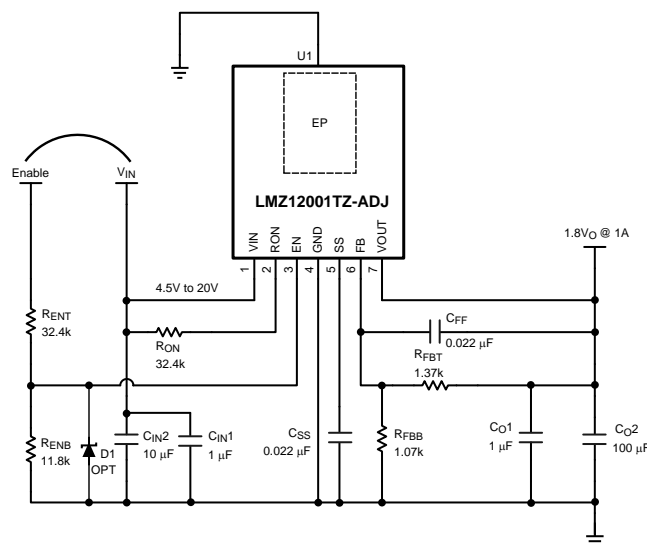

**Figure 34. Evaluation Board Schematic Diagram**

#### 8.2.1 Design Requirements

For this example the following application parameters exist.

- $V_{IN}$  Range = Up to 20 V
- $V_{OUT}$  = 0.8 V to 6 V
- $I_{OUT}$  = 1 A

#### 8.2.2 Detailed Design Procedure

##### 8.2.2.1 Design Steps

The LMZ12001 is fully supported by WEBENCH and offers the following: component selection, electrical and thermal simulations, as well as the build-it board for a reduction in design time. The following list of steps can be used to manually design the LMZ12001 application.

1. Select minimum operating  $V_{IN}$  with enable divider resistors
2. Program  $V_O$  with divider resistor selection
3. Program turnon time with soft-start capacitor selection

## Typical Application (continued)

4. Select  $C_O$
5. Select  $C_{IN}$
6. Set operating frequency with  $R_{ON}$
7. Determine module dissipation
8. Layout PCB for required thermal performance

### 8.2.2.2 Enable Divider, $R_{ENT}$ and $R_{ENB}$ Selection

The enable input provides a precise 1.18-V band-gap rising threshold to allow direct logic drive or connection to a voltage divider from a higher enable voltage such as  $V_{IN}$ . The enable input also incorporates 90 mV (typical) of hysteresis resulting in a falling threshold of 1.09 V. The maximum recommended voltage into the EN pin is 6.5 V. For applications where the midpoint of the enable divider exceeds 6.5 V, a small Zener can be added to limit this voltage.

The function of this resistive divider is to allow the designer to choose an input voltage below which the circuit will be disabled. This implements the feature of programmable under voltage lockout. This is often used in battery powered systems to prevent deep discharge of the system battery. It is also useful in system designs for sequencing of output rails or to prevent early turn-on of the supply as the main input voltage rail rises at power-up. Applying the enable divider to the main input rail is often done in the case of higher input voltage systems where a lower boundary of operation should be established. In the case of sequencing supplies, the divider is connected to a rail that becomes active earlier in the power-up cycle than the LMZ12001 output rail. The two resistors should be chosen based on the following ratio:

$$R_{ENT} / R_{ENB} = (V_{IN\ UVLO} / 1.18\ V) - 1 \quad (1)$$

The LMZ12001 demonstration and evaluation boards use 11.8 k $\Omega$  for  $R_{ENB}$  and 32.4 k $\Omega$  for  $R_{ENT}$  resulting in a rising UVLO of 4.5 V. This divider presents 5.34V to the EN input when the divider input is raised to 20 V.

The EN pin is internally pulled up to  $V_{IN}$  and can be left floating for always-on operation.

### 8.2.2.3 Output Voltage Selection

Output voltage is determined by a divider of two resistors connected between  $V_O$  and ground. The midpoint of the divider is connected to the FB input. The voltage at FB is compared to a 0.8-V internal reference. In normal operation an ON-time cycle is initiated when the voltage on the FB pin falls below 0.8 V. The main MOSFET ON-time cycle causes the output voltage to rise and the voltage at the FB to exceed 0.8 V. As long as the voltage at FB is above 0.8 V, ON-time cycles will not occur.

The regulated output voltage determined by the external divider resistors  $R_{FBT}$  and  $R_{FBB}$  is:

$$V_O = 0.8\ V \times (1 + R_{FBT} / R_{FBB}) \quad (2)$$

Rearranging terms; the ratio of the feedback resistors for a desired output voltage is:

$$R_{FBT} / R_{FBB} = (V_O / 0.8\ V) - 1 \quad (3)$$

These resistors should be chosen from values in the range of 1.0 k $\Omega$  to 10.0 k $\Omega$ .

For  $V_O = 0.8\ V$  the FB pin can be connected to the output directly so long as an output preload resistor remains that draws more than 20  $\mu$ A. Converter operation requires this minimum load to create a small inductor ripple current and maintain proper regulation when no load is present.

A feed-forward capacitor is placed in parallel with  $R_{FBT}$  to improve load step transient response. Its value is usually determined experimentally by load stepping between DCM and CCM conduction modes and adjusting for best transient response and minimum output ripple.

[Table 1](#) lists the values for  $R_{FBT}$ ,  $R_{FBB}$ ,  $C_{FF}$  and  $R_{ON}$ .

**Table 1. Bill of Materials**

REF DES	DESCRIPTION	CASE SIZE	MANUFACTURER	MANUFACTURER P/N
U1	SIMPLE SWITCHER	PFM-7	Texas Instruments	LMZ12001 TZ-ADJ
$C_{in1}$	1 $\mu$ F, 50 V, X7R	1206	Taiyo Yuden	UMK316B7105KL-T
$C_{in2}$	10 $\mu$ F, 50 V, X7R	1210	Taiyo Yuden	UMK325BJ106MM-T

**Typical Application (continued)**
**Table 1. Bill of Materials (continued)**

REF DES	DESCRIPTION	CASE SIZE	MANUFACTURER	MANUFACTURER P/N
C <sub>O1</sub>	1 μF, 50 V, X7R	1206	Taiyo Yuden	UMK316B7105KL-T
C <sub>O2</sub>	100 μF, 6.3 V, X7R	1210	Taiyo Yuden	JMK325BJ10CR7MM-T
R <sub>FBT</sub>	1.37 kΩ	0603	Vishay Dale	CRCW06031K37FKEA
R <sub>FBB</sub>	1.07 kΩ	0603	Vishay Dale	CRCW06031K07FKEA
R <sub>ON</sub>	32.4 kΩ	0603	Vishay Dale	CRCW060332K4FKEA
R <sub>ENT</sub>	32.4 kΩ	0603	Vishay Dale	CRCW060332K4FKEA
R <sub>ENB</sub>	11.8 kΩ	0603	Vishay Dale	CRCW060311k8FKEA
C <sub>FF</sub>	22 nF, ±10%, X7R, 16 V	0603	TDK	C1608X7R1H223K
C <sub>SS</sub>	22 nF, ±10%, X7R, 16 V	0603	TDK	C1608X7R1H223K
D1	5.1 V	SOD-23	—	Optional

**8.2.2.4 Soft-Start Capacitor Selection**

Programmable soft-start permits the regulator to slowly ramp to its steady-state operating point after being enabled, thereby reducing current inrush from the input supply and slowing the output voltage rise-time to prevent overshoot.

Upon turnon, after all UVLO conditions have been passed, an internal 8-μA current source begins charging the external soft-start capacitor. The soft-start time duration to reach steady-state operation is given by the formula:

$$t_{SS} = V_{REF} \times C_{SS} / I_{SS} = 0.8 \text{ V} \times C_{SS} / 8 \mu\text{A} \quad (4)$$

This equation can be rearranged as follows:

$$C_{SS} = t_{SS} \times 8 \mu\text{A} / 0.8 \text{ V} \quad (5)$$

Use of a 0.022-μF capacitor results in 2.2-ms soft-start interval which is recommended as a minimum value.

As the soft-start input exceeds 0.8 V the output of the power stage will be in regulation. The soft-start capacitor continues charging until it reaches approximately 3.8 V on the SS pin. Voltage levels between 0.8 V and 3.8 V have no effect on other circuit operation. Note that the following conditions will reset the soft-start capacitor by discharging the SS input to ground with an internal 200-μA current sink.

- The enable input being *pulled low*
- Thermal shutdown condition
- Overcurrent fault
- Internal V<sub>CC</sub> UVLO (Approx 4-V input to V<sub>IN</sub>)

**8.2.2.5 C<sub>O</sub> Selection**

None of the required C<sub>O</sub> output capacitance is contained within the module. At a minimum, the output capacitor must meet the worst case minimum ripple current rating of 0.5 × I<sub>LRP-P</sub>, as calculated in [Equation 17](#). Beyond that, additional capacitance will reduce output ripple so long as the ESR is low enough to permit it. A minimum value of 10 μF is generally required. Experimentation will be required if attempting to operate with a minimum value. Ceramic capacitors or other low ESR types are recommended. See AN-2024 for more detail.

[Equation 6](#) provides a good first pass approximation of C<sub>O</sub> for load transient requirements:

$$C_O \geq I_{STEP} \times V_{FB} \times L \times V_{IN} / (4 \times V_O \times (V_{IN} - V_O) \times V_{OUT-TRAN}) \quad (6)$$

Solving:

$$C_O \geq 1 \text{ A} \times 0.8 \text{ V} \times 10 \mu\text{H} \times 12 \text{ V} / (4 \times 3.3 \text{ V} \times (12 \text{ V} - 3.3 \text{ V}) \times 33 \text{ mV}) \geq 25 \mu\text{F} \quad (7)$$

The LMZ12001 demonstration and evaluation boards are populated with a 100 uF 6.3V X5R output capacitor. Locations for other output capacitors are provided.



### 8.2.2.6 $C_{IN}$ Selection

The LMZ12001 module contains an internal 0.47- $\mu\text{F}$  input ceramic capacitor. Additional input capacitance is required external to the module to handle the input ripple current of the application. This input capacitance should be located in very close proximity to the module. Input capacitor selection is generally directed to satisfy the input ripple current requirements rather than by capacitance value. Worst case input ripple current rating is dictated by [Equation 8](#):

$$I(C_{IN(RMS)}) \approx 1/2 \times I_O \times \sqrt{(D / (1-D))}$$

where

- $D \approx V_O / V_{IN}$  (8)

As a point of reference, the worst case ripple current will occur when the module is presented with full load current and when  $V_{IN} = 2 \times V_O$ .

Recommended minimum input capacitance is 10- $\mu\text{F}$  X7R ceramic with a voltage rating at least 25% higher than the maximum applied input voltage for the application. It is also recommended that attention be paid to the voltage and temperature deratings of the capacitor selected. It should be noted that ripple current rating of ceramic capacitors may be missing from the capacitor data sheet and you may have to contact the capacitor manufacturer for this rating.

If the system design requires a certain minimum value of input ripple voltage  $\Delta V_{IN}$  be maintained then [Equation 9](#) may be used.

$$C_{IN} \geq I_O \times D \times (1 - D) / f_{SW-CCM} \times \Delta V_{IN} \quad (9)$$

If  $\Delta V_{IN}$  is 1% of  $V_{IN}$  for a 20-V input to 3.3-V output application this equals 200 mV and  $f_{SW} = 400$  kHz.

$$C_{IN} \geq 1 \text{ A} \times 3.3 \text{ V} / 20 \text{ V} \times (1 - 3.3 \text{ V} / 20 \text{ V}) / (400000 \times 0.200 \text{ V})$$

$$\geq 1.7 \mu\text{F}$$

Additional bulk capacitance with higher ESR may be required to damp any resonant effects of the input capacitance and parasitic inductance of the incoming supply lines.

### 8.2.2.7 $R_{ON}$ Resistor Selection

Many designs will begin with a desired switching frequency in mind. For that purpose [Equation 10](#) can be used.

$$f_{SW(CCM)} \approx V_O / (1.3 \times 10^{-10} \times R_{ON}) \quad (10)$$

This can be rearranged as

$$R_{ON} \approx V_O / (1.3 \times 10^{-10} \times f_{SW(CCM)}) \quad (11)$$

The selection of  $R_{ON}$  and  $f_{SW(CCM)}$  must be confined by limitations in the ON-time and OFF-time for the [COT Control Circuit Overview](#) section.

The ON-time of the LMZ12001 timer is determined by the resistor  $R_{ON}$  and the input voltage  $V_{IN}$ . It is calculated as follows:

$$t_{ON} = (1.3 \times 10^{-10} \times R_{ON}) / V_{IN} \quad (12)$$

The inverse relationship of  $t_{ON}$  and  $V_{IN}$  gives a nearly constant switching frequency as  $V_{IN}$  is varied.  $R_{ON}$  should be selected such that the ON-time at maximum  $V_{IN}$  is greater than 150 ns. The ON-timer has a limiter to ensure a minimum of 150 ns for  $t_{ON}$ . This limits the maximum operating frequency, which is governed by [Equation 13](#):

$$f_{SW(MAX)} = V_O / (V_{IN(MAX)} \times 150 \text{ ns}) \quad (13)$$

This equation can be used to select  $R_{ON}$  if a certain operating frequency is desired so long as the minimum ON-time of 150 ns is observed. The limit for  $R_{ON}$  can be calculated as follows:

$$R_{ON} \geq V_{IN(MAX)} \times 150 \text{ ns} / (1.3 \times 10^{-10}) \quad (14)$$

If  $R_{ON}$  calculated in [Equation 11](#) is less than the minimum value determined in [Equation 14](#) a lower frequency should be selected. Alternatively,  $V_{IN(MAX)}$  can also be limited in order to keep the frequency unchanged.

Additionally, consider the minimum OFF-time of 260 ns limits the maximum duty ratio. Larger  $R_{ON}$  (lower  $F_{SW}$ ) should be selected in any application requiring large duty ratio.

#### 8.2.2.7.1 Discontinuous Conduction and Continuous Conduction Mode Selection

Operating frequency in DCM can be calculated as follows:

$$f_{\text{SW(DCM)}} \cong V_O \times (V_{\text{IN}} - 1) \times 10 \mu\text{H} \times 1.18 \times 10^{20} \times I_O / (V_{\text{IN}} - V_O) \times R_{\text{ON}}^2 \quad (15)$$

In CCM, current flows through the inductor through the entire switching cycle and never falls to zero during the OFF-time. The switching frequency remains relatively constant with load current and line voltage variations. The CCM operating frequency can be calculated using [Equation 7](#).

[Figure 35](#) is a comparison pair of waveforms of the showing both CCM (upper) and DCM operating modes.

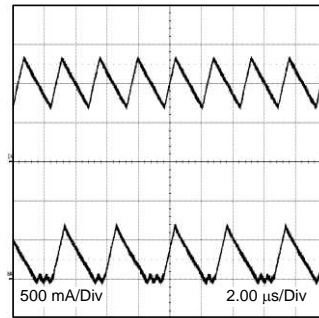

$$V_{\text{IN}} = 12 \text{ V}, V_O = 3.3 \text{ V}, I_O = 1 \text{ A} / 0.25 \text{ A}$$

**Figure 35. CCM and DCM Operating Modes**

The approximate formula for determining the DCM/CCM boundary is as follows:

$$I_{\text{DCB}} \cong V_O \times (V_{\text{IN}} - V_O) / (2 \times 10 \mu\text{H} \times f_{\text{SW(CCM)}} \times V_{\text{IN}}) \quad (16)$$

[Figure 36](#) is a typical waveform showing the boundary condition.

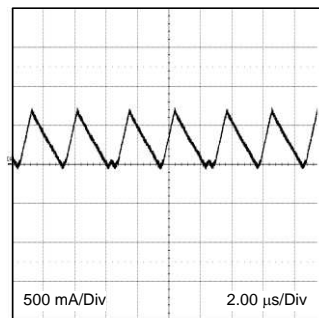

$$V_{\text{IN}} = 12 \text{ V}, V_O = 3.3 \text{ V}, I_O = 0.29 \text{ A}$$

**Figure 36. Transition Mode Operation**

The inductor internal to the module is 10 μH. This value was chosen as a good balance between low and high input voltage applications. The main parameter affected by the inductor is the amplitude of the inductor ripple current ( $I_{\text{LR}}$ ).  $I_{\text{LR}}$  can be calculated with:

$$I_{\text{LRP-P}} = V_O \times (V_{\text{IN}} - V_O) / (10 \mu\text{H} \times f_{\text{SW}} \times V_{\text{IN}})$$

where

- $V_{\text{IN}}$  is the maximum input voltage and  $f_{\text{SW}}$  is determined from [Equation 10](#). (17)

If the output current  $I_O$  is determined by assuming that  $I_O = I_L$ , the higher and lower peak of  $I_{\text{LR}}$  can be determined. Be aware that the lower peak of  $I_{\text{LR}}$  must be positive if CCM operation is required.

### 8.2.3 Application Curves

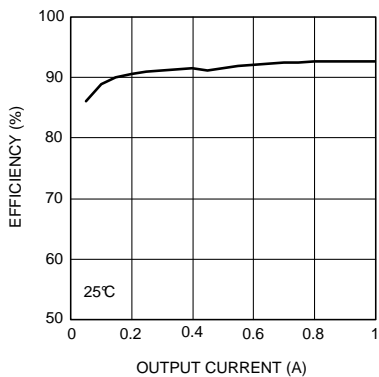

$V_{IN} = 12\text{ V}$ ,  $V_{OUT} = 5\text{ V}$

**Figure 37. Efficiency**

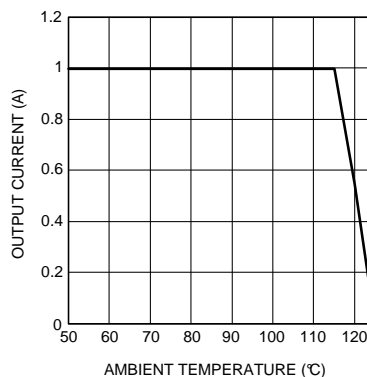

$V_{IN} = 12\text{ V}$ ,  $V_{OUT} = 5\text{ V}$

**Figure 38. Thermal Derating Curve**

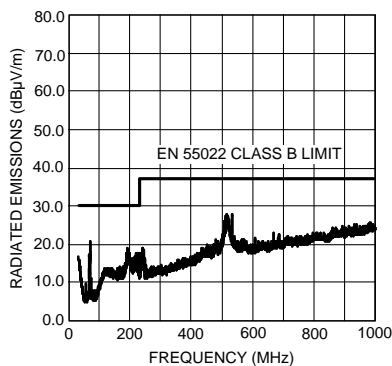

**Figure 39. Radiated Emissions (EN 55022 Class B) from Evaluation Board**

## 9 Power Supply Recommendations

The LMZ12001 device is designed to operate from an input voltage supply range between 4.5 V and 20 V. This input supply should be well regulated and able to withstand maximum input current and maintain a stable voltage. The resistance of the input supply rail should be low enough that an input current transient does not cause a high enough drop at the LMZ12001 supply voltage that can cause a false UVLO fault triggering and system reset. If the input supply is more than a few inches from the LMZ12001, additional bulk capacitance may be required in addition to the ceramic bypass capacitors. The amount of bulk capacitance is not critical, but a 47- $\mu$ F or 100- $\mu$ F electrolytic capacitor is a typical choice.

## 10 Layout

### 10.1 Layout Guidelines

PCB layout is an important part of DC-DC converter design. Poor board layout can disrupt the performance of a DC-DC converter and surrounding circuitry by contributing to EMI, ground bounce and resistive voltage drop in the traces. These can send erroneous signals to the DC-DC converter resulting in poor regulation or instability. Good layout can be implemented by following a few simple design rules.

#### 1. Minimize area of switched current loops.

From an EMI reduction standpoint, it is imperative to minimize the high di/dt current paths during PCB layout. The high current loops that do not overlap have high di/dt content that will cause observable high frequency noise on the output pin if the input capacitor  $C_{IN1}$  is placed a distance away from the LMZ12001. Therefore physically place  $C_{IN1}$  as close as possible to the LMZ12001 VIN and GND exposed pad. This will minimize the high di/dt area and reduce radiated EMI. Additionally, grounding for both the input and output capacitor should consist of a localized top side plane that connects to the GND exposed pad (EP).

#### 2. Have a single point ground.

The ground connections for the feedback, soft-start, and enable components should be routed to the GND pin of the device. This prevents any switched or load currents from flowing in the analog ground traces. If not properly handled, poor grounding can result in degraded load regulation or erratic output voltage ripple behavior. Provide the single point ground connection from pin 4 to EP.

#### 3. Minimize trace length to the FB pin.

Both feedback resistors,  $R_{FBT}$  and  $R_{FBB}$ , and the feed forward capacitor  $C_{FF}$ , should be located close to the FB pin. Since the FB node is high impedance, maintain the copper area as small as possible. The trace area from  $R_{FBT}$ ,  $R_{FBB}$ , and  $C_{FF}$  should be routed away from the body of the LMZ12001 to minimize noise.

#### 4. Make input and output bus connections as wide as possible.

This reduces any voltage drops on the input or output of the converter and maximizes efficiency. To optimize voltage accuracy at the load, ensure that a separate feedback voltage sense trace is made to the load. Doing so will correct for voltage drops and provide optimum output accuracy.

#### 5. Provide adequate device heat-sinking.

Use an array of heat-sinking vias to connect the exposed pad to the ground plane on the bottom PCB layer. If the PCB has a plurality of copper layers, these thermal vias can also be employed to make connection to inner layer heat-spreading ground planes. For best results use a 6  $\times$  6 via array with a minimum via diameter of 8 mils thermal vias spaced 59 mils (1.5 mm). Ensure enough copper area is used for heat-sinking to keep the junction temperature below 125°C.

## 10.2 Layout Examples

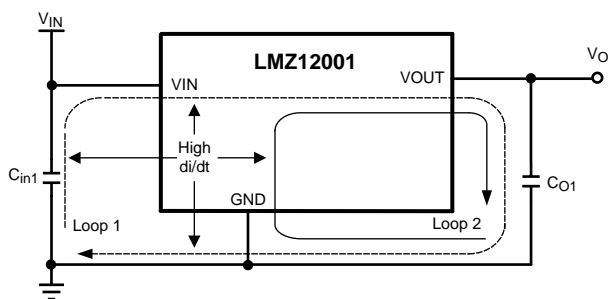

Figure 40. Critical Current Loops to Minimize

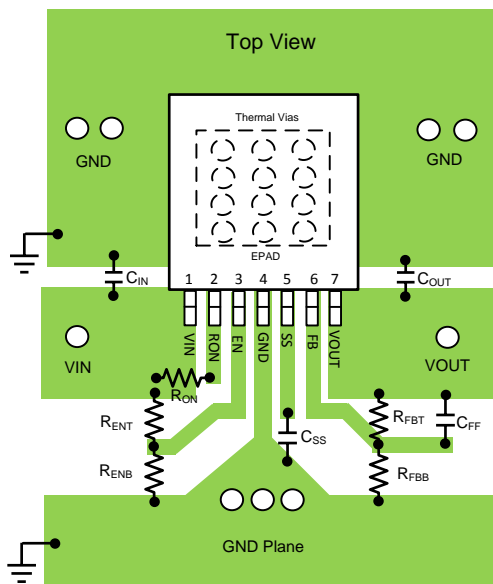
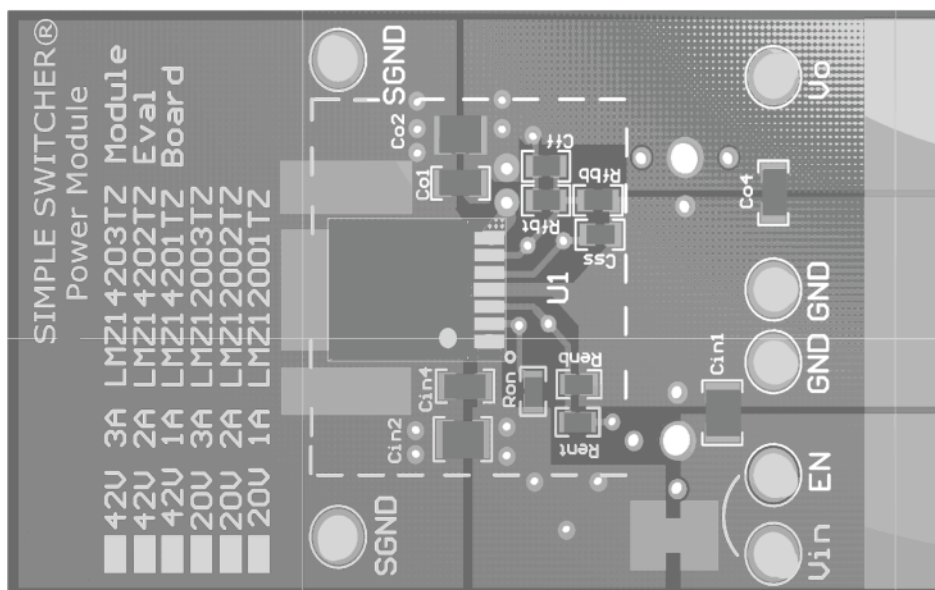
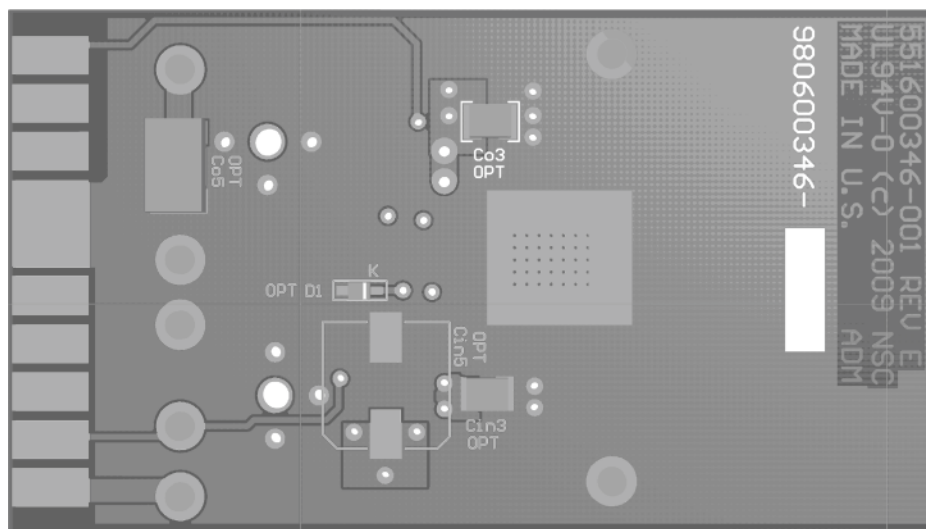

Figure 41. PCB Layout Guide

**Layout Examples (continued)**

**Figure 42. Top View of Evaluation PCB**

**Figure 43. Bottom View of Evaluation PCB**
**10.3 Power Dissipation and Thermal Considerations**

For the design case of  $V_{IN} = 12\text{ V}$ ,  $V_O = 1.8\text{ V}$ ,  $I_O = 1\text{ A}$ ,  $T_{AMB(MAX)} = 85^\circ\text{C}$ , and  $T_{JUNCTION} = 125^\circ\text{C}$ , the device must see a thermal resistance from case to ambient of:

$$R_{\theta CA} < (T_{J-MAX} - T_{AMB(MAX)}) / P_{IC-LOSS} - R_{\theta JC} \quad (18)$$

Given the typical thermal resistance from junction to case to be  $1.9^\circ\text{C/W}$ . Use the  $85^\circ\text{C}$  power dissipation curves in the [Typical Characteristics](#) section to estimate the  $P_{IC-LOSS}$  for the application being designed. In this application it is  $0.4\text{ W}$

$$R_{\theta CA} < (125 - 85) / 0.4\text{ W} - 1.9 = 98.1$$

To reach  $R_{\theta CA} = 98.1$ , the PCB is required to dissipate heat effectively. With no airflow and no external heat, a good estimate of the required board area covered by 1-oz. copper on both the top and bottom metal layers is:

**Power Dissipation and Thermal Considerations (continued)**

$$\text{Board Area}_{\text{cm}^2} = 500^{\circ}\text{C} \times \text{cm}^2/\text{W} / R_{\theta\text{JC}} \tag{19}$$

As a result, approximately 5 square cm of 1-oz. copper on top and bottom layers is required for the PCB design. The PCB copper heat sink must be connected to the exposed pad. Approximately thirty six, 8 mils thermal vias spaced 59 mils (1.5 mm) apart must connect the top copper to the bottom copper. For an example of a high thermal performance PCB layout, refer to the Evaluation Board application note [SNVA422 AN-2024](#). For more information on thermal design see [SNVA419 AN-2020](#) and [SNVA424 AN-2026](#).

**10.4 Power Module SMT Guidelines**

The recommendations below are for a standard module surface mount assembly.

- Land Pattern — Follow the PCB land pattern with either soldermask defined or non-soldermask defined pads
- Stencil Aperture
  - For the exposed die attach pad (DAP), adjust the stencil for approximately 80% coverage of the PCB land pattern
  - For all other I/O pads use a 1:1 ratio between the aperture and the land pattern recommendation
- Solder Paste — Use a standard SAC Alloy such as SAC 305, type 3 or higher
- Stencil Thickness — 0.125 to 0.15 mm
- Reflow - Refer to solder paste supplier recommendation and optimized per board size and density
- Refer to *Design Summary LMZ1xxx and LMZ2xxx Power Modules Family* ([SNAA214](#)) for reflow information
- Maximum number of reflows allowed is one

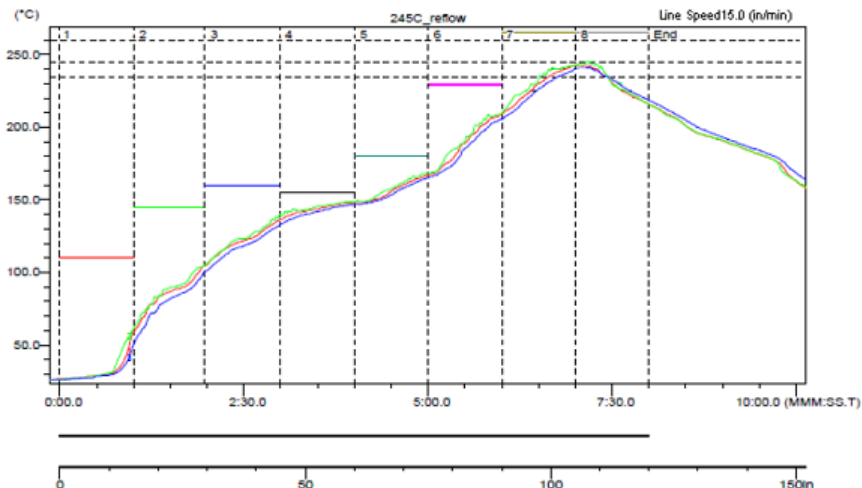

**Figure 44. Sample Reflow Profile**

**Table 2. Sample Reflow Profile Table**

PROBE	MAX TEMP (°C)	REACHED MAX TEMP	TIME ABOVE 235°C	REACHED 235°C	TIME ABOVE 245°C	REACHED 245°C	TIME ABOVE 260°C	REACHED 260°C
1	242.5	6.58	0.49	6.39	0.00	–	0.00	–
2	242.5	7.10	0.55	6.31	0.00	7.10	0.00	–
3	241.0	7.09	0.42	6.44	0.00	–	0.00	–

## 11 Device and Documentation Support

### 11.1 Device Support

#### 11.1.1 Third-Party Products Disclaimer

TI'S PUBLICATION OF INFORMATION REGARDING THIRD-PARTY PRODUCTS OR SERVICES DOES NOT CONSTITUTE AN ENDORSEMENT REGARDING THE SUITABILITY OF SUCH PRODUCTS OR SERVICES OR A WARRANTY, REPRESENTATION OR ENDORSEMENT OF SUCH PRODUCTS OR SERVICES, EITHER ALONE OR IN COMBINATION WITH ANY TI PRODUCT OR SERVICE.

#### 11.1.2 Development Support

For developmental support, see the following:

WEBENCH Tool, <http://www.ti.com/webench>

### 11.2 Documentation Support

#### 11.2.1 Related Documentation

For related documentation, see the following:

- AN-2027 *Inverting Application for the LMZ14203 SIMPLE SWITCHER Power Module*, ([SNVA425](#))
- *Absolute Maximum Ratings for Soldering*, ([SNOA549](#))
- AN-2024 *LMZ1420x / LMZ1200x Evaluation Board* ([SNVA422](#))
- AN-2085 *LMZ23605/03, LMZ22005/03 Evaluation Board* ([SNVA457](#))
- AN-2054 *Evaluation Board for LM10000 - PowerWise AVS System Controller* ([SNVA437](#))
- AN-2020 *Thermal Design By Insight, Not Hindsight* ([SNVA419](#))
- AN-2026 *Effect of PCB Design on Thermal Performance of SIMPLE SWITCHER Power Modules* ([SNVA424](#))
- *Design Summary LMZ1xxx and LMZ2xxx Power Modules Family* ([SNAA214](#))

### 11.3 Community Resources

The following links connect to TI community resources. Linked contents are provided "AS IS" by the respective contributors. They do not constitute TI specifications and do not necessarily reflect TI's views; see TI's [Terms of Use](#).

**TI E2E™ Online Community** *TI's Engineer-to-Engineer (E2E) Community*. Created to foster collaboration among engineers. At [e2e.ti.com](http://e2e.ti.com), you can ask questions, share knowledge, explore ideas and help solve problems with fellow engineers.

**Design Support** *TI's Design Support* Quickly find helpful E2E forums along with design support tools and contact information for technical support.

### 11.4 Trademarks

E2E is a trademark of Texas Instruments.

SIMPLE SWITCHER, WEBENCH are registered trademarks of Texas Instruments.

All other trademarks are the property of their respective owners.

### 11.5 Electrostatic Discharge Caution



These devices have limited built-in ESD protection. The leads should be shorted together or the device placed in conductive foam during storage or handling to prevent electrostatic damage to the MOS gates.

### 11.6 Glossary

[SLYZ022](#) — *TI Glossary*.

This glossary lists and explains terms, acronyms, and definitions.



## 12 Mechanical, Packaging, and Orderable Information

The following pages include mechanical, packaging, and orderable information. This information is the most current data available for the designated devices. This data is subject to change without notice and revision of this document. For browser-based versions of this data sheet, refer to the left-hand navigation.

**PACKAGING INFORMATION**

Orderable Device	Status (1)	Package Type	Package Drawing	Pins	Package Qty	Eco Plan (2)	Lead/Ball Finish (6)	MSL Peak Temp (3)	Op Temp (°C)	Device Marking (4/5)	Samples
LMZ12001TZ-ADJ/NOPB	ACTIVE	TO-PMOD	NDW	7	250	RoHS & Green	SN	Level-3-245C-168 HR	-40 to 125	LMZ12001 TZ-ADJ	<a href="#">Samples</a>
LMZ12001TZE-ADJ/NOPB	ACTIVE	TO-PMOD	NDW	7	45	RoHS & Green	SN	Level-3-245C-168 HR	-40 to 125	LMZ12001 TZ-ADJ	<a href="#">Samples</a>
LMZ12001TZX-ADJ/NOPB	ACTIVE	TO-PMOD	NDW	7	500	RoHS & Green	SN	Level-3-245C-168 HR	-40 to 125	LMZ12001 TZ-ADJ	<a href="#">Samples</a>

(1) The marketing status values are defined as follows:

**ACTIVE:** Product device recommended for new designs.

**LIFEBUY:** TI has announced that the device will be discontinued, and a lifetime-buy period is in effect.

**NRND:** Not recommended for new designs. Device is in production to support existing customers, but TI does not recommend using this part in a new design.

**PREVIEW:** Device has been announced but is not in production. Samples may or may not be available.

**OBsolete:** TI has discontinued the production of the device.

(2) **RoHS:** TI defines "RoHS" to mean semiconductor products that are compliant with the current EU RoHS requirements for all 10 RoHS substances, including the requirement that RoHS substance do not exceed 0.1% by weight in homogeneous materials. Where designed to be soldered at high temperatures, "RoHS" products are suitable for use in specified lead-free processes. TI may reference these types of products as "Pb-Free".

**RoHS Exempt:** TI defines "RoHS Exempt" to mean products that contain lead but are compliant with EU RoHS pursuant to a specific EU RoHS exemption.

**Green:** TI defines "Green" to mean the content of Chlorine (Cl) and Bromine (Br) based flame retardants meet JS709B low halogen requirements of <=1000ppm threshold. Antimony trioxide based flame retardants must also meet the <=1000ppm threshold requirement.

(3) MSL, Peak Temp. - The Moisture Sensitivity Level rating according to the JEDEC industry standard classifications, and peak solder temperature.

(4) There may be additional marking, which relates to the logo, the lot trace code information, or the environmental category on the device.

(5) Multiple Device Markings will be inside parentheses. Only one Device Marking contained in parentheses and separated by a "-" will appear on a device. If a line is indented then it is a continuation of the previous line and the two combined represent the entire Device Marking for that device.

(6) Lead/Ball Finish - Orderable Devices may have multiple material finish options. Finish options are separated by a vertical ruled line. Lead/Ball Finish values may wrap to two lines if the finish value exceeds the maximum column width.

**Important Information and Disclaimer:** The information provided on this page represents TI's knowledge and belief as of the date that it is provided. TI bases its knowledge and belief on information provided by third parties, and makes no representation or warranty as to the accuracy of such information. Efforts are underway to better integrate information from third parties. TI has taken and continues to take reasonable steps to provide representative and accurate information but may not have conducted destructive testing or chemical analysis on incoming materials and chemicals. TI and TI suppliers consider certain information to be proprietary, and thus CAS numbers and other limited information may not be available for release.

In no event shall TI's liability arising out of such information exceed the total purchase price of the TI part(s) at issue in this document sold by TI to Customer on an annual basis.

**TAPE AND REEL INFORMATION**

**QUADRANT ASSIGNMENTS FOR PIN 1 ORIENTATION IN TAPE**

\*All dimensions are nominal

Device	Package Type	Package Drawing	Pins	SPQ	Reel Diameter (mm)	Reel Width W1 (mm)	A0 (mm)	B0 (mm)	K0 (mm)	P1 (mm)	W (mm)	Pin1 Quadrant
LMZ12001TZ-ADJ/NOPB	TO-PMOD	NDW	7	250	330.0	24.4	10.6	14.22	5.0	16.0	24.0	Q2
LMZ12001TZX-ADJ/NOPB	TO-PMOD	NDW	7	500	330.0	24.4	10.6	14.22	5.0	16.0	24.0	Q2

**TAPE AND REEL BOX DIMENSIONS**

\*All dimensions are nominal

Device	Package Type	Package Drawing	Pins	SPQ	Length (mm)	Width (mm)	Height (mm)
LMZ12001TZ-ADJ/NOPB	TO-PMOD	NDW	7	250	367.0	367.0	45.0
LMZ12001TZX-ADJ/NOPB	TO-PMOD	NDW	7	500	367.0	367.0	45.0

**TUBE**

\*All dimensions are nominal

Device	Package Name	Package Type	Pins	SPQ	L (mm)	W (mm)	T (μm)	B (mm)
LMZ12001TZE-ADJ/NOPB	NDW	TO-PMOD	7	45	502	17	6700	8.4

NDW0007A

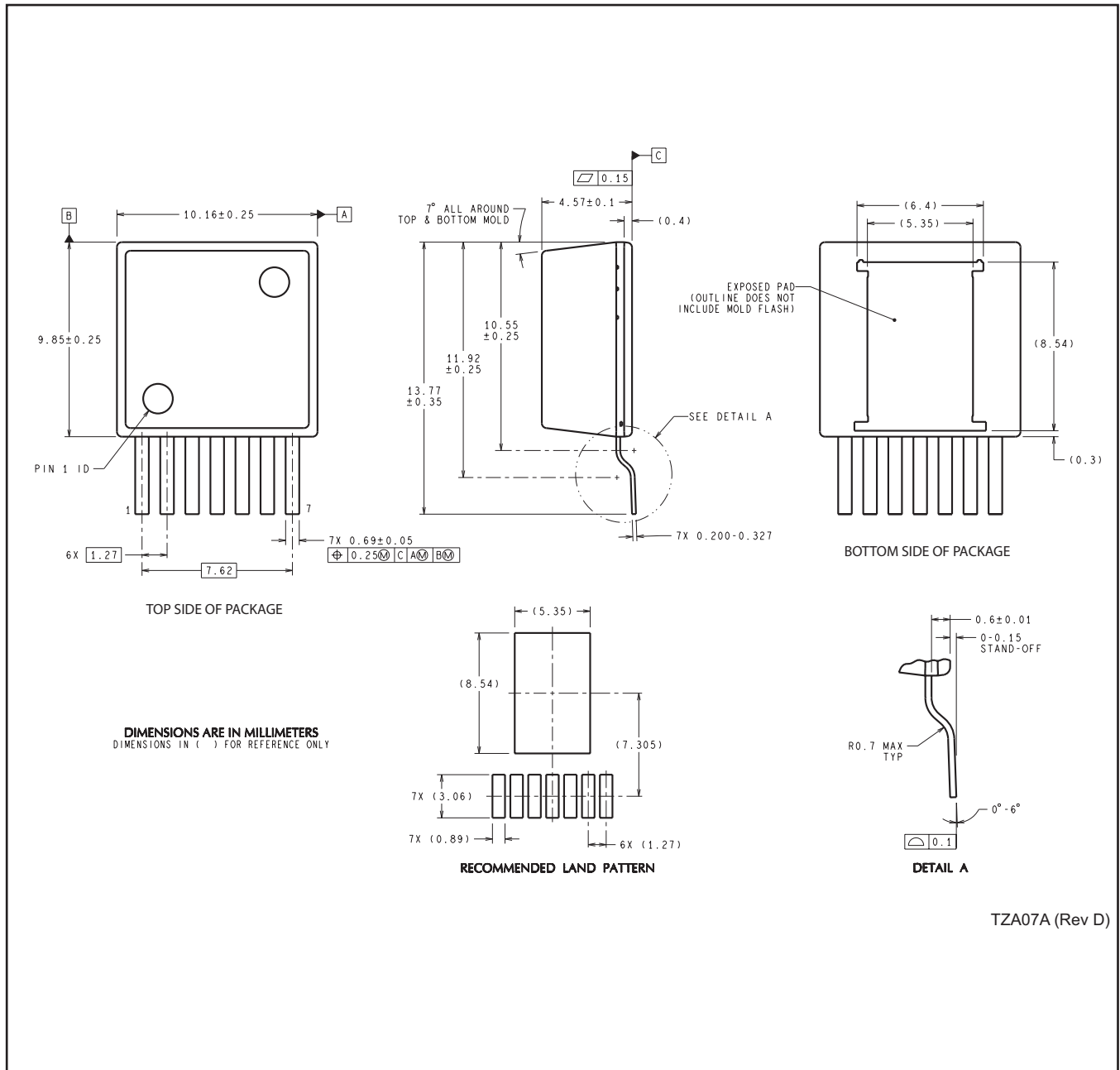

TZA07A (Rev D)

## IMPORTANT NOTICE AND DISCLAIMER

TI PROVIDES TECHNICAL AND RELIABILITY DATA (INCLUDING DATA SHEETS), DESIGN RESOURCES (INCLUDING REFERENCE DESIGNS), APPLICATION OR OTHER DESIGN ADVICE, WEB TOOLS, SAFETY INFORMATION, AND OTHER RESOURCES "AS IS" AND WITH ALL FAULTS, AND DISCLAIMS ALL WARRANTIES, EXPRESS AND IMPLIED, INCLUDING WITHOUT LIMITATION ANY IMPLIED WARRANTIES OF MERCHANTABILITY, FITNESS FOR A PARTICULAR PURPOSE OR NON-INFRINGEMENT OF THIRD PARTY INTELLECTUAL PROPERTY RIGHTS.

These resources are intended for skilled developers designing with TI products. You are solely responsible for (1) selecting the appropriate TI products for your application, (2) designing, validating and testing your application, and (3) ensuring your application meets applicable standards, and any other safety, security, regulatory or other requirements.

These resources are subject to change without notice. TI grants you permission to use these resources only for development of an application that uses the TI products described in the resource. Other reproduction and display of these resources is prohibited. No license is granted to any other TI intellectual property right or to any third party intellectual property right. TI disclaims responsibility for, and you will fully indemnify TI and its representatives against, any claims, damages, costs, losses, and liabilities arising out of your use of these resources.

TI's products are provided subject to [TI's Terms of Sale](#) or other applicable terms available either on [ti.com](http://ti.com) or provided in conjunction with such TI products. TI's provision of these resources does not expand or otherwise alter TI's applicable warranties or warranty disclaimers for TI products.

TI objects to and rejects any additional or different terms you may have proposed.

Mailing Address: Texas Instruments, Post Office Box 655303, Dallas, Texas 75265  
Copyright © 2022, Texas Instruments Incorporated