



12-Bit, 500-/550-MSPS Analog-to-Digital Converters

FEATURES

- 12-Bit Resolution
- On-Chip Analog Buffer
- ADS5463: 500 MSPS
- ADS5463 SFDR: 77dBc at 300 MHz f_{IN}
- ADS54RF63: 550 MSPS
- ADS54RF63 SFDR: 70dBc at 900 MHz f_{IN}
- 2.3-GHz Input Bandwidth
- LVDS-Compatible Outputs
- Very Low Latency: 3.5 Clock Cycles
- High Analog Input Swing without Damage, $> 10 V_{pp}$ Differential-AC Signal
- Total Power Dissipation: 2.2 W
- 80-Pin TQFP PowerPAD™ Package (14-mm × 14-mm footprint)

- Industrial Temperature Range: -40°C to 85°C
- Pin-Similar/Compatible to 12-, 13-, and 14-Bit Family: ADS5440/ADS5444/ADS5474

APPLICATIONS

- Test and Measurement Instrumentation
- Software-Defined Radio
- Data Acquisition
- Power Amplifier Linearization
- Communication Instrumentation
- Radar

DESCRIPTION

The ADS5463/ADS54RF63 is a 12-bit, 500-/550-MSPS analog-to-digital converter (ADC) that operates from both a 5-V supply and 3.3-V supply, while providing LVDS-compatible digital outputs. This ADC is one of a family of 12-, 13-, and 14-bit ADCs that operate from 210 MSPS to 550 MSPS. The ADS5463/ADS54RF63 input buffer isolates the internal switching of the onboard track and hold (T&H) from disturbing the signal source while providing a high-impedance input.

The ADS54RF63 provides superior SFDR compared to the ADS5463 when the analog input frequency exceeds ~350 MHz or if operation up to 550 MSPS is required.

The ADS5463/ADS54RF63 is available in a TQFP-80 PowerPAD™ package. The ADS5463/ADS54RF63 is built on the Texas Instrument complementary bipolar process (BiCom3) and specified over the full industrial temperature range (-40°C to 85°C).

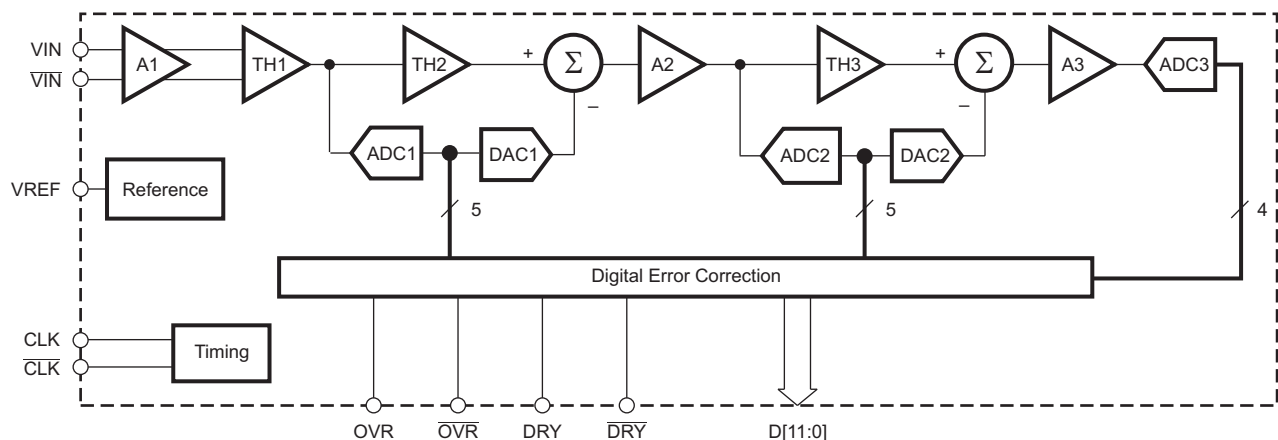

B0061-03



Please be aware that an important notice concerning availability, standard warranty, and use in critical applications of Texas Instruments semiconductor products and disclaimers thereto appears at the end of this data sheet.

PowerPAD is a trademark of Texas Instruments.

All other trademarks are the property of their respective owners.



This integrated circuit can be damaged by ESD. Texas Instruments recommends that all integrated circuits be handled with appropriate precautions. Failure to observe proper handling and installation procedures can cause damage.

ESD damage can range from subtle performance degradation to complete device failure. Precision integrated circuits may be more susceptible to damage because small parametric changes could cause the device not to meet its published specifications.

PACKAGE/ORDERING INFORMATION

PRODUCT	PACKAGE-LEAD	PACKAGE DESIGNATOR ⁽¹⁾	SPECIFIED TEMPERATURE RANGE	PACKAGE MARKING	ORDERING NUMBER	TRANSPORT MEDIA, QUANTITY
ADS5463	HTQFP-80 ⁽²⁾ PowerPAD	PFP	-40°C to 85°C	ADS5463I	ADS5463IPFP	Tray, 96
					ADS5463IPFPR	Tape and reel, 1000
ADS54RF63	HTQFP-80 ⁽²⁾ PowerPAD	PFP	-40°C to 85°C	ADS54RF63I	ADS54RF63IPFP	Tray, 96
					ADS54RF63IPFPR	Tape and reel, 1000

- (1) For the most current product and ordering information, see the Package Option Addendum located at the end of this data sheet.
 (2) Thermal pad size: 6.15 mm x 6.15 mm (min), 7.5 mm x 7.5 mm (maximum), see Thermal Pad Addendum located at the end of the data sheet.

ABSOLUTE MAXIMUM RATINGS

over operating free-air temperature range (unless otherwise noted) ⁽¹⁾

			ADS5463/ADS54RF63	UNIT
Supply voltage	AVDD5 to GND		6	V
	AVDD3 to GND		5	
	DVDD3 to GND		5	
AIN, $\overline{\text{AIN}}$ to GND ⁽²⁾	Voltage difference between pin and ground	AC Signal	-0.3 to (AVDD5 + 0.3)	V
		DC signal, T _J = 105°C	0.4 to 4.4	
		DC signal, T _J = 125°C	1.0 to 3.8	
AIN to $\overline{\text{AIN}}$ ⁽²⁾	Voltage difference between these pins	AC Signal	-5.2 to 5.2	V
		DC Signal, T _J = 105°C	-4.0 to 4.0	
		DC signal, T _J = 125°C	-2.8 to 2.8	
CLK, $\overline{\text{CLK}}$ to GND ⁽²⁾	Voltage difference between pin and ground	AC signal	-0.3 to (AVDD5 + 0.3)	V
		DC signal, T _J = 105°C	0.1 to 4.7	
		DC signal, T _J = 125°C	1.1 to 3.7	
CLK to $\overline{\text{CLK}}$ ⁽²⁾	Voltage difference between these pins	AC Signal	-3.3 to 3.3	V
		DC signal, T _J = 105°C	-3.3 to 3.3	
		DC signal, T _J = 125°C	-2.6 to 2.6	
Data output to GND ⁽²⁾	LVDS digital outputs		-0.3 to (DVDD3 + 0.3)	V
Operating temperature range			-40 to 85	°C
Maximum junction temperature (max T _J)			150	°C
Storage temperature range			-65 to 150	°C
ESD, human-body model (HBM)			2	kV

- (1) Stresses above these ratings may cause permanent damage. Exposure to absolute maximum conditions for extended periods may degrade device reliability. These are stress ratings only, and functional operation of the device at these or any other conditions beyond those specified is not implied. Kirkendall voidings and current density information for calculation of expected lifetime is available upon request.
 (2) Valid when supplies are within recommended operating range.

THERMAL CHARACTERISTICS⁽¹⁾

PARAMETER	TEST CONDITIONS	TYP	UNIT
$R_{\theta JA}$ ⁽²⁾	Soldered thermal pad, no airflow	23.7	°C/W
	Soldered thermal pad, 150-LFM airflow	17.8	
	Soldered thermal pad, 250-LFM airflow	16.4	
$R_{\theta JP}$ ⁽³⁾	Bottom of package (thermal pad)	2.99	°C/W

(1) Using 36 thermal vias (6 × 6 array). See [PowerPAD Package](#) in the *Application Information* section.

(2) $R_{\theta JA}$ is the thermal resistance from the junction to ambient.

(3) $R_{\theta JP}$ is the thermal resistance from the junction to the thermal pad.

RECOMMENDED OPERATING CONDITIONS

	ADS54RF63			ADS5463			UNIT
	MIN	NOM	MAX	MIN	NOM	MAX	
T_A Open free-air temperature	–40		85	–40		85	°C
SUPPLIES							
AVDD5 Analog supply voltage	4.75	5	5.25	4.75	5	5.25	V
AVDD3 Analog supply voltage	3.0	3.3	3.6	3.0	3.3	3.6	V
DVDD3 Output driver supply voltage	3.0	3.3	3.6	3.0	3.3	3.6	V
ANALOG INPUT							
Differential input range		2.2			2.2		V_{pp}
VCM Input common mode		2.4			2.4		V
DIGITAL OUTPUT (DRY, DATA, OVR)							
Maximum differential output load		10			10		pF
CLOCK INPUT (CLK)							
CLK input sample rate (sine wave)	40		550	20		500	MSPS
Clock amplitude, differential sine wave, see Figure 59	0.5		3.5	0.5		3.5	V_{pp}
Clock duty cycle, see Figure 64	40%	50%	60%	40%	50%	60%	

ELECTRICAL CHARACTERISTICS

Typical values at $T_A = 25^\circ\text{C}$, minimum and maximum values over full temperature range $T_{\text{MIN}} = -40^\circ\text{C}$ to $T_{\text{MAX}} = 85^\circ\text{C}$, ADS5463 sampling rate = 500 MSPS, ADS54RF63 sampling rate = 550 MSPS, 50% clock duty cycle, AVDD5 = 5 V, AVDD3 = 3.3 V, DVDD3 = 3.3 V, -1-dBFS differential input, and $3\text{-}V_{\text{PP}}$ differential clock, unless otherwise noted

PARAMETER	TEST CONDITIONS	ADS54RF63			ADS5463			UNIT
		MIN	TYP	MAX	MIN	TYP	MAX	
Resolution			12			12		Bits
ANALOG INPUTS								
	Differential input		2.2			2.2		V_{PP}
VCM	Common-mode voltage	Self-biased	2.4			2.4		V
	Input resistance	To VCM	500			500		Ω
	Input capacitance	To ground (un-soldered package)	2.3			2.3		pF
	Input bandwidth	(-3 dB)	2.3			2.3		GHz
CMRR	Common-mode rejection ratio	Common mode signal = 10 MHz	90			90		dB
CLOCK INPUTS								
	Input resistance	To internal common-mode	1000			1000		Ω
	Input capacitance	To ground (un-soldered package)	1.5			1.5		pF
	Common mode	Internally generated	2.4			2.4		V
INTERNAL REFERENCE VOLTAGE								
V_{REF}	Reference voltage		2.4			2.4		V

ELECTRICAL CHARACTERISTICS (continued)

Typical values at $T_A = 25^\circ\text{C}$, minimum and maximum values over full temperature range $T_{\text{MIN}} = -40^\circ\text{C}$ to $T_{\text{MAX}} = 85^\circ\text{C}$, ADS5463 sampling rate = 500 MSPS, ADS54RF63 sampling rate = 550 MSPS, 50% clock duty cycle, AVDD5 = 5 V, AVDD3 = 3.3 V, DVDD3 = 3.3 V, -1-dBFS differential input, and $3\text{-}V_{\text{PP}}$ differential clock, unless otherwise noted

PARAMETER	TEST CONDITIONS	ADS54RF63			ADS5463			UNIT	
		MIN	TYP	MAX	MIN	TYP	MAX		
DYNAMIC ACCURACY									
	No missing codes	Specified			Specified				
DNL	Differential linearity error	$f_{\text{IN}} = 10\text{ MHz}$	-0.95	± 0.5	0.95	-0.95	± 0.25	0.95	LSB
INL	Integral linearity error	500MSPS, $f_{\text{IN}} = 10\text{ MHz}$	-2.5	± 0.7	2.5	-2.5	+0.8/-0.3	2.5	LSB
		550MSPS, $f_{\text{IN}} = 10\text{ MHz}$	-4.5	± 1.5	4.5	NA			LSB
	Offset error		-11		11	-11		11	mV
	Offset temperature coefficient		0.0005			0.0005			mV/°C
	Gain error		-5		5	-5		5	%FS
	Gain temperature coefficient		-0.02			-0.02			%FS/°C
POWER SUPPLY									
I_{AVDD5}	5-V analog supply current	$V_{\text{IN}} = \text{full scale}, f_{\text{IN}} = 10\text{ MHz}$		310	340		300	330	mA
I_{AVDD3}	3.3-V analog supply current			140	155		125	138	mA
I_{DVDD3}	3.3-V digital supply current (includes LVDS)			82	88		82	88	mA
	Total power dissipation		2.25		2.5	2.18		2.4	W
	Power-up time		200			200			μs
PSRR	Power-supply rejection ratio	Without 0.1- μF board supply capacitors, with 100-kHz supply noise	85			85			dB

ELECTRICAL CHARACTERISTICS (continued)

Typical values at $T_A = 25^\circ\text{C}$, minimum and maximum values over full temperature range $T_{\text{MIN}} = -40^\circ\text{C}$ to $T_{\text{MAX}} = 85^\circ\text{C}$, ADS5463 sampling rate = 500 MSPS, ADS54RF63 sampling rate = 550 MSPS, 50% clock duty cycle, AVDD5 = 5 V, AVDD3 = 3.3 V, DVDD3 = 3.3 V, -1-dBFS differential input, and $3\text{-}V_{\text{PP}}$ differential clock, unless otherwise noted

PARAMETER		TEST CONDITIONS	ADS54RF63			ADS5463			UNIT
			MIN	TYP	MAX	MIN	TYP	MAX	
DYNAMIC AC CHARACTERISTICS									
CLK	Maximum clock frequency		550			500			MHz
RMS idle-channel noise		Inputs tied to common-mode	0.8			0.7			LSB
SNR, Signal-to-Noise Ratio									
SNR	$f_S = 500\text{MSPS}$	$f_{\text{IN}} = 10\text{ MHz}$	64.7			65.4			dBFS
		$f_{\text{IN}} = 70\text{ MHz}$	64.6			65.4			
		$f_{\text{IN}} = 100\text{ MHz}$	64.6			63.5	65.3		
		$f_{\text{IN}} = 230\text{ MHz}$	64.4			65.1			
		$f_{\text{IN}} = 300\text{ MHz}$	62.5	64.3		63	65		
		$f_{\text{IN}} = 450\text{ MHz}$	64.1			64.6			
		$f_{\text{IN}} = 650\text{ MHz}$	63.5			63.9			
		$f_{\text{IN}} = 900\text{ MHz}$	62.5			62.6			
	$f_{\text{IN}} = 1.3\text{ GHz}$	61			59.3				
	$f_S = 550\text{MSPS}$	$f_{\text{IN}} = 100\text{ MHz}$	62.6			NA			
		$f_{\text{IN}} = 450\text{ MHz}$	59	61.9		NA			
$f_{\text{IN}} = 1.3\text{ GHz}$		59.3			NA				
SFDR, Spurious-Free Dynamic Range									
SFDR	$f_S = 500\text{MSPS}$	$f_{\text{IN}} = 10\text{ MHz}$	85			85			dBc
		$f_{\text{IN}} = 70\text{ MHz}$	83			82			
		$f_{\text{IN}} = 100\text{ MHz}$	84			70	82		
		$f_{\text{IN}} = 230\text{ MHz}$	81			78			
		$f_{\text{IN}} = 300\text{ MHz}$	64	78		64	77		
		$f_{\text{IN}} = 450\text{ MHz}$	80			75			
		$f_{\text{IN}} = 650\text{ MHz}$	75			65			
		$f_{\text{IN}} = 900\text{ MHz}$	70			56			
	$f_{\text{IN}} = 1.3\text{ GHz}$	58			45				
	$f_S = 550\text{MSPS}$	$f_{\text{IN}} = 100\text{ MHz}$	76			NA			
		$f_{\text{IN}} = 450\text{ MHz}$	62	75		NA			
$f_{\text{IN}} = 1.3\text{ GHz}$		57			NA				

ELECTRICAL CHARACTERISTICS (continued)

Typical values at $T_A = 25^\circ\text{C}$, minimum and maximum values over full temperature range $T_{\text{MIN}} = -40^\circ\text{C}$ to $T_{\text{MAX}} = 85^\circ\text{C}$, ADS5463 sampling rate = 500 MSPS, ADS54RF63 sampling rate = 550 MSPS, 50% clock duty cycle, AVDD5 = 5 V, AVDD3 = 3.3 V, DVDD3 = 3.3 V, -1-dBFS differential input, and 3- V_{PP} differential clock, unless otherwise noted

PARAMETER	TEST CONDITIONS	ADS54RF63			ADS5463			UNIT
		MIN	TYP	MAX	MIN	TYP	MAX	
HD2, Second Harmonic								
HD2	$f_S = 500\text{MSPS}$	$f_{\text{IN}} = 10\text{ MHz}$		87		87		dBc
		$f_{\text{IN}} = 70\text{ MHz}$		87		82		
		$f_{\text{IN}} = 100\text{ MHz}$		85	70	80		
		$f_{\text{IN}} = 230\text{ MHz}$		83		81		
		$f_{\text{IN}} = 300\text{ MHz}$	64	79	64	77		
		$f_{\text{IN}} = 450\text{ MHz}$		81		80		
		$f_{\text{IN}} = 650\text{ MHz}$		75		77		
		$f_{\text{IN}} = 900\text{ MHz}$		70		66		
	$f_{\text{IN}} = 1.3\text{ GHz}$		58		50			
	$f_S = 550\text{MSPS}$	$f_{\text{IN}} = 100\text{ MHz}$		84		NA		
		$f_{\text{IN}} = 450\text{ MHz}$	62	78		NA		
$f_{\text{IN}} = 1.3\text{ GHz}$			63		NA			
HD3, Third Harmonic								
HD3	$f_S = 500\text{MSPS}$	$f_{\text{IN}} = 10\text{ MHz}$		90		85		dBc
		$f_{\text{IN}} = 70\text{ MHz}$		92		90		
		$f_{\text{IN}} = 100\text{ MHz}$		89	70	87		
		$f_{\text{IN}} = 230\text{ MHz}$		85		90		
		$f_{\text{IN}} = 300\text{ MHz}$	64	83	64	80		
		$f_{\text{IN}} = 450\text{ MHz}$		90		75		
		$f_{\text{IN}} = 650\text{ MHz}$		76		65		
		$f_{\text{IN}} = 900\text{ MHz}$		78		56		
	$f_{\text{IN}} = 1.3\text{ GHz}$		58		45			
	$f_S = 550\text{MSPS}$	$f_{\text{IN}} = 100\text{ MHz}$		76		NA		
		$f_{\text{IN}} = 450\text{ MHz}$	62	75		NA		
$f_{\text{IN}} = 1.3\text{ GHz}$			57		NA			
Worst Harmonic/Spur (other than HD2 and HD3)								
Worst non-HD2/3	$f_S = 500\text{MSPS}$	$f_{\text{IN}} = 10\text{ MHz}$		86		86		dBc
		$f_{\text{IN}} = 70\text{ MHz}$		86		86		
		$f_{\text{IN}} = 100\text{ MHz}$		86		86		
		$f_{\text{IN}} = 230\text{ MHz}$		83		77		
		$f_{\text{IN}} = 300\text{ MHz}$		82		81		
		$f_{\text{IN}} = 450\text{ MHz}$		86		86		
		$f_{\text{IN}} = 650\text{ MHz}$		85		85		
		$f_{\text{IN}} = 900\text{ MHz}$		82		78		
	$f_{\text{IN}} = 1.3\text{ GHz}$		78		67			
	$f_S = 550\text{MSPS}$	$f_{\text{IN}} = 100\text{ MHz}$		82		NA		
		$f_{\text{IN}} = 450\text{ MHz}$		81		NA		
$f_{\text{IN}} = 1.3\text{ GHz}$			74		NA			

ELECTRICAL CHARACTERISTICS (continued)

Typical values at $T_A = 25^\circ\text{C}$, minimum and maximum values over full temperature range $T_{\text{MIN}} = -40^\circ\text{C}$ to $T_{\text{MAX}} = 85^\circ\text{C}$, ADS5463 sampling rate = 500 MSPS, ADS54RF63 sampling rate = 550 MSPS, 50% clock duty cycle, AVDD5 = 5 V, AVDD3 = 3.3 V, DVDD3 = 3.3 V, -1-dBFS differential input, and 3- V_{PP} differential clock, unless otherwise noted

PARAMETER	TEST CONDITIONS	ADS54RF63			ADS5463			UNIT
		MIN	TYP	MAX	MIN	TYP	MAX	
THD, Total Harmonic Distortion								
THD	$f_S = 500\text{MSPS}$	$f_{\text{IN}} = 10\text{ MHz}$		82		80		dBc
		$f_{\text{IN}} = 70\text{ MHz}$		82		79		
		$f_{\text{IN}} = 100\text{ MHz}$		80		77		
		$f_{\text{IN}} = 230\text{ MHz}$		78		75		
		$f_{\text{IN}} = 300\text{ MHz}$		76		73		
		$f_{\text{IN}} = 450\text{ MHz}$		77		73		
		$f_{\text{IN}} = 650\text{ MHz}$		69		64		
		$f_{\text{IN}} = 900\text{ MHz}$		64		55		
	$f_{\text{IN}} = 1.3\text{ GHz}$		56		44			
	$f_S = 550\text{MSPS}$	$f_{\text{IN}} = 100\text{ MHz}$		74		NA		
		$f_{\text{IN}} = 450\text{ MHz}$		72		NA		
$f_{\text{IN}} = 1.3\text{ GHz}$			56		NA			
SINAD, Signal-to-Noise and Distortion								
SINAD	$f_S = 500\text{MSPS}$	$f_{\text{IN}} = 10\text{ MHz}$		63.6		64.2		dBc
		$f_{\text{IN}} = 70\text{ MHz}$		63.5		64.2		
		$f_{\text{IN}} = 100\text{ MHz}$		63.5	62	64.1		
		$f_{\text{IN}} = 230\text{ MHz}$		63.2		63.7		
		$f_{\text{IN}} = 300\text{ MHz}$	60	63.1		63.5		
		$f_{\text{IN}} = 450\text{ MHz}$		62.9		63.1		
		$f_{\text{IN}} = 650\text{ MHz}$		61.5		60.5		
		$f_{\text{IN}} = 900\text{ MHz}$		59.6		54.4		
	$f_{\text{IN}} = 1.3\text{ GHz}$		54.4		44.1			
	$f_S = 550\text{MSPS}$	$f_{\text{IN}} = 100\text{ MHz}$		61.3		NA		
		$f_{\text{IN}} = 450\text{ MHz}$	57	60.1		NA		
$f_{\text{IN}} = 1.3\text{ GHz}$			54		NA			
ENOB, Effective Number of Bits (from SINAD in dBc) ⁽¹⁾								
ENOB	$f_S = 500\text{MSPS}$	$f_{\text{IN}} = 100\text{ MHz}$		10.3	10	10.4		Bits
		$f_{\text{IN}} = 300\text{ MHz}$	9.67	10.2		10.4		
		$f_{\text{IN}} = 900\text{ MHz}$		9.6		8.7		
		$f_{\text{IN}} = 1.3\text{ GHz}$		8.7		7		
	$f_S = 550\text{MSPS}$	$f_{\text{IN}} = 450\text{ MHz}$	9.18	9.7		NA		
		$f_{\text{IN}} = 1.3\text{ GHz}$		8.7		NA		

(1) $\text{ENOB} = [\text{SINAD}(\text{dBc}) - 1.76] / 6.02$

ELECTRICAL CHARACTERISTICS (continued)

Typical values at $T_A = 25^\circ\text{C}$, minimum and maximum values over full temperature range $T_{\text{MIN}} = -40^\circ\text{C}$ to $T_{\text{MAX}} = 85^\circ\text{C}$, ADS5463 sampling rate = 500 MSPS, ADS54RF63 sampling rate = 550 MSPS, 50% clock duty cycle, AVDD5 = 5 V, AVDD3 = 3.3 V, DVDD3 = 3.3 V, -1-dBFS differential input, and 3- V_{PP} differential clock, unless otherwise noted

PARAMETER	TEST CONDITIONS	ADS54RF63			ADS5463			UNIT	
		MIN	TYP	MAX	MIN	TYP	MAX		
Two-Tone SFDR									
2-tone SFDR	$f_s = 500\text{MSPS}$	$f_{\text{IN}1} = 65\text{ MHz}, f_{\text{IN}2} = 70\text{ MHz},$ each tone at -7 dBFS	90			90			dBFS
		$f_{\text{IN}1} = 65\text{ MHz}, f_{\text{IN}2} = 70\text{ MHz},$ each tone at -16 dBFS	90			89			
		$f_{\text{IN}1} = 350\text{ MHz}, f_{\text{IN}2} = 355\text{ MHz},$ each tone at -7 dBFS	90			82			
		$f_{\text{IN}1} = 350\text{ MHz}, f_{\text{IN}2} = 355\text{ MHz},$ each tone at -16 dBFS	90			89			
	$f_s = 550\text{MSPS}$	$f_{\text{IN}1} = 397.5\text{ MHz}, f_{\text{IN}2} = 402.5\text{ MHz},$ each tone at -7 dBFS	90			NA			
		$f_{\text{IN}1} = 647.5\text{ MHz}, f_{\text{IN}2} = 652.5\text{ MHz},$ each tone at -7 dBFS	84			NA			
LVDS DIGITAL OUTPUTS									
V_{OD}	Differential output voltage (\pm)	247	350	454	247	350	454	mV	
V_{OC}	Common-mode output voltage	1.125		1.375	1.125		1.375	V	

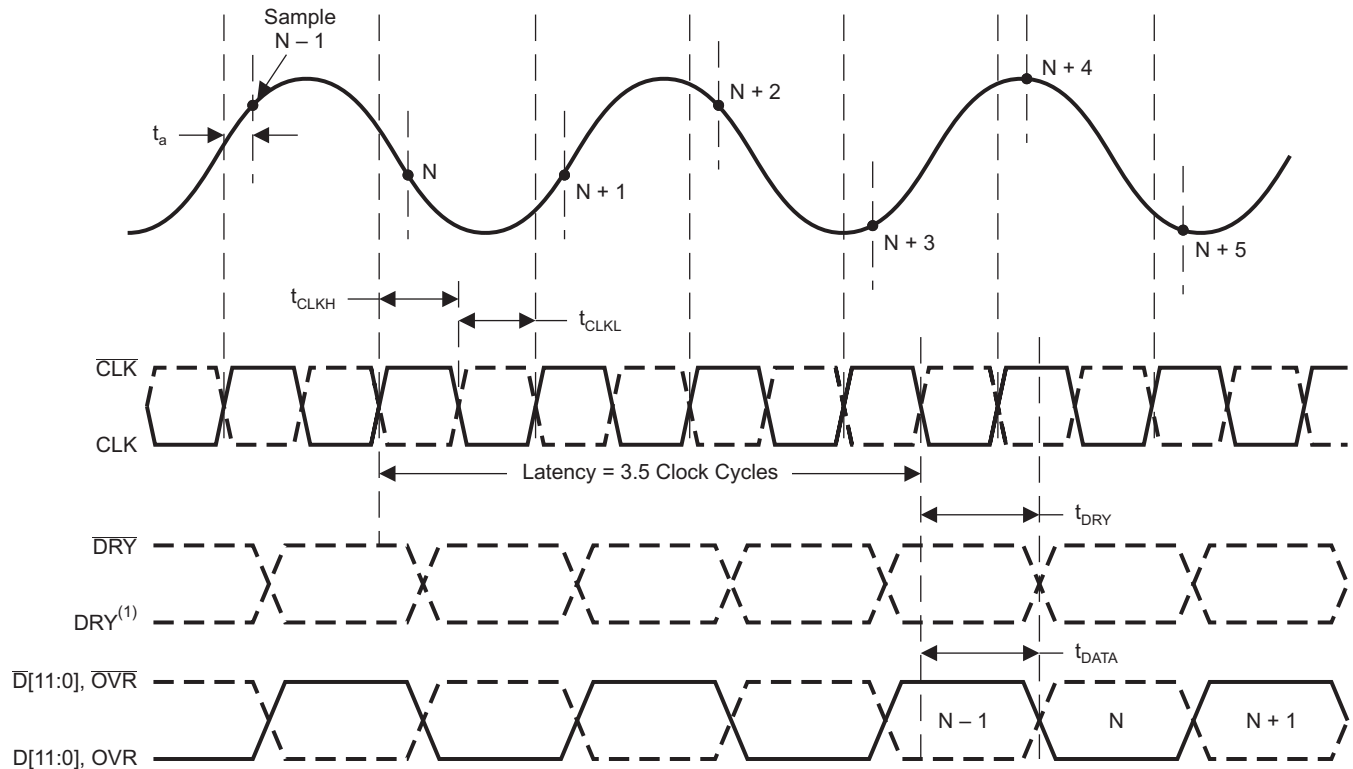

T0158-01

(1) Polarity of DRY is undetermined. For further information, see the Digital Outputs section.

Figure 1. Timing Diagram

TIMING CHARACTERISTICS⁽¹⁾

Typical values at $T_A = 25^\circ\text{C}$, minimum and maximum values over full temperature range $T_{\text{MIN}} = -40^\circ\text{C}$ to $T_{\text{MAX}} = 85^\circ\text{C}$, sampling rate = maximum rated, 50% clock duty cycle, AVDD5 = 5 V, AVDD3 = 3.3 V, DVDD3 = 3.3 V, and 3- V_{PP} differential clock (unless otherwise noted)

PARAMETER	TEST CONDITIONS	ADS54RF63			ADS5463			UNIT		
		MIN	TYP	MAX	MIN	TYP	MAX			
t_a	Aperture delay		200		200			ps		
	Aperture jitter, rms		150		150			fs		
	Latency		3.5		3.5			cycles		
t_{CLK}	Clock period	1.8181		50	2		50	ns		
t_{CLKH}	Clock pulse duration, high	Assumes min 40% duty cycle		0.727	0.8			ns		
t_{CLKL}	Clock pulse duration, low			0.727	0.8			ns		
t_{DRY}	CLK to DRY delay ⁽²⁾	Zero crossing		1350	1750	950	1600	ps		
t_{DATA}	CLK to DATA/OVR delay ⁽²⁾	Zero crossing		1100	2000	750	2100	ps		
t_{SKEW}	DATA to DRY skew	$t_{\text{DATA}} - t_{\text{DRY}}$		-250	0	250	-350	0	650	ps
t_{RISE}	DRY/DATA/OVR rise time			500				ps		
t_{FALL}	DRY/DATA/OVR fall time			500				ps		

- (1) Timing parameters are specified by design or characterization, but not production tested. <10pF load on each output pin.
 (2) DRY, DATA, and OVR are updated on the falling edge of CLK. The latency must be added to t_{DATA} to determine the overall propagation delay.

PIN CONFIGURATION

PFP PACKAGE
(TOP VIEW)

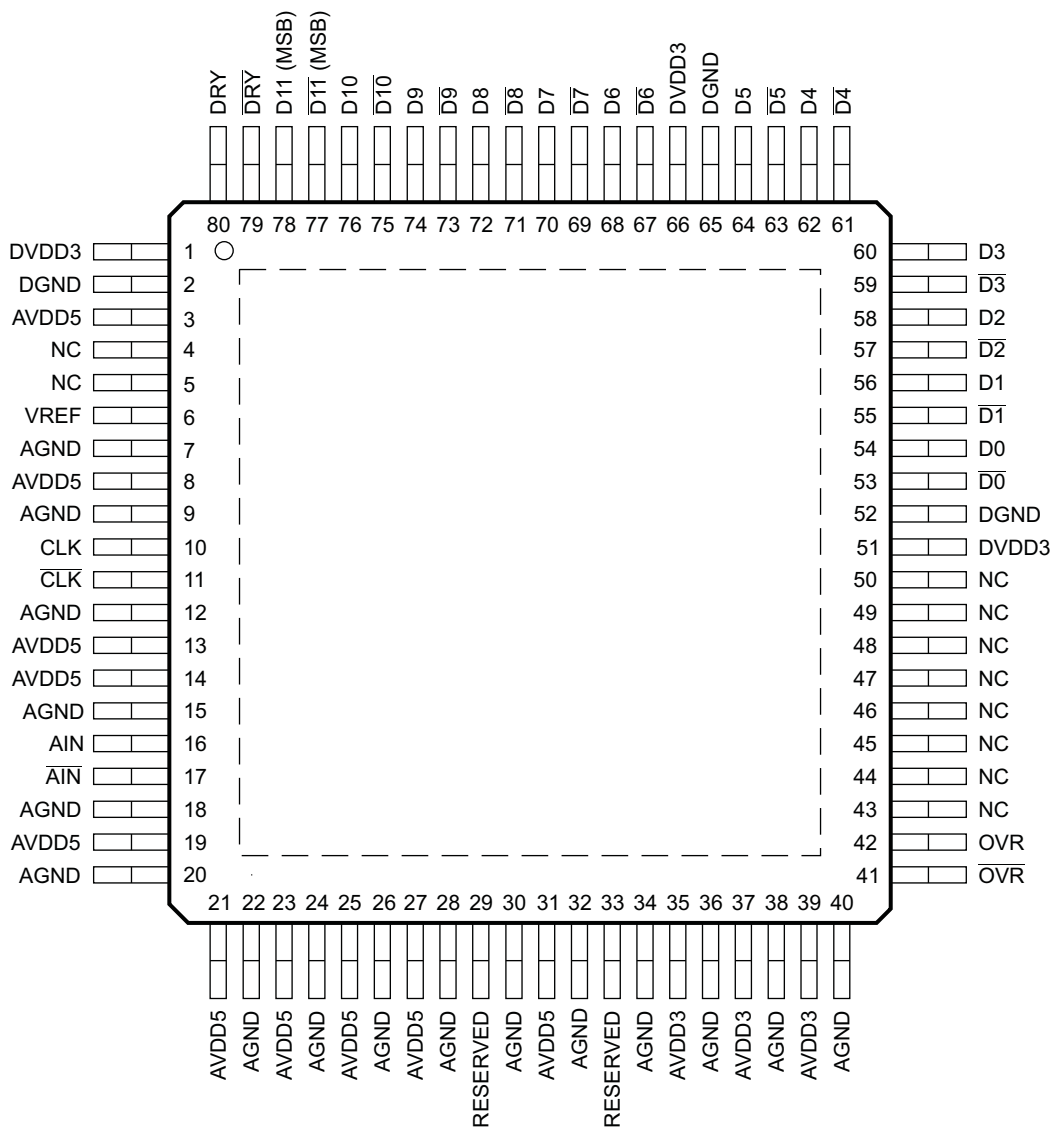

P0027-02

Table 1. PIN FUNCTIONS

PIN		DESCRIPTION
NAME	NO.	
AIN	16	Differential input signal (positive)
$\overline{\text{AIN}}$	17	Differential input signal (negative)
AVDD5	3, 8, 13, 14, 19, 21, 23, 25, 27, 31	Analog power supply (5 V)
AVDD3	35, 37, 39	Analog power supply (3.3 V) (Suggestion for ≤ 250 MSPS: leave option to connect to 5 V for ADS5440/4 13-bit compatibility)
DVDD3	1, 51, 66	Output driver power supply (3.3 V)
AGND	7, 9, 12, 15, 18, 20, 22, 24, 26, 28, 30, 32, 34, 36, 38, 40	Analog ground
(Power Pad)	(81)	Power pad for thermal relief, also analog ground
DGND	2, 52, 65	Digital ground
CLK	10	Differential input clock (positive). Conversion is initiated on rising edge.
$\overline{\text{CLK}}$	11	Differential input clock (negative)
D0–D11	54, 56, 58, 60, 62, 64, 68, 70, 72, 74, 76, 78	LVDS digital output pairs (D0/ $\overline{\text{D0}}$ is LSB pair. D11/ $\overline{\text{D11}}$ is MSB pair.)
$\overline{\text{D0}}\text{--}\overline{\text{D11}}$	53, 55, 57, 59, 61, 63, 67, 69, 71, 73, 75, 77	
DRY, $\overline{\text{DRY}}$	80, 79	Data ready LVDS output pair
NC	4, 5, 43–50	No connect (4 and 5 should be left floating, 43–50 are possible future bit additions for this pinout and therefore can be connected to a digital bus or left floating)
OVR, $\overline{\text{OVR}}$	42, 41	Overrange indicator LVDS output. A logic high signals an analog input in excess of the full-scale range.
RESERVED	29, 33	Pin 29 is reserved for possible future Vcm output for this pinout, like ADS5474; pin 33 is reserved for possible future power-down control pin for this pinout, like ADS5474.
VREF	6	Reference voltage input/output (2.4 V nominal). Connect 0.1- μF capacitor from VREF to AGND.

ADS5463 TYPICAL CHARACTERISTICS

Typical plots at $T_A = 25^\circ\text{C}$, sampling rate = 500 MSPS, 50% clock duty cycle, $AVDD5 = 5\text{ V}$, $AVDD3 = 3.3\text{ V}$, $DVDD3 = 3.3\text{ V}$, and 3- V_{PP} differential clock, (unless otherwise noted)

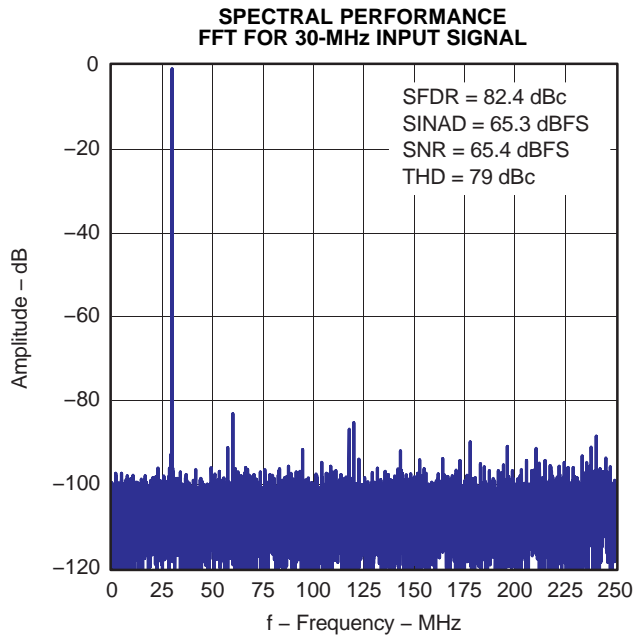

Figure 2.

G001

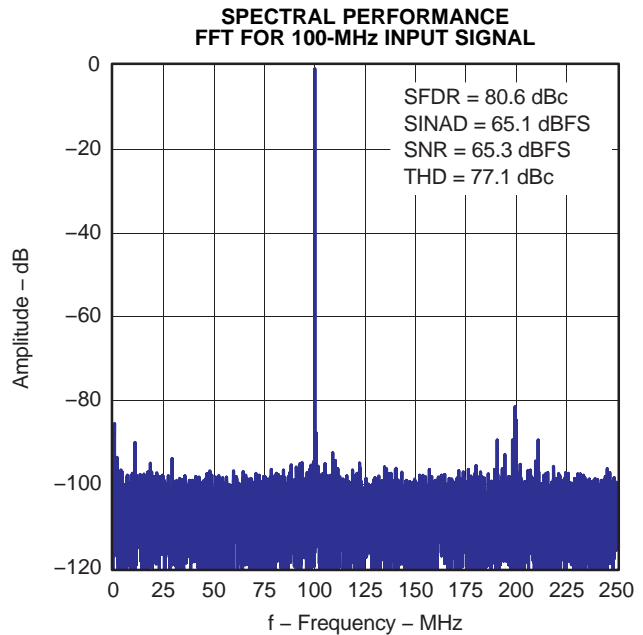

Figure 3.

G002

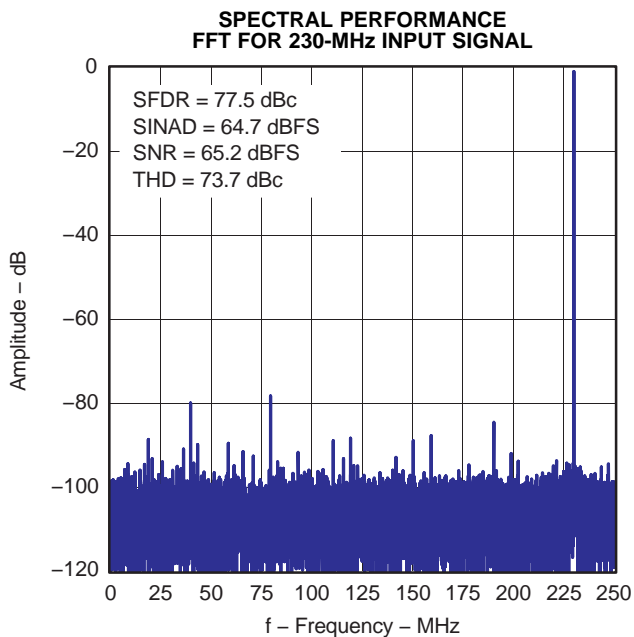

Figure 4.

G003

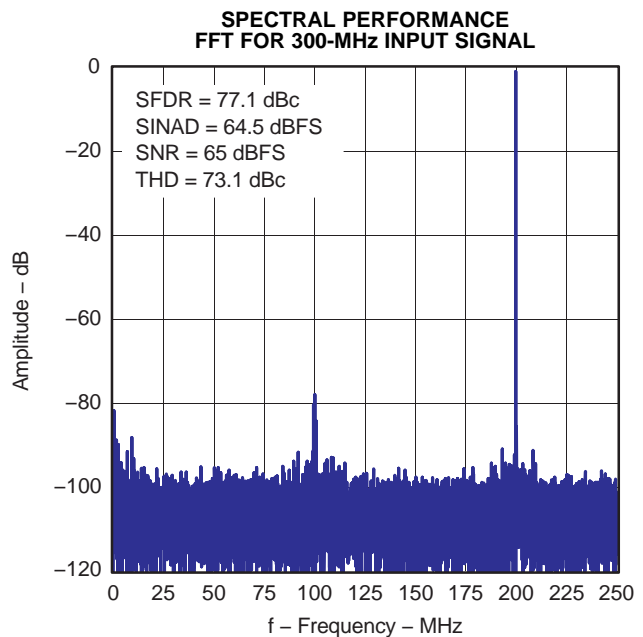

Figure 5.

G004

ADS5463 TYPICAL CHARACTERISTICS (continued)

Typical plots at $T_A = 25^\circ\text{C}$, sampling rate = 500 MSPS, 50% clock duty cycle, AVDD5 = 5 V, AVDD3 = 3.3 V, DVDD3 = 3.3 V, and 3- V_{PP} differential clock, (unless otherwise noted)

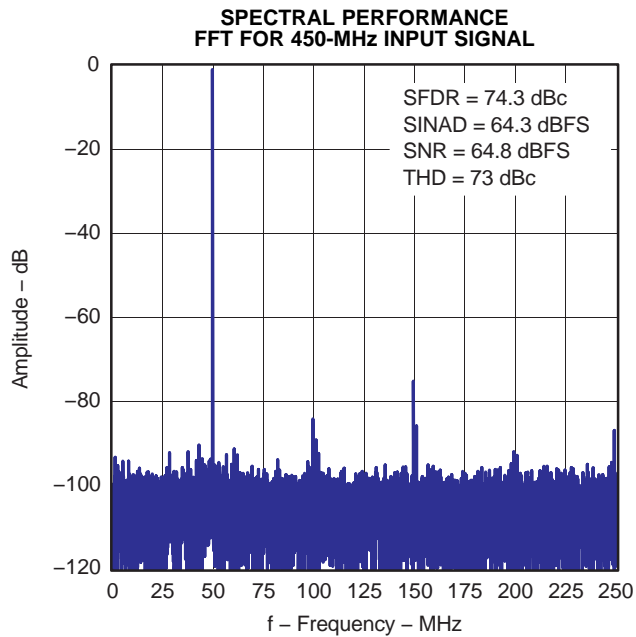

Figure 6.

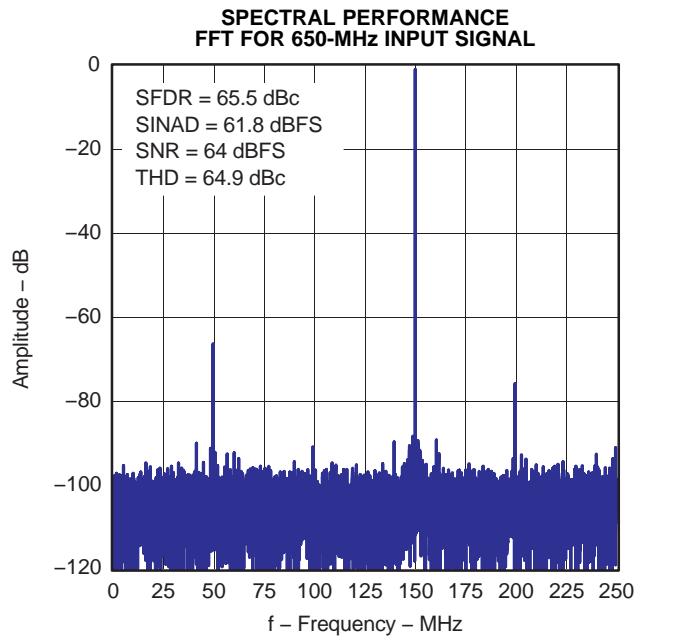

Figure 7.

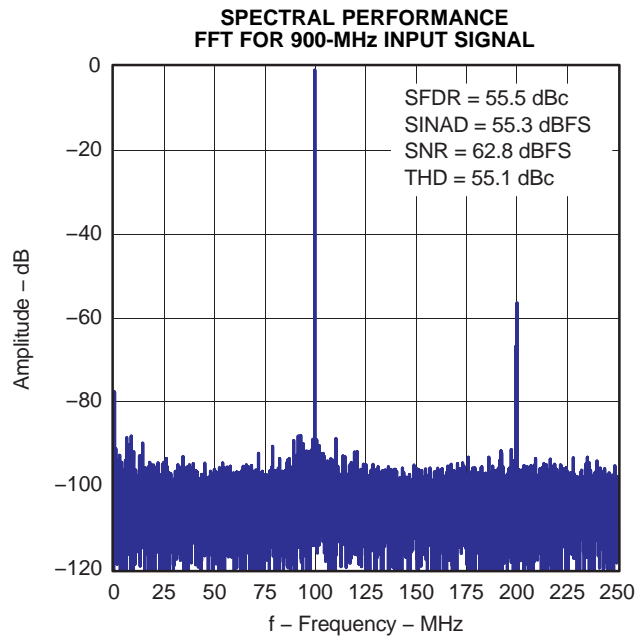

Figure 8.

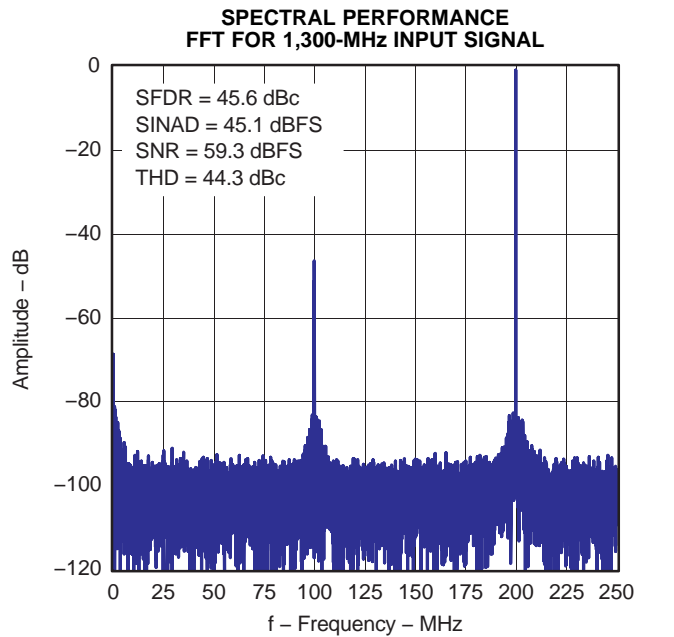

Figure 9.

ADS5463 TYPICAL CHARACTERISTICS (continued)

Typical plots at $T_A = 25^\circ\text{C}$, sampling rate = 500 MSPS, 50% clock duty cycle, AVDD5 = 5 V, AVDD3 = 3.3 V, DVDD3 = 3.3 V, and 3- V_{PP} differential clock, (unless otherwise noted)

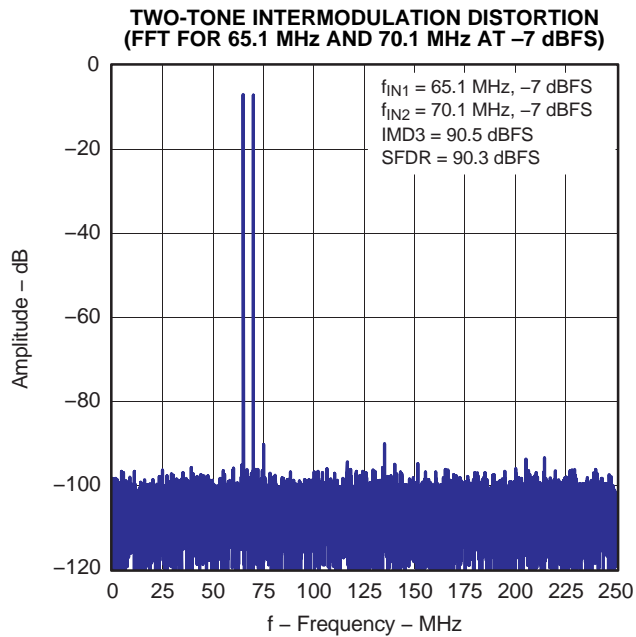

Figure 10.

G009

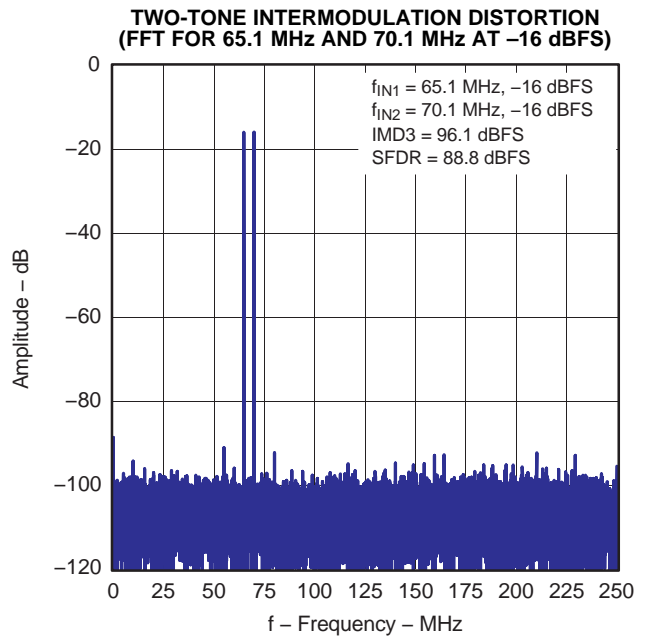

Figure 11.

G010

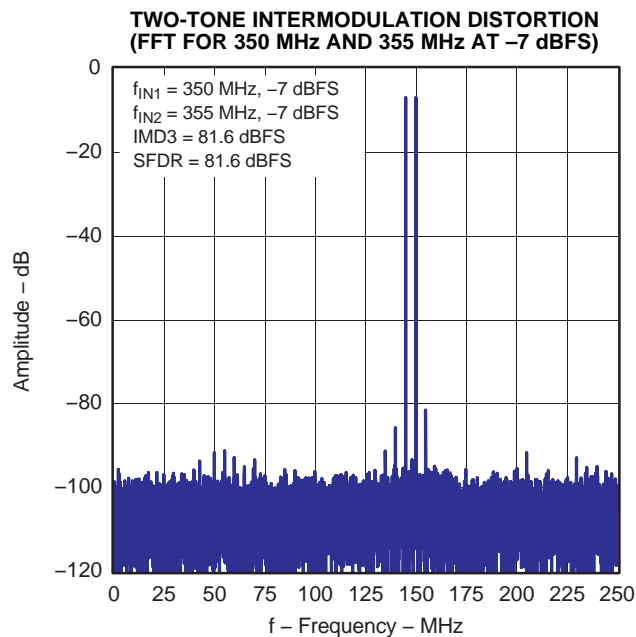

Figure 12.

G011

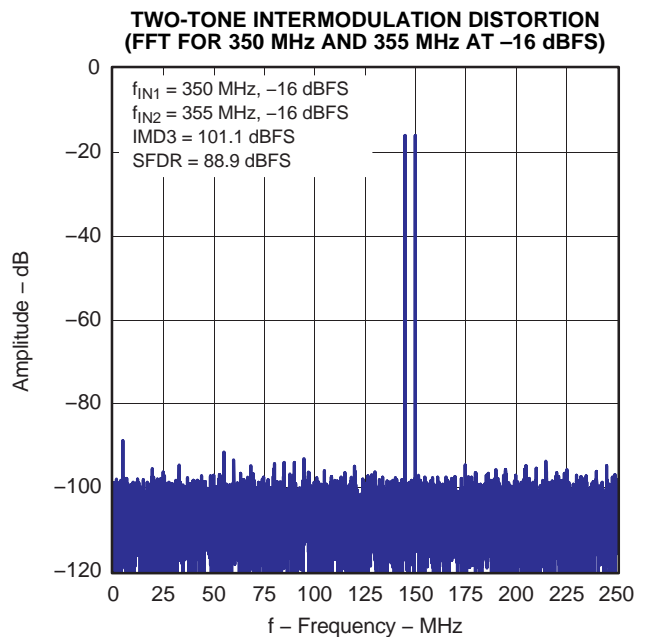

Figure 13.

G012

ADS5463 TYPICAL CHARACTERISTICS (continued)

Typical plots at $T_A = 25^\circ\text{C}$, sampling rate = 500 MSPS, 50% clock duty cycle, AVDD5 = 5 V, AVDD3 = 3.3 V, DVDD3 = 3.3 V, and 3- V_{PP} differential clock, (unless otherwise noted)

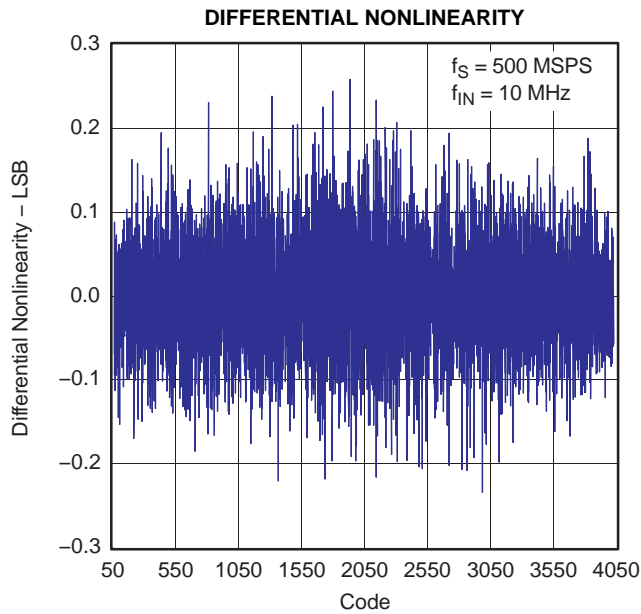

Figure 14.

G014

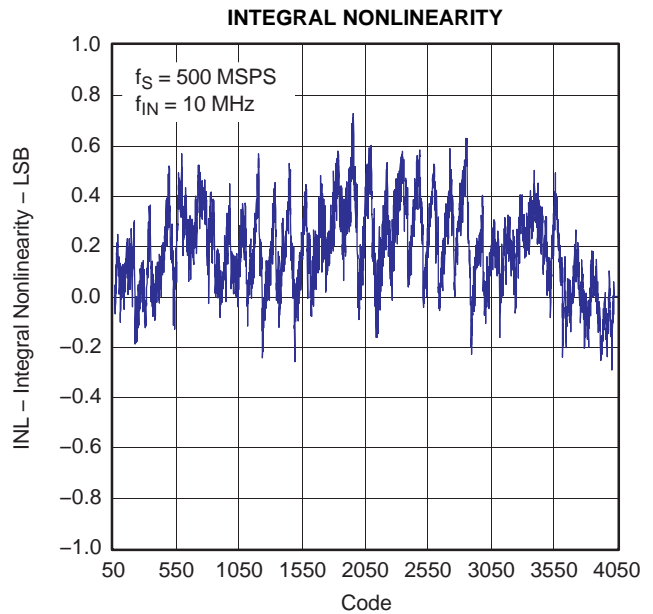

Figure 15.

G015

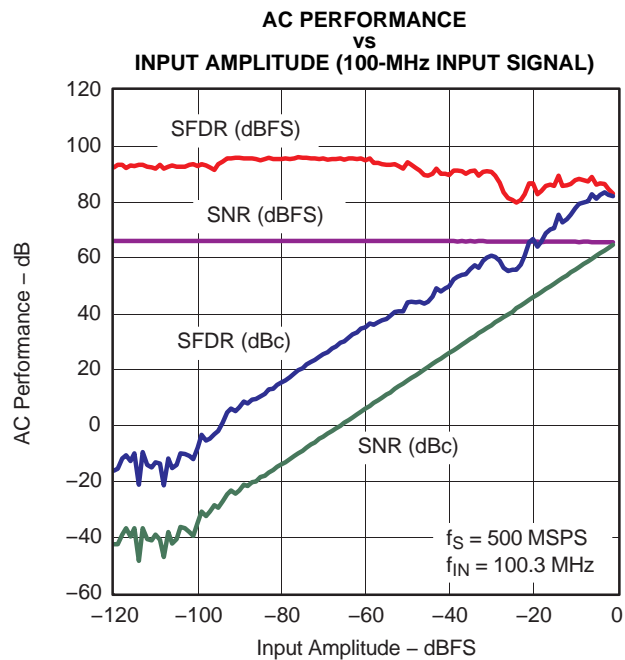

Figure 16.

G017

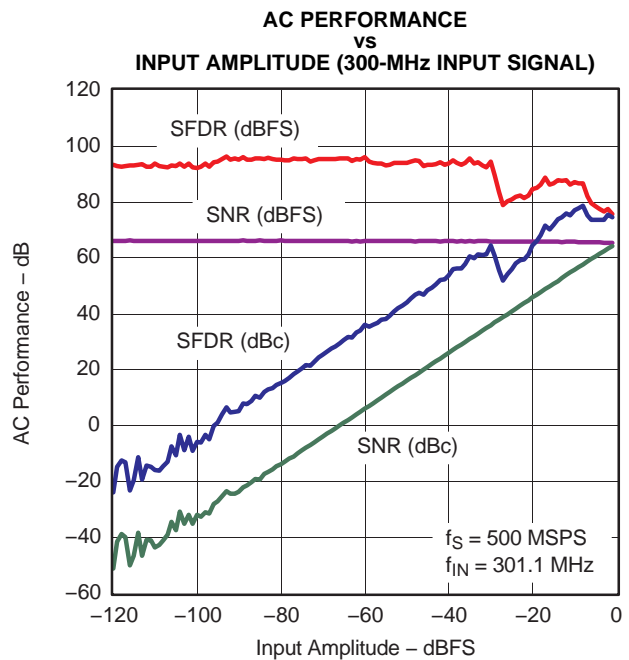

Figure 17.

G018

ADS5463 TYPICAL CHARACTERISTICS (continued)

Typical plots at $T_A = 25^\circ\text{C}$, sampling rate = 500 MSPS, 50% clock duty cycle, AVDD5 = 5 V, AVDD3 = 3.3 V, DVDD3 = 3.3 V, and 3-V_{PP} differential clock, (unless otherwise noted)

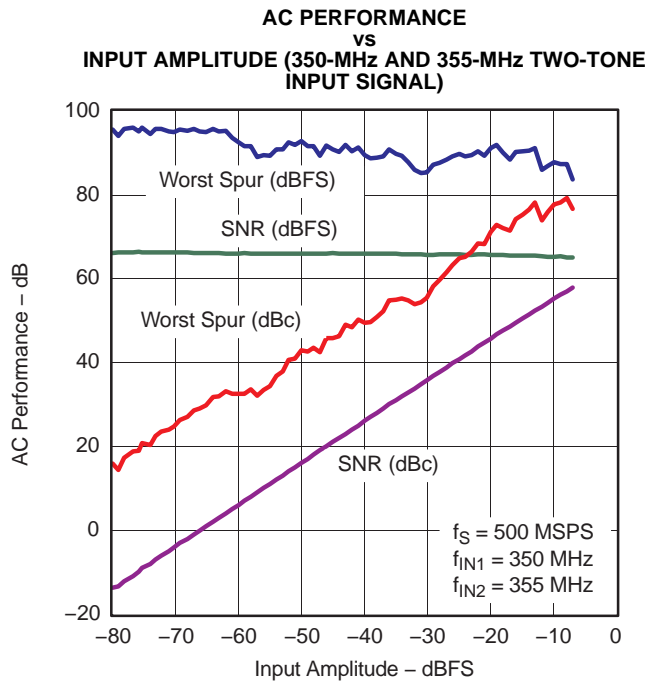

Figure 18.

G020

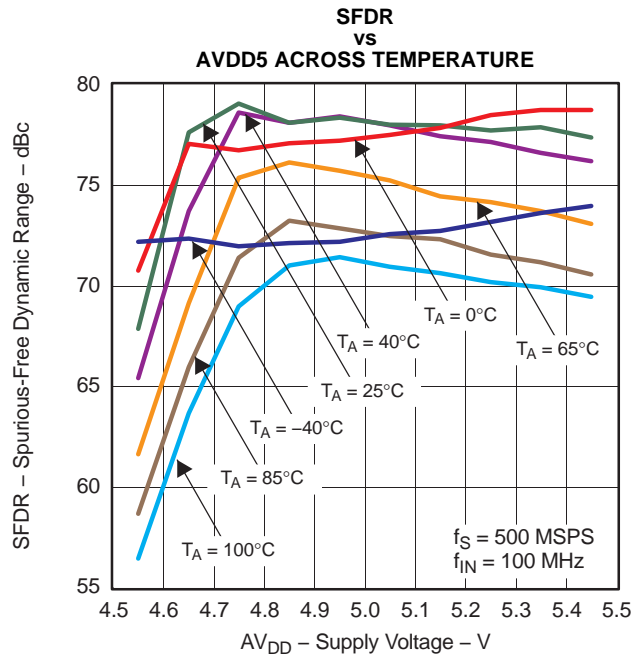

Figure 19.

G026

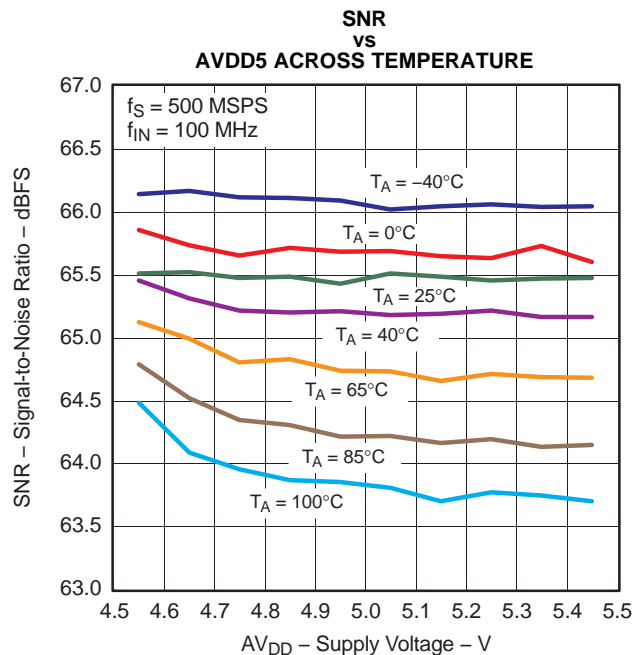

Figure 20.

G027

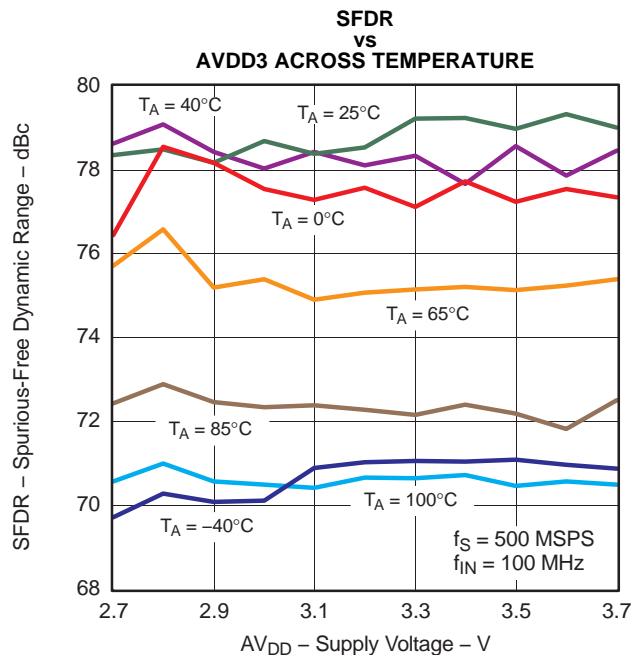

Figure 21.

G028

ADS5463 TYPICAL CHARACTERISTICS (continued)

Typical plots at $T_A = 25^\circ\text{C}$, sampling rate = 500 MSPS, 50% clock duty cycle, AVDD5 = 5 V, AVDD3 = 3.3 V, DVDD3 = 3.3 V, and 3- V_{PP} differential clock, (unless otherwise noted)

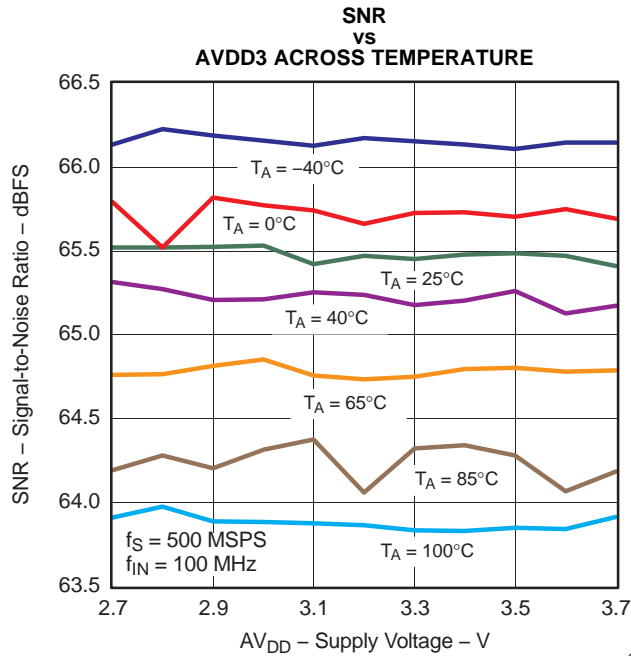

Figure 22.

G029

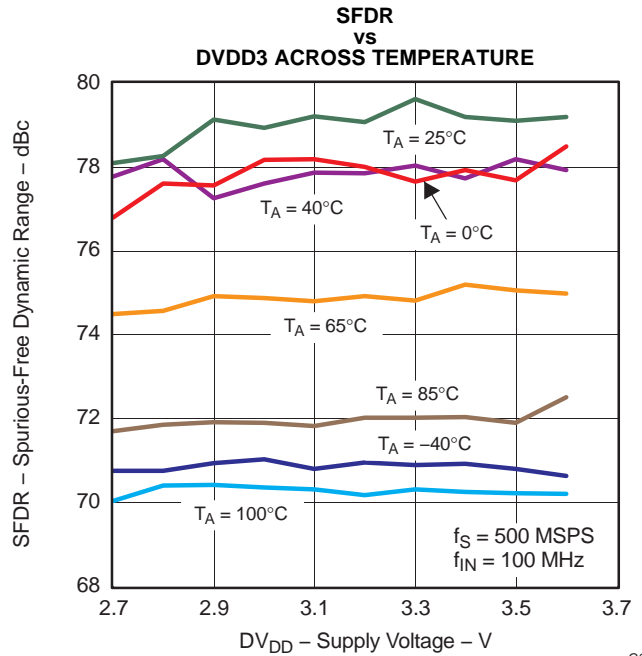

Figure 23.

G030

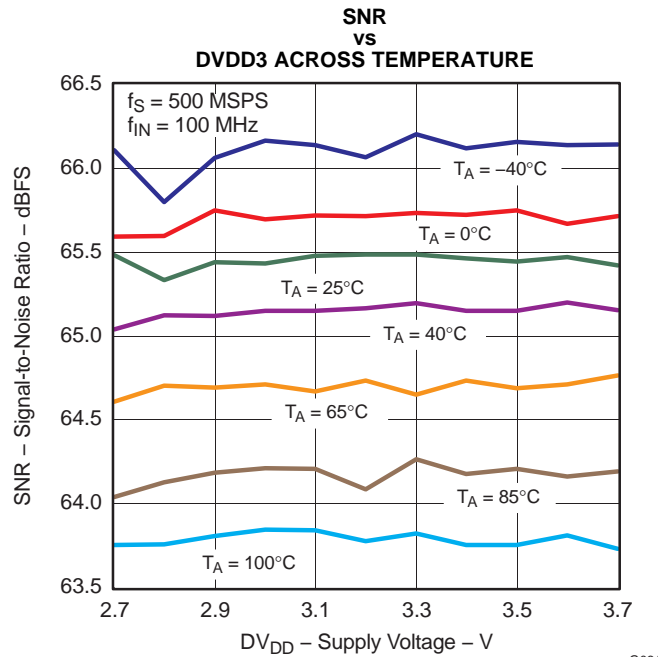

Figure 24.

G031

ADS5463 TYPICAL CHARACTERISTICS (continued)

Typical plots at $T_A = 25^\circ\text{C}$, sampling rate = 500 MSPS, 50% clock duty cycle, AVDD5 = 5 V, AVDD3 = 3.3 V, DVDD3 = 3.3 V, and 3-V_{PP} differential clock, (unless otherwise noted)

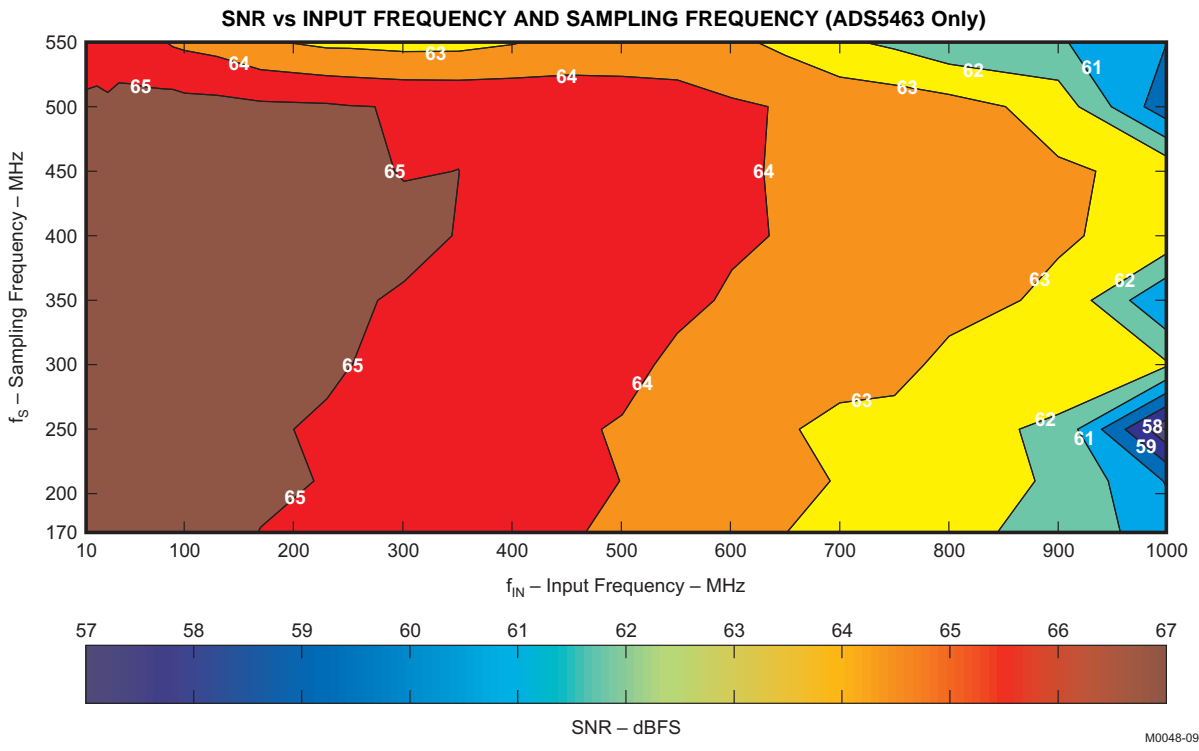

Figure 25.

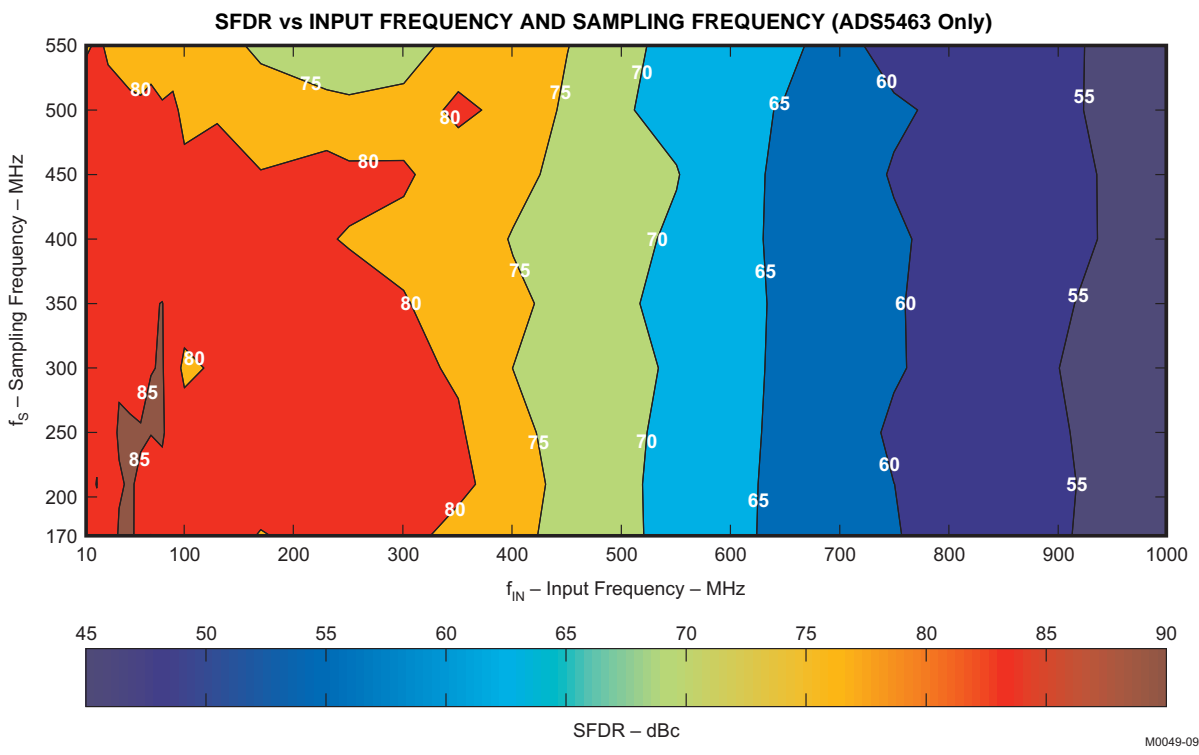

Figure 26.

ADS54RF63 TYPICAL CHARACTERISTICS

Typical plots at $T_A = 25^\circ\text{C}$, sampling rate = 550 MSPS, 50% clock duty cycle, AVDD5 = 5 V, AVDD3 = 3.3 V, DVDD3 = 3.3 V, and 3- V_{PP} differential clock, (unless otherwise noted)

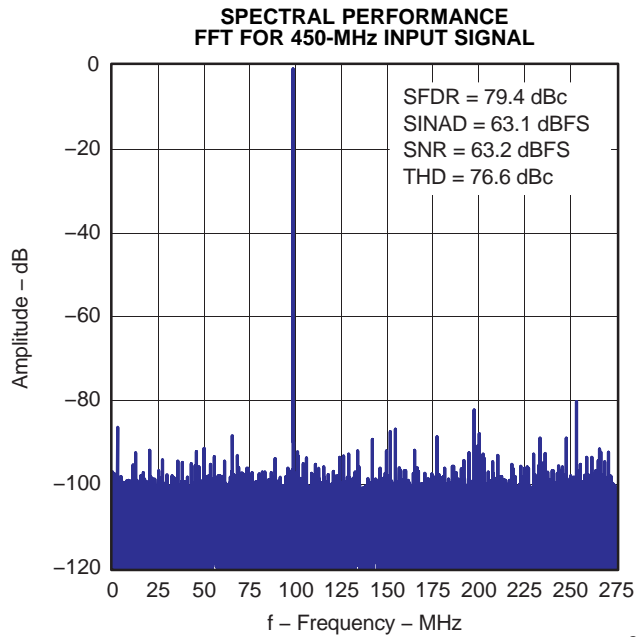

Figure 27.

G034

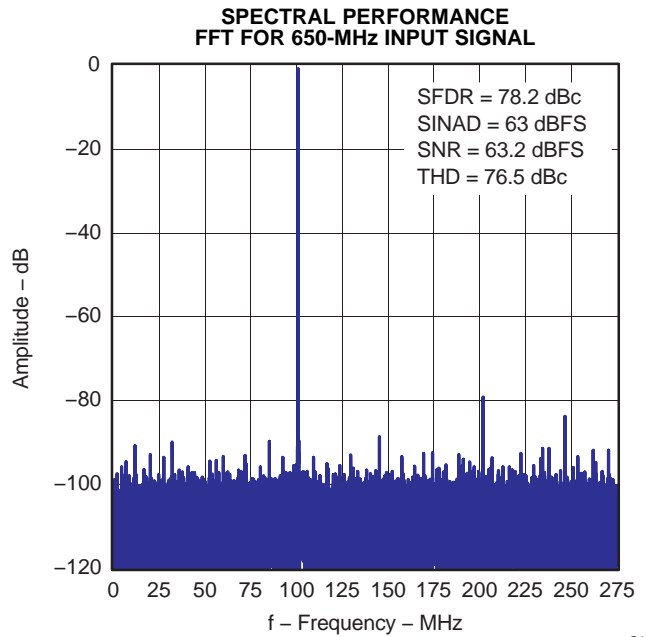

Figure 28.

G035

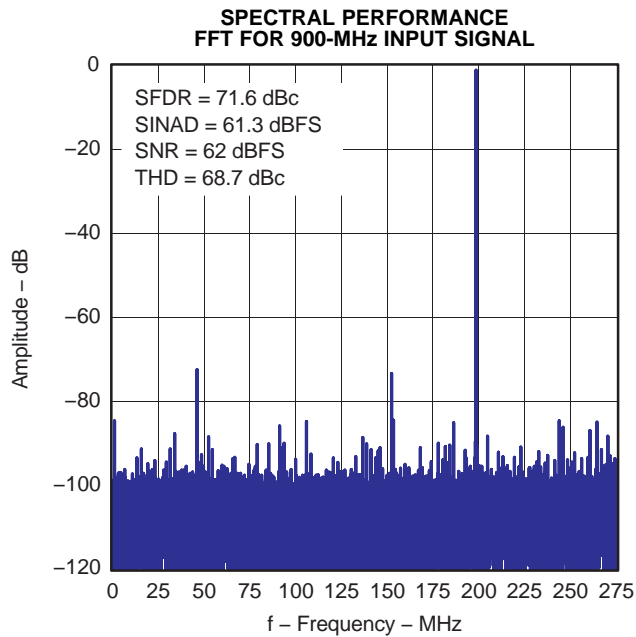

Figure 29.

G036

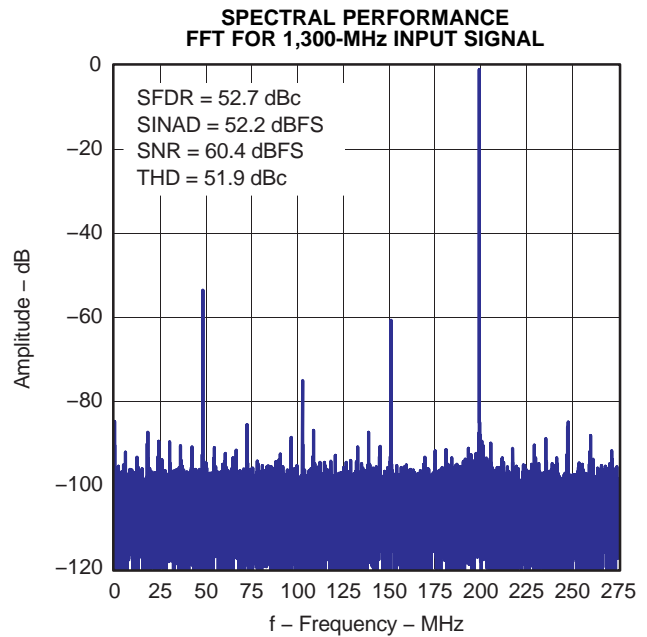

Figure 30.

G037

ADS54RF63 TYPICAL CHARACTERISTICS (continued)

Typical plots at $T_A = 25^\circ\text{C}$, sampling rate = 550 MSPS, 50% clock duty cycle, AVDD5 = 5 V, AVDD3 = 3.3 V, DVDD3 = 3.3 V, and 3- V_{PP} differential clock, (unless otherwise noted)

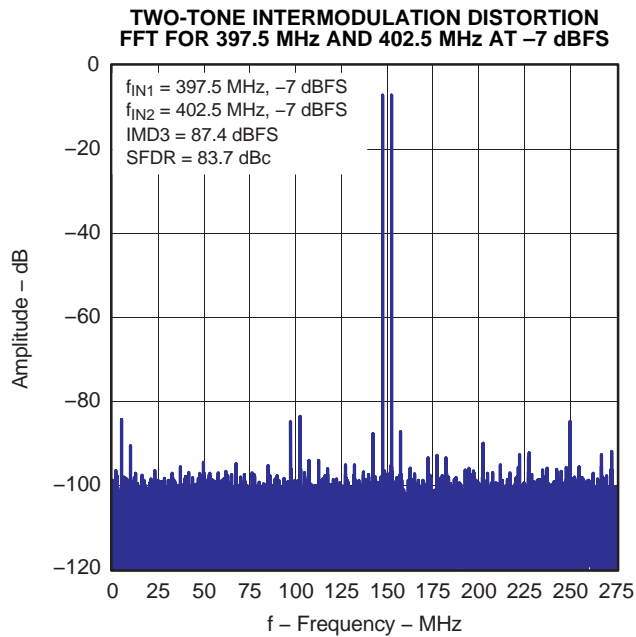

Figure 31.

G038

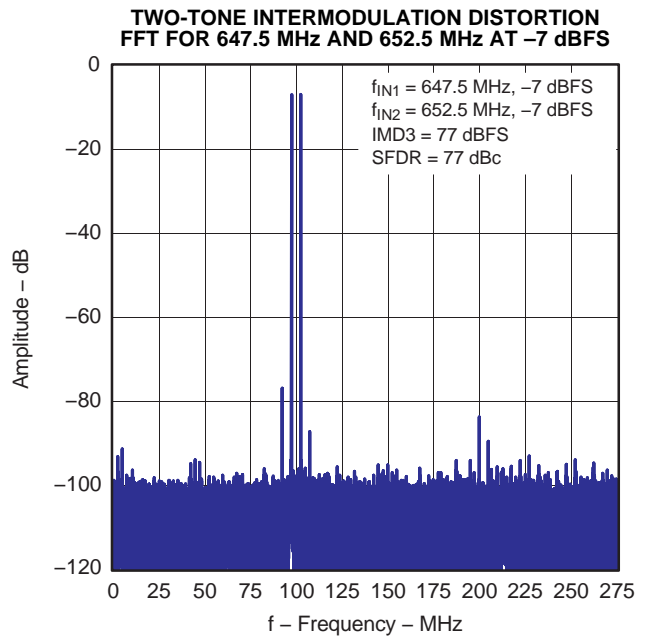

Figure 32.

G039

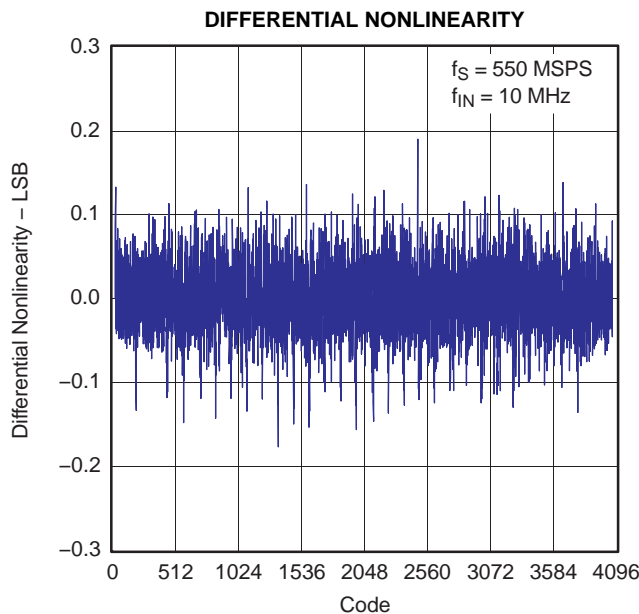

Figure 33.

G040

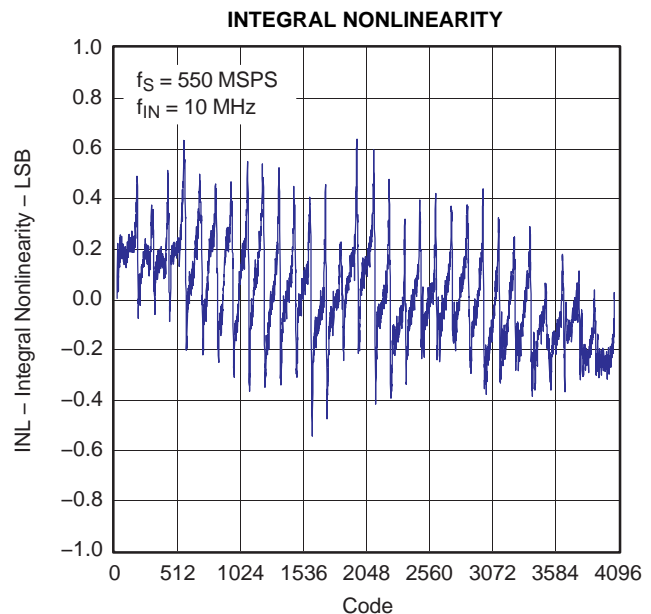

Figure 34.

G041

ADS54RF63 TYPICAL CHARACTERISTICS (continued)

Typical plots at $T_A = 25^\circ\text{C}$, sampling rate = 550 MSPS, 50% clock duty cycle, AVDD5 = 5 V, AVDD3 = 3.3 V, DVDD3 = 3.3 V, and 3-V_{PP} differential clock, (unless otherwise noted)

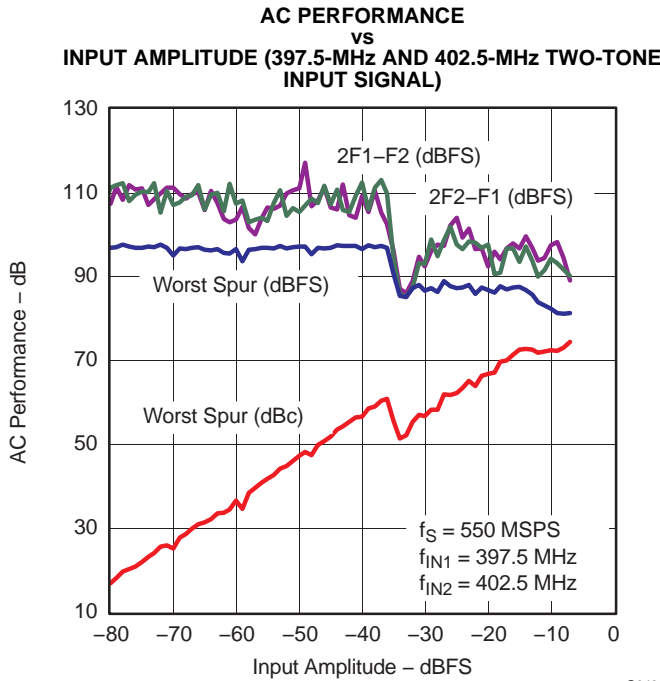

Figure 35.

G043

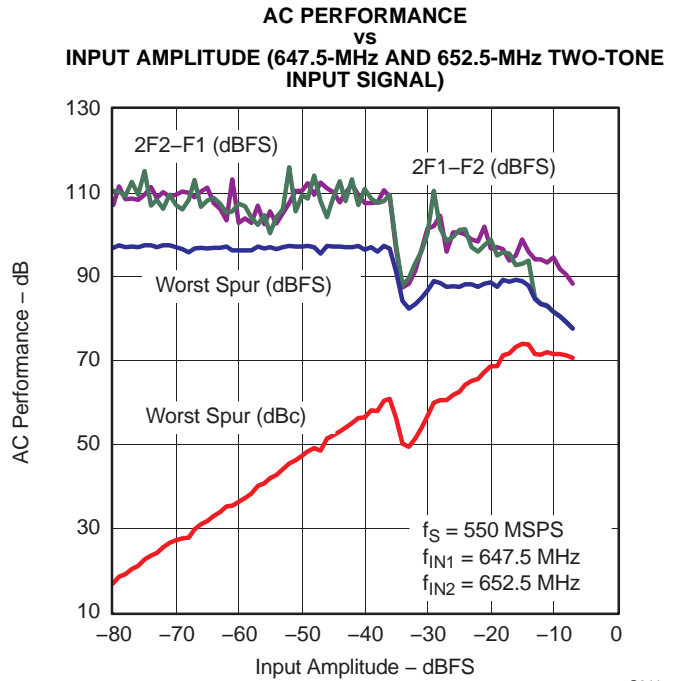

Figure 36.

G044

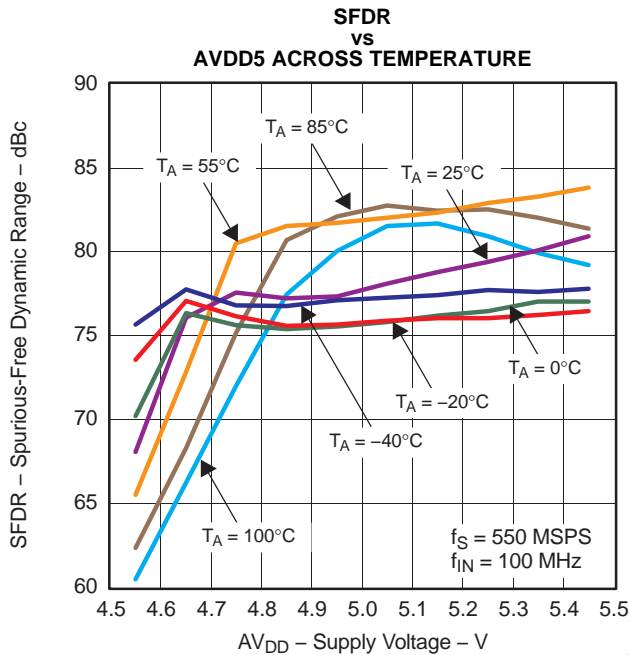

Figure 37.

G045

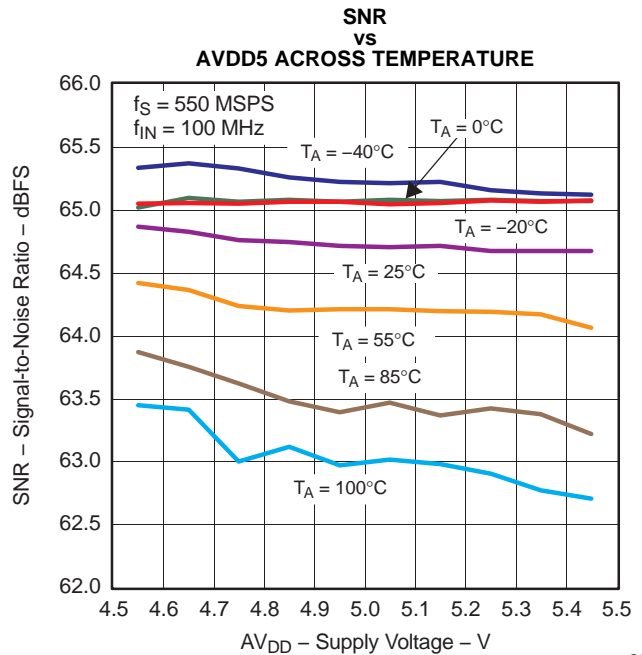

Figure 38.

G046

ADS54RF63 TYPICAL CHARACTERISTICS (continued)

Typical plots at $T_A = 25^\circ\text{C}$, sampling rate = 550 MSPS, 50% clock duty cycle, $AV_{DD5} = 5\text{ V}$, $AV_{DD3} = 3.3\text{ V}$, $DV_{DD3} = 3.3\text{ V}$, and 3- V_{PP} differential clock, (unless otherwise noted)

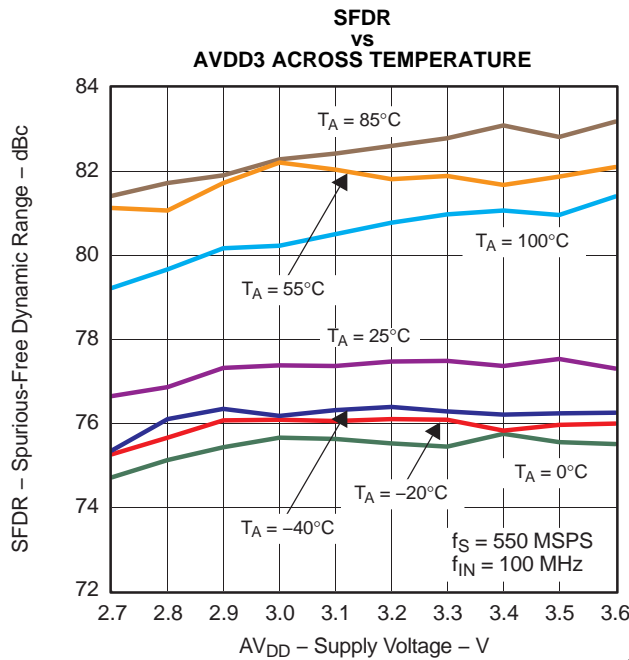

Figure 39.

G047

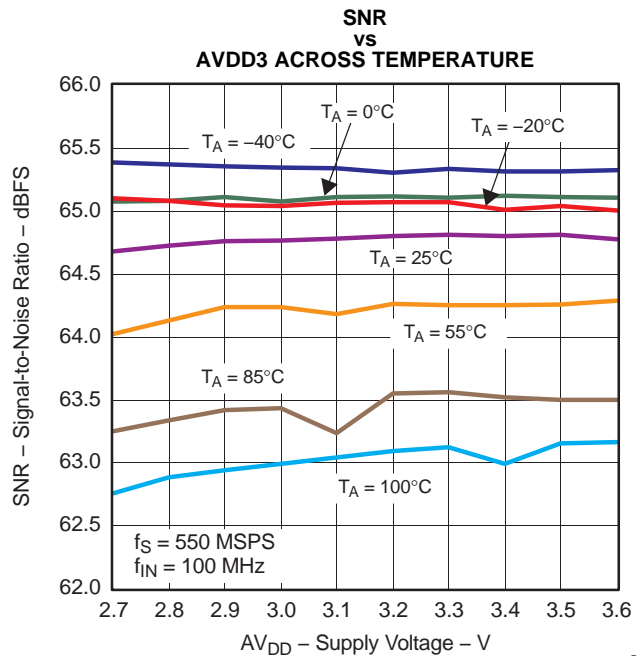

Figure 40.

G048

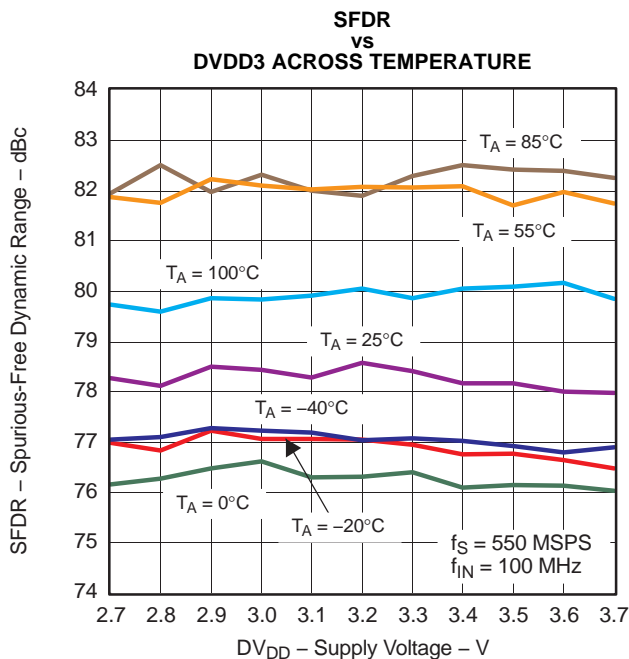

Figure 41.

G049

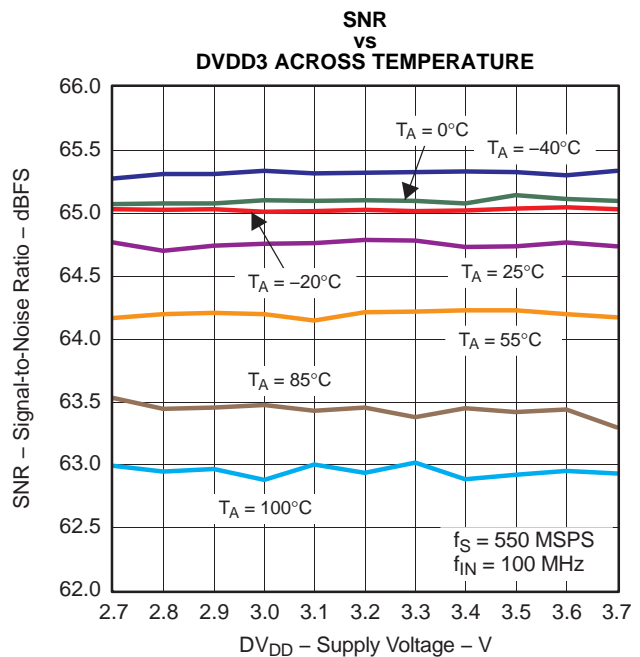

Figure 42.

G050

ADS54RF63 TYPICAL CHARACTERISTICS (continued)

Typical plots at $T_A = 25^\circ\text{C}$, sampling rate = 550 MSPS, 50% clock duty cycle, AVDD5 = 5 V, AVDD3 = 3.3 V, DVDD3 = 3.3 V, and 3-V_{PP} differential clock, (unless otherwise noted)

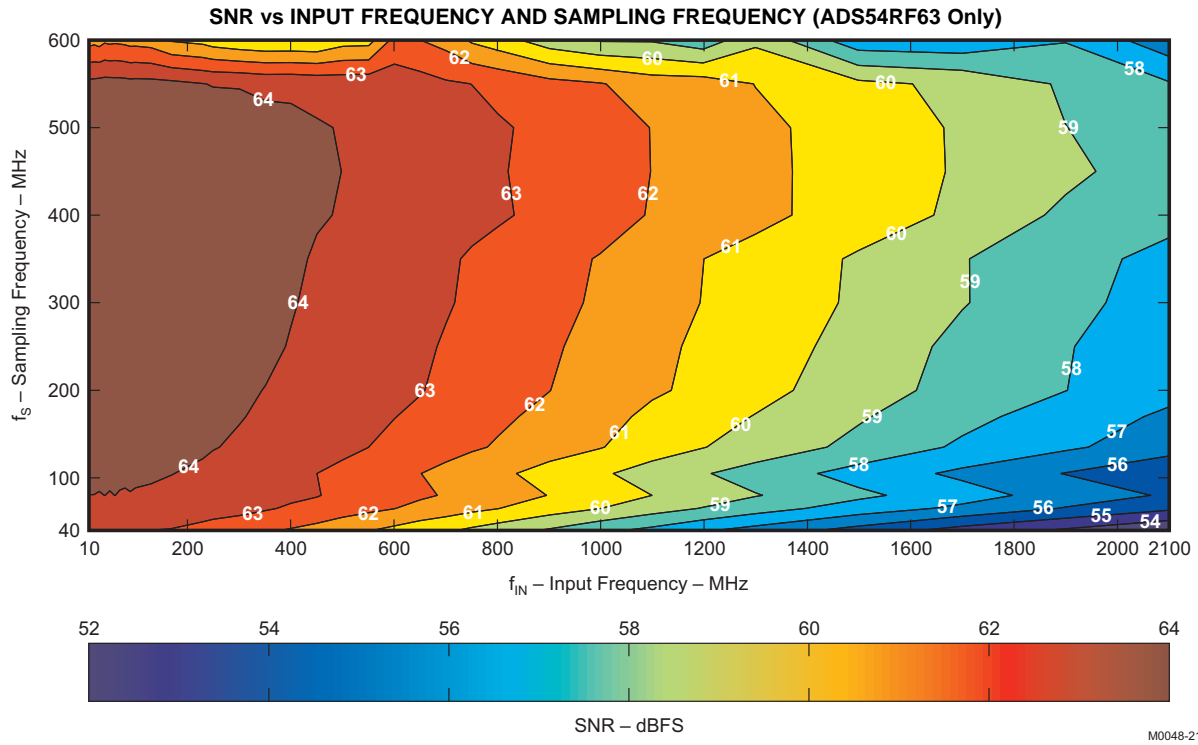

Figure 43.

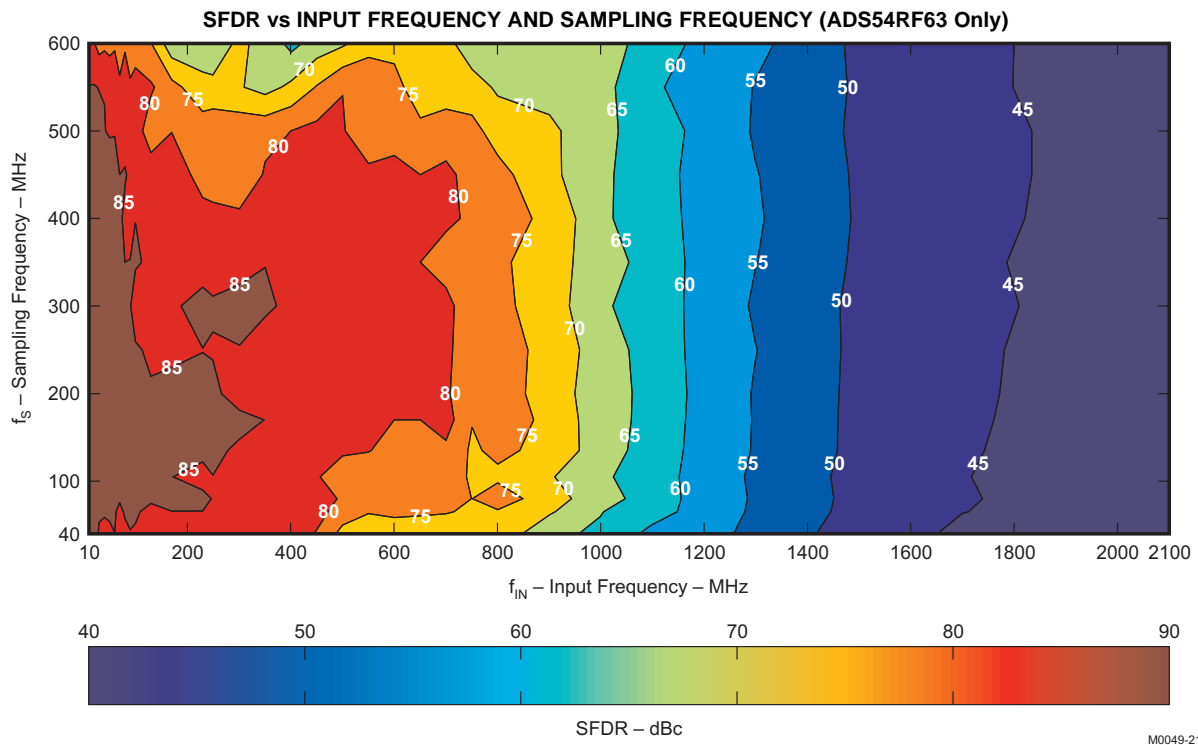

Figure 44.

ADS5463 AND ADS54RF63 TYPICAL CHARACTERISTICS

Typical plots at $T_A = 25^\circ\text{C}$, 50% clock duty cycle, $AV_{DD5} = 5\text{ V}$, $AV_{DD3} = 3.3\text{ V}$, $DV_{DD3} = 3.3\text{ V}$, and $3\text{-}V_{PP}$ differential clock, (unless otherwise noted)

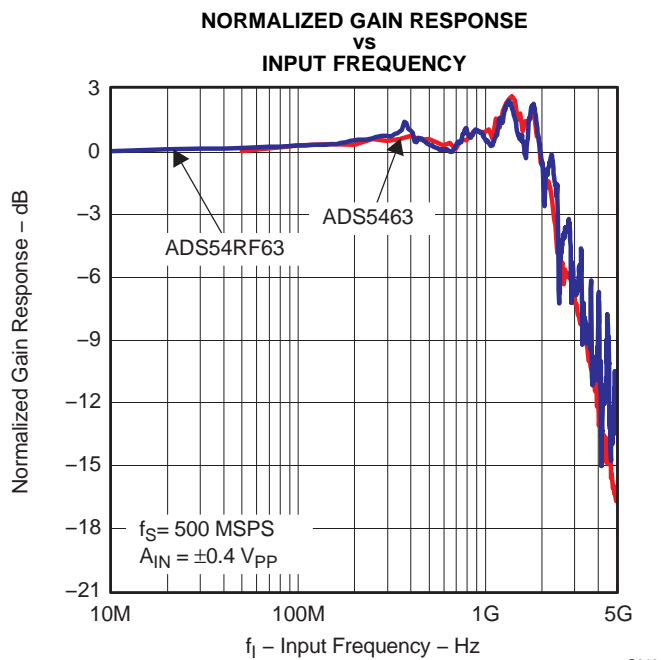

Figure 45.

G013

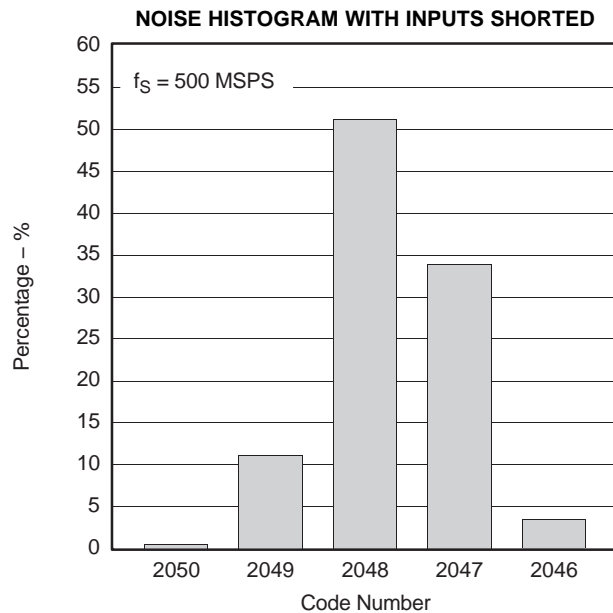

Figure 46.

G016

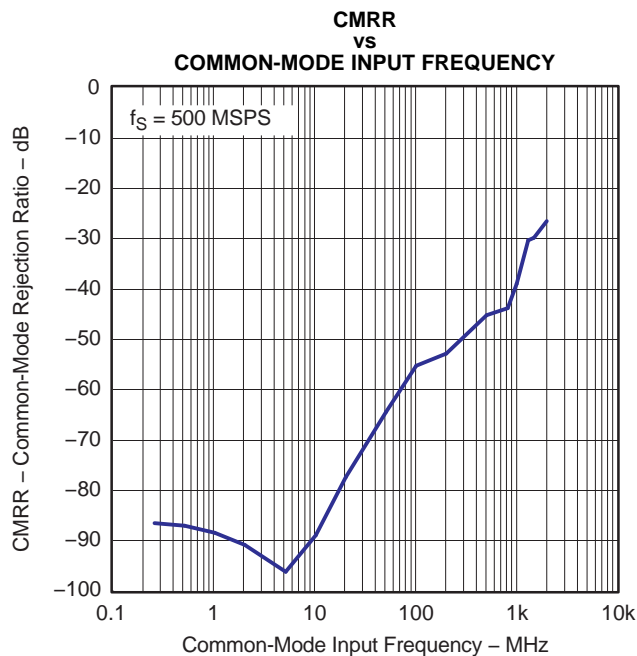

Figure 47.

G033

APPLICATION INFORMATION

Theory of Operation

The ADS5463/ADS54RF63 is a 12-bit, 500/550-MSPS, monolithic pipeline ADC. Its bipolar analog core operates from 5-V and 3.3-V supplies, while the output uses a 3.3-V supply to provide LVDS-compatible outputs. The conversion process is initiated by the rising edge of the external input clock. At that instant, the differential input signal is captured by the input track-and-hold (T&H), and the input sample is sequentially converted by a series of lower resolution stages, with the outputs combined in a digital correction logic block. Both the rising and the falling clock edges are used to propagate the sample through the pipeline every half clock cycle. This process results in a data latency of 3.5 clock cycles, after which the output data is available as a 12-bit parallel word, coded in offset binary format.

The ADS5463 and ADS54RF63 are identical in the way they are used on a board. They differ in their maximum sample rate and spectral performance versus frequency. A good study of the contour plots in [Figure 25](#), [Figure 26](#), [Figure 43](#), and [Figure 44](#) demonstrate the spectral differences. The digital output characteristics are the same except the ADS54RF63 has less restrictive timing parameters.

Input Configuration

The analog input for the ADS5463/ADS54RF63 consists of an analog pseudo-differential buffer followed by a bipolar transistor track-and-hold (see [Figure 48](#)). The analog buffer isolates the source driving the input of the ADC from any internal switching and presents a high impedance to drive at high input frequencies, as compared to an ADC without a buffered input. The input common mode is set internally through a 500-Ω resistor connected from 2.4 V to each of the inputs. This results in a differential input impedance of 1 kΩ. The 0.5 pF of parasitic package capacitance is before soldering.

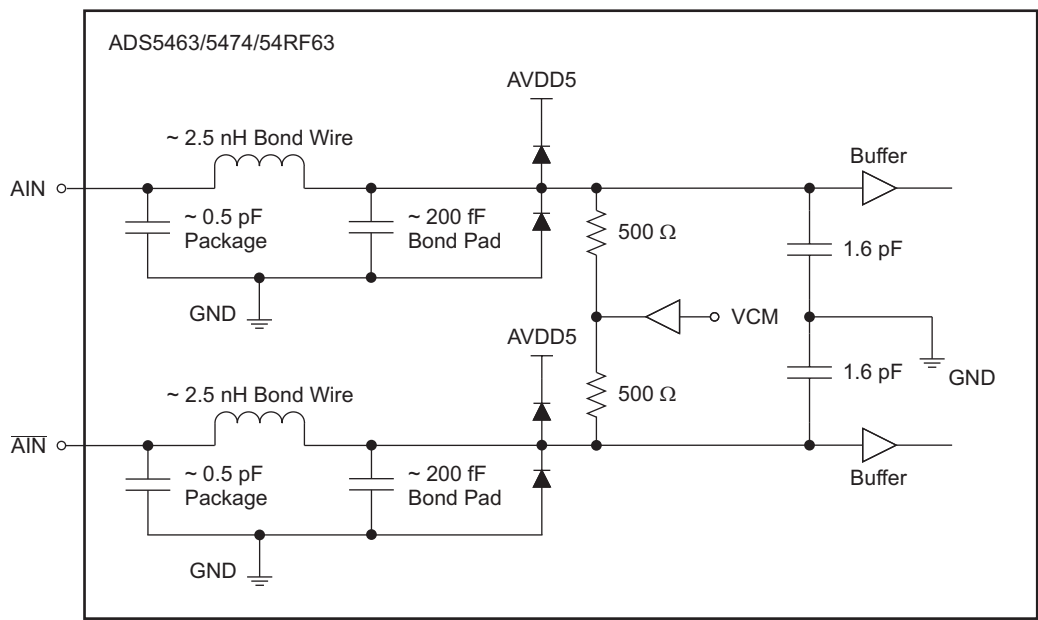

Figure 48. Analog Input Equivalent Circuit (unsoldered)

For a full-scale differential input, each of the differential lines of the input signal (pins 16 and 17) swing symmetrically between $2.4\text{ V} + 0.55\text{ V}$ and $2.4\text{ V} - 0.55\text{ V}$. This means that each input has a maximum signal swing of 1.1 V_{PP} for a total differential input signal swing of 2.2 V_{PP} . Operation below 2.2 V_{PP} is allowable, with the characteristics of performance versus input amplitude demonstrated in [Figure 16](#) and [Figure 17](#). For instance, for performance at 1.1 V_{PP} rather than 2.2 V_{PP} , see the SNR and SFDR at -6 dBFS ($0\text{ dBFS} = 2.2\text{ V}_{PP}$). The maximum swing is determined by the internal reference voltage generator, eliminating the need for any external circuitry for this purpose.

The ADS5463/ADS54RF63 obtains optimum performance when the analog inputs are driven differentially. The circuit in Figure 49 shows one possible configuration using an RF transformer with termination either on the primary or on the secondary of the transformer. In addition, the evaluation module is configured with two back-to-back transformers, which also demonstrates good performance. If voltage gain is required, a step-up transformer can be used.

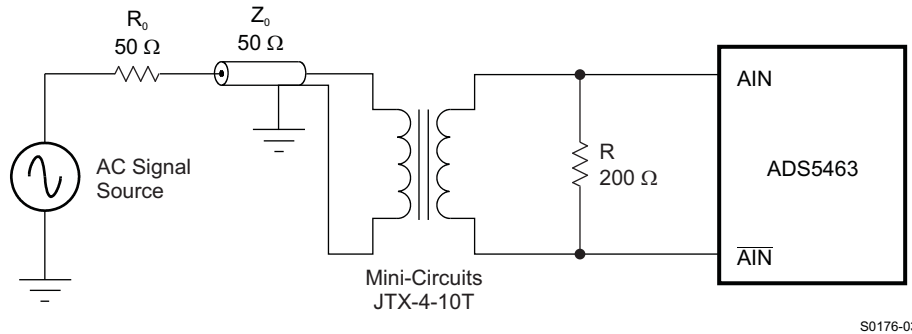

Figure 49. Converting a Single-Ended Input to a Differential Signal Using an RF Transformer

In addition to the transformer configurations, an RF gain-block amplifier, such as the Texas Instruments THS9001, can also be used for high-input-frequency applications. For large voltage gains at intermediate frequencies in the 50-MHz – 350-MHz range, the configuration shown in Figure 50 can be used. The component values can be tuned for different intermediate frequencies. The example shown is located on the evaluation module and is tuned for an IF of 170 MHz. More information regarding this configuration can be found in the ADS5463 EVM User Guide (SLAU194) and the THS9001 50 MHz to 350 MHz Cascadeable Amplifier data sheet (SLOS426).

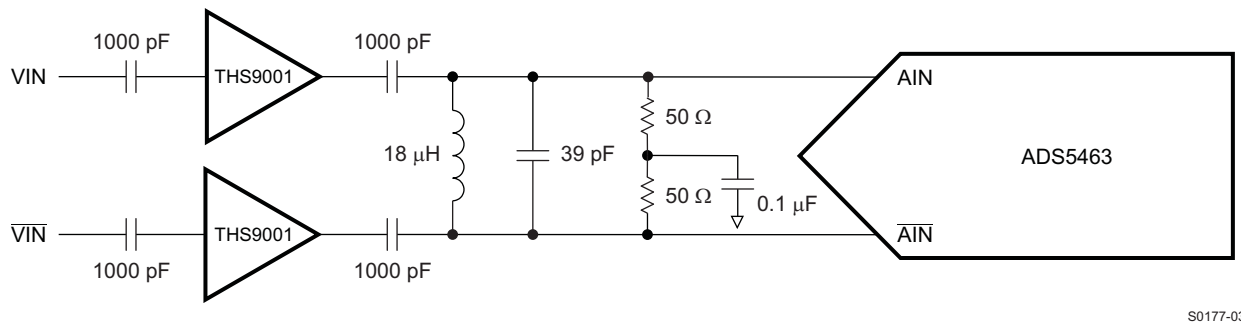

Figure 50. Using the THS9001 IF Amplifier with the ADS5463/ADS54RF63

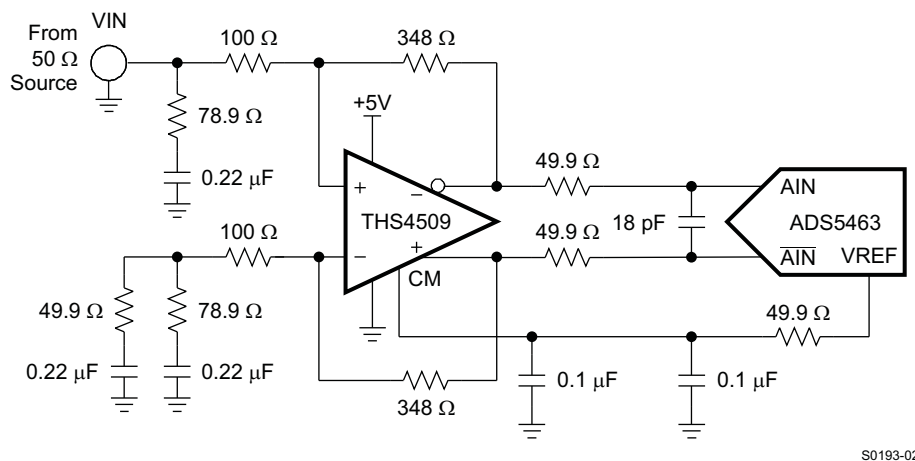

Figure 51. Using the THS4509 with the ADS5463/ADS54RF63

For applications requiring dc-coupling with the signal source, a differential input/differential output amplifier like the THS4509 (see [Figure 51](#)) provides good harmonic performance and low noise over a wide range of frequencies. Notice that VREF is used for the common mode with the ADS5463/ADS54RF63 and ADS5444/5440, whereas VCM must be used with the ADS5474.

In this configuration, the THS4509 amplifier circuit provides 10 dB of gain, converts the single-ended input to differential, and sets the proper input common-mode voltage to the ADS5463/ADS54RF63 by using the VREF pin from the ADC. The 50-Ω resistors and 18-pF capacitor between the THS4509 outputs and ADS5463/ADS54RF63 inputs (along with the input capacitance of the ADC) limit the bandwidth of the signal to about 70 MHz (–3 dB). Input termination is accomplished via the 78.9-Ω resistor and 0.22-μF capacitor to ground, in conjunction with the input impedance of the amplifier circuit. A 0.22-μF capacitor and 49.9-Ω resistor are inserted to ground across the 78.9-Ω resistor and 0.22-μF capacitor on the alternate input to balance the circuit. Gain is a function of the source impedance, termination, and 348-Ω feedback resistor. See the THS4509 data sheet for further component values to set proper 50-Ω termination for other common gains. Because the ADS5463/ADS54RF63 recommended input common-mode voltage is 2.4 V, the THS4509 is operated from a single power supply input with $V_{S+} = 5\text{ V}$ and $V_{S-} = 0\text{ V}$ (ground). This maintains maximum headroom on the internal transistors of the THS4509.

Over-Range Analog Input Recovery Error

An over-range condition occurs if the analog input voltage exceeds the full-scale range of the converter (0dBFS, nominally 2.2 V_{pp}). To test recovery from an over-range, the ADC analog input is injected with a sinusoidal input frequency exactly at $CLKIN/4$ (a four-point sinusoid). The four sample points of each period theoretically occur at the top, mid-scale, bottom and mid-scale of the sinusoid. Once the amplitude exceeds 0dBFS, the top and bottom of the sinusoidal input becomes out of range, while the mid-scale points are always in-range and therefore measurable. The graph in [Figure 52](#) indicates the amount of error from the expected mid-scale value of 2048 that occurs after negative over-range (bottom of sinusoid went out of range) and positive over-range (top of sinusoid went out of range). Due to the four point sinusoid, this equates to the amount of error in a valid sample 1 clock cycle after an over-range occurs as a function of amplitude. The errors generally increase as a function of input over-range amplitude, though non-monotonically.

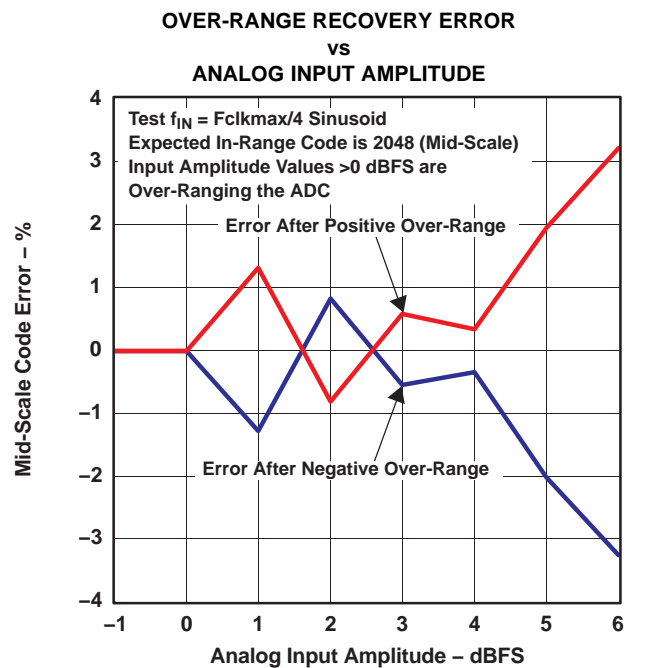

Figure 52.

G055

External Voltage Reference

For systems that require the analog signal gain to be adjusted or calibrated, this can be performed by using an external reference. The dependency on the signal amplitude to the value of the external reference voltage is characterized typically by [Figure 53](#) ($V_{REF} = 2.4\text{ V}$ is normalized to 0 dB as this is the internal reference voltage). (This figure is the average gain adjustment from the data collected from -1dBFS to -6dBFS in 1 dB steps.) As can be seen in the linear fit, this equates to approximately -0.3 dB of signal adjustment per 100 mV of reference adjustment. The range of allowable variation depends on the analog input amplitude that is applied to the inputs and the desired spectral performance, as can be seen in the performance versus external reference graphs in [Figure 54](#) and [Figure 55](#). As the applied analog signal amplitude is reduced, more variation in the reference voltage is allowed in the positive direction (which equates to a reduction in signal amplitude), whereas an adjustment in reference voltage below the nominal 2.4 V (which equates to an increase in signal amplitude) is not recommended below approximately 2.35 V. The power consumption versus reference voltage and operating temperature should also be considered, especially at high ambient temperatures, because the lifetime of the device is affected by internal junction temperature, see [Figure 68](#).

The ADS5463/ADS54RF63 does not have a VCM output pin and uses the VREF pin to provide the common-mode voltage in dc-coupled applications. The ADS5463/ADS54RF63 ($V_{CM} = 2.4\text{ V}$) and [ADS5474](#) ($V_{CM} = 3.1\text{ V}$) do not have the same common-mode voltage, but they do share the same approximate VREF (2.4 V). To create a board layout that may accommodate both devices in dc-coupled applications, route the VCM of the ADS5474 and the VREF of the ADS5463/ADS54RF63 both to a common point that can be selected via a switch, jumper, or a 0- Ω resistor to be used as the common-mode voltage of the driving circuit.

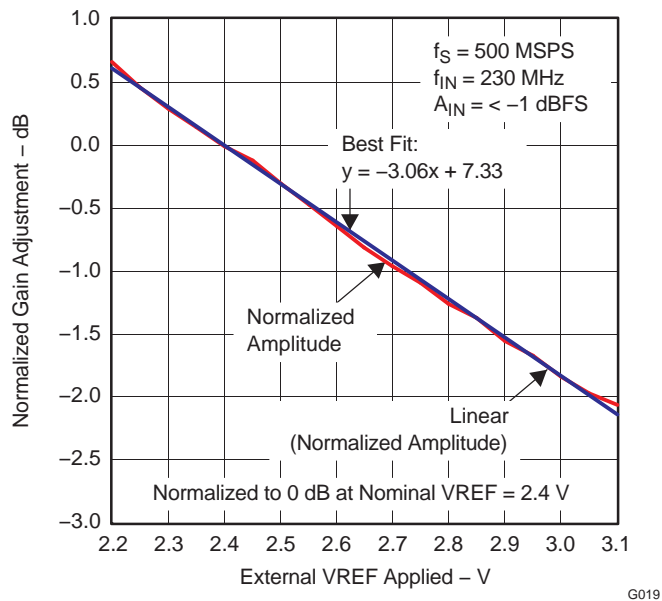

Figure 53. ADS5463 Signal Gain Adjustment versus External Reference (VREF)

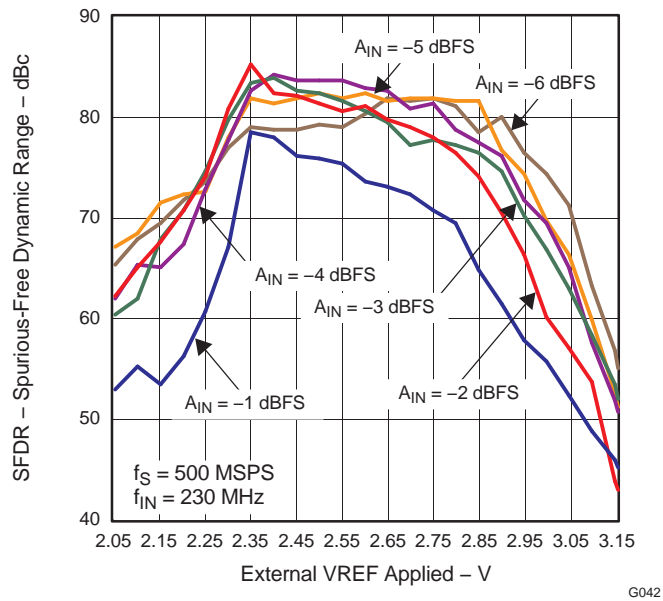

Figure 54. ADS5463 SFDR versus External VREF and AIN

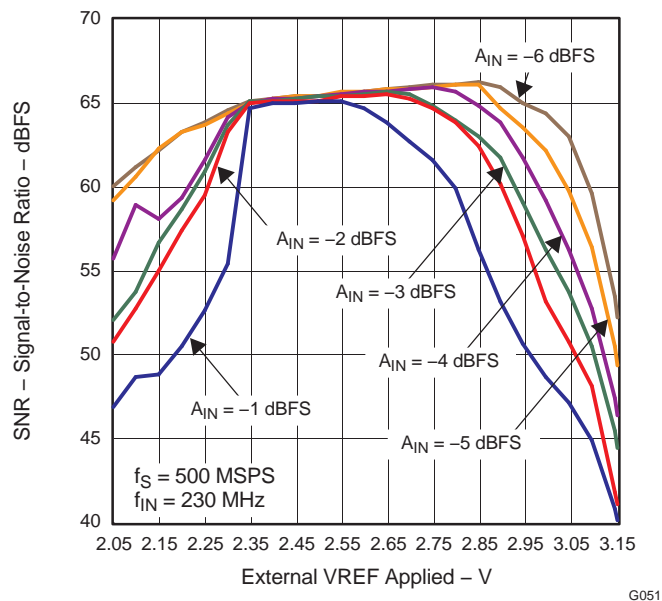

Figure 55. ADS5463 SNR versus External VREF and AIN

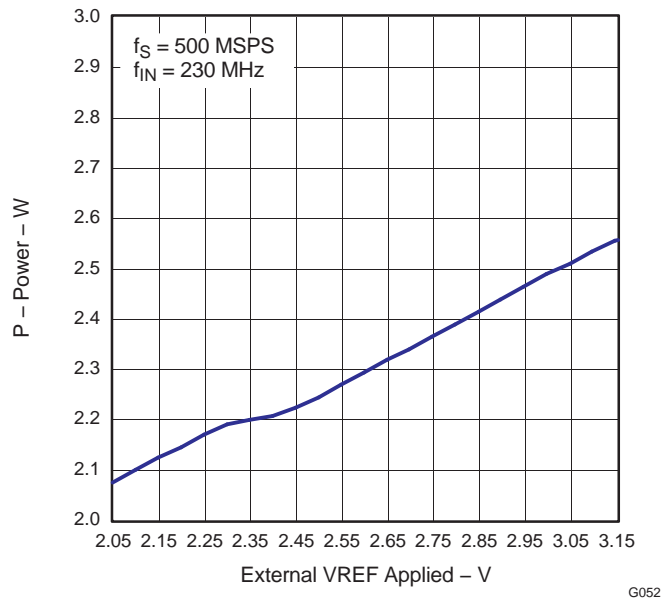
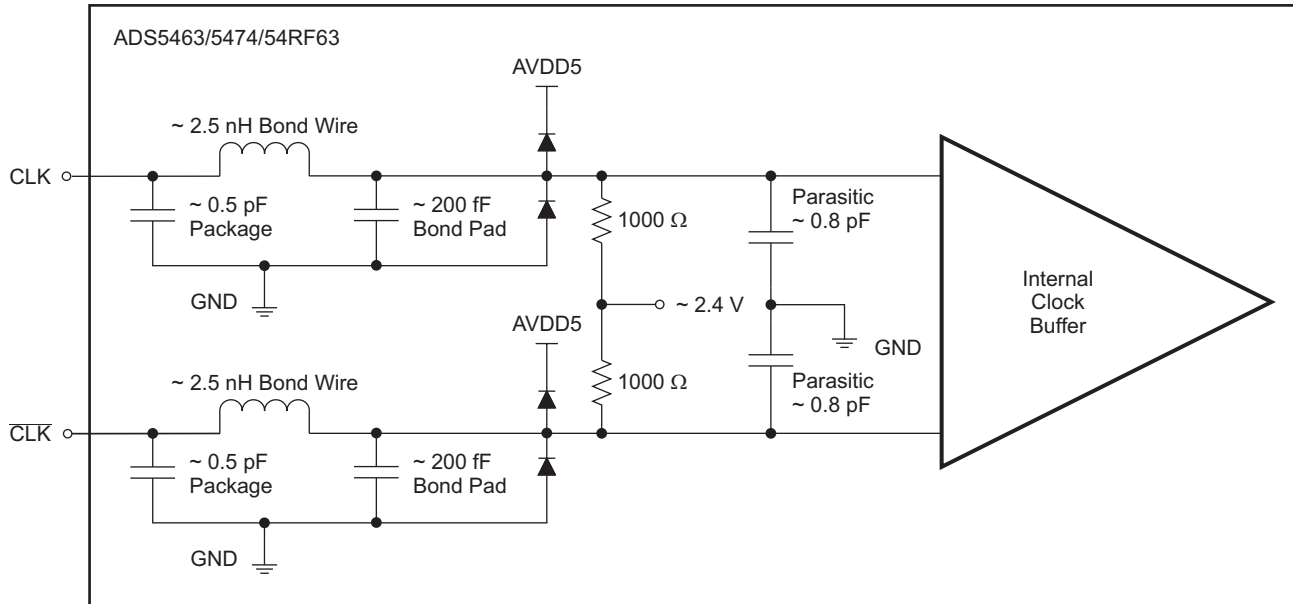

Figure 56. Total Power Consumption versus External VREF

Clock Inputs

The ADS5463/ADS54RF63 clock input can be driven with either a differential clock signal or a single-ended clock input. The equivalent clock input circuit can be seen in Figure 57. The 0.5 pF of parasitic package capacitance is before soldering. When jitter may not be a big concern, the use of a single-ended clock (as shown in Figure 58) could save cost and board space without much performance tradeoff. When clocked with this configuration, it is best to connect CLK to ground with a 0.01- μ F capacitor, while CLK is ac-coupled with a 0.01- μ F capacitor to the clock source, as shown in Figure 58.



S0292-01

Figure 57. Clock Input Circuit (unsoldered package)

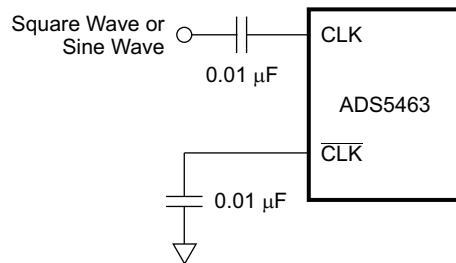

S0168-05

Figure 58. Single-Ended Clock

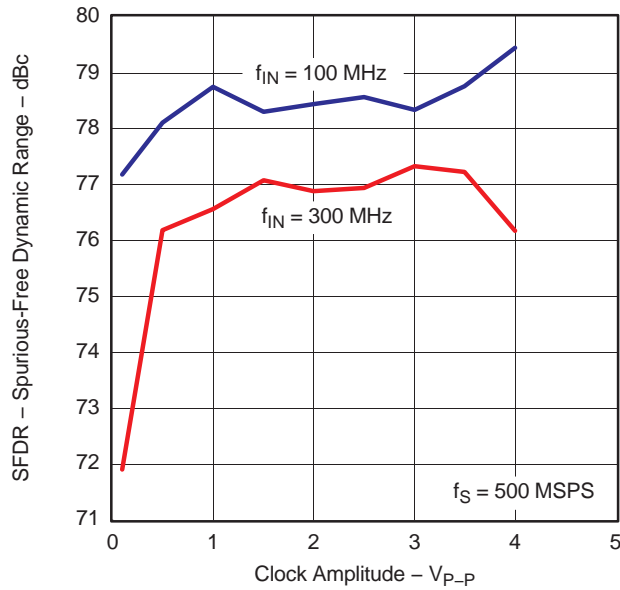

Figure 59. ADS5463 SFDR versus Differential Clock Level

G022

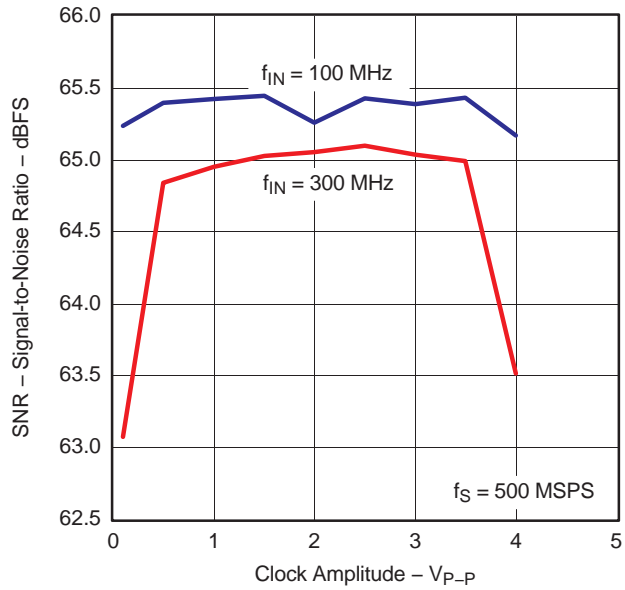
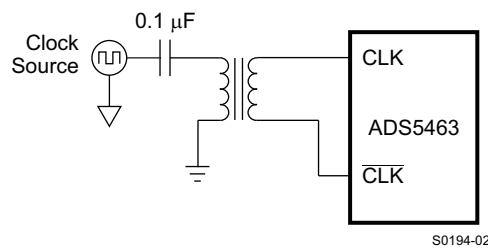

Figure 60. ADS5463 SNR versus Differential Clock Level

G023

The characterization of the ADS5463/ADS54RF63 is typically performed with a 3- V_{PP} differential clock, but the ADC performs well with a differential clock amplitude down to $\sim 0.5 V_{PP}$ (250-mV swing on both \overline{CLK} and CLK), as shown in Figure 59 and Figure 60. For jitter-sensitive applications, the use of a differential clock has some advantages at the system level. The differential clock allows for common-mode noise rejection at the printed circuit board (PCB) level. With a differential clock, the signal-to-noise ratio of the ADC is better for jitter-sensitive, high-frequency applications because the board level clock jitter is superior.

Larger clock amplitude levels are recommended for high analog input frequencies or slow clock frequencies. At high analog input frequencies, the sampling process is sensitive to jitter. At slow clock frequencies, a small amplitude sinusoidal clock has a lower slew rate and can create jitter-related SNR degradation due to the uncertainty in the sampling point associated with a slow slew rate. Figure 61 demonstrates a recommended method for converting a single-ended clock source into a differential clock; it is similar to the configuration found on the evaluation board and was used for much of the characterization. See also *Clocking High Speed Data Converters* (SLYT075) for more details.



S0194-02

Figure 61. Differential Clock

The common-mode voltage of the clock inputs is set internally to 2.4 V using internal 1-k Ω resistors (see Figure 57). It is recommended to use ac coupling, but if this scheme is not possible, the ADS5463 features good tolerance to clock common-mode variation, as shown in Figure 62 and Figure 63 (the ADS54RF63 behaves similarly). The internal ADC core uses both edges of the clock for the conversion process. Ideally, a 50% duty-cycle clock signal should be provided, though even 40/60 is good enough for many applications. Performance degradation as a result of duty cycle can be seen in Figure 64.

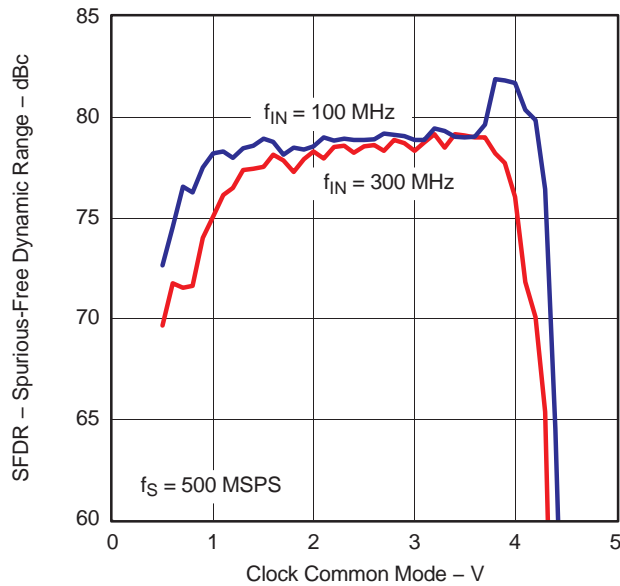

G024

Figure 62. ADS5463 SFDR versus Clock Common Mode

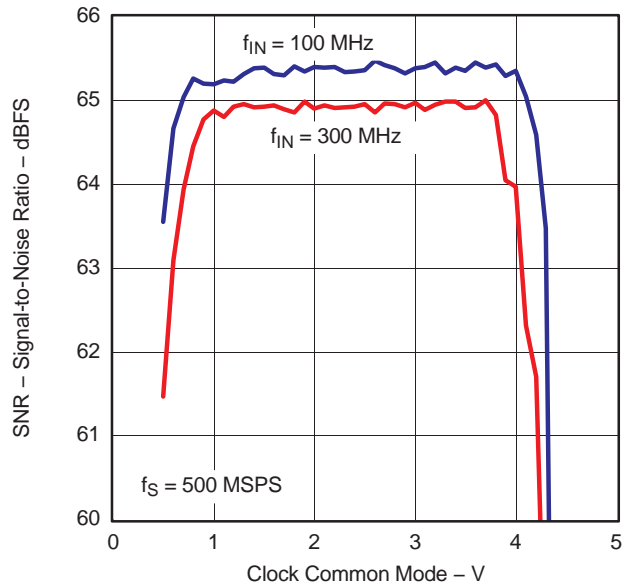

G025

Figure 63. ADS5463 SNR versus Clock Common Mode

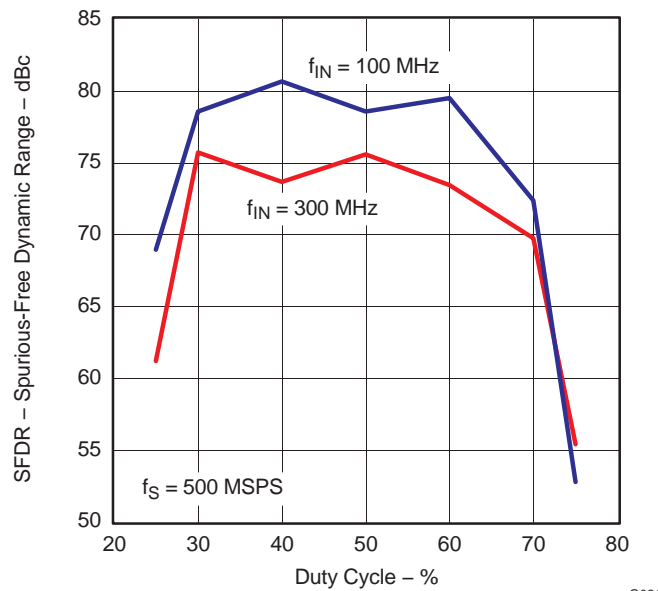

G021

Figure 64. ADS5463 SFDR vs Clock Duty Cycle

To understand how to determine the required clock jitter, an example is useful. The ADS5463 is capable of achieving 63.6 dBFS SNR at 450 MHz of analog input frequency. In order to achieve this SNR at 450 MHz the clock source rms jitter must be at least 181 fsec when combined with the 150 fsec of internal aperture jitter in order for the total rms jitter to be 234 fsec. A summary of maximum recommended rms clock jitter as a function of analog input frequency is provided in [Table 2](#) (using 150 fsec of internal aperture jitter). The equations used to create the table are also presented.

Table 2. Recommended RMS Clock Jitter

INPUT FREQUENCY (MHz)	MEASURED SNR (dBc)	TOTAL JITTER (fsec rms)	MAXIMUM CLOCK JITTER (fsec rms)
10	64.4	9590	9589
70	64.4	1370	1362
100	64.3	970	959
230	64.1	432	405
300	64	335	300
450	63.6	234	181
650	62.9	175	94
1300	58.3	149	16

Equation 1 and Equation 2 are used to estimate the required clock source jitter.

$$\text{SNR (dBc)} = -20 \times \text{LOG}_{10} (2 \times \pi \times f_{\text{IN}} \times j_{\text{TOTAL}}) \tag{1}$$

$$j_{\text{TOTAL}} = (j_{\text{ADC}}^2 + j_{\text{CLOCK}}^2)^{1/2} \tag{2}$$

where:

- j_{TOTAL} = the rms summation of the clock and ADC aperture jitter;
- j_{ADC} = the ADC internal aperture jitter which is located in the data sheet;
- j_{CLOCK} = the rms jitter of the clock at the clock input pins to the ADC; and
- f_{IN} = the analog input frequency.

Notice that the SNR is a strong function of the analog input frequency, not the clock frequency. The slope of the clock source edges can have a mild impact on SNR as well and is not taken into account for these estimates. For this reason, maximizing clock source amplitudes at the ADC clock inputs is recommended, though not required (faster slope is desirable for jitter-related SNR). For more information on clocking high-speed ADCs, see application note [SLWA034, Implementing a CDC7005 Low Jitter Clock Solution For High-Speed, High-IF ADC Devices](#). Recommended clock distribution chips (CDCs) are the TI [CDC7005](#), the [CDCM7005](#), and the [CDCE72010](#). Depending on the jitter requirements, a band pass filter (BPF) is sometimes required between the CDC and the ADC. If the insertion loss of the BPF causes the clock amplitude to be too low for the ADC, or the clock source amplitude is too low to begin with, an inexpensive amplifier can be placed between the CDC and the BPF.

[Figure 65](#) represents a scenario where an LVCMOS single-ended clock output is used from a TI CDCM7005 with the clock signal path optimized for maximum amplitude and minimum jitter. This type of conditioning might generally be well-suited for use with greater than 250 MHz of input frequency. The jitter of this setup is difficult to estimate and requires a careful phase noise analysis of the clock path. The BPF (and possibly a low-cost amplifier because of insertion loss in the BPF) can improve the jitter between the CDC and ADC when the jitter provided by the CDC is still not adequate. The total jitter at the CDCM7005 output depends largely on the phase noise of the VCXO selected, as well as the CDCM7005, and typically has 50 fs – 100 fs of rms jitter. If it is determined that the jitter from the CDCM7005 with a VCXO is sufficient without further conditioning, it is possible to clock the ADS5463/ADS54RF63 directly from the CDCM7005 using differential LVPECL outputs, as illustrated in [Figure 66](#) (see the [CDCM7005 data sheet](#) for the exact schematic). This scenario may be more suitable for less than 150 MHz of input frequency where jitter is not as critical. A careful analysis of the required jitter and of the components involved is recommended before determining the proper approach.

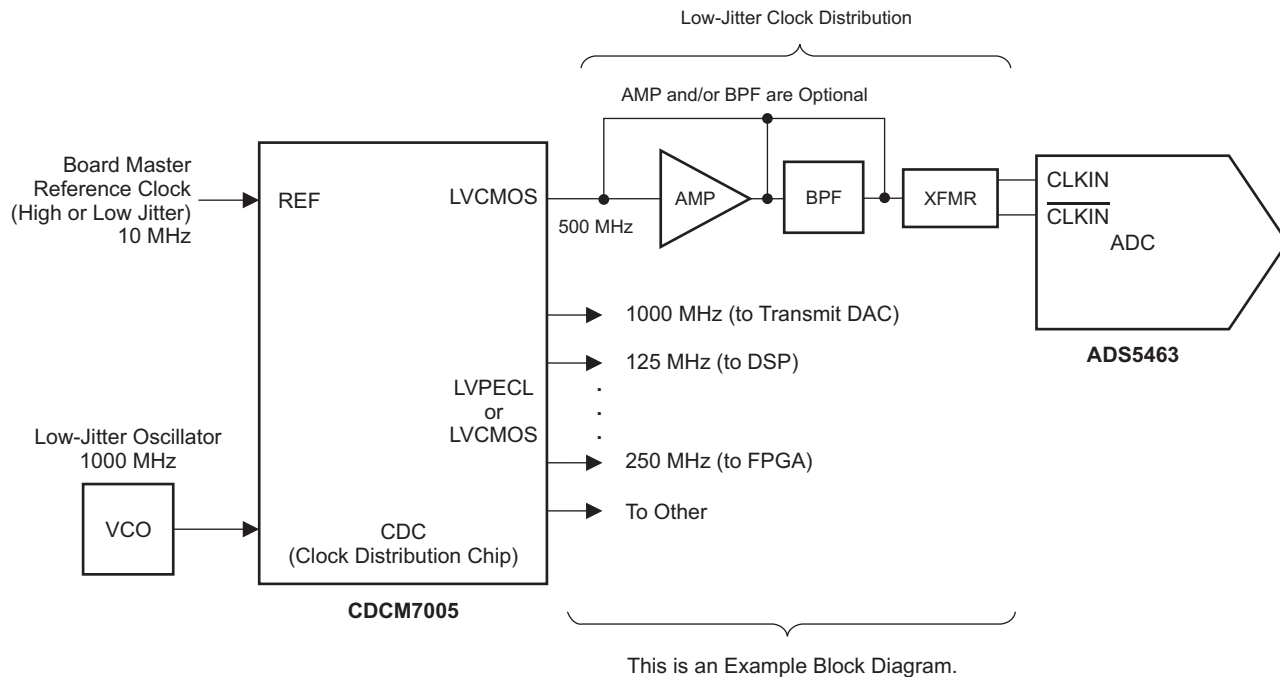

B0268-03

Consult the [CDCM7005 data sheet](#) for proper schematic and specifications regarding allowable input and output frequency and amplitude ranges.

Figure 65. Optimum Jitter Clock Circuit

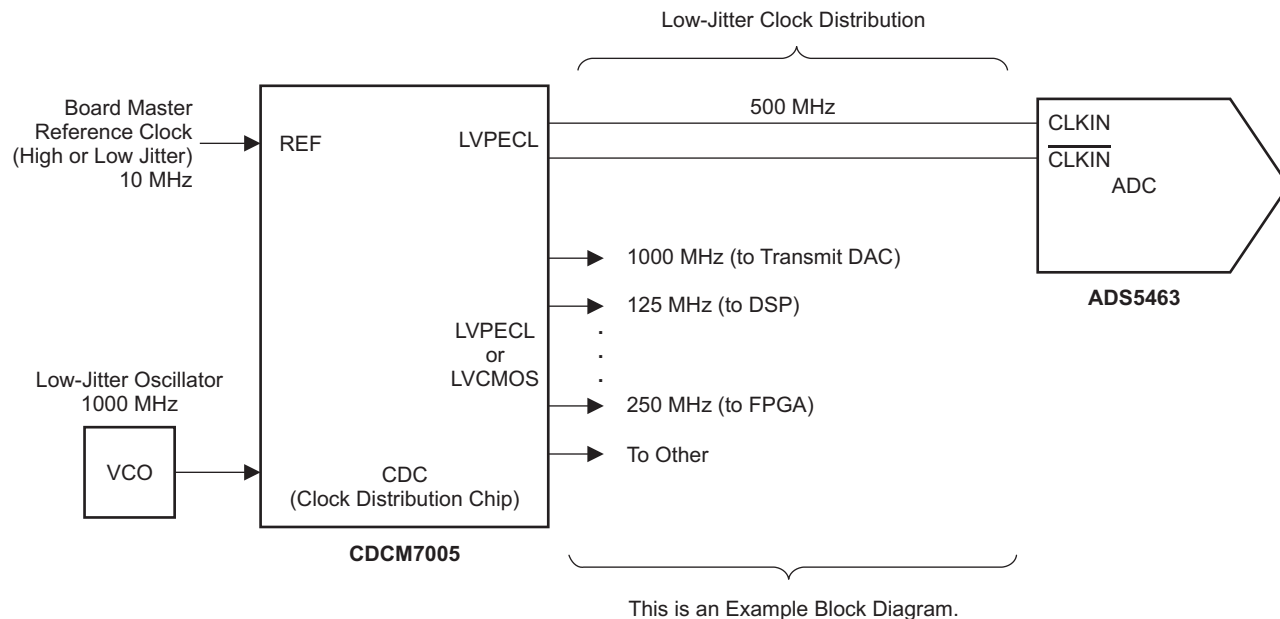

B0343-01

Consult the [CDCM7005 data sheet](#) for proper schematic and specifications regarding allowable input and output frequency and amplitude ranges.

Figure 66. Acceptable Jitter Clock Circuit

Digital Outputs

The ADC provides 12 LVDS-compatible, offset binary data outputs (D11 to D0; D11 is the MSB and D0 is the LSB), a data-ready signal (DRY), and an over-range indicator (OVR). It is recommended to use the DRY signal to capture the output data of the ADS5463/ADS54RF63. DRY is source-synchronous to the DATA/OVR outputs and operates at the same frequency, creating a half-rate DDR interface that updates data on both the rising and falling edges of DRY. It is recommended that the capacitive loading on the digital outputs be minimized. Higher capacitance shortens the data-valid timing window. The values given for timing (see [Figure 1](#)) were obtained with a measured 10-pF parasitic board capacitance to ground on each LVDS line (or 5-pF differential parasitic capacitance). When setting the time relationship between DRY and DATA at the receiving device, it is generally recommended that setup time be maximized, but this partially depends on the setup and hold times of the device receiving the digital data (like an FPGA, Field Programmable Gate Array). Since DRY and DATA are coincident, it will likely be necessary to delay either DRY or DATA such that setup time is maximized.

Referencing [Figure 1](#), the polarity of DRY with respect to the sample N data output transition is undetermined because of the unknown startup logic level of the clock divider that generates the DRY signal (DRY is a frequency divide-by-two of CLK). Either the rising or the falling edge of DRY will be coincident with sample N and the polarity of DRY could invert when power is cycled off/on. Data capture from the transition and not the polarity of DRY is recommended, but not required. If the synchronization of multiple ADS5463/ADS54RF63 devices is required, it might be necessary to use a form of the CLKIN signal rather than DRY to capture the data. Studying the timing characteristics, it can be seen that the ADS54RF63 offers more tightly controlled timing parameters than the ADS5463. Depending on the setup/hold requirements of the FPGA in use, it may be possible to use the DRY from a single ADS54RF63 to latch data into the FPGA from multiple ADS54RF63. This would prove much more difficult with the ADS5463 at full clock speed due to more restrictive timing parameters.

The DRY frequency is identical on the ADS5463/ADS54RF63 to the ADS5474 (where DRY equals half of the CLK frequency), but different to the pin-similar ADS5444/ADS5440 (where DRY equals the CLK frequency). The LVDS outputs all require an external 100-Ω load between each output pair in order to meet the expected LVDS voltage levels. For long trace lengths, it may be necessary to place a 100-Ω load on each digital output as close to the ADC as possible and another 100-Ω differential load at the end of the LVDS transmission line to provide matched impedance and avoid signal reflections. The effective load in this case reduces the LVDS voltage levels by half.

The OVR output equals a logic high when the 12-bit output word attempts to exceed either all 0s or all 1s. The digital outputs will clip to all 0s or all 1s if the input is out of range. The OVR signal is provided as an indicator that the analog input signal exceeded the full-scale input limit of approximately 2.2 V_{PP} (± gain error). The OVR indicator is provided for systems that use gain control to keep the analog input signal within acceptable limits.

Power Supplies

The ADS5463/ADS54RF63 uses three power supplies. For the analog portion of the design, a 5-V and 3.3-V supply (AVDD5 and AVDD3) are used, while the digital portion uses a 3.3-V supply (DVDD3). The use of low-noise power supplies with adequate decoupling is recommended. Linear supplies are preferred to switched supplies; switched supplies tend to generate more noise components that can be coupled to the ADS5463/ADS54RF63. However, the PSRR value and the plot shown in [Figure 67](#) were obtained without bulk supply decoupling capacitors. When bulk (0.1 μ F) decoupling capacitors are used, the board-level PSRR is much higher than the stated value for the ADC. The user may be able to supply power to the device with a less-than-ideal supply and still achieve good performance. It is not possible to make a single recommendation for every type of supply and level of decoupling for all systems. If the noise characteristics of the available supplies are understood, a study of the PSRR data for the ADS5463/ADS54RF63 may provide the user with enough information to select noisy supplies if the performance is still acceptable within the frequency range of interest. The power consumption of the ADS5463/ADS54RF63 does not change substantially over clock rate or input frequency as a result of the architecture and process. The DVDD3 PSRR is superior to both the AVDD5 and AVDD3 so was not graphed.

Because there are two diodes connected in reverse between AVDD3 and DVDD3 internally, a power-up sequence is recommended. When there is a delay in power up between these two supplies, the one that lags could have current sinking through an internal diode before it powers up. The sink current can be large or small depending on the impedance of the external supply and could damage the device or affect the supply source. The best power up sequence is one of the following options (regardless of when AVDD5 powers up):

- Power up both AVDD3 and DVDD3 at the same time (best scenario), OR
- Keep the voltage difference less than 0.8 V between AVDD3 and DVDD3 during the power up (0.8 V is not a hard specification - a smaller delta between supplies is safer).

If the above sequences are not practical then the sink current from the supply needs to be controlled or protection added externally. The max transient current (on the order of μ sec) for the DVDD3 or AVDD3 pin is 500 mA to avoid potential damage to the device or reduce its lifetime.

The values for the analog and clock inputs given in the [Absolute Maximum Ratings](#) are valid when the supplies are on. When the power supplies are off and the clock or analog inputs are still being actively driven, the input voltage and current need to be limited to avoid device damage. If the ADC supplies are off, max/min continuous dc voltage is ± 0.95 V and max dc current is 20 mA for each input pin (clock or analog), relative to ground.

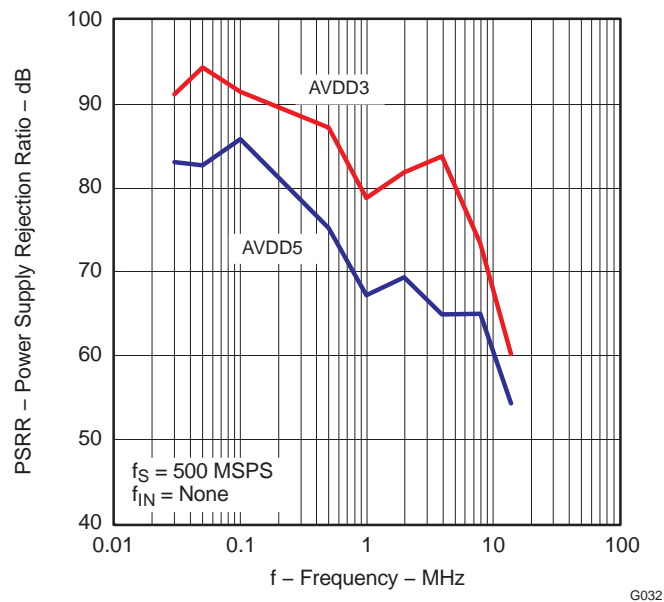

Figure 67. PSRR versus Supply Injected Frequency

Operational Lifetime

It is important for applications that anticipate running continuously for long periods of time near the maximum-rated ambient temperature of +85°C to consider the data shown in Figure 68 and Figure 69. Referring to the Thermal Characteristics table, the worst-case operating condition with no airflow has a thermal rise of 23.7°C/W. At approximately 2.2 W of normal power dissipation, at a maximum ambient of +85°C with no airflow, the junction temperature of the ADS5463 reaches approximately +85°C + 23.7°C/W × 2.2 W = +137°C and therefore the expected lifetime is approximately 8 years due to an electro migration failure and 18 years due to a wirebonding failure. Being even more conservative and accounting for the maximum possible power dissipation that is ensured (2.4 W), the junction temperature becomes nearly +142°C. As Figure 68 and Figure 69 show, this operating condition limits the expected lifetime of the ADS5463 even more. Operation at +85°C continuously may require airflow or an additional heatsink in order to decrease the internal junction temperature and increase the expected lifetime. An airflow of 250 LFM (linear feet per minute) reduces the thermal resistance to 16.4°C/W, the maximum junction temperature to +124°C and the expected lifetime to over 10 years, assuming a worst-case of 2.4 W and +85°C ambient. Of course, operation at lower ambient temperatures greatly increases the expected lifetime.

The ADS5463/ADS54RF63 performance over temperature is quite good and can be seen starting in Figure 19. Although the typical plots show good performance at +100°C, the device is only rated from –40°C to +85°C. For continuous operation at temperatures near or above the maximum, aside from performance degradation, the expected primary negative effect is a shorter device lifetime.

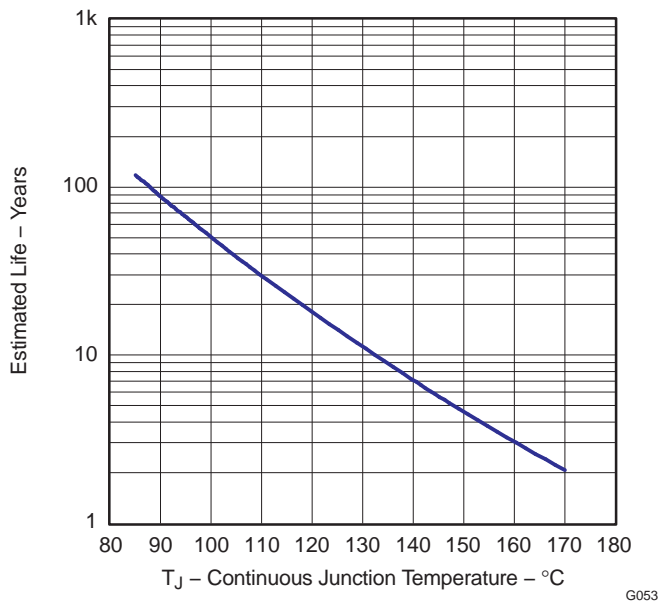

Figure 68. Operating Life Derating Chart, Electro Migration Fail Mode

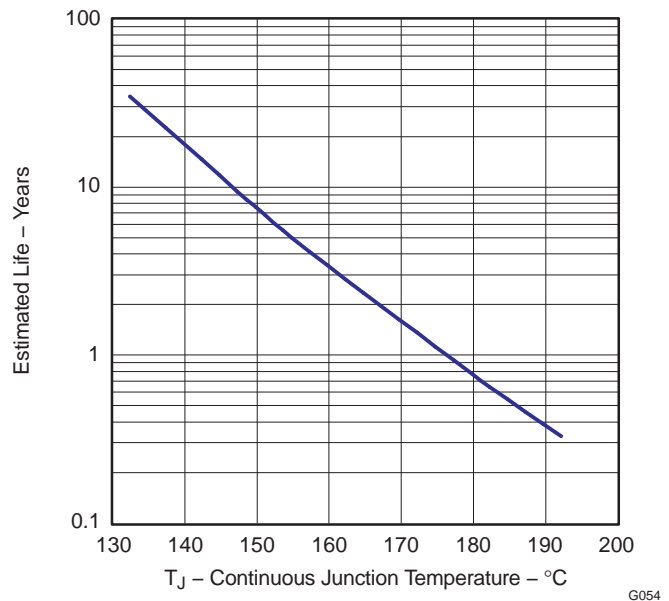

Figure 69. Operating Life Derating Chart, Wirebound Voiding Fail Mode

Layout Information

The evaluation board represents a good guideline of how to lay out the board to obtain maximum performance from the ADS5463/ADS54RF63. General design rules, such as the use of multilayer boards, single ground plane for ADC ground connections, and local decoupling ceramic chip capacitors, should be applied. The input traces should be isolated from any external source of interference or noise, including the digital outputs as well as the clock traces. The clock signal traces should also be isolated from other signals, especially in applications where low jitter is required like high IF sampling. Besides performance-oriented rules, care must be taken when considering the heat dissipation of the device. The thermal heat sink should be soldered to the board as described in the [PowerPAD Package](#) section. See *ADS5463 EVM User Guide (SLAU194)* on the TI web site for the evaluation board schematic.

PowerPAD Package

The PowerPAD package is a thermally enhanced standard-size IC package designed to eliminate the use of bulky heatsinks and slugs traditionally used in thermal packages. This package can be easily mounted using standard printed circuit board (PCB) assembly techniques and can be removed and replaced using standard repair procedures.

The PowerPAD package is designed so that the leadframe die pad (or thermal pad) is exposed on the bottom of the IC. This provides an extremely low thermal resistance path between the die and the exterior of the package. The thermal pad on the bottom of the IC can then be soldered directly to the printed circuit board (PCB), using the PCB as a heatsink.

Assembly Process

1. Prepare the PCB top-side etch pattern including etch for the leads as well as the thermal pad as illustrated in the Mechanical Data section.
2. Place a 6-by-6 array of thermal vias in the thermal pad area. These holes should be 13 mils in diameter. The small size prevents wicking of the solder through the holes.
3. It is recommended to place a small number of 25-mil-diameter holes under the package, but outside the thermal pad area, to provide an additional heat path.
4. Connect all holes (both inside and outside the thermal pad area) to an internal copper plane (such as a ground plane).
5. Do not use the typical web or spoke via-connection pattern when connecting the thermal vias to the ground plane. The spoke pattern increases the thermal resistance to the ground plane.
6. The top-side solder mask should leave exposed the terminals of the package and the thermal pad area.
7. Cover the entire bottom side of the PowerPAD vias to prevent solder wicking.
8. Apply solder paste to the exposed thermal pad area and all of the package terminals.

For more detailed information regarding the PowerPAD package and its thermal properties, see either the *PowerPAD Made Easy* application brief ([SLMA004](#)) or the *PowerPAD Thermally Enhanced Package* application report ([SLMA002](#)).

DEFINITION OF SPECIFICATIONS

Analog Bandwidth

The analog input frequency at which the power of the fundamental is reduced by 3 dB with respect to the low-frequency value

Aperture Delay

The delay in time between the rising edge of the input sampling clock and the actual time at which the sampling occurs

Aperture Uncertainty (Jitter)

The sample-to-sample variation in aperture delay

Clock Pulse Duration/Duty Cycle

The duty cycle of a clock signal is the ratio of the time the clock signal remains at a logic high (clock pulse duration) to the period of the clock signal, expressed as a percentage.

Differential Nonlinearity (DNL)

An ideal ADC exhibits code transitions at analog input values spaced exactly 1 LSB apart. DNL is the deviation of any single step from this ideal value, measured in units of LSB.

Common-Mode Rejection Ratio (CMRR)

CMRR measures the ability to reject signals that are presented to both analog inputs simultaneously. The injected common-mode frequency level is translated into dBFS, the spur in the output FFT is measured in dBFS, and the difference is the CMRR in dB.

Effective Number of Bits (ENOB)

ENOB is a measure in units of bits of a converter's performance as compared to the theoretical limit based on quantization noise

$$\text{ENOB} = (\text{SINAD} - 1.76)/6.02$$

Gain Error

Gain error is the deviation of the ADC actual input full-scale range from its ideal value, given as a percentage of the ideal input full-scale range.

Integral Nonlinearity (INL)

INL is the deviation of the ADC transfer function from a best-fit line determined by a least-squares curve fit of that transfer function. The INL at each analog input value is the difference between the actual transfer function and this best-fit line, measured in units of LSB.

Offset Error

Offset error is the deviation of output code from mid-code when both inputs are tied to common-mode.

Power-Supply Rejection Ratio (PSRR)

PSRR is a measure of the ability to reject frequencies present on the power supply. The injected frequency level is translated into dBFS, the spur in the output FFT is measured in dBFS, and the difference is the PSRR in dB. The measurement calibrates out the benefit of the board supply decoupling capacitors.

Signal-to-Noise Ratio (SNR)

SNR is the ratio of the power of the fundamental (P_S) to the noise floor power (P_N), excluding the power at dc and in the first five harmonics.

$$\text{SNR} = 10\log_{10} \frac{P_S}{P_N} \quad (4)$$

SNR is either given in units of dBc (dB to carrier) when the absolute power of the fundamental is used as the reference, or dBFS (dB to full scale) when the power of the fundamental is extrapolated to the converter's full-scale range.

Signal-to-Noise and Distortion (SINAD)

SINAD is the ratio of the power of the fundamental (P_S) to the power of all the other spectral components including noise (P_N) and distortion (P_D), but excluding dc.

$$\text{SINAD} = 10\log_{10} \frac{P_S}{P_N + P_D} \quad (5)$$

SINAD is either given in units of dBc (dB to carrier) when the absolute power of the fundamental is used as the reference, or dBFS (dB to full scale) when the power of the fundamental is extrapolated to the converter's full-scale range.

Temperature Drift

Temperature drift (with respect to gain error and offset error) specifies the change from the value at the nominal temperature to the value at T_{MIN} or T_{MAX} . It is computed as the maximum variation of the parameters over the whole temperature range divided by $T_{\text{MIN}} - T_{\text{MAX}}$.

Total Harmonic Distortion (THD)

THD is the ratio of the power of the fundamental (P_S) to the power of the first five harmonics (P_D).

$$\text{THD} = 10\log_{10} \frac{P_S}{P_D} \quad (6)$$

THD is typically given in units of dBc (dB to carrier).

Two-Tone Intermodulation Distortion (IMD3)

IMD3 is the ratio of the power of the fundamental (at frequencies f_1 , f_2) to the power of the worst spectral component at either frequency $2f_1 - f_2$ or $2f_2 - f_1$. IMD3 is given in units of either dBc (dB to carrier) when the absolute power of the fundamental is used as the reference, or dBFS (dB to full scale) when the power of the fundamental is extrapolated to the converter's full-scale range.

REVISION HISTORY

Changes from Revision D (FEBRUARY 2009) to Revision E	Page
• Added AC to High Analog Input Swing feature description	1
• Changed clock and analog inputs and data outputs in ABSOLUTE MAXIMUM RATINGS table	2

PACKAGING INFORMATION

Orderable Device	Status ⁽¹⁾	Package Type	Package Drawing	Pins	Package Qty	Eco Plan ⁽²⁾	Lead/Ball Finish	MSL Peak Temp ⁽³⁾
ADS5463IPFP	ACTIVE	HTQFP	PFP	80	96	Green (RoHS & no Sb/Br)	CU NIPDAU	Level-4-260C-72 HR
ADS5463IPFPG4	ACTIVE	HTQFP	PFP	80	96	Green (RoHS & no Sb/Br)	CU NIPDAU	Level-4-260C-72 HR
ADS5463IPFPR	ACTIVE	HTQFP	PFP	80	1000	Green (RoHS & no Sb/Br)	CU NIPDAU	Level-4-260C-72 HR
ADS5463IPFPRG4	ACTIVE	HTQFP	PFP	80	1000	Green (RoHS & no Sb/Br)	CU NIPDAU	Level-4-260C-72 HR
ADS54RF63IPFP	ACTIVE	HTQFP	PFP	80	96	Green (RoHS & no Sb/Br)	CU NIPDAU	Level-4-260C-72 HR
ADS54RF63IPFPR	ACTIVE	HTQFP	PFP	80	1000	Green (RoHS & no Sb/Br)	CU NIPDAU	Level-4-260C-72 HR

⁽¹⁾ The marketing status values are defined as follows:

ACTIVE: Product device recommended for new designs.

LIFEBUY: TI has announced that the device will be discontinued, and a lifetime-buy period is in effect.

NRND: Not recommended for new designs. Device is in production to support existing customers, but TI does not recommend using this part in a new design.

PREVIEW: Device has been announced but is not in production. Samples may or may not be available.

OBSOLETE: TI has discontinued the production of the device.

⁽²⁾ Eco Plan - The planned eco-friendly classification: Pb-Free (RoHS), Pb-Free (RoHS Exempt), or Green (RoHS & no Sb/Br) - please check <http://www.ti.com/productcontent> for the latest availability information and additional product content details.

TBD: The Pb-Free/Green conversion plan has not been defined.

Pb-Free (RoHS): TI's terms "Lead-Free" or "Pb-Free" mean semiconductor products that are compatible with the current RoHS requirements for all 6 substances, including the requirement that lead not exceed 0.1% by weight in homogeneous materials. Where designed to be soldered at high temperatures, TI Pb-Free products are suitable for use in specified lead-free processes.

Pb-Free (RoHS Exempt): This component has a RoHS exemption for either 1) lead-based flip-chip solder bumps used between the die and package, or 2) lead-based die adhesive used between the die and leadframe. The component is otherwise considered Pb-Free (RoHS compatible) as defined above.

Green (RoHS & no Sb/Br): TI defines "Green" to mean Pb-Free (RoHS compatible), and free of Bromine (Br) and Antimony (Sb) based flame retardants (Br or Sb do not exceed 0.1% by weight in homogeneous material)

⁽³⁾ MSL, Peak Temp. -- The Moisture Sensitivity Level rating according to the JEDEC industry standard classifications, and peak solder temperature.

Important Information and Disclaimer: The information provided on this page represents TI's knowledge and belief as of the date that it is provided. TI bases its knowledge and belief on information provided by third parties, and makes no representation or warranty as to the accuracy of such information. Efforts are underway to better integrate information from third parties. TI has taken and continues to take reasonable steps to provide representative and accurate information but may not have conducted destructive testing or chemical analysis on incoming materials and chemicals. TI and TI suppliers consider certain information to be proprietary, and thus CAS numbers and other limited information may not be available for release.

In no event shall TI's liability arising out of such information exceed the total purchase price of the TI part(s) at issue in this document sold by TI to Customer on an annual basis.

OTHER QUALIFIED VERSIONS OF ADS5463 :

- Enhanced Product: [ADS5463-EP](#)
- Space: [ADS5463-SP](#)

NOTE: Qualified Version Definitions:

- Enhanced Product - Supports Defense, Aerospace and Medical Applications
- Space - Radiation tolerant, ceramic packaging and qualified for use in Space-based application

TAPE AND REEL INFORMATION

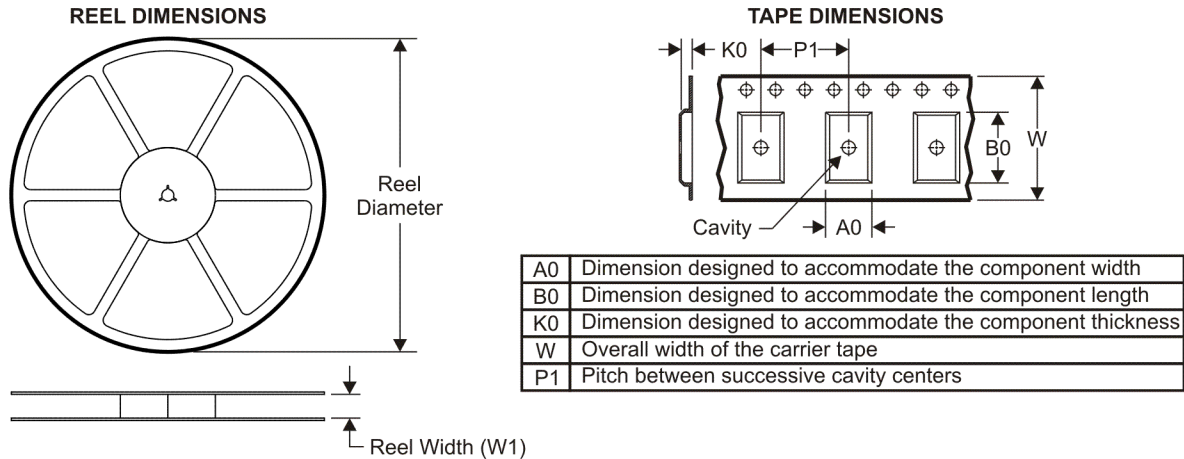

QUADRANT ASSIGNMENTS FOR PIN 1 ORIENTATION IN TAPE

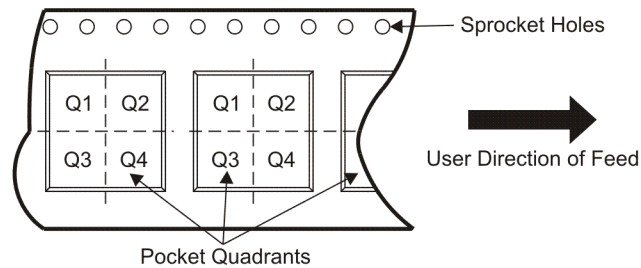

*All dimensions are nominal

Device	Package Type	Package Drawing	Pins	SPQ	Reel Diameter (mm)	Reel Width W1 (mm)	A0 (mm)	B0 (mm)	K0 (mm)	P1 (mm)	W (mm)	Pin1 Quadrant
ADS5463IPFPR	HTQFP	PFP	80	1000	330.0	24.4	15.0	15.0	1.5	20.0	24.0	Q2
ADS54RF63IPFPR	HTQFP	PFP	80	1000	330.0	24.4	15.0	15.0	1.5	20.0	24.0	Q2

TAPE AND REEL BOX DIMENSIONS



*All dimensions are nominal

Device	Package Type	Package Drawing	Pins	SPQ	Length (mm)	Width (mm)	Height (mm)
ADS5463IPFPR	HTQFP	PFP	80	1000	346.0	346.0	41.0
ADS54RF63IPFPR	HTQFP	PFP	80	1000	346.0	346.0	41.0

MECHANICAL DATA

PFP (S-PQFP-G80)

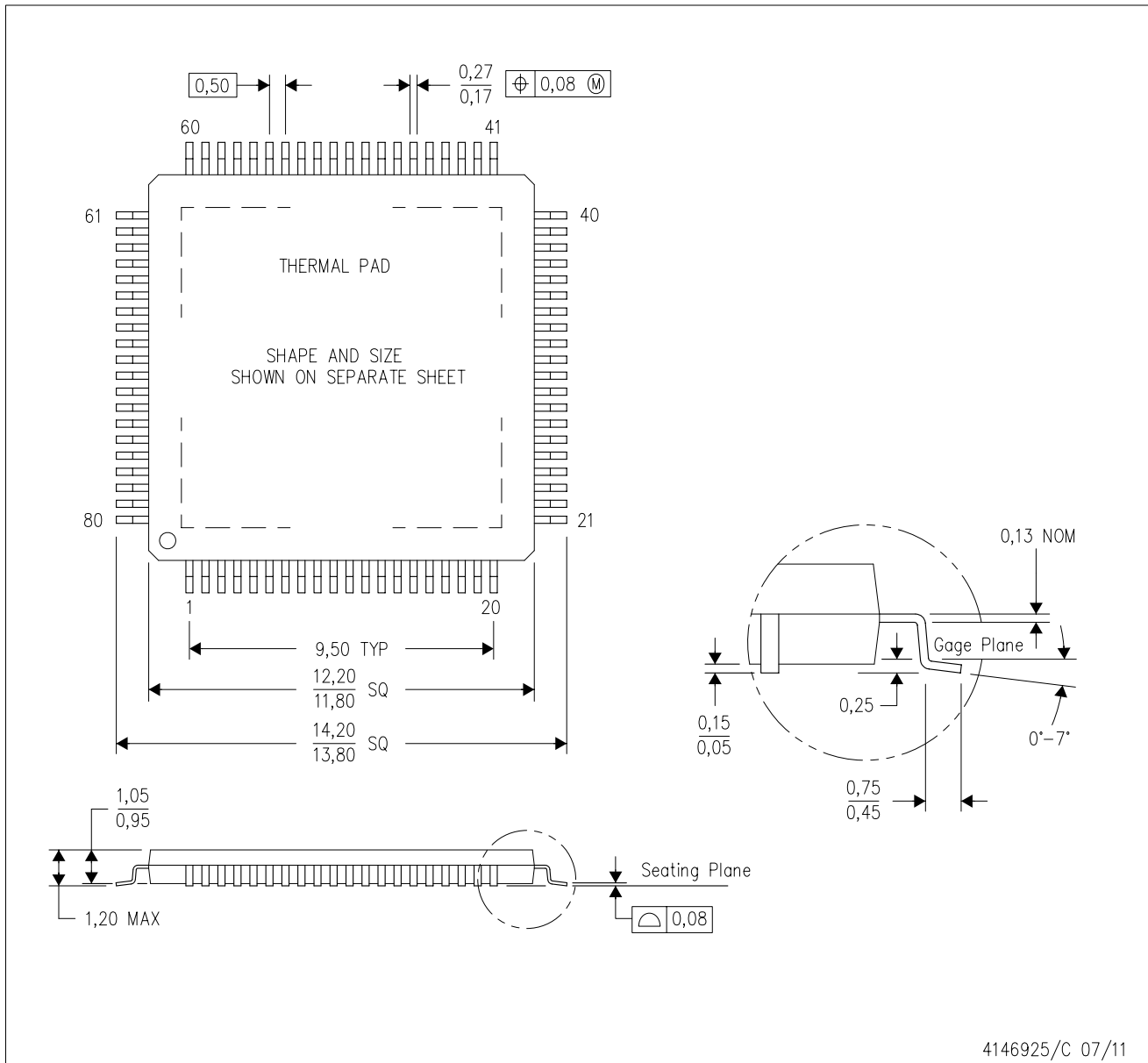
PowerPAD™ PLASTIC QUAD FLATPACK



- NOTES:
- A. All linear dimensions are in millimeters.
 - B. This drawing is subject to change without notice.
 - C. Body dimensions do not include mold flash or protrusion
 - D. This package is designed to be soldered to a thermal pad on the board. Refer to Technical Brief, PowerPad Thermally Enhanced Package, Texas Instruments Literature No. SLMA002 for information regarding recommended board layout. This document is available at www.ti.com <<http://www.ti.com>>.
 - E. See the additional figure in the Product Data Sheet for details regarding the exposed thermal pad features and dimensions.
 - F. Falls within JEDEC MS-026

PowerPAD is a trademark of Texas Instruments.

THERMAL PAD MECHANICAL DATA

PFP (S-PQFP-G80)

PowerPAD™ PLASTIC QUAD FLATPACK

THERMAL INFORMATION

This PowerPAD™ package incorporates an exposed thermal pad that is designed to be attached to a printed circuit board (PCB). The thermal pad must be soldered directly to the PCB. After soldering, the PCB can be used as a heatsink. In addition, through the use of thermal vias, the thermal pad can be attached directly to the appropriate copper plane shown in the electrical schematic for the device, or alternatively, can be attached to a special heatsink structure designed into the PCB. This design optimizes the heat transfer from the integrated circuit (IC).

For additional information on the PowerPAD package and how to take advantage of its heat dissipating abilities, refer to Technical Brief, PowerPAD Thermally Enhanced Package, Texas Instruments Literature No. SLMA002 and Application Brief, PowerPAD Made Easy, Texas Instruments Literature No. SLMA004. Both documents are available at www.ti.com.

The exposed thermal pad dimensions for this package are shown in the following illustration.

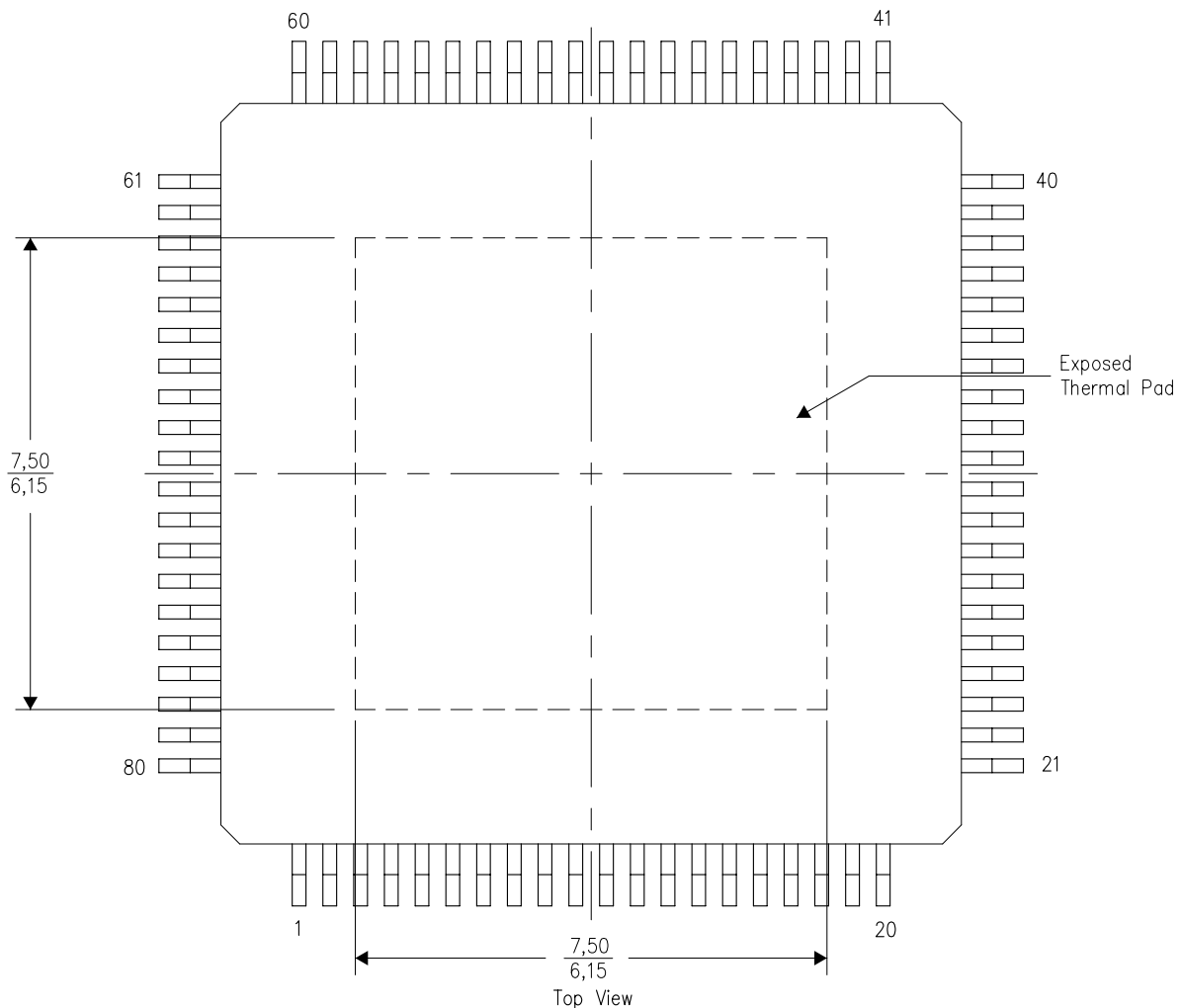

4206327-2/N 09/11

NOTE: A. All linear dimensions are in millimeters

PowerPAD is a trademark of Texas Instruments

LAND PATTERN DATA

PFP (S-PQFP-G80)

PowerPAD™ PLASTIC QUAD FLATPACK

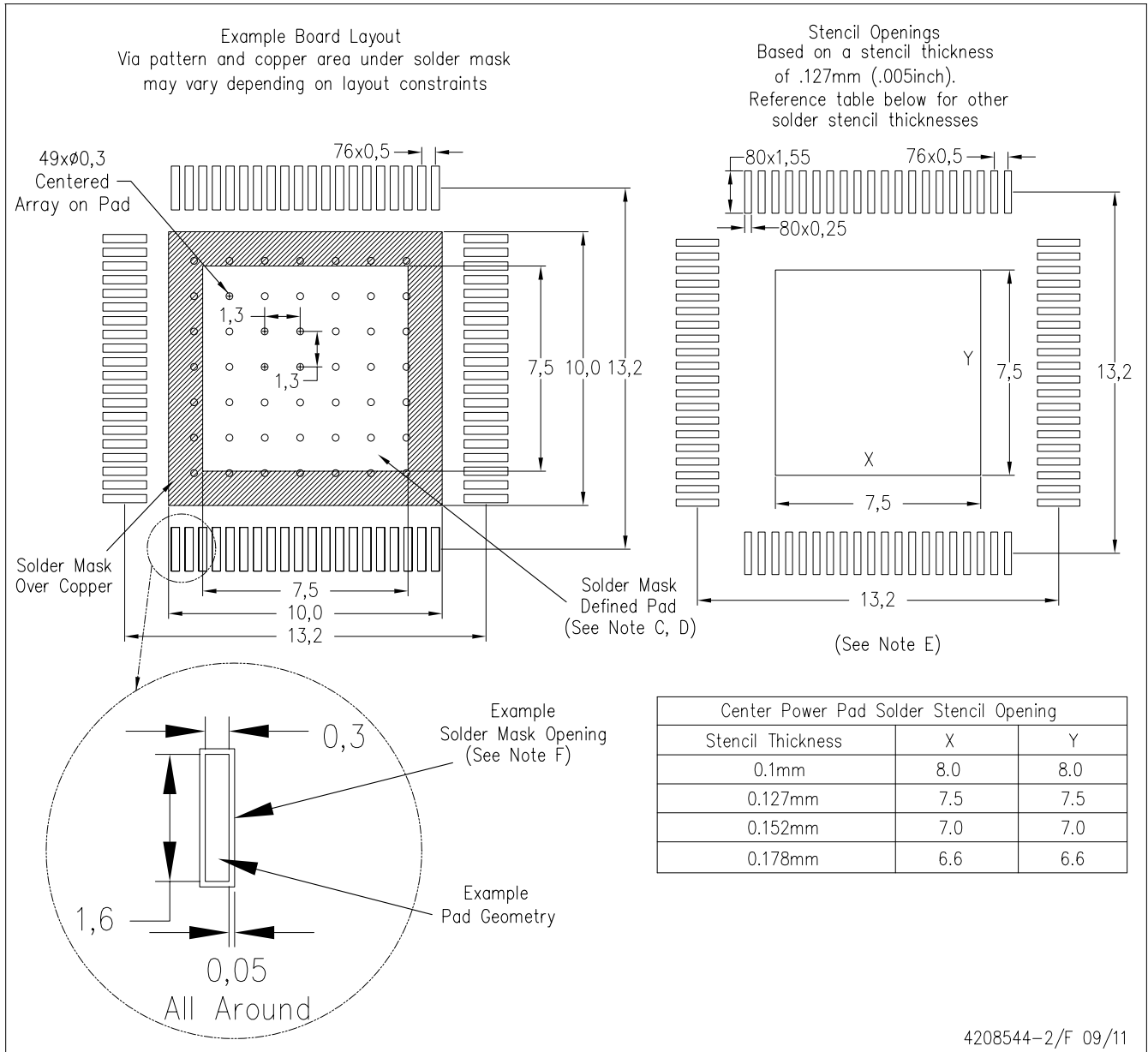

- NOTES:
- All linear dimensions are in millimeters.
 - This drawing is subject to change without notice.
 - Customers should place a note on the circuit board fabrication drawing not to alter the center solder mask defined pad.
 - This package is designed to be soldered to a thermal pad on the board. Refer to Technical Brief, PowerPad Thermally Enhanced Package, Texas Instruments Literature No. SLMA002, SLMA004, and also the Product Data Sheets for specific thermal information, via requirements, and recommended board layout. These documents are available at www.ti.com <<http://www.ti.com>>. Publication IPC-7351 is recommended for alternate designs.
 - Laser cutting apertures with trapezoidal walls and also rounding corners will offer better paste release. Customers should contact their board assembly site for stencil design recommendations. Example stencil design based on a 50% volumetric metal load solder paste. Refer to IPC-7525 for other stencil recommendations.
 - Customers should contact their board fabrication site for solder mask tolerances between and around signal pads.

PowerPAD is a trademark of Texas Instruments.

IMPORTANT NOTICE

Texas Instruments Incorporated and its subsidiaries (TI) reserve the right to make corrections, modifications, enhancements, improvements, and other changes to its products and services at any time and to discontinue any product or service without notice. Customers should obtain the latest relevant information before placing orders and should verify that such information is current and complete. All products are sold subject to TI's terms and conditions of sale supplied at the time of order acknowledgment.

TI warrants performance of its hardware products to the specifications applicable at the time of sale in accordance with TI's standard warranty. Testing and other quality control techniques are used to the extent TI deems necessary to support this warranty. Except where mandated by government requirements, testing of all parameters of each product is not necessarily performed.

TI assumes no liability for applications assistance or customer product design. Customers are responsible for their products and applications using TI components. To minimize the risks associated with customer products and applications, customers should provide adequate design and operating safeguards.

TI does not warrant or represent that any license, either express or implied, is granted under any TI patent right, copyright, mask work right, or other TI intellectual property right relating to any combination, machine, or process in which TI products or services are used. Information published by TI regarding third-party products or services does not constitute a license from TI to use such products or services or a warranty or endorsement thereof. Use of such information may require a license from a third party under the patents or other intellectual property of the third party, or a license from TI under the patents or other intellectual property of TI.

Reproduction of TI information in TI data books or data sheets is permissible only if reproduction is without alteration and is accompanied by all associated warranties, conditions, limitations, and notices. Reproduction of this information with alteration is an unfair and deceptive business practice. TI is not responsible or liable for such altered documentation. Information of third parties may be subject to additional restrictions.

Resale of TI products or services with statements different from or beyond the parameters stated by TI for that product or service voids all express and any implied warranties for the associated TI product or service and is an unfair and deceptive business practice. TI is not responsible or liable for any such statements.

TI products are not authorized for use in safety-critical applications (such as life support) where a failure of the TI product would reasonably be expected to cause severe personal injury or death, unless officers of the parties have executed an agreement specifically governing such use. Buyers represent that they have all necessary expertise in the safety and regulatory ramifications of their applications, and acknowledge and agree that they are solely responsible for all legal, regulatory and safety-related requirements concerning their products and any use of TI products in such safety-critical applications, notwithstanding any applications-related information or support that may be provided by TI. Further, Buyers must fully indemnify TI and its representatives against any damages arising out of the use of TI products in such safety-critical applications.

TI products are neither designed nor intended for use in military/aerospace applications or environments unless the TI products are specifically designated by TI as military-grade or "enhanced plastic." Only products designated by TI as military-grade meet military specifications. Buyers acknowledge and agree that any such use of TI products which TI has not designated as military-grade is solely at the Buyer's risk, and that they are solely responsible for compliance with all legal and regulatory requirements in connection with such use.

TI products are neither designed nor intended for use in automotive applications or environments unless the specific TI products are designated by TI as compliant with ISO/TS 16949 requirements. Buyers acknowledge and agree that, if they use any non-designated products in automotive applications, TI will not be responsible for any failure to meet such requirements.

Following are URLs where you can obtain information on other Texas Instruments products and application solutions:

Products

Audio	www.ti.com/audio
Amplifiers	amplifier.ti.com
Data Converters	dataconverter.ti.com
DLP® Products	www.dlp.com
DSP	dsp.ti.com
Clocks and Timers	www.ti.com/clocks
Interface	interface.ti.com
Logic	logic.ti.com
Power Mgmt	power.ti.com
Microcontrollers	microcontroller.ti.com
RFID	www.ti-rfid.com
OMAP Mobile Processors	www.ti.com/omap
Wireless Connectivity	www.ti.com/wirelessconnectivity

Applications

Communications and Telecom	www.ti.com/communications
Computers and Peripherals	www.ti.com/computers
Consumer Electronics	www.ti.com/consumer-apps
Energy and Lighting	www.ti.com/energy
Industrial	www.ti.com/industrial
Medical	www.ti.com/medical
Security	www.ti.com/security
Space, Avionics and Defense	www.ti.com/space-avionics-defense
Transportation and Automotive	www.ti.com/automotive
Video and Imaging	www.ti.com/video

TI E2E Community Home Page

e2e.ti.com

Mailing Address: Texas Instruments, Post Office Box 655303, Dallas, Texas 75265
Copyright © 2011, Texas Instruments Incorporated