

8-Bit Serial-In/Parallel-Out Shift Register

Features

- Buffered Inputs
- Typical Propagation Delay
 - 6ns at $V_{CC} = 5V$, $T_A = 25^{\circ}C$, $C_L = 50pF$
- Exceeds 2kV ESD Protection MIL-STD-883, Method 3015
- SCR-Latchup-Resistant CMOS Process and Circuit Design
- Speed of Bipolar FAST™/AS/S with Significantly Reduced Power Consumption
- Balanced Propagation Delays
- AC Types Feature 1.5V to 5.5V Operation and Balanced Noise Immunity at 30% of the Supply
- $\pm 24mA$ Output Drive Current
 - Fanout to 15 FAST™ ICs
 - Drives 50 Ω Transmission Lines

Description

The 'AC164 and 'ACT164 are 8-bit serial-in/parallel-out shift registers with asynchronous reset that utilize Advanced CMOS Logic technology. Data is shifted on the positive edge of the clock (CP). A LOW on the Master Reset (\overline{MR}) pin resets the shift register and all outputs go to the LOW state regardless of the input conditions. Two Serial Data inputs (DS1 and DS2) are provided; either one can be used as a Data Enable control.

Ordering Information

PART NUMBER	TEMP. RANGE ($^{\circ}C$)	PACKAGE
CD54AC164F3A	-55 to 125	14 Ld CERDIP
CD74AC164E	-55 to 125	14 Ld PDIP
CD74AC164M	-55 to 125	14 Ld SOIC
CD54ACT164F3A	-55 to 125	14 Ld CERDIP
CD74ACT164E	-55 to 125	14 Ld PDIP
CD74ACT164M	-55 to 125	14 Ld SOIC

NOTES:

1. When ordering, use the entire part number. Add the suffix 96 to obtain the variant in the tape and reel.
2. Wafer and die for this part number is available which meets all electrical specifications. Please contact your local TI sales office or customer service for ordering information.

Pinout

CD54AC164, CD54ACT164
(CERDIP)
CD74AC164, CD74ACT164
(PDIP, SOIC)
TOP VIEW

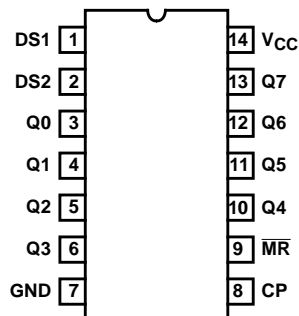

CD54/74AC164, CD54/74ACT164

Functional Diagram

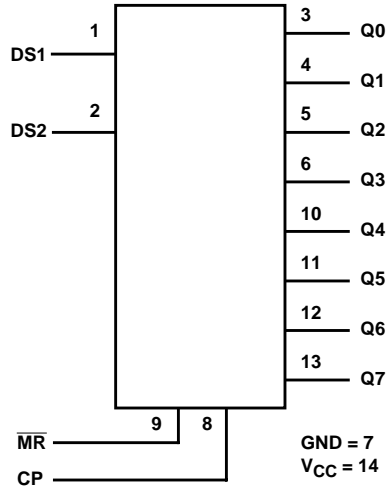

MODE SELECT - TRUTH TABLE

OPERATING MODE	INPUTS				OUTPUTS	
	MR	CP	DS1	DS2	Q0	Q1 - Q7
RESET (CLEAR)	L	X	X	X	L	L - L
SHIFT	H	↑	l	l	L	q0 - q6
	H	↑	l	h	L	q0 - q6
	H	↑	h	l	L	q0 - q6
	H	↑	h	h	H	q0 - q6

H = HIGH voltage level steady state.

L = LOW voltage level steady state.

h = HIGH voltage level one setup time prior to the LOW-to_HIGH clock transition.

l = LOW voltage level one setup time prior to the LOW-to-HIGH clock transition.

X = Don't care.

q = Lowercase letters indicate the state of the referenced output prior to the LOW-to-HIGH clock transition.

↑ = LOW-to-HIGH clock transition.

CD54/74AC164, CD54/74ACT164

Absolute Maximum Ratings

DC Supply Voltage, V_{CC}	-0.5V to 6V
DC Input Diode Current, I_{IK}	
For $V_I < -0.5V$ or $V_I > V_{CC} + 0.5V$	$\pm 20mA$
DC Output Diode Current, I_{OK}	
For $V_O < -0.5V$ or $V_O > V_{CC} + 0.5V$	$\pm 50mA$
DC Output Source or Sink Current per Output Pin, I_O	
For $V_O > -0.5V$ or $V_O < V_{CC} + 0.5V$	$\pm 50mA$
DC V_{CC} or Ground Current, I_{CC} or I_{GND} (Note 3)	$\pm 100mA$

Thermal Information

Thermal Resistance (Typical, Note 5)	θ_{JA} ($^{\circ}C/W$)
PDIP Package	90
SOIC Package	175
Maximum Junction Temperature (Plastic Package)	$150^{\circ}C$
Maximum Storage Temperature Range	$-65^{\circ}C$ to $150^{\circ}C$
Maximum Lead Temperature (Soldering 10s)	$300^{\circ}C$ (SOIC - Lead Tips Only)

Operating Conditions

Temperature Range, T_A	$-55^{\circ}C$ to $125^{\circ}C$
Supply Voltage Range, V_{CC} (Note 4)	
AC Types	1.5V to 5.5V
ACT Types	4.5V to 5.5V
DC Input or Output Voltage, V_I , V_O	0V to V_{CC}
Input Rise and Fall Slew Rate, dt/dv	
AC Types, 1.5V to 3V	50ns (Max)
AC Types, 3.6V to 5.5V	20ns (Max)
ACT Types, 4.5V to 5.5V	10ns (Max)

CAUTION: Stresses above those listed in "Absolute Maximum Ratings" may cause permanent damage to the device. This is a stress only rating and operation of the device at these or any other conditions above those indicated in the operational sections of this specification is not implied.

NOTES:

3. For up to 4 outputs per device, add $\pm 25mA$ for each additional output.
4. Unless otherwise specified, all voltages are referenced to ground.
5. θ_{JA} is measured with the component mounted on an evaluation PC board in free air.

DC Electrical Specifications

PARAMETER	SYMBOL	TEST CONDITIONS		V_{CC} (V)	25 $^{\circ}C$		-40 $^{\circ}C$ TO 85 $^{\circ}C$		-55 $^{\circ}C$ TO 125 $^{\circ}C$		UNITS	
		V_I (V)	I_O (mA)		MIN	MAX	MIN	MAX	MIN	MAX		
AC TYPES												
High Level Input Voltage	V_{IH}	-	-	1.5	1.2	-	1.2	-	1.2	-	V	
				3	2.1	-	2.1	-	2.1	-	V	
				5.5	3.85	-	3.85	-	3.85	-	V	
Low Level Input Voltage	V_{IL}	-	-	1.5	-	0.3	-	0.3	-	0.3	V	
				3	-	0.9	-	0.9	-	0.9	V	
				5.5	-	1.65	-	1.65	-	1.65	V	
High Level Output Voltage	V_{OH}	V_{IH} or V_{IL}	-0.05	-0.05	1.5	1.4	-	1.4	-	1.4	-	V
			-0.05	-0.05	3	2.9	-	2.9	-	2.9	-	V
			-0.05	-0.05	4.5	4.4	-	4.4	-	4.4	-	V
			-4	-4	3	2.58	-	2.48	-	2.4	-	V
			-24	-24	4.5	3.94	-	3.8	-	3.7	-	V
			-75 (Note 6, 7)	-75 (Note 6, 7)	5.5	-	-	3.85	-	-	-	V
-50 (Note 6, 7)	-50 (Note 6, 7)	5.5	-	-	-	-	3.85	-	V			

CD54/74AC164, CD54/74ACT164

DC Electrical Specifications (Continued)

PARAMETER	SYMBOL	TEST CONDITIONS		V _{CC} (V)	25°C		-40°C TO 85°C		-55°C TO 125°C		UNITS
		V _I (V)	I _O (mA)		MIN	MAX	MIN	MAX	MIN	MAX	
Low Level Output Voltage	V _{OL}	V _{IH} or V _{IL}	0.05	1.5	-	0.1	-	0.1	-	0.1	V
			0.05	3	-	0.1	-	0.1	-	0.1	V
			0.05	4.5	-	0.1	-	0.1	-	0.1	V
			12	3	-	0.36	-	0.44	-	0.5	V
			24	4.5	-	0.36	-	0.44	-	0.5	V
			75 (Note 6, 7)	5.5	-	-	-	1.65	-	-	V
			50 (Note 6, 7)	5.5	-	-	-	-	-	1.65	V
Input Leakage Current	I _I	V _{CC} or GND	-	5.5	-	±0.1	-	±1	-	±1	μA
Quiescent Supply Current MSI	I _{CC}	V _{CC} or GND	0	5.5	-	8	-	80	-	160	μA
ACT TYPES											
High Level Input Voltage	V _{IH}	-	-	4.5 to 5.5	2	-	2	-	2	-	V
Low Level Input Voltage	V _{IL}	-	-	4.5 to 5.5	-	0.8	-	0.8	-	0.8	V
High Level Output Voltage	V _{OH}	V _{IH} or V _{IL}	-0.05	4.5	4.4	-	4.4	-	4.4	-	V
			-24	4.5	3.94	-	3.8	-	3.7	-	V
			-75 (Note 6, 7)	5.5	-	-	3.85	-	-	-	V
			-50 (Note 6, 7)	5.5	-	-	-	-	3.85	-	V
Low Level Output Voltage	V _{OL}	V _{IH} or V _{IL}	0.05	4.5	-	0.1	-	0.1	-	0.1	V
			24	4.5	-	0.36	-	0.44	-	0.5	V
			75 (Note 6, 7)	5.5	-	-	-	1.65	-	-	V
			50 (Note 6, 7)	5.5	-	-	-	-	-	1.65	V
Input Leakage Current	I _I	V _{CC} or GND	-	5.5	-	±0.1	-	±1	-	±1	μA
Quiescent Supply Current MSI	I _{CC}	V _{CC} or GND	0	5.5	-	8	-	80	-	160	μA
Additional Supply Current per Input Pin TTL Inputs High 1 Unit Load	ΔI _{CC}	V _{CC} -2.1	-	4.5 to 5.5	-	2.4	-	2.8	-	3	mA

NOTES:

- Test one output at a time for a 1-second maximum duration. Measurement is made by forcing current and measuring voltage to minimize power dissipation.
- Test verifies a minimum 50Ω transmission-line-drive capability at 85°C, 75Ω at 125°C.

ACT Input Load Table

INPUT	UNIT LOAD
DS1, DS2	0.5
MR	0.74
CP	0.71

NOTE: Unit load is ΔI_{CC} limit specified in DC Electrical Specifications Table, e.g., 2.4mA max at 25°C.

CD54/74AC164, CD54/74ACT164

Prerequisite For Switching Function

PARAMETER	SYMBOL	V _{CC} (V)	-40°C TO 85°C		-55°C TO 125°C		UNITS
			MIN	MAX	MIN	MAX	
AC TYPES							
Max. Clock Frequency	f _{MAX}	1.5	7	-	6	-	MHz
		3.3 (Note 9)	62	-	54	-	MHz
		5 (Note 10)	86	-	75	-	MHz
MR Pulse Width	t _W	1.5	49	-	56	-	ns
		3.3	5.5	-	6.3	-	ns
		5	3.9	-	4.5	-	ns
CP Pulse Width	t _W	1.5	73	-	84	-	ns
		3.3	8.2	-	9.4	-	ns
		5	5.9	-	6.7	-	ns
Set-up Time	t _{SU}	1.5	27	-	31	-	ns
		3.3	3.1	-	3.5	-	ns
		5	2.2	-	2.5	-	ns
Hold Time	t _H	1.5	27	-	31	-	ns
		3.3	3.1	-	3.5	-	ns
		5	2.2	-	2.5	-	ns
MR to CP Removal Time	t _{REM}	1.5	1	-	1	-	ns
		3.3	1	-	1	-	ns
		5	1	-	1	-	ns
ACT TYPES							
Max. Clock Frequency	f _{MAX}	5 (Note 10)	80	-	70	-	MHz
MR Pulse Width	t _W	5	3.9	-	4.5	-	ns
CP Pulse Width	t _W	5	6.2	-	7.1	-	ns
Set-up Time	t _{SU}	5	2.2	-	2.5	-	ns
Hold Time	t _H	5	2.6	-	3	-	ns
MR to CP Removal Time	t _{REM}	5	0	-	0	-	ns

Switching Specifications Input t_r, t_f = 3ns, C_L = 50pF (Worst Case)

PARAMETER	SYMBOL	V _{CC} (V)	-40°C TO 85°C			-55°C TO 125°C			UNITS
			MIN	TYP	MAX	MIN	TYP	MAX	
AC TYPES									
Propagation Delay, CP to Qn	t _{PLH} , t _{PHL}	1.5	-	-	143	-	-	157	ns
		3.3 (Note 9)	4.5	-	15.9	4.4	-	17.5	ns
		5 (Note 10)	3.2	-	11.4	3.1	-	12.5	ns

CD54/74AC164, CD54/74ACT164

Switching Specifications Input $t_r, t_f = 3\text{ns}$, $C_L = 50\text{pF}$ (Worst Case) (Continued)

PARAMETER	SYMBOL	V_{CC} (V)	-40°C TO 85°C			-55°C TO 125°C			UNITS
			MIN	TYP	MAX	MIN	TYP	MAX	
Propagation Delay, $\overline{\text{MR}}$ to Q_n	t_{PLH}, t_{PHL}	1.5	-	-	158	-	-	174	ns
		3.3	5	-	17.7	4.9	-	19.5	ns
		5	3.6	-	12.6	3.5	-	13.9	ns
Input Capacitance	C_I	-	-	-	10	-	-	10	pF
Power Dissipation Capacitance	C_{PD} (Note 11)	-	-	150	-	-	150	-	pF
ACT TYPES									
Propagation Delay, CP to Q_n	t_{PLH}, t_{PHL}	5 (Note 10)	3.8	-	13.5	3.7	-	14.9	ns
Propagation Delay, $\overline{\text{MR}}$ to Q_n	t_{PLH}, t_{PHL}	5	4.1	-	14.4	4	-	15.8	ns
Input Capacitance	C_I	-	-	-	10	-	-	10	pF
Power Dissipation Capacitance	C_{PD} (Note 11)	-	-	150	-	-	150	-	pF

NOTES:

8. Limits tested at 100%.
9. 3.3V Min at 3.6V, Max at 3V.
10. 5V Min at 5.5V, Max at 4.5V.
11. C_{PD} is used to determine the dynamic power consumption per device.
 $P_D = C_{PD}V_{CC}^2 f_i \Sigma (C_L V_{CC}^2 f_o) + V_{CC} \Delta I_{CC}$, where f_i = input frequency, f_o = output frequency, C_L = output load capacitance, V_{CC} = supply voltage.

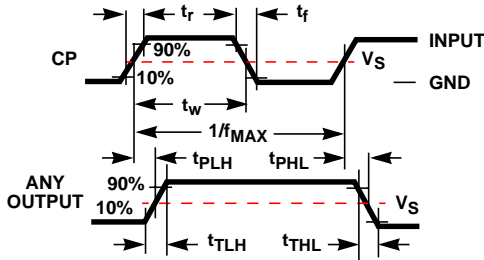

FIGURE 1.

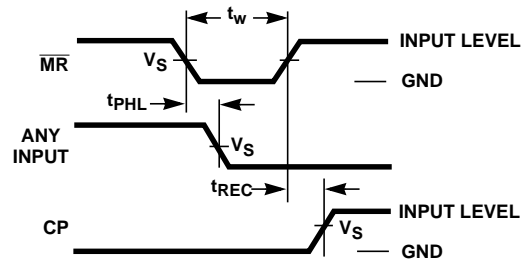

FIGURE 2.

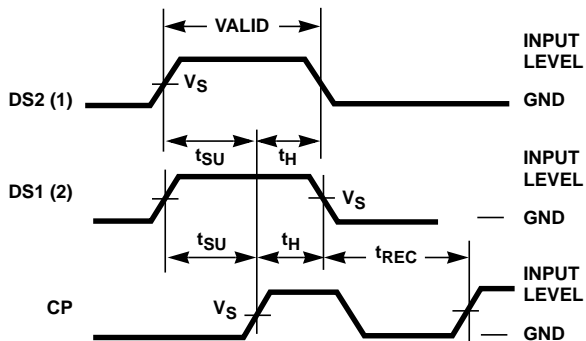

FIGURE 3.

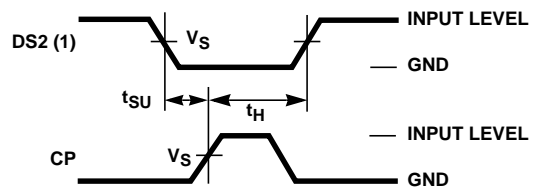
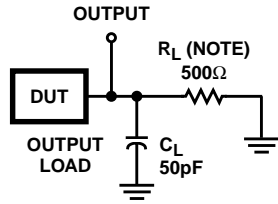

FIGURE 4.

CD54/74AC164, CD54/74ACT164



NOTE: For AC Series Only: When $V_{CC} = 1.5V$, $R_L = 1k\Omega$.

	AC	ACT
Input Level	V_{CC}	3V
Input Switching Voltage, V_S	$0.5 V_{CC}$	1.5V
Output Switching Voltage, V_S	$0.5 V_{CC}$	$0.5 V_{CC}$

FIGURE 5. PROPAGATION DELAY TIMES

PACKAGING INFORMATION

Orderable Device	Status (1)	Package Type	Package Drawing	Pins	Package Qty	Eco Plan (2)	Lead/Ball Finish (6)	MSL Peak Temp (3)	Op Temp (°C)	Device Marking (4/5)	Samples
CD54AC164F3A	ACTIVE	CDIP	J	14	1	TBD	A42	N / A for Pkg Type	-55 to 125	CD54AC164F3A	Samples
CD54ACT164F3A	ACTIVE	CDIP	J	14	1	TBD	A42	N / A for Pkg Type	-55 to 125	CD54ACT164F3A	Samples
CD74AC164E	ACTIVE	PDIP	N	14	25	Green (RoHS & no Sb/Br)	CU NIPDAU	N / A for Pkg Type	-55 to 125	CD74AC164E	Samples
CD74AC164M	ACTIVE	SOIC	D	14	50	Green (RoHS & no Sb/Br)	CU NIPDAU	Level-1-260C-UNLIM	-55 to 125	AC164M	Samples
CD74AC164M96	ACTIVE	SOIC	D	14	2500	Green (RoHS & no Sb/Br)	CU NIPDAU	Level-1-260C-UNLIM	-55 to 125	AC164M	Samples
CD74AC164ME4	ACTIVE	SOIC	D	14	50	Green (RoHS & no Sb/Br)	CU NIPDAU	Level-1-260C-UNLIM	-55 to 125	AC164M	Samples
CD74ACT164E	ACTIVE	PDIP	N	14	25	Green (RoHS & no Sb/Br)	CU NIPDAU	N / A for Pkg Type	-55 to 125	CD74ACT164E	Samples
CD74ACT164EE4	ACTIVE	PDIP	N	14	25	Green (RoHS & no Sb/Br)	CU NIPDAU	N / A for Pkg Type	-55 to 125	CD74ACT164E	Samples
CD74ACT164M	ACTIVE	SOIC	D	14	50	Green (RoHS & no Sb/Br)	CU NIPDAU	Level-1-260C-UNLIM	-55 to 125	ACT164M	Samples
CD74ACT164M96	ACTIVE	SOIC	D	14	2500	Green (RoHS & no Sb/Br)	CU NIPDAU	Level-1-260C-UNLIM	-55 to 125	ACT164M	Samples
CD74ACT164M96G4	ACTIVE	SOIC	D	14	2500	Green (RoHS & no Sb/Br)	CU NIPDAU	Level-1-260C-UNLIM	-55 to 125	ACT164M	Samples

(1) The marketing status values are defined as follows:

ACTIVE: Product device recommended for new designs.

LIFEBUY: TI has announced that the device will be discontinued, and a lifetime-buy period is in effect.

NRND: Not recommended for new designs. Device is in production to support existing customers, but TI does not recommend using this part in a new design.

PREVIEW: Device has been announced but is not in production. Samples may or may not be available.

OBSOLETE: TI has discontinued the production of the device.

(2) **RoHS:** TI defines "RoHS" to mean semiconductor products that are compliant with the current EU RoHS requirements for all 10 RoHS substances, including the requirement that RoHS substance do not exceed 0.1% by weight in homogeneous materials. Where designed to be soldered at high temperatures, "RoHS" products are suitable for use in specified lead-free processes. TI may reference these types of products as "Pb-Free".

RoHS Exempt: TI defines "RoHS Exempt" to mean products that contain lead but are compliant with EU RoHS pursuant to a specific EU RoHS exemption.

Green: TI defines "Green" to mean the content of Chlorine (Cl) and Bromine (Br) based flame retardants meet JS709B low halogen requirements of <=1000ppm threshold. Antimony trioxide based flame retardants must also meet the <=1000ppm threshold requirement.

- (3) MSL, Peak Temp. - The Moisture Sensitivity Level rating according to the JEDEC industry standard classifications, and peak solder temperature.
- (4) There may be additional marking, which relates to the logo, the lot trace code information, or the environmental category on the device.
- (5) Multiple Device Markings will be inside parentheses. Only one Device Marking contained in parentheses and separated by a "~" will appear on a device. If a line is indented then it is a continuation of the previous line and the two combined represent the entire Device Marking for that device.
- (6) Lead/Ball Finish - Orderable Devices may have multiple material finish options. Finish options are separated by a vertical ruled line. Lead/Ball Finish values may wrap to two lines if the finish value exceeds the maximum column width.

Important Information and Disclaimer:The information provided on this page represents TI's knowledge and belief as of the date that it is provided. TI bases its knowledge and belief on information provided by third parties, and makes no representation or warranty as to the accuracy of such information. Efforts are underway to better integrate information from third parties. TI has taken and continues to take reasonable steps to provide representative and accurate information but may not have conducted destructive testing or chemical analysis on incoming materials and chemicals. TI and TI suppliers consider certain information to be proprietary, and thus CAS numbers and other limited information may not be available for release.

In no event shall TI's liability arising out of such information exceed the total purchase price of the TI part(s) at issue in this document sold by TI to Customer on an annual basis.

OTHER QUALIFIED VERSIONS OF CD54AC164, CD54ACT164, CD74AC164, CD74ACT164 :

- Catalog: [CD74AC164](#), [CD74ACT164](#)
- Military: [CD54AC164](#), [CD54ACT164](#)

NOTE: Qualified Version Definitions:

- Catalog - TI's standard catalog product
- Military - QML certified for Military and Defense Applications

TAPE AND REEL INFORMATION

REEL DIMENSIONS



TAPE DIMENSIONS



A0	Dimension designed to accommodate the component width
B0	Dimension designed to accommodate the component length
K0	Dimension designed to accommodate the component thickness
W	Overall width of the carrier tape
P1	Pitch between successive cavity centers

TAPE AND REEL INFORMATION

*All dimensions are nominal

Device	Package Type	Package Drawing	Pins	SPQ	Reel Diameter (mm)	Reel Width W1 (mm)	A0 (mm)	B0 (mm)	K0 (mm)	P1 (mm)	W (mm)	Pin1 Quadrant
CD74AC164M96	SOIC	D	14	2500	330.0	16.4	6.5	9.0	2.1	8.0	16.0	Q1
CD74ACT164M96	SOIC	D	14	2500	330.0	16.4	6.5	9.0	2.1	8.0	16.0	Q1

TAPE AND REEL BOX DIMENSIONS

*All dimensions are nominal

Device	Package Type	Package Drawing	Pins	SPQ	Length (mm)	Width (mm)	Height (mm)
CD74AC164M96	SOIC	D	14	2500	367.0	367.0	38.0
CD74ACT164M96	SOIC	D	14	2500	367.0	367.0	38.0

J 14

GENERIC PACKAGE VIEW
CDIP - 5.08 mm max height
CERAMIC DUAL IN LINE PACKAGE



Images above are just a representation of the package family, actual package may vary.
Refer to the product data sheet for package details.

4040083-5/G

J0014A



PACKAGE OUTLINE

CDIP - 5.08 mm max height

CERAMIC DUAL IN LINE PACKAGE



4214771/A 05/2017

NOTES:

1. All controlling linear dimensions are in inches. Dimensions in brackets are in millimeters. Any dimension in brackets or parenthesis are for reference only. Dimensioning and tolerancing per ASME Y14.5M.
2. This drawing is subject to change without notice.
3. This package is hermetically sealed with a ceramic lid using glass frit.
4. Index point is provided on cap for terminal identification only and on press ceramic glass frit seal only.
5. Falls within MIL-STD-1835 and GDIP1-T14.

EXAMPLE BOARD LAYOUT

J0014A

CDIP - 5.08 mm max height

CERAMIC DUAL IN LINE PACKAGE



LAND PATTERN EXAMPLE
NON-SOLDER MASK DEFINED
SCALE: 5X



4214771/A 05/2017

D (R-PDSO-G14)

PLASTIC SMALL OUTLINE



- NOTES:
- A. All linear dimensions are in inches (millimeters).
 - B. This drawing is subject to change without notice.
 - Body length does not include mold flash, protrusions, or gate burrs. Mold flash, protrusions, or gate burrs shall not exceed 0.006 (0,15) each side.
 - Body width does not include interlead flash. Interlead flash shall not exceed 0.017 (0,43) each side.
 - E. Reference JEDEC MS-012 variation AB.

D (R-PDSO-G14)

PLASTIC SMALL OUTLINE



4211283-3/E 08/12

- NOTES:
- A. All linear dimensions are in millimeters.
 - B. This drawing is subject to change without notice.
 - C. Publication IPC-7351 is recommended for alternate designs.
 - D. Laser cutting apertures with trapezoidal walls and also rounding corners will offer better paste release. Customers should contact their board assembly site for stencil design recommendations. Refer to IPC-7525 for other stencil recommendations.
 - E. Customers should contact their board fabrication site for solder mask tolerances between and around signal pads.

N (R-PDIP-T**)

PLASTIC DUAL-IN-LINE PACKAGE

16 PINS SHOWN



4040049/E 12/2002

- NOTES: A. All linear dimensions are in inches (millimeters).
 B. This drawing is subject to change without notice.
 (C) Falls within JEDEC MS-001, except 18 and 20 pin minimum body length (Dim A).
 (D) The 20 pin end lead shoulder width is a vendor option, either half or full width.

IMPORTANT NOTICE

Texas Instruments Incorporated (TI) reserves the right to make corrections, enhancements, improvements and other changes to its semiconductor products and services per JESD46, latest issue, and to discontinue any product or service per JESD48, latest issue. Buyers should obtain the latest relevant information before placing orders and should verify that such information is current and complete.

TI's published terms of sale for semiconductor products (<http://www.ti.com/sc/docs/stdterms.htm>) apply to the sale of packaged integrated circuit products that TI has qualified and released to market. Additional terms may apply to the use or sale of other types of TI products and services.

Reproduction of significant portions of TI information in TI data sheets is permissible only if reproduction is without alteration and is accompanied by all associated warranties, conditions, limitations, and notices. TI is not responsible or liable for such reproduced documentation. Information of third parties may be subject to additional restrictions. Resale of TI products or services with statements different from or beyond the parameters stated by TI for that product or service voids all express and any implied warranties for the associated TI product or service and is an unfair and deceptive business practice. TI is not responsible or liable for any such statements.

Buyers and others who are developing systems that incorporate TI products (collectively, "Designers") understand and agree that Designers remain responsible for using their independent analysis, evaluation and judgment in designing their applications and that Designers have full and exclusive responsibility to assure the safety of Designers' applications and compliance of their applications (and of all TI products used in or for Designers' applications) with all applicable regulations, laws and other applicable requirements. Designer represents that, with respect to their applications, Designer has all the necessary expertise to create and implement safeguards that (1) anticipate dangerous consequences of failures, (2) monitor failures and their consequences, and (3) lessen the likelihood of failures that might cause harm and take appropriate actions. Designer agrees that prior to using or distributing any applications that include TI products, Designer will thoroughly test such applications and the functionality of such TI products as used in such applications.

TI's provision of technical, application or other design advice, quality characterization, reliability data or other services or information, including, but not limited to, reference designs and materials relating to evaluation modules, (collectively, "TI Resources") are intended to assist designers who are developing applications that incorporate TI products; by downloading, accessing or using TI Resources in any way, Designer (individually or, if Designer is acting on behalf of a company, Designer's company) agrees to use any particular TI Resource solely for this purpose and subject to the terms of this Notice.

TI's provision of TI Resources does not expand or otherwise alter TI's applicable published warranties or warranty disclaimers for TI products, and no additional obligations or liabilities arise from TI providing such TI Resources. TI reserves the right to make corrections, enhancements, improvements and other changes to its TI Resources. TI has not conducted any testing other than that specifically described in the published documentation for a particular TI Resource.

Designer is authorized to use, copy and modify any individual TI Resource only in connection with the development of applications that include the TI product(s) identified in such TI Resource. NO OTHER LICENSE, EXPRESS OR IMPLIED, BY ESTOPPEL OR OTHERWISE TO ANY OTHER TI INTELLECTUAL PROPERTY RIGHT, AND NO LICENSE TO ANY TECHNOLOGY OR INTELLECTUAL PROPERTY RIGHT OF TI OR ANY THIRD PARTY IS GRANTED HEREIN, including but not limited to any patent right, copyright, mask work right, or other intellectual property right relating to any combination, machine, or process in which TI products or services are used. Information regarding or referencing third-party products or services does not constitute a license to use such products or services, or a warranty or endorsement thereof. Use of TI Resources may require a license from a third party under the patents or other intellectual property of the third party, or a license from TI under the patents or other intellectual property of TI.

TI RESOURCES ARE PROVIDED "AS IS" AND WITH ALL FAULTS. TI DISCLAIMS ALL OTHER WARRANTIES OR REPRESENTATIONS, EXPRESS OR IMPLIED, REGARDING RESOURCES OR USE THEREOF, INCLUDING BUT NOT LIMITED TO ACCURACY OR COMPLETENESS, TITLE, ANY EPIDEMIC FAILURE WARRANTY AND ANY IMPLIED WARRANTIES OF MERCHANTABILITY, FITNESS FOR A PARTICULAR PURPOSE, AND NON-INFRINGEMENT OF ANY THIRD PARTY INTELLECTUAL PROPERTY RIGHTS. TI SHALL NOT BE LIABLE FOR AND SHALL NOT DEFEND OR INDEMNIFY DESIGNER AGAINST ANY CLAIM, INCLUDING BUT NOT LIMITED TO ANY INFRINGEMENT CLAIM THAT RELATES TO OR IS BASED ON ANY COMBINATION OF PRODUCTS EVEN IF DESCRIBED IN TI RESOURCES OR OTHERWISE. IN NO EVENT SHALL TI BE LIABLE FOR ANY ACTUAL, DIRECT, SPECIAL, COLLATERAL, INDIRECT, PUNITIVE, INCIDENTAL, CONSEQUENTIAL OR EXEMPLARY DAMAGES IN CONNECTION WITH OR ARISING OUT OF TI RESOURCES OR USE THEREOF, AND REGARDLESS OF WHETHER TI HAS BEEN ADVISED OF THE POSSIBILITY OF SUCH DAMAGES.

Unless TI has explicitly designated an individual product as meeting the requirements of a particular industry standard (e.g., ISO/TS 16949 and ISO 26262), TI is not responsible for any failure to meet such industry standard requirements.

Where TI specifically promotes products as facilitating functional safety or as compliant with industry functional safety standards, such products are intended to help enable customers to design and create their own applications that meet applicable functional safety standards and requirements. Using products in an application does not by itself establish any safety features in the application. Designers must ensure compliance with safety-related requirements and standards applicable to their applications. Designer may not use any TI products in life-critical medical equipment unless authorized officers of the parties have executed a special contract specifically governing such use. Life-critical medical equipment is medical equipment where failure of such equipment would cause serious bodily injury or death (e.g., life support, pacemakers, defibrillators, heart pumps, neurostimulators, and implantables). Such equipment includes, without limitation, all medical devices identified by the U.S. Food and Drug Administration as Class III devices and equivalent classifications outside the U.S.

TI may expressly designate certain products as completing a particular qualification (e.g., Q100, Military Grade, or Enhanced Product). Designers agree that it has the necessary expertise to select the product with the appropriate qualification designation for their applications and that proper product selection is at Designers' own risk. Designers are solely responsible for compliance with all legal and regulatory requirements in connection with such selection.

Designer will fully indemnify TI and its representatives against any damages, costs, losses, and/or liabilities arising out of Designer's non-compliance with the terms and provisions of this Notice.