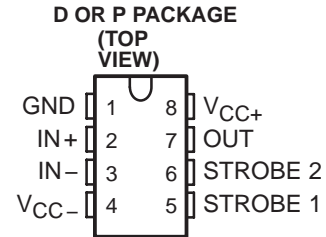


# LM306 DIFFERENTIAL COMPARATOR WITH STROBES

SLCS008A – OCTOBER 1979 – REVISED OCTOBER 1991

- Fast Response Times
- Improved Gain and Accuracy
- Fanout to 10 Series 54/74 TTL Loads
- Strobe Capability
- Short-Circuit and Surge Protection
- Designed to Be Interchangeable With National Semiconductor LM306



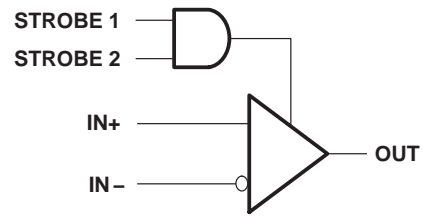
## description

The LM306 is a high-speed voltage comparator with differential inputs, a low-impedance high-sink-current (100 mA) output, and two strobe inputs. This device detects low-level analog or digital signals and can drive digital logic or lamps and relays directly. Short-circuit protection and surge-current limiting is provided.

A low-level input at either strobe causes the output to remain high regardless of the differential input. When both strobe inputs are either open or at a high logic level, the output voltage is controlled by the differential input voltage. The circuit will operate with any negative supply voltage between  $-3\text{ V}$  and  $-12\text{ V}$  with little difference in performance.

The LM306 is characterized for operation from  $0^{\circ}\text{C}$  to  $70^{\circ}\text{C}$ .

## functional block diagram



## AVAILABLE OPTIONS

$T_A$	$V_{IO\max}$ at $25^{\circ}\text{C}$	PACKAGE	
		SMALL OUTLINE (D)	PLASTIC DIP (P)
$0^{\circ}\text{C}$ to $70^{\circ}\text{C}$	5 mV	LM306D	LM306P

PRODUCTION DATA information is current as of publication date. Products conform to specifications per the terms of Texas Instruments standard warranty. Production processing does not necessarily include testing of all parameters.



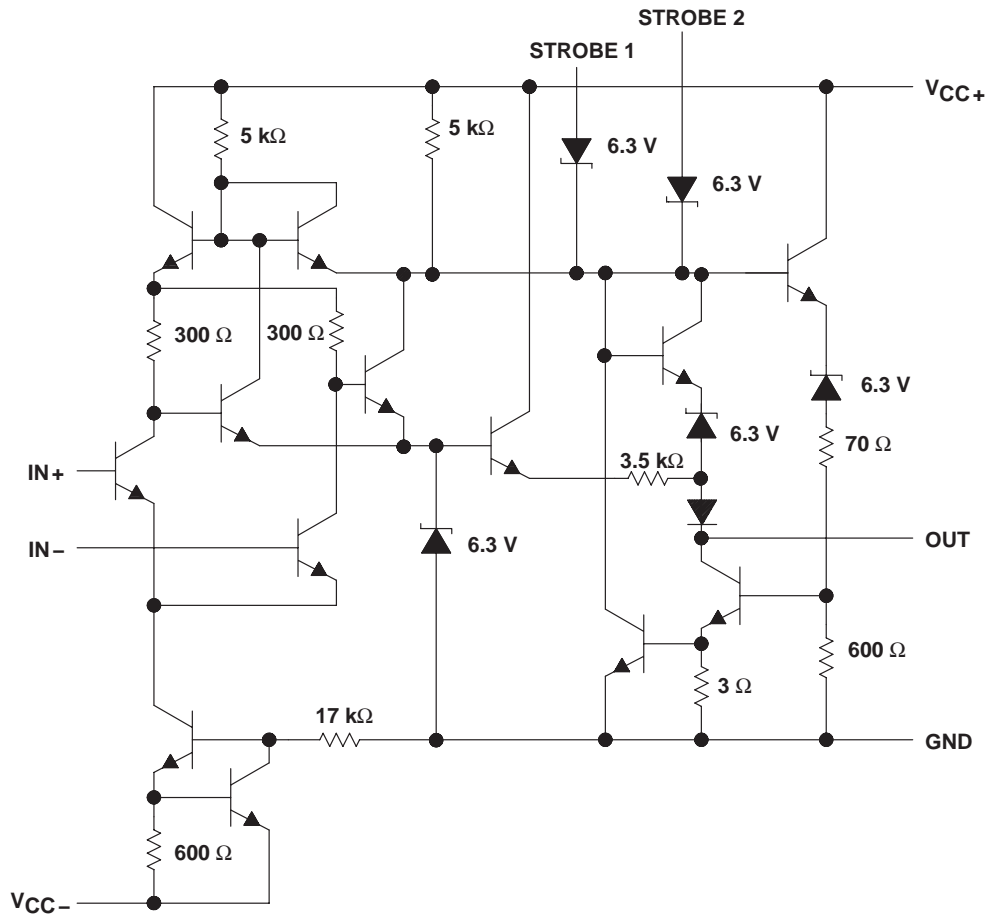
POST OFFICE BOX 655303 • DALLAS, TEXAS 75265  
POST OFFICE BOX 1443 • HOUSTON, TEXAS 77251-1443

Copyright © 1991, Texas Instruments Incorporated

# LM306 DIFFERENTIAL COMPARATOR WITH STROBES

SLCS008A – OCTOBER 1979 – REVISED OCTOBER 1991

## schematic



Resistor values are nominal.

# LM306 DIFFERENTIAL COMPARATOR WITH STROBES

SLCS008A – OCTOBER 1979 – REVISED OCTOBER 1991

## absolute maximum ratings over operating free-air temperature range (unless otherwise noted)†

Supply voltage, $V_{CC+}$ (see Note 1) .....	15 V
Supply voltage, $V_{CC-}$ (see Note 1) .....	-15 V
Differential input voltage, $V_{ID}$ (see Note 2) .....	$\pm 5$ V
Input voltage, $V_I$ (either input, see Notes 1 and 3) .....	$\pm 7$ V
Strobe voltage range (see Note 1) .....	0 V to $V_{CC+}$
Output voltage, $V_O$ (see Note 1) .....	24 V
Voltage from output to $V_{CC-}$ .....	30 V
Duration of output short circuit to ground (see Note 4) .....	10 s
Continuous total dissipation .....	See Dissipation Rating Table
Operating free-air temperature range, $T_A$ .....	$0^\circ\text{C}$ to $70^\circ\text{C}$
Storage temperature range .....	$-65^\circ\text{C}$ to $150^\circ\text{C}$
Lead temperature 1,6 mm (1/16 inch) from case for 10 seconds .....	$260^\circ\text{C}$

† Stresses beyond those listed under "absolute maximum ratings" may cause permanent damage to the device. These are stress ratings only, and functional operation of the device at these or any other conditions beyond those indicated under "recommended operating conditions" is not implied. Exposure to absolute-maximum-rated conditions for extended periods may affect device reliability.

- NOTES: 1. All voltage values, except differential voltages and the voltage from the output to  $V_{CC-}$ , are with respect to the network ground.  
 2. Differential voltages are at  $IN+$  with respect to  $IN-$ .  
 3. The magnitude of the input voltage must never exceed the magnitude of the supply voltage or 7 V, whichever is less.  
 4. The output may be shorted to ground or either power supply.

**DISSIPATION RATING TABLE**

PACKAGE	$T_A \leq 25^\circ\text{C}$ POWER RATING	DERATING FACTOR	DERATE ABOVE $T_A$	$T_A = 70^\circ\text{C}$ POWER RATING
D	600 mW	5.8 mW/ $^\circ\text{C}$	$46^\circ\text{C}$	464 mW
P	600 mW	8.0 mW/ $^\circ\text{C}$	$75^\circ\text{C}$	600 mW



# LM306

## DIFFERENTIAL COMPARATOR WITH STROBES

SLCS008A – OCTOBER 1979 – REVISED OCTOBER 1991

electrical characteristics at specified free-air temperature,  $V_{CC+} = 12\text{ V}$ ,  $V_{CC-} = -3\text{ V}$  to  $-12\text{ V}$  (unless otherwise noted)

PARAMETER		TEST CONDITIONS†	$T_A$ ‡	MIN	TYP	MAX	UNIT	
$V_{IO}$	Input offset voltage	$R_S \leq 200\ \Omega$	25°C		1.6§	5	mV	
			Full range			6.5		
$\alpha V_{IO}$	Average temperature coefficient of input offset voltage	$R_S = 50\ \Omega$ , See Note 5	Full range		5	20	$\mu\text{V}/^\circ\text{C}$	
$I_{IO}$	Input offset current	See Note 5	25°C		1.8	5	$\mu\text{A}$	
			MIN		1	7.5		
			MAX		0.5	5		
$\alpha I_{IO}$	Average temperature coefficient of input offset current	See Note 5	MIN to 25°C		24	100	$\text{nA}/^\circ\text{C}$	
			25°C to MAX		15	50		
$I_{IB}$	Input bias current	$V_O = 0.5\text{ V}$ to $5\text{ V}$	MIN to 25°C			40	$\mu\text{A}$	
			25°C to MAX		16	25		
$I_{IL(S)}$	Low-level strobe current	$V(\text{strobe}) = 0.4\text{ V}$	Full range		-1.7	-3.2	mA	
$V_{IH(S)}$	High-level strobe voltage		Full range	2.2			V	
$V_{IL(S)}$	Low-level strobe voltage		Full range			0.9	V	
$V_{ICR}$	Common-mode input voltage range	$V_{CC-} = -7\text{ V}$ to $-12\text{ V}$	Full range	$\pm 5$			V	
$V_{ID}$	Differential input voltage range		Full range	$\pm 5$			V	
$A_{VD}$	Large-signal differential voltage amplification	$V_O = 0.5\text{ V}$ to $5\text{ V}$ , No load	25°C		40		V/mV	
$V_{OH}$	High-level output voltage	$I_{OH} = -400\ \mu\text{A}$ $V_{ID} = 8\text{ mV}$	Full range	2.5		5.5	V	
$V_{OL}$	Low-level output voltage	$I_{OL} = 100\text{ mA}$ $V_{ID} = -7\text{ mV}$	25°C		0.8	2	V	
		$I_{OL} = 50\text{ mA}$ $V_{ID} = -7\text{ mV}$	Full range			1		
		$I_{OL} = 16\text{ mA}$ $V_{ID} = -8\text{ mV}$	Full range					0.4
$I_{OH}$	High-level output voltage	$V_{OH} = 8\text{ V}$ to $24\text{ V}$	$V_{ID} = 7\text{ mV}$	MIN to 25°C		0.02	2	$\mu\text{A}$
			$V_{ID} = 8\text{ mV}$	25°C to MAX				
$I_{CC+}$	Supply current from $V_{CC+}$	$V_{ID} = -5\text{ mV}$ , No load	Full range		6.6	10	mA	
$I_{CC-}$	Supply current from $V_{CC-}$	No load	Full range		-1.9	-3.6	mA	

† Unless otherwise noted, all characteristics are measured with both strobes open.

‡ Full range is 0°C to 70°C. MIN is 0°C. MAX is 70°C.

§ This typical value is at  $V_{CC+} = 12\text{ V}$ ,  $V_{CC-} = -6\text{ V}$ .

NOTE 5: The offset voltages and offset currents given are the maximum values required to drive the output down to the low range ( $V_{OL}$ ) or up to the high range ( $V_{OH}$ ). These parameters actually define an error band and take into account the worst-case effects of voltage gain and input impedance.

### switching characteristics, $V_{CC+} = 12\text{ V}$ , $V_{CC-} = -6\text{ V}$ , $T_A = 25^\circ\text{C}$

PARAMETER	TEST CONDITIONS†	MIN	TYP	MAX	UNIT
Response time, low-to-high-level output	$R_L = 390\ \Omega$ to $5\text{ V}$ , $C_L = 15\text{ pF}$ , See Note 6		28	40	ns

† All characteristics are measured with both strobes open.

NOTE 6: The response time specified is for a 100-mV input step with 5-mV overdrive and is the interval between the input step function and the instant when the output crosses 1.4 V.

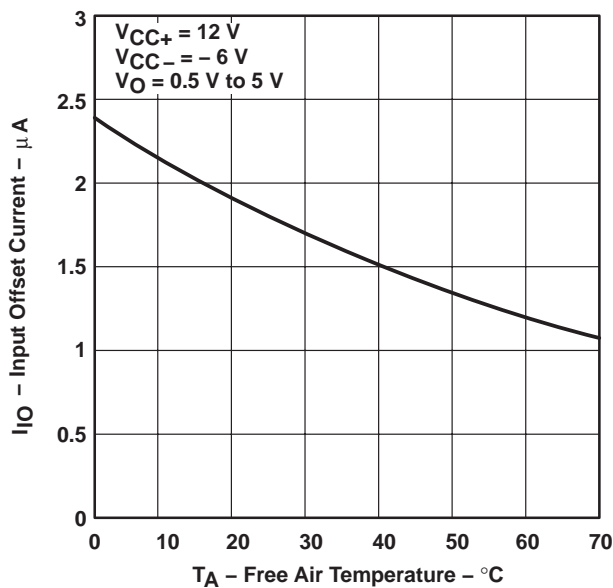


**TYPICAL CHARACTERISTICS**

**Table of Graphs**

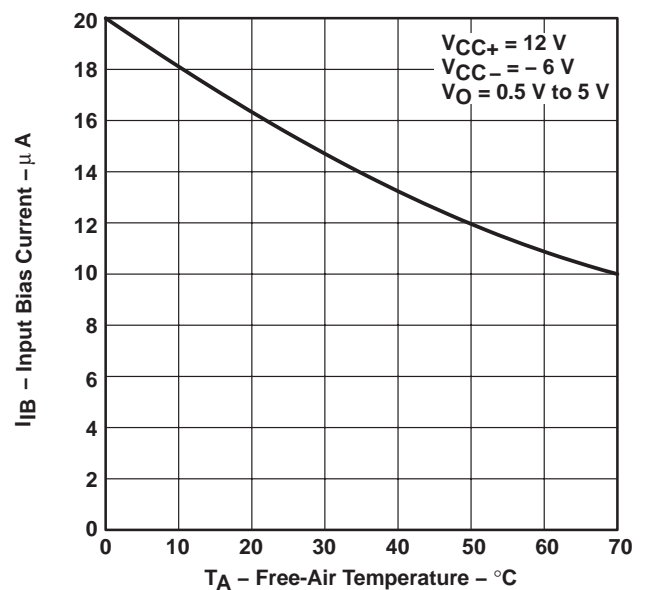
			FIGURE
$I_{IB}$	Input bias current	vs Free-air temperature	1
$I_{IO}$	Input offset current	vs Free-air temperature	2
$V_{OH}$	High-level output voltage	vs Free-air temperature	3
$V_{OL}$	Low-level output voltage	vs Free-air temperature	4
$V_O$	Output voltage	vs Differential input voltage	5
$I_O$	Output current	vs Differential input voltage	6
$A_{VD}$	Large-signal differential voltage amplification	vs Free-air temperature	7
$I_{OS}$	Short-circuit output current	vs Free-air temperature	8
	Output response	vs Time	9, 10
$I_{CC+}$	Positive supply current	vs Positive supply voltage	11
$I_{CC-}$	Negative supply current	vs Negative supply voltage	12
$P_D$	Total power dissipation	vs Free-air temperature	13

**INPUT OFFSET CURRENT  
vs  
FREE-AIR TEMPERATURE**



**Figure 1**

**INPUT BIAS CURRENT  
vs  
FREE-AIR TEMPERATURE**



**Figure 2**

# LM306 DIFFERENTIAL COMPARATOR WITH STROBES

SLCS008A – OCTOBER 1979 – REVISED OCTOBER 1991

## TYPICAL CHARACTERISTICS

HIGH-LEVEL OUTPUT VOLTAGE  
vs  
FREE-AIR TEMPERATURE

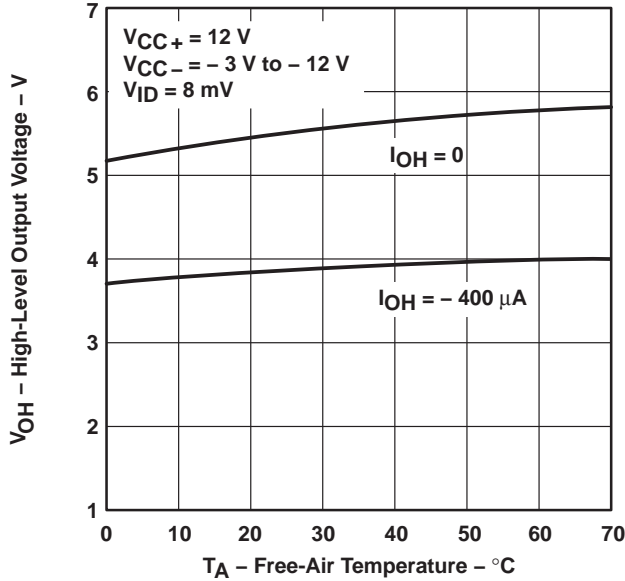


Figure 3

LOW-LEVEL OUTPUT VOLTAGE  
vs  
FREE-AIR TEMPERATURE

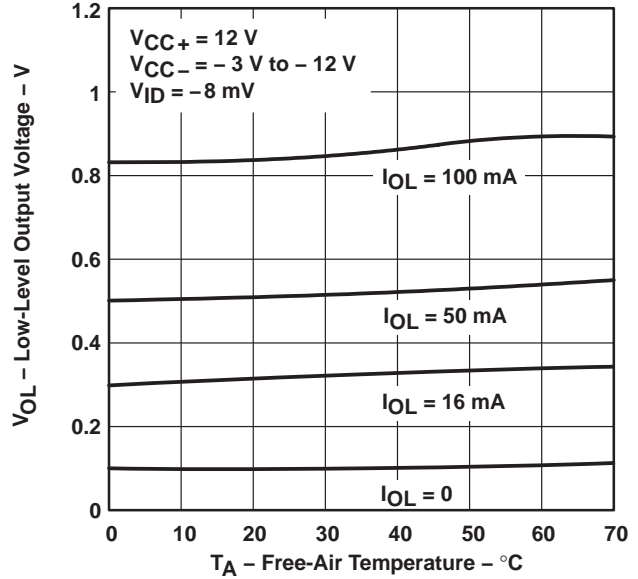


Figure 4

OUTPUT VOLTAGE  
vs  
DIFFERENTIAL INPUT VOLTAGE

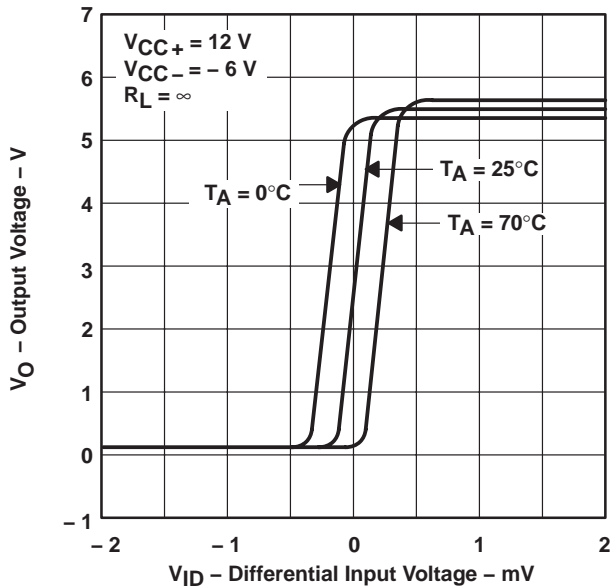


Figure 5

OUTPUT CURRENT  
vs  
DIFFERENTIAL INPUT VOLTAGE

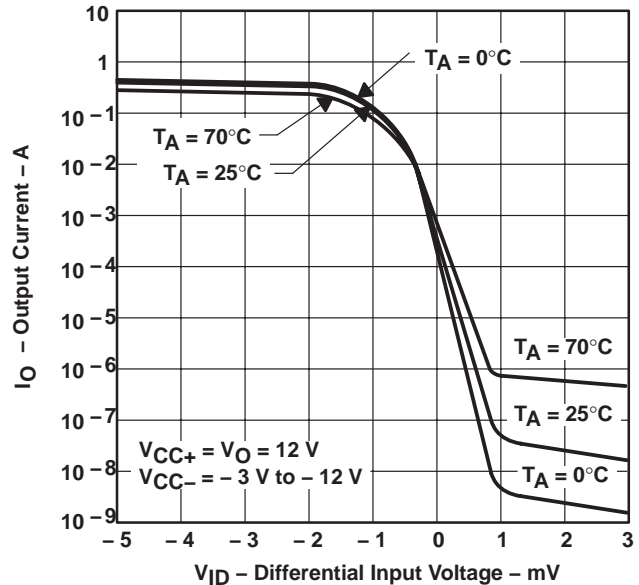
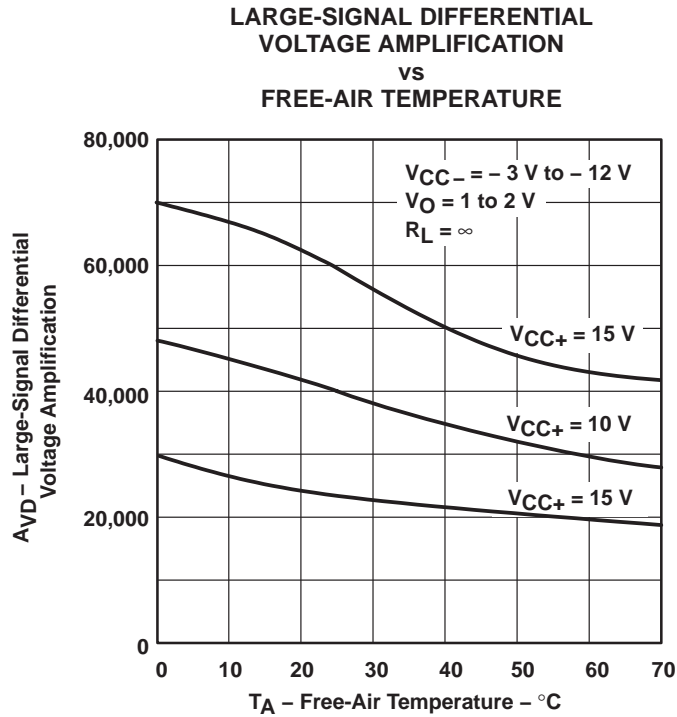


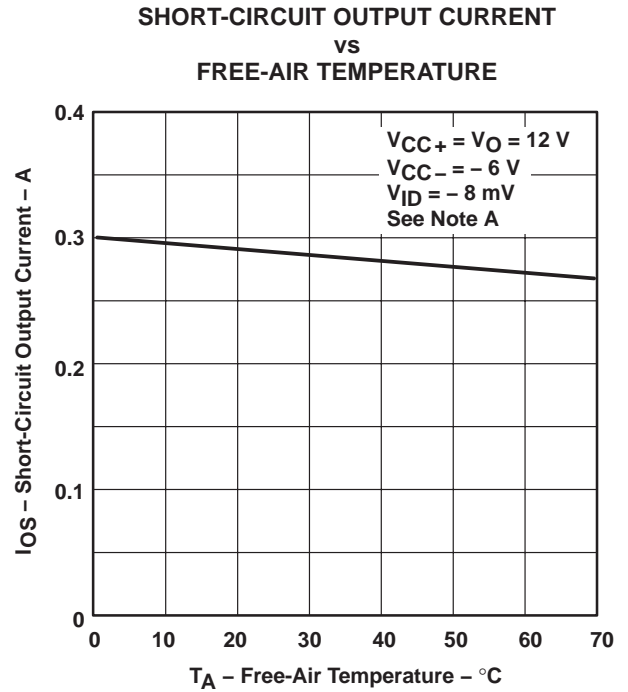
Figure 6



**TYPICAL CHARACTERISTICS**

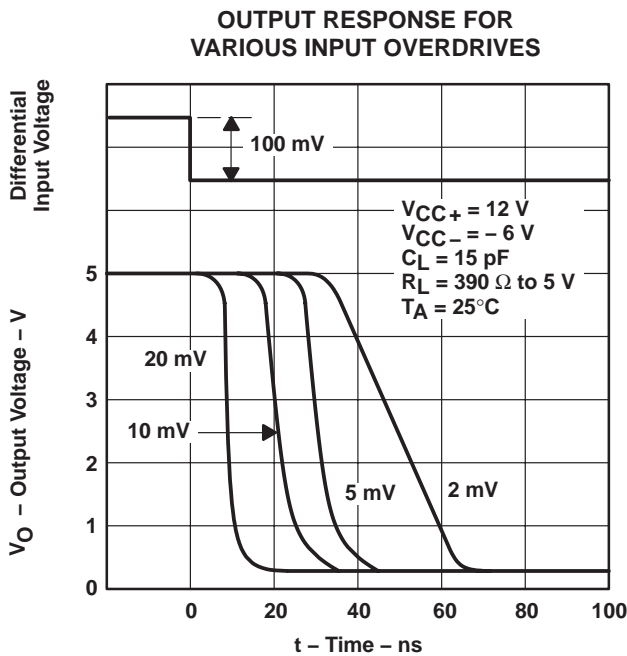


**Figure 7**

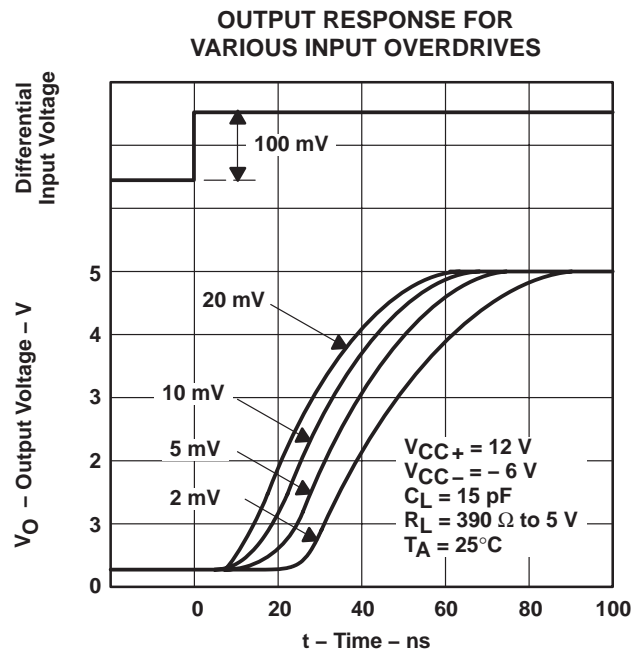


NOTE A: This parameter was measured using a single 5-ms pulse.

**Figure 8**



**Figure 9**



**Figure 10**

# LM306 DIFFERENTIAL COMPARATOR WITH STROBES

SLCS008A – OCTOBER 1979 – REVISED OCTOBER 1991

## TYPICAL CHARACTERISTICS

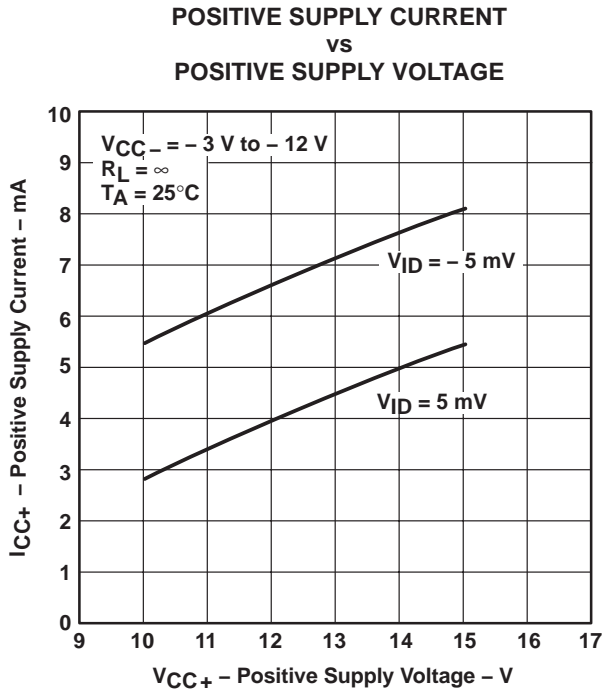


Figure 11

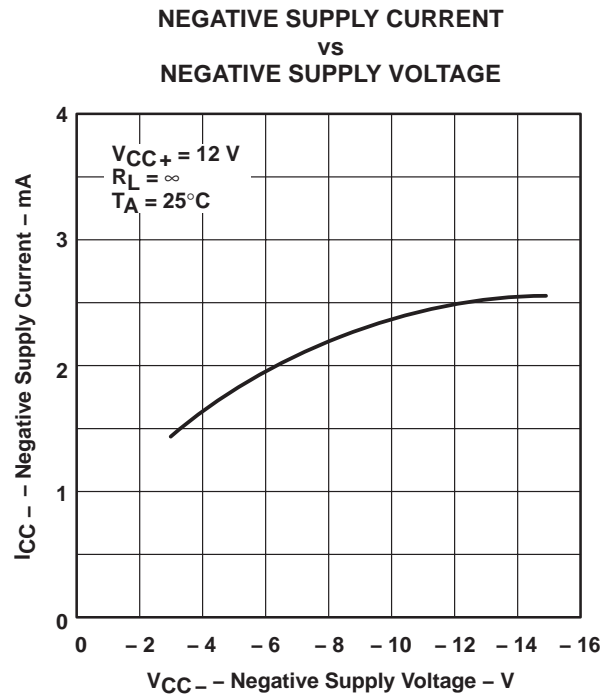


Figure 12

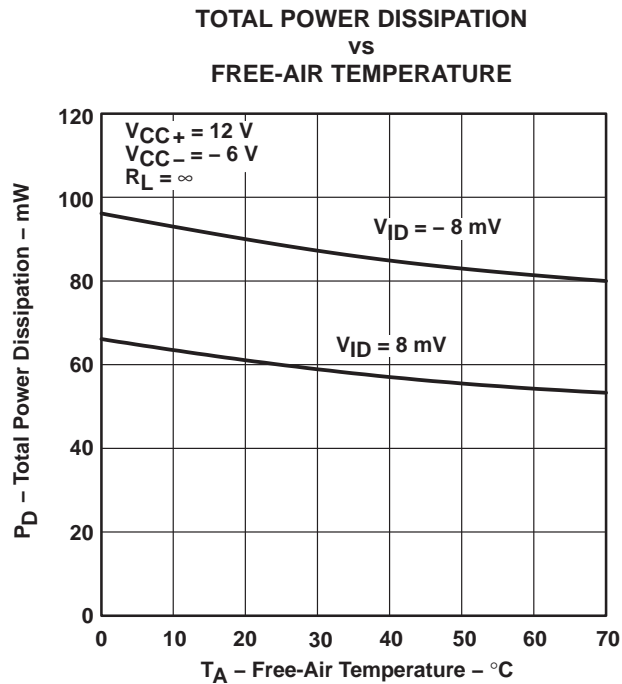


Figure 13





**PACKAGING INFORMATION**

Orderable Device	Status (1)	Package Type	Package Drawing	Pins	Package Qty	Eco Plan (2)	Lead/Ball Finish (6)	MSL Peak Temp (3)	Op Temp (°C)	Device Marking (4/5)	Samples
LM306D	ACTIVE	SOIC	D	8	75	Green (RoHS & no Sb/Br)	CU NIPDAU	Level-1-260C-UNLIM	0 to 70	LM306	<a href="#">Samples</a>
LM306P	ACTIVE	PDIP	P	8	50	Green (RoHS & no Sb/Br)	CU NIPDAU	N / A for Pkg Type	0 to 70	LM306P	<a href="#">Samples</a>

(1) The marketing status values are defined as follows:

**ACTIVE:** Product device recommended for new designs.

**LIFEBUY:** TI has announced that the device will be discontinued, and a lifetime-buy period is in effect.

**NRND:** Not recommended for new designs. Device is in production to support existing customers, but TI does not recommend using this part in a new design.

**PREVIEW:** Device has been announced but is not in production. Samples may or may not be available.

**OBsolete:** TI has discontinued the production of the device.

(2) **RoHS:** TI defines "RoHS" to mean semiconductor products that are compliant with the current EU RoHS requirements for all 10 RoHS substances, including the requirement that RoHS substance do not exceed 0.1% by weight in homogeneous materials. Where designed to be soldered at high temperatures, "RoHS" products are suitable for use in specified lead-free processes. TI may reference these types of products as "Pb-Free".

**RoHS Exempt:** TI defines "RoHS Exempt" to mean products that contain lead but are compliant with EU RoHS pursuant to a specific EU RoHS exemption.

**Green:** TI defines "Green" to mean the content of Chlorine (Cl) and Bromine (Br) based flame retardants meet JS709B low halogen requirements of <=1000ppm threshold. Antimony trioxide based flame retardants must also meet the <=1000ppm threshold requirement.

(3) MSL, Peak Temp. - The Moisture Sensitivity Level rating according to the JEDEC industry standard classifications, and peak solder temperature.

(4) There may be additional marking, which relates to the logo, the lot trace code information, or the environmental category on the device.

(5) Multiple Device Markings will be inside parentheses. Only one Device Marking contained in parentheses and separated by a "~" will appear on a device. If a line is indented then it is a continuation of the previous line and the two combined represent the entire Device Marking for that device.

(6) Lead/Ball Finish - Orderable Devices may have multiple material finish options. Finish options are separated by a vertical ruled line. Lead/Ball Finish values may wrap to two lines if the finish value exceeds the maximum column width.

**Important Information and Disclaimer:**The information provided on this page represents TI's knowledge and belief as of the date that it is provided. TI bases its knowledge and belief on information provided by third parties, and makes no representation or warranty as to the accuracy of such information. Efforts are underway to better integrate information from third parties. TI has taken and continues to take reasonable steps to provide representative and accurate information but may not have conducted destructive testing or chemical analysis on incoming materials and chemicals. TI and TI suppliers consider certain information to be proprietary, and thus CAS numbers and other limited information may not be available for release.

In no event shall TI's liability arising out of such information exceed the total purchase price of the TI part(s) at issue in this document sold by TI to Customer on an annual basis.





D0008A

# PACKAGE OUTLINE

SOIC - 1.75 mm max height

SMALL OUTLINE INTEGRATED CIRCUIT



4214825/C 02/2019

NOTES:

- Linear dimensions are in inches [millimeters]. Dimensions in parenthesis are for reference only. Controlling dimensions are in inches. Dimensioning and tolerancing per ASME Y14.5M.
- This drawing is subject to change without notice.
- This dimension does not include mold flash, protrusions, or gate burrs. Mold flash, protrusions, or gate burrs shall not exceed  $.006$  [0.15] per side.
- This dimension does not include interlead flash.
- Reference JEDEC registration MS-012, variation AA.

# EXAMPLE BOARD LAYOUT

D0008A

SOIC - 1.75 mm max height

SMALL OUTLINE INTEGRATED CIRCUIT



LAND PATTERN EXAMPLE  
EXPOSED METAL SHOWN  
SCALE:8X



SOLDER MASK DETAILS

4214825/C 02/2019

NOTES: (continued)

6. Publication IPC-7351 may have alternate designs.

7. Solder mask tolerances between and around signal pads can vary based on board fabrication site.

# EXAMPLE STENCIL DESIGN

D0008A

SOIC - 1.75 mm max height

SMALL OUTLINE INTEGRATED CIRCUIT



SOLDER PASTE EXAMPLE  
BASED ON .005 INCH [0.125 MM] THICK STENCIL  
SCALE:8X

4214825/C 02/2019

NOTES: (continued)

8. Laser cutting apertures with trapezoidal walls and rounded corners may offer better paste release. IPC-7525 may have alternate design recommendations.
9. Board assembly site may have different recommendations for stencil design.

P (R-PDIP-T8)

PLASTIC DUAL-IN-LINE PACKAGE



- NOTES:
- A. All linear dimensions are in inches (millimeters).
  - B. This drawing is subject to change without notice.
  - C. Falls within JEDEC MS-001 variation BA.

## IMPORTANT NOTICE AND DISCLAIMER

TI PROVIDES TECHNICAL AND RELIABILITY DATA (INCLUDING DATASHEETS), DESIGN RESOURCES (INCLUDING REFERENCE DESIGNS), APPLICATION OR OTHER DESIGN ADVICE, WEB TOOLS, SAFETY INFORMATION, AND OTHER RESOURCES "AS IS" AND WITH ALL FAULTS, AND DISCLAIMS ALL WARRANTIES, EXPRESS AND IMPLIED, INCLUDING WITHOUT LIMITATION ANY IMPLIED WARRANTIES OF MERCHANTABILITY, FITNESS FOR A PARTICULAR PURPOSE OR NON-INFRINGEMENT OF THIRD PARTY INTELLECTUAL PROPERTY RIGHTS.

These resources are intended for skilled developers designing with TI products. You are solely responsible for (1) selecting the appropriate TI products for your application, (2) designing, validating and testing your application, and (3) ensuring your application meets applicable standards, and any other safety, security, or other requirements. These resources are subject to change without notice. TI grants you permission to use these resources only for development of an application that uses the TI products described in the resource. Other reproduction and display of these resources is prohibited. No license is granted to any other TI intellectual property right or to any third party intellectual property right. TI disclaims responsibility for, and you will fully indemnify TI and its representatives against, any claims, damages, costs, losses, and liabilities arising out of your use of these resources.

TI's products are provided subject to TI's Terms of Sale ([www.ti.com/legal/termsofsale.html](http://www.ti.com/legal/termsofsale.html)) or other applicable terms available either on [ti.com](http://ti.com) or provided in conjunction with such TI products. TI's provision of these resources does not expand or otherwise alter TI's applicable warranties or warranty disclaimers for TI products.

Mailing Address: Texas Instruments, Post Office Box 655303, Dallas, Texas 75265  
Copyright © 2019, Texas Instruments Incorporated