

# SM73302 88 MHz, Precision, Low Noise, 1.8V CMOS Input, Decompensated Operational Amplifier

Check for Samples: [SM73302](#)

## FEATURES

- (Typical 5V Supply, Unless Otherwise Noted)
- Renewable Energy Grade
- Input Offset Voltage  $\pm 150 \mu\text{V}$  (max)
- Input Referred Voltage Noise  $5.8 \text{ nV}/\sqrt{\text{Hz}}$
- Input Bias Current  $100 \text{ fA}$
- Gain Bandwidth Product  $88 \text{ MHz}$
- Supply Voltage Range  $1.8\text{V}$  to  $5.5\text{V}$
- Supply Current  $1.15\text{mA}$
- Rail-to-Rail Output Swing
  - @  $10 \text{ k}\Omega$  Load  $25 \text{ mV}$  from Rail
  - @  $2 \text{ k}\Omega$  Load  $45 \text{ mV}$  from Rail
- $2.5\text{V}$  and  $5.0\text{V}$  Performance
- Total Harmonic Distortion  $0.04\%$  @  $1 \text{ kHz}$ ,  $600\Omega$
- Temperature Range  $-40^\circ\text{C}$  to  $125^\circ\text{C}$

## APPLICATIONS

- ADC Interface
- Photodiode Amplifiers
- Active Filters and Buffers
- Low Noise Signal Processing
- Medical Instrumentation
- Sensor Interface Applications

## Typical Application

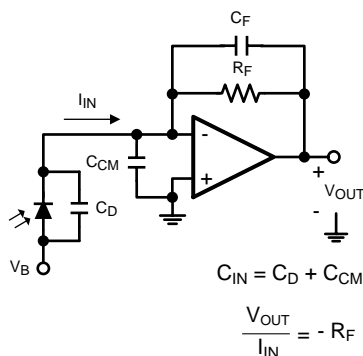
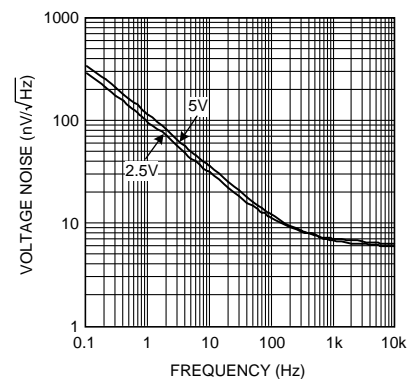

**Figure 1. Photodiode Transimpedance Amplifier**

## DESCRIPTION

The SM73302 low noise, CMOS input operational amplifier offers a low input voltage noise density of  $5.8 \text{ nV}/\sqrt{\text{Hz}}$  while consuming only  $1.15 \text{ mA}$  of quiescent current. The SM73302 is stable at a gain of 10 and has a gain bandwidth (GBW) product of  $88 \text{ MHz}$ . The SM73302 has a supply voltage range of  $1.8\text{V}$  to  $5.5\text{V}$  and can operate from a single supply. The SM73302 features a rail-to-rail output stage, and is part of the precision amplifier family and is ideal for a variety of instrumentation applications.

The SM73302 provides optimal performance in low voltage and low noise systems. A CMOS input stage, with typical input bias currents in the range of a few femtoamperes, and an input common mode voltage range, which includes ground, makes the SM73302 ideal for low power sensor applications where high speeds are needed.

The SM73302 is manufactured using an advanced VIP50 process. The SM73302 is offered in a 5-Pin SOT-23 package.

**Figure 2. Input Referred Voltage Noise vs. Frequency**

Please be aware that an important notice concerning availability, standard warranty, and use in critical applications of Texas Instruments semiconductor products and disclaimers thereto appears at the end of this data sheet.

All trademarks are the property of their respective owners.



These devices have limited built-in ESD protection. The leads should be shorted together or the device placed in conductive foam during storage or handling to prevent electrostatic damage to the MOS gates.

### Absolute Maximum Ratings<sup>(1)(2)</sup>

|   |                     |                        |
|---|---------------------|------------------------|
| ESD Tolerance <sup>(3)</sup>  | Human Body Model    | 2000V                  |
|   | Machine Model       | 200V                   |
|   | Charge-Device Model | 1000V                  |
| $V_{IN}$ Differential   |                     | ±0.3V                  |
| Supply Voltage ( $V^+ - V^-$ )  |                     | 6.0V                   |
| Input/Output Pin Voltage  |                     | $V^+ +0.3V, V^- -0.3V$ |
| Storage Temperature Range   |                     | -65°C to 150°C         |
| Junction Temperature <sup>(4)</sup>   |                     | +150°C                 |
| For soldering specifications: see <a href="http://www.ti.com/lit/SNOA549">http://www.ti.com/lit/SNOA549</a> |                     |                        |

- (1) Absolute Maximum Ratings indicate limits beyond which damage to the device may occur. Operating Ratings indicate conditions for which the device is intended to be functional. For specifications and the test conditions, see the Electrical Characteristics Tables.
- (2) If Military/Aerospace specified devices are required, please contact the Texas Instruments Sales Office/ Distributors for availability and specifications.
- (3) Human Body Model, applicable std. MIL-STD-883, Method 3015.7. Machine Model, applicable std. JESD22-A115-A (ESD MM std. of JEDEC) Field-Induced Charge-Device Model, applicable std. JESD22-C101-C (ESD FICDM std. of JEDEC).
- (4) The maximum power dissipation is a function of  $T_{J(MAX)}$ ,  $\theta_{JA}$ . The maximum allowable power dissipation at any ambient temperature is  $P_D = (T_{J(MAX)} - T_A)/\theta_{JA}$ . All numbers apply for packages soldered directly onto a PC Board.

### Operating Ratings<sup>(1)</sup>

|   |   |                |
|---|---|----------------|
| Temperature Range <sup>(2)</sup>                            |   | -40°C to 125°C |
| Supply Voltage ( $V^+ - V^-$ )                              | $-40^\circ\text{C} \leq T_A \leq 125^\circ\text{C}$ | 2.0V to 5.5V   |
|   | $0^\circ\text{C} \leq T_A \leq 125^\circ\text{C}$   | 1.8V to 5.5V   |
| Package Thermal Resistance ( $\theta_{JA}$ ) <sup>(2)</sup> | 5-Pin SOT-23  | 180°C/W        |

- (1) Absolute Maximum Ratings indicate limits beyond which damage to the device may occur. Operating Ratings indicate conditions for which the device is intended to be functional. For specifications and the test conditions, see the Electrical Characteristics Tables.
- (2) The maximum power dissipation is a function of  $T_{J(MAX)}$ ,  $\theta_{JA}$ . The maximum allowable power dissipation at any ambient temperature is  $P_D = (T_{J(MAX)} - T_A)/\theta_{JA}$ . All numbers apply for packages soldered directly onto a PC Board.

## 2.5V Electrical Characteristics<sup>(1)</sup>

Unless otherwise specified, all limits are specified for  $T_A = 25^\circ\text{C}$ ,  $V^+ = 2.5\text{V}$ ,  $V^- = 0\text{V}$ ,  $V_{\text{CM}} = V^+/2 = V_O$ . **Boldface** limits apply at the temperature extremes.

| Symbol             | Parameter  | Conditions   | Min <sup>(2)</sup>                                  | Typ <sup>(3)</sup> | Max <sup>(2)</sup>                       | Units                        |
|--------------------|--|--|---|--------------------|--|------------------------------|
| $V_{\text{OS}}$    | Input Offset Voltage                                     |  |   | $\pm 20$           | $\pm 180$<br><b><math>\pm 480</math></b> | $\mu\text{V}$                |
| TC $V_{\text{OS}}$ | Input Offset Voltage Temperature Drift <sup>(4)(5)</sup> |  |   | -1.0               | $\pm 4$                                  | $\mu\text{V}/^\circ\text{C}$ |
| $I_{\text{B}}$     | Input Bias Current                                       | $V_{\text{CM}} = 1.0\text{V}^{(6)(5)}$<br>$-40^\circ\text{C} \leq T_A \leq 85^\circ\text{C}$       |   | 0.05               | <b>1</b><br><b>25</b>                    | pA                           |
|                    |  |  | $-40^\circ\text{C} \leq T_A \leq 125^\circ\text{C}$ |                    | 0.05                                     |                              |
| $I_{\text{OS}}$    | Input Offset Current                                     | $V_{\text{CM}} = 1.0\text{V}^{(5)}$  |   | .006               | 0.5<br><b>50</b>                         | pA                           |
| CMRR               | Common Mode Rejection Ratio                              | $0\text{V} \leq V_{\text{CM}} \leq 1.4\text{V}$  | <b>83</b><br><b>80</b>                              | 94                 |  | dB                           |
| PSRR               | Power Supply Rejection Ratio                             | $2.0\text{V} \leq V^+ \leq 5.5\text{V}$ , $V_{\text{CM}} = 0\text{V}$                              | <b>85</b><br><b>80</b>                              | 100                |  | dB                           |
|                    |  | $1.8\text{V} \leq V^+ \leq 5.5\text{V}$ , $V_{\text{CM}} = 0\text{V}$                              | 85  | 98                 |  |                              |
| CMVR               | Common Mode Voltage Range                                | CMRR $\geq 60$ dB<br>CMRR $\geq 55$ dB   | -0.3<br><b>-0.3</b>                                 |                    | 1.5<br><b>1.5</b>                        | V                            |
| $A_{\text{VOL}}$   | Open Loop Voltage Gain                                   | $V_{\text{OUT}} = 0.15\text{V to } 2.2\text{V}$ ,<br>$R_{\text{L}} = 2\text{ k}\Omega$ to $V^+/2$  | <b>88</b><br><b>82</b>                              | 98                 |  | dB                           |
|                    |  | $V_{\text{OUT}} = 0.15\text{V to } 2.2\text{V}$ ,<br>$R_{\text{L}} = 10\text{ k}\Omega$ to $V^+/2$ | 92<br><b>88</b>                                     | 110                |  |                              |
| $V_{\text{OUT}}$   | Output Voltage Swing High                                | $R_{\text{L}} = 2\text{ k}\Omega$ to $V^+/2$   |   | 25                 | 70<br><b>77</b>                          | mV from either rail          |
|                    |  | $R_{\text{L}} = 10\text{ k}\Omega$ to $V^+/2$  |   | 20                 | 60<br><b>66</b>                          |                              |
|                    | Output Voltage Swing Low                                 | $R_{\text{L}} = 2\text{ k}\Omega$ to $V^+/2$   |   | 30                 | 70<br><b>73</b>                          |                              |
|                    |  | $R_{\text{L}} = 10\text{ k}\Omega$ to $V^+/2$  |   | 15                 | 60<br><b>62</b>                          |                              |
| $I_{\text{OUT}}$   | Output Current   | Sourcing to $V^-$<br>$V_{\text{IN}} = 200\text{ mV}^{(7)}$   | 36<br><b>30</b>                                     | 47                 |  | mA                           |
|                    |  | Sinking to $V^+$<br>$V_{\text{IN}} = -200\text{ mV}^{(7)}$   | 7.5<br><b>5</b>                                     | 15                 |  |                              |
| $I_{\text{S}}$     | Supply Current   |  |   | 0.95               | 1.30<br><b>1.65</b>                      | mA                           |
| SR                 | Slew Rate  | $A_{\text{V}} = +10$ , Rising (10% to 90%)   |   | 32                 |  | V/ $\mu\text{s}$             |
|                    |  | $A_{\text{V}} = +10$ , Falling (90% to 10%)  |   | 24                 |  |                              |
| GBW                | Gain Bandwidth   | $A_{\text{V}} = +10$ , $R_{\text{L}} = 10\text{ k}\Omega$  |   | 88                 |  | MHz                          |
| $e_{\text{n}}$     | Input Referred Voltage Noise Density                     | $f = 1\text{ kHz}$   |   | 6.2                |  | $\text{nV}/\sqrt{\text{Hz}}$ |
| $i_{\text{n}}$     | Input Referred Current Noise Density                     | $f = 1\text{ kHz}$   |   | 0.01               |  | $\text{pA}/\sqrt{\text{Hz}}$ |
| THD+N              | Total Harmonic Distortion + Noise                        | $f = 1\text{ kHz}$ , $A_{\text{V}} = 1$ , $R_{\text{L}} = 600\Omega$                               |   | 0.01               |  | %                            |

- (1) Electrical Table values apply only for factory testing conditions at the temperature indicated. Factory testing conditions result in very limited self-heating of the device such that  $T_{\text{J}} = T_{\text{A}}$ . No indication of parametric performance exists in the electrical tables under conditions of internal self-heating where  $T_{\text{J}} > T_{\text{A}}$ .
- (2) Limits are 100% production tested at  $25^\circ\text{C}$ . Limits over the operating temperature range are specified through correlations using the statistical quality control (SQC) method.
- (3) Typical values represent the most likely parametric norm as determined at the time of characterization. Actual typical values may vary over time and will also depend on the application and configuration. The typical values are not tested and are not specified on shipped production material.
- (4) Offset voltage average drift is determined by dividing the change in  $V_{\text{OS}}$  by temperature change.
- (5) Parameter is specified by design and/or characterization and is not test in production.
- (6) Positive current corresponds to current flowing into the device.
- (7) The short circuit test is a momentary test, the short circuit duration is 1.5 ms.

## 5V Electrical Characteristics<sup>(1)</sup>

Unless otherwise specified, all limits are specified for  $T_A = 25^\circ\text{C}$ ,  $V^+ = 5\text{V}$ ,  $V^- = 0\text{V}$ ,  $V_{\text{CM}} = V^+/2 = V_O$ . **Boldface** limits apply at the temperature extremes.

| Symbol             | Parameter  | Conditions   | Min <sup>(2)</sup>                                  | Typ <sup>(3)</sup> | Max <sup>(2)</sup>                       | Units                        |             |
|--------------------|--|--|---|--------------------|--|------------------------------|-------------|
| $V_{\text{OS}}$    | Input Offset Voltage                                     |  |   | $\pm 10$           | $\pm 150$<br><b><math>\pm 450</math></b> | $\mu\text{V}$                |             |
| TC $V_{\text{OS}}$ | Input Offset Voltage Temperature Drift <sup>(4)(5)</sup> |  |   | -1.0               | $\pm 4$                                  | $\mu\text{V}/^\circ\text{C}$ |             |
| $I_{\text{B}}$     | Input Bias Current                                       | $V_{\text{CM}} = 2.0\text{V}^{(6)(5)}$   | $-40^\circ\text{C} \leq T_A \leq 85^\circ\text{C}$  |                    | 0.1                                      | 1<br><b>25</b>               | $\text{pA}$ |
|                    |  |  | $-40^\circ\text{C} \leq T_A \leq 125^\circ\text{C}$ |                    | 0.1                                      | 1<br><b>100</b>              |             |
| $I_{\text{OS}}$    | Input Offset Current                                     | $V_{\text{CM}} = 2.0\text{V}^{(5)}$  |   | .01                | 0.5<br><b>50</b>                         | $\text{pA}$                  |             |
| CMRR               | Common Mode Rejection Ratio                              | $0\text{V} \leq V_{\text{CM}} \leq 3.7\text{V}$  | 85<br><b>80</b>                                     | 100                |  | dB                           |             |
| PSRR               | Power Supply Rejection Ratio                             | $2.0\text{V} \leq V^+ \leq 5.5\text{V}$ , $V_{\text{CM}} = 0\text{V}$                              | 85<br><b>80</b>                                     | 100                |  | dB                           |             |
|                    |  | $1.8\text{V} \leq V^+ \leq 5.5\text{V}$ , $V_{\text{CM}} = 0\text{V}$                              | 85  | 98                 |  |                              |             |
| CMVR               | Common Mode Voltage Range                                | CMRR $\geq 60$ dB<br>CMRR $\geq 55$ dB   | -0.3<br><b>-0.3</b>                                 |                    | 4<br><b>4</b>                            | V                            |             |
| $A_{\text{VOL}}$   | Open Loop Voltage Gain                                   | $V_{\text{OUT}} = 0.3\text{V}$ to $4.7\text{V}$ ,<br>$R_{\text{L}} = 2\text{ k}\Omega$ to $V^+/2$  | 88<br><b>82</b>                                     | 107                |  | dB                           |             |
|                    |  | $V_{\text{OUT}} = 0.3\text{V}$ to $4.7\text{V}$ ,<br>$R_{\text{L}} = 10\text{ k}\Omega$ to $V^+/2$ | 92<br><b>88</b>                                     | 110                |  |                              |             |
| $V_{\text{OUT}}$   | Output Voltage Swing High                                | $R_{\text{L}} = 2\text{ k}\Omega$ to $V^+/2$   |   | 35                 | 70<br><b>77</b>                          | mV from either rail          |             |
|                    |  | $R_{\text{L}} = 10\text{ k}\Omega$ to $V^+/2$  |   | 25                 | 60<br><b>66</b>                          |                              |             |
|                    | Output Voltage Swing Low                                 | $R_{\text{L}} = 2\text{ k}\Omega$ to $V^+/2$   |   | 42                 | 70<br><b>73</b>                          |                              |             |
|                    |  | $R_{\text{L}} = 10\text{ k}\Omega$ to $V^+/2$  |   | 25                 | 60<br><b>66</b>                          |                              |             |

- Electrical Table values apply only for factory testing conditions at the temperature indicated. Factory testing conditions result in very limited self-heating of the device such that  $T_{\text{J}} = T_{\text{A}}$ . No indication of parametric performance exists in the electrical tables under conditions of internal self-heating where  $T_{\text{J}} > T_{\text{A}}$ .
- Limits are 100% production tested at  $25^\circ\text{C}$ . Limits over the operating temperature range are specified through correlations using the statistical quality control (SQC) method.
- Typical values represent the most likely parametric norm as determined at the time of characterization. Actual typical values may vary over time and will also depend on the application and configuration. The typical values are not tested and are not specified on shipped production material.
- Offset voltage average drift is determined by dividing the change in  $V_{\text{OS}}$  by temperature change.
- Parameter is specified by design and/or characterization and is not test in production.
- Positive current corresponds to current flowing into the device.

### 5V Electrical Characteristics<sup>(1)</sup> (continued)

Unless otherwise specified, all limits are specified for  $T_A = 25^\circ\text{C}$ ,  $V^+ = 5\text{V}$ ,  $V^- = 0\text{V}$ ,  $V_{\text{CM}} = V^+/2 = V_O$ . **Boldface** limits apply at the temperature extremes.

| Symbol           | Parameter                            | Conditions   | Min <sup>(2)</sup> | Typ <sup>(3)</sup> | Max <sup>(2)</sup>  | Units                  |
|------------------|--------------------------------------|--|--------------------|--------------------|---------------------|------------------------|
| $I_{\text{OUT}}$ | Output Short Circuit Current         | Sourcing to $V^-$<br>$V_{\text{IN}} = 200\text{ mV}^{(7)}$ | 46<br><b>38</b>    | 60                 |                     | mA                     |
|                  |                                      | Sinking to $V^+$<br>$V_{\text{IN}} = -200\text{ mV}^{(7)}$ | 10.5<br><b>6.5</b> | 21                 |                     |                        |
| $I_S$            | Supply Current                       |  |                    | 1.15               | 1.40<br><b>1.75</b> | mA                     |
| SR               | Slew Rate                            | $A_V = +10$ , Rising (10% to 90%)                          |                    | 35                 |                     | V/ $\mu\text{s}$       |
|                  |                                      | $A_V = +10$ , Falling (90% to 10%)                         |                    | 28                 |                     |                        |
| GBW              | Gain Bandwidth                       | $A_V = +10$ , $R_L = 10\text{ k}\Omega$                    |                    | 88                 |                     | MHz                    |
| $e_n$            | Input Referred Voltage Noise Density | $f = 1\text{ kHz}$   |                    | 5.8                |                     | nV/ $\sqrt{\text{Hz}}$ |
| $i_n$            | Input Referred Current Noise Density | $f = 1\text{ kHz}$   |                    | 0.01               |                     | pA/ $\sqrt{\text{Hz}}$ |
| THD+N            | Total Harmonic Distortion + Noise    | $f = 1\text{ kHz}$ , $A_V = 1$ , $R_L = 600\Omega$         |                    | 0.01               |                     | %                      |

(7) The short circuit test is a momentary test, the short circuit duration is 1.5 ms.

#### Connection Diagram

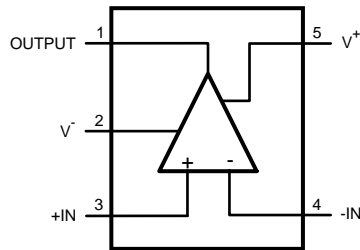

Figure 3. 5-Pin SOT-23, Top View  
See DBV Package

### Typical Performance Characteristics

Unless otherwise specified,  $T_A = 25^\circ\text{C}$ ,  $V^- = 0$ ,  $V^+ = 5\text{V}$ ,  $V_S = V^+ - V^-$ ,  $V_{CM} = V_S/2$ .

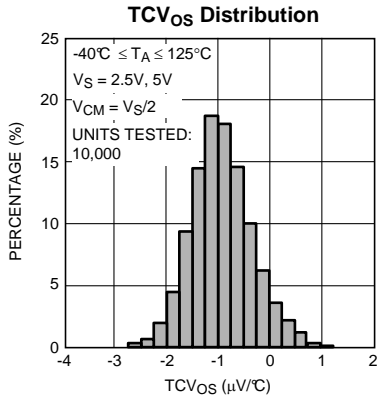

Figure 4.

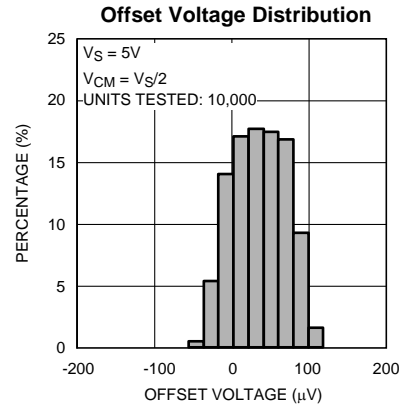

Figure 5.

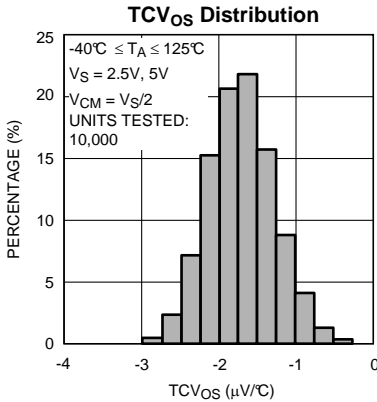

Figure 6.

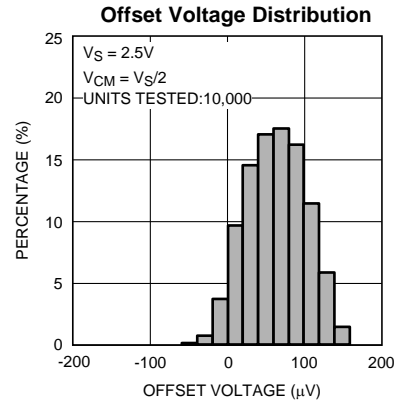

Figure 7.

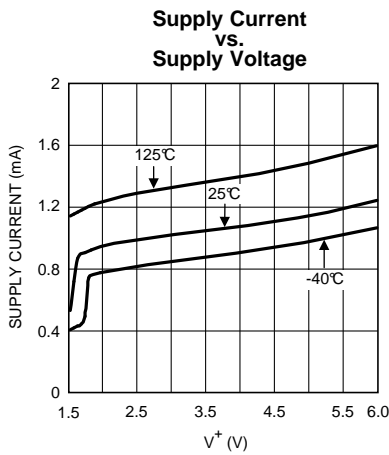

Figure 8.

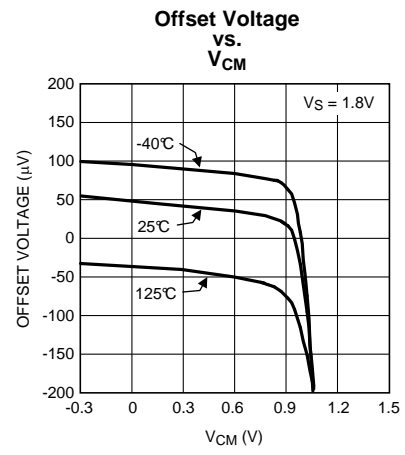

Figure 9.

**Typical Performance Characteristics (continued)**

Unless otherwise specified,  $T_A = 25^\circ\text{C}$ ,  $V^- = 0$ ,  $V^+ = 5\text{V}$ ,  $V_S = V^+ - V^-$ ,  $V_{CM} = V_S/2$ .

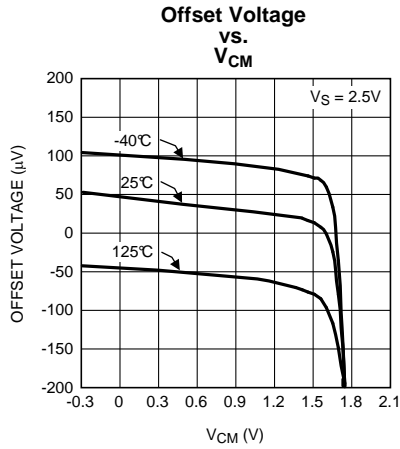

Figure 10.

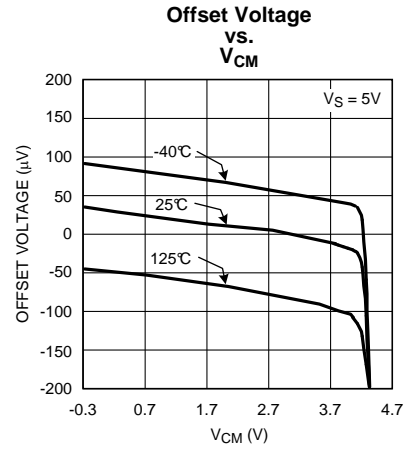

Figure 11.

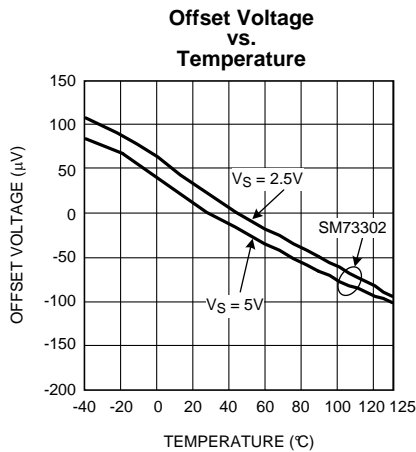

Figure 12.

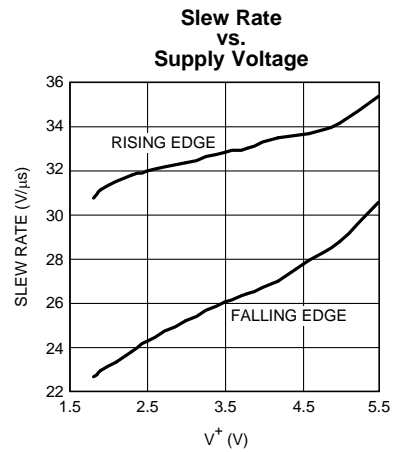

Figure 13.

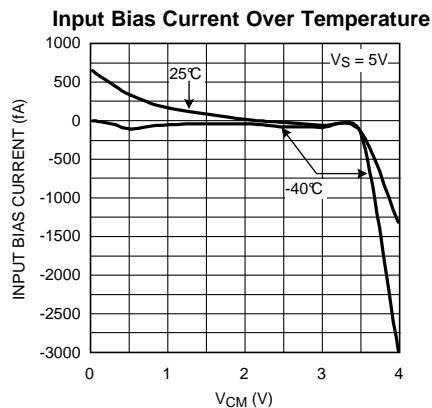

Figure 14.

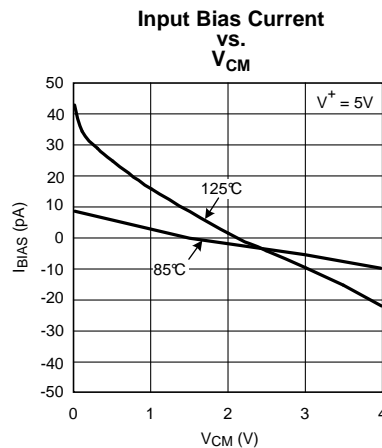

Figure 15.

**Typical Performance Characteristics (continued)**

Unless otherwise specified,  $T_A = 25^\circ\text{C}$ ,  $V^- = 0$ ,  $V^+ = 5\text{V}$ ,  $V_S = V^+ - V^-$ ,  $V_{CM} = V_S/2$ .

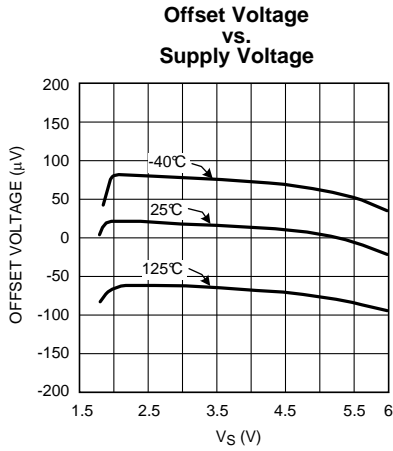

Figure 16.

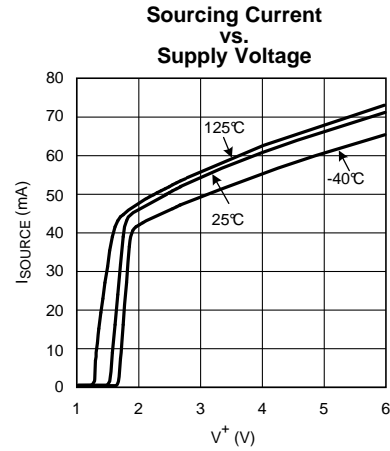

Figure 17.

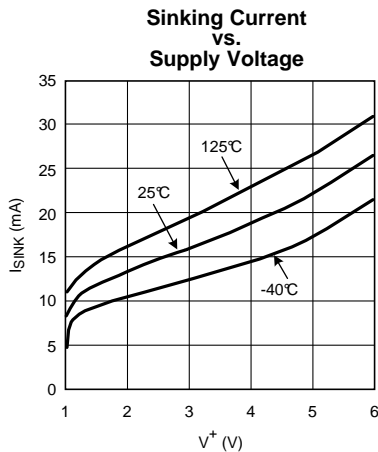

Figure 18.

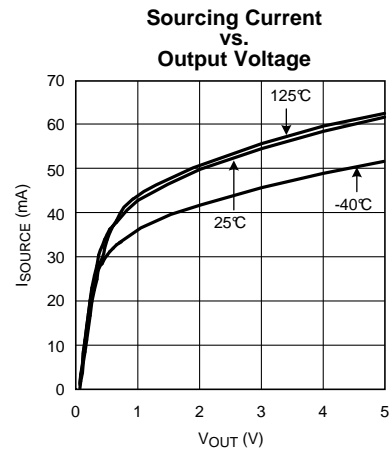

Figure 19.

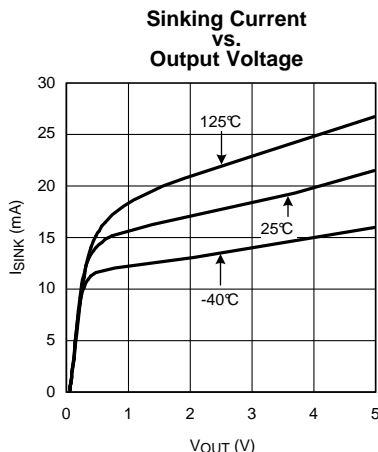

Figure 20.

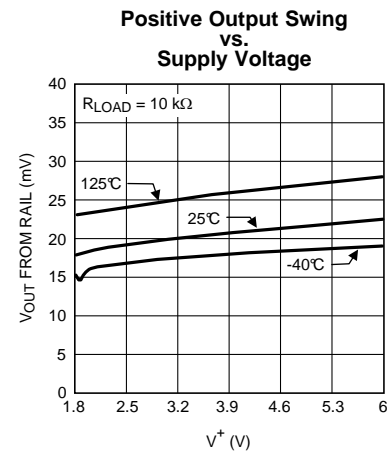

Figure 21.



**Typical Performance Characteristics (continued)**

Unless otherwise specified,  $T_A = 25^\circ\text{C}$ ,  $V^- = 0$ ,  $V^+ = 5\text{V}$ ,  $V_S = V^+ - V^-$ ,  $V_{CM} = V_S/2$ .

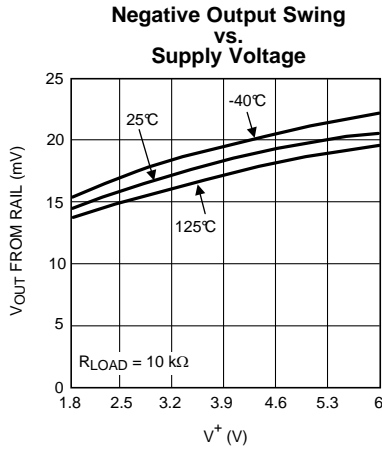

Figure 22.

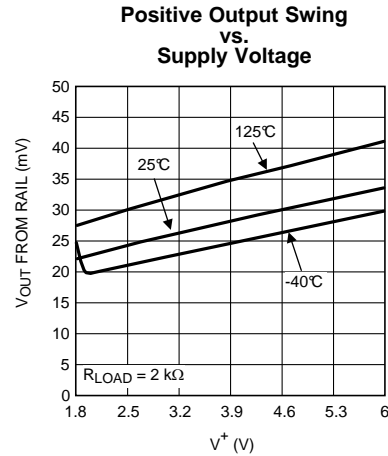

Figure 23.

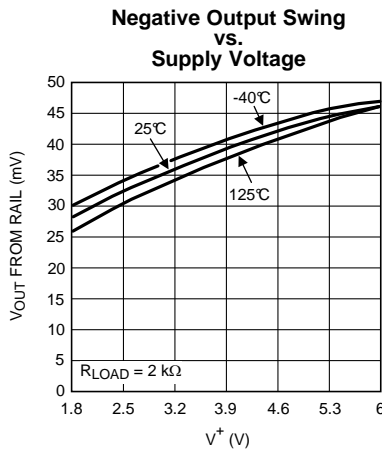

Figure 24.

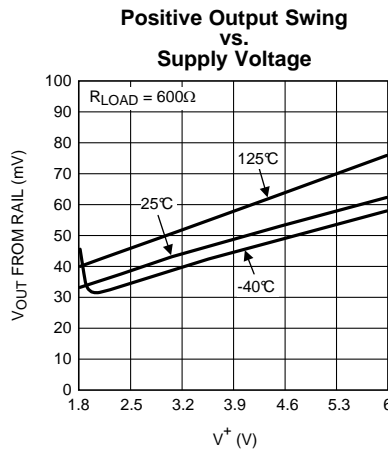

Figure 25.

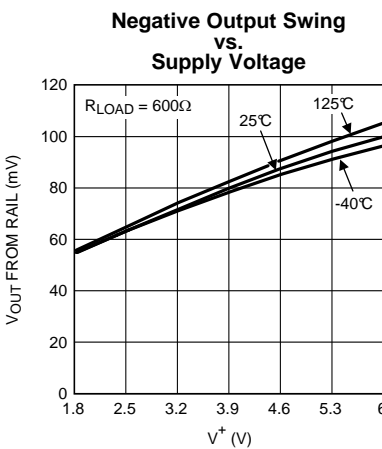

Figure 26.

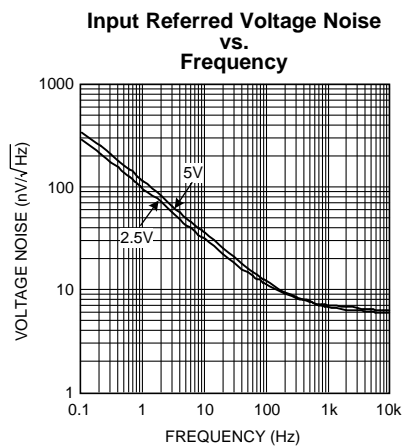

Figure 27.

### Typical Performance Characteristics (continued)

Unless otherwise specified,  $T_A = 25^\circ\text{C}$ ,  $V^- = 0$ ,  $V^+ = 5\text{V}$ ,  $V_S = V^+ - V^-$ ,  $V_{CM} = V_S/2$ .

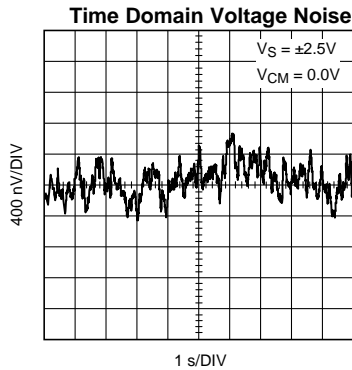

Figure 28.

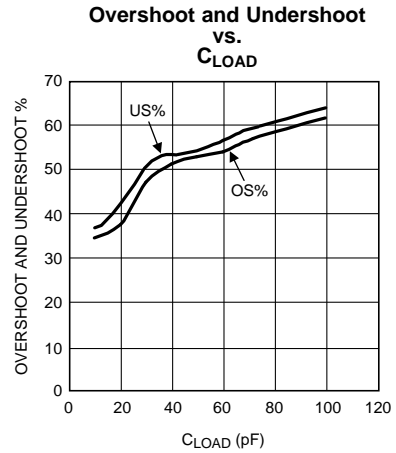

Figure 29.

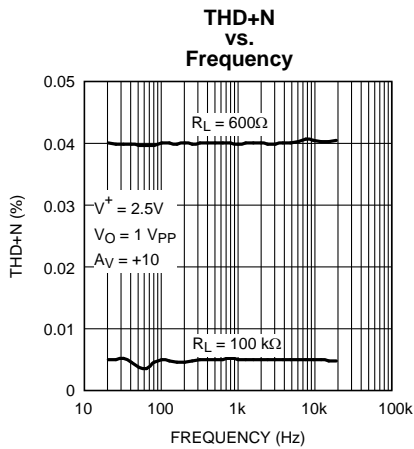

Figure 30.

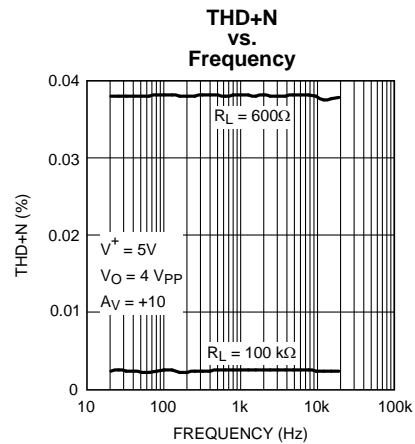

Figure 31.

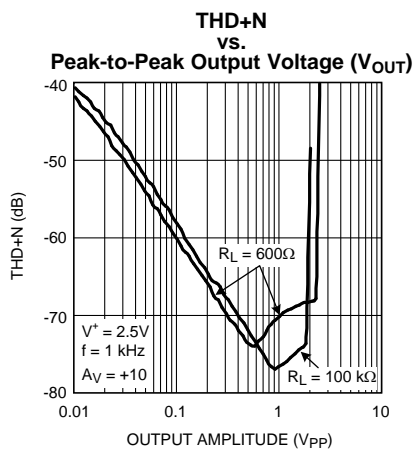

Figure 32.

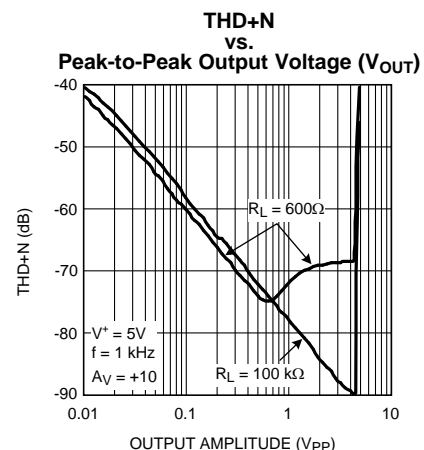

Figure 33.

### Typical Performance Characteristics (continued)

Unless otherwise specified,  $T_A = 25^\circ\text{C}$ ,  $V^- = 0$ ,  $V^+ = 5\text{V}$ ,  $V_S = V^+ - V^-$ ,  $V_{CM} = V_S/2$ .

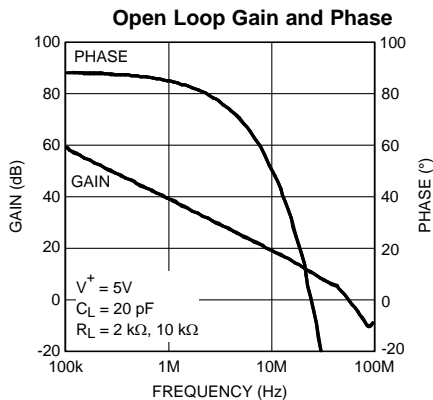

Figure 34.

### Closed Loop Output Impedance vs. Frequency

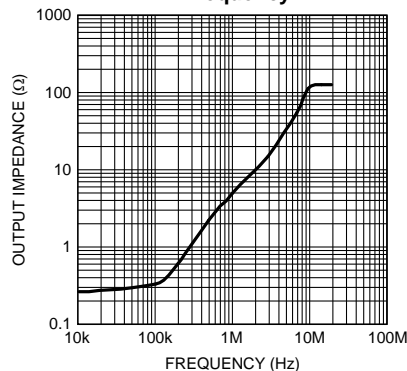

Figure 35.

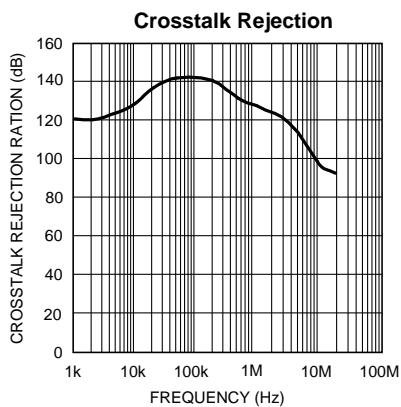

Figure 36.

### Small Signal Transient Response, $A_V = +10$

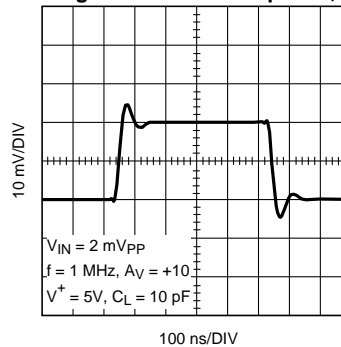

Figure 37.

### Large Signal Transient Response, $A_V = +10$

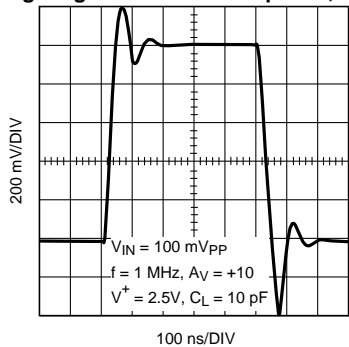

Figure 38.

### Small Signal Transient Response, $A_V = +10$

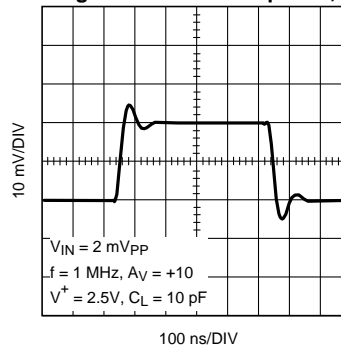
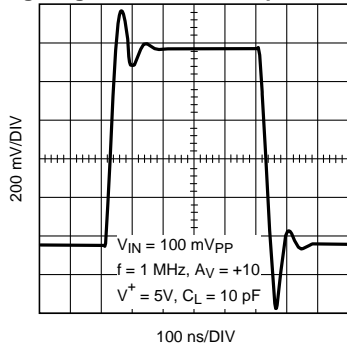

Figure 39.

**Typical Performance Characteristics (continued)**

Unless otherwise specified,  $T_A = 25^\circ\text{C}$ ,  $V^- = 0$ ,  $V^+ = 5\text{V}$ ,  $V_S = V^+ - V^-$ ,  $V_{CM} = V_S/2$ .

**Large Signal Transient Response,  $A_V = +10$**



**Figure 40.**

**PSRR vs. Frequency**

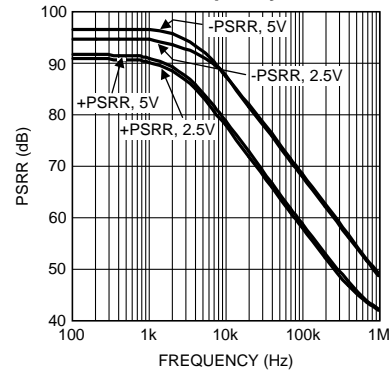

**Figure 41.**

**CMRR vs. Frequency**

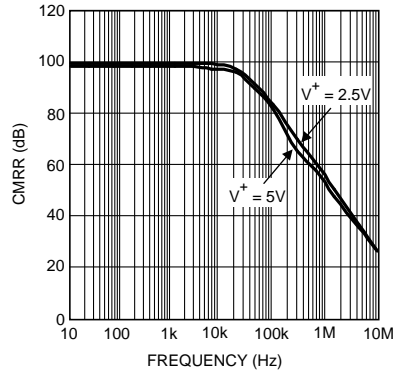

**Figure 42.**

**Input Common Mode Capacitance vs.  $V_{CM}$**

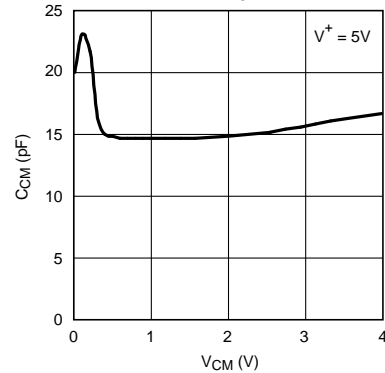

**Figure 43.**

## APPLICATION INFORMATION

### ADVANTAGES OF THE SM73302

#### Wide Bandwidth at Low Supply Current

The SM73302 is a high performance op amp that provides a GBW of 88 MHz with a gain of 10 while drawing a low supply current of 1.15 mA. This makes it ideal for providing wideband amplification in data acquisition applications.

With the proper external compensation, the SM73302 can be operated at gains of  $\pm 1$  and still maintain much faster slew rates than comparable unity gain stable amplifiers. The increase in bandwidth and slew rate is obtained without any additional power consumption over the LMP7715.

#### Low Input Referred Noise and Low Input Bias Current

The SM73302 has a very low input referred voltage noise density ( $5.8 \text{ nV}/\sqrt{\text{Hz}}$  at 1 kHz). A CMOS input stage ensures a small input bias current (100 fA) and low input referred current noise ( $0.01 \text{ pA}/\sqrt{\text{Hz}}$ ). This is very helpful in maintaining signal integrity, and makes the SM73302 ideal for audio and sensor based applications.

#### Low Supply Voltage

The SM73302 operates with a 2.5V and 5V supply. This device operates at all supply voltages between 2.0V and 5.5V, for ambient temperatures ranging from  $-40^\circ\text{C}$  to  $125^\circ\text{C}$ , thus utilizing the entire battery lifetime. The SM73302 is also operational at 1.8V supply voltage, for temperatures between  $0^\circ\text{C}$  and  $125^\circ\text{C}$  optimizing their usage in low-voltage applications.

#### RRO and Ground Sensing

Rail-to-Rail output (RRO) swing provides the maximum possible dynamic range. This is particularly important when operating at low supply voltages. An innovative positive feedback scheme is used to boost the current drive capability of the output stage. This allows the SM73302 to source more than 40 mA of current at 1.8V supply. This also limits the performance of this part as a comparator, and hence the usage of the SM73302 in an open-loop configuration is not recommended. The input common-mode range includes the negative supply rail which allows direct sensing at ground in single supply operation.

#### Small Size

The small footprint of the SM73302 package saves space on printed circuit boards, and enables the design of smaller electronic products, such as cellular phones, pagers, or other portable systems. Long traces between the signal source and the op amp make the signal path more susceptible to noise pick up.

The physically smaller SM73302 allows the op amp to be placed closer to the signal source, thus reducing noise pickup and maintaining signal integrity.

### USING THE DECOMPENSATED SM73302

#### Advantages of Decompensated Op Amp

A unity gain stable op amp, which is fully compensated, is designed to operate with good stability down to gains of  $\pm 1$ . The large amount of compensation does provide an op amp that is relatively easy to use; however, a decompensated op amp is designed to maximize the bandwidth and slew rate without any additional power consumption. This can be very advantageous.

The SM73302 requires a gain of  $\pm 10$  to be stable. However, with an external compensation network (a simple RC network) these parts can be stable with gains of  $\pm 1$  and still maintain the higher slew rate. Looking at the Bode plots for the SM73302 and its closest equivalent unity gain stable op amp, the LMP7715, one can clearly see the increased bandwidth of the SM73302. Both plots are taken with a parallel combination of 20 pF and 10 k $\Omega$  for the output load.

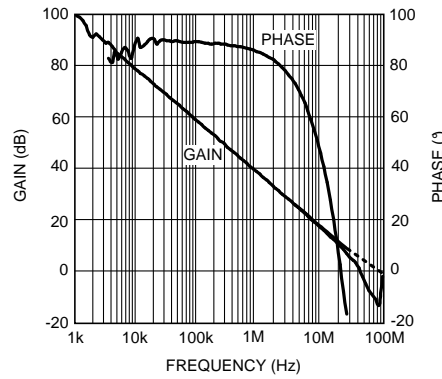

Figure 44. SM73302  $A_{VOL}$  vs. Frequency

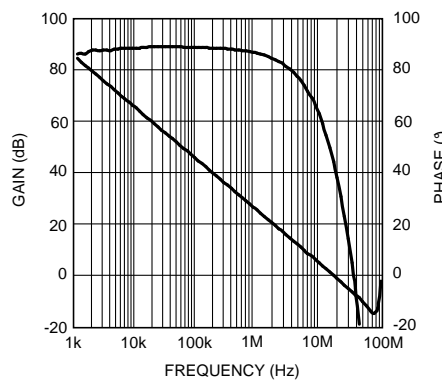

Figure 45. LMP7715  $A_{VOL}$  vs. Frequency

Figure 44 shows the much larger 88 MHz bandwidth of the SM73302 as compared to the 17 MHz bandwidth of the LMP7715 shown in Figure 45. The decompensated SM73302 has five times the bandwidth of the LMP7715.

**What is a Decompensated Op Amp?**

The differences between the unity gain stable op amp and the decompensated op amp are shown in Figure 46. This Bode plot assumes an ideal two pole system. The dominant pole of the decompensated op amp is at a higher frequency,  $f_1$ , as compared to the unity gain stable op amp which is at  $f_d$  as shown in Figure 46. This is done in order to increase the speed capability of the op amp while maintaining the same power dissipation of the unity gain stable op amp. The SM73302 has a dominant pole at 1.6 kHz. The unity gain stable LMP7715/LMP7716 have their dominant pole at 300 Hz.

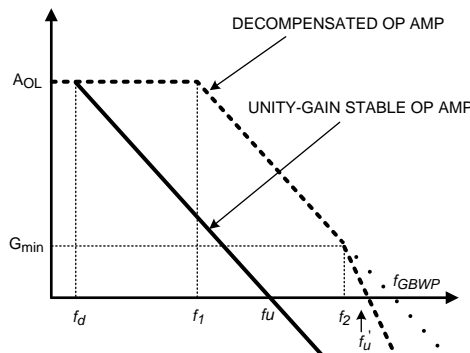

Figure 46. Open Loop Gain for Unity Gain Stable Op Amp and Decompensated Op Amp

Having a higher frequency for the dominate pole will result in:

1. The DC open loop gain ( $A_{VOL}$ ) extending to a higher frequency.
2. A wider closed loop bandwidth.
3. Better slew rate due to reduced compensation capacitance within the op amp.

The second open loop pole ( $f_2$ ) for the SM73302 occurs at 45 MHz. The unity gain ( $f_u'$ ) occurs after the second pole at 51 MHz. An ideal two pole system would give a phase margin of  $45^\circ$  at the location of the second pole. The SM73302 has parasitic poles close to the second pole, giving a phase margin closer to  $0^\circ$ . Therefore it is necessary to operate the SM73302 at a closed loop gain of 10 or higher, or to add external compensation in order to assure stability.

For the LMP7715, the gain bandwidth product occurs at 17 MHz. The curve is constant from  $f_d$  to  $f_u$  which occurs before the second pole.

For the SM73302 the GBW = 88 MHz and is constant between  $f_1$  and  $f_2$ . The second pole at  $f_2$  occurs before  $A_{VOL} = 1$ . Therefore  $f_u'$  occurs at 51 MHz, well before the GBW frequency of 88 MHz. For decompensated op amps the unity gain frequency and the GBW are no longer equal.  $G_{min}$  is the minimum gain for stability and for the SM73302 this is a gain of 18 to 20 dB.

### Input Lead-Lag Compensation

The recommended technique which allows the user to compensate the SM73302 for stable operation at any gain is lead-lag compensation. The compensation components added to the circuit allow the user to shape the feedback function to make sure there is sufficient phase margin when the loop gain is as low as 0 dB and still maintain the advantages over the unity gain op amp. Figure 47 shows the lead-lag configuration. Only  $R_C$  and C are added for the necessary compensation.

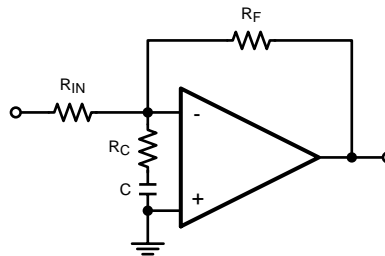

Figure 47. SM73302 with Lead-Lag Compensation for Inverting Configuration

To cover how to calculate the compensation network values it is necessary to introduce the term called the feedback factor or F. The feedback factor F is the feedback voltage  $V_A - V_B$  across the op amp input terminals relative to the op amp output voltage  $V_{OUT}$ .

$$F = \frac{V_A - V_B}{V_{OUT}} \quad (1)$$

From feedback theory the classic form of the feedback equation for op amps is:

$$\frac{V_{OUT}}{V_{IN}} = \frac{A}{1 + AF} \quad (2)$$

A is the open loop gain of the amplifier and AF is the loop gain. Both are highly important in analyzing op amps. Normally  $AF \gg 1$  and so the above equation reduces to:

$$\frac{V_{OUT}}{V_{IN}} = \frac{1}{F} \quad (3)$$

Deriving the equations for the lead-lag compensation is beyond the scope of this datasheet. The derivation is based on the feedback equations that have just been covered. The inverse of feedback factor for the circuit in Figure 47 is:

$$\frac{1}{F} = \left( 1 + \frac{R_F}{R_{IN}} \right) \left( \frac{1 + s(R_C + R_{IN} \parallel R_F) C}{1 + sR_C C} \right) \quad (4)$$

where 1/F's pole is located at

$$f_p = \frac{1}{2\pi R_C C} \quad (5)$$

1/F's zero is located at

$$f_z = \frac{1}{2\pi(R_C + R_{IN} \parallel R_F) C} \quad (6)$$

$$\left. \frac{1}{F} \right|_{f=0} = 1 + \frac{R_F}{R_{IN}} \quad (7)$$

The circuit gain for [Figure 47](#) at low frequencies is  $-R_F/R_{IN}$ , but F, the feedback factor is not equal to the circuit gain. The feedback factor is derived from feedback theory and is the same for both inverting and non-inverting configurations. Yes, the feedback factor at low frequencies is equal to the gain for the non-inverting configuration.

$$\left. \frac{1}{F} \right|_{f=\infty} = \left( 1 + \frac{R_F}{R_{IN}} \right) \left( 1 + \frac{R_{IN} \parallel R_F}{R_C} \right) \quad (8)$$

From this formula, we can see that

- 1/F's zero is located at a lower frequency compared with 1/F's pole.
- 1/F's value at low frequency is  $1 + R_F/R_{IN}$ .
- This method creates one additional pole and one additional zero.
- This pole-zero pair will serve two purposes:
  - To raise the 1/F value at higher frequencies prior to its intercept with A, the open loop gain curve, in order to meet the  $G_{min} = 10$  requirement. For the SM73302 some overcompensation will be necessary for good stability.
  - To achieve the previous purpose above with no additional loop phase delay.

Please note the constraint  $1/F \geq G_{min}$  needs to be satisfied only in the vicinity where the open loop gain A and 1/F intersect; 1/F can be shaped elsewhere as needed. The 1/F pole must occur before the intersection with the open loop gain A.

In order to have adequate phase margin, it is desirable to follow these two rules:

**Rule 1** 1/F and the open loop gain A should intersect at the frequency where there is a minimum of 45° of phase margin. When over-compensation is required the intersection point of A and 1/F is set at a frequency where the phase margin is above 45°, therefore increasing the stability of the circuit.

**Rule 2** 1/F's pole should be set at least one decade below the intersection with the open loop gain A in order to take advantage of the full 90° of phase lead brought by 1/F's pole which is F's zero. This ensures that the effect of the zero is fully neutralized when the 1/F and A plots intersect each other.

### Calculating Lead-Lag Compensation for SM73302

[Figure 48](#) is the same plot as [Figure 44](#), but the  $A_{VOL}$  and phase curves have been redrawn as smooth lines to more readily show the concepts covered, and to clearly show the key parameters used in the calculations for lead-lag compensation.



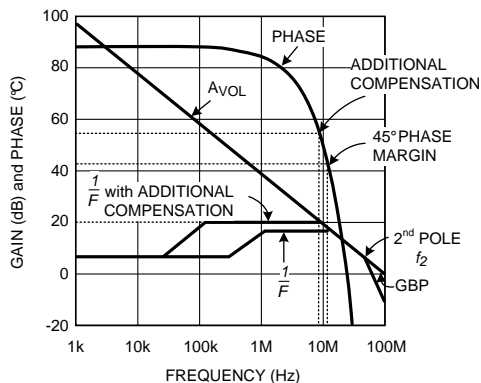

Figure 48. SM73302 Simplified Bode Plot

To obtain stable operation with gains under 10 V/V the open loop gain margin must be reduced at high frequencies to where there is a 45° phase margin when the gain margin of the circuit with the external compensation is 0 dB. The pole and zero in F, the feedback factor, control the gain margin at the higher frequencies. The distance between F and A<sub>VOL</sub> is the gain margin; therefore, the unity gain point (0 dB) is where F crosses the A<sub>VOL</sub> curve.

For the example being used R<sub>IN</sub> = R<sub>F</sub> for a gain of -1. Therefore F = 6 dB at low frequencies. At the higher frequencies the minimum value for F is 18 dB for 45° phase margin. From Equation 8 we have the following relationship:

$$\left(1 + \frac{R_F}{R_{IN}}\right) \left(1 + \frac{R_{IN} \parallel R_F}{R_C}\right) = 18 \text{ dB} = 7.9 \tag{9}$$

Now set R<sub>F</sub> = R<sub>IN</sub> = R. With these values and solving for R<sub>C</sub> we have R<sub>C</sub> = R/5.9. Note that the value of C does not affect the ratio between the resistors. Once the value of the resistors is set, then the position of the pole in F must be set. A 2 kΩ resistor is used for R<sub>F</sub> and R<sub>IN</sub> in this design. Therefore the value for R<sub>C</sub> is set at 330Ω, the closest standard value for 2 kΩ/5.9.

Rewriting Equation 5 to solve for the minimum capacitor value gives the following equation:

$$C = 1/(2\pi f_p R_C) \tag{10}$$

The feedback factor curve, F, intersects the A<sub>VOL</sub> curve at about 12 MHz. Therefore the pole of F should not be any larger than 1.2 MHz. Using this value and R<sub>C</sub> = 330Ω the minimum value for C is 390 pF. Figure 49 shows that there is too much overshoot, but the part is stable. Increasing C to 2.2 nF did not improve the ringing, as shown in Figure 50.

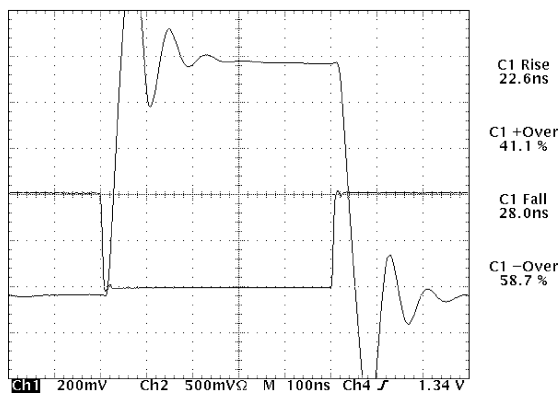
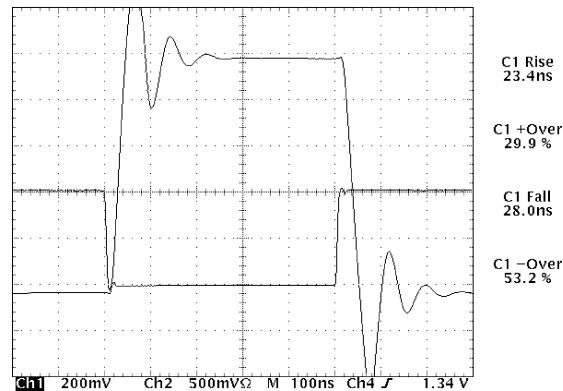
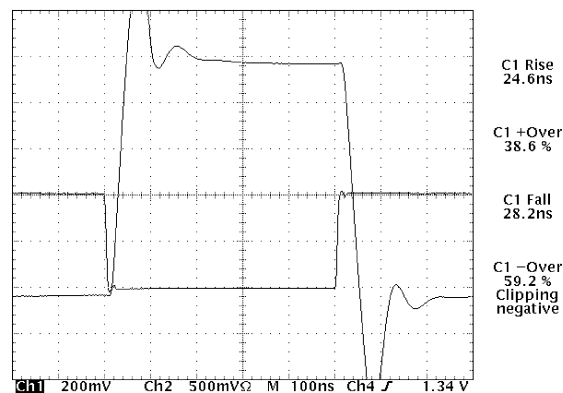

Figure 49. First Try at Compensation, Gain = -1

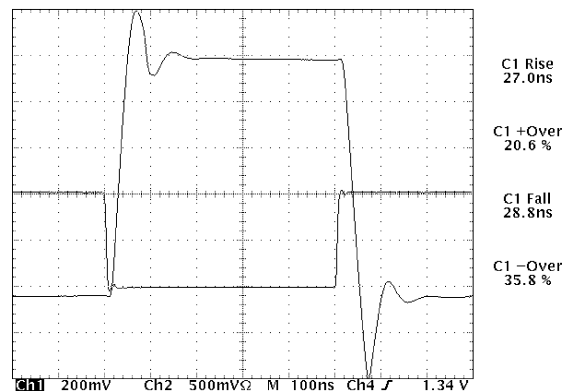

**Figure 50. C Increased to 2.2 nF, Gain = -1**

Some over-compensation appears to be needed for the desired overshoot characteristics. Instead of intersecting the  $A_{VOL}$  curve at 18 dB, 2 dB of over-compensation will be used, and the  $A_{VOL}$  curve will be intersected at 20 dB. Using Equation 8 for 20 dB, or 10 V/V, the closest standard value of  $R_C$  is 240Ω. The following two waveforms show the new resistor value with  $C = 390$  pF and 2.2 nF. Figure 52 shows the final compensation and a very good response for the 1 MHz square wave.



**Figure 51.  $R_C = 240\Omega$  and  $C = 390$  pF, Gain = -1**



**Figure 52.  $R_C = 240\Omega$  and  $C = 2.2$  nF, Gain = -1**

To summarize, the following steps were taken to compensate the SM73302 for a gain of  $-1$ :

1. Values for  $R_C$  and  $C$  were calculated from the Bode plot to give an expected phase margin of  $45^\circ$ . The values were based on  $R_{IN} = R_F = 2\text{ k}\Omega$ . These calculations gave  $R_C = 330\Omega$  and  $C = 390\text{ pF}$ .
2. To reduce the ringing  $C$  was increased to  $2.2\text{ nF}$  which moved the pole of  $F$ , the feedback factor, farther away from the  $A_{VOL}$  curve.
3. There was still too much ringing so  $2\text{ dB}$  of over-compensation was added to  $F$ . This was done by decreasing  $R_C$  to  $240\Omega$ .

The LMP7715 is the fully compensated part (without the Renewable Energy Grade), which is comparable to the SM73302. Using the LMP7715 in the same setup, but removing the compensation network, provided the response shown in Figure 53.

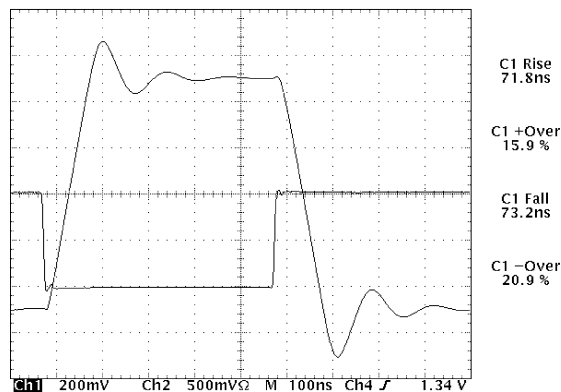

Figure 53. LMP7715 Response

For large signal response the rise and fall times are dominated by the slew rate of the op amps. Even though both parts are quite similar the SM73302 will give rise and fall times about 2.5 times faster than the LMP7715. This is possible because the SM73302 is a decompensated op amp and even though it is being used at a gain of  $-1$ , the speed is preserved by using a good technique for external compensation.

### Non-Inverting Compensation

For the non-inverting amp the same theory applies for establishing the needed compensation. When setting the inverting configuration for a gain of  $-1$ ,  $F$  has a value of 2. For the non-inverting configuration both  $F$  and the actual gain are the same, making the non-inverting configuration more difficult to compensate. Using the same circuit as shown in Figure 47, but setting up the circuit for non-inverting operation (gain of  $+2$ ) results in similar performance as the inverting configuration with the inputs set to half the amplitude to compensate for the additional gain. Figure 54 below shows the results.

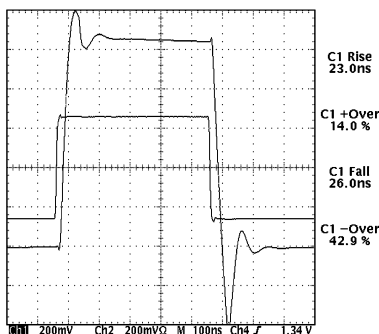
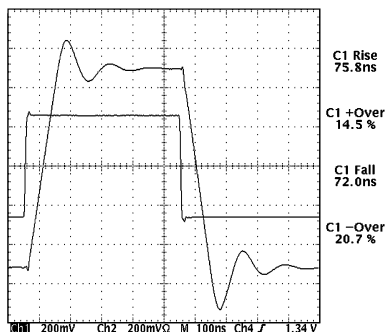

Figure 54.  $R_C = 240\Omega$  and  $C = 2.2\text{ nF}$ , Gain =  $+2$



**Figure 55. LMP7715 Response Gain = +2**

The response shown in [Figure 54](#) is close to the response shown in [Figure 52](#). The part is actually slightly faster in the non-inverting configuration. Decreasing the value of  $R_C$  to around  $200\Omega$  can decrease the negative overshoot but will have slightly longer rise and fall times. The other option is to add a small resistor in series with the input signal. [Figure 55](#) shows the performance of the LMP7715 with no compensation. Again the decoupled parts are almost 2.5 times faster than the fully compensated op amp.

The most difficult op amp configuration to stabilize is the gain of +1. With proper compensation the SM73302 can be used in this configuration and still maintain higher speeds than the fully compensated parts. [Figure 56](#) shows the gain = 1, or the buffer configuration, for these parts.

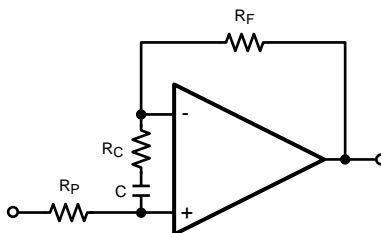

**Figure 56. SM73302 with Lead-Lag Compensation for Non-Inverting Configuration**

[Figure 56](#) is the result of using [Equation 8](#) and additional experimentation in the lab.  $R_P$  is not part of [Equation 8](#), but it is necessary to introduce another pole at the input stage for good performance at gain = +1. [Equation 8](#) is shown below with  $R_{IN} = \infty$ .

$$\left(1 + \frac{R_F}{R_C}\right) = 18 \text{ dB} = 7.9 \quad (11)$$

Using  $2 \text{ k}\Omega$  for  $R_F$  and solving for  $R_C$  gives  $R_C = 2000/6.9 = 290\Omega$ . The closest standard value for  $R_C$  is  $300\Omega$ . After some fine tuning in the lab  $R_C = 330\Omega$  and  $R_P = 1.5 \text{ k}\Omega$  were chosen as the optimum values.  $R_P$  together with the input capacitance at the non-inverting pin inserts another pole into the compensation for the SM73302. Adding this pole and slightly reducing the compensation for  $1/F$  (using a slightly higher resistor value for  $R_C$ ) gives the optimum response for a gain of +1. [Figure 57](#) is the response of the circuit shown in [Figure 56](#). [Figure 58](#) shows the response of the LMP7715 in the buffer configuration with no compensation and  $R_P = R_F = 0$ .

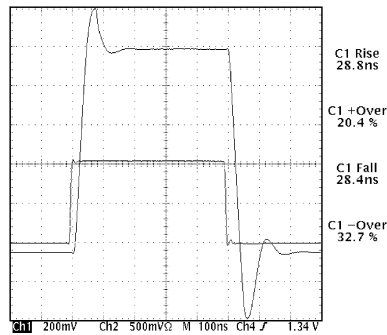

Figure 57.  $R_C = 330\Omega$  and  $C = 10$  nF, Gain = +1

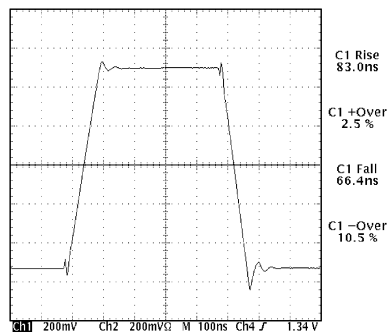

Figure 58. LMP7715 Response Gain = +1

With no increase in power consumption the decompensated op amp offers faster speed than the compensated equivalent part . These examples used  $R_F = 2$  k $\Omega$ . This value is high enough to be easily driven by the SM73302, yet small enough to minimize the effects from the parasitic capacitance of both the PCB and the op amp.

**Note:** When using the SM73302, proper high frequency PCB layout must be followed. The GBW of these parts is 88 MHz, making the PCB layout significantly more critical than when using the compensated counterparts which have a GBW of 17 MHz.

## TRANSIMPEDANCE AMPLIFIER

An excellent application for the SM73302 is as a transimpedance amplifier. With a GBW product of 88 MHz this part is ideal for high speed data transmission by light. The circuit shown on the front page of the datasheet is the circuit used to test the SM73302 as a transimpedance amplifier. The only change is that  $V_B$  is tied to the  $V_{CC}$  of the part, thus the direction of the diode is reversed from the circuit shown on the front page.

Very high speed components were used in testing to check the limits of the SM73302 in a transimpedance configuration. The photodiode part number is PIN-HR040 from OSI Optoelectronics. The diode capacitance for this part is only about 7 pF for the 2.5V bias used ( $V_{CC}$  to virtual ground). The rise time for this diode is 1 nsec. A laser diode was used for the light source. Laser diodes have on and off times under 5 nsec. The speed of the selected optical components allowed an accurate evaluation of the SM73302 as a transimpedance amplifier. An evaluation board for decompensated op amps, PN 551013271-001 A, was used and only minor modifications were necessary and no traces had to be cut.

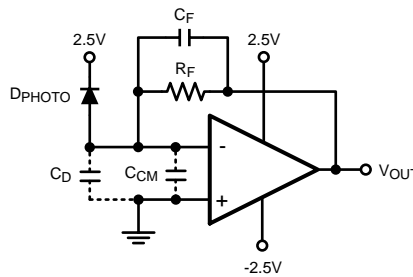

**Figure 59. Transimpedance Amplifier**

Figure 59 is the complete schematic for a transimpedance amplifier. Only the supply bypass capacitors are not shown.  $C_D$  represents the photodiode capacitance which is given on its datasheet.  $C_{CM}$  is the input common mode capacitance of the op amp and, for the SM73302 it is shown in Figure 43. In Figure 59 the inverting input pin of the SM73302 is kept at virtual ground. Even though the diode is connected to the 2.5V line, a power supply line is AC ground, thus  $C_D$  is connected to ground.

Figure 60 shows the schematic needed to derive  $F$ , the feedback factor, for a transimpedance amplifier. In this figure  $C_D + C_{CM} = C_{IN}$ . Therefore it is critical that the designer knows the diode capacitance and the op amp input capacitance. The photodiode is close to an ideal current source once its capacitance is included in the model. What kind of circuit is this? Without  $C_F$  there is only an input capacitor and a feedback resistor. This circuit is a differentiator! Remember, differentiator circuits are inherently unstable and must be compensated. In this case  $C_F$  compensates the circuit.

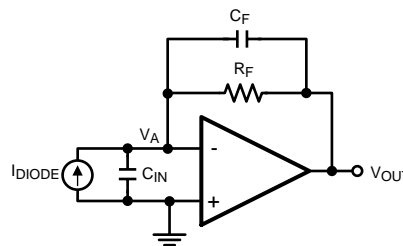

**Figure 60. Transimpedance Feedback Model**

Using feedback theory,  $F = V_A/V_{OUT}$ , this becomes a voltage divider giving the following equation:

$$F = \frac{1 + sC_F R_F}{1 + sR_F (C_F + C_{IN})} \quad (12)$$

The noise gain is  $1/F$ . Because this is a differentiator circuit, a zero must be inserted. The location of the zero is given by:

$$f_z = \frac{1}{1 + sR_F (C_F + C_{IN})} \quad (13)$$

$C_F$  has been added for stability. The addition of this part adds a pole to the circuit. The pole is located at:

$$f_p = \frac{1}{1 + sC_F R_F} \quad (14)$$

To attain maximum bandwidth and still have good stability the pole is to be located on the open loop gain curve which is  $A$ . If additional compensation is required one can always increase the value of  $C_F$ , but this will also reduce the bandwidth of the circuit. Therefore  $A = 1/F$ , or  $AF = 1$ . For  $A$  the equation is:

$$A = \frac{\omega_{GBW}}{\omega} = \frac{f_{GBW}}{f} \quad (15)$$

The expression  $f_{GBW}$  is the gain bandwidth product of the part. For a unity gain stable part this is the frequency where  $A = 1$ . For the SM73302  $f_{GBW} = 88$  MHz. Multiplying  $A$  and  $F$  results in the following equation:

$$AF \Big|_{f_p} = \frac{f_{GBW}}{f} \times \frac{1 + sC_F R_F}{1 + sR_F (C_F + C_{IN})} =$$

$$\frac{f_{GBW}}{f} \times \frac{\sqrt{1 + \left(\frac{C_F R_F}{C_F R_F}\right)^2}}{\sqrt{1 + \left(\frac{R_F (C_F + C_{IN})}{C_F R_F}\right)^2}} = 1$$
(16)

For the above equation  $s = j\omega$ . To find the actual amplitude of the equation the square root of the square of the real and imaginary parts are calculated. At the intersection of  $F$  and  $A$ , we have:

$$\omega = \frac{1}{C_F R_F}$$
(17)

After a bit of algebraic manipulation the above equation reduces to:

$$1 + \left(\frac{C_F + C_{IN}}{C_F}\right)^2 = 8\pi^2 f_{GBW}^2 R_F^2 C_F^2$$
(18)

In the above equation the only unknown is  $C_F$ . In trying to solve this equation the fourth power of  $C_F$  must be dealt with. An excel spread sheet with this equation can be used and all the known values entered. Then through iteration, the value of  $C_F$  when both sides are equal will be found. That is the correct value for  $C_F$  and of course the closest standard value is used for  $C_F$ .

Before moving to the lab, the transfer function of the transimpedance amplifier must be found and the units must be in Ohms.

$$V_{OUT} = \frac{-R_F}{1 + sC_F R_F} \times I_{DIODE}$$
(19)

The SM73302 was evaluated for  $R_F = 10$  k $\Omega$  and 100 k $\Omega$ , representing a somewhat lower gain configuration and with the 100 k $\Omega$  feedback resistor a fairly high gain configuration. The  $R_F = 10$  k $\Omega$  is covered first. Looking at the *Input Common Mode Capacitance vs.  $V_{CM}$*  chart for  $C_{CM}$  for the operating point selected  $C_{CM} = 15$  pF. Note that for split supplies  $V_{CM} = 2.5$ V,  $C_{IN} = 22$  pF and  $f_{GBW} = 88$  MHz. Solving for  $C_F$  the calculated value is 1.75 pF, so 1.8 pF is selected for use. Checking the frequency of the pole finds that it is at 8.8 MHz, which is right at the minimum gain recommended for this part. Some over compensation was necessary for stability and the final selected value for  $C_F$  is 2.7 pF. This moves the pole to 5.9 MHz. [Figure 61](#) and [Figure 62](#) show the rise and fall times obtained in the lab with a 1V output swing. The laser diode was difficult to drive due to thermal effects making the starting and ending point of the pulse quite different, therefore the two separate scope pictures.

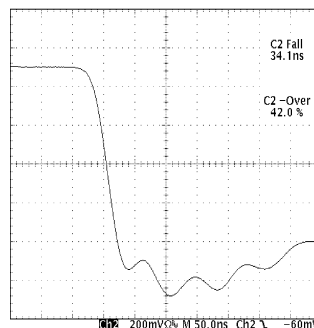
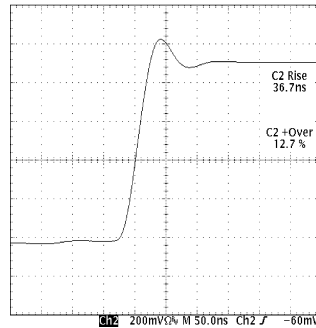

Figure 61. Fall Time



**Figure 62. Rise Time**

In [Figure 61](#) the ringing and the hump during the on time is from the laser. The higher drive levels for the laser gave ringing in the light source as well as light changing from the thermal characteristics. The hump is due to the thermal characteristics.

Solving for  $C_F$  using a 100 k $\Omega$  feedback resistor, the calculated value is 0.54 pF. One of the problems with more gain is the very small value for  $C_F$ . A 0.5 pF capacitor was used, its measured value being 0.64 pF. For the 0.64 pF location the pole is at 2.5 MHz. [Figure 63](#) shows the response for a 1V output.

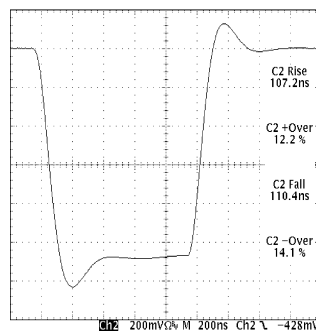

**Figure 63. High Gain Response**

A transimpedance amplifier is an excellent application for the SM73302. Even with the high gain using a 100 k $\Omega$  feedback resistor, the bandwidth is still well over 1 MHz. Other than a little over compensation for the 10 k $\Omega$  feedback resistor configuration using the SM73302 was quite easy. Of course a very good board layout was also used for this test.



---

**REVISION HISTORY**

| <b>Changes from Original (April 2013) to Revision A</b>  | <b>Page</b>              |
|--|--------------------------|
| <hr/> <ul style="list-style-type: none"><li>• Changed layout of National Data Sheet to TI format .....</li></ul> | <hr/> <a href="#">24</a> |

**PACKAGING INFORMATION**

| Orderable Device | Status<br>(1) | Package Type | Package Drawing | Pins | Package Qty | Eco Plan<br>(2) | Lead finish/<br>Ball material<br>(6) | MSL Peak Temp<br>(3) | Op Temp (°C) | Device Marking<br>(4/5) | Samples                 |
|------------------|---------------|--------------|-----------------|------|-------------|-----------------|--------------------------------------|----------------------|--------------|-------------------------|-------------------------|
| SM73302MF/NOPB   | ACTIVE        | SOT-23       | DBV             | 5    | 1000        | RoHS & Green    | SN                                   | Level-1-260C-UNLIM   | -40 to 125   | SC3B                    | <a href="#">Samples</a> |
| SM73302MFE/NOPB  | ACTIVE        | SOT-23       | DBV             | 5    | 250         | RoHS & Green    | SN                                   | Level-1-260C-UNLIM   | -40 to 125   | SC3B                    | <a href="#">Samples</a> |
| SM73302MFX/NOPB  | ACTIVE        | SOT-23       | DBV             | 5    | 3000        | RoHS & Green    | SN                                   | Level-1-260C-UNLIM   | -40 to 125   | SC3B                    | <a href="#">Samples</a> |

(1) The marketing status values are defined as follows:

**ACTIVE:** Product device recommended for new designs.

**LIFEBUY:** TI has announced that the device will be discontinued, and a lifetime-buy period is in effect.

**NRND:** Not recommended for new designs. Device is in production to support existing customers, but TI does not recommend using this part in a new design.

**PREVIEW:** Device has been announced but is not in production. Samples may or may not be available.

**OBSELETE:** TI has discontinued the production of the device.

(2) **RoHS:** TI defines "RoHS" to mean semiconductor products that are compliant with the current EU RoHS requirements for all 10 RoHS substances, including the requirement that RoHS substance do not exceed 0.1% by weight in homogeneous materials. Where designed to be soldered at high temperatures, "RoHS" products are suitable for use in specified lead-free processes. TI may reference these types of products as "Pb-Free".

**RoHS Exempt:** TI defines "RoHS Exempt" to mean products that contain lead but are compliant with EU RoHS pursuant to a specific EU RoHS exemption.

**Green:** TI defines "Green" to mean the content of Chlorine (Cl) and Bromine (Br) based flame retardants meet JS709B low halogen requirements of <=1000ppm threshold. Antimony trioxide based flame retardants must also meet the <=1000ppm threshold requirement.

(3) MSL, Peak Temp. - The Moisture Sensitivity Level rating according to the JEDEC industry standard classifications, and peak solder temperature.

(4) There may be additional marking, which relates to the logo, the lot trace code information, or the environmental category on the device.

(5) Multiple Device Markings will be inside parentheses. Only one Device Marking contained in parentheses and separated by a "~" will appear on a device. If a line is indented then it is a continuation of the previous line and the two combined represent the entire Device Marking for that device.

(6) Lead finish/Ball material - Orderable Devices may have multiple material finish options. Finish options are separated by a vertical ruled line. Lead finish/Ball material values may wrap to two lines if the finish value exceeds the maximum column width.

**Important Information and Disclaimer:**The information provided on this page represents TI's knowledge and belief as of the date that it is provided. TI bases its knowledge and belief on information provided by third parties, and makes no representation or warranty as to the accuracy of such information. Efforts are underway to better integrate information from third parties. TI has taken and continues to take reasonable steps to provide representative and accurate information but may not have conducted destructive testing or chemical analysis on incoming materials and chemicals. TI and TI suppliers consider certain information to be proprietary, and thus CAS numbers and other limited information may not be available for release.

In no event shall TI's liability arising out of such information exceed the total purchase price of the TI part(s) at issue in this document sold by TI to Customer on an annual basis.

**TAPE AND REEL INFORMATION**

**QUADRANT ASSIGNMENTS FOR PIN 1 ORIENTATION IN TAPE**

\*All dimensions are nominal

| Device          | Package Type | Package Drawing | Pins | SPQ  | Reel Diameter (mm) | Reel Width W1 (mm) | A0 (mm) | B0 (mm) | K0 (mm) | P1 (mm) | W (mm) | Pin1 Quadrant |
|-----------------|--------------|-----------------|------|------|--------------------|--------------------|---------|---------|---------|---------|--------|---------------|
| SM73302MF/NOPB  | SOT-23       | DBV             | 5    | 1000 | 178.0              | 8.4                | 3.2     | 3.2     | 1.4     | 4.0     | 8.0    | Q3            |
| SM73302MFE/NOPB | SOT-23       | DBV             | 5    | 250  | 178.0              | 8.4                | 3.2     | 3.2     | 1.4     | 4.0     | 8.0    | Q3            |
| SM73302MFX/NOPB | SOT-23       | DBV             | 5    | 3000 | 178.0              | 8.4                | 3.2     | 3.2     | 1.4     | 4.0     | 8.0    | Q3            |

**TAPE AND REEL BOX DIMENSIONS**

\*All dimensions are nominal

| Device          | Package Type | Package Drawing | Pins | SPQ  | Length (mm) | Width (mm) | Height (mm) |
|-----------------|--------------|-----------------|------|------|-------------|------------|-------------|
| SM73302MF/NOPB  | SOT-23       | DBV             | 5    | 1000 | 208.0       | 191.0      | 35.0        |
| SM73302MFE/NOPB | SOT-23       | DBV             | 5    | 250  | 208.0       | 191.0      | 35.0        |
| SM73302MFX/NOPB | SOT-23       | DBV             | 5    | 3000 | 208.0       | 191.0      | 35.0        |

# DBV0005A



# PACKAGE OUTLINE

SOT-23 - 1.45 mm max height

SMALL OUTLINE TRANSISTOR



4214839/J 02/2024

**NOTES:**

1. All linear dimensions are in millimeters. Any dimensions in parenthesis are for reference only. Dimensioning and tolerancing per ASME Y14.5M.
2. This drawing is subject to change without notice.
3. Reference JEDEC MO-178.
4. Body dimensions do not include mold flash, protrusions, or gate burrs. Mold flash, protrusions, or gate burrs shall not exceed 0.25 mm per side.
5. Support pin may differ or may not be present.

# EXAMPLE BOARD LAYOUT

DBV0005A

SOT-23 - 1.45 mm max height

SMALL OUTLINE TRANSISTOR



LAND PATTERN EXAMPLE  
EXPOSED METAL SHOWN  
SCALE:15X



SOLDER MASK DETAILS

4214839/J 02/2024

NOTES: (continued)

- 6. Publication IPC-7351 may have alternate designs.
- 7. Solder mask tolerances between and around signal pads can vary based on board fabrication site.

# EXAMPLE STENCIL DESIGN

DBV0005A

SOT-23 - 1.45 mm max height

SMALL OUTLINE TRANSISTOR



SOLDER PASTE EXAMPLE  
BASED ON 0.125 mm THICK STENCIL  
SCALE:15X

4214839/J 02/2024

NOTES: (continued)

8. Laser cutting apertures with trapezoidal walls and rounded corners may offer better paste release. IPC-7525 may have alternate design recommendations.
9. Board assembly site may have different recommendations for stencil design.



## IMPORTANT NOTICE AND DISCLAIMER

TI PROVIDES TECHNICAL AND RELIABILITY DATA (INCLUDING DATA SHEETS), DESIGN RESOURCES (INCLUDING REFERENCE DESIGNS), APPLICATION OR OTHER DESIGN ADVICE, WEB TOOLS, SAFETY INFORMATION, AND OTHER RESOURCES "AS IS" AND WITH ALL FAULTS, AND DISCLAIMS ALL WARRANTIES, EXPRESS AND IMPLIED, INCLUDING WITHOUT LIMITATION ANY IMPLIED WARRANTIES OF MERCHANTABILITY, FITNESS FOR A PARTICULAR PURPOSE OR NON-INFRINGEMENT OF THIRD PARTY INTELLECTUAL PROPERTY RIGHTS.

These resources are intended for skilled developers designing with TI products. You are solely responsible for (1) selecting the appropriate TI products for your application, (2) designing, validating and testing your application, and (3) ensuring your application meets applicable standards, and any other safety, security, regulatory or other requirements.

These resources are subject to change without notice. TI grants you permission to use these resources only for development of an application that uses the TI products described in the resource. Other reproduction and display of these resources is prohibited. No license is granted to any other TI intellectual property right or to any third party intellectual property right. TI disclaims responsibility for, and you will fully indemnify TI and its representatives against, any claims, damages, costs, losses, and liabilities arising out of your use of these resources.

TI's products are provided subject to [TI's Terms of Sale](#) or other applicable terms available either on [ti.com](https://www.ti.com) or provided in conjunction with such TI products. TI's provision of these resources does not expand or otherwise alter TI's applicable warranties or warranty disclaimers for TI products.

TI objects to and rejects any additional or different terms you may have proposed.

Mailing Address: Texas Instruments, Post Office Box 655303, Dallas, Texas 75265  
Copyright © 2024, Texas Instruments Incorporated