

SN54ALS805A, SN54AS805B, SN74ALS805A, SN74AS805B HEX 2-INPUT NOR DRIVERS

SDAS023C – DECEMBER 1982 – REVISED JANUARY 1995

- High Capacitive-Drive Capability
- 'ALS805A Has Typical Delay Time of 4.2 ns ($C_L = 50$ pF) and Typical Power Dissipation of 4.2 mW Per Gate
- 'AS805B Has Typical Delay Time of 2.6 ns ($C_L = 50$ pF) and Typical Power Dissipation of 12 mW Per Gate
- Package Options Include Plastic Small-Outline (DW) Packages, Ceramic Chip Carriers (FK), and Standard Plastic (N) and Ceramic (J) 300-mil DIPs

description

These devices contain six independent 2-input NOR drivers. They perform the Boolean functions $Y = A + B$ or $Y = \bar{A} \cdot \bar{B}$ in positive logic.

The SN54ALS805A and SN54AS805B are characterized for operation over the full military temperature range of -55°C to 125°C . The SN74ALS805A and SN74AS805B are characterized for operation from 0°C to 70°C .

FUNCTION TABLE
(each driver)

| INPUTS | | OUTPUT |
|--------|---|--------|
| A | B | Y |
| H | X | L |
| X | H | L |
| L | L | H |

logic symbol†

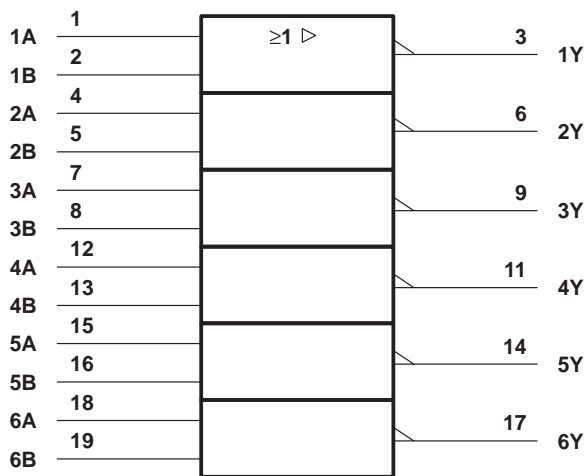

logic diagram (positive logic)

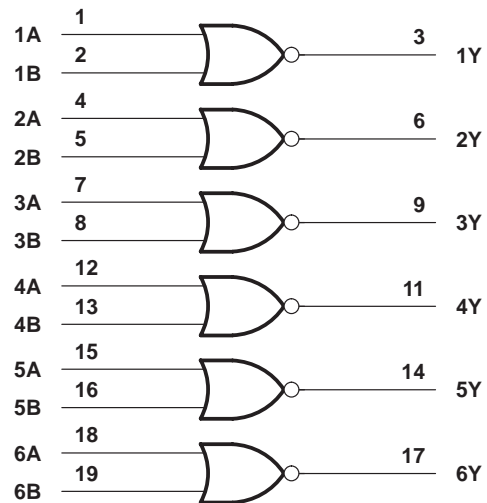

† This symbol is in accordance with ANSI/IEEE Std 91-1984 and IEC Publication 617-12.

SN54ALS805A, SN54AS805B . . . J PACKAGE
SN74ALS805A, SN74AS805B . . . DW OR N PACKAGE
(TOP VIEW)

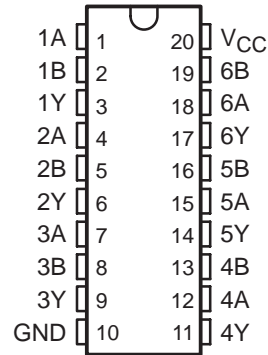

SN54ALS805A, SN54AS805B . . . FK PACKAGE
(TOP VIEW)

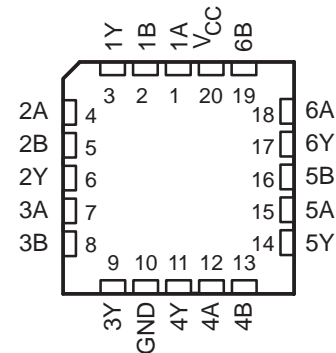

SN54ALS805A, SN54AS805B, SN74ALS805A, SN74AS805B HEX 2-INPUT NOR DRIVERS

SDAS023C – DECEMBER 1982 – REVISED JANUARY 1995

absolute maximum ratings over operating free-air temperature range (unless otherwise noted)†

| | |
|---|----------------|
| Supply voltage, V_{CC} | 7 V |
| Input voltage, V_I | 7 V |
| Operating free-air temperature range, T_A : SN54ALS805A | -55°C to 125°C |
| SN74ALS805A | 0°C to 70°C |
| Storage temperature range | -65°C to 150°C |

† Stresses beyond those listed under "absolute maximum ratings" may cause permanent damage to the device. These are stress ratings only, and functional operation of the device at these or any other conditions beyond those indicated under "recommended operating conditions" is not implied. Exposure to absolute-maximum-rated conditions for extended periods may affect device reliability.

recommended operating conditions

| | | SN54ALS805A | | | SN74ALS805A | | | UNIT |
|----------|--------------------------------|-------------|-----|-----|-------------|-----|-----|------|
| | | MIN | NOM | MAX | MIN | NOM | MAX | |
| V_{CC} | Supply voltage | 4.5 | 5 | 5.5 | 4.5 | 5 | 5.5 | V |
| V_{IH} | High-level input voltage | 2 | | | 2 | | | V |
| V_{IL} | Low-level input voltage | | | 0.7 | | | 0.8 | V |
| I_{OH} | High-level output current | | | -12 | | | -15 | mA |
| I_{OL} | Low-level output current | | | 12 | | | 24 | mA |
| T_A | Operating free-air temperature | -55 | | 125 | 0 | | 70 | °C |

electrical characteristics over recommended operating free-air temperature range (unless otherwise noted)

| PARAMETER | TEST CONDITIONS | SN54ALS805A | | | SN74ALS805A | | | UNIT |
|--------------|---|--------------|------|--------------|-------------|------|------|------|
| | | MIN | TYP‡ | MAX | MIN | TYP‡ | MAX | |
| V_{IK} | $V_{CC} = 4.5$ V, $I_I = -18$ mA | | | -1.2 | | | -1.2 | V |
| V_{OH} | $V_{CC} = 4.5$ V to 5.5 V, $I_{OH} = -0.4$ mA | $V_{CC} - 2$ | | $V_{CC} - 2$ | | | | V |
| | $V_{CC} = 4.5$ V, $I_{OH} = -3$ mA | 2.4 | 3.2 | 2.4 | 3.2 | | | |
| | $V_{CC} = 4.5$ V, $I_{OH} = -12$ mA | 2 | | 2 | | | | |
| V_{OL} | $V_{CC} = 4.5$ V, $I_{OL} = 12$ mA | | 0.25 | 0.4 | | 0.25 | 0.4 | V |
| | $V_{CC} = 4.5$ V, $I_{OL} = 24$ mA | | | | | 0.35 | 0.5 | |
| I_I | $V_{CC} = 5.5$ V, $V_I = 7$ V | | | 0.1 | | | 0.1 | mA |
| I_{IH} | $V_{CC} = 5.5$ V, $V_I = 2.7$ V | | | 20 | | | 20 | μA |
| I_{IL} | $V_{CC} = 5.5$ V, $V_I = 0.4$ V | | | -0.1 | | | -0.1 | mA |
| I_{O}^{\S} | $V_{CC} = 5.5$ V, $V_O = 2.25$ V | -20 | | -112 | -30 | | -112 | mA |
| I_{CCH} | $V_{CC} = 5.5$ V, $V_I = 0$ | | 2 | 4 | | 2 | 4 | mA |
| I_{CCL} | $V_{CC} = 5.5$ V, $V_I = 4.5$ V | | 8 | 14 | | 8 | 14 | mA |

‡ All typical values are at $V_{CC} = 5$ V, $T_A = 25^\circ\text{C}$.

§ The output conditions have been chosen to produce a current that closely approximates one half of the true short-circuit output current, I_{OS} .



SN54ALS805A, SN54AS805B, SN74ALS805A, SN74AS805B HEX 2-INPUT NOR DRIVERS

SDAS023C – DECEMBER 1982 – REVISED JANUARY 1995

switching characteristics (see Figure 1)

| PARAMETER | FROM (INPUT) | TO (OUTPUT) | V _{CC} = 4.5 V to 5.5 V, C _L = 50 pF, R _L = 500 Ω, T _A = MIN to MAX† | | | | UNIT |
|------------------|-----------------|----------------|---|-----|-------------|-----|------|
| | | | SN54ALS805A | | SN74ALS805A | | |
| | | | MIN | MAX | MIN | MAX | |
| t _{PLH} | A or B | Y | 1 | 12 | 2 | 7 | ns |
| t _{PHL} | | | 1 | 9 | 2 | 8 | |

† For conditions shown as MIN or MAX, use the appropriate value specified under recommended operating conditions.

absolute maximum ratings over operating free-air temperature range (unless otherwise noted)‡

| | |
|---|----------------|
| Supply voltage, V _{CC} | 7 V |
| Input voltage, V _I | 7 V |
| Operating free-air temperature range, T _A : SN54AS805B | -55°C to 125°C |
| SN74AS805B | 0°C to 70°C |
| Storage temperature range | -65°C to 150°C |

‡ Stresses beyond those listed under "absolute maximum ratings" may cause permanent damage to the device. These are stress ratings only, and functional operation of the device at these or any other conditions beyond those indicated under "recommended operating conditions" is not implied. Exposure to absolute-maximum-rated conditions for extended periods may affect device reliability.

recommended operating conditions§

| | SN54AS805B | | | SN74AS805B | | | UNIT |
|---|------------|-----|-----|------------|-----|-----|------|
| | MIN | NOM | MAX | MIN | NOM | MAX | |
| V _{CC} Supply voltage | 4.5 | 5 | 5.5 | 4.5 | 5 | 5.5 | V |
| V _{IH} High-level input voltage | 2 | | | 2 | | | V |
| V _{IL} Low-level input voltage | | | 0.8 | | | 0.8 | V |
| I _{OH} High-level output current | | | -40 | | | -48 | mA |
| I _{OL} Low-level output current | | | 40 | | | 48 | mA |
| T _A Operating free-air temperature | -55 | | 125 | 0 | | 70 | °C |

§ These high sink- or source-current devices are not recommended for use above 40 MHz.



SN54ALS805A, SN54AS805B, SN74ALS805A, SN74AS805B HEX 2-INPUT NOR DRIVERS

SDAS023C – DECEMBER 1982 – REVISED JANUARY 1995

electrical characteristics over recommended operating free-air temperature range (unless otherwise noted)

| PARAMETER | TEST CONDITIONS | | SN54AS805B | | SN74AS805B | | UNIT | |
|-----------------|-------------------------------|-------------------|--------------|------|--------------|------|---------|------|
| | | | MIN | TYP† | MAX | MIN | | TYP† |
| V_{IK} | $V_{CC} = 4.5 V$, | $I_I = -18 mA$ | | | -1.2 | -1.2 | V | |
| V_{OH} | $V_{CC} = 4.5 V$ to $5.5 V$, | $I_{OH} = -2 mA$ | $V_{CC} - 2$ | | $V_{CC} - 2$ | | V | |
| | $V_{CC} = 4.5 V$ | $I_{OH} = -3 mA$ | 2.4 | 3.2 | 2.4 | 3.2 | | |
| | | $I_{OH} = -40 mA$ | 2 | | 2 | | | |
| V_{OL} | $V_{CC} = 4.5 V$ | $I_{OL} = 40 mA$ | 0.25 0.5 | | | | V | |
| | | $I_{OL} = 48 mA$ | | | 0.35 | 0.5 | | |
| I_I | $V_{CC} = 5.5 V$, | $V_I = 7 V$ | | | 0.1 | 0.1 | mA | |
| I_{IH} | $V_{CC} = 5.5 V$, | $V_I = 2.7 V$ | | | 20 | 20 | μA | |
| I_{IL} | $V_{CC} = 5.5 V$, | $V_I = 0.4 V$ | | | -0.5 | -0.5 | mA | |
| $I_{O\ddagger}$ | $V_{CC} = 5.5 V$, | $V_O = 2.25 V$ | -50 | | -200 | -200 | mA | |
| I_{CCH} | $V_{CC} = 5.5 V$, | $V_I = 0$ | | 6.5 | 10 | 6.5 | 10 | mA |
| I_{CCL} | $V_{CC} = 5.5 V$, | $V_I = 4.5 V$ | | 20 | 32 | 20 | 32 | mA |

† All typical values are at $V_{CC} = 5 V$, $T_A = 25^\circ C$.

‡ The output conditions have been chosen to produce a current that closely approximates one half of the true short-circuit output current, I_{OS} .

switching characteristics (see Figure 1)

| PARAMETER | FROM (INPUT) | TO (OUTPUT) | $V_{CC} = 4.5 V$ to $5.5 V$, $C_L = 50 pF$, $R_L = 500 \Omega$, $T_A = MIN$ to MAX § | | | | UNIT |
|-----------|--------------|-------------|--|-----|------------|-----|------|
| | | | SN54AS805B | | SN74AS805B | | |
| | | | MIN | MAX | MIN | MAX | |
| t_{PLH} | A or B | Y | 1 | 4.8 | 1 | 4.3 | ns |
| t_{PHL} | | | 1 | 4.8 | 1 | 4.3 | |

§ For conditions shown as MIN or MAX, use the appropriate value specified under recommended operating conditions.



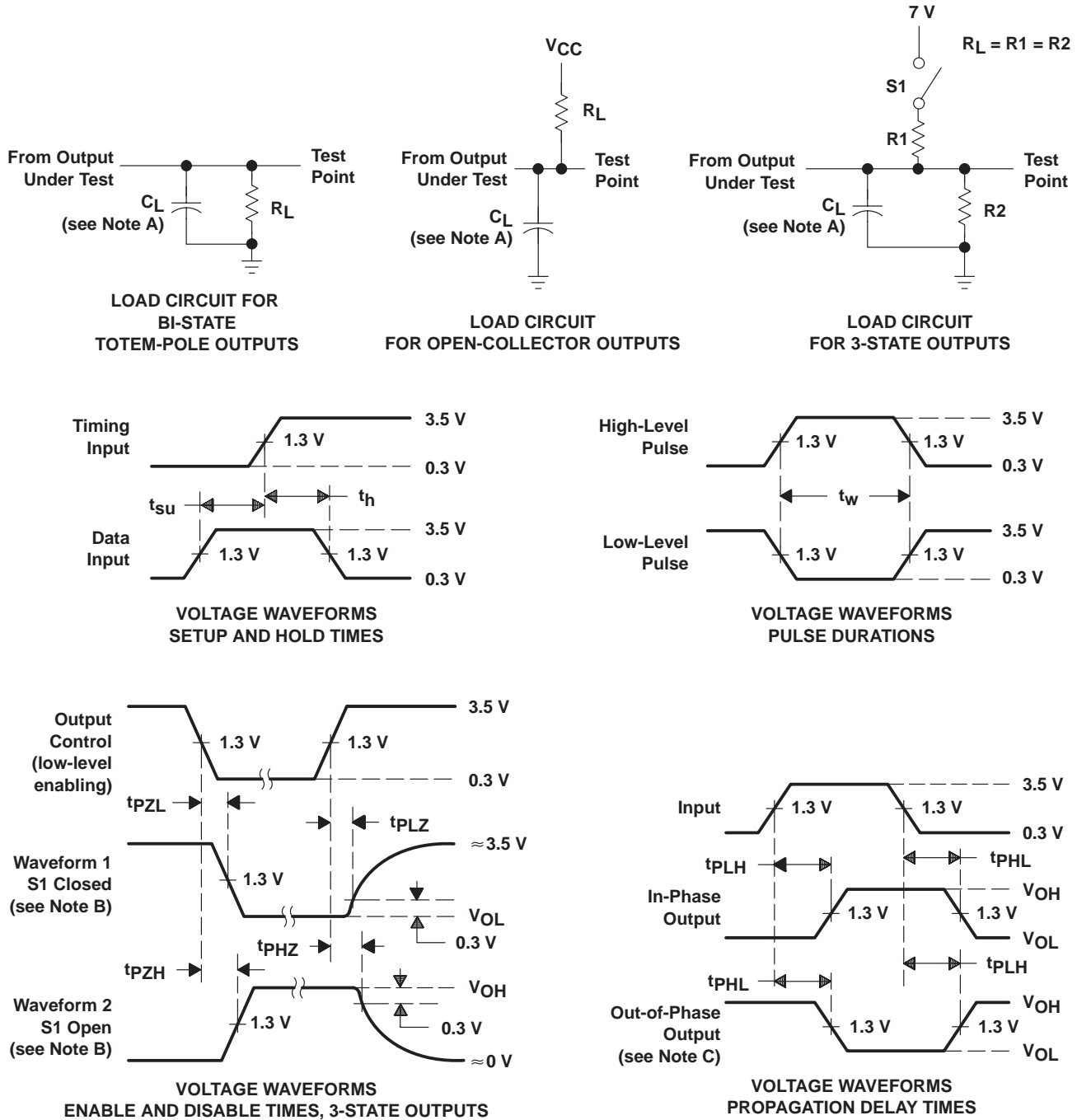

PARAMETER MEASUREMENT INFORMATION
SERIES 54ALS/74ALS AND 54AS/74AS DEVICES



- NOTES: A. C_L includes probe and jig capacitance.
 B. Waveform 1 is for an output with internal conditions such that the output is low except when disabled by the output control. Waveform 2 is for an output with internal conditions such that the output is high except when disabled by the output control.
 C. When measuring propagation delay items of 3-state outputs, switch S1 is open.
 D. All input pulses have the following characteristics: $PRR \leq 1$ MHz, $t_r = t_f = 2$ ns, duty cycle = 50%.
 E. The outputs are measured one at a time with one transition per measurement.

Figure 1. Load Circuits and Voltage Waveforms

PACKAGING INFORMATION

| Orderable Device | Status (1) | Package Type | Package Drawing | Pins | Package Qty | Eco Plan (2) | Lead/Ball Finish (6) | MSL Peak Temp (3) | Op Temp (°C) | Device Marking (4/5) | Samples |
|------------------|---------------|--------------|-----------------|------|-------------|-----------------|-------------------------|----------------------|--------------|--|---|
| 5962-87794012A | ACTIVE | LCCC | FK | 20 | 1 | TBD | POST-PLATE | N / A for Pkg Type | -55 to 125 | 5962- 87794012A SNJ54AS 805BFBK |  |
| SNJ54AS805BFBK | ACTIVE | LCCC | FK | 20 | 1 | TBD | POST-PLATE | N / A for Pkg Type | -55 to 125 | 5962- 87794012A SNJ54AS 805BFBK |  |

(1) The marketing status values are defined as follows:

ACTIVE: Product device recommended for new designs.

LIFEBUY: TI has announced that the device will be discontinued, and a lifetime-buy period is in effect.

NRND: Not recommended for new designs. Device is in production to support existing customers, but TI does not recommend using this part in a new design.

PREVIEW: Device has been announced but is not in production. Samples may or may not be available.

OBSOLETE: TI has discontinued the production of the device.

(2) Eco Plan - The planned eco-friendly classification: Pb-Free (RoHS), Pb-Free (RoHS Exempt), or Green (RoHS & no Sb/Br) - please check <http://www.ti.com/productcontent> for the latest availability information and additional product content details.

TBD: The Pb-Free/Green conversion plan has not been defined.

Pb-Free (RoHS): TI's terms "Lead-Free" or "Pb-Free" mean semiconductor products that are compatible with the current RoHS requirements for all 6 substances, including the requirement that lead not exceed 0.1% by weight in homogeneous materials. Where designed to be soldered at high temperatures, TI Pb-Free products are suitable for use in specified lead-free processes.

Pb-Free (RoHS Exempt): This component has a RoHS exemption for either 1) lead-based flip-chip solder bumps used between the die and package, or 2) lead-based die adhesive used between the die and leadframe. The component is otherwise considered Pb-Free (RoHS compatible) as defined above.

Green (RoHS & no Sb/Br): TI defines "Green" to mean Pb-Free (RoHS compatible), and free of Bromine (Br) and Antimony (Sb) based flame retardants (Br or Sb do not exceed 0.1% by weight in homogeneous material)

(3) MSL, Peak Temp. - The Moisture Sensitivity Level rating according to the JEDEC industry standard classifications, and peak solder temperature.

(4) There may be additional marking, which relates to the logo, the lot trace code information, or the environmental category on the device.

(5) Multiple Device Markings will be inside parentheses. Only one Device Marking contained in parentheses and separated by a "~" will appear on a device. If a line is indented then it is a continuation of the previous line and the two combined represent the entire Device Marking for that device.

(6) Lead/Ball Finish - Orderable Devices may have multiple material finish options. Finish options are separated by a vertical ruled line. Lead/Ball Finish values may wrap to two lines if the finish value exceeds the maximum column width.

Important Information and Disclaimer: The information provided on this page represents TI's knowledge and belief as of the date that it is provided. TI bases its knowledge and belief on information provided by third parties, and makes no representation or warranty as to the accuracy of such information. Efforts are underway to better integrate information from third parties. TI has taken and continues to take reasonable steps to provide representative and accurate information but may not have conducted destructive testing or chemical analysis on incoming materials and chemicals. TI and TI suppliers consider certain information to be proprietary, and thus CAS numbers and other limited information may not be available for release.

In no event shall TI's liability arising out of such information exceed the total purchase price of the TI part(s) at issue in this document sold by TI to Customer on an annual basis.

FK (S-CQCC-N**)

LEADLESS CERAMIC CHIP CARRIER

28 TERMINAL SHOWN



| NO. OF TERMINALS ** | A | | B | |
|---------------------|------------------|------------------|------------------|------------------|
| | MIN | MAX | MIN | MAX |
| 20 | 0.342 (8,69) | 0.358 (9,09) | 0.307 (7,80) | 0.358 (9,09) |
| 28 | 0.442 (11,23) | 0.458 (11,63) | 0.406 (10,31) | 0.458 (11,63) |
| 44 | 0.640 (16,26) | 0.660 (16,76) | 0.495 (12,58) | 0.560 (14,22) |
| 52 | 0.740 (18,78) | 0.761 (19,32) | 0.495 (12,58) | 0.560 (14,22) |
| 68 | 0.938 (23,83) | 0.962 (24,43) | 0.850 (21,6) | 0.858 (21,8) |
| 84 | 1.141 (28,99) | 1.165 (29,59) | 1.047 (26,6) | 1.063 (27,0) |



4040140/D 01/11

- NOTES:
- All linear dimensions are in inches (millimeters).
 - This drawing is subject to change without notice.
 - This package can be hermetically sealed with a metal lid.
 - Falls within JEDEC MS-004

IMPORTANT NOTICE AND DISCLAIMER

TI PROVIDES TECHNICAL AND RELIABILITY DATA (INCLUDING DATASHEETS), DESIGN RESOURCES (INCLUDING REFERENCE DESIGNS), APPLICATION OR OTHER DESIGN ADVICE, WEB TOOLS, SAFETY INFORMATION, AND OTHER RESOURCES "AS IS" AND WITH ALL FAULTS, AND DISCLAIMS ALL WARRANTIES, EXPRESS AND IMPLIED, INCLUDING WITHOUT LIMITATION ANY IMPLIED WARRANTIES OF MERCHANTABILITY, FITNESS FOR A PARTICULAR PURPOSE OR NON-INFRINGEMENT OF THIRD PARTY INTELLECTUAL PROPERTY RIGHTS.

These resources are intended for skilled developers designing with TI products. You are solely responsible for (1) selecting the appropriate TI products for your application, (2) designing, validating and testing your application, and (3) ensuring your application meets applicable standards, and any other safety, security, or other requirements. These resources are subject to change without notice. TI grants you permission to use these resources only for development of an application that uses the TI products described in the resource. Other reproduction and display of these resources is prohibited. No license is granted to any other TI intellectual property right or to any third party intellectual property right. TI disclaims responsibility for, and you will fully indemnify TI and its representatives against, any claims, damages, costs, losses, and liabilities arising out of your use of these resources.

TI's products are provided subject to TI's Terms of Sale (www.ti.com/legal/termsofsale.html) or other applicable terms available either on ti.com or provided in conjunction with such TI products. TI's provision of these resources does not expand or otherwise alter TI's applicable warranties or warranty disclaimers for TI products.

Mailing Address: Texas Instruments, Post Office Box 655303, Dallas, Texas 75265
Copyright © 2019, Texas Instruments Incorporated