

2.5 V/3.3 V PECL/ECL 1:2 Fanout Buffer

FEATURES

- 1:2 PECL/ECL Fanout Buffer
- Operating Range
 - PECL: $V_{CC} = 2.375\text{ V to }3.8\text{ V}$ With $V_{EE} = 0\text{ V}$
 - NECL: $V_{CC} = 0\text{ V}$ With $V_{EE} = -2.375\text{ V to }-3.8\text{ V}$
- Open Input Default State
- Support for Clock Frequencies $> 3.0\text{ GHz}$
- 240 ps Typical Propagation Delay
- Deterministic Output Value for Open Input Conditions
- Q Output Will Default Low When Input Open or at V_{EE}
- Built-in Temperature Compensation
- Drop in Compatible to MC10LVEP11, MC100LVEP11
- LVDS Input Compatible

DESCRIPTION

The SN65LVEP11 is a differential 1:2 PECL/ECL fanout buffer. The device includes circuitry to maintain known logic levels when the inputs are in an open condition. Single-ended clock input operation is limited to $V_{CC} \geq 3\text{ V}$ in PECL mode, or $V_{EE} \leq 3\text{ V}$ in NECL mode. The device is housed in an industry-standard SOIC-8 package and is also available in TSSOP-8 package option.

PINOUT ASSIGNMENT

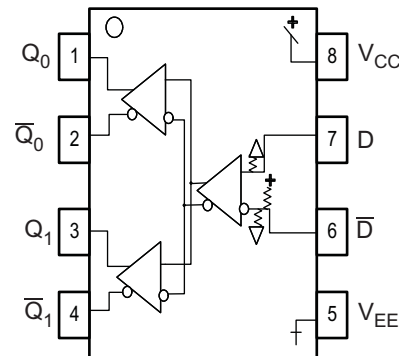

Table 1. PIN DESCRIPTION

PIN	FUNCTION
D, \bar{D}	PECL/ECL data inputs
$Q_0, \bar{Q}_0, Q_1, \bar{Q}_1$	PECL/ECL outputs
V_{CC}	Positive supply
V_{EE}	Negative supply

ORDERING INFORMATION⁽¹⁾

PART NUMBER	PART MARKING	PACKAGE	LEAD FINISH
SN65LVEP11D	SN65LVEP11	SOIC	NiPdAu
SN65LVEP11DGK	SN65LVEP11	SOIC-TSSOP	NiPdAu

(1) Leaded device option not initially available; contact [TI sales representative](#) for further information.



Please be aware that an important notice concerning availability, standard warranty, and use in critical applications of Texas Instruments semiconductor products and disclaimers thereto appears at the end of this data sheet.



These devices have limited built-in ESD protection. The leads should be shorted together or the device placed in conductive foam during storage or handling to prevent electrostatic damage to the MOS gates.

ABSOLUTE MAXIMUM RATINGS

PARAMETER	CONDITION	VALUE	UNIT
Absolute PECL mode supply voltage VCC	$V_{EE} = 0\text{ V}$	6	V
Absolute NECL mode supply voltage, V_{EE}	$V_{CC} = 0\text{ V}$	-6	V
PECL mode input voltage	$V_{EE} = 0\text{ V}; V_I \leq V_{CC}$	6	V
NECL mode input voltage	$V_{CC} = 0\text{ V}; V_I \geq V_{EE}$	-6	V
Output current	Continuous	50	mA
	Surge	100	mA
Operating temperature range		-40 to 85	°C
Storage temperature range		-65 to 150	°C

POWER DISSIPATION RATINGS

PACKAGE	CIRCUIT BOARD MODEL	POWER RATING $T_A < 25^\circ\text{C}$ (mW)	THERMAL RESISTANCE, JUNCTION TO AMBIENT NO AIRFLOW	DERATING FACTOR $T_A > 25^\circ\text{C}$ (mW/°C)	POWER RATING $T_A = 85^\circ\text{C}$ (mW)
SOIC	Low-K	719	139	7	288
	High-K	840	119	8	336
SOIC-TSSOP	Low-K	469	213	5	188
	High-K	527	189	5	211

THERMAL CHARACTERISTICS

PARAMETER		PACKAGE	VALUE	UNIT
θ_{JB}	Junction-to Board Thermal Resistance	SOIC	79	°C/W
		SOIC-TSSOP	120	
θ_{JC}	Junction-to Case Thermal Resistance	SOIC	98	°C/W
		SOIC-TSSOP	74	

KEY ATTRIBUTES

CHARACTERISTICS	VALUE
Internal input pull down resistor	75 k Ω
Internal input pull up resistor	37.5 k Ω
Moisture sensitivity level	Level 1
Flammability rating (Oxygen Index: 28 to 34)	UL 94 V-0 at 0.125 in
ESD-HBM	4 kV
ESD-machine model	200 V
ESD-charged device model	2 kV
Meets or exceeds JEDEC Spec EIA/JESD78 latchup test	

PECL DC CHARACTERISTICS⁽¹⁾ ($V_{CC} = 2.5\text{ V}$; $V_{EE} = 0.0\text{ V}$)⁽²⁾

PARAMETER		–40°C			25°C			85°C			UNIT
		MIN	TYP	MAX	MIN	TYP	MAX	MIN	TYP	MAX	
I_{CC}	Power supply current		28	45		31	45		35	45	mA
V_{OH}	Output HIGH voltage ⁽³⁾	1355		1605	1355	1425	1605	1335		1605	mV
V_{OL}	Output LOW voltage ⁽³⁾	555		900	555	759	900	555		900	mV
V_{IH}	Input high voltage (Single-Ended)	1335		1620	1335		1620	1335		1620	mV
V_{IL}	Input low voltage (Single-Ended)	555		900	555		900	555		900	mV
V_{IHCMR}	Input HIGH voltage common mode range (Differential) ⁽⁴⁾	1.2		2.5	1.2		2.5	1.2		2.5	V
I_{IH}	Input HIGH current			150			150			150	μA
I_{IL}	Input LOW current (D)	0.5			0.5			0.5			μA
	Input LOW current (–D)	–150			–150			–150			

- (1) The device will meet the specifications after the thermal balance has been established when mounted in a socket or printed circuit board with maintained transverse airflow greater than 500 lfpm. Electrical parameters are assured only over the declared operating temperature range. Functional operation of the device exceeding these conditions is not implied. Device specification limit values are applied individually under normal operating conditions and not valid simultaneously.
- (2) Input and output parameters vary 1:1 with V_{CC} . V_{EE} can vary +0.125 V to –1.3 V.
- (3) All loading with 50 Ω to $V_{CC} - 2\text{ V}$.
- (4) $V_{IHCMR\ min}$ varies 1:1 with V_{EE} . $V_{IHCMR\ max}$ varies 1:1 with V_{CC} . The V_{IHCMR} range is referenced to the most positive side of the differential input signal. Single ended input clock pin operation is limited to $V_{CC} \geq 3.0\text{ V}$ in PECL mode.

PECL DC CHARACTERISTICS⁽¹⁾ ($V_{CC} = 3.3\text{ V}$; $V_{EE} = 0.0\text{ V}$)⁽²⁾

PARAMETER		–40°C			25°C			85°C			UNIT
		MIN	TYP	MAX	MIN	TYP	MAX	MIN	TYP	MAX	
I_{CC}	Power supply current		28	45		32	45		36	45	mA
V_{OH}	Output HIGH voltage ⁽³⁾	2155		2405	2155	2221	2405	2155		2405	mV
V_{OL}	Output LOW voltage ⁽³⁾	1355		1700	1355	1543	1700	1355		1700	mV
V_{IH}	Input high voltage (Single-Ended) ⁽⁴⁾	2135		2420	2135		2420	2135		2420	mV
V_{IL}	Input low voltage (Single-Ended) ⁽⁴⁾	1355		1700	1355		1700	1355		1700	mV
V_{IHCMR}	Input HIGH voltage common mode range (Differential) ⁽⁵⁾	1.2		3.3	1.2		3.3	1.2		3.3	V
I_{IH}	Input HIGH current			150			150			150	μA
I_{IL}	Input LOW current (D)	0.5			0.5			0.5			μA
	Input LOW current (–D)	–150			–150			–150			

- (1) The device will meet the specifications after the thermal balance has been established when mounted in a socket or printed circuit board with maintained transverse airflow greater than 500 lfpm. Electrical parameters are specified only over the declared operating temperature range. Functional operation of the device exceeding these conditions is not implied. Device specification limit values are applied individually under normal operating conditions and not valid simultaneously.
- (2) Input and output parameters vary 1:1 with V_{CC} . V_{EE} can vary +0.925 V to –0.5 V.
- (3) All loading with 50 Ω to $V_{CC} - 2\text{ V}$.
- (4) Single Ended input clock pin operation is limited to $V_{CC} \geq 3\text{ V}$ in PECL mode.
- (5) $V_{IHCMR\ min}$ varies 1:1 with V_{EE} . $V_{IHCMR\ max}$ varies 1:1 with V_{CC} . The V_{IHCMR} range is referenced to the most positive side of the differential input signal.

NECL DC CHARACTERISTICS⁽¹⁾ ($V_{CC} = 0.0\text{ V}$; $V_{EE} = -3.8\text{ V to } -2.375\text{ V}$)⁽²⁾

PARAMETER	-40°C			25°C			85°C			UNIT
	MIN	TYP	MAX	MIN	TYP	MAX	MIN	TYP	MAX	
I_{CC} Power supply current		28	45		32	45		36	45	mA
V_{OH} Output HIGH voltage ⁽³⁾	-1145		-895	-1145	-1065	-895	-1145		-895	mV
V_{OL} Output LOW voltage ⁽³⁾	-1945		-1600	-1945	-1777	-1600	-1945		-1600	mV
V_{IH} Input high voltage (Single-Ended) ⁽⁴⁾	-1165		-880	-1165		-880	-1165		-880	mV
V_{IL} Input low voltage (Single-Ended) ⁽⁴⁾	-1945		-1600	-1945		-1600	-1945		-1600	mV
V_{IHCMR} Input HIGH voltage common mode range (Differential) ⁽⁵⁾	$V_{EE}+1.2$	$V_{EE}+1.2$	0.0	$V_{EE}+1.2$	$V_{EE}+1.2$	0.0	$V_{EE}+1.2$	$V_{EE}+1.2$	0.0	V
I_{IH} Input HIGH current			150			150			150	μ A
I_{IL} Input LOW current (D)		0.5			0.5			0.5		μ A
	Input LOW current (-D)	-150		-150		-150		-150		

- (1) The device will meet the specifications after thermal balance has been established when mounted in a socket or printed circuit board with maintained transverse airflow greater than 500 lfm. Electrical parameters are assured only over the declared operating temperature range. Functional operation of the device exceeding these conditions is not implied. Device specification limit values are applied individually under normal operating conditions and not valid simultaneously.
- (2) Input and output parameters vary 1:1 with V_{CC} .
- (3) All loading with 50 Ω to $V_{CC} - 2\text{ V}$.
- (4) Single Ended input clock pin operation is limited to $V_{CC} \leq -3\text{ V}$ in NECL mode.
- (5) $V_{IHCMR\ min}$ varies 1:1 with V_{EE} , $V_{IHCMR\ max}$ varies 1:1 with V_{CC} . The V_{IHCMR} range is referenced to the most positive side of the differential input signal.

AC CHARACTERISTICS⁽¹⁾ ($V_{CC} = 2.375\text{ V to } 3.8\text{ V}$; $V_{EE} = 0.0\text{ V or } V_{CC} = 0.0\text{ V}$; $V_{EE} = -3.8\text{ V to } -2.375\text{ V}$)⁽²⁾

PARAMETER	-40°C			25°C			85°C			UNIT
	MIN	TYP	MAX	MIN	TYP	MAX	MIN	TYP	MAX	
f_{MAX} Max switching frequency ⁽³⁾ (see Figure 6)		3.8			3.5			3.1		GHz
t_{PLH}/t_{PHL} Propagation delay to output differential (CLK, Q, -Q)	200		300	200		300	200		300	ps
t_{SKEW}	Device skew (Q, -Q)		8		8	15		8	15	ps
	Device to Device Skew (Q, -Q) ⁽⁴⁾		25		25			25		
t_{JITTER}	Random clock jitter (RMS) $\leq 1.0\text{ GHz}$		0.3		0.3			0.3		ps
	Random Clock Jitter (RMS) $\leq 1.5\text{ GHz}$		0.2		0.2			0.2		
	Random Clock Jitter (RMS) $\leq 2.0\text{ GHz}$		0.2		0.2			0.2		
	Random Clock Jitter (RMS) $\leq 2.5\text{ GHz}$		0.2		0.2			0.2		
	Random Clock Jitter (RMS) $\leq 3.0\text{ GHz}$		0.2		0.2			0.2		
V_{PP} Input swing Differential Config.	150	800	1200	150		1200	150		1200	mV
t_r/t_f Output rise/fall times Q, -Q (20%–80%)	100		200	100		200	100		200	ps

- (1) The device will meet the specifications after thermal equilibrium has been established when mounted in a test socket or printed circuit board with maintained transverse airflow greater than 500 lfm. Electrical parameters are assured only over the declared operating temperature range. Functional operation of the device exceeding these conditions is not implied. Device specification limit values are applied individually under normal operating conditions and not valid simultaneously.
- (2) Measured using a 750 mV source, 50% duty cycle clock source. All loading with 50 Ω to $V_{CC} - 2\text{ V}$.
- (3) The maximum switching frequency measured at the output amplitude of 300 mVpp.
- (4) Skew is measured between outputs under identical transitions

Typical Termination for Output Driver

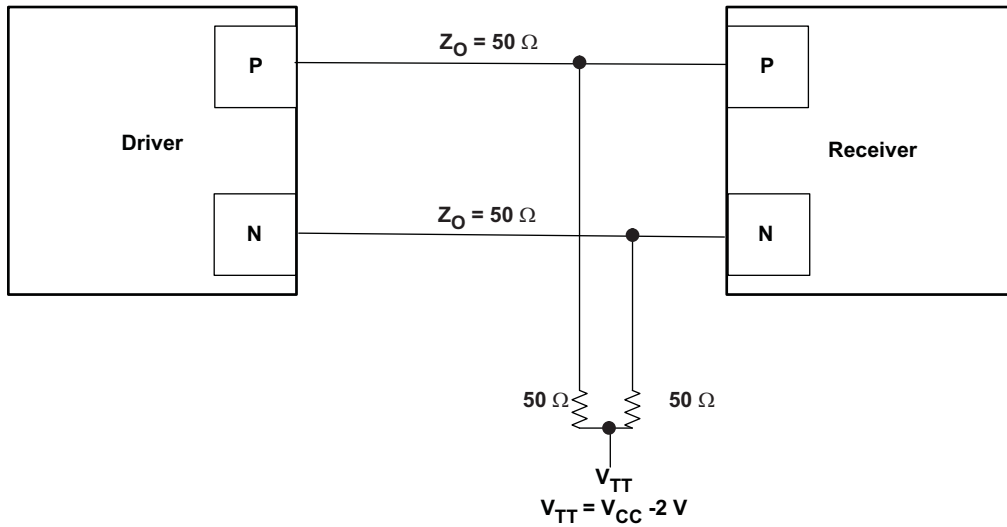

Figure 1. Typical Termination for Output Driver

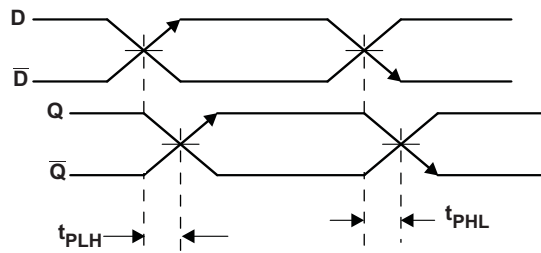

Figure 2. Propagation Delay

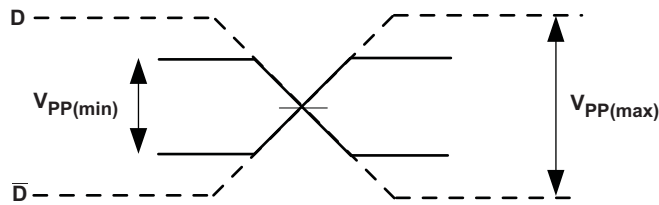

Figure 3. Input Voltage Swing

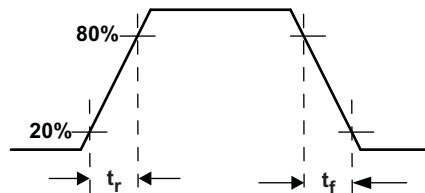

Figure 4. Output Rise and Fall Times

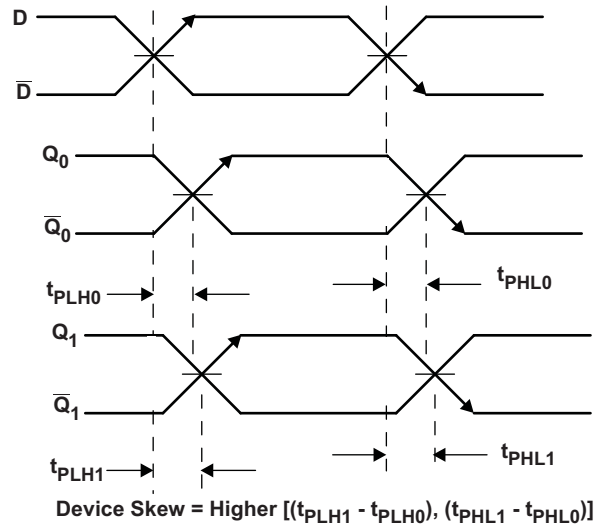

Figure 5. Device Skew

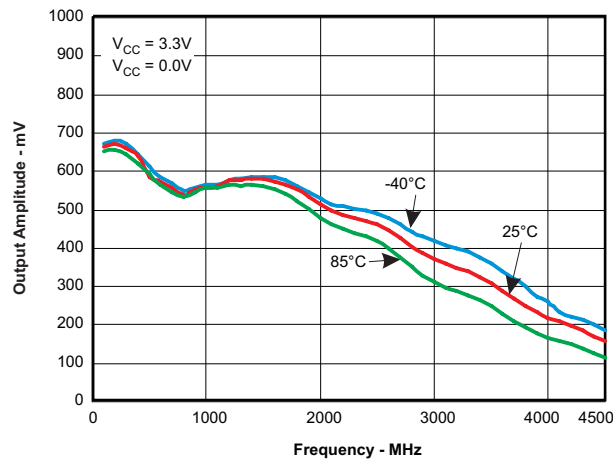

Figure 6. Output Amplitude vs Frequency

PACKAGING INFORMATION

Orderable Device	Status (1)	Package Type	Package Drawing	Pins	Package Qty	Eco Plan (2)	Lead/Ball Finish (6)	MSL Peak Temp (3)	Op Temp (°C)	Device Marking (4/5)	Samples
SN65LVEP11D	ACTIVE	SOIC	D	8	75	Green (RoHS & no Sb/Br)	NIPDAU	Level-1-260C-UNLIM	-40 to 85	LVEP11	Samples
SN65LVEP11DGK	ACTIVE	VSSOP	DGK	8	80	Green (RoHS & no Sb/Br)	Call TI NIPDAU	Level-1-260C-UNLIM	-40 to 85	SIJI	Samples
SN65LVEP11DGKR	ACTIVE	VSSOP	DGK	8	2500	Green (RoHS & no Sb/Br)	NIPDAU	Level-1-260C-UNLIM	-40 to 85	SIJI	Samples
SN65LVEP11DR	ACTIVE	SOIC	D	8	2500	Green (RoHS & no Sb/Br)	NIPDAU	Level-1-260C-UNLIM	-40 to 85	LVEP11	Samples

(1) The marketing status values are defined as follows:

ACTIVE: Product device recommended for new designs.

LIFEBUY: TI has announced that the device will be discontinued, and a lifetime-buy period is in effect.

NRND: Not recommended for new designs. Device is in production to support existing customers, but TI does not recommend using this part in a new design.

PREVIEW: Device has been announced but is not in production. Samples may or may not be available.

OBSELETE: TI has discontinued the production of the device.

(2) **RoHS:** TI defines "RoHS" to mean semiconductor products that are compliant with the current EU RoHS requirements for all 10 RoHS substances, including the requirement that RoHS substance do not exceed 0.1% by weight in homogeneous materials. Where designed to be soldered at high temperatures, "RoHS" products are suitable for use in specified lead-free processes. TI may reference these types of products as "Pb-Free".

RoHS Exempt: TI defines "RoHS Exempt" to mean products that contain lead but are compliant with EU RoHS pursuant to a specific EU RoHS exemption.

Green: TI defines "Green" to mean the content of Chlorine (Cl) and Bromine (Br) based flame retardants meet JS709B low halogen requirements of <=1000ppm threshold. Antimony trioxide based flame retardants must also meet the <=1000ppm threshold requirement.

(3) MSL, Peak Temp. - The Moisture Sensitivity Level rating according to the JEDEC industry standard classifications, and peak solder temperature.

(4) There may be additional marking, which relates to the logo, the lot trace code information, or the environmental category on the device.

(5) Multiple Device Markings will be inside parentheses. Only one Device Marking contained in parentheses and separated by a "-" will appear on a device. If a line is indented then it is a continuation of the previous line and the two combined represent the entire Device Marking for that device.

(6) Lead/Ball Finish - Orderable Devices may have multiple material finish options. Finish options are separated by a vertical ruled line. Lead/Ball Finish values may wrap to two lines if the finish value exceeds the maximum column width.

Important Information and Disclaimer:The information provided on this page represents TI's knowledge and belief as of the date that it is provided. TI bases its knowledge and belief on information provided by third parties, and makes no representation or warranty as to the accuracy of such information. Efforts are underway to better integrate information from third parties. TI has taken and

continues to take reasonable steps to provide representative and accurate information but may not have conducted destructive testing or chemical analysis on incoming materials and chemicals. TI and TI suppliers consider certain information to be proprietary, and thus CAS numbers and other limited information may not be available for release.

In no event shall TI's liability arising out of such information exceed the total purchase price of the TI part(s) at issue in this document sold by TI to Customer on an annual basis.

TAPE AND REEL INFORMATION



QUADRANT ASSIGNMENTS FOR PIN 1 ORIENTATION IN TAPE



*All dimensions are nominal

Device	Package Type	Package Drawing	Pins	SPQ	Reel Diameter (mm)	Reel Width W1 (mm)	A0 (mm)	B0 (mm)	K0 (mm)	P1 (mm)	W (mm)	Pin1 Quadrant
SN65LVEP11DGKR	VSSOP	DGK	8	2500	330.0	12.4	5.3	3.4	1.4	8.0	12.0	Q1

TAPE AND REEL BOX DIMENSIONS



*All dimensions are nominal

Device	Package Type	Package Drawing	Pins	SPQ	Length (mm)	Width (mm)	Height (mm)
SN65LVEP11DGKR	VSSOP	DGK	8	2500	367.0	367.0	35.0



D0008A

PACKAGE OUTLINE

SOIC - 1.75 mm max height

SMALL OUTLINE INTEGRATED CIRCUIT



4214825/C 02/2019

NOTES:

1. Linear dimensions are in inches [millimeters]. Dimensions in parenthesis are for reference only. Controlling dimensions are in inches. Dimensioning and tolerancing per ASME Y14.5M.
2. This drawing is subject to change without notice.
3. This dimension does not include mold flash, protrusions, or gate burrs. Mold flash, protrusions, or gate burrs shall not exceed $.006$ [0.15] per side.
4. This dimension does not include interlead flash.
5. Reference JEDEC registration MS-012, variation AA.

EXAMPLE BOARD LAYOUT

D0008A

SOIC - 1.75 mm max height

SMALL OUTLINE INTEGRATED CIRCUIT



LAND PATTERN EXAMPLE
 EXPOSED METAL SHOWN
 SCALE:8X



SOLDER MASK DETAILS

4214825/C 02/2019

NOTES: (continued)

- 6. Publication IPC-7351 may have alternate designs.
- 7. Solder mask tolerances between and around signal pads can vary based on board fabrication site.

EXAMPLE STENCIL DESIGN

D0008A

SOIC - 1.75 mm max height

SMALL OUTLINE INTEGRATED CIRCUIT



SOLDER PASTE EXAMPLE
BASED ON .005 INCH [0.125 MM] THICK STENCIL
SCALE:8X

4214825/C 02/2019

NOTES: (continued)

8. Laser cutting apertures with trapezoidal walls and rounded corners may offer better paste release. IPC-7525 may have alternate design recommendations.
9. Board assembly site may have different recommendations for stencil design.

DGK (S-PDSO-G8)

PLASTIC SMALL-OUTLINE PACKAGE



4073329/E 05/06

- NOTES:
- A. All linear dimensions are in millimeters.
 - B. This drawing is subject to change without notice.
 - C. Body length does not include mold flash, protrusions, or gate burrs. Mold flash, protrusions, or gate burrs shall not exceed 0.15 per end.
 - D. Body width does not include interlead flash. Interlead flash shall not exceed 0.50 per side.
 - E. Falls within JEDEC MO-187 variation AA, except interlead flash.



- NOTES:
- A. All linear dimensions are in millimeters.
 - B. This drawing is subject to change without notice.
 - C. Publication IPC-7351 is recommended for alternate designs.
 - D. Laser cutting apertures with trapezoidal walls and also rounding corners will offer better paste release. Customers should contact their board assembly site for stencil design recommendations. Refer to IPC-7525 for other stencil recommendations.
 - E. Customers should contact their board fabrication site for solder mask tolerances between and around signal pads.

IMPORTANT NOTICE AND DISCLAIMER

TI PROVIDES TECHNICAL AND RELIABILITY DATA (INCLUDING DATASHEETS), DESIGN RESOURCES (INCLUDING REFERENCE DESIGNS), APPLICATION OR OTHER DESIGN ADVICE, WEB TOOLS, SAFETY INFORMATION, AND OTHER RESOURCES "AS IS" AND WITH ALL FAULTS, AND DISCLAIMS ALL WARRANTIES, EXPRESS AND IMPLIED, INCLUDING WITHOUT LIMITATION ANY IMPLIED WARRANTIES OF MERCHANTABILITY, FITNESS FOR A PARTICULAR PURPOSE OR NON-INFRINGEMENT OF THIRD PARTY INTELLECTUAL PROPERTY RIGHTS.

These resources are intended for skilled developers designing with TI products. You are solely responsible for (1) selecting the appropriate TI products for your application, (2) designing, validating and testing your application, and (3) ensuring your application meets applicable standards, and any other safety, security, or other requirements. These resources are subject to change without notice. TI grants you permission to use these resources only for development of an application that uses the TI products described in the resource. Other reproduction and display of these resources is prohibited. No license is granted to any other TI intellectual property right or to any third party intellectual property right. TI disclaims responsibility for, and you will fully indemnify TI and its representatives against, any claims, damages, costs, losses, and liabilities arising out of your use of these resources.

TI's products are provided subject to TI's Terms of Sale (www.ti.com/legal/termsofsale.html) or other applicable terms available either on ti.com or provided in conjunction with such TI products. TI's provision of these resources does not expand or otherwise alter TI's applicable warranties or warranty disclaimers for TI products.

Mailing Address: Texas Instruments, Post Office Box 655303, Dallas, Texas 75265
Copyright © 2020, Texas Instruments Incorporated