

FEATURES

- Members of the Texas Instruments Widebus™ Family
- Output Ports Have Equivalent 22-Ω Series Resistors, So No External Resistors Are Required
- Support Mixed-Mode Signal Operation (5-V Input and Output Voltages With 3.3-V V_{CC})
- Support Unregulated Battery Operation Down to 2.7 V
- Typical V_{OLP} (Output Ground Bounce) <0.8 V at V_{CC} = 3.3 V, T_A = 25°C
- I_{off} and Power-Up 3-State Support Hot Insertion
- Bus Hold on Data Inputs Eliminates the Need for External Pullup/Pulldown Resistors
- Distributed V_{CC} and GND Pins Minimize High-Speed Switching Noise
- Flow-Through Architecture Optimizes PCB Layout
- Latch-Up Performance Exceeds 500 mA Per JESD 17
- ESD Protection Exceeds JESD 22
 - 2000-V Human-Body Model (A114-A)
 - 200-V Machine Model (A115-A)

SN54LVTH162374... WD PACKAGE
SN74LVTH162374... DGG OR DL PACKAGE
(TOP VIEW)

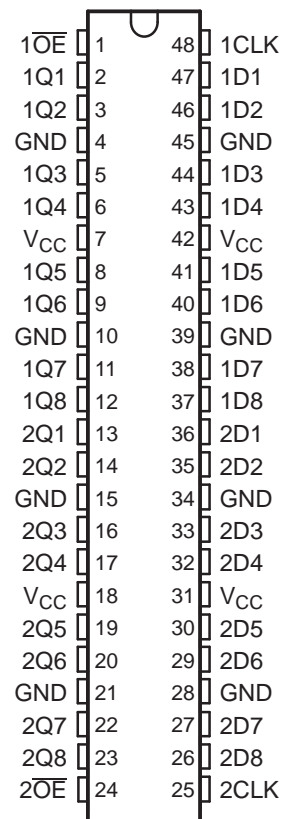

DESCRIPTION/ORDERING INFORMATION

ORDERING INFORMATION

T _A	PACKAGE ⁽¹⁾		ORDERABLE PART NUMBER	TOP-SIDE MARKING
-40°C to 85°C	FBGA – GRD	Reel of 1000	74LVTH162374GRDR	LL2374
	FBGA – ZRD (Pb-free)		74LVTH162374ZRDR	
	SSOP – DL	Tube of 25	SN74LVTH162374DL	LVTH162374
			SN74LVTH162374DLG4	
		Reel of 1000	74LVTH16374DLRG4 SN74LVTH16374DLR	
	TSSOP – DGG	Reel of 2000	SN74LVTH162374DGGR 74LVTH162374DGGRG4	LVTH162374
VFBGA – GQL	Reel of 1000	SN74LVTH162374GQLR	LL2374	
		74LVTH162374ZQLR		
-55°C to 125°C	CFP – WD	Tube	SNJ54LVTH162374WD	SNJ54LVTH162374WD

(1) Package drawings, standard packing quantities, thermal data, symbolization, and PCB design guidelines are available at www.ti.com/sc/package.



Please be aware that an important notice concerning availability, standard warranty, and use in critical applications of Texas Instruments semiconductor products and disclaimers thereto appears at the end of this data sheet.

Widebus is a trademark of Texas Instruments.

SN54LVTH162374, SN74LVTH162374

3.3-V ABT 16-BIT EDGE-TRIGGERED D-TYPE FLIP-FLOPS WITH 3-STATE OUTPUTS

SCBS262M–JULY 1993–REVISED NOVEMBER 2006

DESCRIPTION/ORDERING INFORMATION (CONTINUED)

The LVTH162374 devices are 16-bit edge-triggered D-type flip-flops with 3-state outputs designed for low-voltage (3.3-V) V_{CC} operation, but with the capability to provide a TTL interface to a 5-V system environment. They are particularly suitable for implementing buffer registers, I/O ports, bidirectional bus drivers, and working registers.

These devices can be used as two 8-bit flip-flops or one 16-bit flip-flop. On the positive transition of the clock (CLK), the Q outputs of the flip-flop take on the logic levels set up at the D inputs.

A buffered output-enable (\overline{OE}) input can be used to place the eight outputs in either a normal logic state (high or low logic levels) or a high-impedance state. In the high-impedance state, the outputs neither load nor drive the bus lines significantly. The high-impedance state and the increased drive provide the capability to drive bus lines without need for interface or pullup components.

\overline{OE} does not affect internal operations of the flip-flop. Old data can be retained or new data can be entered while the outputs are in the high-impedance state.

The outputs, which are designed to source or sink up to 12 mA, include equivalent 22- Ω series resistors to reduce overshoot and undershoot.

Active bus-hold circuitry holds unused or undriven inputs at a valid logic state. Use of pullup or pulldown resistors with the bus-hold circuitry is not recommended.

When V_{CC} is between 0 and 1.5 V, the devices are in the high-impedance state during power up or power down. However, to ensure the high-impedance state above 1.5 V, \overline{OE} should be tied to V_{CC} through a pullup resistor; the minimum value of the resistor is determined by the current-sinking capability of the driver.

These devices are fully specified for hot-insertion applications using I_{off} and power-up 3-state. The I_{off} circuitry disables the outputs, preventing damaging current backflow through the devices when they are powered down. The power-up 3-state circuitry places the outputs in the high-impedance state during power up and power down, which prevents driver conflict.

**GQL OR ZQL PACKAGE
(TOP VIEW)**

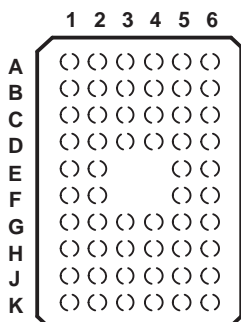

**TERMINAL ASSIGNMENTS⁽¹⁾
(56-Ball GQL/ZQL Package)**

	1	2	3	4	5	6
A	1 \overline{OE}	NC	NC	NC	NC	1CLK
B	1Q2	1Q1	GND	GND	1D1	1D2
C	1Q4	1Q3	V _{CC}	V _{CC}	1D3	1D4
D	1Q6	1Q5	GND	GND	1D5	1D6
E	1Q8	1Q7			1D7	1D8
F	2Q1	2Q2			2D2	2D1
G	2Q3	2Q4	GND	GND	2D4	2D3
H	2Q5	2Q6	V _{CC}	V _{CC}	2D6	2D5
J	2Q7	2Q8	GND	GND	2D8	2D7
K	2 \overline{OE}	NC	NC	NC	NC	2CLK

(1) NC – No internal connection

**GRD OR ZRD PACKAGE
(TOP VIEW)**

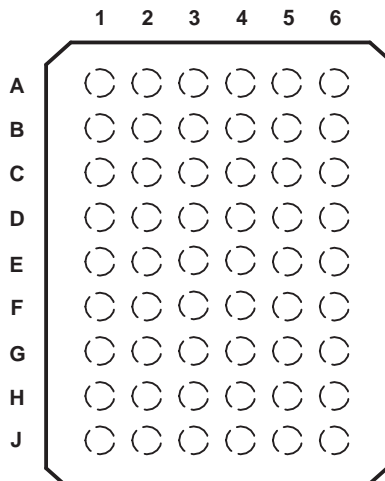

**TERMINAL ASSIGNMENTS⁽¹⁾
(54-Ball GRD/ZRD Package)**

	1	2	3	4	5	6
A	1Q1	NC	1 \overline{OE}	1CLK	NC	1D1
B	1Q3	1Q2	NC	NC	1D2	1D3
C	1Q5	1Q4	V _{CC}	V _{CC}	1D4	1D5
D	1Q7	1Q6	GND	GND	1D6	1D7
E	2Q1	1Q8	GND	GND	1D8	2D1
F	2Q3	2Q2	GND	GND	2D2	2D3
G	2Q5	2Q4	V _{CC}	V _{CC}	2D4	2D5
H	2Q7	2Q6	NC	NC	2D6	2D7
J	2Q8	NC	2 \overline{OE}	2CLK	NC	2D8

(1) NC – No internal connection

**FUNCTION TABLE
(EACH FLIP-FLOP)**

INPUTS			OUTPUT Q
\overline{OE}	CLK	D	
L	↑	H	H
L	↑	L	L
L	H or L	X	Q ₀
H	X	X	Z

SN54LVTH162374, SN74LVTH162374

3.3-V ABT 16-BIT EDGE-TRIGGERED D-TYPE FLIP-FLOPS WITH 3-STATE OUTPUTS

SCBS262M—JULY 1993—REVISED NOVEMBER 2006

LOGIC DIAGRAM (POSITIVE LOGIC)

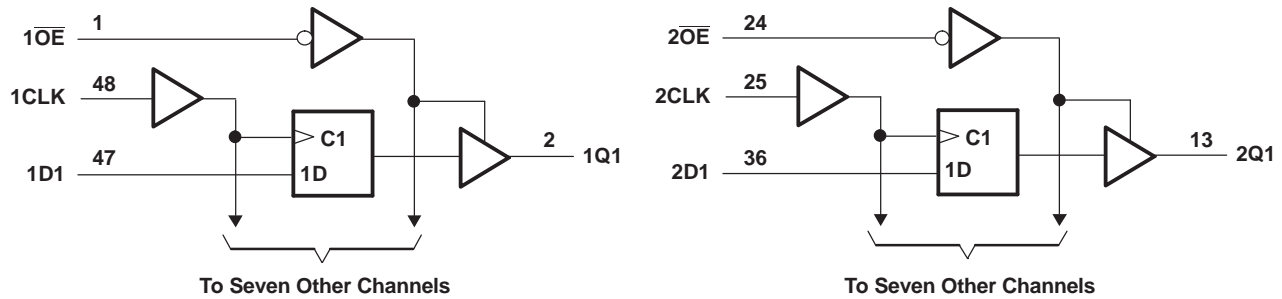

Pin numbers shown are for the DGG, DL, and WD packages.

Absolute Maximum Ratings⁽¹⁾

over operating free-air temperature range (unless otherwise noted)

		MIN	MAX	UNIT
V_{CC}	Supply voltage range	-0.5	4.6	V
V_I	Input voltage range ⁽²⁾	-0.5	7	V
V_O	Voltage range applied to any output in the high-impedance or power-off state ⁽²⁾	-0.5	7	V
V_O	Voltage range applied to any output in the high state ⁽²⁾	-0.5	$V_{CC} + 0.5$	V
I_O	Current into any output in the low state		30	mA
I_O	Current into any output in the high state ⁽³⁾		30	mA
I_{IK}	Input clamp current	$V_I < 0$	-50	mA
I_{OK}	Output clamp current	$V_O < 0$	-50	mA
θ_{JA}	Package thermal impedance ⁽⁴⁾	DGG package	70	°C/W
		DL package	63	
		GQL/ZQL package	42	
		GRD/ZRD package	36	
T_{stg}	Storage temperature range	-65	150	°C

- (1) Stresses beyond those listed under "absolute maximum ratings" may cause permanent damage to the device. These are stress ratings only, and functional operation of the device at these or any other conditions beyond those indicated under "recommended operating conditions" is not implied. Exposure to absolute-maximum-rated conditions for extended periods may affect device reliability.
- (2) The input and output negative-voltage ratings may be exceeded if the input and output clamp-current ratings are observed.
- (3) This current flows only when the output is in the high state and $V_O > V_{CC}$.
- (4) The package thermal impedance is calculated in accordance with JESD 51-7.

Recommended Operating Conditions⁽¹⁾

		SN54LVTH162374		SN74LVTH162374		UNIT
		MIN	MAX	MIN	MAX	
V_{CC}	Supply voltage	2.7	3.6	2.7	3.6	V
V_{IH}	High-level input voltage	2		2		V
V_{IL}	Low-level input voltage		0.8		0.8	V
V_I	Input voltage		5.5		5.5	V
I_{OH}	High-level output current		-12		-12	mA
I_{OL}	Low-level output current		12		12	mA
$\Delta t/\Delta v$	Input transition rise or fall rate		10		10	ns/V
	Outputs enabled					
$\Delta t/\Delta V_{CC}$	Power-up ramp rate	200		200		μs/V
T_A	Operating free-air temperature	-55	125	-40	85	°C

- (1) All unused control inputs of the device must be held at V_{CC} or GND to ensure proper device operation. Refer to the TI application report, *Implications of Slow or Floating CMOS Inputs*, literature number SCBA004.

Electrical Characteristics

over recommended operating free-air temperature range (unless otherwise noted)

PARAMETER	TEST CONDITIONS		SN54LVTH162374		SN74LVTH162374		UNIT
			MIN	TYP ⁽¹⁾	MAX	MIN	
V_{IK}	$V_{CC} = 2.7\text{ V}$,	$I_I = -18\text{ mA}$			-1.2	-1.2	V
V_{OH}	$V_{CC} = 3\text{ V}$,	$I_{OH} = -12\text{ mA}$	2		2		V
V_{OL}	$V_{CC} = 3\text{ V}$,	$I_{OL} = 12\text{ mA}$			0.8	0.8	V
I_I	Control inputs	$V_{CC} = 0\text{ or }3.6\text{ V}$,	$V_I = 5.5\text{ V}$		10	10	μA
		$V_{CC} = 3.6\text{ V}$,	$V_I = V_{CC}\text{ or GND}$		± 1	± 1	
	Data inputs	$V_{CC} = 3.6\text{ V}$	$V_I = V_{CC}$	1	1		
			$V_I = 0$	-5	-5		
I_{off}	$V_{CC} = 0$,	$V_I\text{ or }V_O = 0\text{ to }4.5\text{ V}$				± 100	μA
$I_{I(\text{hold})}$	Data inputs	$V_{CC} = 3\text{ V}$	$V_I = 0.8\text{ V}$	75	75	μA	
			$V_I = 2\text{ V}$	-75	-75		
		$V_{CC} = 3.6\text{ V}$, ⁽²⁾	$V_I = 0\text{ to }3.6\text{ V}$			500 -750	
I_{OZH}	$V_{CC} = 3.6\text{ V}$,	$V_O = 3\text{ V}$			5	5	μA
I_{OZL}	$V_{CC} = 3.6\text{ V}$,	$V_O = 0.5\text{ V}$			-5	-5	μA
I_{OZPU}	$V_{CC} = 0\text{ to }1.5\text{ V}$, $V_O = 0.5\text{ V to }3\text{ V}$, $OE = \text{don't care}$				± 100 ⁽³⁾	± 100	μA
I_{OZPD}	$V_{CC} = 1.5\text{ V to }0$, $V_O = 0.5\text{ V to }3\text{ V}$, $OE = \text{don't care}$				± 100 ⁽³⁾	± 100	μA
I_{CC}	$V_{CC} = 3.6\text{ V}$, $I_O = 0$, $V_I = V_{CC}\text{ or GND}$	Outputs high			0.19	0.19	mA
		Outputs low			5	5	
		Outputs disabled			0.19	0.19	
ΔI_{CC} ⁽⁴⁾	$V_{CC} = 3\text{ V to }3.6\text{ V}$, One input at $V_{CC} - 0.6\text{ V}$, Other inputs at $V_{CC}\text{ or GND}$				0.2	0.2	mA
C_i	$V_I = 3\text{ V or }0$			3	3		pF
C_o	$V_O = 3\text{ V or }0$			9	9		pF

(1) All typical values are at $V_{CC} = 3.3\text{ V}$, $T_A = 25^\circ\text{C}$.

(2) This is the bus-hold maximum dynamic current. It is the minimum overdrive current required to switch the input from one state to another.

(3) On products compliant to MIL-PRF-38535, this parameter is not production tested.

(4) This is the increase in supply current for each input that is at the specified TTL voltage level, rather than V_{CC} or GND.

Timing Requirements

over recommended operating free-air temperature range (unless otherwise noted) (see Figure 1)

		SN54LVTH162374				SN74LVTH162374				UNIT	
		$V_{CC} = 3.3\text{ V} \pm 0.3\text{ V}$		$V_{CC} = 2.7\text{ V}$		$V_{CC} = 3.3\text{ V} \pm 0.3\text{ V}$		$V_{CC} = 2.7\text{ V}$			
		MIN	MAX	MIN	MAX	MIN	MAX	MIN	MAX		
f_{clock}	Clock frequency	160		160		160		160		MHz	
t_w	Pulse duration, CLK high or low	3		3.3		3		3		ns	
t_{su}	Setup time, data before CLK \uparrow	High or low		2.8		3.2		1.8		2	ns
t_h	Hold time, data after CLK \uparrow	High or low		1.2		0.5		0.8		0.1	ns

SN54LVTH162374, SN74LVTH162374

3.3-V ABT 16-BIT EDGE-TRIGGERED D-TYPE FLIP-FLOPS WITH 3-STATE OUTPUTS

SCBS262M–JULY 1993–REVISED NOVEMBER 2006

Switching Characteristics

over recommended operating free-air temperature range, $C_L = 50$ pF (unless otherwise noted) (see [Figure 1](#))

PARAMETER	FROM (INPUT)	TO (OUTPUT)	SN54LVTH162374				SN74LVTH162374				UNIT	
			$V_{CC} = 3.3$ V ± 0.3 V		$V_{CC} = 2.7$ V		$V_{CC} = 3.3$ V ± 0.3 V			$V_{CC} = 2.7$ V		
			MIN	MAX	MIN	MAX	MIN	TYP ⁽¹⁾	MAX	MIN		MAX
f_{max}			160		160		160			160	MHz	
t_{PLH}	CLK	Q	1.4	6.6	7.4		2	3.4	5.3	6.2		ns
t_{PHL}			1.4	5.8	6		2.2	3.3	4.9	5.1		
t_{PZH}	\overline{OE}	Q	1	6.6	7.4		1.8	3.5	5.6	6.9		ns
t_{PZL}			1.4	6	6.8		1.8	3.5	4.9	6		
t_{PHZ}	\overline{OE}	Q	1	6.6	7.4		2.4	4.2	5.4	5.7		ns
t_{PLZ}			1.4	6	6		2	3.8	5	5.1		
$t_{sk(LH)}$								0.5			ns	
$t_{sk(HL)}$								0.5				

(1) All typical values are at $V_{CC} = 3.3$ V, $T_A = 25^\circ\text{C}$.

PARAMETER MEASUREMENT INFORMATION

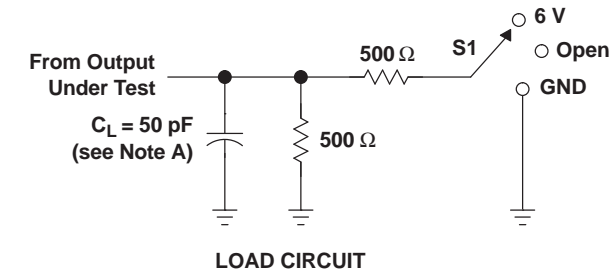

TEST	S1
t_{PLH}/t_{PHL}	Open
t_{PLZ}/t_{PZL}	6 V
t_{PHZ}/t_{PZH}	GND

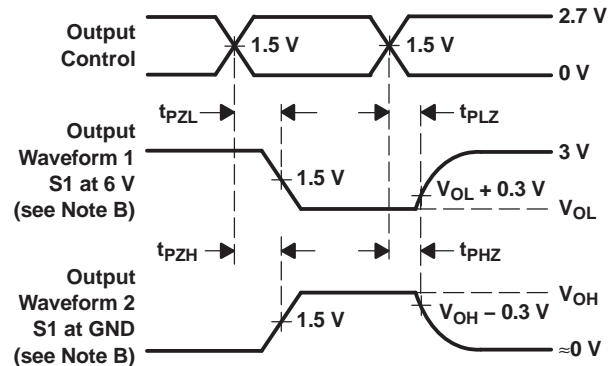
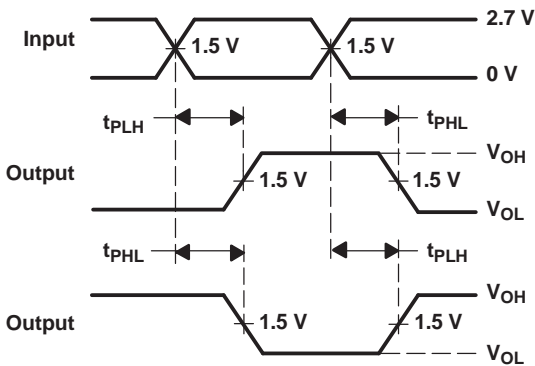
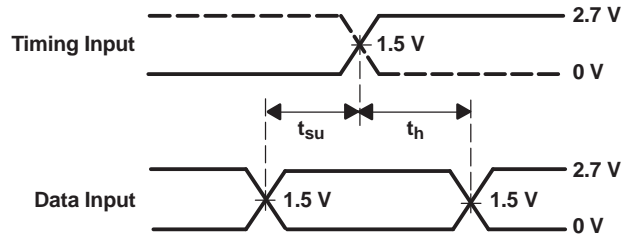
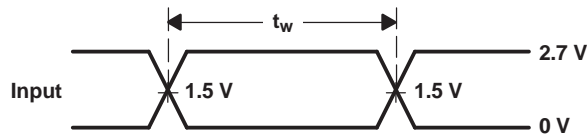

- NOTES: A. C_L includes probe and jig capacitance.
 B. Waveform 1 is for an output with internal conditions such that the output is low, except when disabled by the output control. Waveform 2 is for an output with internal conditions such that the output is high, except when disabled by the output control.
 C. All input pulses are supplied by generators having the following characteristics: $PRR \leq 10 \text{ MHz}$, $Z_O = 50 \Omega$, $t_r \leq 2.5 \text{ ns}$, $t_f \leq 2.5 \text{ ns}$.
 D. The outputs are measured one at a time, with one transition per measurement.

Figure 1. Load Circuit and Voltage Waveforms

PACKAGING INFORMATION

Orderable Device	Status (1)	Package Type	Package Drawing	Pins	Package Qty	Eco Plan (2)	Lead/Ball Finish (6)	MSL Peak Temp (3)	Op Temp (°C)	Device Marking (4/5)	Samples
5962-9854201VXA	ACTIVE	CFP	WD	48	1	TBD	A42	N / A for Pkg Type	-55 to 125	5962-9854201VX A SNV54LVTH16237 4WD	Samples
74LVTH162374ZQLR	ACTIVE	BGA MICROSTAR JUNIOR	ZQL	56	1000	Green (RoHS & no Sb/Br)	SNAGCU	Level-1-260C-UNLIM	-40 to 85	LL2374	Samples
74LVTH162374ZRDR	ACTIVE	BGA MICROSTAR JUNIOR	ZRD	54	1000	Green (RoHS & no Sb/Br)	SNAGCU	Level-1-260C-UNLIM	-40 to 85	LL2374	Samples
SN74LVTH162374DGGR	ACTIVE	TSSOP	DGG	48	2000	Green (RoHS & no Sb/Br)	CU NIPDAU	Level-1-260C-UNLIM	-40 to 85	LVTH162374	Samples
SN74LVTH162374DL	ACTIVE	SSOP	DL	48	25	Green (RoHS & no Sb/Br)	CU NIPDAU	Level-1-260C-UNLIM	-40 to 85	LVTH162374	Samples
SN74LVTH162374DLR	ACTIVE	SSOP	DL	48	1000	Green (RoHS & no Sb/Br)	CU NIPDAU	Level-1-260C-UNLIM	-40 to 85	LVTH162374	Samples
SNJ54LVTH162374WD	LIFEBUY	CFP	WD	48		TBD	Call TI	Call TI	-55 to 125	5962-9854201QX A SNJ54LVTH16237 4WD	

(1) The marketing status values are defined as follows:

ACTIVE: Product device recommended for new designs.

LIFEBUY: TI has announced that the device will be discontinued, and a lifetime-buy period is in effect.

NRND: Not recommended for new designs. Device is in production to support existing customers, but TI does not recommend using this part in a new design.

PREVIEW: Device has been announced but is not in production. Samples may or may not be available.

OBSELETE: TI has discontinued the production of the device.

(2) **RoHS:** TI defines "RoHS" to mean semiconductor products that are compliant with the current EU RoHS requirements for all 10 RoHS substances, including the requirement that RoHS substance do not exceed 0.1% by weight in homogeneous materials. Where designed to be soldered at high temperatures, "RoHS" products are suitable for use in specified lead-free processes. TI may reference these types of products as "Pb-Free".

RoHS Exempt: TI defines "RoHS Exempt" to mean products that contain lead but are compliant with EU RoHS pursuant to a specific EU RoHS exemption.

Green: TI defines "Green" to mean the content of Chlorine (Cl) and Bromine (Br) based flame retardants meet JS709B low halogen requirements of <=1000ppm threshold. Antimony trioxide based flame retardants must also meet the <=1000ppm threshold requirement.

(3) MSL, Peak Temp. - The Moisture Sensitivity Level rating according to the JEDEC industry standard classifications, and peak solder temperature.

(4) There may be additional marking, which relates to the logo, the lot trace code information, or the environmental category on the device.

(5) Multiple Device Markings will be inside parentheses. Only one Device Marking contained in parentheses and separated by a "~" will appear on a device. If a line is indented then it is a continuation of the previous line and the two combined represent the entire Device Marking for that device.

(6) Lead/Ball Finish - Orderable Devices may have multiple material finish options. Finish options are separated by a vertical ruled line. Lead/Ball Finish values may wrap to two lines if the finish value exceeds the maximum column width.

Important Information and Disclaimer:The information provided on this page represents TI's knowledge and belief as of the date that it is provided. TI bases its knowledge and belief on information provided by third parties, and makes no representation or warranty as to the accuracy of such information. Efforts are underway to better integrate information from third parties. TI has taken and continues to take reasonable steps to provide representative and accurate information but may not have conducted destructive testing or chemical analysis on incoming materials and chemicals. TI and TI suppliers consider certain information to be proprietary, and thus CAS numbers and other limited information may not be available for release.

In no event shall TI's liability arising out of such information exceed the total purchase price of the TI part(s) at issue in this document sold by TI to Customer on an annual basis.

OTHER QUALIFIED VERSIONS OF SN54LVTH162374, SN54LVTH162374-SP, SN74LVTH162374 :

- Catalog: [SN74LVTH162374](#), [SN54LVTH162374](#)
- Military: [SN54LVTH162374](#)
- Space: [SN54LVTH162374-SP](#)

NOTE: Qualified Version Definitions:

- Catalog - TI's standard catalog product
- Military - QML certified for Military and Defense Applications
- Space - Radiation tolerant, ceramic packaging and qualified for use in Space-based application

TAPE AND REEL INFORMATION

QUADRANT ASSIGNMENTS FOR PIN 1 ORIENTATION IN TAPE

*All dimensions are nominal

Device	Package Type	Package Drawing	Pins	SPQ	Reel Diameter (mm)	Reel Width W1 (mm)	A0 (mm)	B0 (mm)	K0 (mm)	P1 (mm)	W (mm)	Pin1 Quadrant
74LVTH162374ZQLR	BGA MICROSTAR JUNIOR	ZQL	56	1000	330.0	16.4	4.8	7.3	1.5	8.0	16.0	Q1
74LVTH162374ZRDR	BGA MICROSTAR JUNIOR	ZRD	54	1000	330.0	16.4	5.8	8.3	1.55	8.0	16.0	Q1
SN74LVTH162374DGGR	TSSOP	DGG	48	2000	330.0	24.4	8.6	13.0	1.8	12.0	24.0	Q1
SN74LVTH162374DLR	SSOP	DL	48	1000	330.0	32.4	11.35	16.2	3.1	16.0	32.0	Q1

TAPE AND REEL BOX DIMENSIONS



*All dimensions are nominal

Device	Package Type	Package Drawing	Pins	SPQ	Length (mm)	Width (mm)	Height (mm)
74LVTH162374ZQLR	BGA MICROSTAR JUNIOR	ZQL	56	1000	350.0	350.0	43.0
74LVTH162374ZRDR	BGA MICROSTAR JUNIOR	ZRD	54	1000	350.0	350.0	43.0
SN74LVTH162374DGGR	TSSOP	DGG	48	2000	367.0	367.0	45.0
SN74LVTH162374DLR	SSOP	DL	48	1000	367.0	367.0	55.0

DGG (R-PDSO-G**)

PLASTIC SMALL-OUTLINE PACKAGE

48 PINS SHOWN



- NOTES: A. All linear dimensions are in millimeters.
 B. This drawing is subject to change without notice.
 C. Body dimensions do not include mold protrusion not to exceed 0,15.
 D. Falls within JEDEC MO-153

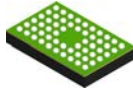

ZQL0056A

PACKAGE OUTLINE

JRBGA - 1 mm max height

PLASTIC BALL GRID ARRAY

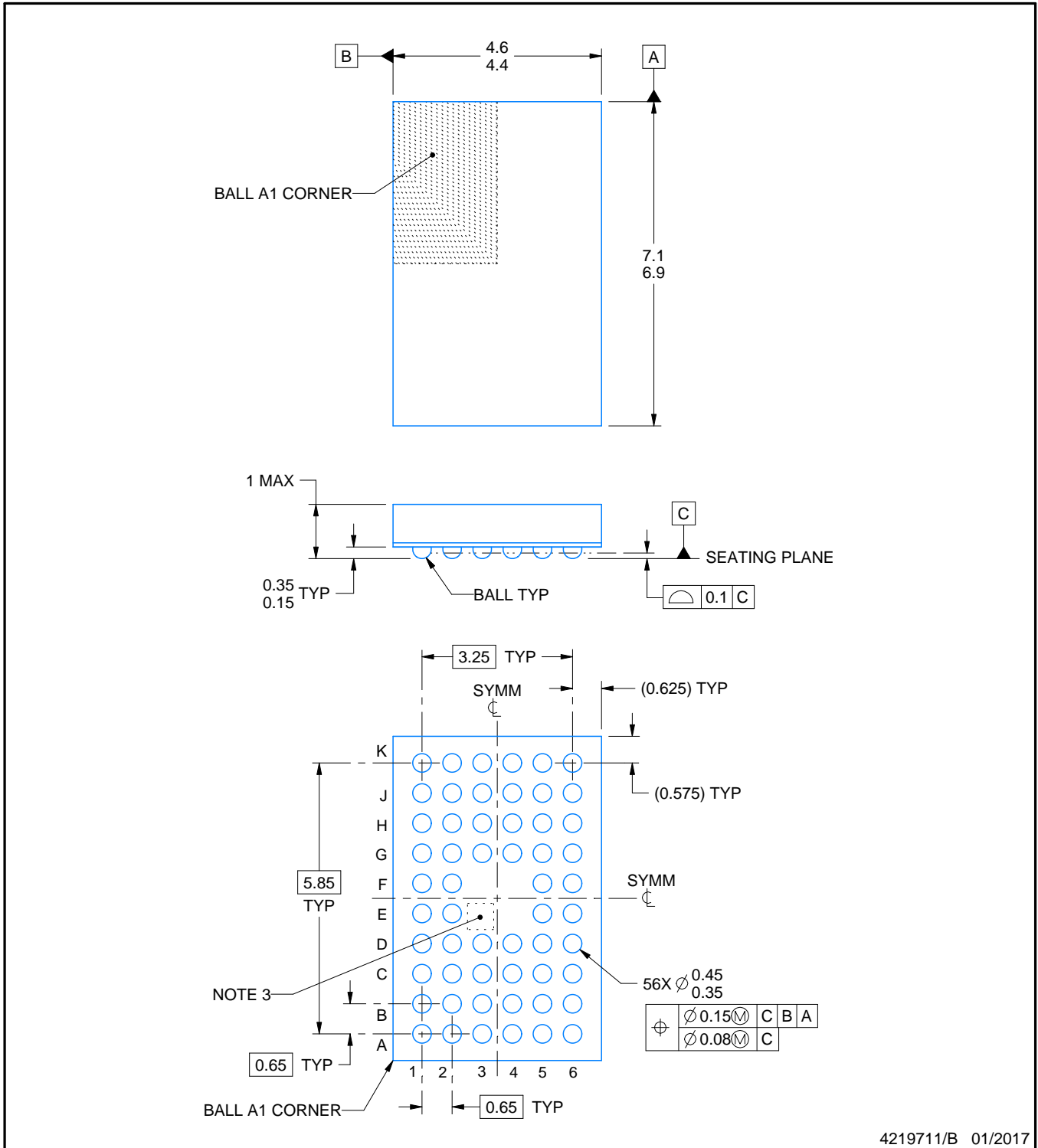

4219711/B 01/2017

NOTES:

1. All linear dimensions are in millimeters. Any dimensions in parenthesis are for reference only. Dimensioning and tolerancing per ASME Y14.5M.
2. This drawing is subject to change without notice.
3. No metal in this area, indicates orientation.

EXAMPLE BOARD LAYOUT

ZQL0056A

JRBGA - 1 mm max height

PLASTIC BALL GRID ARRAY

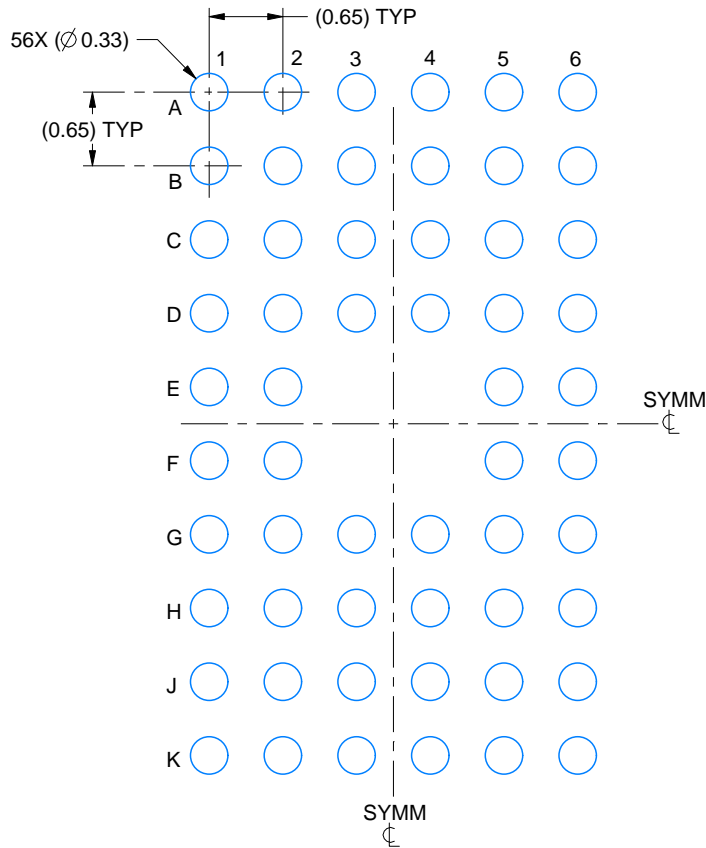

LAND PATTERN EXAMPLE
EXPOSED METAL SHOWN
SCALE:15X

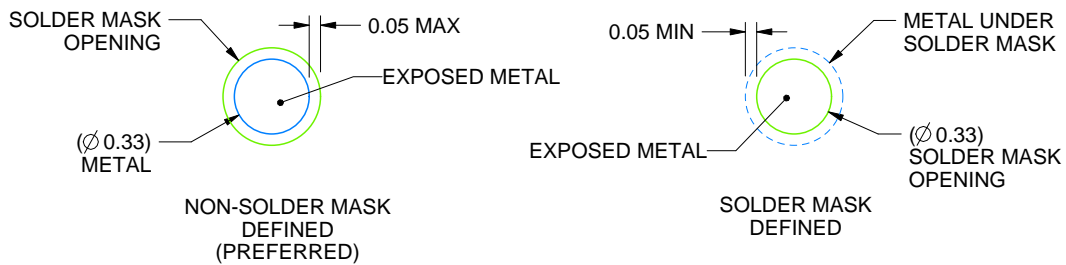

SOLDER MASK DETAILS
NOT TO SCALE

4219711/B 01/2017

NOTES: (continued)

- Final dimensions may vary due to manufacturing tolerance considerations and also routing constraints. For information, see Texas Instruments literature number SPRAA99 (www.ti.com/lit/spraa99).

EXAMPLE STENCIL DESIGN

ZQL0056A

JRBGA - 1 mm max height

PLASTIC BALL GRID ARRAY

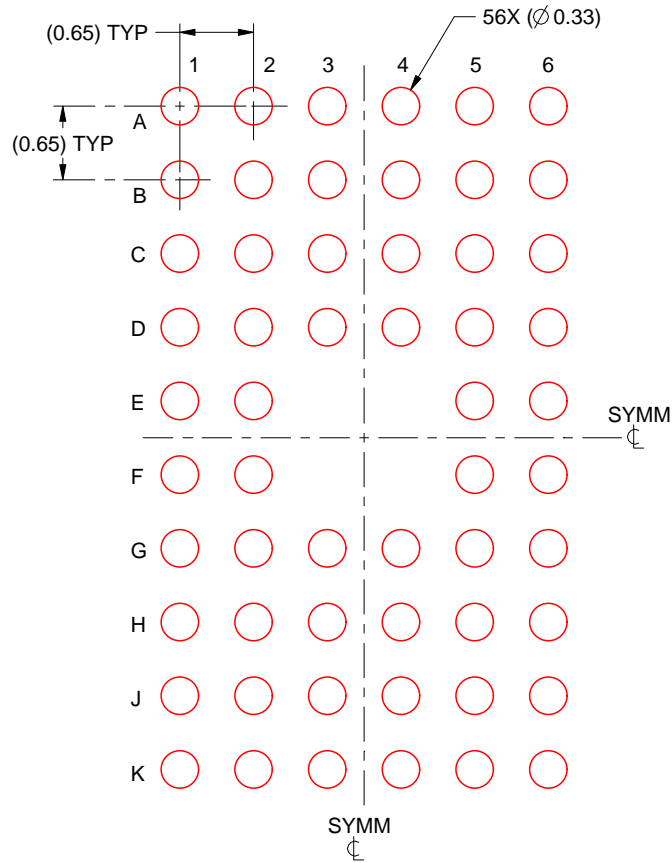

SOLDER PASTE EXAMPLE
BASED ON 0.125 mm THICK STENCIL
SCALE:15X

4219711/B 01/2017

NOTES: (continued)

5. Laser cutting apertures with trapezoidal walls and rounded corners may offer better paste release.

WD (R-GDFP-F**)

CERAMIC DUAL FLATPACK

48 LEADS SHOWN

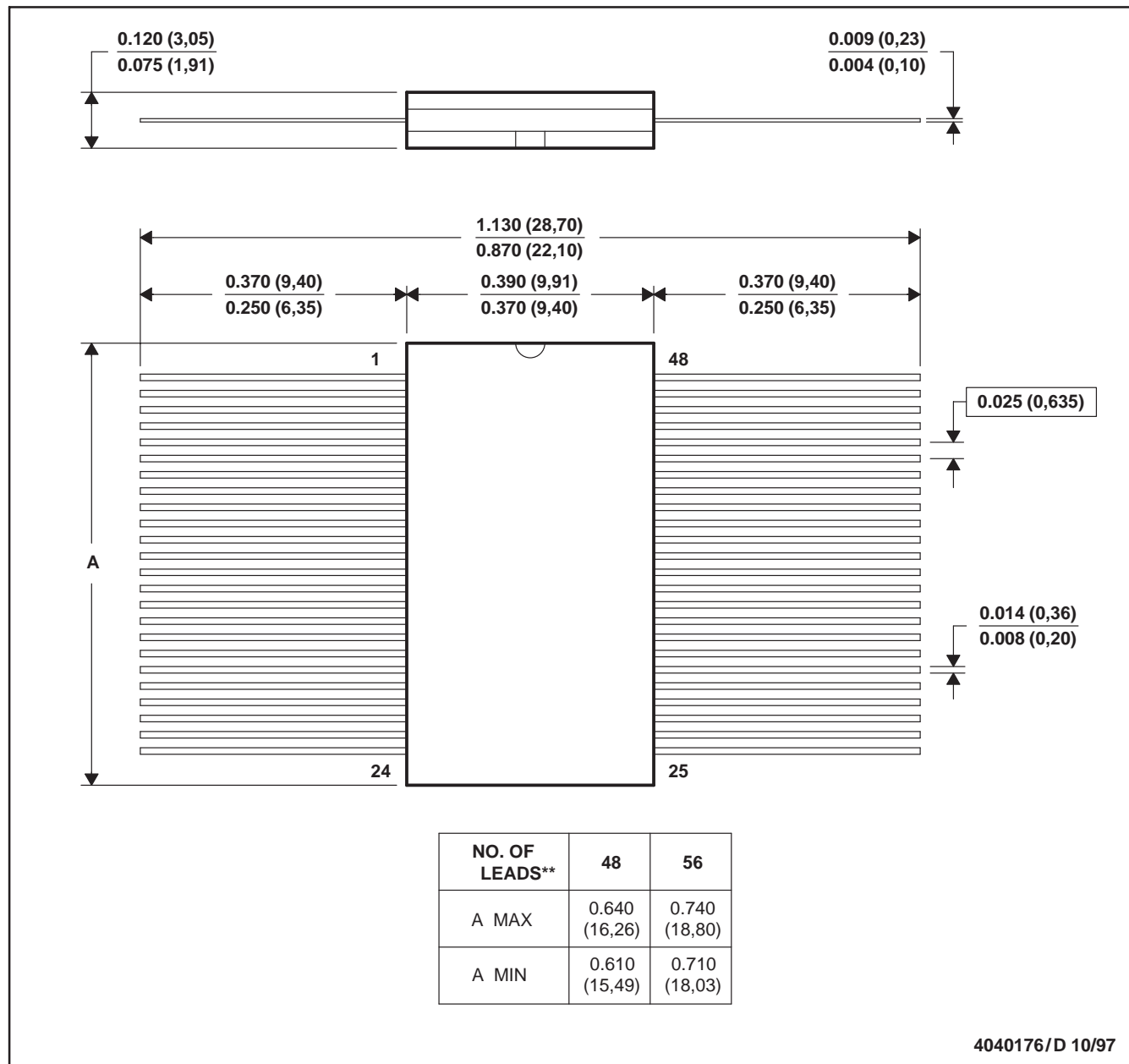

- NOTES: A. All linear dimensions are in inches (millimeters).
 B. This drawing is subject to change without notice.
 C. This package can be hermetically sealed with a ceramic lid using glass frit.
 D. Index point is provided on cap for terminal identification only
 E. Falls within MIL STD 1835: GDFP1-F48 and JEDEC MO-146AA
 GDFP1-F56 and JEDEC MO-146AB

ZRD (R-PBGA-N54)

PLASTIC BALL GRID ARRAY



4204760/B 06/04

- NOTES:
- A. All linear dimensions are in millimeters.
 - B. This drawing is subject to change without notice.
 - C. Falls within JEDEC MO-205 variation DD.
 - D. This package is lead-free. Refer to the 54 GRD package (drawing 4204759) for tin-lead (SnPb).

MECHANICAL DATA

DL (R-PDSO-G48)

PLASTIC SMALL-OUTLINE PACKAGE



- NOTES:
- All linear dimensions are in inches (millimeters).
 - This drawing is subject to change without notice.
 - Body dimensions do not include mold flash or protrusion not to exceed 0.006 (0,15).
 - Falls within JEDEC MO-118

PowerPAD is a trademark of Texas Instruments.

IMPORTANT NOTICE AND DISCLAIMER

TI PROVIDES TECHNICAL AND RELIABILITY DATA (INCLUDING DATASHEETS), DESIGN RESOURCES (INCLUDING REFERENCE DESIGNS), APPLICATION OR OTHER DESIGN ADVICE, WEB TOOLS, SAFETY INFORMATION, AND OTHER RESOURCES "AS IS" AND WITH ALL FAULTS, AND DISCLAIMS ALL WARRANTIES, EXPRESS AND IMPLIED, INCLUDING WITHOUT LIMITATION ANY IMPLIED WARRANTIES OF MERCHANTABILITY, FITNESS FOR A PARTICULAR PURPOSE OR NON-INFRINGEMENT OF THIRD PARTY INTELLECTUAL PROPERTY RIGHTS.

These resources are intended for skilled developers designing with TI products. You are solely responsible for (1) selecting the appropriate TI products for your application, (2) designing, validating and testing your application, and (3) ensuring your application meets applicable standards, and any other safety, security, or other requirements. These resources are subject to change without notice. TI grants you permission to use these resources only for development of an application that uses the TI products described in the resource. Other reproduction and display of these resources is prohibited. No license is granted to any other TI intellectual property right or to any third party intellectual property right. TI disclaims responsibility for, and you will fully indemnify TI and its representatives against, any claims, damages, costs, losses, and liabilities arising out of your use of these resources.

TI's products are provided subject to TI's Terms of Sale (www.ti.com/legal/termsofsale.html) or other applicable terms available either on ti.com or provided in conjunction with such TI products. TI's provision of these resources does not expand or otherwise alter TI's applicable warranties or warranty disclaimers for TI products.

Mailing Address: Texas Instruments, Post Office Box 655303, Dallas, Texas 75265
Copyright © 2019, Texas Instruments Incorporated