

DUAL HOT SWAP POWER CONTROLLERS WITH INDEPENDENT CIRCUIT BREAKER

Check for Samples: [TPS2320](#), [TPS2321](#)

FEATURES

- Dual-Channel High-Side MOSFET Drivers
- IN1: 3 V to 13 V; IN2: 3 V to 5.5 V
- Output dV/dt Control Limits Inrush Current
- Independent Circuit-Breaker With Programmable Overcurrent Threshold and Transient Timer
- CMOS- and TTL-Compatible Enable Input
- Low, 5- μ A Standby Supply Current (Max)
- Available in 16-Pin SOIC and TSSOP Package
- -40°C to 85°C Ambient Temperature Range
- Electrostatic Discharge Protection

APPLICATIONS

- Hot-Swap/Plug/Dock Power Management
- Hot-Plug PCI, Device Bay
- Electronic Circuit Breaker

DESCRIPTION

The TPS2320 and TPS2321 are dual-channel hot-swap controllers that use external N-channel MOSFETs as high-side switches in power applications. Features of these devices, such as overcurrent protection (OCP), inrush-current control, and the ability to discriminate between load transients and faults, are critical requirements for hot-swap applications.

The TPS2320/21 devices incorporate undervoltage lockout (UVLO) to ensure the device is off at startup. Each internal charge pump, capable of driving multiple MOSFETs, provides enough gate-drive voltage to fully enhance the N-channel MOSFETs. The charge pumps control both the rise times and fall times (dv/dt) of the MOSFETs, reducing power transients during power up/down. The circuit-breaker functionality combines the ability to sense overcurrent conditions with a timer function; this allows designs such as DSPs, that may have high peak currents during power-state transitions, to disregard transients for a programmable period.

Table 1. AVAILABLE OPTIONS

T _A	HOT-SWAP CONTROLLER DESCRIPTION	PIN COUNT	PACKAGES	
			ENABLE	ENABLE
-40°C to 85°C	Dual-channel with independent OCP and adjustable PG	20	TPS2300IPW	TPS2301IPW
	Dual-channel with interdependent OCP and adjustable PG	20	TPS2310IPW	TPS2311IPW
	Dual-channel with independent OCP	16	TPS2320ID TPS2320IPW	TPS2321ID TPS2321IPW
	Single-channel with OCP and adjustable PG	14	TPS2330ID TPS2330IPW	TPS2331ID TPS2331IPW

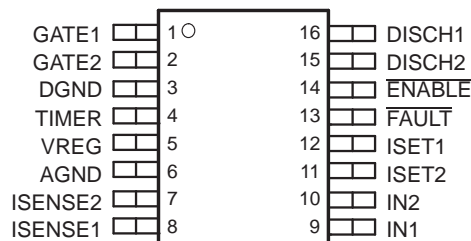
**D OR PW PACKAGE
(TOP VIEW)**

NOTE: Terminal 14 is active-high on TPS2321.

typical application

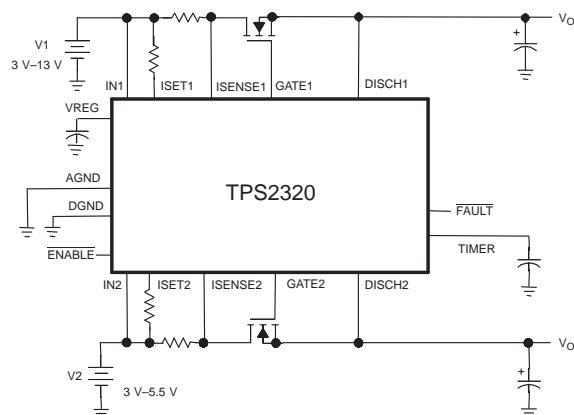

Please be aware that an important notice concerning availability, standard warranty, and use in critical applications of Texas Instruments semiconductor products and disclaimers thereto appears at the end of this data sheet.

FUNCTIONAL BLOCK DIAGRAM

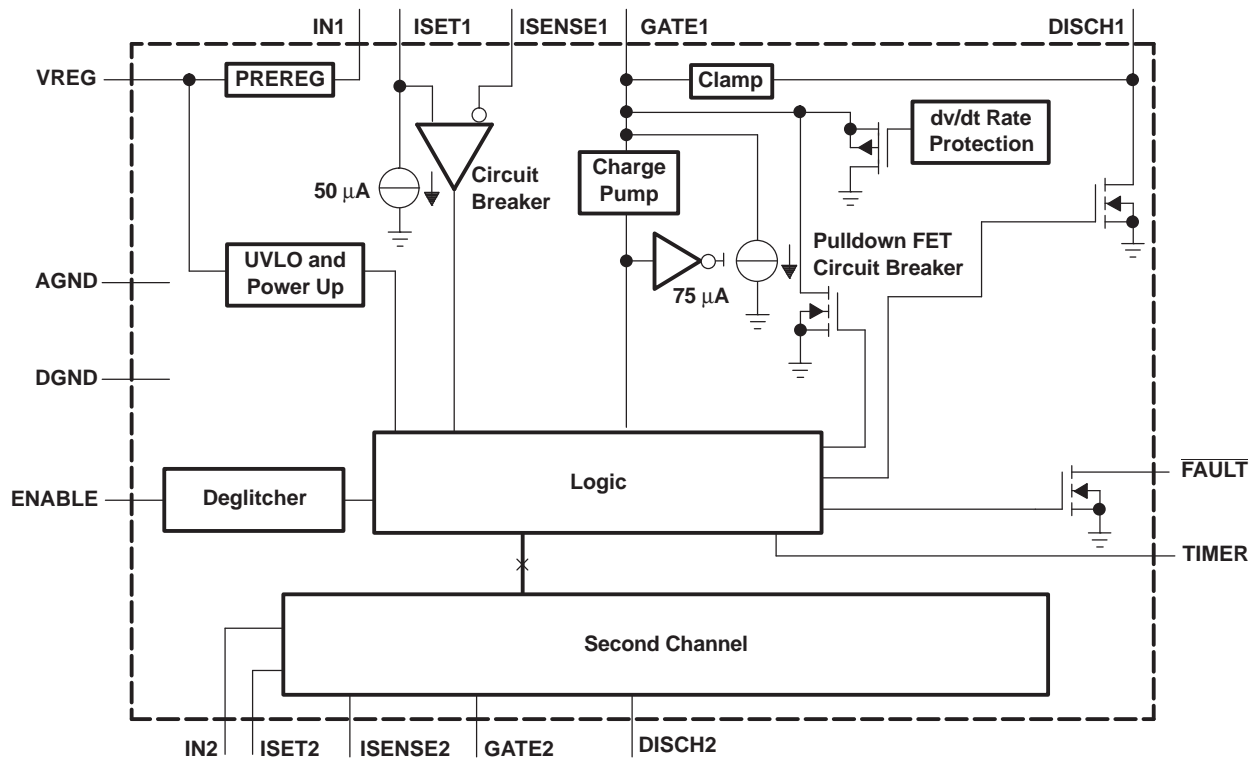

Table 2. Terminal Functions

TERMINAL NAME	NO.	I/O	DESCRIPTION
AGND	6	I	Analog ground, connects to DGND as close as possible
DGND	3	I	Digital ground
DISCH1	16	O	Discharge transistor 1
DISCH2	15	O	Discharge transistor 2
ENABLE/ENABLE	14	I	Active low (TPS2320) or active high enable (TPS2321)
FAULT	13	O	Overcurrent fault, open-drain output
GATE1	1	O	Connects to gate of channel 1 high-side MOSFET
GATE2	2	O	Connects to gate of channel 2 high-side MOSFET
IN1	9	I	Input voltage for channel 1
IN2	10	I	Input voltage for channel 2
ISENSE1	8	I	Current-sense input channel 1
ISENSE2	7	I	Current-sense input channel 2
ISET1	12	I	Adjusts circuit-breaker threshold with resistor connected to IN1
ISET2	11	I	Adjusts circuit-breaker threshold with resistor connected to IN2
TIMER	4	O	Adjusts circuit-breaker deglitch time
VREG	5	O	Connects to bypass capacitor, for stable operation

DETAILED DESCRIPTION

DISCH1, DISCH2 – DISCH1 and DISCH2 should be connected to the sources of the external N-channel MOSFET transistors connected to GATE1 and GATE2, respectively. These pins discharge the loads when the MOSFET transistors are disabled. They also serve as reference-voltage connections for internal gate voltage-clamp circuitry.

ENABLE or ENABLE – $\overline{\text{ENABLE}}$ for TPS2320 is active low. ENABLE for TPS2321 is active high. When the controller is enabled, both GATE1 and GATE2 voltages will power up to turn on the external MOSFETs. When the ENABLE pin is pulled high for TPS2320 or the ENABLE pin is pulled low for TPS2321 for more than 50 μs , the gate of the MOSFET is discharged at a controlled rate by a current source, and a transistor is enabled to discharge the output bulk capacitance. In addition, the device turns on the internal regulator PREREG (see VREG) when enabled and shuts down PREREG when disabled so that total supply current is much less than 5 μA .

FAULT – $\overline{\text{FAULT}}$ is an open-drain overcurrent flag output. When an overcurrent condition in either channel is sustained long enough to charge TIMER to 0.5 V, the overcurrent channel latches off and pulls FAULT low. The other channel will run normally if not in overcurrent. In order to turn the channel back on, either the enable pin has to be toggled or the input power has to be cycled.

GATE1, GATE2 – GATE1 and GATE2 connect to the gates of external N-channel MOSFET transistors. When the device is enabled, internal charge-pump circuitry pulls these pins up by sourcing approximately 15 μA to each. The turnon slew rates depend upon the capacitance present at the GATE1 and GATE2 terminals. If desired, the turnon slew rates can be further reduced by connecting capacitors between these pins and ground. These capacitors also reduce inrush current and protect the device from false overcurrent triggering during power up. The charge-pump circuitry will generate gate-to-source voltages of 9 V-12 V across the external MOSFET transistors.

IN1, IN2 – IN1 and IN2 should be connected to the power sources driving the external N-channel MOSFET transistors connected to GATE1 and GATE2, respectively. The TPS2320/TPS2321 draws its operating current from IN1, and both channels will remain disabled until the IN1 power supply has been established. The IN1 channel has been constructed to support 3-V, 5-V, or 12-V operation, while the IN2 channel has been constructed to support 3-V or 5-V operation

ISENSE1, ISENSE2, ISET1, ISET2 – ISENSE1 and ISENSE2, in combination with ISET1 and ISET2, implement overcurrent sensing for GATE1 and GATE2. ISET1 and ISET2 set the magnitude of the current that generates an overcurrent fault, through external resistors connected to ISET1 and ISET2. An internal current source draws 50 μA from ISET1 and ISET2. With a sense resistor from IN1 to ISENSE1 or from IN2 to ISENSE2, which is also connected to the drains of external MOSFETs, the voltage on the sense resistor reflects the load current. An overcurrent condition is assumed to exist if ISENSE1 is pulled below ISET1 or if ISENSE2 is pulled below ISET2. To ensure proper circuit breaker operation, $V_{I(\text{ISENSE1})}$ and $V_{I(\text{ISET1})}$ should never exceed $V_{I(\text{IN1})}$. Similarly, $V_{I(\text{ISENSE2})}$ and $V_{I(\text{ISET2})}$ should never exceed $V_{I(\text{IN2})}$.

TIMER – A capacitor on TIMER sets the time during which the power switch can be in overcurrent before turning off. When the overcurrent protection circuits sense an excessive current, a current source is enabled which charges the capacitor on TIMER. Once the voltage on TIMER reaches approximately 0.5 V, the circuit-breaker latch is set and the power switch is latched off. Power must be recycled or the ENABLE pin must be toggled to restart the controller. In high-power or high-temperature applications, a minimum 50-pF capacitor is strongly recommended from TIMER to ground, to prevent any false triggering.

VREG – VREG is the output of an internal low-dropout voltage regulator, where IN1 is the input. The regulator is used to generate a regulated voltage source, less than 5.5 V, for the device. A 0.1- μF ceramic capacitor should be connected between VREG and ground to aid in noise rejection. In this configuration, upon disabling the device, the internal low-dropout regulator will also be disabled, which removes power from the internal circuitry and allows the device to be placed in low-quiescent-current mode. In applications where IN1 is less than 5.5 V, VREG and IN1 may be connected together. However, under these conditions, disabling the device will not place the device in low-quiescent-current mode, because the internal low-dropout voltage regulator is being bypassed, thereby keeping internal circuitry operational. If VREG and IN1 are connected together, a 0.1- μF ceramic capacitor between VREG and ground is not needed if IN1 already has a bypass capacitor of 1 μF to 10 μF .

ABSOLUTE MAXIMUM RATINGS

over operating free-air temperature range (unless otherwise noted) ⁽¹⁾ ⁽²⁾

		VALUE	UNIT
Input voltage range	$V_{I(IN1)}$, $V_{I(SENSE1)}$, $V_{I(SET1)}$, $V_{I(ENABLE)}$	-0.3 to 15	V
	$V_{I(IN2)}$, $V_{I(SENSE2)}$, $V_{I(SET2)}$, $V_{I(VREG)}$	-0.3 to 7	V
Output voltage range	$V_{O(GATE1)}$	-0.3 to 30	V
	$V_{O(GATE2)}$	-0.3 to 22	V
	$V_{O(DISCH1)}$, $V_{O(FAULT)}$, $V_{O(DISCH2)}$, $V_{O(TIMER)}$	-0.3 to 15	V
Sink current range	$I_{(GATE1)}$, $I_{(GATE2)}$, $I_{(DISCH1)}$, $I_{(DISCH2)}$	0 to 100	mA
	$I_{(TIMER)}$, $I_{(FAULT)}$	0 to 10	mA
Operating virtual junction temperature range, T_J		-40 to 100	°C
Storage temperature range, T_{stg}		-55 to 150	°C
Lead temperature 1,6 mm (1/16 inch) from case for 10 seconds		260	°C

- (1) Stresses beyond those listed under *absolute maximum ratings* may cause permanent damage to the device. These are stress ratings only, and functional operation of the device at these or any other conditions beyond those indicated under *recommended operating conditions* is not implied. Exposure to absolute-maximum-rated conditions for extended periods may affect device reliability.
- (2) All voltages are respect to DGND.

DISSIPATION RATING TABLE

PACKAGE	$T_A \leq 25^\circ\text{C}$ POWER RATING	DERATING FACTOR ABOVE $T_A = 25^\circ\text{C}$	$T_A = 70^\circ\text{C}$ POWER RATING	$T_A = 85^\circ\text{C}$ POWER RATING
PW-16	823 mW	10.98 mW/°C	329 mW	165 mW
D-16	674 mW	8.98 mW/°C	270 mW	135 mW

RECOMMENDED OPERATING CONDITIONS

		MIN	NOM	MAX	UNIT
V_I	Input voltage	$V_{I(IN1)}$, $V_{I(SENSE1)}$, $V_{I(SET1)}$	3	13	V
		$V_{I(IN2)}$, $V_{I(SENSE2)}$, $V_{I(SET2)}$, $V_{I(VREG)}$	3	5.5	
		$V_{I(SENSE1)}$, $V_{I(SET1)}$		$V_{I(IN1)}$	
		$V_{I(SENSE2)}$, $V_{I(SET2)}$		$V_{I(IN2)}$	
T_J	Operating virtual junction temperature	-40		100	°C

ELECTRICAL CHARACTERISTICS

over recommended operating temperature range ($-40^{\circ}\text{C} < T_A < 85^{\circ}\text{C}$), $3\text{V} \leq V_{I(IN1)} \leq 13\text{V}$, $3\text{V} \leq V_{I(IN2)} \leq 5.5\text{V}$ (unless otherwise noted)

PARAMETER		TEST CONDITIONS		MIN	TYP	MAX	UNIT
GENERAL							
$I_{I(IN1)}$	Input current, IN1	$V_{I(ENABLE)} = 5\text{V}$ (TPS2321),		0.5	1		mA
$I_{I(IN2)}$	Input current, IN2	$V_{I(ENABLE)} = 0\text{V}$ (TPS2320)		75	200		μA
$I_{I(stby)}$	Standby current (sum of currents into IN1, IN2, ISENSE1, ISENSE2, ISET1, and ISET2)	$V_{I(ENABLE)} = 0\text{V}$ (TPS2321), $V_{I(ENABLE)} = 5\text{V}$ (TPS2320)			5		μA
GATE1							
$V_{G(GATE1_3V)}$	Gate voltage	$I_{I(GATE1)} = 500\text{ nA}$, DISCH1 open	$V_{I(IN1)} = 3\text{V}$	9	11.5		V
$V_{G(GATE1_4.5V)}$			$V_{I(IN1)} = 4.5\text{V}$	10.5	14.5		
$V_{G(GATE1_10.8V)}$			$V_{I(IN1)} = 10.8\text{V}$	16.8	21		
$V_{C(GATE1)}$	Clamping voltage, GATE1 to DISCH1			9	10	12	V
$I_{S(GATE1)}$	Source current, GATE1	$3\text{V} \leq V_{I(IN1)} \leq 13.2\text{V}$, $3\text{V} \leq V_{O(VREG)} \leq 5.5\text{V}$, $V_{I(GATE1)} = V_{I(IN1)} + 6\text{V}$		10	14	20	μA
	Sink current, GATE1	$3\text{V} \leq V_{I(IN1)} \leq 13.2\text{V}$, $3\text{V} \leq V_{O(VREG)} \leq 5.5\text{V}$, $V_{I(GATE1)} = V_{I(IN1)}$		50	75	100	μA
$t_{r(GATE1)}$	Rise time, GATE1	C_g to GND = 1 nF ⁽¹⁾	$V_{I(IN1)} = 3\text{V}$	0.5			ms
			$V_{I(IN1)} = 4.5\text{V}$	0.6			
			$V_{I(IN1)} = 10.8\text{V}$	1			
$t_{f(GATE1)}$	Fall time, GATE1	C_g to GND = 1 nF ⁽¹⁾	$V_{I(IN1)} = 3\text{V}$	0.1			ms
			$V_{I(IN1)} = 4.5\text{V}$	0.12			
			$V_{I(IN1)} = 10.8\text{V}$	0.2			
GATE2							
$V_{G(GATE2_3V)}$	Gate voltage	$I_{I(GATE2)} = 500\text{ nA}$, DISCH2 open	$V_{I(IN2)} = 3\text{V}$	9	11.7		V
$V_{G(GATE2_4.5V)}$			$V_{I(IN2)} = 4.5\text{V}$	10.5	14.7		
$V_{C(GATE2)}$	Clamping voltage, GATE2 to DISCH2			9	10	12	V
$I_{S(GATE2)}$	Source current, GATE2	$3\text{V} \leq V_{I(IN2)} \leq 5.5\text{V}$, $3\text{V} \leq V_{O(VREG)} \leq 5.5\text{V}$, $V_{I(GATE2)} = V_{I(IN2)} + 6\text{V}$		10	14	20	μA
	Sink current, GATE2	$3\text{V} \leq V_{I(IN2)} \leq 5.5\text{V}$, $3\text{V} \leq V_{O(VREG)} \leq 5.5\text{V}$, $V_{I(GATE2)} = V_{I(IN2)}$		50	75	100	μA
$t_{r(GATE2)}$	Rise time, GATE2	C_g to GND = 1 nF ⁽¹⁾	$V_{I(IN2)} = 3\text{V}$	0.5			ms
			$V_{I(IN2)} = 4.5\text{V}$	0.6			
$t_{f(GATE2)}$	Fall time, GATE2	C_g to GND = 1 nF ⁽¹⁾	$V_{I(IN2)} = 3\text{V}$	0.1			ms
			$V_{I(IN2)} = 4.5\text{V}$	0.12			

(1) Specified, but not production tested.

ELECTRICAL CHARACTERISTICS (Continued)

over recommended operating temperature range ($-40^{\circ}\text{C} < T_A < 85^{\circ}\text{C}$), $3\text{V} \leq V_{I(IN1)} \leq 13\text{V}$, $3\text{V} \leq V_{I(IN2)} \leq 5.5\text{V}$ (unless otherwise noted)

PARAMETER		TEST CONDITIONS	MIN	TYP	MAX	UNIT
TIMER						
$V_{(TO_TIMER)}$	Threshold voltage, TIMER		0.4	0.5	0.6	V
	Charge current, TIMER	$V_{I(TIMER)} = 0\text{V}$	35	50	65	μA
	Discharge current, TIMER	$V_{I(TIMER)} = 1\text{V}$	1	2.5		mA
CIRCUIT BREAKER						
$V_{IT(CB)}$	Threshold voltage, circuit breaker	$R_{ISETx} = 1\text{ k}\Omega$	40	50	60	mV
		$R_{ISETx} = 400\ \Omega$, $T_A = 25^{\circ}\text{C}$	14	19	24	
		$R_{ISETx} = 1\text{ k}\Omega$, $T_A = 25^{\circ}\text{C}$	44	50	53	
		$R_{ISETx} = 1.5\text{ k}\Omega$, $T_A = 25^{\circ}\text{C}$	68	73	78	
$I_{(IB_ISENSEx)}$	Input bias current, I_{SENSEx}		0.1	5	μA	
	Discharge current, $GATEx$	$V_{O(GATEx)} = 4\text{V}$	400	800		mA
		$V_{O(GATEx)} = 1\text{V}$	25	150		
$t_{pd(CB)}$	Propagation (delay) time, comparator inputs to gate output	$C_G = 50\text{ pF}$, 10 mV overdrive, (50% to 10%), $C_{TIMER} = 50\text{ pF}$		1.3		μs
ENABLE, ACTIVE LOW (TPS2320)						
$V_{IH(ENABLE)}$	High-level input voltage, \overline{ENABLE}		2			V
$V_{IL(ENABLE)}$	Low-level input voltage, \overline{ENABLE}				0.8	V
$R_{I(ENABLE)}$	Input pullup resistance, \overline{ENABLE}	See ⁽¹⁾	100	200	300	$\text{k}\Omega$
$t_{d(off_ENABLE)}$	Turnoff delay time, \overline{ENABLE}	$V_{I(ENABLE)}$ increasing above stop threshold; 100 ns rise time, 20 mV overdrive ⁽²⁾		60		μs
$t_{d(on_ENABLE)}$	Turnon delay time, \overline{ENABLE}	$V_{I(ENABLE)}$ decreasing below start threshold; 100 ns fall time, 20 mV overdrive ⁽²⁾		125		μs
ENABLE, ACTIVE HIGH (TPS2321)						
$V_{IH(ENABLE)}$	High-level input voltage, ENABLE		2			V
$V_{IL(ENABLE)}$	Low-level input voltage, ENABLE				0.7	V
$R_{I(ENABLE)}$	Input pulldown resistance, ENABLE		100	150	300	$\text{k}\Omega$
$t_{d(on_ENABLE)}$	Turnon delay time, ENABLE	$V_{I(ENABLE)}$ increasing above start threshold; 100 ns rise time, 20 mV overdrive ⁽²⁾		85		μs
$t_{d(off_ENABLE)}$	Turnoff delay time, ENABLE	$V_{I(ENABLE)}$ decreasing below stop threshold; 100 ns fall time, 20 mV overdrive ⁽²⁾		100		μs
PREREG						
$V_{(VREG)}$	PREREG output voltage	$4.5 \leq V_{I(IN1)} \leq 13\text{V}$	3.5	4.1	5.5	V
$V_{(drop_PREREG)}$	PREREG dropout voltage	$V_{I(IN1)} = 3\text{V}$			0.1	V

- (1) Test I_O of \overline{ENABLE} at $V_{I(ENABLE)} = 1\text{V}$ and 0V , then $R_{I(ENABLE)} = \frac{1\text{V}}{I_{O_0V} - I_{O_1V}}$
- (2) Specified, but not production tested.

ELECTRICAL CHARACTERISTICS (Continued)

over recommended operating temperature range ($-40^{\circ}\text{C} < T_A < 85^{\circ}\text{C}$), $3\text{V} \leq V_{I(IN1)} \leq 13\text{V}$, $3\text{V} \leq V_{I(IN2)} \leq 5.5\text{V}$ (unless otherwise noted)

PARAMETER		TEST CONDITIONS	MIN	TYP	MAX	UNIT
VREG UVLO						
$V_{(TO_UVLOstart)}$	Output threshold voltage, start		2.75	2.85	2.95	V
$V_{(TO_UVLOstop)}$	Output threshold voltage, stop		2.65	2.78		V
$V_{hys(UVLO)}$	Hysteresis		50	75		mV
	UVLO sink current, GATE _x	$V_{I(GATEx)} = 2\text{ V}$	10			mA
FAULT OUTPUT						
$V_{O(sat_FAULT)}$	Output saturation voltage, $\overline{\text{FAULT}}$	$I_O = 2\text{ mA}$			0.4	V
$I_{lkq(FAULT)}$	Leakage current, $\overline{\text{FAULT}}$	$V_{O(FAULT)} = 13\text{ V}$			1	μA
DISCH1 AND DISCH2						
$I_{(DISCH)}$	Discharge current, DISCH _x	$V_{I(DISCHx)} = 1.5\text{ V}$, $V_{I(VIN1)} = 5\text{ V}$	5	10		mA
$V_{IH(DISCH)}$	Discharge on high-level input voltage		2			V
$V_{IL(DISCH)}$	Discharge on low-level input voltage				1	V

PARAMETER MEASUREMENT INFORMATION

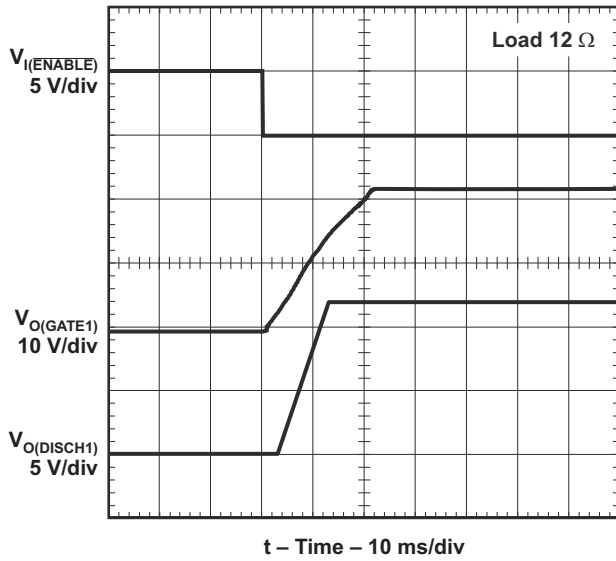

Figure 1. Turnon Voltage Transition of Channel 1

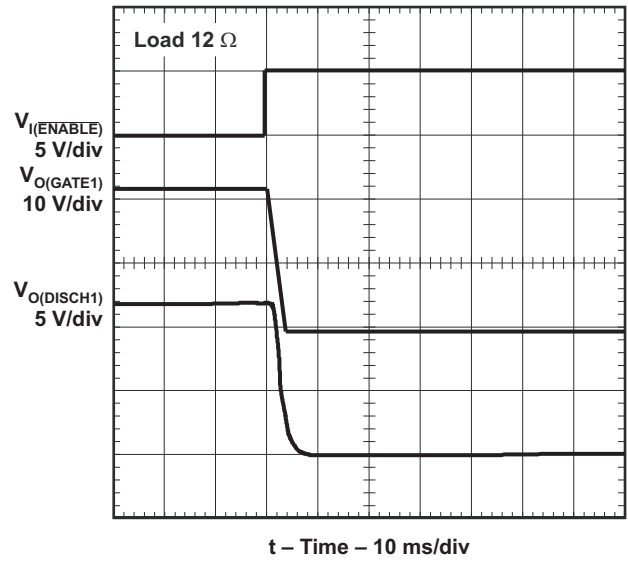

Figure 2. Turnoff Voltage Transition of Channel 1

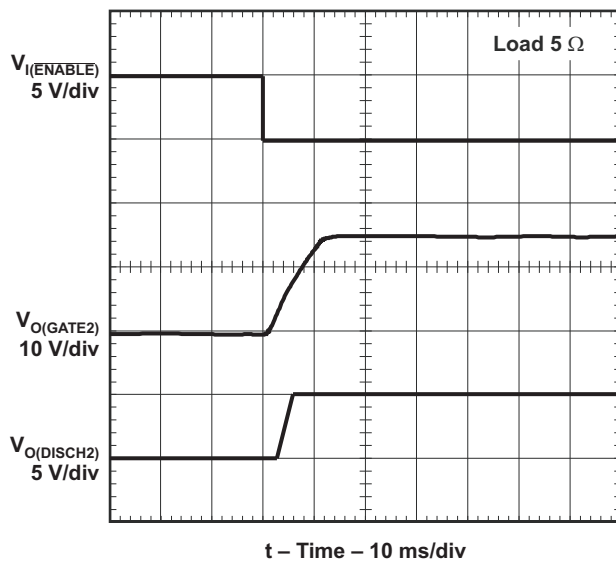

Figure 3. Turnon Voltage Transition of Channel 2

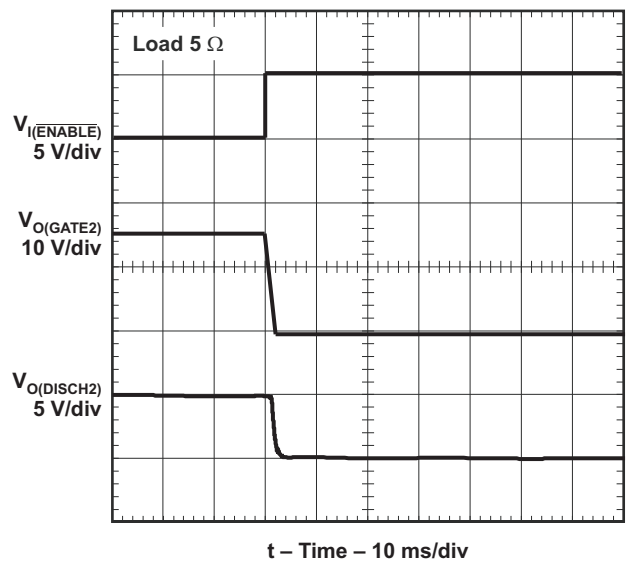

Figure 4. Turnoff Voltage Transition of Channel 2

PARAMETER MEASUREMENT INFORMATION (continued)

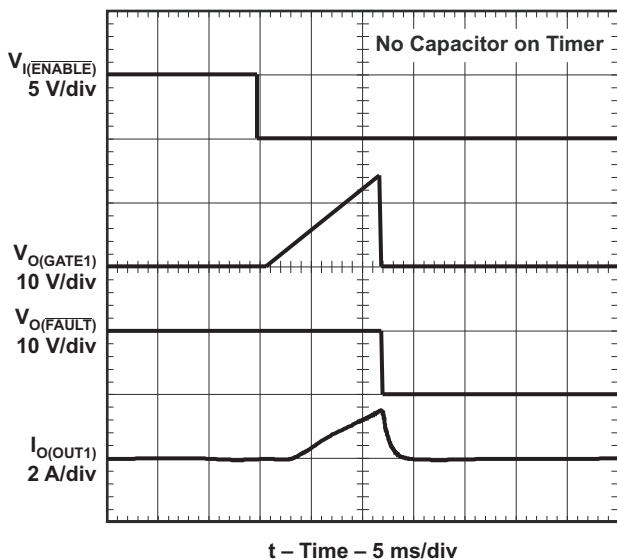

Figure 5. Channel 1 Overcurrent Response: Enabled Into Overcurrent Load

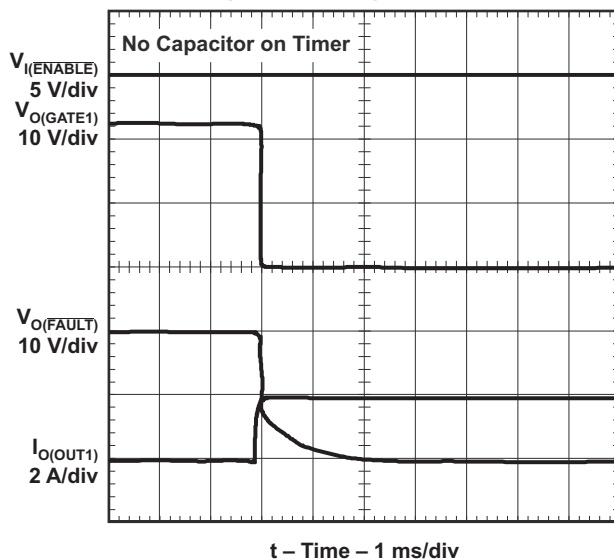

Figure 6. Channel 1 Overcurrent Response: an Overcurrent Load Plugged Into the Enabled Board

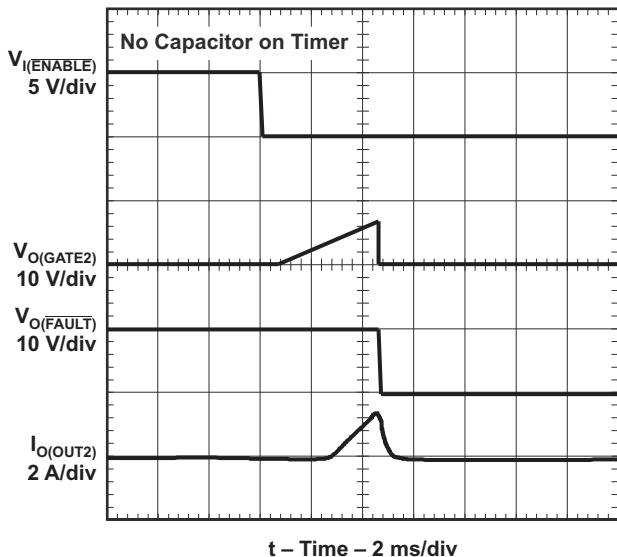

Figure 7. Channel 2 Overcurrent Response: Enabled Into Overcurrent Load

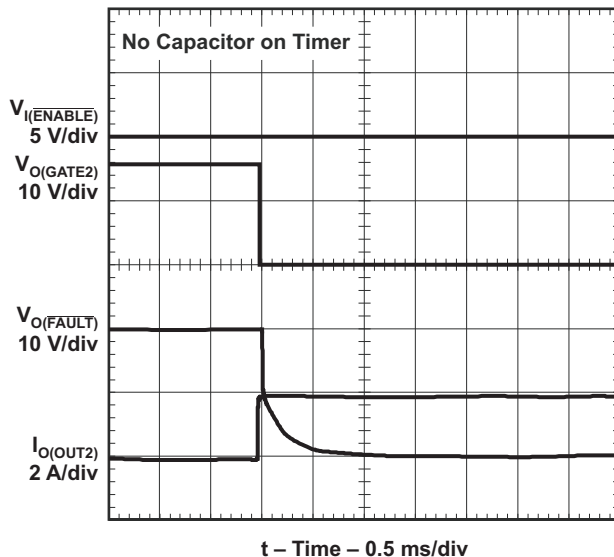

Figure 8. Channel 2 Overcurrent Response: an Overcurrent Load Plugged Into the Enabled Board

PARAMETER MEASUREMENT INFORMATION (continued)

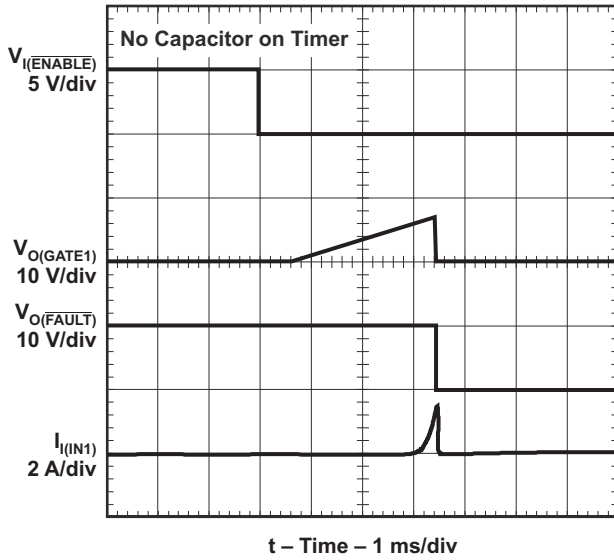

Figure 9. Channel 1 – Enabled Into Short Circuit

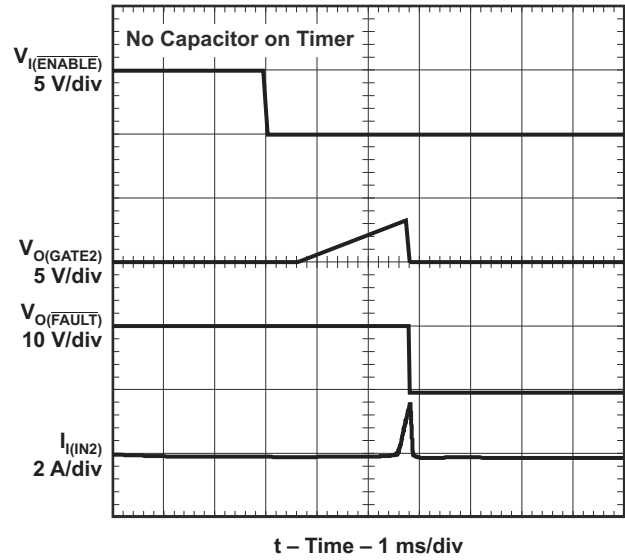

Figure 10. Channel 2 – Enabled Into Short Circuit

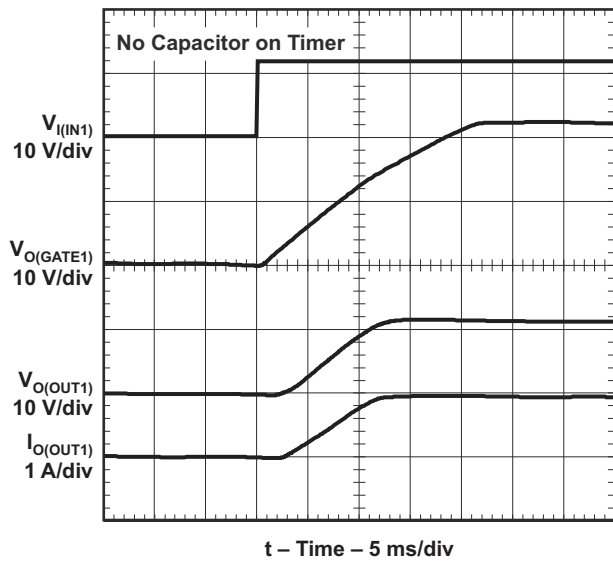

Figure 11. Channel 1 –Hot Plug

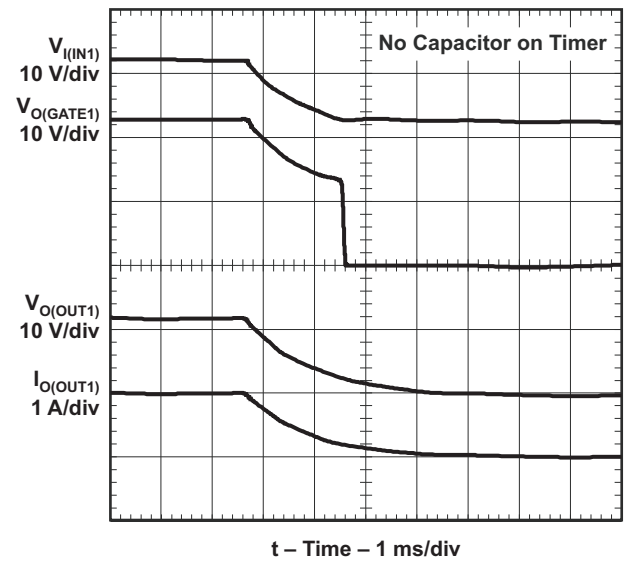

Figure 12. Channel 1 –Hot Removal

PARAMETER MEASUREMENT INFORMATION (continued)

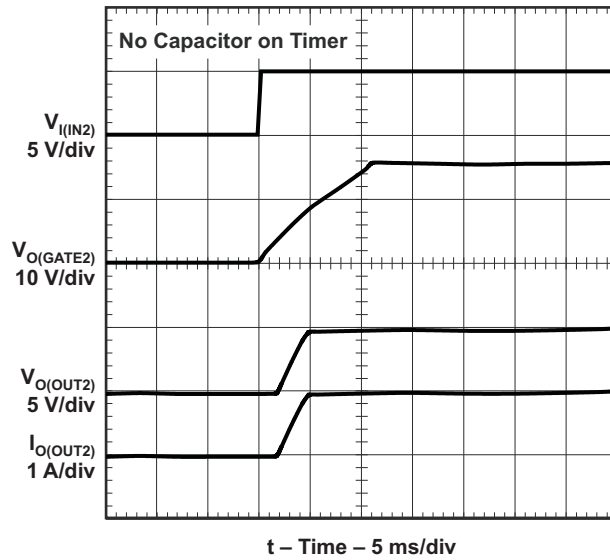

Figure 13. Channel 2 - Hot Plug

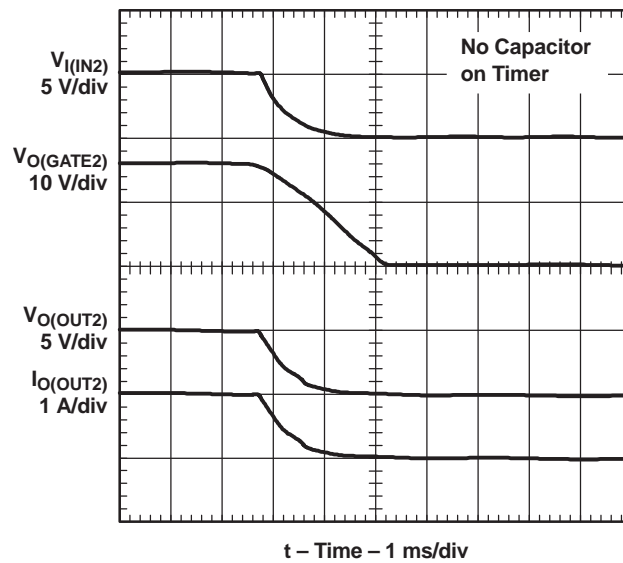
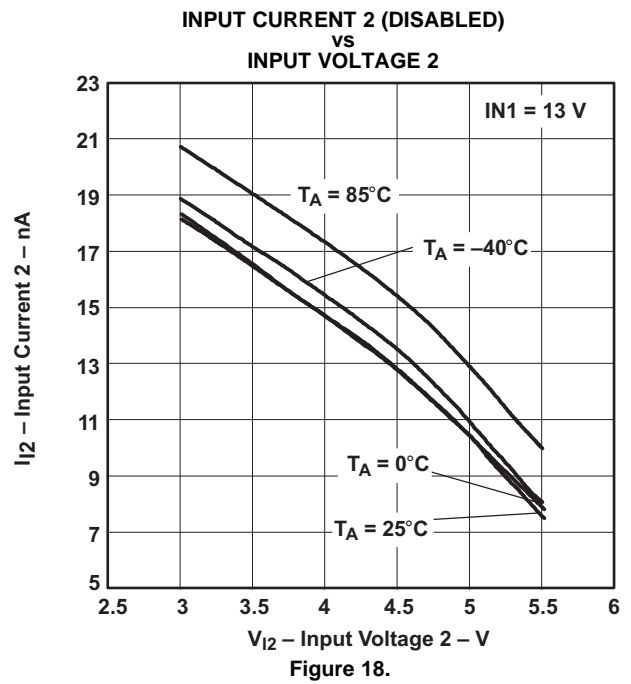
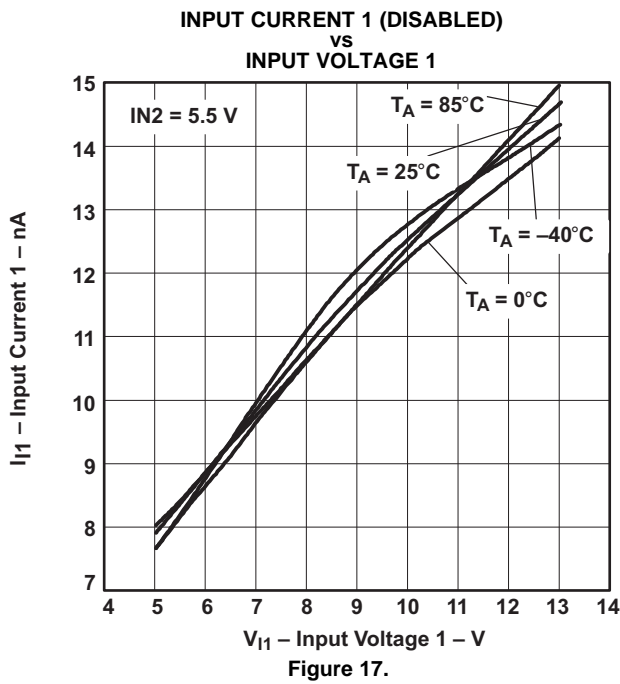
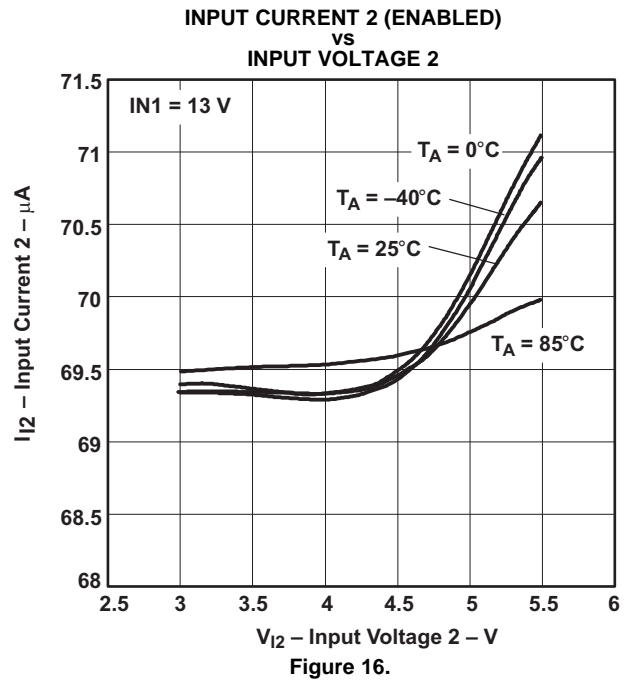
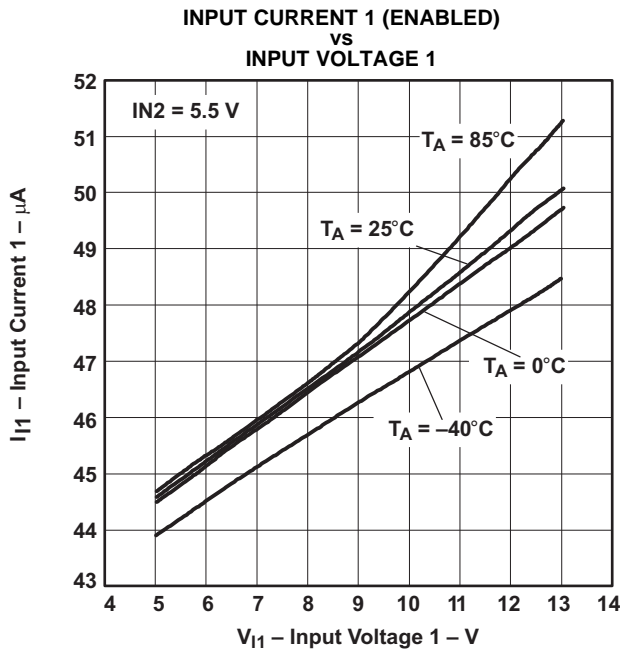

Figure 14. Channel 2 - Hot Removal

TYPICAL CHARACTERISTICS



TYPICAL CHARACTERISTICS (continued)

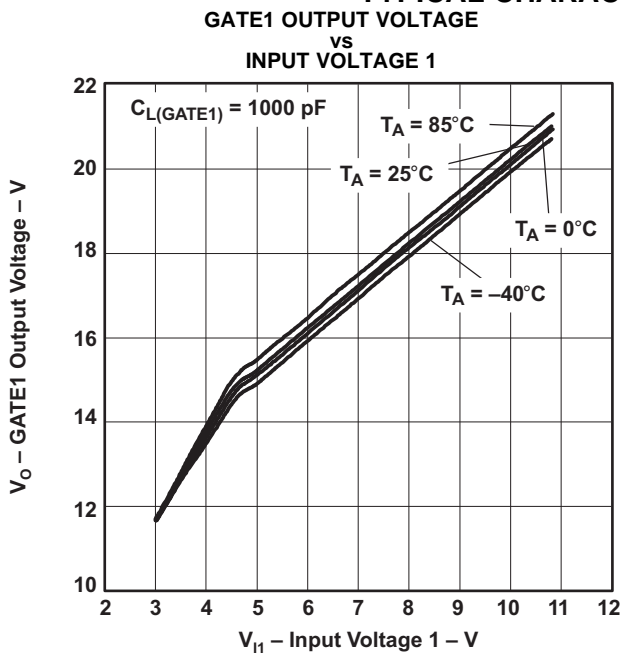

Figure 19.

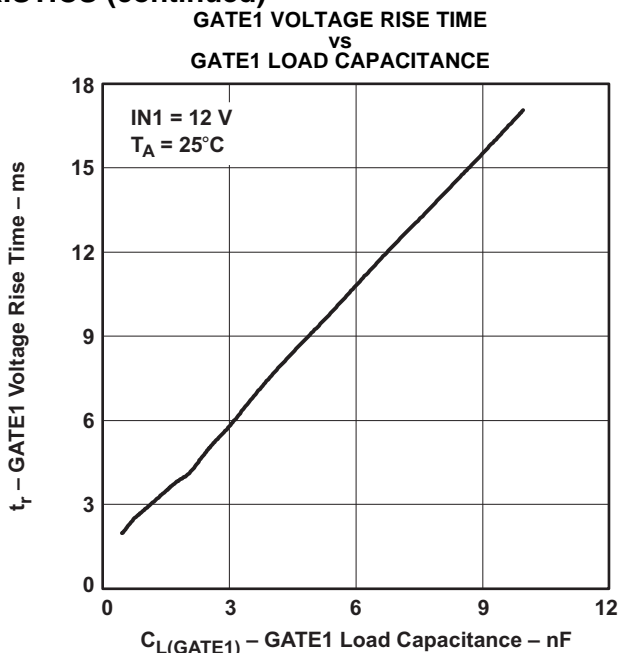

Figure 20.

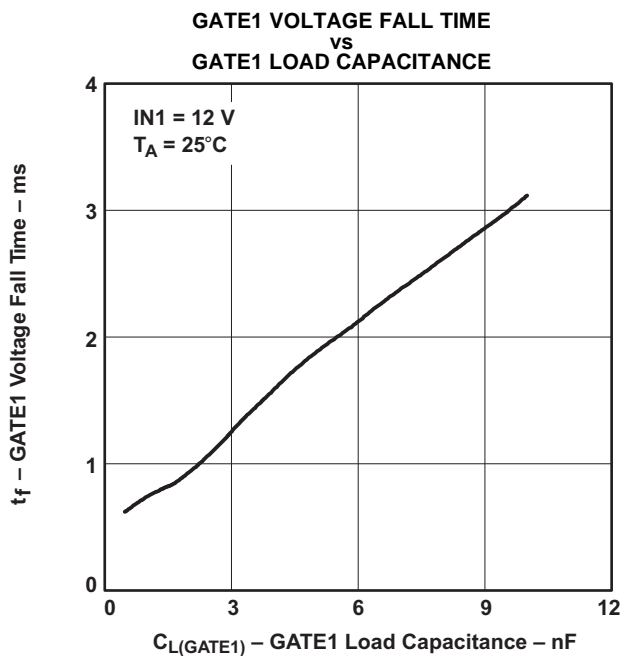

Figure 21.

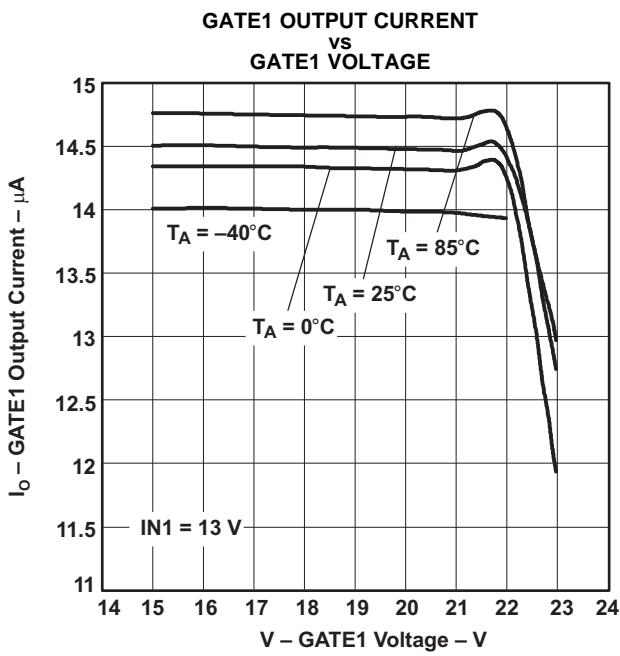

Figure 22.

TYPICAL CHARACTERISTICS (continued)

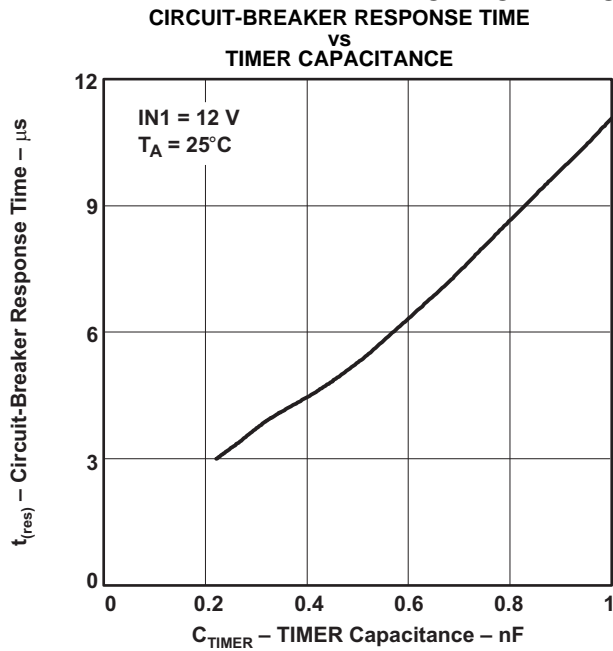

Figure 23.

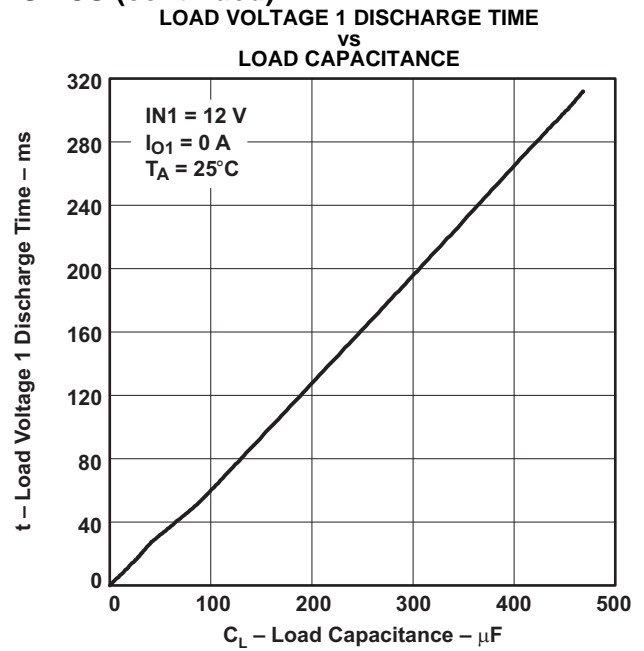

Figure 24.

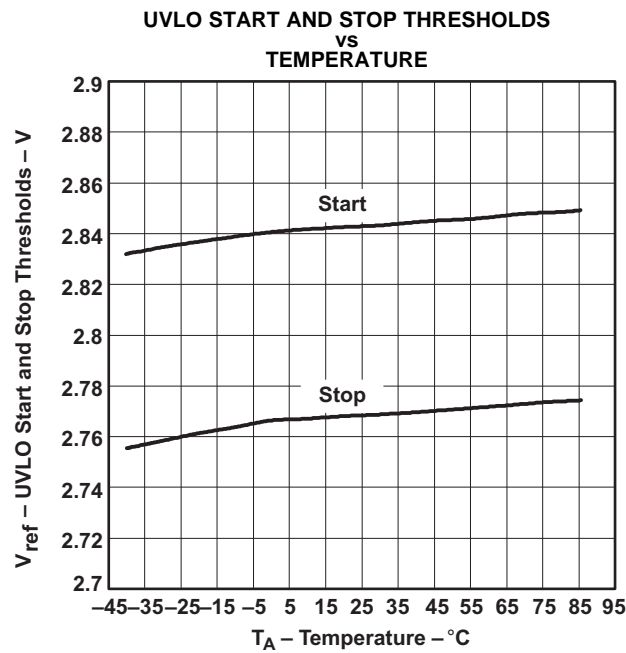

Figure 25.

APPLICATION INFORMATION

Figure 26 shows a typical dual hot-swap application. The pullup resistor at $\overline{\text{FAULT}}$ should be relatively large (e.g., 100 k Ω) to reduce power loss, unless it is required to drive a large load.

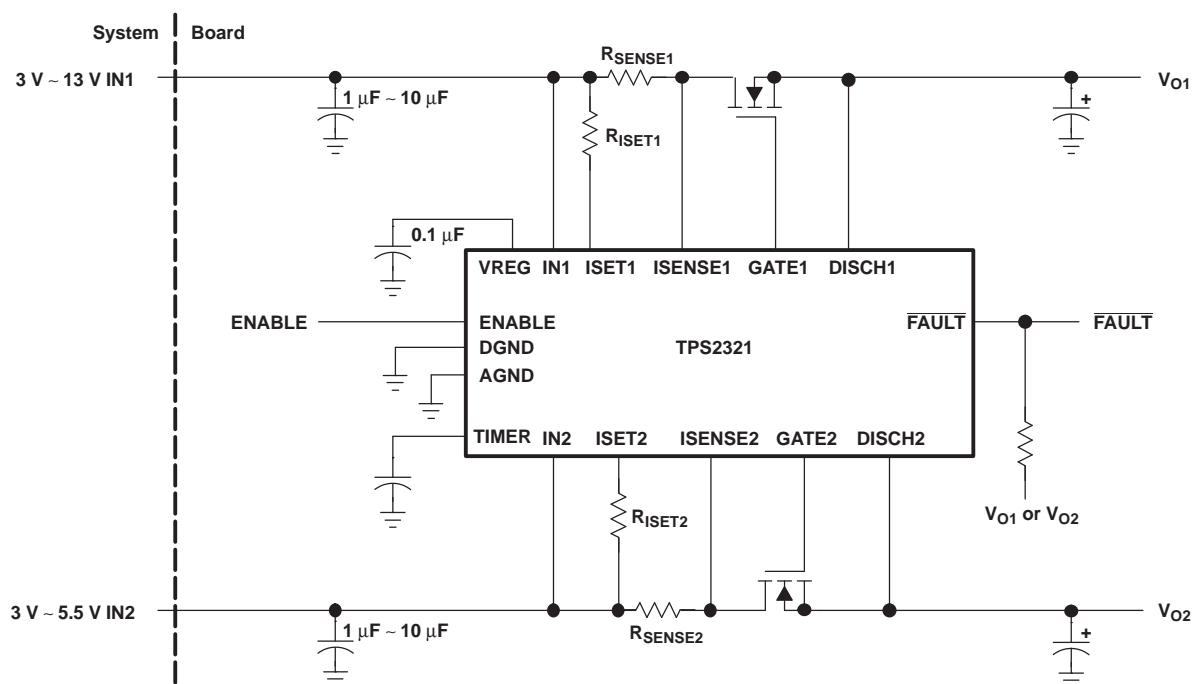

Figure 26. Typical Dual Hot-Swap Application

INPUT CAPACITOR

A 0.1- μF ceramic capacitor in parallel with a 1- μF ceramic capacitor should be placed on the input power terminals near the connector on the hot-plug board to help stabilize the voltage rails on the cards. The TPS2320/01 does not need to be mounted near the connector or to these input capacitors. For applications with more severe power environments, a 2.2- μF , or higher, ceramic capacitor is recommended near the input terminals of the hot-plug board. A bypass capacitor for IN1 and for IN2 should be placed close to the device.

OUTPUT CAPACITOR

A 0.1- μF ceramic capacitor is recommended per load on the TPS2320/21; these capacitors should be placed close to the external FETs and to TPS2320/21. A larger bulk capacitor is also recommended on the load. The value of the bulk capacitor should be selected based on the power requirements and the transients generated by the application.

EXTERNAL FET

To deliver power from the input sources to the loads, each channel needs an external N-channel MOSFET. A few widely used MOSFETs are shown in Table 3. But many other MOSFETs on the market can also be used with TPS23xx in hot-swap systems.

Table 3. Some Available N-Channel MOSFETs

CURRENT RANGE (A)	PART NUMBER	DESCRIPTION	MANUFACTURER
0 to 2	IRF7601	N-channel, $r_{\text{DS(on)}} = 0.035 \Omega$, 4.6 A, Micro-8	International Rectifier
	MTSF3N03HDR2	N-channel, $r_{\text{DS(on)}} = 0.040 \Omega$, 4.6 A, Micro-8	ON Semiconductor
	MMSF5N02HDR2	Dual N-channel, $r_{\text{DS(on)}} = 0.04 \Omega$, 5 A, SO-8	ON Semiconductor

Table 3. Some Available N-Channel MOSFETs (continued)

CURRENT RANGE (A)	PART NUMBER	DESCRIPTION	MANUFACTURER
2 to 5	IRF7401	N-channel, $r_{DS(on)} = 0.022 \Omega$, 7 A, SO-8	International Rectifier
	MMSF5N02HDR2	N-channel, $r_{DS(on)} = 0.025 \Omega$, 5 A, SO-8	ON Semiconductor
	IRF7313	Dual N-channel, $r_{DS(on)} = 0.029 \Omega$, 5.2 A, SO-8	International Rectifier
	SI4410	N-channel, $r_{DS(on)} = 0.020 \Omega$, 8 A, SO-8	Vishay Dale
5 to 10	IRLR3103	N-channel, $r_{DS(on)} = 0.019 \Omega$, 29 A, d-Pak	International Rectifier
	IRLR2703	N-channel, $r_{DS(on)} = 0.045 \Omega$, 14 A, d-Pak	International Rectifier

TIMER

For most applications, a minimum capacitance of 50 pF is recommended to prevent false triggering. A capacitor should be connected between TIMER and ground. The presence of an overcurrent condition on either channel of the TPS2320/TPS2321 causes a 50- μ A current source to begin charging this capacitor. If the over-current condition persists until the capacitor has been charged to approximately 0.5 V, the TPS2320/TPS2321 latches off the offending channels and pulls the $\overline{\text{FAULT}}$ pin low. The timer capacitor can be made as large as desired to provide additional time delay before registering a fault condition. PWRGDx will not correctly report power conditions when the device is disabled. The time delay is approximately:

$$dt(\text{sec}) = C_{\text{TIMER}}(F) \times 10,000(\Omega).$$

OUTPUT-VOLTAGE SLEW-RATE CONTROL

When enabled, the TPS2320/TPS2321 controllers supply the gates of each external MOSFET transistor with a current of approximately 15 μ A. The slew rate of the MOSFET source voltage is thus limited by the gate-to-drain capacitance C_{gd} of the external MOSFET capacitor to a value approximating:

$$\frac{dV_s}{dt} = \frac{15 \mu\text{A}}{C_{gd}} \quad (1)$$

If a slower slew rate is desired, an additional capacitance can be connected between the gate of the external MOSFET and ground.

VREG CAPACITOR

The internal voltage regulator connected to VREG requires an external capacitor to ensure stability. A 0.1- μ F or 0.22- μ F ceramic capacitor is recommended.

GATE-DRIVE CIRCUITRY

The TPS2320/TPS2321 includes four separate features associated with each gate-drive terminal:

- A charging current of approximately 15 μ A is applied to enable the external MOSFET transistor. This current is generated by an internal charge pump that can develop a gate-to-source potential (referenced to DISCH1 or DISCH2) of 9 V–12 V. DISCH1 and DISCH2 must be connected to the respective external MOSFET source terminals to ensure proper operation of this circuitry.
- A discharge current of approximately 75 μ A is applied to disable the external MOSFET transistor. Once the transistor gate voltage has dropped below approximately 1.5 V, this current is disabled and the UVLO discharge driver is enabled instead. This feature allows the part to enter a low-current shutdown mode while ensuring that the gates of the external MOSFET transistors remain at a low voltage.
- During a UVLO condition, the gates of both MOSFET transistors are pulled down by internal PMOS transistors. These transistors continue to operate even if IN1 and IN2 are both at 0 V. This circuitry also helps hold the external MOSFET transistors off when power is suddenly applied to the system.
- During an overcurrent fault condition, the external MOSFET transistor that exhibited an overcurrent condition will be rapidly turned off by an internal pulldown circuit capable of pulling in excess of 400 mA (at 4 V) from the pin. Once the gate has been pulled below approximately 1.5 V, this driver is disengaged and the UVLO driver is enabled instead. If one channel experiences an overcurrent condition and the other does not, then only the channel that is conducting excessive current will be turned off rapidly. The other channel will continue to operate normally.

SETTING THE CURRENT-LIMIT CIRCUIT-BREAKER THRESHOLD

Using channel 1 as an example, the current sensing resistor $R_{ISENSE1}$ and the current-limit-setting resistor R_{ISET1} determine the current limit of the channel, and can be calculated by the following equation:

$$I_{LMT1} = \frac{R_{ISET1} \times 50 \times 10^{-6}}{R_{ISENSE1}} \quad (2)$$

Typically $R_{ISENSE1}$ is very small (0.001 Ω to 0.1 Ω). If the trace and solder-junction resistances between the junction of $R_{ISENSE1}$ and ISENSE1 and the junction of $R_{ISENSE1}$ and R_{ISET1} are greater than 10% of the $R_{ISENSE1}$ value, then these resistance values should be added to the $R_{ISENSE1}$ value used in the calculation above.

The above information and calculation also apply to channel 2. [Table 4](#) shows some of the current sense resistors available in the market.

Table 4. Some Current Sense Resistors

CURRENT RANGE (A)	PART NUMBER	DESCRIPTION	MANUFACTURER
0 to 1	WSL-1206, 0.05 1%	0.05 Ω , 0.25 W, 1% resistor	Vishay Dale
1 to 2	WSL-1206, 0.025 1%	0.025 Ω , 0.25 W, 1% resistor	
2 to 4	WSL-1206, 0.015 1%	0.015 Ω , 0.25 W, 1% resistor	
4 to 6	WSL-2010, 0.010 1%	0.010 Ω , 0.5 W, 1% resistor	
6 to 8	WSL-2010, 0.007 1%	0.007 Ω , 0.5 W, 1% resistor	
8 to 10	WSR-2, 0.005 1%	0.005 Ω , 0.5 W, 1% resistor	

UNDERVOLTAGE LOCKOUT (UVLO)

The TPS2320/TPS2321 includes an undervoltage lockout (UVLO) feature that monitors the voltage present on the VREG pin. This feature will disable both external MOSFETs if the voltage on VREG drops below 2.78 V (nominal) and will re-enable normal operation when it rises above 2.85 V (nominal). Since VREG is fed from IN1 through a low-dropout voltage regulator, the voltage on VREG will track the voltage on IN1 within 50 mV. While the undervoltage lockout is engaged, both GATE1 and GATE2 are held low by internal PMOS pulldown transistors, ensuring that the external MOSFET transistors remain off at all times, even if all power supplies have fallen to 0 V.

SINGLE-CHANNEL OPERATION

Some applications may require only a single external MOS transistor. Such applications should use GATE1 and the associated circuitry (IN1, ISENSE1, ISET1, DISCH1). The IN2 pin should be grounded to disable the circuitry associated with the GATE2 pin.

POWER-UP CONTROL

The TPS2320/TPS2321 includes a 500 μ s (nominal) startup delay that ensures that internal circuitry has sufficient time to start before the device begins turning on the external MOSFETs. This delay is triggered only upon the rapid application of power to the circuit. If the power supply ramps up slowly, the undervoltage lockout circuitry will provide adequate protection against undervoltage operation.

3-CHANNEL HOT-SWAP APPLICATION

Some applications require hot-swap control of up to three voltage rails, but may not explicitly require the sensing of the status of the output power on all three of the voltage rails. One such application is device bay, where dv/dt control of 3.3 V, 5 V, and 12 V is required. By using Channel 2 to drive both the 3.3-V and 5-V power rails and Channel 1 to drive the 12-V power rail, as is shown below, TPS2320/01 can deliver three different voltages to three loads while monitoring the status of two of the loads.

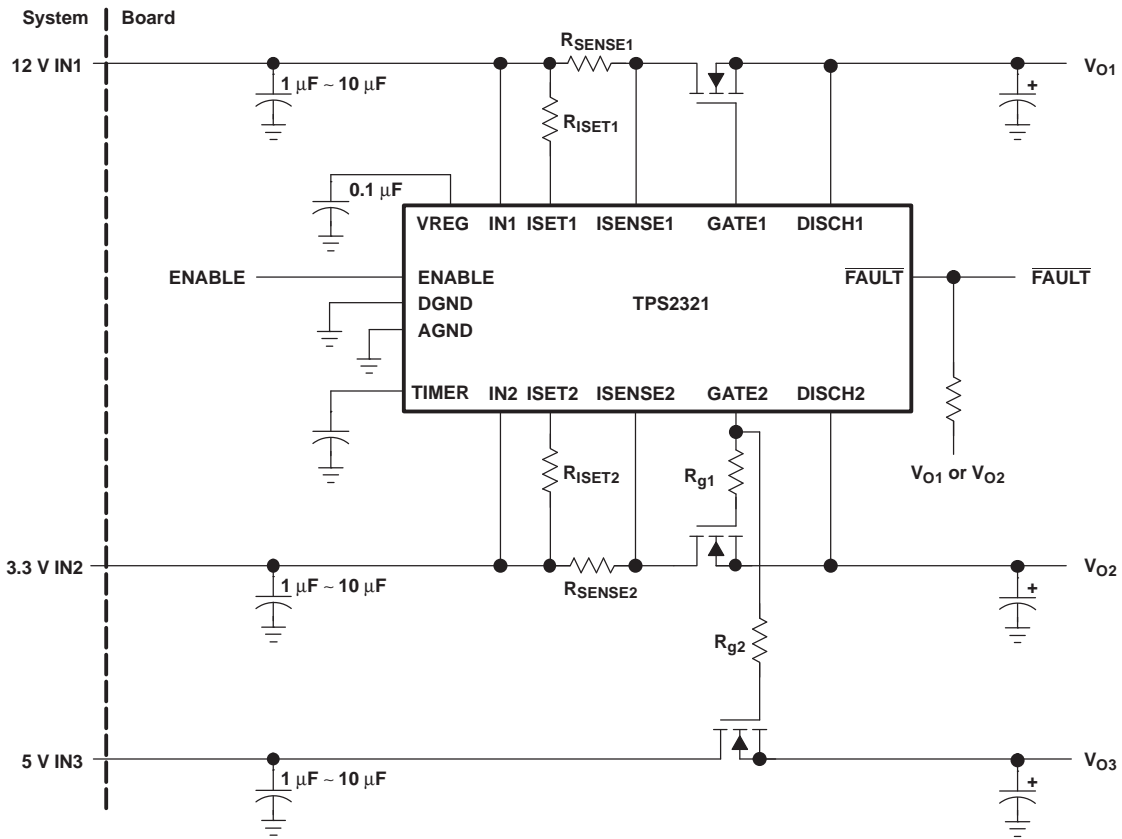

Figure 27. Three-Channel Application

Figure 28 shows ramp-up waveforms of the three output voltages.

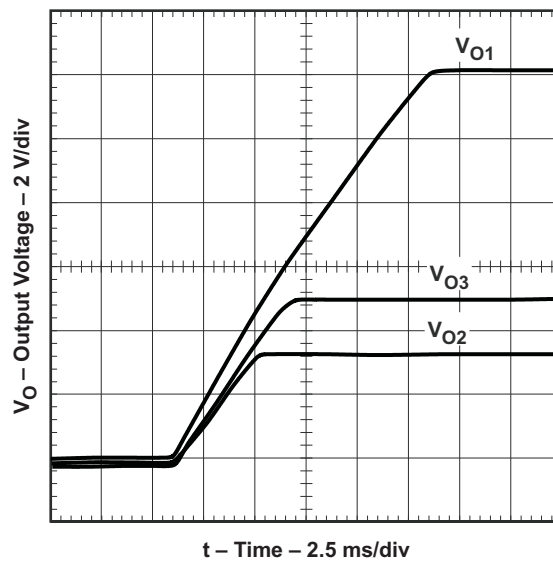

Figure 28.

REVISION HISTORY

Note: Revision history for previous versions is not available. Page numbers of previous versions may differ.

Changes from Revision E (November 2006) to Revision F	Page
• Added text to ISENSE1, ISENSE2, ISET1, ISET2 pin description paragraph for clarification.	3
• Added additional V_I specs to ROC table for clarification	4
• Added minus sign to 40°C MIN T_J temperature	4

PACKAGING INFORMATION

Orderable Device	Status (1)	Package Type	Package Drawing	Pins	Package Qty	Eco Plan (2)	Lead finish/ Ball material (6)	MSL Peak Temp (3)	Op Temp (°C)	Device Marking (4/5)	Samples
TPS2320ID	ACTIVE	SOIC	D	16	40	RoHS & Green	NIPDAU	Level-1-260C-UNLIM	-40 to 85	TPS2320I	Samples
TPS2320IDR	ACTIVE	SOIC	D	16	2500	RoHS & Green	NIPDAU	Level-1-260C-UNLIM	-40 to 85	TPS2320I	Samples
TPS2320IPW	ACTIVE	TSSOP	PW	16	90	RoHS & Green	NIPDAU	Level-1-260C-UNLIM	-40 to 85	PD2320I	Samples
TPS2320IPWR	ACTIVE	TSSOP	PW	16	2000	RoHS & Green	NIPDAU	Level-1-260C-UNLIM	-40 to 85	PD2320I	Samples
TPS2321ID	ACTIVE	SOIC	D	16	40	RoHS & Green	NIPDAU	Level-1-260C-UNLIM	-40 to 85	TPS2321I	Samples
TPS2321IPW	ACTIVE	TSSOP	PW	16	90	RoHS & Green	NIPDAU	Level-1-260C-UNLIM	-40 to 85	PD2321I	Samples
TPS2321IPWR	ACTIVE	TSSOP	PW	16	2000	RoHS & Green	NIPDAU	Level-1-260C-UNLIM	-40 to 85	PD2321I	Samples

(1) The marketing status values are defined as follows:

ACTIVE: Product device recommended for new designs.

LIFEBUY: TI has announced that the device will be discontinued, and a lifetime-buy period is in effect.

NRND: Not recommended for new designs. Device is in production to support existing customers, but TI does not recommend using this part in a new design.

PREVIEW: Device has been announced but is not in production. Samples may or may not be available.

OBSOLETE: TI has discontinued the production of the device.

(2) **RoHS:** TI defines "RoHS" to mean semiconductor products that are compliant with the current EU RoHS requirements for all 10 RoHS substances, including the requirement that RoHS substance do not exceed 0.1% by weight in homogeneous materials. Where designed to be soldered at high temperatures, "RoHS" products are suitable for use in specified lead-free processes. TI may reference these types of products as "Pb-Free".

RoHS Exempt: TI defines "RoHS Exempt" to mean products that contain lead but are compliant with EU RoHS pursuant to a specific EU RoHS exemption.

Green: TI defines "Green" to mean the content of Chlorine (Cl) and Bromine (Br) based flame retardants meet JS709B low halogen requirements of <=1000ppm threshold. Antimony trioxide based flame retardants must also meet the <=1000ppm threshold requirement.

(3) MSL, Peak Temp. - The Moisture Sensitivity Level rating according to the JEDEC industry standard classifications, and peak solder temperature.

(4) There may be additional marking, which relates to the logo, the lot trace code information, or the environmental category on the device.

(5) Multiple Device Markings will be inside parentheses. Only one Device Marking contained in parentheses and separated by a "~" will appear on a device. If a line is indented then it is a continuation of the previous line and the two combined represent the entire Device Marking for that device.

⁽⁶⁾ Lead finish/Ball material - Orderable Devices may have multiple material finish options. Finish options are separated by a vertical ruled line. Lead finish/Ball material values may wrap to two lines if the finish value exceeds the maximum column width.

Important Information and Disclaimer:The information provided on this page represents TI's knowledge and belief as of the date that it is provided. TI bases its knowledge and belief on information provided by third parties, and makes no representation or warranty as to the accuracy of such information. Efforts are underway to better integrate information from third parties. TI has taken and continues to take reasonable steps to provide representative and accurate information but may not have conducted destructive testing or chemical analysis on incoming materials and chemicals. TI and TI suppliers consider certain information to be proprietary, and thus CAS numbers and other limited information may not be available for release.

In no event shall TI's liability arising out of such information exceed the total purchase price of the TI part(s) at issue in this document sold by TI to Customer on an annual basis.

TAPE AND REEL INFORMATION

QUADRANT ASSIGNMENTS FOR PIN 1 ORIENTATION IN TAPE

*All dimensions are nominal

Device	Package Type	Package Drawing	Pins	SPQ	Reel Diameter (mm)	Reel Width W1 (mm)	A0 (mm)	B0 (mm)	K0 (mm)	P1 (mm)	W (mm)	Pin1 Quadrant
TPS2320IDR	SOIC	D	16	2500	330.0	16.4	6.5	10.3	2.1	8.0	16.0	Q1
TPS2320IPWR	TSSOP	PW	16	2000	330.0	12.4	6.9	5.6	1.6	8.0	12.0	Q1
TPS2321IPWR	TSSOP	PW	16	2000	330.0	12.4	6.9	5.6	1.6	8.0	12.0	Q1

TAPE AND REEL BOX DIMENSIONS

*All dimensions are nominal

Device	Package Type	Package Drawing	Pins	SPQ	Length (mm)	Width (mm)	Height (mm)
TPS2320IDR	SOIC	D	16	2500	340.5	336.1	32.0
TPS2320IPWR	TSSOP	PW	16	2000	356.0	356.0	35.0
TPS2321IPWR	TSSOP	PW	16	2000	356.0	356.0	35.0

TUBE

*All dimensions are nominal

Device	Package Name	Package Type	Pins	SPQ	L (mm)	W (mm)	T (μm)	B (mm)
TPS2320ID	D	SOIC	16	40	507	8	3940	4.32
TPS2320IPW	PW	TSSOP	16	90	530	10.2	3600	3.5
TPS2321ID	D	SOIC	16	40	507	8	3940	4.32
TPS2321IPW	PW	TSSOP	16	90	530	10.2	3600	3.5

D (R-PDSO-G16)

PLASTIC SMALL OUTLINE



- NOTES:
- A. All linear dimensions are in inches (millimeters).
 - B. This drawing is subject to change without notice.
 - C. Body length does not include mold flash, protrusions, or gate burrs. Mold flash, protrusions, or gate burrs shall not exceed 0.006 (0,15) each side.
 - D. Body width does not include interlead flash. Interlead flash shall not exceed 0.017 (0,43) each side.
 - E. Reference JEDEC MS-012 variation AC.

D (R-PDSO-G16)

PLASTIC SMALL OUTLINE



4211283-4/E 08/12

- NOTES:
- A. All linear dimensions are in millimeters.
 - B. This drawing is subject to change without notice.
 - C. Publication IPC-7351 is recommended for alternate designs.
 - D. Laser cutting apertures with trapezoidal walls and also rounding corners will offer better paste release. Customers should contact their board assembly site for stencil design recommendations. Refer to IPC-7525 for other stencil recommendations.
 - E. Customers should contact their board fabrication site for solder mask tolerances between and around signal pads.



4220204/A 02/2017

NOTES:

1. All linear dimensions are in millimeters. Any dimensions in parenthesis are for reference only. Dimensioning and tolerancing per ASME Y14.5M.
2. This drawing is subject to change without notice.
3. This dimension does not include mold flash, protrusions, or gate burrs. Mold flash, protrusions, or gate burrs shall not exceed 0.15 mm per side.
4. This dimension does not include interlead flash. Interlead flash shall not exceed 0.25 mm per side.
5. Reference JEDEC registration MO-153.

EXAMPLE BOARD LAYOUT

PW0016A

TSSOP - 1.2 mm max height

SMALL OUTLINE PACKAGE



LAND PATTERN EXAMPLE
EXPOSED METAL SHOWN
SCALE: 10X



4220204/A 02/2017

NOTES: (continued)

- 6. Publication IPC-7351 may have alternate designs.
- 7. Solder mask tolerances between and around signal pads can vary based on board fabrication site.

EXAMPLE STENCIL DESIGN

PW0016A

TSSOP - 1.2 mm max height

SMALL OUTLINE PACKAGE

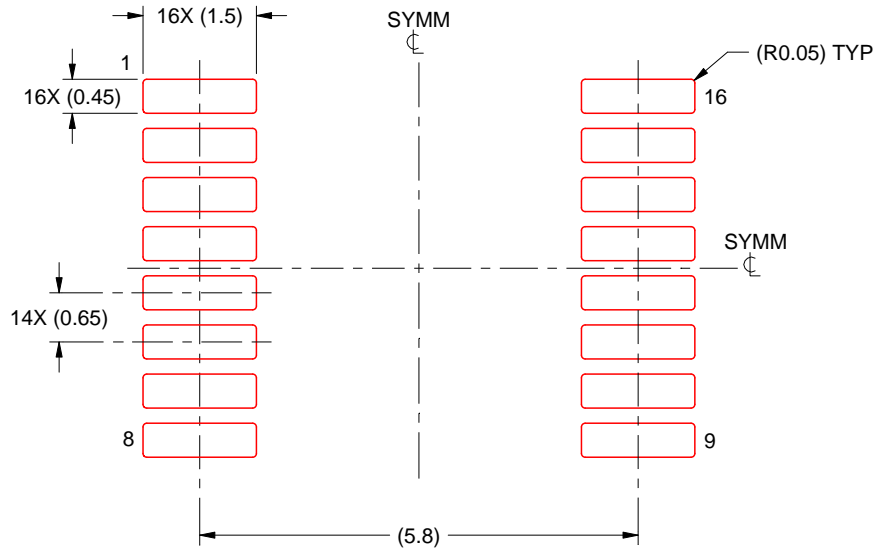

SOLDER PASTE EXAMPLE
BASED ON 0.125 mm THICK STENCIL
SCALE: 10X

4220204/A 02/2017

NOTES: (continued)

8. Laser cutting apertures with trapezoidal walls and rounded corners may offer better paste release. IPC-7525 may have alternate design recommendations.
9. Board assembly site may have different recommendations for stencil design.

IMPORTANT NOTICE AND DISCLAIMER

TI PROVIDES TECHNICAL AND RELIABILITY DATA (INCLUDING DATA SHEETS), DESIGN RESOURCES (INCLUDING REFERENCE DESIGNS), APPLICATION OR OTHER DESIGN ADVICE, WEB TOOLS, SAFETY INFORMATION, AND OTHER RESOURCES "AS IS" AND WITH ALL FAULTS, AND DISCLAIMS ALL WARRANTIES, EXPRESS AND IMPLIED, INCLUDING WITHOUT LIMITATION ANY IMPLIED WARRANTIES OF MERCHANTABILITY, FITNESS FOR A PARTICULAR PURPOSE OR NON-INFRINGEMENT OF THIRD PARTY INTELLECTUAL PROPERTY RIGHTS.

These resources are intended for skilled developers designing with TI products. You are solely responsible for (1) selecting the appropriate TI products for your application, (2) designing, validating and testing your application, and (3) ensuring your application meets applicable standards, and any other safety, security, regulatory or other requirements.

These resources are subject to change without notice. TI grants you permission to use these resources only for development of an application that uses the TI products described in the resource. Other reproduction and display of these resources is prohibited. No license is granted to any other TI intellectual property right or to any third party intellectual property right. TI disclaims responsibility for, and you will fully indemnify TI and its representatives against, any claims, damages, costs, losses, and liabilities arising out of your use of these resources.

TI's products are provided subject to [TI's Terms of Sale](#) or other applicable terms available either on [ti.com](https://www.ti.com) or provided in conjunction with such TI products. TI's provision of these resources does not expand or otherwise alter TI's applicable warranties or warranty disclaimers for TI products.

TI objects to and rejects any additional or different terms you may have proposed.

Mailing Address: Texas Instruments, Post Office Box 655303, Dallas, Texas 75265
Copyright © 2024, Texas Instruments Incorporated