

3A Processor Supply with I²C Compatible Interface and Remote Sense

Check for Samples: [TPS62360](#), [TPS62361B](#), [TPS62362](#), [TPS62363](#)

FEATURES

- **3A Peak Output Current**
- **Highest Efficiency:**
 - **Low R_{DS,on} Switch and Active Rectifier**
 - **Power Save Mode for Light Loads**
- **I²C High Speed Compatible Interface**
- **Programmable Output Voltage for Digital Voltage Scaling**
 - **TPS62360/62: 0.77V to 1.4V, 10mV Steps**
 - **TPS62361B/63: 0.5V to 1.77V, 10mV Steps**
- **Excellent DC/AC Output Voltage Regulation**
 - **Differential Load Sensing**
 - **Precise DC Output Voltage Accuracy**
 - **DCS-Control™ Architecture for Fast and Precise Transient Regulation**
- **Multiple Robust Operation/Protection Features:**
 - **Soft Start**
 - **Programmable Slew Rate at Voltage Transition**
 - **Over Temperature Protection**
 - **Input Under Voltage Detection and Lockout**
- **Available in 16-Bump, 2mm x 2mm NanoFree™ Package**
- **Low External Device Count: < 25mm² Solution Size**

APPLICATIONS

- **Dynamic Voltage Scale Compliant Processors and DSPs, Memory**
- **SmartReflex™ Compliant Power Supply**
- **Cell Phones, Smart Phones, Feature Phones**
- **Tablets, Netbooks, Clamshells**

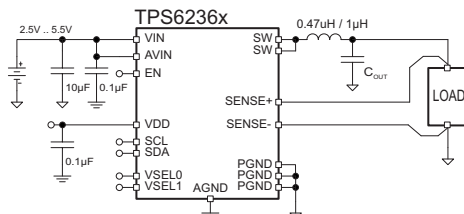

DESCRIPTION

The TPS6236x are a family of high-frequency synchronous step down dc-dc converter optimized for battery-powered portable applications for a small solution size. With an input voltage range of 2.5V to 5.5V, common battery technologies are supported. The device provides up to 3A peak load current, operating at 2.5MHz typical switching frequency.

The devices convert to an output voltage range of 0.77V to 1.4V (TPS62360/62) and 0.5V to 1.77V (TPS62361B/63), programmable via I²C interface in 10mV steps. Dedicated inputs allow fast voltage transition to address processor performance operating points.

The TPS6236x supports low-voltage DSPs and processor cores in smart-phones and handheld computers including latest submicron processes. Dedicated hardware input pins allow simple transitions to performance operating points and retention modes of processors.

The devices focus on a high output voltage accuracy. The differential sensing and the DCS-Control™ architecture achieve precise static and dynamic, transient output voltage regulation.

The TPS6236x devices offer high efficiency step down conversion. The area of highest efficiency is extended towards low output currents to increase the efficiency while the processor is operating in retention mode, as well as towards highest output currents increasing the battery on-time.

The robust architecture and multiple safety features allow perfect system integration.

The 2mm x 2mm package and the low number of required external components lead to a tiny solution size of less than 25mm².

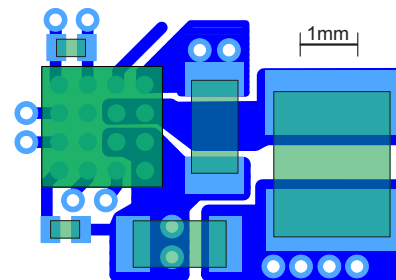

Please be aware that an important notice concerning availability, standard warranty, and use in critical applications of Texas Instruments semiconductor products and disclaimers thereto appears at the end of this data sheet.

DCS-Control, NanoFree, SmartReflex are trademarks of Texas Instruments.



These devices have limited built-in ESD protection. The leads should be shorted together or the device placed in conductive foam during storage or handling to prevent electrostatic damage to the MOS gates.

ORDERING INFORMATION

PART NUMBER	PACKAGE MARKING	PACKAGE	DEVICE SPECIFIC FEATURES ⁽¹⁾	
			Output Voltage Range	Output Voltage Presets
TPS62360 ⁽²⁾	See PACKAGE SUMMARY Section	CSP-16	V _{OUT} = 0.77V to 1.4V, 10mV Steps	1.40V, 1.00V, 1.40V, 1.10V
TPS62361B ⁽²⁾	See PACKAGE SUMMARY Section	CSP-16	V _{OUT} = 0.5V to 1.77V, 10mV Steps	0.96V, 1.40V, 1.16V, 1.16V
TPS62362 ⁽²⁾	See PACKAGE SUMMARY Section	CSP-16	V _{OUT} = 0.77V to 1.4V, 10mV Steps	1.23V, 1.00V, 1.20V, 1.10V
TPS62363 ⁽²⁾	See PACKAGE SUMMARY Section	CSP-16	V _{OUT} = 0.5V to 1.77V, 10mV Steps	1.20V, 1.36V, 1.50V, 1.00V

- (1) Contact the factory to check availability of other output voltage or feature versions.
 (2) The YZH package is available in tape and reel. Add R suffix (e.g. TPS62360YZHR) to order quantities of 3000 parts per reel, T suffix for 250 parts per reel (e.g. TPS62360YZHT). For the most current package and ordering information, see the Package Option Addendum at the end of this document, or visit the device product folder on ti.com.

ABSOLUTE MAXIMUM RATINGS

over operating free-air temperature range (unless otherwise noted)⁽¹⁾

		VALUE		UNIT
		MIN	MAX	
Voltage range ⁽²⁾	VIN, AVIN, SW pin	-0.3	7	V
	EN, VSEL0, VSEL1, SENSE+	-0.3	(V _{AVIN} +0.3V)	V
	SENSE-	-0.3	0.3	V
	SCL, SDA	-0.3	(V _{DD} +0.3V)	V
	VDD	-0.3	3.6	V
Continuous RMS VIN / SW current per Pin ⁽³⁾			1275	mA
Temperature range	Operating junction temperature, T _J	-40	150	°C
	Storage temperature, T _{stg}	-65	150	°C
ESD rating ⁽⁴⁾	Machine model		200	V
	Charge device model		500	V
	Human body model		2	kV

- (1) Stresses beyond those listed under absolute maximum ratings may cause permanent damage to the device. These are stress ratings only, and functional operation of the device at these or any other conditions beyond those indicated under recommended operating conditions is not implied. Exposure to absolute-maximum-rated conditions for extended periods may affect device reliability.
 (2) All voltage values are with respect to network ground terminal.
 (3) In order to be consistent with the TI reliability requirement for the silicon chips (100K Power-On-Hours at 105°C junction temperature), the current should not continuously exceed 1275mA in the VIN pin and 2550mA in the SW pins so as to prevent electromigration failure in the solder. See [THERMAL AND DEVICE LIFE TIME INFORMATION](#).
 (4) The human body model is a 100-pF capacitor discharged through a 1.5-kΩ resistor into each pin. The machine model is a 200-pF capacitor discharged directly into each pin.

THERMAL INFORMATION

THERMAL METRIC ⁽¹⁾		TPS6236x	UNITS
		YZH	
		16 PINS	
θ_{JA}	Junction-to-ambient thermal resistance ⁽²⁾	94.8	°C/W
θ_{JCTop}	Junction-to-case (top) thermal resistance ⁽³⁾	25	
θ_{JB}	Junction-to-board thermal resistance ⁽⁴⁾	60	
ψ_{JT}	Junction-to-top characterization parameter ⁽⁵⁾	3.2	
ψ_{JB}	Junction-to-board characterization parameter ⁽⁶⁾	57	
θ_{JCbott}	Junction-to-case (bottom) thermal resistance ⁽⁷⁾	n/a	

- (1) For more information about traditional and new thermal metrics, see the *IC Package Thermal Metrics* application report, [SPRA953](#).
- (2) The junction-to-ambient thermal resistance under natural convection is obtained in a simulation on a JEDEC-standard, high-K board, as specified in JESD51-7, in an environment described in JESD51-2a.
- (3) The junction-to-case (top) thermal resistance is obtained by simulating a cold plate test on the package top. No specific JEDEC-standard test exists, but a close description can be found in the ANSI SEMI standard G30-88.
- (4) The junction-to-board thermal resistance is obtained by simulating in an environment with a ring cold plate fixture to control the PCB temperature, as described in JESD51-8.
- (5) The junction-to-top characterization parameter, ψ_{JT} , estimates the junction temperature of a device in a real system and is extracted from the simulation data for obtaining θ_{JA} , using a procedure described in JESD51-2a (sections 6 and 7).
- (6) The junction-to-board characterization parameter, ψ_{JB} , estimates the junction temperature of a device in a real system and is extracted from the simulation data for obtaining θ_{JA} , using a procedure described in JESD51-2a (sections 6 and 7).
- (7) The junction-to-case (bottom) thermal resistance is obtained by simulating a cold plate test on the exposed (power) pad. No specific JEDEC standard test exists, but a close description can be found in the ANSI SEMI standard G30-88.

RECOMMENDED OPERATING CONDITIONS

		MIN	TYP	MAX	UNIT	
V_{IN}	Input voltage range, V_{IN}	$I_{OUT} \leq 2.5A$		2.5	5.5	V
		$I_{OUT} > 2.5A$		3	5.5	V
$I_{OUT,avg}$	Continuous output current ⁽¹⁾			2.5	A	
t_{rf}	Rising and falling signal transition time at EN, VSELx		30		mV/ μ s	
T_A	Operating ambient temperature ⁽²⁾	-40		85	°C	
T_J	Operating junction temperature	-40		125	°C	

- (1) The TPS6236x device is designed to provide 3A according to typical application processor load profiles. Drawing more than 2.5A permanently might impact the device life time. See [THERMAL AND DEVICE LIFE TIME INFORMATION](#) for details.
- (2) In applications where high power dissipation and/or poor package thermal resistance is present, the maximum ambient temperature may have to be derated. Maximum ambient temperature [$T_{A(max)}$] is dependent on the maximum operating junction temperature [$T_{J(max)}$], the maximum power dissipation of the device in the application [$P_{D(max)}$], and the junction-to-ambient thermal resistance of the part/package in the application (θ_{JA}), as given by the following equation: $T_{A(max)} = T_{J(max)} - (\theta_{JA} \times P_{D(max)})$

ELECTRICAL CHARACTERISTICS

Unless otherwise noted the specification applies for $V_{IN} = 3.6V$ over an operating ambient temp. $-40^{\circ}C \leq T_A \leq 85^{\circ}C$; Circuit of Parameter Measurement Information section (unless otherwise noted). Typical values are for $T_A = 25^{\circ}C$.

PARAMETER		TEST CONDITIONS		MIN	TYP	MAX	UNIT
INPUT							
V_{IN}	Input voltage range at V_{IN} , AV_{IN}			2.5		5.5	V
V_{DD}	I ² C and registers supply voltage range			1.15		3.6	V
$I_{SD(AVIN)}$	Shutdown current into AV_{IN}	EN = LOW, $V_{DD} = 0V$			0.65	5	μ A
$I_{SD(VIN)}$	Shutdown current into V_{IN}	EN = LOW, $V_{DD} = 0V$	$T_A = 25^{\circ}C$		0.5	1	μ A
			$T_A = 85^{\circ}C$		1	3	μ A
$I_{SD(VDD)}$	Shutdown current into V_{DD}	EN = LOW, I ² C bus idle			0.01		μ A

ELECTRICAL CHARACTERISTICS (continued)

Unless otherwise noted the specification applies for $V_{IN} = 3.6V$ over an operating ambient temp. $-40^{\circ}C \leq T_A \leq 85^{\circ}C$; Circuit of Parameter Measurement Information section (unless otherwise noted). Typical values are for $T_A = 25^{\circ}C$.

PARAMETER		TEST CONDITIONS		MIN	TYP	MAX	UNIT
I_Q	Operating quiescent current into (AVIN + VIN)	EN = HIGH, $I_{OUT} = 0mA$, not switching	PFM mode		56		μA
			Forced PWM mode (Test Mode)		180		μA
V_{UVLO}	Under voltage lock out at AVIN	Input voltage falling, EN = High			2.3	2.45	V
		Input voltage rising, EN = Low			1.3		V
$V_{UVLO,HYST(AVIN)}$	Under voltage lock out hysteresis at AVIN	Input voltage rising			110		mV
$V_{DD,UVLO}$	Under voltage lock out at VDD	Input voltage falling		0.7	0.92	1.1	V
$V_{UVLO,HYST(VDD)}$	Under voltage lock out hysteresis at VDD	Input voltage rising			50		mV
I_{VDD}	Input current at VDD	I^2C not active			0		μA
		I^2C active (r/w)			0.02	1	mA
LOGIC INTERFACE							
V_{IH}	High-level input voltage at EN, VSEL0, VSEL1			1.2			V
V_{IL}	Low-level input voltage at EN, VSEL0, VSEL1					0.4	V
$V_{IH,I2C}$	High-level input voltage at SCL, SDA			$0.7x V_{DD}$			V
$V_{IL,I2C}$	Low-level input voltage at SCL, SDA					$0.3x V_{DD}$	V
I_{LKG}	Logic input leakage current at EN, VSEL0, VSEL1, SDA, SCL	Internal pulldown resistors disabled			0.05		μA
R_{PD}	Pull down resistance at EN, VSEL0, VSEL1	Internal pulldown resistors enabled			300		k Ω
	I^2C clock frequency	Fast mode				400	kHz
		High speed mode				3.4	MHz
POWER SWITCH							
$R_{DS(on)}$	High side MOSFET switch	$V_{IN} = 3.6V$		25	44	75	m Ω
	Low side MOSFET switch	$V_{IN} = 3.6V$		25	32	50	m Ω
I_{LIMF}	High side MOSFET forward current limit	$V_{IN} = 3.6V$		3.0	3.6	4.3	A
	Low side MOSFET forward current limit	$V_{IN} = 3.6V$		2.6	3	3.8	A
	Low side MOSFET negative current limit	$V_{IN} = 3.6V$, PWM mode		2.2	2.5	2.9	A
f_{SW}	Nominal switching frequency	PWM mode			2.5		MHz
T_{JEV}	Die temperature early warning				120		$^{\circ}C$
T_{JSD}	Thermal shutdown				150		$^{\circ}C$
$T_{JSD,HYST}$	Thermal shutdown hysteresis				20		$^{\circ}C$
$t_{ON,min}$	Minimum on time				120		ns
OUTPUT							
V_{OUT}	Output voltage range	10mV increments	TPS62360/62	0.77		1.4	V
			TPS62361B/63	0.5		1.77	
	Output voltage accuracy	TPS62360/62: $V_{IN} = 2.5V \dots 5.5V$ $V_{OUT} = 0.77V \dots 1.4V$	No load, Forced PWM, $V_{OUT} = [0.77V, 1.3V]$ $T_J = 85^{\circ}C$	-0.5%		+0.5%	
		TPS62361B/63: $V_{IN} = 2.7V \dots 5.5V$ $V_{OUT} = 0.5V \dots 1.77V$	No load, Forced PWM, $T_J = -40 \dots 150^{\circ}C$	-1%	$\pm 0.5\%$	+1%	

ELECTRICAL CHARACTERISTICS (continued)

Unless otherwise noted the specification applies for $V_{IN} = 3.6V$ over an operating ambient temp. $-40^{\circ}C \leq T_A \leq 85^{\circ}C$; Circuit of Parameter Measurement Information section (unless otherwise noted). Typical values are for $T_A = 25^{\circ}C$.

PARAMETER		TEST CONDITIONS	MIN	TYP	MAX	UNIT
	Line regulation	$I_{OUT} = 1A$, forced PWM		< 0.1		%/V
	Load regulation	$V_{OUT} = 1.2V$, forced PWM		< 0.05		%/A
t_{Start}	Start-up time	Time from active EN to $V_{OUT} = 1.4V$, $C_{OUT} < 100\mu F$, RMP[2:0] = 000, $I_{OUT} = 0mA$			1	ms
R_{Sense}	Input resistance between Sense+, Sense–			2.2		MΩ
	Ramp timer	RMP[2:0] = 000		32		mV/μs
		RMP[2:0] = 001		16		
		RMP[2:0] = 010		8		
		RMP[2:0] = 011		4		
		RMP[2:0] = 100		2		
		RMP[2:0] = 101		1		
		RMP[2:0] = 110		0.5		
		RMP[2:0] = 111		0.25		

I²C INTERFACE TIMING REQUIREMENTS⁽¹⁾⁽²⁾

PARAMETER		TEST CONDITIONS	MIN	MAX	UNIT
f _(SCL)	SCL clock frequency	Standard mode		100	kHz
		Fast mode		400	kHz
		High-speed mode (write operation), C _B – 100 pF max		3.4	MHz
		High-speed mode (read operation), C _B – 100 pF max		3.4	MHz
		High-speed mode (write operation), C _B – 400 pF max		1.7	MHz
		High-speed mode (read operation), C _B – 400 pF max		1.7	MHz
t _{BUF}	Bus free time between a STOP and START condition	Standard mode	4.7		μs
		Fast mode	1.3		μs
t _{HD} , t _{STA}	Hold time (repeated) START condition	Standard mode	4		μs
		Fast mode	600		ns
		High-speed mode	160		ns
t _{LOW}	Low period of the SCL clock	Standard mode	4.7		μs
		Fast mode	1.3		μs
		High-speed mode, C _B – 100 pF max	160		ns
		High-speed mode, C _B – 400 pF max	320		ns
t _{HIGH}	High period of the SCL clock	Standard mode	4		μs
		Fast mode	600		ns
		High-speed mode, C _B – 100 pF max	60		ns
		High-speed mode, C _B – 400 pF max	120		ns
t _{SU} , t _{STA}	Setup time for a repeated START condition	Standard mode	4.7		μs
		Fast mode	600		ns
		High-speed mode	160		ns
t _{SU} , t _{DAT}	Data setup time	Standard mode	250		ns
		Fast mode	100		ns
		High-speed mode	10		ns
t _{HD} , t _{DAT}	Data hold time	Standard mode	0	3.45	μs
		Fast mode	0	0.9	μs
		High-speed mode, C _B – 100 pF max	0	70	ns
		High-speed mode, C _B – 400 pF max	0	150	ns
t _{RCL}	Rise time of SCL signal	Standard mode	20 + 0.1 C _B	1000	ns
		Fast mode	20 + 0.1 C _B	300	ns
		High-speed mode, C _B – 100 pF max	10	40	ns
		High-speed mode, C _B – 400 pF max	20	80	ns
t _{RCL1}	Rise time of SCL signal after a repeated START condition and after an acknowledge bit	Standard mode	20 + 0.1 C _B	1000	ns
		Fast mode	20 + 0.1 C _B	300	ns
		High-speed mode, C _B – 100 pF max	10	80	ns
		High-speed mode, C _B – 400 pF max	20	160	ns
t _{FCL}	Fall time of SCL signal	Standard mode	20 + 0.1 C _B	300	ns
		Fast mode	20 + 0.1 C _B	300	ns
		High-speed mode, C _B – 100 pF max	10	40	ns
		High-speed mode, C _B – 400 pF max	20	80	ns

(1) S/M = standard mode; F/M = fast mode

(2) Specified by design. Not tested in production.

I²C INTERFACE TIMING REQUIREMENTS⁽¹⁾⁽²⁾ (continued)

PARAMETER		TEST CONDITIONS	MIN	MAX	UNIT
t _{RDA}	Rise time of SDA signal	Standard mode	20 + 0.1 C _B	1000	ns
		Fast mode	20 + 0.1 C _B	300	ns
		High-speed mode, C _B – 100 pF max	10	80	ns
		High-speed mode, C _B – 400 pF max	20	160	ns
t _{FDA}	Fall time of SDA signal	Standard mode	20 + 0.1 C _B	300	ns
		Fast mode	20 + 0.1 C _B	300	ns
		High-speed mode, C _B – 100 pF max	10	80	ns
		High-speed mode, C _B – 400 pF max	20	160	ns
t _{SU} , t _{STO}	Setup time for STOP condition	Standard mode	4		μs
		Fast mode	600		ns
		High-speed mode	160		ns
C _B	Capacitive load for SDA and SCL		400		pF

I²C TIMING DIAGRAMS

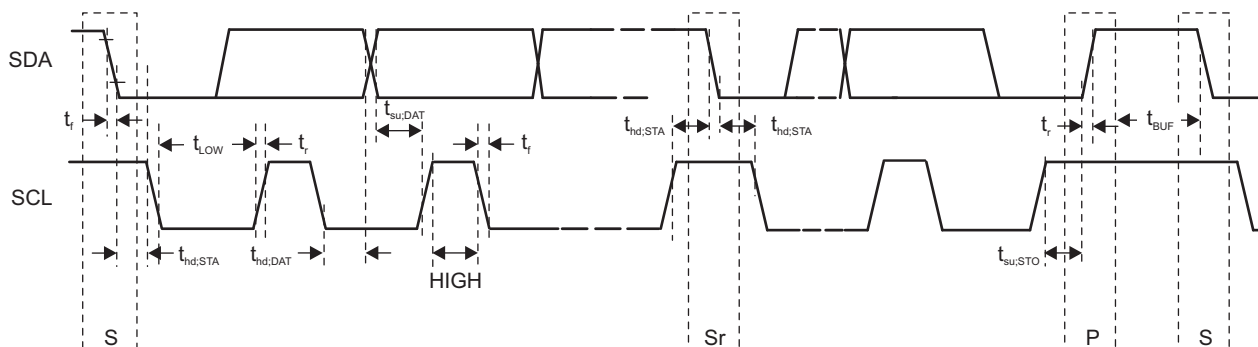
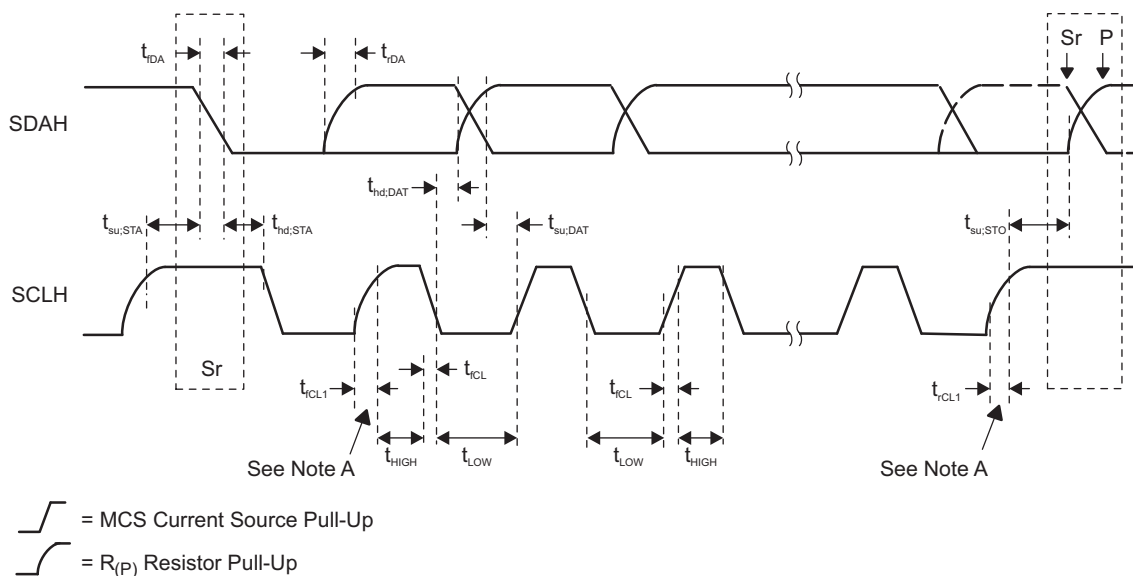

Figure 1. Serial Interface Timing for F/S Mode



= MCS Current Source Pull-Up
 = R_(p) Resistor Pull-Up

Note A: First rising edge of the SCLH signal after Sr and after each acknowledge bit.

Figure 2. Serial Interface Timing for H/S Mode

DEVICE INFORMATION

PIN ASSIGNMENTS

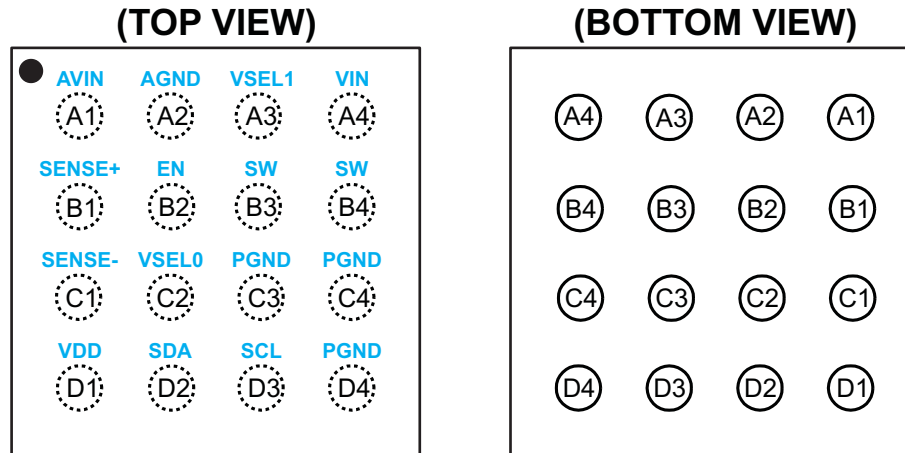

PIN FUNCTIONS

PIN		I/O	DESCRIPTION
NAME	NO.		
AVIN	A1	I	Analog Supply Voltage Input.
AGND	A2	–	Analog Ground Connection.
EN	B2	I	Device Enable Logic Input. Logic HIGH enables the device, logic LOW disables the device and turns it into shutdown. The pin must be terminated to either HIGH or LOW if the internal pull down resistor is deactivated.
VDD	D1	I	I ² C Logic and Registers supply voltage. For resetting the internal registers, this connection must be pulled below its UVLO level.
SCL	D3	I/O	I ² C clock signal.
SDA	D2	I/O	I ² C data signal.
VSEL0	C2	I	Output Settings Selection Logic Inputs. Predefined register settings can be chosen for setting output voltage and mode. The pins must be terminated to logic HIGH or LOW if the internal pull down resistors are deactivated.
VSEL1	A3	I	
SW	B3	–	Inductor connection
	B4		
SENSE+	B1	I	Positive Output Voltage Remote Sense. Must be connected closest to the load supply node.
SENSE–	C1	I	Negative Output Voltage Remote Sense. Must be connected closest to the load ground node.
VIN	A4	I	Power Supply Voltage Input.
PGND	C3	–	Power Ground Connection.
	C4		
	D4		

FUNCTIONAL BLOCK DIAGRAM

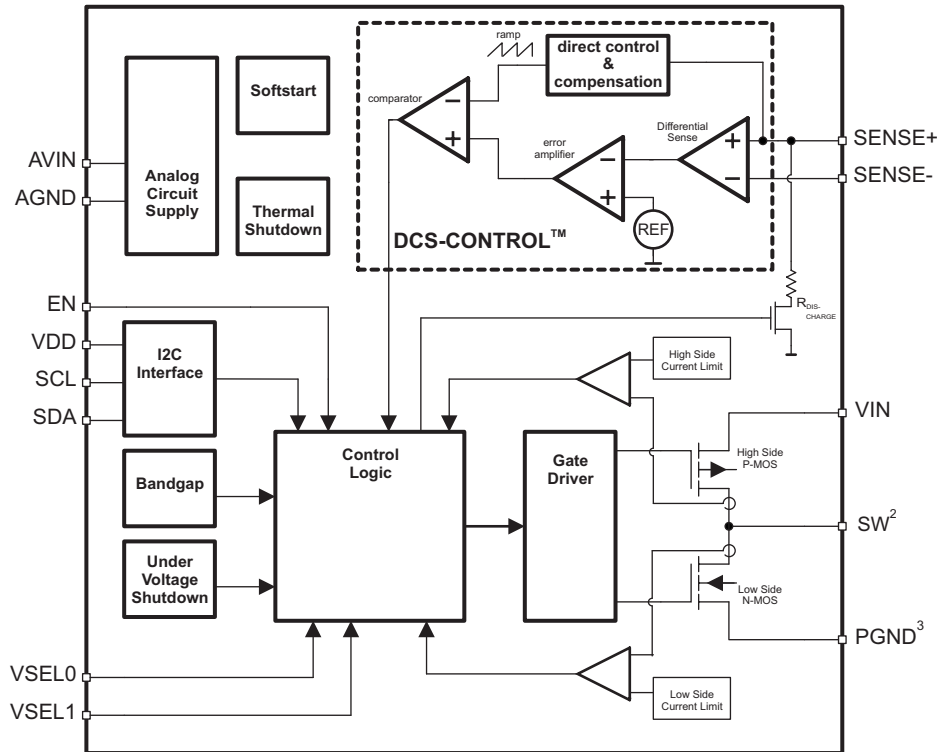

TYPICAL CHARACTERISTICS

Table of Graphs

			FIGURE	
η	Efficiency	vs. Output Current (Power Save and Forced PWM Mode)	$V_{OUT} = 1.5V$	Figure 3
			$V_{OUT} = 1.4V$	Figure 4
			$V_{OUT} = 1.2V$	Figure 5
			$V_{OUT} = 1.1V$	Figure 6
			$V_{OUT} = 1.0V$	Figure 7
			$V_{OUT} = 0.9V$	Figure 8
		vs. Input Voltage (Power Save and Forced PWM Mode)	$I_{OUT} = 3000mA$	Figure 10
			$I_{OUT} = 1000mA$	Figure 11
			$I_{OUT} = 100mA$	Figure 12
			$I_{OUT} = 10mA$	Figure 13
V_O	DC Output Voltage	vs. Output Current (Power Save and Forced PWM Mode)	$V_{OUT} = 1.5V, T_A = 25^\circ C$	Figure 14
			$V_{OUT} = 1.2V, T_A = 25^\circ C$	Figure 15
			$V_{OUT} = 0.9V, T_A = 25^\circ C$	Figure 16
			$V_{OUT} = 0.6V, T_A = 25^\circ C$	Figure 17
	Startup	Into No Load	$V_{OUT} = 0.5V, I_{OUT} = 0mA$	Figure 18
			$V_{OUT} = 1.5V, I_{OUT} = 0mA$	Figure 19
		Into Load	$V_{OUT} = 0.5V, I_{OUT} = 1000mA$	Figure 20
			$V_{OUT} = 1.5V, I_{OUT} = 1000mA$	Figure 21
	Switching Wave forms		$I_{OUT} = 10mA$	Figure 22
			$I_{OUT} = 200mA$	Figure 23
			$I_{OUT} = 1000mA$	Figure 24
			$I_{OUT} = 3000mA$	Figure 25
	Output Voltage Ramp Control	Transition 0.6V .. 1.5V	$I_{OUT} = 0mA$	Figure 26
			$I_{OUT} = 1000mA$	Figure 27
	Load Transient Response		$I_{OUT} = 5mA$ to 200mA	Figure 28
			$I_{OUT} = 5mA$ to 1000mA	Figure 29
			$I_{OUT} = 200mA$ to 1000mA	Figure 30
			$I_{OUT} = 1000mA$ to 3000mA	Figure 31
	Line Transient Response		$V_{IN} = 3.2$ to 4.2V	Figure 32
$I_{SD(VIN)}, I_{SD(AVIN)}$	Shutdown Current at AVIN and VIN	vs. Input Voltage	$T_A = [-40^\circ C, 25^\circ C, 125^\circ C]$	Figure 33
I_Q	Quiescent Current	vs. Input Voltage	$T_A = [-40^\circ C, 25^\circ C, 125^\circ C],$ auto PFM/PWM	Figure 34
			$T_A = [-40^\circ C, 25^\circ C, 125^\circ C]$ forced PWM	Figure 35
f_{SW}	Switching Frequency	vs. Output Current	$V_{OUT} = 1.2V$	Figure 36
I_{LIM}	Current Limit	vs. Input Voltage		Figure 37

TYPICAL CHARACTERISTICS (continued)

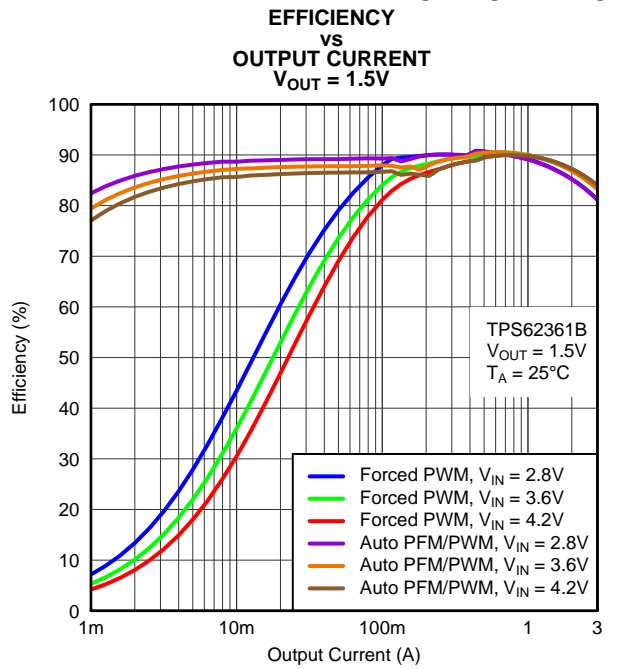

Figure 3.

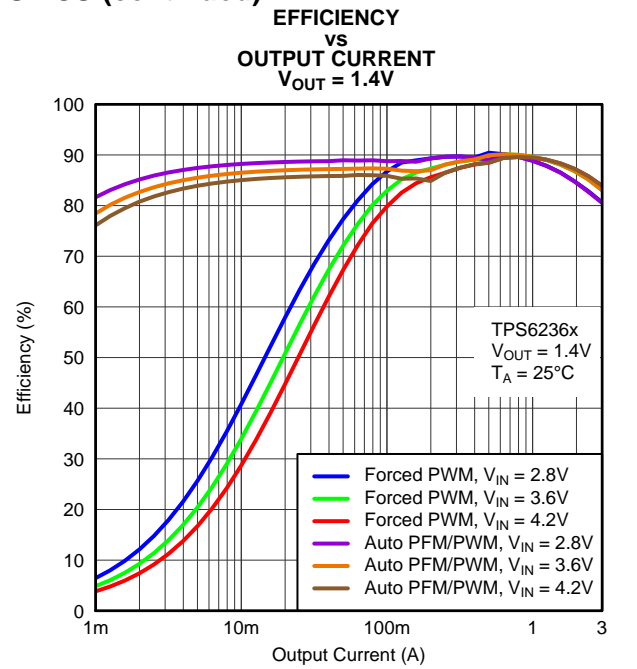

Figure 4.

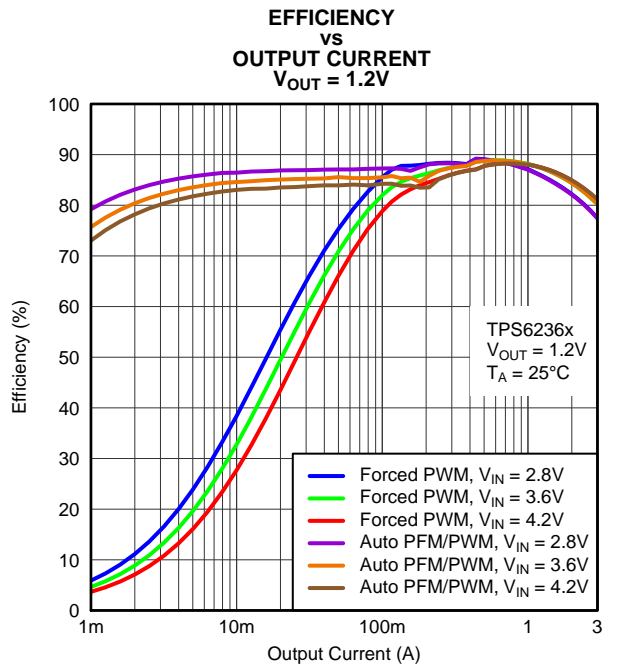

Figure 5.

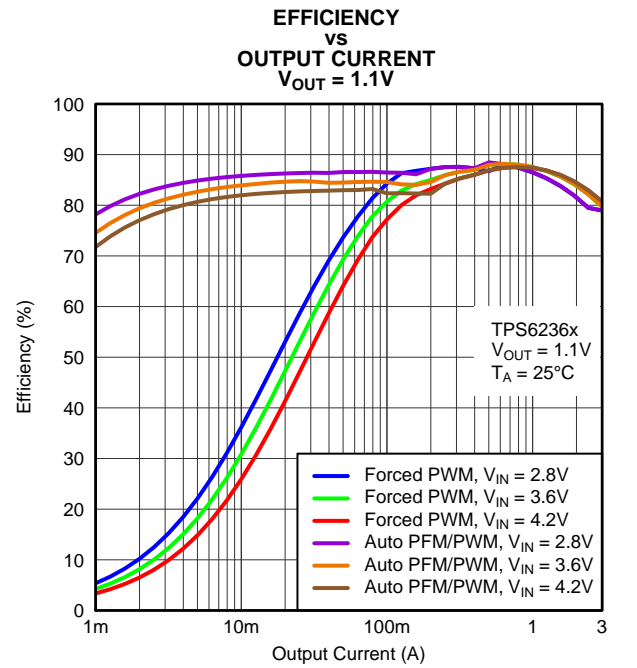

Figure 6.

TYPICAL CHARACTERISTICS (continued)

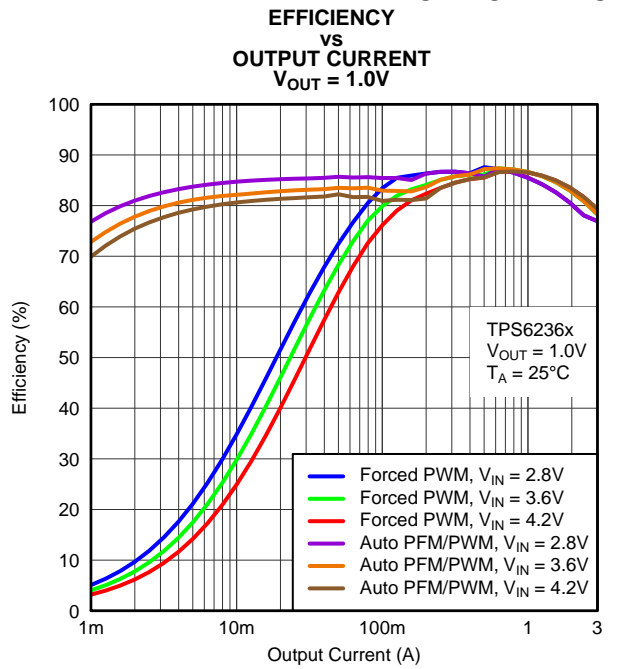

Figure 7.

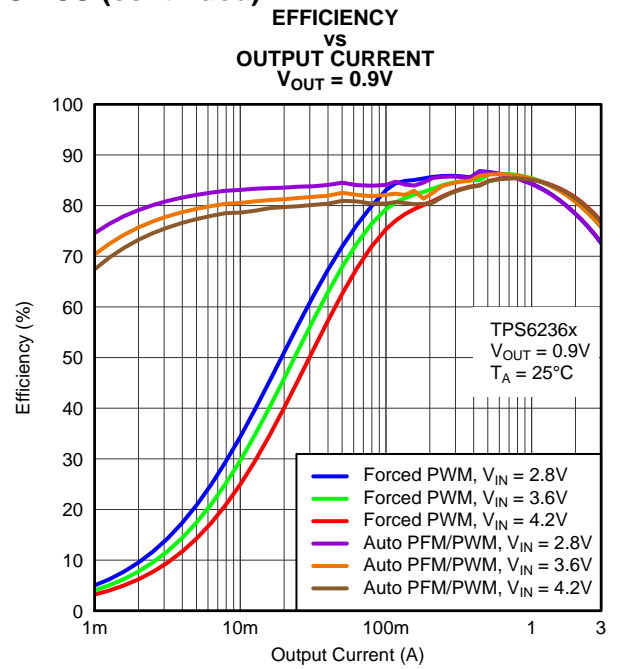

Figure 8.

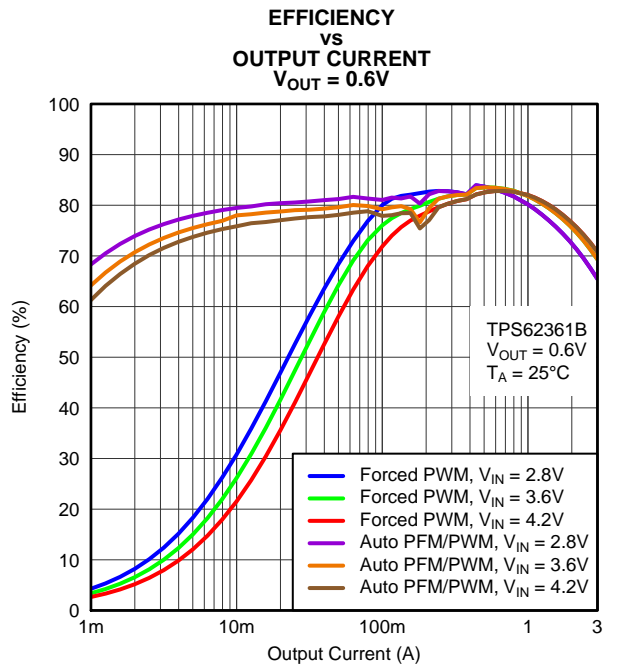

Figure 9.

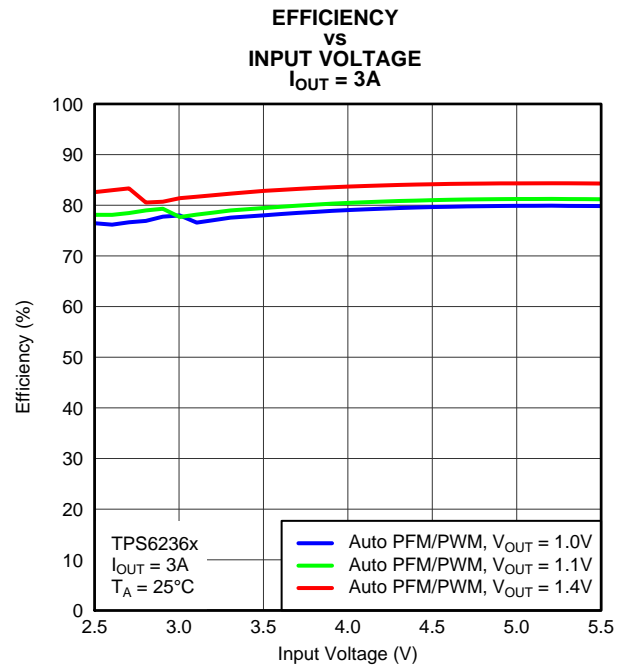

Figure 10.

TYPICAL CHARACTERISTICS (continued)

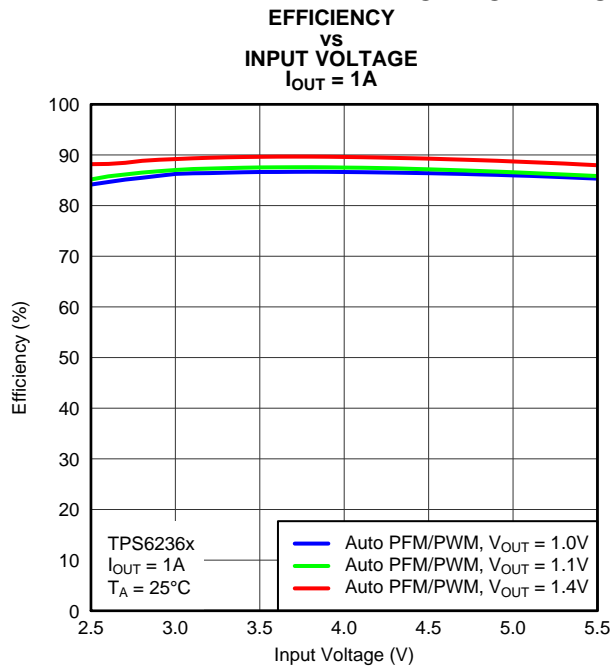

Figure 11.

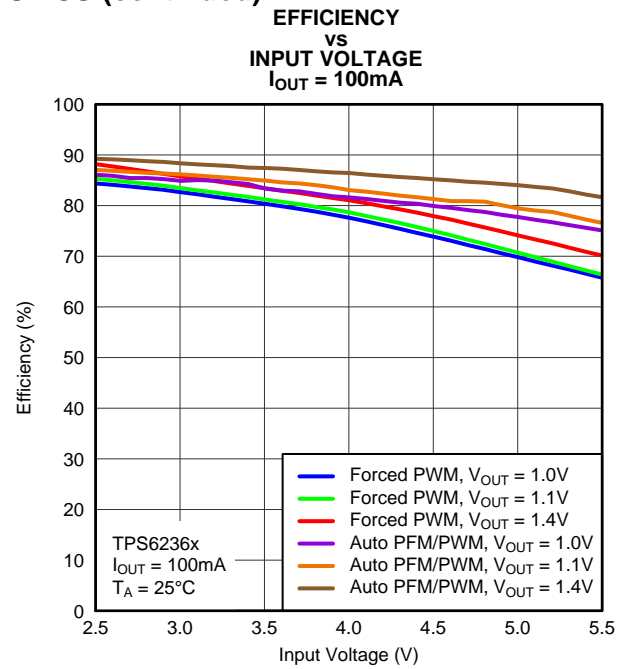

Figure 12.

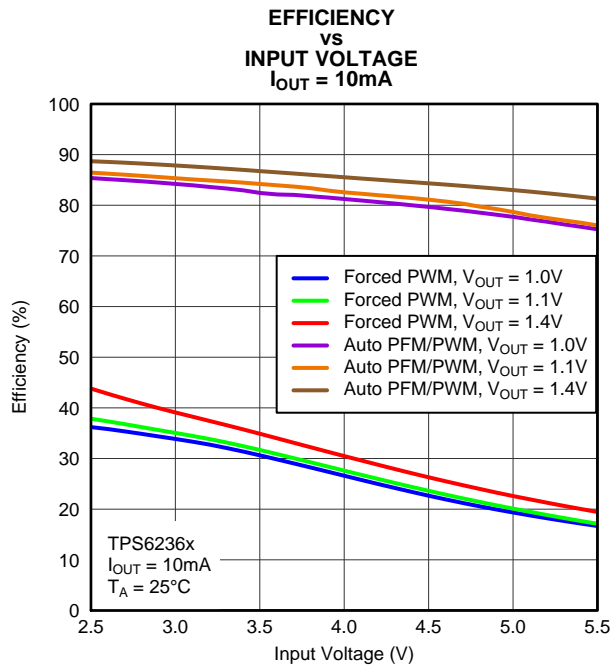

Figure 13.

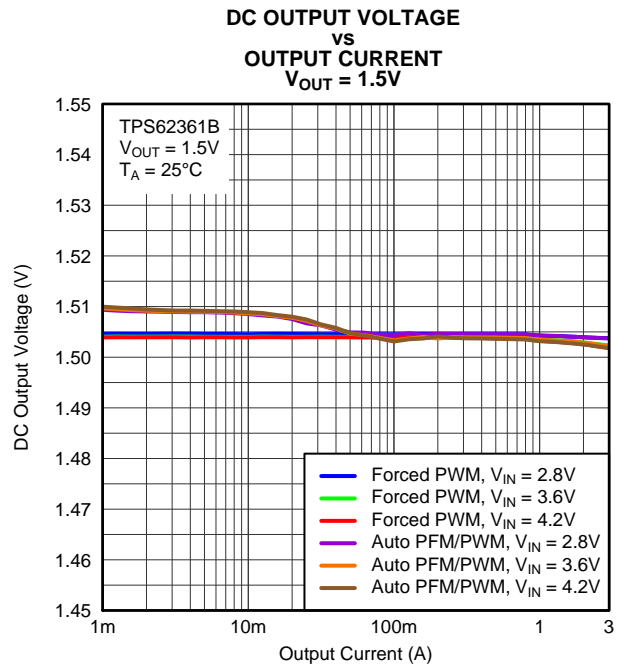

Figure 14.

TYPICAL CHARACTERISTICS (continued)

**DC OUTPUT VOLTAGE
vs
OUTPUT CURRENT
V_{OUT} = 1.2V**

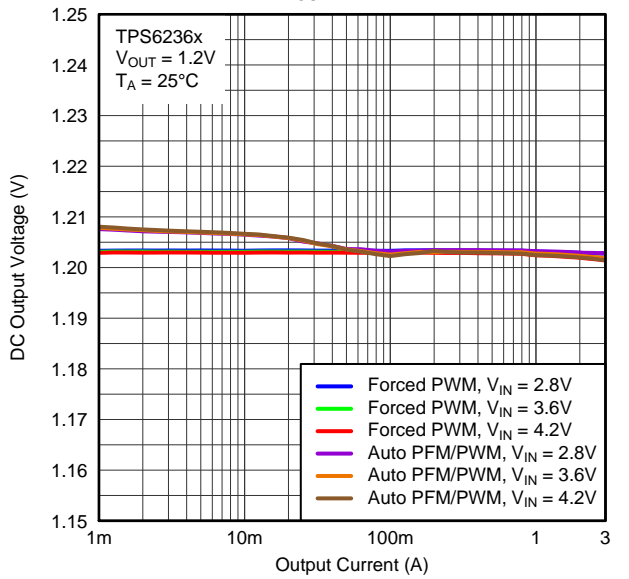

Figure 15.

**DC OUTPUT VOLTAGE
vs
OUTPUT CURRENT
V_{OUT} = 0.9V**

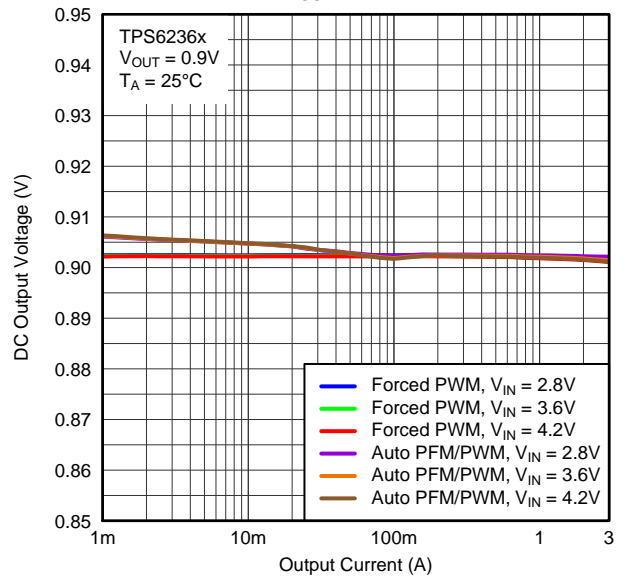

Figure 16.

**DC OUTPUT VOLTAGE
vs
OUTPUT CURRENT
V_{OUT} = 0.6V**

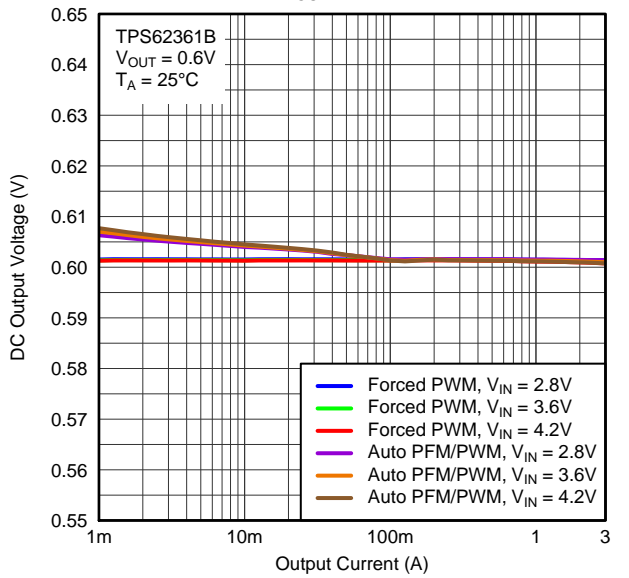

Figure 17.

**STARTUP INTO NO LOAD
V_{OUT} = 0.5V**

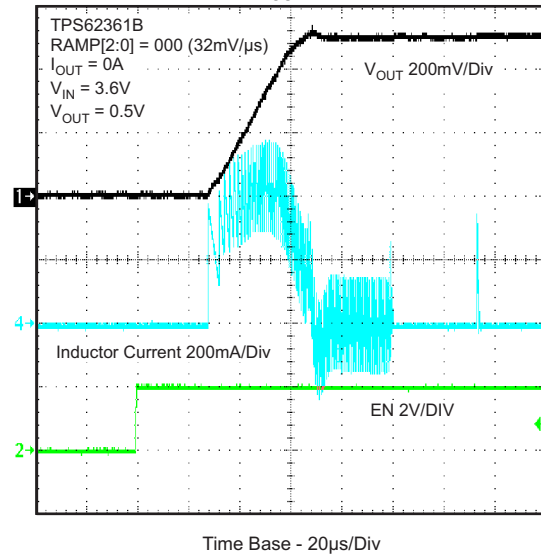
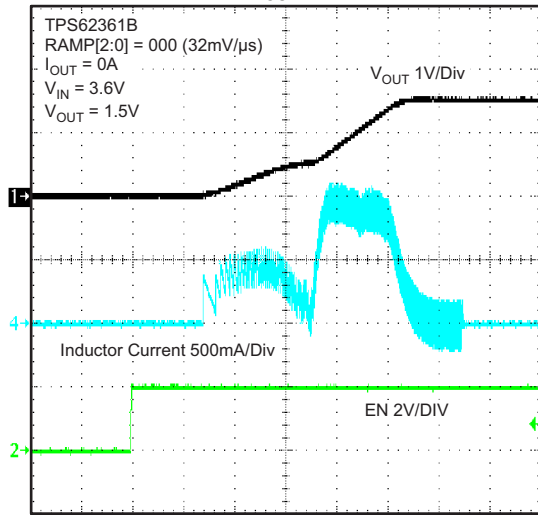

Figure 18.

TYPICAL CHARACTERISTICS (continued)

STARTUP INTO NO LOAD
V_{OUT} = 1.5V



Time Base - 20μs/Div

Figure 19.

G018

STARTUP INTO LOAD
V_{OUT} = 0.5V

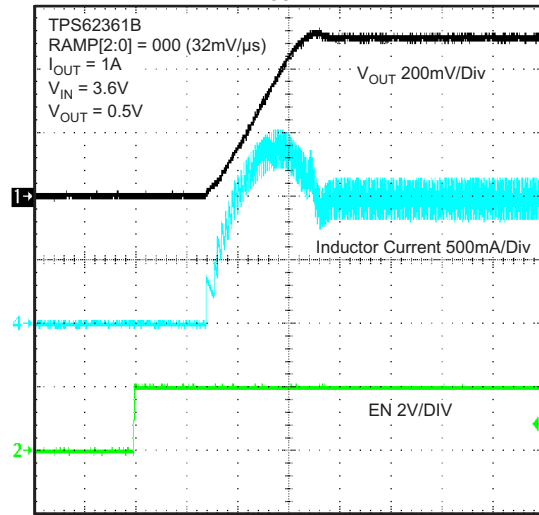

Time Base - 20μs/Div

Figure 20.

G019

STARTUP INTO LOAD
V_{OUT} = 1.5V

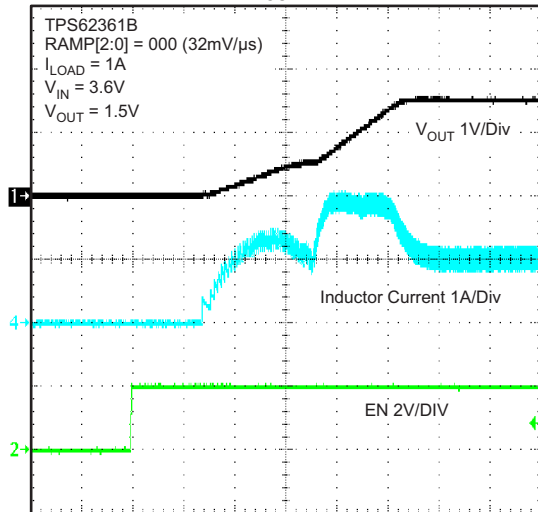

Time Base - 20μs/Div

Figure 21.

G020

SWITCHING WAVE FORMS
I_{OUT} = 10mA

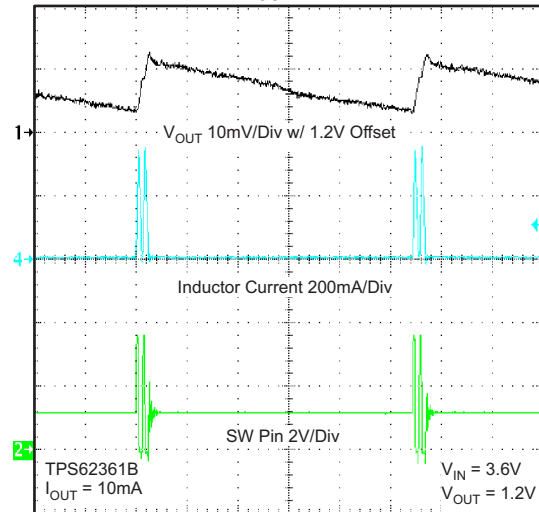

Time Base - 4μs/Div

Figure 22.

G021

TYPICAL CHARACTERISTICS (continued)

SWITCHING WAVE FORMS
 $I_{OUT} = 200\text{mA}$

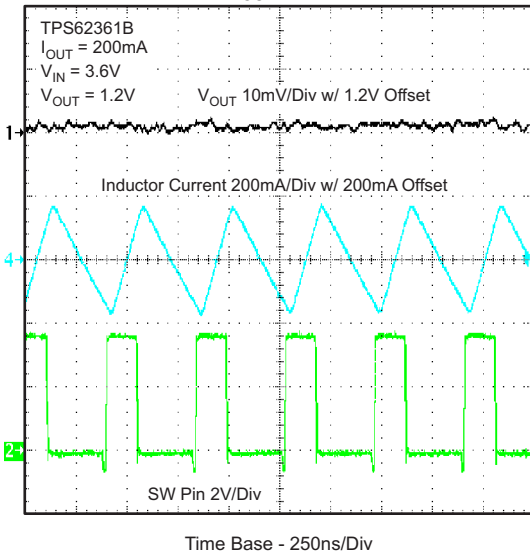

Figure 23.

G022

SWITCHING WAVE FORMS
 $I_{OUT} = 1\text{A}$

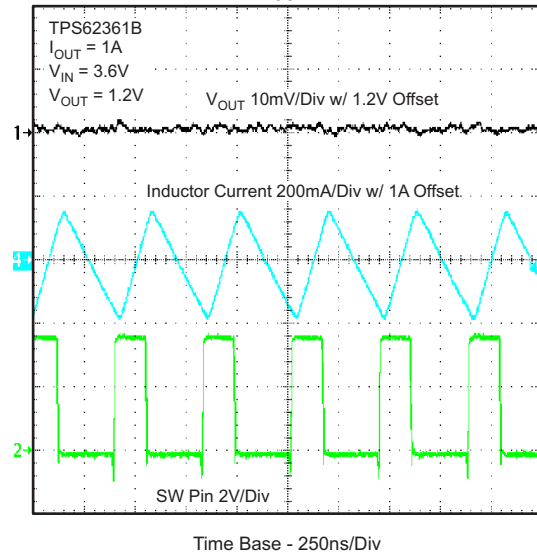

Figure 24.

G023

SWITCHING WAVE FORMS
 $I_{OUT} = 3\text{A}$

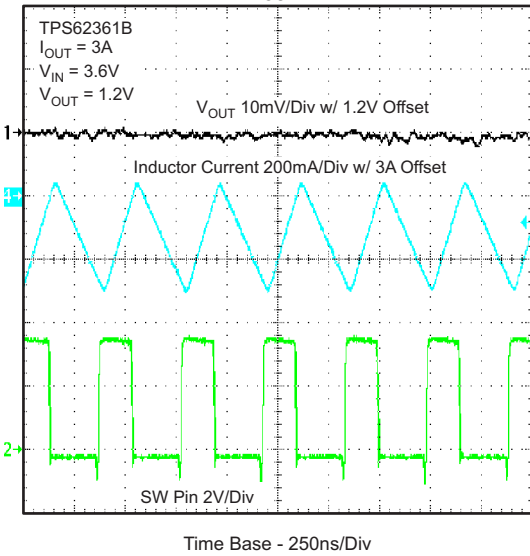

Figure 25.

G024

OUTPUT VOLTAGE RAMP CONTROL
 NO LOAD

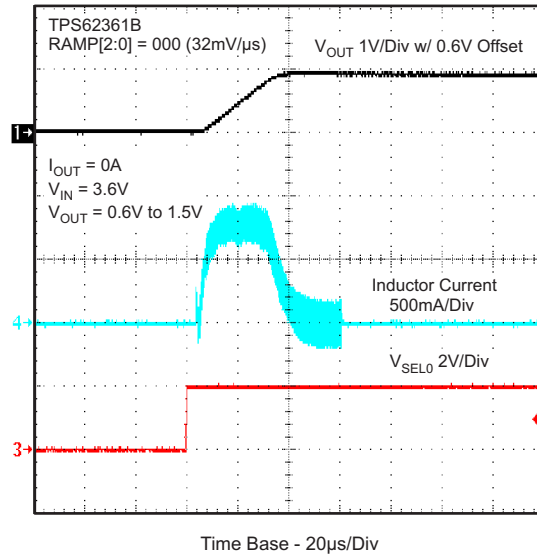

Figure 26.

G025

TYPICAL CHARACTERISTICS (continued)

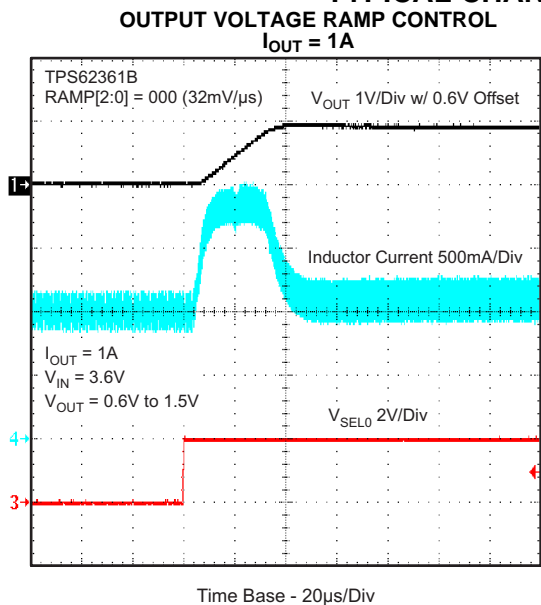

Figure 27.

G026

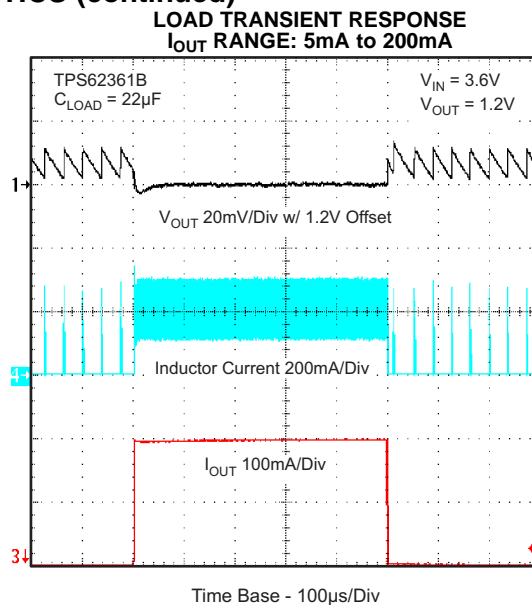

Figure 28.

G027

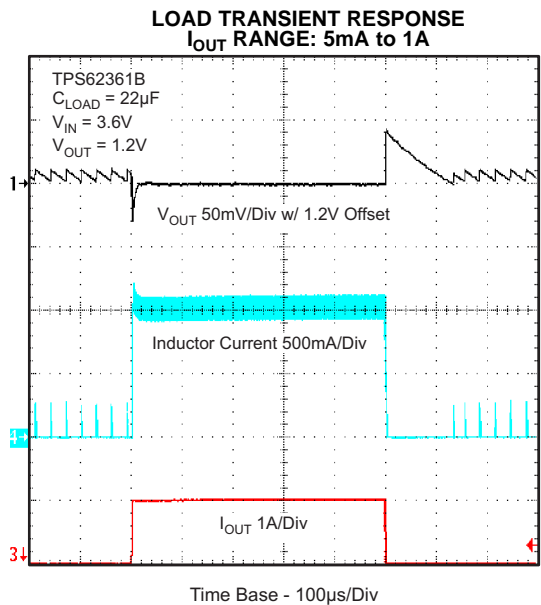

Figure 29.

G028

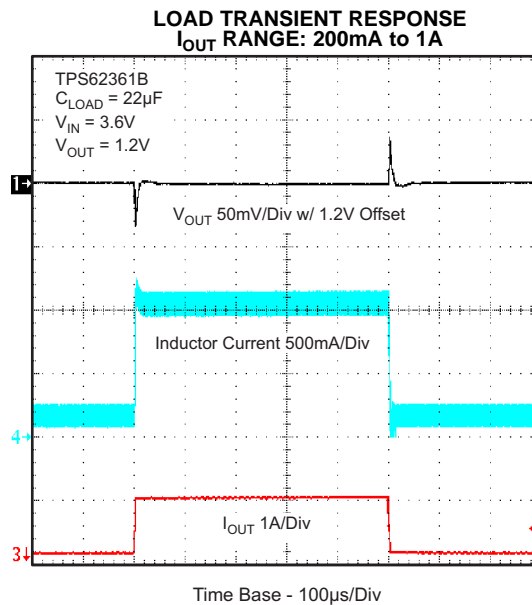

Figure 30.

G029

TYPICAL CHARACTERISTICS (continued)

LOAD TRANSIENT RESPONSE
I_{OUT} RANGE: 1A to 3A

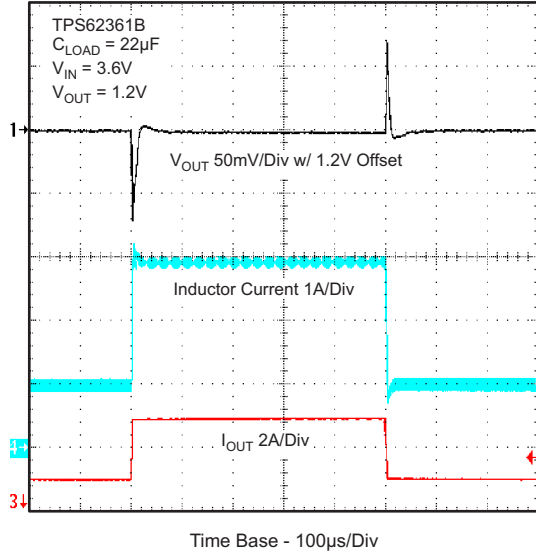

Figure 31.

G030

LINE TRANSIENT RESPONSE
V_{IN} RANGE: 4.2V to 3.2V

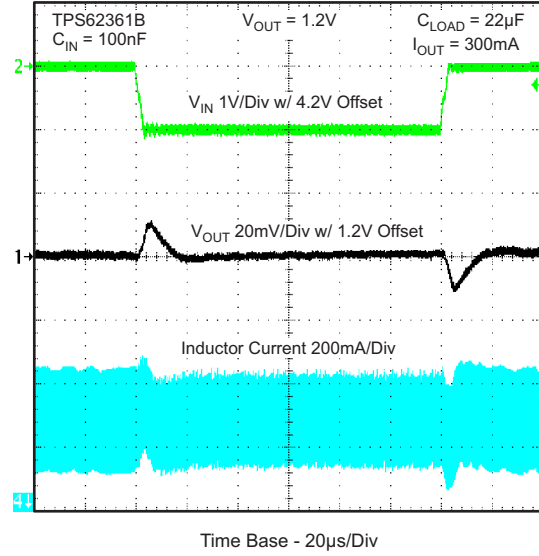

Figure 32.

G031

SHUTDOWN CURRENT
vs
INPUT VOLTAGE

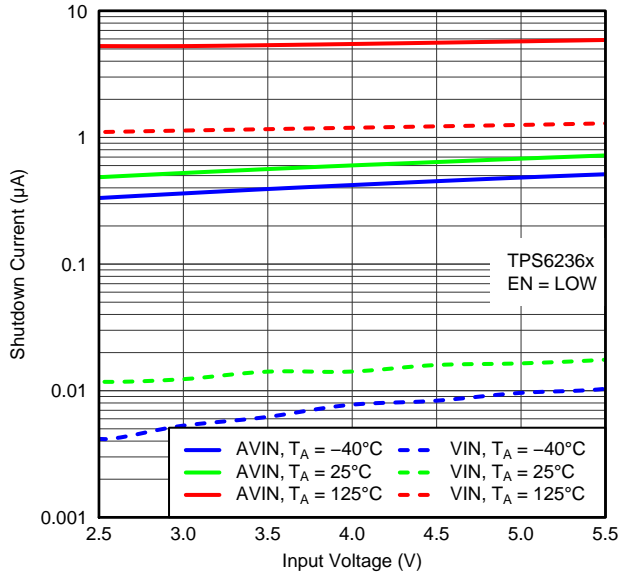

Figure 33.

G034

QUIESCENT CURRENT
vs
INPUT VOLTAGE

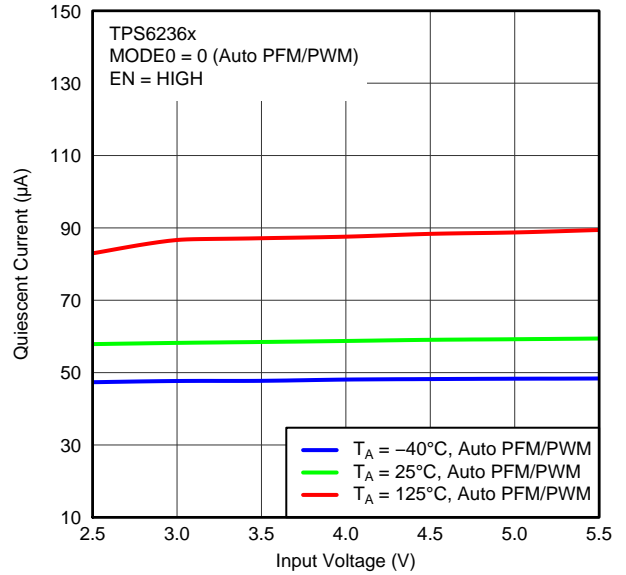

Figure 34.

G035

TYPICAL CHARACTERISTICS (continued)

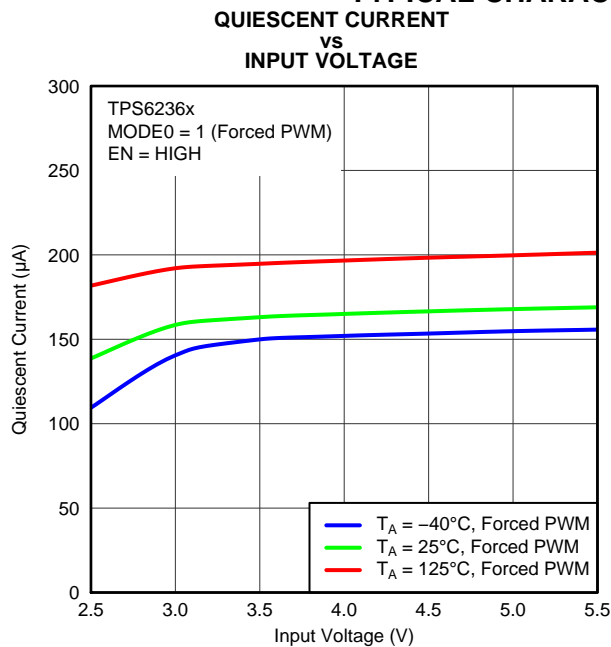

Figure 35.

G036

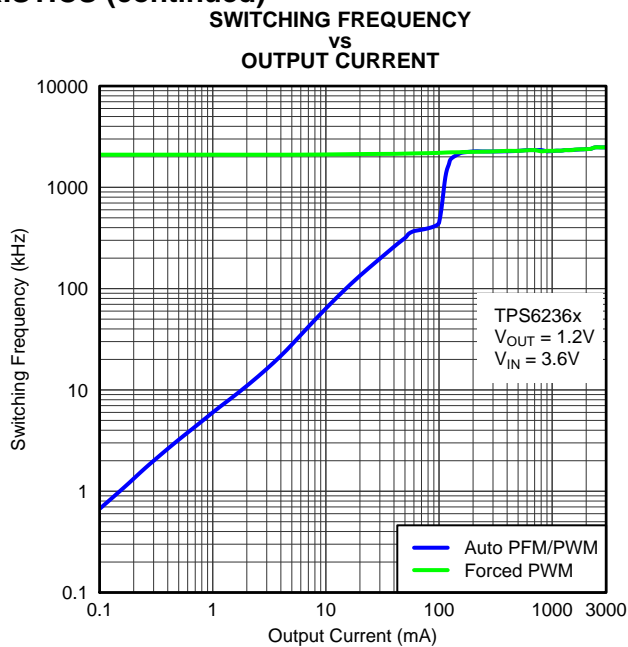

Figure 36.

G037

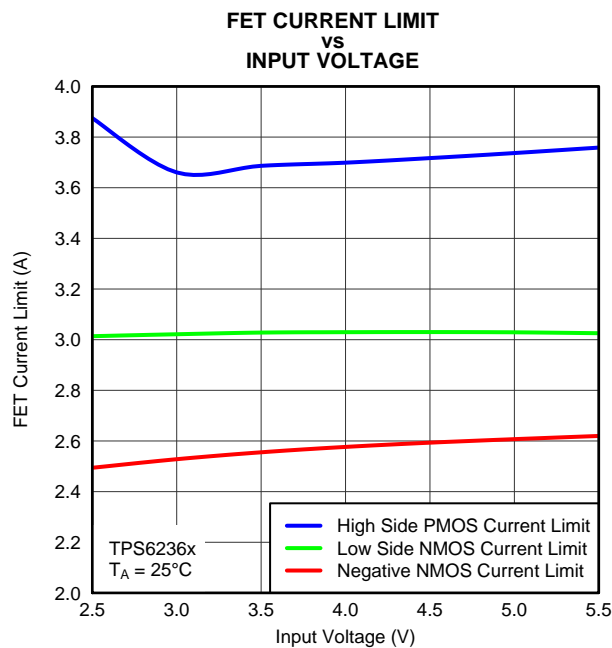

Figure 37.

G038

PARAMETER MEASUREMENT INFORMATION

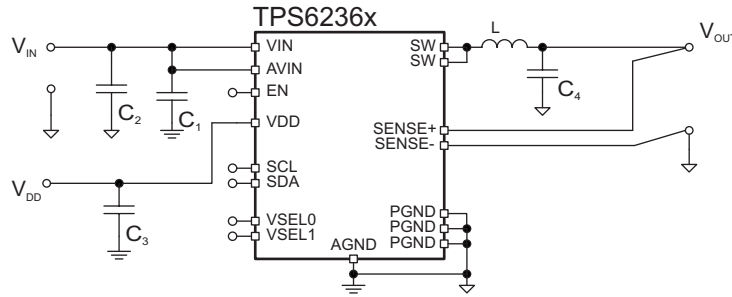

Table 1. List of Components

REFERENCE	DESCRIPTION	MANUFACTURER
TPS6236x	3A Processor Supply with I ² C Compatible Interface and Remote Sense	Texas Instruments
L	1 μ H, 4 mm x 4 mm x 2.1 mm	Coilcraft (XFL4020-102ME1.0)
C ₂ , C ₄	10 μ F, Ceramic, 6.3V, X5R	Murata (GRM188R60J106ME84D)
C ₁ , C ₃	0.1 μ F, Ceramic, 10V, X5R	Standard

DETAILED DESCRIPTION

The TPS6236x are a family of high-frequency synchronous step down dc-dc converter optimized for battery-powered portable applications. With an input voltage range of 2.5V to 5.5V, common battery technologies are supported.

The device provides up to 3A peak load current, operating at 2.5MHz typical switching frequency.

The devices convert to an output voltage range of 0.77V to 1.4V (TPS62360 / TPS62362) and 0.5V to 1.77V (TPS62361B / TPS62363), programmable via I²C interface in 10mV steps.

The TPS6236x supports low-voltage DSPs and processor cores in smart-phones and handheld computers, including latest submicron processes and their retention modes and addresses digital voltage scaling technologies such as SmartReflex™.

Output Voltages and Modes can be fully programmed via I²C. To address different performance operating points and/or startup conditions, the device offers four output voltage / mode presets which can be chosen via dedicated hardware input pins allowing simple and zero latency output voltage transition.

The devices focus on a high output voltage accuracy. The fully differential sensing and the DCS-Control™ architecture achieve precise static and dynamic, transient output voltage regulation. This accounts for stable processor operation. Output voltage security margins can be kept small, resulting in an increased overall system efficiency.

The TPS6236x devices offer high efficiency step down conversion. The area of highest efficiency is extended towards low output currents to increase the efficiency while the processor is operating in retention mode, as well as towards highest output currents reducing the power loss. This addresses the power profile of processors. High efficiency conversion is required for low output currents to support the retention modes of processors, resulting in an increased battery on-time. To address the processor maximum performance operating points with highest output currents, high efficiency conversion is enabled as well to save the battery on-time and reduce input power.

The robust architecture and multiple safety features allow perfect system integration.

The 2mm x 2mm package and the low number of required external components lead to a tiny solution size of approximately less than 25 mm².

OPERATION

The TPS6236x synchronous switched mode power converters are based on DCS-Control™, an advanced regulation topology, that combines the advantages of hysteretic, voltage mode and current mode control architectures.

While a comparator stage provides excellent load transient response, an additional voltage loop ensures high DC accuracy as well. The TPS6236x compensates ground shifts at the load by the differentially sensing the output voltage at the point of load.

The internal ramp generator adds information about the load current and fast output voltage changes. The internally compensated regulation network achieves fast and stable operation with low ESR capacitors.

The DCS-Control™ topology supports PWM (Pulse Width Modulation) mode for medium and heavy load conditions and a Power Save Mode at light loads. During PWM it operates at its nominal switching frequency in continuous conduction mode. This frequency is typically about 2.5MHz with a controlled frequency variation depending on the input voltage. As the load current decreases, the converter enters Power Save Mode to sustain high efficiency down to light loads. The transition from PWM to Power Save Mode is seamless and avoids output voltage transients.

An internal current limit supports nominal output currents of up to 3A. The TPS6236x family offers both excellent DC voltage and superior load transient regulation, combined with very low output voltage ripple, minimizing interference with RF circuits.

ENABLING AND DISABLING THE DEVICE

The device is enabled by setting the EN input to a logic high. Accordingly, a logic low disables the device. If the device is enabled, the internal power stage will start switching and regulate the output voltage to the programmed threshold. The EN input must be terminated unless the internal pull down resistor is activated.

The I²C interface is operable when VDD and AVIN are present, regardless of the state of the EN pin.

If the device is disabled by pulling the EN to a logic low, the output capacitor can actively be discharged. Per default, this feature is disabled. Programming the EN_DISC bit to a logic high will discharge the output capacitor via a typ. 300Ω path on the SENSE+ pin.

SOFT START

The device incorporates an internal soft start circuitry that controls the ramp up of the output voltage after enabling the device. This circuitry eliminates inrush current to avoid excessive voltage drops of primary cells and rechargeable batteries with high internal impedance.

During soft start, the output voltage is monotonically ramped up to the minimum programmable output voltage. After reaching this threshold, the output voltage is further increased following the slope as programmed in the ramp rate settings (see [RAMP RATE CONTROLLING](#)) until reaching the programmed output voltage. Once the nominal voltage is reached, regular operation as described above will continue.

The device is able to start into a pre biased output capacitor as well.

PROGRAMMING THE OUTPUT

The TPS6236x devices offer four similar registers to program the output. Two dedicated hardware input pins, VSEL0 and VSEL1, are implemented for choosing the active register. The logic state of VSEL0 and VSEL1 select the register whose settings are present at the output. The VSEL0 and VSEL1 pins must be terminated unless the internal pull-down resistors are activated.

The registers have a certain initial default value (see [Table 2](#)) and can be readjusted via I²C during operation.

This allows a simple transition between several output options by triggering the dedicated input pins. At the same time since the presets can be readjusted during operation, this offers highest flexibility.

Table 2. Output Presets

INPUT PINS		PRESET	I ² C REGISTER	DEFAULT OPERATION MODE	DEFAULT OUTPUT VOLTAGE [V]			
VSEL 1	VSEL 0			TPS62360, TPS62361B, TPS62362, TPS62363	TPS62360	TPS62361B	TPS62362	TPS62363
0	0	SET0	0x00h – see Table 13 , Table 14 , Table 15 , Table 16	Power Save Mode	1.40	0.96	1.23	1.20
0	1	SET1	0x01h – see Table 17 , Table 18 , Table 19 , Table 20	Power Save Mode	1.00	1.40	1.00	1.36
1	0	SET2	0x02h – see Table 21 , Table 22 , Table 23 , Table 24	Power Save Mode	1.40	1.16	1.20	1.50
1	1	SET3	0x03h – see Table 25 , Table 26 , Table 27 , Table 28	Power Save Mode	1.10	1.16	1.10	1.00

Via the I²C interface and/or the four preset options, the following output parameters can be changed:

- Output voltage from 0.77V to 1.4V (TPS62360/62) and 0.5V to 1.77V (TPS62361B/63) with 10mV granularity
- Mode of operation: Power Save Mode or forced PWM mode

The slope for transition between different output voltages (Ramp Rate) can be changed via I²C as well. The slope applies for all presets globally. See [RAMP RATE CONTROLLING](#) for further details.

Since the output parameters can be changed by dedicated pins for selecting presets and by I²C, the following use scenarios are feasible:

- Control the device via dedicated pins only, after programming the presets, to choose and change within the programmed settings
- Program via I²C only. The dedicated input pins have fixed connections. Changes are conducted by changing the preset values of the active register.
- Dedicated input pins and I²C mixed operation. The non active presets might be changed. The dedicated input pins are used for the transition to the new output condition. Changes within an active preset via I²C are feasible as well.

DYNAMIC VOLTAGE SCALING

The output voltage can be adjusted dynamically. Each of the four output registers can be programmed individually by setting OV[5:0] (TPS62360/62) and OV[6:0] (TPS62361B/63) respectively in the SET0, SET1, SET2 and SET3 registers.

Table 3. TPS62360, TPS62362 Output Voltage Settings for Registers SET0, SET1, SET2 and SET3

REGISTERS: SET0, SET1, SET2, SET3	
OV[D5:D0]	OUTPUT VOLTAGE
00 0000	770 mV
00 0001	780 mV
00 0010	790 mV
00 0011	800 mV
...	...
11 1101	1380 mV
11 1110	1390 mV
11 1111	1400 mV

Table 4. TPS62361B, TPS62363 Output Voltage Settings for Registers SET0, SET1, SET2 and SET3

REGISTERS: SET0, SET1, SET2, SET3	
OV[D6:D0]	OUTPUT VOLTAGE
000 0000	500 mV
000 0001	510 mV
000 0010	520 mV
000 0011	530 mV
...	...
111 1101	1750 mV
111 1110	1760 mV
111 1111	1770 mV

If the output voltage is changed at the active register (selected by VSEL0 and VSEL1), these changes will apply after the I²C command is sent.

POWER SAVE MODE AND FORCED PWM MODE

The TPS6236x devices feature a Power Save Mode to gain efficiency at light output current conditions. The device automatically transitions in both directions between pulse width modulation (PWM) operation at high load and pulse frequency modulation (PFM) operation at light load current. This maintains high efficiency at both light and heavy load currents. In PFM Mode, the device generates single switching pulses when required to maintain the programmed output voltage.

The transition into and out of Power Save Mode happens within the entire regulation scheme and is seamless in both directions.

The output current, at which the device transitions from PWM to PFM operation can be estimated as follows:

$$I_{OUT,TRANS} = \frac{V_{IN} - V_{OUT}}{2} \times \frac{V_{OUT}}{V_{IN}} \times \frac{1}{(f \times L)} \quad (1)$$

With:

V_{IN} = Input voltage

V_{OUT} = Output Voltage

f = Switching frequency, typ. 2.5 MHz

L = Inductor value

The TPS6236x is optimized for low output voltage ripple. Therefore, the peak inductor current in PFM mode is kept small and can be calculated as follows:

$$I_{L,PFM,peak} = \frac{t_{ON}}{L} \times (V_{IN} - V_{OUT}) \quad (2)$$

And:

$$t_{ON} = \frac{V_{OUT}}{V_{IN}} \times 350ns + 20ns \quad (3)$$

With:

V_{IN} = Input Voltage

V_{OUT} = Output Voltage

t_{ON} = On-time of the High Side FET, from [Equation 3](#)

L = Inductor value

The TPS6236x offers a forced PWM mode as well. In this mode, the converter is forced in PWM mode even at light load currents. This comes with the benefit that the converter is operating with lower output voltage ripple. Compared to the PFM mode, the efficiency is lower during light load currents.

According to the output voltage, the Power Save Mode / forced PWM Mode can be programmed individually for each preset via I²C by setting the MODE0 – MODE3 bit D7. [Table 2](#) shows the factory presets after enabling the I²C. For additional flexibility, the Power Save Mode can be changed at a preset that is currently active.

RAMP RATE CONTROLLING

If the output voltage is changed, the TPS6236x can actively control the voltage ramp rate during the transition. An internal oscillator is embedded for high timing precision.

[Figure 38](#) and [Figure 39](#) show the operation principle. If the output voltage changes, the device will change the output voltage through discrete steps with a programmable ramp rate resulting in a corresponding transition time.

The ramp up/down slope can be programmed via I²C interface (see [Table 5](#)).

Table 5. Ramp Rates

RMP [2:0]	RAMP RATE	
	[mV/μs]	[μs/10mV]
000	32	0.3125
001	16	0.625
010	8	1.25
011	4	2.5
100	2	5
101	1	10
110	0.5	20
111	0.25	40

For a transition of the output voltage from $V_{OUT,A}$ to $V_{OUT,B}$ and vice versa, the resulting ramp up/down slope can be calculated as

$$\frac{\Delta V_{OUT}}{\Delta t} = 32 \frac{mV}{\mu s} \frac{1}{2^{(RMP[2-0])_2}} \quad (4)$$

If the device is operating in forced PWM Mode, the device actively controls both the ramp up and down slope.

If Power Save Mode is activated, the ramp up phase follows the programmed slope.

To force the output voltage to follow the ramp down slope in Power Save Mode, the RAMP_PFM bit needs to be set. This will force the converter to follow the ramp down slope during PFM operation as well.

If the RAMP_PFM bit is not set in Power Save Mode, the slope can be less at low output currents since the device does not actively source energy back from the output capacitor to the input or it might be sharper at high output currents since the output capacitor is discharged quickly.

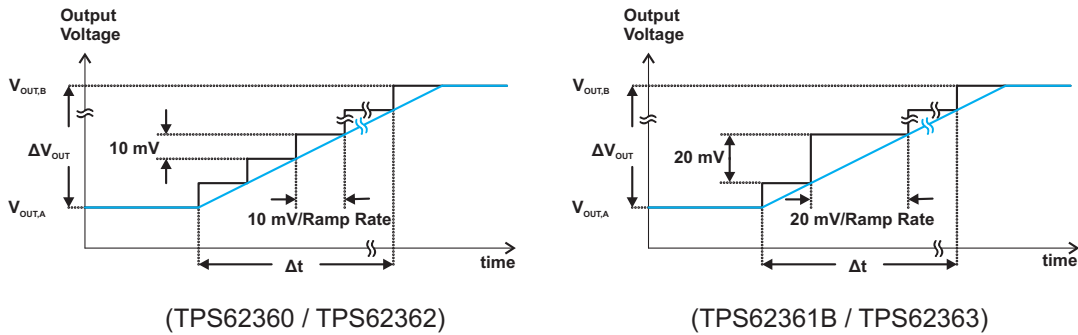

Figure 38. Ramp Up

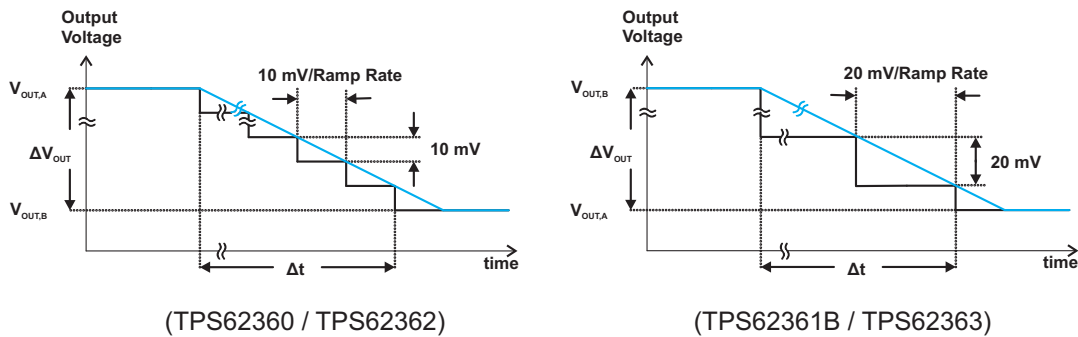

Figure 39. Ramp Down

The TPS62360 and TPS62362 ramp the output voltage taking 10mV steps, while the TPS62361B and TPS62363 ramp taking 20mV steps with a final 10mV step if required. The resulting slope remains equal for both devices.

While the output voltage setpoint is changed in a digital stair step fashion, the connected output capacitor flattens the steps to create a linear change in the output voltage.

SAFE OPERATION AND PROTECTION FEATURES

Inductor Current Limit

The inductor current limiting prevents the device from drawing high inductor current and excessive current from the battery. Excessive current might occur with a shorted/saturated inductor or a heavy load/shorted output circuit condition.

The incorporated inductor peak current limit measures the current while the high side power MOSFET is turned on. Once the current limit is tripped, the high side MOSFET is turned off and the low side MOSFET is turned on to ramp down the inductor current. This prevents high currents to be drawn from the battery.

Once the low side MOSFET is on, the low side forward current limit keeps the low side MOSFET on until the current through it decreases below the low side forward current limit threshold.

The negative current limit acts if current is flowing back to the battery from the output. It works differently in PWM and PFM operation. In PWM operation, the negative current limit prevents excessive current from flowing back through the inductor to the battery, preventing abnormal voltage conditions at the switching node. In PFM operation, a zero current limits any power flow back to the battery by preventing negative inductor current.

Die Temperature Monitoring and Over Temperature Protection

The TPS6236x offers two stages of die temperature monitoring and protection.

The Early Warning Monitoring Feature monitors the device temperature and provides the host an indication that the die temperature is in the higher range. If the device's junction temperature, T_J , exceeds 120°C typical, the TJEW bit is set high. To avoid the thermal shutdown being triggered, the current drawn from the TPS6236x should be reduced at this early stage.

The Over Temperature Protection feature disables the device if the temperature increases due to heavy load and/or high ambient temperature. It monitors the device die temperature and, if required, triggers the device into shutdown until the die temperature falls sufficiently.

If the junction temperature, T_J , exceeds 150°C typical, the device goes into thermal shutdown. In this mode, the power stage is turned off. During thermal shutdown, the I²C interface remains operable. All register values are kept.

For the thermal shutdown, a hysteresis of 20°C typical is implemented allowing the device to cool after the shutdown is triggered. Once the junction temperature T_J cools down to 130°C typical, the device resumes operation.

If a thermal shutdown has occurred, the TJTS bit is latched and remains a logic high as long as VDD and AVIN are present and until the bit is reset by the host.

Input Under Voltage Protection

The input under voltage protection is implemented in order to prevent operation of the device for low input voltage conditions. If the device is enabled, it prevents the device from switching if AVIN falls below the under voltage lockout threshold. If the AVIN under voltage protection threshold is tripped, the device will go into under voltage shutdown instantaneously, turning the power stage off and resetting all internal registers. The input under voltage protection is also implemented on the VDD input. If the VDD under voltage protection threshold is tripped, the device will reset all internal registers.

A under voltage lockout hysteresis of $V_{UVLO,HYST(AVIN)}$ at AVIN and $V_{UVLO,HYST(VDD)}$ at VDD is implemented.

The I²C compatible interface remains fully functional if AVIN and VDD are present. If the under voltage lockout of AVIN or VDD is triggered during operation, all internal registers are reset to their default values. Figure 40 shows the UVLO block diagram.

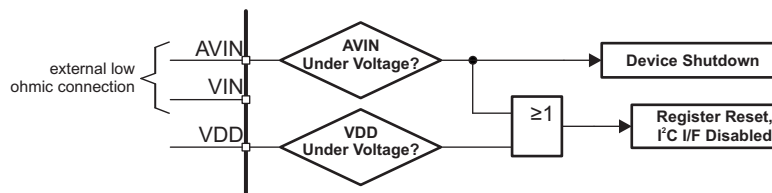

Figure 40. UVLO State Chart

By connecting VIN and AVIN to the same potential, VIN is included in the under voltage monitoring. If a low pass input filter is applied at AVIN (not mandatory for the TPS6236x), the delay and shift in the voltage level can be calculated by taking the typical quiescent current I_Q at AVIN. As an example, for I_Q and 10Ω series resistance, this results in a minimal static shift of approx. 560μV.

VIN and AVIN must be connected to the same source for proper device operation.

APPLICATION INFORMATION

I²C INTERFACE

Serial Interface Description

I²C is a 2-wire serial interface developed by Philips Semiconductor (see I²C-Bus Specification, Version 2.1, January 2000). The bus consists of a data line (SDA) and a clock line (SCL) with pull-up structures. When the bus is *idle*, both SDA and SCL lines are pulled high. All the I²C compatible devices connect to the I²C bus through open drain I/O pins, SDA and SCL. A *master* device, usually a micro controller or a digital signal processor, controls the bus. The master is responsible for generating the SCL signal and device addresses. The master also generates specific conditions that indicate the START and STOP of data transfer. A *slave* device receives and/or transmits data on the bus under control of the master device.

The TPS6236x device works as a *slave* and supports the following data transfer *modes*, as defined in the I²C-Bus Specification:

- Standard mode (100 kbps)
- Fast mode (400 kbps)
- Fast mode plus (1Mbps)
- High-speed mode (3.4 Mbps)

The interface adds flexibility to the power supply solution, enabling most functions to be programmed to new values depending on the instantaneous application requirements. Register contents remain intact as long as VDD and AVIN are present in the specified range. Tripping the under voltage lockout of AVIN or VDD deletes the registers and establishes the default values once the supply is present again.

The data transfer protocol for standard and fast modes is exactly the same; therefore, they are referred to as F/S-mode in this document. The protocol for high-speed mode is different from F/S-mode, and it is referred to as HS-mode. The TPS6236x device supports 7-bit addressing. 10-bit addressing and general call addressing are not supported.

Table 6 shows the TPS6236x devices and their assigned I²C addresses.

Table 6. I²C Address

DEVICE OPTION	I ² C ADDRESS	
	HEXADECIMAL CODED	BINARY CODED
TPS62360	(0x60) _{HEX}	(110 0000) ₂
TPS62361B	(0x60) _{HEX}	(110 0000) ₂
TPS62362	(0x60) _{HEX}	(110 0000) ₂
TPS62363	(0x60) _{HEX}	(110 0000) ₂

F/S-Mode Protocol

The master initiates data transfer by generating a start condition. The start condition is when a high-to-low transition occurs on the SDA line while SCL is high, as shown in Figure 41. All I²C-compatible devices should recognize a start condition.

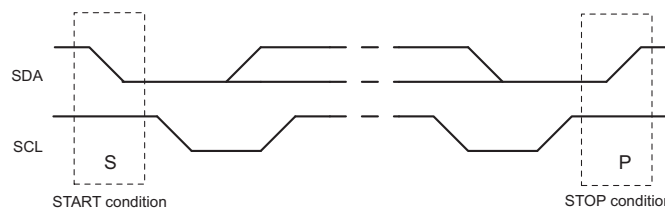

Figure 41. START and STOP Conditions

The master then generates the SCL pulses, and transmits the 7-bit address and the read/write direction bit R/W on the SDA line. During all transmissions, the master ensures that data is valid. A valid data condition requires the SDA line to be stable during the entire high period of the clock pulse (see Figure 42). All devices recognize the address sent by the master and compare it to their internal fixed addresses. Only the slave device with a matching address generates an acknowledge (see Figure 43) by pulling the SDA line low during the entire high period of the ninth SCL cycle. Upon detecting this acknowledge, the master knows that communication link with a slave has been established.

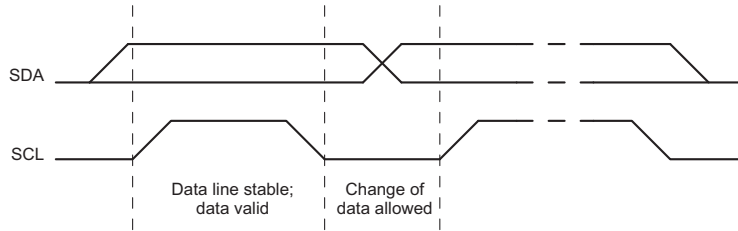

Figure 42. Bit Transfer on the Serial Interface

The master generates further SCL cycles to either transmit data to the slave (R/W bit 1) or receive data from the slave (R/W bit 0). In either case, the receiver needs to acknowledge the data sent by the transmitter. So an acknowledge signal can either be generated by the master or by the slave, depending on which one is the receiver. 9-bit valid data sequences consisting of 8-bit data and 1-bit acknowledge can continue as long as necessary.

To signal the end of the data transfer, the master generates a stop condition by pulling the SDA line from low to high while the SCL line is high (see Figure 41). This releases the bus and stops the communication link with the addressed slave. All I²C compatible devices must recognize the stop condition. Upon the receipt of a stop condition, all devices know that the bus is released, and they wait for a start condition followed by a matching address.

Attempting to read data from register addresses not listed in this section will result in 00h being read out.

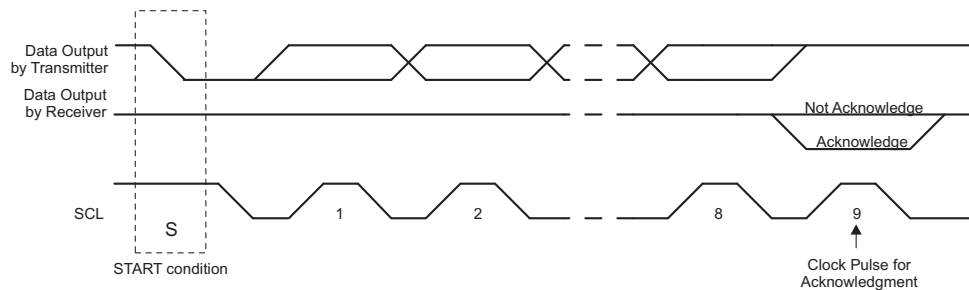

Figure 43. Acknowledge on the I²C Bus

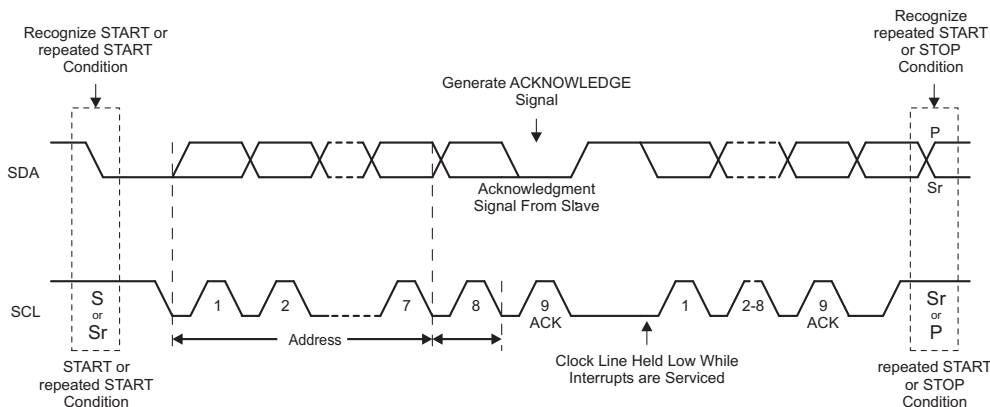

Figure 44. Bus Protocol

HS-Mode Protocol

When the bus is idle, both SDA and SCL lines are pulled high by the pull-up devices.

The master generates a start condition followed by a valid serial byte containing HS master code 00001XXX. This transmission is made in F/S-mode at no more than 400 Kbps. No device is allowed to acknowledge the HS master code, but all devices must recognize it and switch their internal setting to support 3.4 Mbps operation.

The master then generates a *repeated start condition* (a repeated start condition has the same timing as the start condition). After this repeated start condition, the protocol is the same as F/S-mode, except that transmission speeds up to 3.4Mbps are allowed. A stop condition ends the HS-mode and switches all the internal settings of the slave devices to support the F/S-mode. Instead of using a stop condition, repeated start conditions should be used to secure the bus in HS-mode.

Attempting to read data from register addresses not listed in this section will result in 00h being read out.

I²C UPDATE SEQUENCE

The TPS6236x requires a start condition, a valid I²C address, a register address byte, and a data byte for a single update. After the receipt of each byte, the TPS6236x device acknowledges by pulling the SDA line low during the high period of a single clock pulse. A valid I²C address selects the TPS6236x. The TPS6236x performs an update on the falling edge of the acknowledge signal that follows the LSB byte.

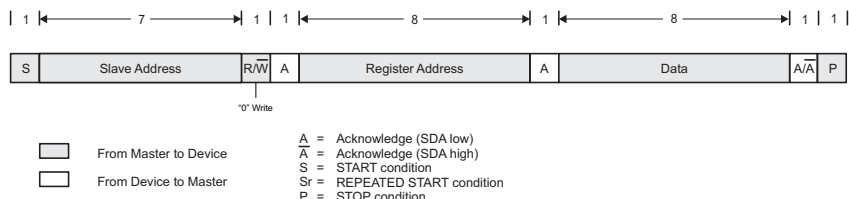

Figure 45. Write Data Transfer Format in F/S-Mode

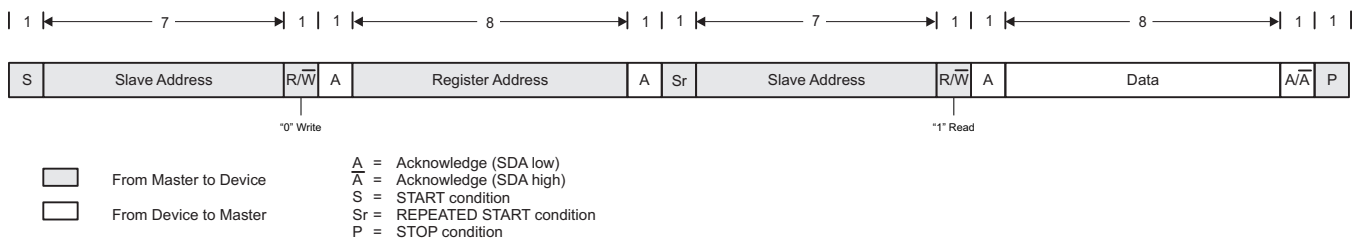

Figure 46. Read Data Transfer Format in F/S-Mode

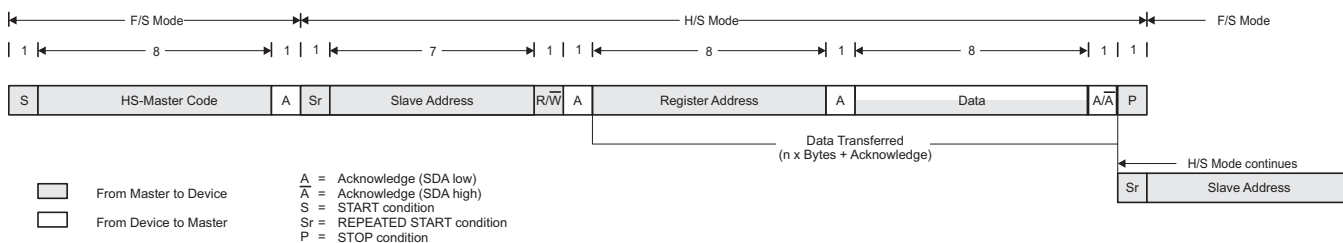

Figure 47. Data Transfer Format in H/S-Mode

Slave Address Byte

MSB							LSB
X	X	X	X	X	X	A1	A0

The slave address byte is the first byte received following the START condition from the master device.

Register Address Byte

MSB						LSB	
0	0	0	0	0	D2	D1	D0

Following the successful acknowledgment of the slave address, the bus master will send a byte to the TPS6236x, which will contain the address of the register to be accessed.

I²C REGISTER RESET

The I²C registers can be reset by pulling VDD below the VDD Under Voltage Level, $V_{DD,UVLO}$. VDD can be used as a hardware reset function to reset the registers to defaults, if VDD is supplied by a GPIO of the host. The host's GPIO must be capable of driving $I_{VDD,max}$.

Refer to the [Input Under Voltage Protection](#) section for details.

PULL DOWN RESISTORS

The EN, VSEL0 and VSEL1 inputs feature internal pull down resistors to discharge the potential if one of the pins is not connected or is triggered by a high impedance source. See [Figure 48](#). By default, the pull down resistors are enabled.

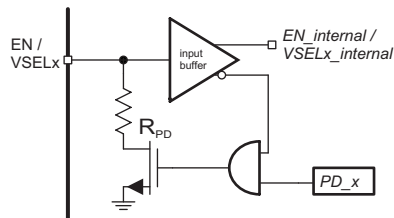

Figure 48. Pull Down Resistors at EN, VSEL0 and VSEL1 Pins

If a pin is read as a logic HIGH, its pull down resistor is disconnected dynamically to reduce power consumption.

To achieve lowest possible quiescent current or if external pull up/down resistors are employed, the internal pull down resistors can be disabled individually at EN, VSEL0 and VSEL1 by I²C programming the registers PD_EN, PD_VSEL0 and PD_VSEL1.

INPUT CAPACITOR SELECTION

The input capacitor is required to buffer the pulsing current drawn by the device at VIN and reducing the input voltage ripple. The pulsing current is originated by the operation principles of a step down converter.

Low ESR input capacitors are required for best input voltage filtering and minimal interference with other system components. For best performance, ceramic capacitors with a low ESR at the switching frequency are recommended. X7R or X5R type capacitors should be used.

A ceramic input capacitor in the nominal range of $C_{IN} = 10\mu\text{F}$ to $22\mu\text{F}$ should be a good choice for most application scenarios. In general, there is no upper limit for increasing the input capacitor.

For typical operation, a $10\mu\text{F}$ X5R type capacitor is recommended. DC bias effects reduce the effective capacitance of MLCC capacitors as a function of the voltage applied. This effect needs to be factored in when choosing an input capacitor by choosing the proper voltage rating. [Table 7](#) shows a list of recommended capacitors.

Table 7. List of Recommended Capacitors

CAPACITANCE [μF]	TYPE	DIMENSIONS L x W x H [mm ³]	MANUFACTURER
10	GRM188R60J106M	0603: 1.6 x 0.8 x 0.8	Murata
10	CL10A106MQ8NRNC	0603: 1.6 x 0.8 x 0.8	Samsung
22	GRM188R60G226M	0603: 1.6 x 0.8 x 0.8	Murata
22	CL10A106MQ8NRNC	0603: 1.6 x 0.8 x 0.8	Samsung

DECOUPLING CAPACITORS AT AVIN, VDD

Noise impacts can be reduced by buffering AVIN and VDD with a decoupling capacitor. It is recommended to buffer AVIN and VDD with a X5R or X7R ceramic capacitor of at least 0.1μF connected between AVIN, AGND and VDD, AGND respectively. The capacitor closest to the pin should be kept small (< 0.22μF) in order to keep a low impedance at high frequencies. In general, there is no upper limit for the total capacitance.

Adding a low pass input filter at AVIN (e.g. by adding $R_{LP} = 10\Omega$ resistor in series) is not mandatory for the TPS6236x. It can be used if the supply rail at very noisy (e.g. by the use of a pre-regulator) to filter away aggressive noise. See [Figure 49](#).

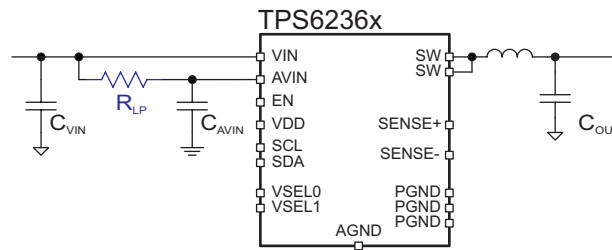

Figure 49. Optional Low Pass Filter at AVIN

INDUCTOR SELECTION

The choice of the inductor type and value has an impact on the inductor ripple current, the transition point of PFM to PWM operation, the output voltage ripple and accuracy. The subsections below support for choosing the proper inductor.

Inductance Value

The TPS6236x is designed for best operation with a nominal inductance value of 1μH.

Inductances down to 0.47μH nominal may be used to improve the load transient behavior or to decrease the total solution size. See [OUTPUT FILTER DESIGN](#) for details.

Depending on the inductance, using inductances lower than 1μH results in a higher inductor current ripple. It can be calculated as:

$$\Delta I_L = V_{OUT} \times \frac{1 - \frac{V_{OUT}}{V_{IN}}}{L \times f} \quad (5)$$

With:

V_{IN} = Input Voltage

V_{OUT} = Output Voltage

f = Switching frequency, typ. 2.5 MHz

L = Inductance

Inductor Saturation Current

The inductor needs to be selected for its current rating. To pick the proper saturation current rating, the maximum inductor current can be calculated as:

$$I_{L,MAX} = I_{OUT,MAX} + \frac{\Delta I_L}{2} \quad (6)$$

With:

ΔI_L = Inductor ripple current (see Equation 5)

$I_{OUT,MAX}$ = Maximum output current

Since the inductance can be decreased by saturation effects and temperature impact, the inductor needs to be chosen to have an effective inductance of at least 0.3 μ H under temperature and saturation effects.

Table 8 shows a list of inductors that have been used with the TPS6236x. Special care needs to be taken for choosing the proper inductor, taking e.g. the load profile into account.

Table 8. List of Recommended Inductors

INDUCTANCE [μ H]	SATURATION CURRENT RATING ⁽¹⁾ ($\Delta L/L = 30\%$, typ) [A]	TEMPERATURE CURRENT RATING ⁽¹⁾ ($\Delta T = 40^\circ\text{C}$, typ) [A]	DIMENSIONS L x W x H [mm ³]	DC RESISTANCE [m Ω typ]	TYPE	MANUFACTURER
1.0	5.4	11.0	4.0 x 4.0 x 2.1	11	XFL4020-102ME1.0	Coilcraft
1.0	4.7	3.6	3.2 x 2.5 x 1.2	34	DFE322512C	Toko
1.0	6.0	4.1	4.4 x 4.1 x 1.2	38	SPM4012	TDK
1.0	4.7	3.8	3.2 x 2.5 x 1.2	35	PILE32251B- 1R0MS-11 ⁽²⁾	Cyntec
1.0	4.5	7.0	4.15 x 4.0 x 1.8	24	PIMB042T-1R0MS- 11	Cyntec
1.0	4.2	3.7	2.5 x 2.0 x 1.2	38	DFE252012R -H- 1R0N ⁽²⁾	Toko
0.47	6.6	11.2	4.0 x 4.0 x 1.5	8	XFL4015-471M	Coilcraft
0.47	5	4.5	2.5 x 2.0 x 1.2	23	PIFE25201B- R47MS-11 ⁽²⁾	Cyntec
0.47	5.2	4.4	2.5 x 2.0 x 1.2	27	DFE252012R -H- R47N ⁽³⁾	Toko

(1) Excessive inductor temperature might result in a further effective inductance drop which might be below or close to the max. current limit threshold, $I_{LIM,max}$, depending on the inductor, use case and thermal board design. Proper saturation current rating must be verified, taking into account the use scenario and thermal board layout.

(2) Product preview, release planned for Q3/4 2012. Contact manufacturer for details.

(3) Under development, typ. data might change. Contact manufacturer for schedule and details.

OUTPUT CAPACITOR SELECTION

The unique hysteretic control scheme allows the use of tiny ceramic capacitors. For best performance, ceramic capacitors with low ESR values are recommended to achieve high conversion efficiency and low output voltage ripple. For stable operation, X7R or X5R type capacitors are recommended.

The TPS6236x is designed to operate with a minimum output capacitor of 10 μ F for a 1 μ H inductor and 2x10 μ F for a 0.47 μ H inductor, placed at the device's output. In addition, a 0.1 μ F capacitor can be added to the output to reduce the high frequency content created by a very sudden load change. For stability, an overall maximum output capacitance must not be exceeded. See [OUTPUT FILTER DESIGN](#).

Table 7 shows a list of tested capacitors. The TPS6236x is not designed for use with polymer, tantalum, or electrolytic output capacitors.

OUTPUT FILTER DESIGN

The inductor and the output capacitors create the output filter. The output capacitors consist of C_{OUT} and buffer capacitors at the load, C_{LOAD} . See Figure 50. Buffering the load by ceramic capacitors, C_{LOAD} , improves the voltage quality at the load input and the dynamic load step behavior. This is especially true if the trace between the TPS6236x and the load is longer than the smallest possible.

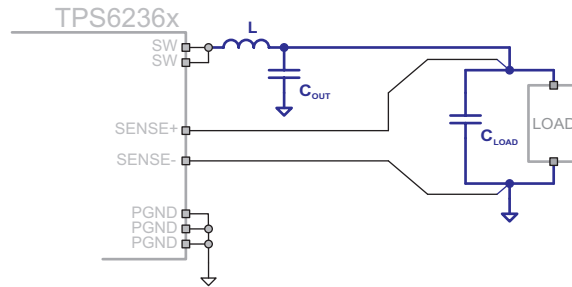

Figure 50. L, C_{OUT} and C_{LOAD} Forming the Output Filter

Depending on the chosen inductor value, a certain minimum output capacitor C_{OUT} must be present. Also depending on the chosen inductor value, a maximum output and buffer capacitor configuration (C_{OUT} + C_{LOAD}) must not be exceeded. Figure 51 shows the range of L, C_{OUT} and C_{LOAD} that create a stable output filter.

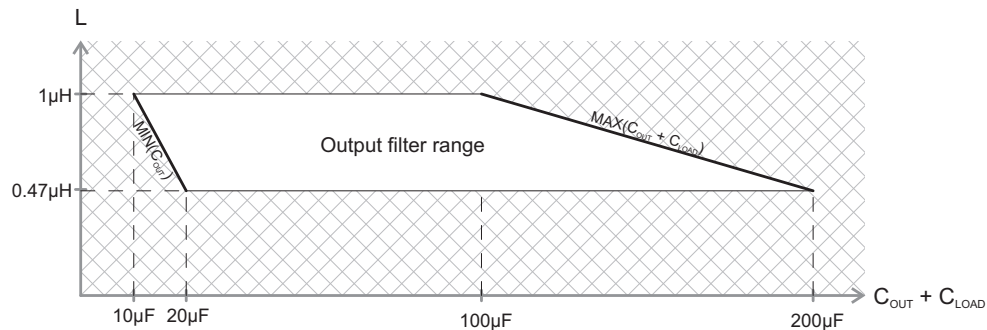

Figure 51. Recommended L, C_{OUT} and C_{LOAD} Combinations

Within the allowed output filter range, a certain filter can be chosen to improve further on application specific key parameters.

The choice of the inductance, L, affects the inductor current ripple, output voltage ripple, the PFM to PWM transition point and the PFM operation switching frequency.

The TPS6236x is designed for operation with a nominal inductance value of 1µH. Inductances down to 0.47µH nominal may be used to improve the load transient behavior or to decrease the total solution size. This increases the inductor current ripple (see Equation 5). As a consequence, the output voltage ripple is increased if the output capacitance is kept constant. The increased inductor ripple current also causes higher peak inductor currents (see Equation 6), requiring a higher saturation current rating. Furthermore, the PFM switching frequency is decreased and the automatic PFM to PWM transition occurs at a higher output current (see Equation 1).

The choice of the output and buffer capacitance (C_{OUT} and C_{LOAD}) affects the load step behavior, output voltage ripple, PFM switching frequency and output voltage transition time.

A higher output capacitance improves the load step behavior and reduces the output voltage ripple as well as decreasing the PFM switching frequency. For very large output filter combinations, the output voltage might be slower than the programmed ramp rate at voltage transitions (see RAMP RATE CONTROLLING) because of the higher energy stored on the output capacitance. At startup, the time required to charge the output capacitor to 0.5V might be longer. At shutdown, if the output capacitor is discharged by the internal discharge resistor (see ENABLING AND DISABLING THE DEVICE), this requires more time to settle V_{OUT} down as a consequence of the increased time constant $T = R_{DISCHARGE} \times (C_{OUT} + C_{LOAD})$.

For further performance or specific demands, these values might be tweaked. In any case, the loop stability should be checked since the control loop stability might be affected. At light loads, if the device is operating in PFM Mode, choosing a higher value minimizes the voltage ripple resulting in a better DC output accuracy.

THERMAL AND DEVICE LIFE TIME INFORMATION

Implementation of integrated circuits in low-profile and fine-pitch surface-mount packages typically requires special attention to power dissipation. Many system-dependent issues such as thermal coupling, airflow, added heat sinks and convection surfaces, and the presence of other heat-generating components affect the power-dissipation limits of a given component.

Thermal performance can be enhanced by proper PCB layout. Wide power traces come with the ability to sink dissipated heat. This can be improved further on multi layer PCB designs with vias to different layers.

Proper PCB layout with a focus on thermal performance results in a reduced junction-to-ambient thermal resistance θ_{JA} and thereby reduces the device junction temperature, T_J .

The TI reliability requirement for the silicon chip's life time (100K Power-On-Hours at $T_J = 105^\circ\text{C}$) is affected by the junction temperature and the continuously drawn current at the VIN pin and the SW pins. In order to be consistent with the TI reliability requirement for the silicon chips (100000 Power-On-Hours at $T_J = 105^\circ\text{C}$), the VIN pin current should not continuously exceed 1275mA and the SW pins current should not continuously exceed 2550mA so as to prevent electromigration failure in the solder bump. Drawing 1150mA at VIN would, as an example, be the case for typically $I_{OUT} = 2350\text{mA}$, $V_{OUT} = 1.5\text{V}$ and $V_{IN} = 3.6\text{V}$.

Exceeding the VIN pin / SW pins current rating might affect the device reliability. As an example, drawing current peaks of $I_{OUT} = 3000\text{mA}$ with up to 10% of the application time over a base continuous output current of $I_{OUT} = 2000\text{mA}$ might reduce the Power-on-Hours to 90000 hours for conditions such as $V_{IN} = 2.7\text{V}$, $V_{OUT} = 1.5\text{V}$, $T_J = 105^\circ\text{C}$. In this example, exceeding $T_J = 105^\circ\text{C}$ in combination with a higher peak output current duty cycle clearly further affects the device life time.

For more details on how to use the thermal parameters, see the application notes: [Thermal Characteristics Application Note \(SZZA017\)](#), and [IC Package Thermal Metrics Application Note \(SPRA953\)](#).

PCB LAYOUT

The PCB layout is an important step to maintain the high performance of the TPS6236x. Both the high current and the fast switching nodes demand full attention to the PCB layout to save the robustness of the TPS6236x through the PCB layout. Improper layout might show the symptoms of poor line or load regulation, ground and output voltage shifts, stability issues, unsatisfying EMI behavior or worsened efficiency.

Signal Routing Strategy

The TPS6236x is a mixed signal IC. Depending on the function of a pin or trace, different board layout strategies must be addressed to achieve a good design. Due to the nature of a switching converter, some signals are sensitive to influence from other signals (aggressors). The sense lines, SENSE+ and SENSE-, are sensitive to the aggressors, which are high bandwidth I/O pins (SCL and SDA) and the switch node (SW) and their connected traces. Special care must be taken to avoid cross-talk between between them.

The following recommendations need to be followed:

- PGND, VIN and SW should be routed on thick layers. They must not surround inner signal layers which are not able to withstand interference from noisy PGND, VIN and SW. They create a flux which is determined by the switching frequency. The flux generated affects neighboring layers due to capacitive coupling across layers.
- AGND, AVIN and VDD must be isolated from noisy signals.
- If crossing layers is required for PGND, VIN and SW, they must be dimensioned to support the high currents to not cause high IR drops. In general, changing the layers frequently must be avoided.
- Signal traces, and especially the sense lines (SENSE+ and SENSE-), must be kept away from noisy traces/signals. Avoid capacitive coupling with neighboring noisy layers by cutting away the overlapping areas close to signal traces. Special care must be taken for the sense lines to avoid inductive / capacitive cross-talk from aggressors, both from noisy lines as well as external inductors which generate magnetic fields.
- Care should be taken for a proper thermal layout. Wide traces, connecting through the layers with vias, provides a proper thermal path to sink the heat energy created from the device and inductor.

External Components Placement

The input capacitor at VIN must be placed closest to the IC for proper operation. The decoupling caps at AVIN and VDD reduce noise impacts and should be placed as close to the IC as possible. The output filter, consisting of C_{OUT} and L, converts the switching signal at SW to the noiseless output voltage. It should be placed as close as possible to the device keeping the switch node small, for best EMI behavior.

Trace routing

Route the VIN trace wide and thick to avoid IR drops. The trace between the input capacitor's higher node and VIN as well as the trace between the input capacitor's lower node and PGND must be kept as short as possible. Parasitic inductance on these traces must be kept as tiny as possible for proper device operation.

AVIN and AGND should be isolated from noisy signals. Route the AGND to the star ground point where no IR drop occurs. The input cap at AVIN isolates noise. Proceed with VDD and AGND in a similar manner.

The trace between the switch node, SW, must connect directly to the inductor followed by the output capacitors, C_{OUT}. The switch node is an aggressor. Keeping this trace short reduces noise being radiated and improves EMI behavior. The lower node of the output capacitor, C_{OUT}, needs to connect to the star ground point. The TPS6236x supports the point of load concept (POL). Input caps at the POL do not need to be placed closest to the IC; they should be placed close to the POL. Route the traces between the TPS6236x's output capacitor and the load's input capacitors direct and wide to avoid losses due to the IR drop.

Connect the sense lines to the POL. This puts into practice the remote sensing concept, allowing the device to regulate the voltage at the POL, compensating IR drops. If possible, make a Kelvin connection to the load device. The sense lines are susceptible to noise. They must be kept away from noisy signals such as PGND, VIN, and SW, as well as high bandwidth signals such as the I²C bus. Avoid both capacitive as well as inductive coupling by keeping the sense lines short, direct and close to each other. Run the lines in a quiet layer. Isolate them from noisy signals by a voltage or ground plane if possible. Running the signal as a differential pair is recommended.

The PGND nodes at C_{IN} and C_{OUT} can be connected underneath the IC at the PGND pins (star point). Make sure that small signal traces returning to the AGND do not share the high current path at PGND to C_{IN} and C_{OUT}.

See [Figure 52](#) for the recommended layout.

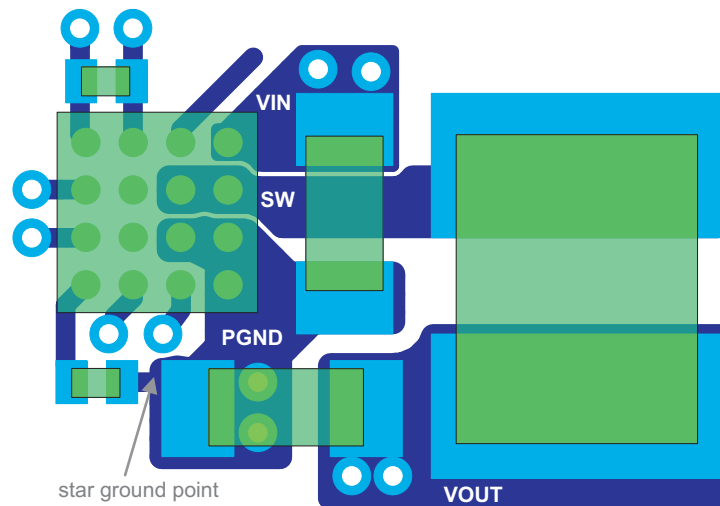

Figure 52. Layout Suggestion (top view) with 3225 Inductor. Overall Solution Size: 27.5mm²

REGISTER SETTINGS

Overview

Table 9. TPS62360 Register Settings Overview

ADDRESS	REGISTER	RESET / DEFAULT STATE	READ / WRITE	REGISTER (default / reset values)									
				MSB								LSB	
				D7	D6	D5	D4	D3	D2	D1	D0		
0x00h	SET0	0x111111	R/W	MODE0									OV0[5:0]
0x01h	SET1	0x010111	R/W	MODE1									OV1[5:0]
0x02h	SET2	0x111111	R/W	MODE2									OV2[5:0]
0x03h	SET3	0x100001	R/W	MODE3									OV3[5:0]
0x04h	Ctrl	111xxxxx	R/W	PD_EN	PD_VSEL0	PD_VSEL1							
0x05h	Temp	xxxxx000	R/W							DIS_TS	TJEW	TJTS	
0x06h	RmpCtrl	000xx00x	R/W		RMP[2:0]					EN_DISC	RAMP_PFM		
0x07h	(Reserved)	xxxxxxx											
0x08h	Chip_ID	100000xx	R										
0x09h	Chip_ID												

Table 10. TPS62361B Register Settings Overview

ADDRESS	REGISTER	RESET / DEFAULT STATE	READ / WRITE	REGISTER (default / reset values)									
				MSB								LSB	
				D7	D6	D5	D4	D3	D2	D1	D0		
0x00h	SET0	00101110	R/W	MODE0									OV0[6:0]
0x01h	SET1	01011010	R/W	MODE1									OV1[6:0]
0x02h	SET2	01000010	R/W	MODE2									OV2[6:0]
0x03h	SET3	01000010	R/W	MODE3									OV3[6:0]
0x04h	Ctrl	111xxxxx	R/W	PD_EN	PD_VSEL0	PD_VSEL1							
0x05h	Temp	xxxxx000	R/W							DIS_TS	TJEW	TJTS	
0x06h	RmpCtrl	000xx00x	R/W		RMP[2:0]					EN_DISC	RAMP_PFM		
0x07h	(Reserved)	xxxxxxx											
0x08h	Chip_ID	100001xx	R										
0x09h	Chip_ID												

Table 11. TPS62362 Register Settings Overview

ADDRESS	REGISTER	RESET / DEFAULT STATE	READ / WRITE	REGISTER (default / reset values)									
				MSB								LSB	
				D7	D6	D5	D4	D3	D2	D1	D0		
0x00h	SET0	0x101110	R/W	MODE0									OV0[5:0]
0x01h	SET1	0x010111	R/W	MODE1									OV1[5:0]
0x02h	SET2	0x101011	R/W	MODE2									OV2[5:0]
0x03h	SET3	0x100001	R/W	MODE3									OV3[5:0]
0x04h	Ctrl	111xxxxx	R/W	PD_EN	PD_VSEL0	PD_VSEL1							
0x05h	Temp	xxxxx000	R/W							DIS_TS	TJEW	TJTS	
0x06h	RmpCtrl	000xx00x	R/W		RMP[2:0]					EN_DISC	RAMP_PFM		
0x07h	(Reserved)	xxxxxxx											
0x08h	Chip_ID	100010xx	R										
0x09h	Chip_ID												

Table 12. TPS62363 Register Settings Overview

ADDRESS	REGISTER	RESET / DEFAULT STATE	READ / WRITE	REGISTER (default / reset values)							
				MSB				LSB			
				D7	D6	D5	D4	D3	D2	D1	D0
0x00h	SET0	01000110	R/W	MODE0	OV0[6:0]						
0x01h	SET1	01010011	R/W	MODE1	OV1[6:0]						
0x02h	SET2	01100100	R/W	MODE2	OV2[6:0]						
0x03h	SET3	00110010	R/W	MODE3	OV3[6:0]						
0x04h	Ctrl	111xxxxx	R/W	PD_EN	PD_VSEL0	PD_VSEL1					
0x05h	Temp	xxxxx000	R/W						DIS_TS	TJEW	TJTS
0x06h	RmpCtrl	000xx00x	R/W	RMP[2:0]					EN_DISC	RAMP_PFM	
0x07h	(Reserved)	xxxxxxx									
0x08h	Chip_ID	100001xx	R								
0x09h	Chip_ID										

Register 0x00h Description: SET0

The register settings apply by choosing SET0 (VSEL1 = LOW, VSEL0 = LOW).

Table 13. TPS62360 Register 0x00h Description

REGISTER ADDRESS: 0x00h Read/Write					
BIT	NAME	DEFAULT	DESCRIPTION		
D7	MODE0	MSB	0	Operation mode for SET0 0 = PFM / PWM mode operation 1 = Forced PWM mode operation	
D6			x	Reserved for future use	
D5	OV0[5:0]		1	Output voltage for SET0 Default: (111111) ₂ = 1.4V	
D4			1	D5-D0	Output voltage
D3			1	00 0000	770 mV
D2			1	00 0001	780 mV
				00 0010	790 mV
D1			1
				11 1111	1400 mV
D0		LSB	1	$V_{OUT} = (xx\ xxxx)_2 \times 10\text{mV} + 770\text{ mV}$	

Table 14. TPS62361B Register 0x00h Description

REGISTER ADDRESS: 0x00h Read/Write					
BIT	NAME	DEFAULT	DESCRIPTION		
D7	MODE0	MSB	0	Operation mode for SET0 0 = PFM / PWM mode operation 1 = Forced PWM mode operation	
D6	OV0[6:0]			0	Output voltage for SET0 Default: (0101110) ₂ = 0.96V
D5		1			
D4		0		D6-D0	Output voltage
D3		1		000 0000	500 mV
D2		1		000 0001	510 mV
				000 0010	520 mV
D1		1	
		111 1111	1770 mV		
D0		LSB	0	$V_{OUT} = (xxx\ xxxx)_2 \times 10\text{mV} + 500\text{ mV}$	

Table 15. TPS62362 Register 0x00h Description

REGISTER ADDRESS: 0x00h Read/Write				
BIT	NAME	DEFAULT	DESCRIPTION	
D7	MODE0	MSB	0 Operation mode for SET0 0 = PFM / PWM mode operation 1 = Forced PWM mode operation	
D6		x	Reserved for future use	
D5	OV0[5:0]	1	Output voltage for SET0 Default: (101110) ₂ = 1.23V	
D4		0	D5-D0	
D3		1	00 0000	770 mV
D2		1	00 0001	780 mV
			00 0010	790 mV
D1		1
			11 1111	1400 mV
D0		LSB	0 $V_{OUT} = (xx\ xxxx)_2 \times 10\text{mV} + 770\text{ mV}$	

Table 16. TPS62363 Register 0x00h Description

REGISTER ADDRESS: 0x00h Read/Write				
BIT	NAME	DEFAULT	DESCRIPTION	
D7	MODE0	MSB	0 Operation mode for SET0 0 = PFM / PWM mode operation 1 = Forced PWM mode operation	
D6	OV0[6:0]	1	Output voltage for SET0 Default: (1000110) ₂ = 1.2V	
D5		0	D6-D0	
D4		0	000 0000	500 mV
D3		0	000 0001	510 mV
D2		1	000 0010	520 mV
D1		1
			111 1111	1770 mV
D0		LSB	0 $V_{OUT} = (xxx\ xxxx)_2 \times 10\text{mV} + 500\text{ mV}$	

Register 0x01h Description: SET1

The register settings apply by choosing SET1 (VSEL1 = LOW, VSEL0 = HIGH).

Table 17. TPS62360 Register 0x01h Description

REGISTER ADDRESS: 0x01h Read/Write				
BIT	NAME	DEFAULT	DESCRIPTION	
D7	MODE1	MSB	0 Operation mode for SET1 0 = PFM / PWM mode operation 1 = Forced PWM mode operation	
D6			x Reserved for future use	
D5	OV1[5:0]	0	Output voltage for SET1 Default: (010111) ₂ = 1.0V	
D4			1	D5-D0 Output voltage
D3			0	00 0000 770 mV
D2			1	00 0001 780 mV
				00 0010 790 mV
D1			1
				11 1111 1400 mV
D0		LSB	1 $V_{OUT} = (xx\ xxxx)_2 \times 10\text{mV} + 770\text{ mV}$	

Table 18. TPS62361B Register 0x01h Description

REGISTER ADDRESS: 0x01h Read/Write				
BIT	NAME	DEFAULT	DESCRIPTION	
D7	MODE1	MSB	0 Operation mode for SET1 0 = PFM / PWM mode operation 1 = Forced PWM mode operation	
D6			1 Output voltage for SET1 Default: (1011010) ₂ = 1.4V	
D5	OV1[6:0]	0	0	
D4			1	D6-D0 Output voltage
D3			1	000 0000 500 mV
D2			0	000 0001 510 mV
				000 0010 520 mV
D1			1
				111 1111 1770 mV
D0		LSB	0 $V_{OUT} = (xxx\ xxxx)_2 \times 10\text{mV} + 500\text{ mV}$	

Table 19. TPS62362 Register 0x01h Description

REGISTER ADDRESS: 0x01h Read/Write				
BIT	NAME	DEFAULT	DESCRIPTION	
D7	MODE1	MSB	0 Operation mode for SET1 0 = PFM / PWM mode operation 1 = Forced PWM mode operation	
D6			x Reserved for future use	
D5	OV1[5:0]		0 Output voltage for SET1 Default: (010111) ₂ = 1.0V	
D4			1 D5-D0 Output voltage	
D3			0 00 0000 770 mV	
D2			1 00 0001 780 mV 00 0010 790 mV	
D1			1 11 1111 1400 mV	
D0		LSB	1	$V_{OUT} = (xx\ xxxx)_2 \times 10\text{mV} + 770\text{ mV}$

Table 20. TPS62363 Register 0x01h Description

REGISTER ADDRESS: 0x01h Read/Write			
BIT	NAME	DEFAULT	DESCRIPTION
D7	MODE1	MSB	0 Operation mode for SET1 0 = PFM / PWM mode operation 1 = Forced PWM mode operation
D6	OV1[6:0]		1 Output voltage for SET1 Default: (1010011) ₂ = 1.36V
D5			0
D4			1 D6-D0 Output voltage
D3			0 000 0000 500 mV
D2			0 000 0001 510 mV 000 0010 520 mV
D1			1 111 1111 1770 mV
D0		LSB	1

Register 0x02h Description: SET2

The register settings apply by choosing SET2 (VSEL1 = HIGH, VSEL0 = LOW).

Table 21. TPS62360 Register 0x02h Description

REGISTER ADDRESS: 0x02h Read/Write					
BIT	NAME	DEFAULT	DESCRIPTION		
D7	MODE2	MSB	0	Operation mode for SET2 0 = PFM / PWM mode operation 1 = Forced PWM mode operation	
D6			x	Reserved for future use	
D5	OV2[5:0]		1	Output voltage for SET2 Default: (111111) ₂ = 1.4V	
D4			1	D5-D0	Output voltage
D3			1	00 0000	770 mV
D2			1	00 0001	780 mV
				00 0010	790 mV
D1			1
				11 1111	1400 mV
D0		LSB	1	$V_{OUT} = (xx\ xxxx)_2 \times 10\text{mV} + 770\text{ mV}$	

Table 22. TPS62361B Register 0x02h Description

REGISTER ADDRESS: 0x02h Read/Write					
BIT	NAME	DEFAULT	DESCRIPTION		
D7	MODE2	MSB	0	Operation mode for SET2 0 = PFM / PWM mode operation 1 = Forced PWM mode operation	
D6	OV2[6:0]			1	Output voltage for SET2 Default: (1000010) ₂ = 1.16V
D5		0			
D4		0		D6-D0	Output voltage
D3		0		000 0000	500 mV
D2		0		000 0001	510 mV
				000 0010	520 mV
D1		1	
		111 1111	1770 mV		
D0		LSB	0	$V_{OUT} = (xxx\ xxxx)_2 \times 10\text{mV} + 500\text{ mV}$	

Table 23. TPS62362 Register 0x02h Description

REGISTER ADDRESS: 0x02h Read/Write															
BIT	NAME	DEFAULT	DESCRIPTION												
D7	MODE2	MSB	0 Operation mode for SET2 0 = PFM / PWM mode operation 1 = Forced PWM mode operation												
D6			x Reserved for future use												
D5	OV2[5:0]		1 Output voltage for SET2 Default: (101011) ₂ = 1.2V												
D4			0												
D3			1												
D2			0												
D1			1												
D0		LSB	1	V _{OUT} = (xx xxxx) ₂ × 10mV + 770 mV											
				<table border="1"> <thead> <tr> <th>D5-D0</th> <th>Output voltage</th> </tr> </thead> <tbody> <tr> <td>00 0000</td> <td>770 mV</td> </tr> <tr> <td>00 0001</td> <td>780 mV</td> </tr> <tr> <td>00 0010</td> <td>790 mV</td> </tr> <tr> <td>...</td> <td>...</td> </tr> <tr> <td>11 1111</td> <td>1400 mV</td> </tr> </tbody> </table>	D5-D0	Output voltage	00 0000	770 mV	00 0001	780 mV	00 0010	790 mV	11 1111
D5-D0	Output voltage														
00 0000	770 mV														
00 0001	780 mV														
00 0010	790 mV														
...	...														
11 1111	1400 mV														

Table 24. TPS62363 Register 0x02h Description

REGISTER ADDRESS: 0x02h Read/Write															
BIT	NAME	DEFAULT	DESCRIPTION												
D7	MODE2	MSB	0 Operation mode for SET2 0 = PFM / PWM mode operation 1 = Forced PWM mode operation												
D6	OV2[6:0]		1 Output voltage for SET2 Default: (1100100) ₂ = 1.5V												
D5			1												
D4			0												
D3			0												
D2			1												
D1			0												
D0		LSB	0	V _{OUT} = (xxx xxxx) ₂ × 10mV + 500 mV											
			<table border="1"> <thead> <tr> <th>D6-D0</th> <th>Output voltage</th> </tr> </thead> <tbody> <tr> <td>000 0000</td> <td>500 mV</td> </tr> <tr> <td>000 0001</td> <td>510 mV</td> </tr> <tr> <td>000 0010</td> <td>520 mV</td> </tr> <tr> <td>...</td> <td>...</td> </tr> <tr> <td>111 1111</td> <td>1770 mV</td> </tr> </tbody> </table>	D6-D0	Output voltage	000 0000	500 mV	000 0001	510 mV	000 0010	520 mV	111 1111	1770 mV
D6-D0	Output voltage														
000 0000	500 mV														
000 0001	510 mV														
000 0010	520 mV														
...	...														
111 1111	1770 mV														

Register 0x03h Description: SET3

The register settings apply by choosing SET3 (VSEL1 = HIGH, VSEL0 = HIGH).

Table 25. TPS62360 Register 0x03h Description

REGISTER ADDRESS: 0x03h Read/Write					
BIT	NAME	DEFAULT	DESCRIPTION		
D7	MODE3	MSB	0	Operation mode for SET3 0 = PFM / PWM mode operation 1 = Forced PWM mode operation	
D6			x	Reserved for future use	
D5	OV3[5:0]		1	Output voltage for SET3 Default: $(100001)_2 = 1.1V$	
D4			0	D5-D0	Output voltage
D3			0	00 0000	770 mV
D2			0	00 0001	780 mV
				00 0010	790 mV
D1			0
				11 1111	1400 mV
D0		LSB	1	$V_{OUT} = (xx\ xxxx)_2 \times 10mV + 770\ mV$	

Table 26. TPS62361B Register 0x03h Description

REGISTER ADDRESS: 0x03h Read/Write					
BIT	NAME	DEFAULT	DESCRIPTION		
D7	MODE3	MSB	0	Operation mode for SET3 0 = PFM / PWM mode operation 1 = Forced PWM mode operation	
D6	OV3[6:0]			1	Output voltage for SET3 Default: $(1000010)_2 = 1.16V$
D5		0			
D4		0		D6-D0	Output voltage
D3		0		000 0000	500 mV
D2		0		000 0001	510 mV
				000 0010	520 mV
D1		1	
		111 1111	1770 mV		
D0		LSB	0	$V_{OUT} = (xxx\ xxxx)_2 \times 10mV + 500\ mV$	

Table 27. TPS62362 Register 0x03h Description

REGISTER ADDRESS: 0x03h Read/Write			
BIT	NAME	DEFAULT	DESCRIPTION
D7	MODE3	MSB	0 Operation mode for SET3 0 = PFM / PWM mode operation 1 = Forced PWM mode operation
D6			x Reserved for future use
D5	OV3[5:0]		1 Output voltage for SET3 Default: (100001) ₂ = 1.1V
D4			0
D3			0
D2			0
D1			0
			0
D0			LSB

Table 28. TPS62363 Register 0x03h Description

REGISTER ADDRESS: 0x03h Read/Write			
BIT	NAME	DEFAULT	DESCRIPTION
D7	MODE3	MSB	0 Operation mode for SET3 0 = PFM / PWM mode operation 1 = Forced PWM mode operation
D6	OV3[6:0]		0 Output voltage for SET3 Default: (0110010) ₂ = 1.0V
D5			1
D4			1
D3			0
D2			0
D1			1
D0			LSB

Register 0x04h Description: Ctrl

Table 29. TPS6236x Register 0x04h Description

REGISTER ADDRESS: 0x04h Read / Write			
BIT	NAME	DEFAULT	DESCRIPTION
D7	PD_EN	MSB	1 EN internal pull down resistor 0 = disabled 1 = enabled
D6	PD_VSEL0		1 VSEL0 internal pull down resistor 0 = disabled 1 = enabled
D5	PD_VSEL1		1 VSEL1 internal pull down resistor 0 = disabled 1 = enabled
D4			x Reserved for future use
D3			x Reserved for future use
D2			x Reserved for future use
D1			x Reserved for future use
D0			LSB x Reserved for future use

Register 0x05h Description: Temp

Table 30. TPS6236x Register 0x05h Description

REGISTER ADDRESS: 0x05h Read/Write			
BIT	NAME	DEFAULT	DESCRIPTION
D7		MSB	x Reserved for future use
D6			x Reserved for future use
D5			x Reserved for future use
D4			x Reserved for future use
D3			x Reserved for future use
D2	DIS_TS	0	Disable temperature shutdown feature 0 = Temperature shutdown enabled 1 = Temperature shutdown disabled (not recommended)
D1	TJEW	0	T _J early warning bit 0 = T _J < 120°C (typ) 1 = T _J ≥ 120°C (typ)
D0	TJTS	0	T _J temperature shutdown bit 0 = die temperature within the valid range 1 = temperature shutdown was triggered
		LSB	Bit needs to be reset after it has been latched.

Register 0x06h Description: RmpCtrl
Table 31. TPS6236x Register 0x06h Description

REGISTER ADDRESS: 0x06h Read/Write																		
BIT	NAME	DEFAULT	DESCRIPTION															
D7	RMP[2:0]	MSB	Output voltage ramp timing															
			0	<table border="1"> <thead> <tr> <th>D7-D5</th> <th>Slope</th> </tr> </thead> <tbody> <tr> <td>000</td> <td>32 mV / μs</td> </tr> <tr> <td>001</td> <td>16 mV / μs</td> </tr> <tr> <td>010</td> <td>8 mV / μs</td> </tr> <tr> <td>...</td> <td>...</td> </tr> <tr> <td>110</td> <td>0.5 mV / μs</td> </tr> <tr> <td>111</td> <td>0.25 mV / μs</td> </tr> </tbody> </table>	D7-D5	Slope	000	32 mV / μ s	001	16 mV / μ s	010	8 mV / μ s	110	0.5 mV / μ s	111	0.25 mV / μ s
D7-D5			Slope															
000			32 mV / μ s															
001			16 mV / μ s															
010			8 mV / μ s															
...			...															
110			0.5 mV / μ s															
111			0.25 mV / μ s															
D6			0	<table border="1"> <thead> <tr> <th>D7-D5</th> <th>Slope</th> </tr> </thead> <tbody> <tr> <td>000</td> <td>32 mV / μs</td> </tr> <tr> <td>001</td> <td>16 mV / μs</td> </tr> <tr> <td>010</td> <td>8 mV / μs</td> </tr> <tr> <td>...</td> <td>...</td> </tr> <tr> <td>110</td> <td>0.5 mV / μs</td> </tr> <tr> <td>111</td> <td>0.25 mV / μs</td> </tr> </tbody> </table>	D7-D5	Slope	000	32 mV / μ s	001	16 mV / μ s	010	8 mV / μ s	110	0.5 mV / μ s	111	0.25 mV / μ s
D7-D5	Slope																	
000	32 mV / μ s																	
001	16 mV / μ s																	
010	8 mV / μ s																	
...	...																	
110	0.5 mV / μ s																	
111	0.25 mV / μ s																	
D5	0	$\frac{\Delta V_{OUT}}{\Delta t} = 32 \frac{mV}{\mu s} \frac{1}{2^{(RMP[2-0])_2}}$																
D4		x	Reserved for future use															
D3		x	Reserved for future use															
D2	EN_DISC	0	Active output capacitor discharge at shutdown 0 = disabled 1 = enabled															
D1	RAMP_PFM	0	Defines the ramp behavior if the device is in Power Save (PFM) mode 0 = output cap will be discharged by the load 1 = output voltage will be forced to follow the ramp down slope															
D0		LSB	x	Reserved for future use														

Register 0x07h Description: (Reserved)
Table 32. TPS6236x Register 0x07h Description

REGISTER ADDRESS: 0x07h				
BIT	NAME	DEFAULT	DESCRIPTION	
D7		MSB	x	Reserved for future use
D6			x	Reserved for future use
D5			x	Reserved for future use
D4			x	Reserved for future use
D3			x	Reserved for future use
D2			x	Reserved for future use
D1			x	Reserved for future use
D0			LSB	x

Register 0x08h, 0x09h Description Chip_ID:

Table 33. TPS6236x Register 0x08h and 0x09h Description

REGISTER ADDRESS: 0x08h, 0x09 Read				
BIT	NAME	DEFAULT	DESCRIPTION	
D7		MSB	Vendor ID	
D6				1
D5				0
D4				0
D3		x	D3-D2	Part number ID
D2			00	TPS62360
			01	TPS62361B
			11	TPS62363
D1		x	D1-D0	Chip revision ID
D0			00	Rev. 1
			01	Rev. 2
			11	Rev. 4
		LSB		

PACKAGE SUMMARY

CHIP SCALE PACKAGE (TOP VIEW)

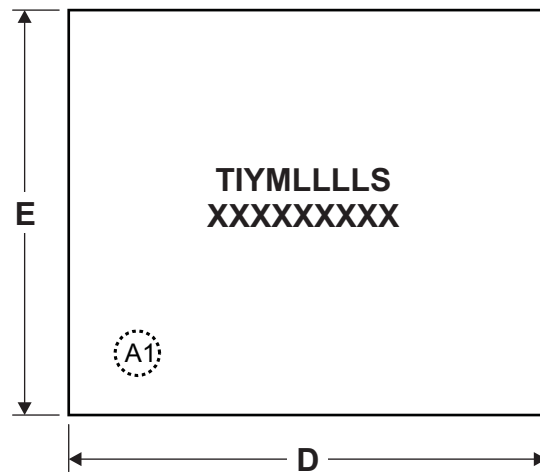

Code:

- TI — Texas Instruments
- YM — Year Month date code
- LLLL — Lot trace code
- S — Assembly site code
- XXXXXXXX — Part number
 - TPS62360 = TPS62360
 - TPB62361 = TPS62361B
 - TPS62362 = TPS62362
 - TPS62363 = TPS62363

Figure 53. Package Marking and Dimensions

CHIP SCALE PACKAGE DIMENSIONS

The TPS6236x device is available in a 16-bump chip scale package (YZH, NanoFree™). The package dimensions are given as:

- D = 2.076mm (+/- 0.03mm)
- E = 2.076mm (+/- 0.03mm)

REVISION HISTORY

Changes from Revision B (March 2012) to Revision C	Page
• Changed solution size of approximately 27.5 mm ² to 25 mm ²	1
• Changed application schematic	1
• Changed layout diagram	1
• Changed TPS62362 output voltage preset from 1.10V to 1.00V in ORDERING INFORMATION	2
• Changed continuous output current in RECOMMENDED OPERATING CONDITIONS	3
• Added rising and falling signal transition time at EN, VSELx to RECOMMENDED OPERATING CONDITIONS, removed from from ELECTRICAL CHARACTERISTICS	3
• Changed Figure 40	26
• Changed Figure 45	29
• Changed Figure 46	29
• Changed Figure 47	29
• Changed I ² C REGISTER RESET information	30
• Added Figure 48	30
• Changed C _{IN} = 4.7μF to 22μF to C _{IN} = 10μF to 22μF in INPUT CAPACITOR SELECTION	30
• Changed optional low pass filter in DECOUPLING CAPACITORS AT AVIN, VDD	31
• Changed Table 8 (updated list of recommended Inductors)	32
• Changed OUTPUT CAPACITOR SELECTION description	32
• Changed OUTPUT FILTER DESIGN description	32
• Changed PCB LAYOUT description	34

PACKAGING INFORMATION

Orderable Device	Status (1)	Package Type	Package Drawing	Pins	Package Qty	Eco Plan (2)	Lead finish/ Ball material (6)	MSL Peak Temp (3)	Op Temp (°C)	Device Marking (4/5)	Samples
TPS62360YZHR	ACTIVE	DSBGA	YZH	16	3000	RoHS & Green	SNAGCU	Level-1-260C-UNLIM	-40 to 85	TPS62360	Samples
TPS62360YZHT	ACTIVE	DSBGA	YZH	16	250	RoHS & Green	SNAGCU	Level-1-260C-UNLIM	-40 to 85	TPS62360	Samples
TPS62361BYZHR	ACTIVE	DSBGA	YZH	16	3000	RoHS & Green	SNAGCU	Level-1-260C-UNLIM	-40 to 85	TPB62361	Samples
TPS62361BYZHT	ACTIVE	DSBGA	YZH	16	250	RoHS & Green	SNAGCU	Level-1-260C-UNLIM	-40 to 85	TPB62361	Samples
TPS62362YZHR	ACTIVE	DSBGA	YZH	16	3000	RoHS & Green	SNAGCU	Level-1-260C-UNLIM	-40 to 85	TPS62362	Samples
TPS62362YZHT	ACTIVE	DSBGA	YZH	16	250	RoHS & Green	SNAGCU	Level-1-260C-UNLIM	-40 to 85	TPS62362	Samples
TPS62363YZHR	ACTIVE	DSBGA	YZH	16	3000	RoHS & Green	SNAGCU	Level-1-260C-UNLIM	-40 to 85	TPS62363	Samples
TPS62363YZHT	ACTIVE	DSBGA	YZH	16	250	RoHS & Green	SNAGCU	Level-1-260C-UNLIM	-40 to 85	TPS62363	Samples

(1) The marketing status values are defined as follows:

ACTIVE: Product device recommended for new designs.

LIFEBUY: TI has announced that the device will be discontinued, and a lifetime-buy period is in effect.

NRND: Not recommended for new designs. Device is in production to support existing customers, but TI does not recommend using this part in a new design.

PREVIEW: Device has been announced but is not in production. Samples may or may not be available.

OBSELETE: TI has discontinued the production of the device.

(2) **RoHS:** TI defines "RoHS" to mean semiconductor products that are compliant with the current EU RoHS requirements for all 10 RoHS substances, including the requirement that RoHS substance do not exceed 0.1% by weight in homogeneous materials. Where designed to be soldered at high temperatures, "RoHS" products are suitable for use in specified lead-free processes. TI may reference these types of products as "Pb-Free".

RoHS Exempt: TI defines "RoHS Exempt" to mean products that contain lead but are compliant with EU RoHS pursuant to a specific EU RoHS exemption.

Green: TI defines "Green" to mean the content of Chlorine (Cl) and Bromine (Br) based flame retardants meet JS709B low halogen requirements of <=1000ppm threshold. Antimony trioxide based flame retardants must also meet the <=1000ppm threshold requirement.

(3) MSL, Peak Temp. - The Moisture Sensitivity Level rating according to the JEDEC industry standard classifications, and peak solder temperature.

(4) There may be additional marking, which relates to the logo, the lot trace code information, or the environmental category on the device.

(5) Multiple Device Markings will be inside parentheses. Only one Device Marking contained in parentheses and separated by a "~" will appear on a device. If a line is indented then it is a continuation of the previous line and the two combined represent the entire Device Marking for that device.

⁽⁶⁾ Lead finish/Ball material - Orderable Devices may have multiple material finish options. Finish options are separated by a vertical ruled line. Lead finish/Ball material values may wrap to two lines if the finish value exceeds the maximum column width.

Important Information and Disclaimer: The information provided on this page represents TI's knowledge and belief as of the date that it is provided. TI bases its knowledge and belief on information provided by third parties, and makes no representation or warranty as to the accuracy of such information. Efforts are underway to better integrate information from third parties. TI has taken and continues to take reasonable steps to provide representative and accurate information but may not have conducted destructive testing or chemical analysis on incoming materials and chemicals. TI and TI suppliers consider certain information to be proprietary, and thus CAS numbers and other limited information may not be available for release.

In no event shall TI's liability arising out of such information exceed the total purchase price of the TI part(s) at issue in this document sold by TI to Customer on an annual basis.

TAPE AND REEL INFORMATION

QUADRANT ASSIGNMENTS FOR PIN 1 ORIENTATION IN TAPE

*All dimensions are nominal

Device	Package Type	Package Drawing	Pins	SPQ	Reel Diameter (mm)	Reel Width W1 (mm)	A0 (mm)	B0 (mm)	K0 (mm)	P1 (mm)	W (mm)	Pin1 Quadrant
TPS62360YZHR	DSBGA	YZH	16	3000	180.0	8.4	2.18	2.18	0.81	4.0	8.0	Q1
TPS62360YZHT	DSBGA	YZH	16	250	180.0	8.4	2.18	2.18	0.81	4.0	8.0	Q1
TPS62361BYZHR	DSBGA	YZH	16	3000	180.0	8.4	2.18	2.18	0.81	4.0	8.0	Q1
TPS62361BYZHT	DSBGA	YZH	16	250	180.0	8.4	2.18	2.18	0.81	4.0	8.0	Q1
TPS62362YZHR	DSBGA	YZH	16	3000	180.0	8.4	2.18	2.18	0.81	4.0	8.0	Q1
TPS62362YZHT	DSBGA	YZH	16	250	180.0	8.4	2.18	2.18	0.81	4.0	8.0	Q1
TPS62363YZHR	DSBGA	YZH	16	3000	180.0	8.4	2.18	2.18	0.81	4.0	8.0	Q1
TPS62363YZHT	DSBGA	YZH	16	250	180.0	8.4	2.18	2.18	0.81	4.0	8.0	Q1

TAPE AND REEL BOX DIMENSIONS

*All dimensions are nominal

Device	Package Type	Package Drawing	Pins	SPQ	Length (mm)	Width (mm)	Height (mm)
TPS62360YZHR	DSBGA	YZH	16	3000	182.0	182.0	20.0
TPS62360YZHT	DSBGA	YZH	16	250	182.0	182.0	20.0
TPS62361BYZHR	DSBGA	YZH	16	3000	182.0	182.0	20.0
TPS62361BYZHT	DSBGA	YZH	16	250	182.0	182.0	20.0
TPS62362YZHR	DSBGA	YZH	16	3000	182.0	182.0	20.0
TPS62362YZHT	DSBGA	YZH	16	250	182.0	182.0	20.0
TPS62363YZHR	DSBGA	YZH	16	3000	182.0	182.0	20.0
TPS62363YZHT	DSBGA	YZH	16	250	182.0	182.0	20.0

YZH0016

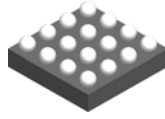

PACKAGE OUTLINE

DSBGA - 0.625 mm max height

DIE SIZE BALL GRID ARRAY

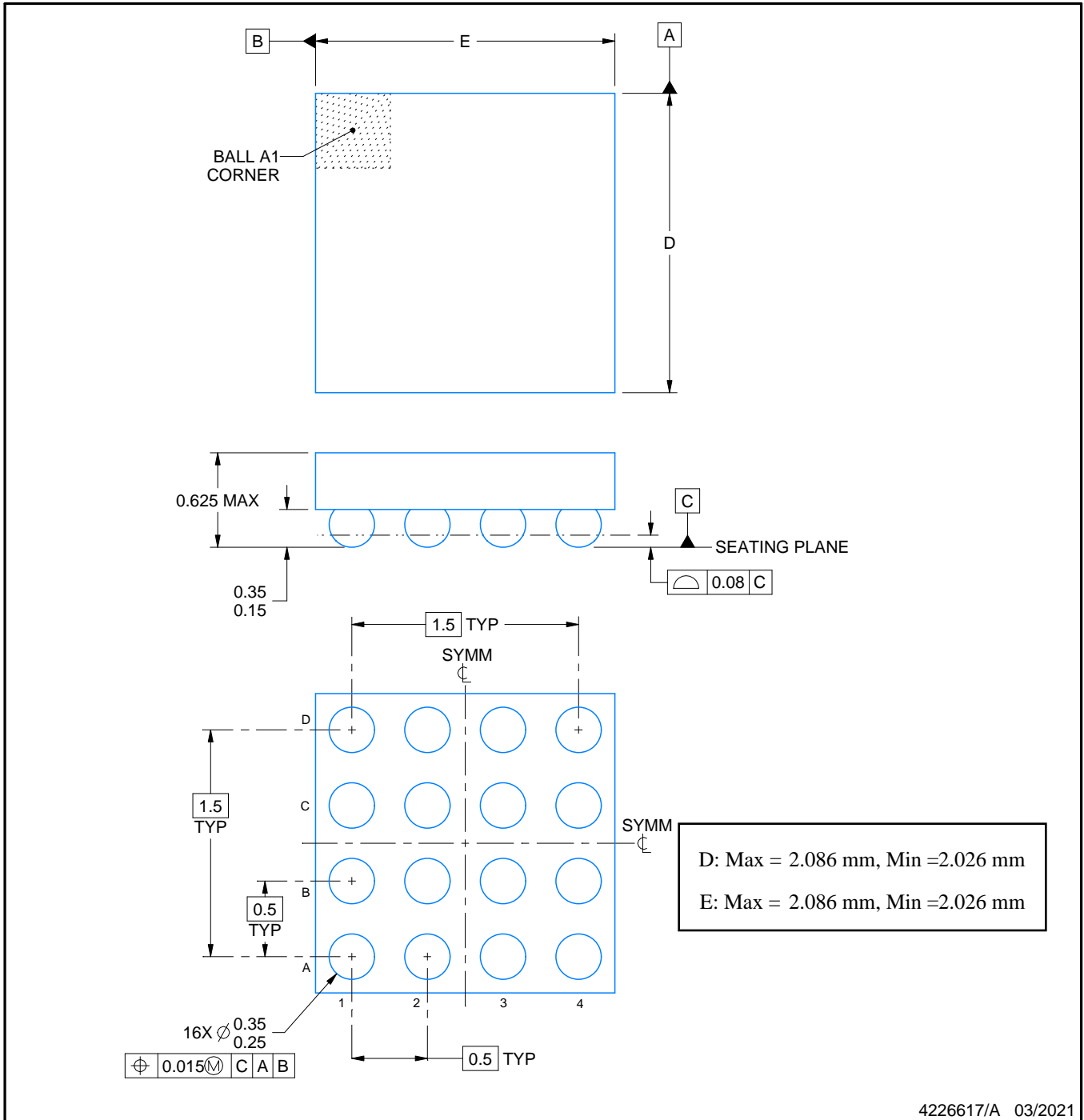

NOTES:

1. All linear dimensions are in millimeters. Any dimensions in parenthesis are for reference only. Dimensioning and tolerancing per ASME Y14.5M.
2. This drawing is subject to change without notice.

EXAMPLE BOARD LAYOUT

YZH0016

DSBGA - 0.625 mm max height

DIE SIZE BALL GRID ARRAY

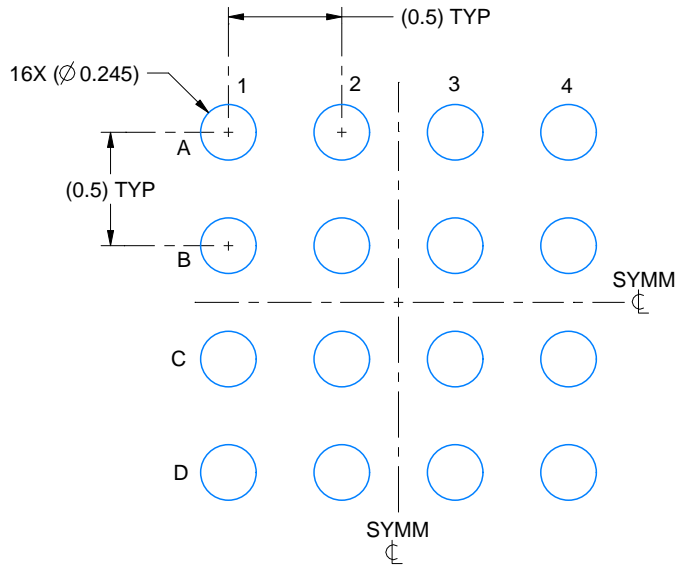

LAND PATTERN EXAMPLE
EXPOSED METAL SHOWN
SCALE: 30X

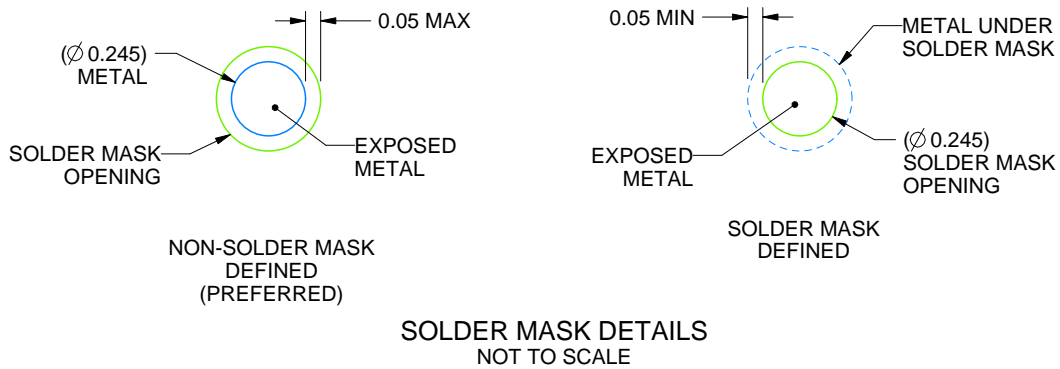

SOLDER MASK DETAILS
NOT TO SCALE

4226617/A 03/2021

NOTES: (continued)

- Final dimensions may vary due to manufacturing tolerance considerations and also routing constraints. See Texas Instruments Literature No. SNVA009 (www.ti.com/lit/snva009).

EXAMPLE STENCIL DESIGN

YZH0016

DSBGA - 0.625 mm max height

DIE SIZE BALL GRID ARRAY

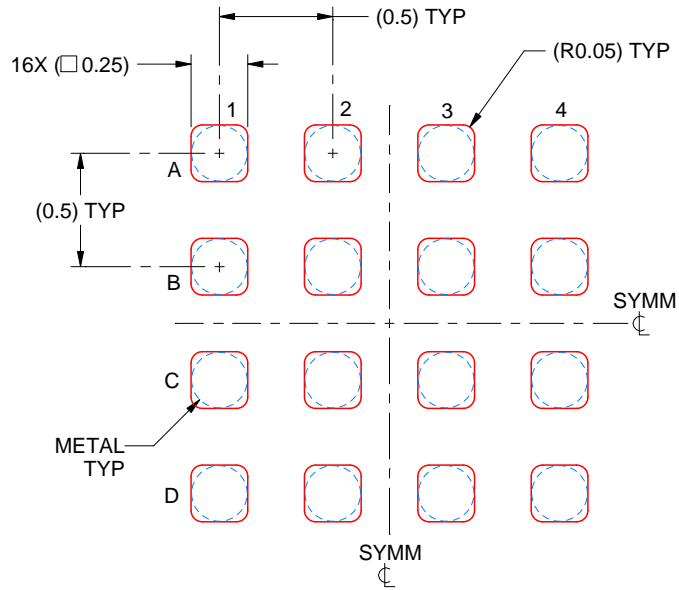

SOLDER PASTE EXAMPLE
BASED ON 0.075 mm THICK STENCIL
SCALE: 30X

4226617/A 03/2021

NOTES: (continued)

4. Laser cutting apertures with trapezoidal walls and rounded corners may offer better paste release.

IMPORTANT NOTICE AND DISCLAIMER

TI PROVIDES TECHNICAL AND RELIABILITY DATA (INCLUDING DATA SHEETS), DESIGN RESOURCES (INCLUDING REFERENCE DESIGNS), APPLICATION OR OTHER DESIGN ADVICE, WEB TOOLS, SAFETY INFORMATION, AND OTHER RESOURCES "AS IS" AND WITH ALL FAULTS, AND DISCLAIMS ALL WARRANTIES, EXPRESS AND IMPLIED, INCLUDING WITHOUT LIMITATION ANY IMPLIED WARRANTIES OF MERCHANTABILITY, FITNESS FOR A PARTICULAR PURPOSE OR NON-INFRINGEMENT OF THIRD PARTY INTELLECTUAL PROPERTY RIGHTS.

These resources are intended for skilled developers designing with TI products. You are solely responsible for (1) selecting the appropriate TI products for your application, (2) designing, validating and testing your application, and (3) ensuring your application meets applicable standards, and any other safety, security, regulatory or other requirements.

These resources are subject to change without notice. TI grants you permission to use these resources only for development of an application that uses the TI products described in the resource. Other reproduction and display of these resources is prohibited. No license is granted to any other TI intellectual property right or to any third party intellectual property right. TI disclaims responsibility for, and you will fully indemnify TI and its representatives against, any claims, damages, costs, losses, and liabilities arising out of your use of these resources.

TI's products are provided subject to [TI's Terms of Sale](#) or other applicable terms available either on [ti.com](https://www.ti.com) or provided in conjunction with such TI products. TI's provision of these resources does not expand or otherwise alter TI's applicable warranties or warranty disclaimers for TI products.

TI objects to and rejects any additional or different terms you may have proposed.

Mailing Address: Texas Instruments, Post Office Box 655303, Dallas, Texas 75265
Copyright © 2024, Texas Instruments Incorporated