

# TPS77601-EP, TPS77615-EP, TPS77618-EP, TPS77625-EP TPS77628-EP, TPS77633-EP WITH PG OUTPUT FAST-TRANSIENT-RESPONSE 500-mA LOW-DROPOUT VOLTAGE REGULATORS

SGLS176A – AUGUST 2003 – REVISED MARCH 2007

- **Controlled Baseline**  
– One Assembly/Test Site, One Fabrication Site
- **Extended Temperature Performance of**  
–40°C to 125°C
- **Enhanced Diminishing Manufacturing Sources (DMS) Support**
- **Enhanced Product Change Notification**
- **Qualification Pedigree†**
- **Open Drain Power Good**
- **500-mA Low-Dropout Voltage Regulator**
- **Available in 1.5-V, 1.8-V, 2.5-V, 2.8-V, 3.3-V Fixed Output and Adjustable Versions**
- **Dropout Voltage to 169 mV (Typ) at 500 mA (TPS77633)**
- **Ultralow 85  $\mu$ A Typical Quiescent Current**
- **Fast Transient Response**
- **2% Tolerance Over Specified Conditions for Fixed-Output Versions**
- **20-Pin TSSOP PowerPAD™ (PWP) Package**
- **Thermal Shutdown Protection**

**PWP PACKAGE  
(TOP VIEW)**

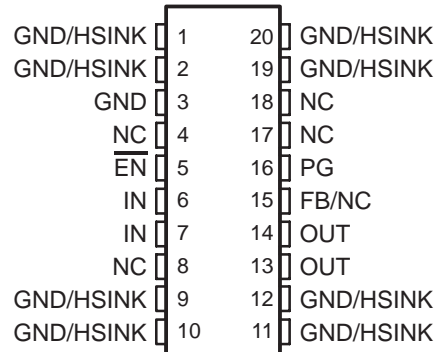

NC – No internal connection

† Component qualification in accordance with JEDEC and industry standards to ensure reliable operation over an extended temperature range. This includes, but is not limited to, Highly Accelerated Stress Test (HAST) or biased 85/85, temperature cycle, autoclave or unbiased HAST, electromigration, bond intermetallic life, and mold compound life. Such qualification testing should not be viewed as justifying use of this component beyond specified performance and environmental limits.

## description

The TPS776xx devices are designed to have a fast transient response and be stable with a 10- $\mu$ F low ESR capacitors. This combination provides high performance at a reasonable cost.

Because the PMOS device behaves as a low-value resistor, the dropout voltage is very low (typically 169 mV at an output current of 500 mA for the TPS77633) and is directly proportional to the output current. Additionally, since the PMOS pass element is a voltage-driven device, the quiescent current is very low and independent of output loading (typically 85  $\mu$ A over the full range of output current, 0 mA to 500 mA). These two key specifications yield a significant improvement in operating life for battery-powered systems. This LDO family also features a sleep mode; applying a TTL high signal to EN (enable) shuts down the regulator, reducing the quiescent current to 1  $\mu$ A at  $T_J = 25^\circ\text{C}$ .

Power good (PG) of the TPS776xx is an active high output, which can be used to implement a power-on reset or a low-battery indicator.

The TPS776xx are offered in 1.5-V, 1.8-V, 2.5-V, 2.8 V, and 3.3-V fixed-voltage versions and in an adjustable version (programmable over the range of 1.2 V to 5.5 V for TPS77601 option). Output voltage tolerance is specified as a maximum of 2% over line, load, and temperature ranges. The TPS776xx family is available in 20 pin TSSOP package.



Please be aware that an important notice concerning availability, standard warranty, and use in critical applications of Texas Instruments semiconductor products and disclaimers thereto appears at the end of this data sheet.

PowerPAD is a trademark of Texas Instruments.

PRODUCTION DATA information is current as of publication date. Products conform to specifications per the terms of Texas Instruments standard warranty. Production processing does not necessarily include testing of all parameters.



POST OFFICE BOX 655303 • DALLAS, TEXAS 75265

Copyright © 2007, Texas Instruments Incorporated

**TPS77601-EP, TPS77615-EP, TPS77618-EP, TPS77625-EP  
 TPS77628-EP, TPS77633-EP WITH PG OUTPUT  
 FAST-TRANSIENT-RESPONSE 500-mA LOW-DROPOUT VOLTAGE REGULATORS**

SGLS176A – AUGUST 2003 – REVISED MARCH 2007

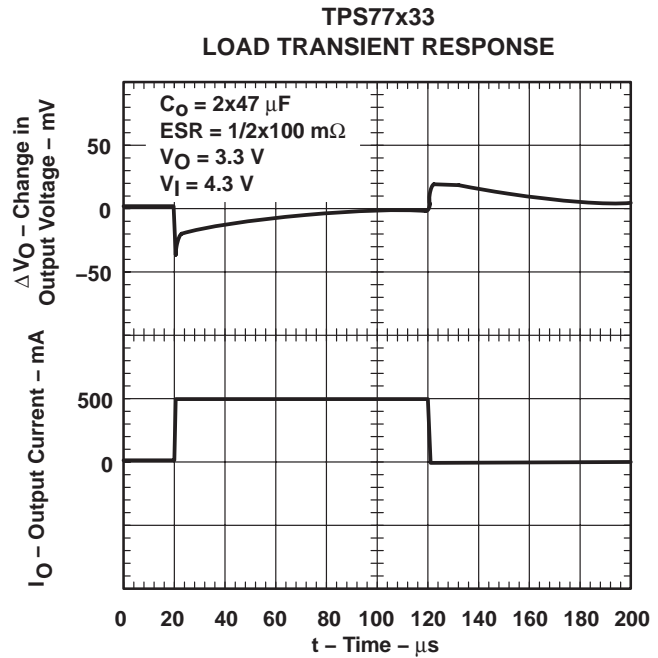
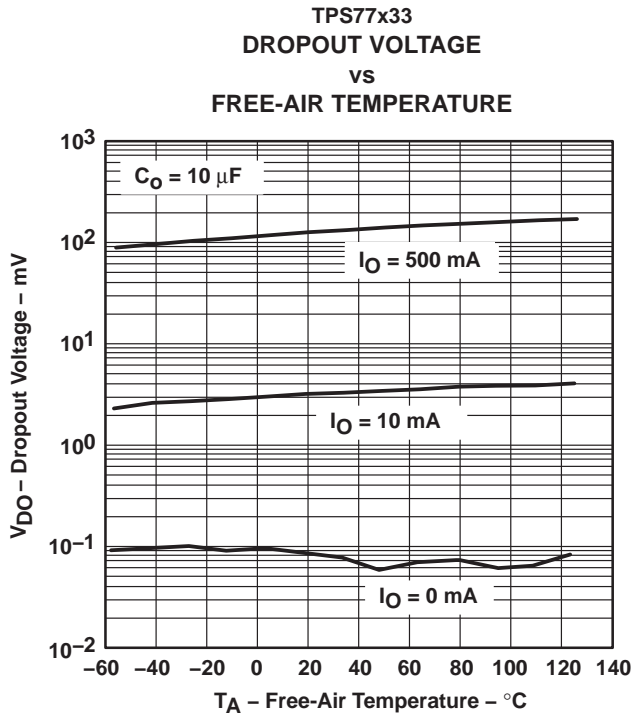

**ORDERING INFORMATION†**

$T_A$	OUTPUT VOLTAGE (V TYP)	PACKAGE		ORDERABLE PART NUMBER	TOP-SIDE MARKING
-40°C to 125°C	3.3	TSSOP - PW	Tape and reel	TPS77633QPWPREP	77633QE
	2.8	TSSOP - PW	Tape and reel	TPS77628QPWPREP§	77628QE
	2.5	TSSOP - PW	Tape and reel	TPS77625QPWPREP	77625QE
	1.8	TSSOP - PW	Tape and reel	TPS77618QPWPREP	77618QE
	1.5	TSSOP - PW	Tape and reel	TPS77615QPWPREP	77615QE
	Adjustable‡ 1.2 V to 5.5 V	TSSOP - PW	Tape and reel	TPS77601QPWPREP	77601QE

† Package drawings, standard packing quantities, thermal data, symbolization, and PCB design guidelines are available at [www.ti.com/sc/package](http://www.ti.com/sc/package).

‡ The TPS77601 is programmable using an external resistor divider (see application information).

§ TPS77628 is Product Preview.

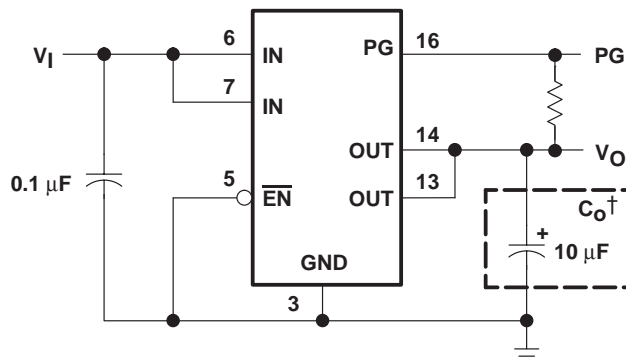

† See application information section for capacitor selection details.

**TPS77601-EP, TPS77615-EP, TPS77618-EP, TPS77625-EP  
TPS77628-EP, TPS77633-EP WITH PG OUTPUT  
FAST-TRANSIENT-RESPONSE 500-mA LOW-DROPOUT VOLTAGE REGULATORS**

SGLS176A – AUGUST 2003 – REVISED MARCH 2007

Figure 1. Typical Application Configuration for Fixed Output Options

functional block diagram—adjustable version

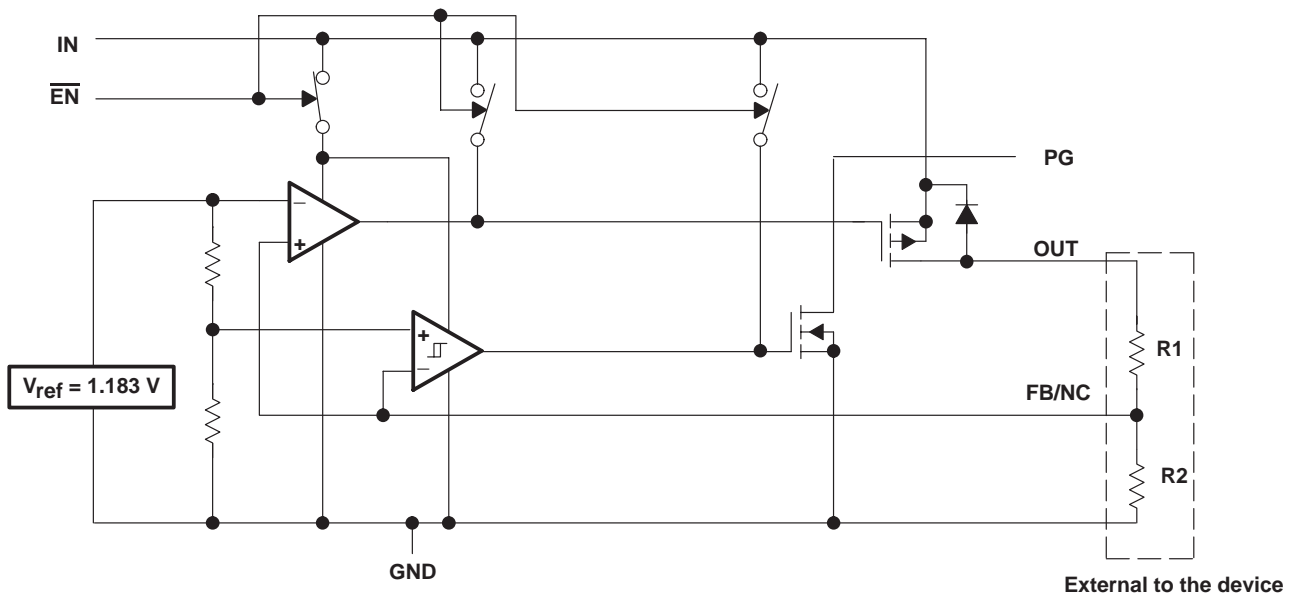

functional block diagram—fixed-voltage version

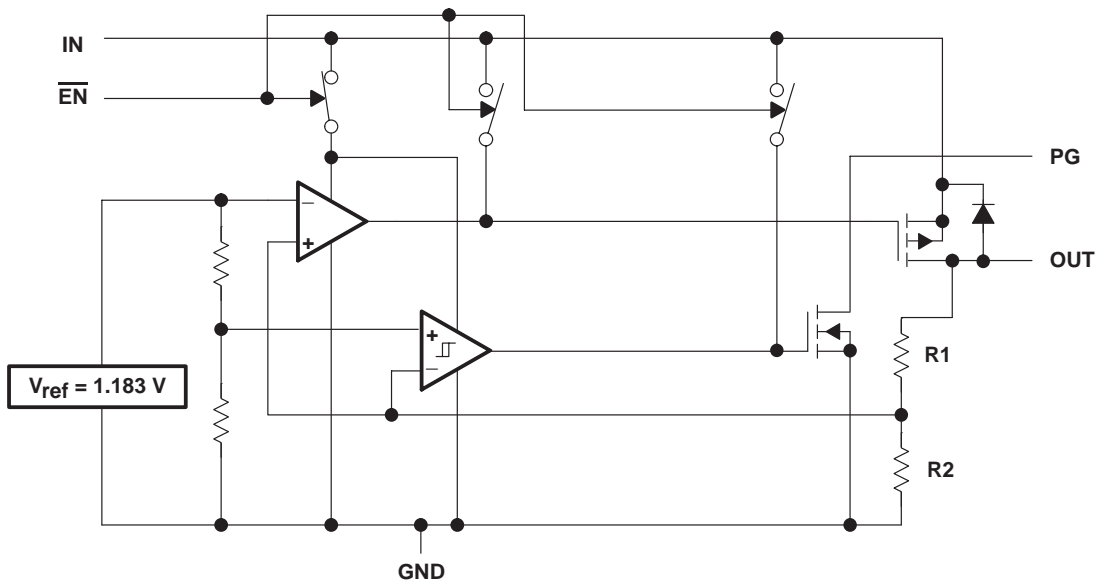

**TPS77601-EP, TPS77615-EP, TPS77618-EP, TPS77625-EP  
TPS77628-EP, TPS77633-EP WITH PG OUTPUT  
FAST-TRANSIENT-RESPONSE 500-mA LOW-DROPOUT VOLTAGE REGULATORS**

SGLS176A – AUGUST 2003 – REVISED MARCH 2007

---

**Terminal Functions**

**TSSOP Package**

TERMINAL		I/O	DESCRIPTION
NAME	NO.		
$\overline{\text{EN}}$	5	I	Enable input
FB/NC	15	I	Feedback input voltage for adjustable device (no connect for fixed options)
GND	3		Regulator ground
GND/HSINK	1, 2, 9, 10, 11, 12, 19, 20		Ground/heatsink
IN	6, 7	I	Input voltage
NC	4, 8, 17, 18		No connect
OUT	13, 14	O	Regulated output voltage
PG	16	O	PG output



POST OFFICE BOX 655303 • DALLAS, TEXAS 75265

**TPS77601-EP, TPS77615-EP, TPS77618-EP, TPS77625-EP  
TPS77628-EP, TPS77633-EP WITH PG OUTPUT  
FAST-TRANSIENT-RESPONSE 500-mA LOW-DROPOUT VOLTAGE REGULATORS**

SGLS176A – AUGUST 2003 – REVISED MARCH 2007

**absolute maximum ratings over operating free-air temperature range (unless otherwise noted)<sup>†</sup>**

Input voltage range <sup>‡</sup> , $V_I$ .....	-0.3 V to 13.5 V
Voltage range at $\overline{EN}$ .....	-0.3 V to 16.5 V
Maximum PG voltage .....	16.5 V
Peak output current .....	Internally limited
Output voltage, $V_O$ (OUT, FB) .....	7 V
Continuous total power dissipation .....	See dissipation rating tables
Operating virtual junction temperature range, $T_J$ .....	-40°C to 125°C
Storage temperature range, $T_{stg}$ .....	-65°C to 150°C
ESD rating, HBM .....	2 kV

<sup>†</sup> Stresses beyond those listed under “absolute maximum ratings” may cause permanent damage to the device. These are stress ratings only, and functional operation of the device at these or any other conditions beyond those indicated under “recommended operating conditions” is not implied. Exposure to absolute-maximum-rated conditions for extended periods may affect device reliability.

<sup>‡</sup> All voltage values are with respect to network terminal ground.

**DISSIPATION RATING TABLE – FREE-AIR TEMPERATURES**

PACKAGE	AIR FLOW (CFM)	$T_A < 25^\circ\text{C}$ POWER RATING	DERATING FACTOR ABOVE $T_A = 25^\circ\text{C}$	$T_A = 70^\circ\text{C}$ POWER RATING	$T_A = 85^\circ\text{C}$ POWER RATING
PWP <sup>§</sup>	0	2.9 W	23.5 mW/°C	1.9 W	1.5 W
	300	4.3 W	34.6 mW/°C	2.8 W	2.2 W
PWP <sup>¶</sup>	0	3 W	23.8 mW/°C	1.9 W	1.5 W
	300	7.2 W	57.9 mW/°C	4.6 W	3.8 W

<sup>§</sup> This parameter is measured with the recommended copper heat sink pattern on a 1-layer PCB, 5-in × 5-in PCB, 1 oz. copper, 2-in × 2-in coverage (4 in<sup>2</sup>).

<sup>¶</sup> This parameter is measured with the recommended copper heat sink pattern on a 8-layer PCB, 1.5-in × 2-in PCB, 1 oz. copper with layers 1, 2, 4, 5, 7, and 8 at 5% coverage (0.9 in<sup>2</sup>) and layers 3 and 6 at 100% coverage (6 in<sup>2</sup>). For more information, refer to TI technical brief SLMA002.

**recommended operating conditions**

	MIN	MAX	UNIT
Input voltage, $V_I$ <sup>#</sup>	2.7	10	V
Output voltage range, $V_O$	1.2	5.5	V
Output current, $I_O$ (see Note 1)	0	500	mA
Operating virtual junction temperature, $T_J$ (see Note 1)	-40	125	°C

<sup>#</sup> To calculate the minimum input voltage for your maximum output current, use the following equation:  $V_{I(\min)} = V_{O(\max)} + V_{DO(\max \text{ load})}$ .

NOTE 1: Continuous current and operating junction temperature are limited by internal protection circuitry, but it is not recommended that the device operate under conditions beyond those specified in this table for extended periods of time.



**TPS77601-EP, TPS77615-EP, TPS77618-EP, TPS77625-EP  
 TPS77628-EP, TPS77633-EP WITH PG OUTPUT  
 FAST-TRANSIENT-RESPONSE 500-mA LOW-DROPOUT VOLTAGE REGULATORS**

SGLS176A – AUGUST 2003 – REVISED MARCH 2007

electrical characteristics over recommended operating free-air temperature range,  
 $V_I = V_O(\text{typ}) + 1 \text{ V}$ ,  $I_O = 1 \text{ mA}$ ,  $\overline{\text{EN}} = 0 \text{ V}$ ,  $C_O = 10 \mu\text{F}$  (unless otherwise noted)

PARAMETER		TEST CONDITIONS	MIN	TYP	MAX	UNIT
Output voltage (10 $\mu\text{A}$ to 500 mA load) (see Note 2)	TPS77601	$1.2 \text{ V} \leq V_O \leq 5.5 \text{ V}$ , $T_J = 25^\circ\text{C}$	$V_O$			V
		$1.2 \text{ V} \leq V_O \leq 5.5 \text{ V}$ , $T_J = -40^\circ\text{C}$ to $125^\circ\text{C}$	$0.98V_O$	$1.02V_O$		
	TPS77615	$T_J = 25^\circ\text{C}$ , $2.7 \text{ V} < V_{\text{IN}} < 10 \text{ V}$	1.5			V
		$T_J = -40^\circ\text{C}$ to $125^\circ\text{C}$ , $2.7 \text{ V} < V_{\text{IN}} < 10 \text{ V}$	1.470	1.530		
	TPS77618	$T_J = 25^\circ\text{C}$ , $2.8 \text{ V} < V_{\text{IN}} < 10 \text{ V}$	1.8			V
		$T_J = -40^\circ\text{C}$ to $125^\circ\text{C}$ , $2.8 \text{ V} < V_{\text{IN}} < 10 \text{ V}$	1.764	1.836		
	TPS77625	$T_J = 25^\circ\text{C}$ , $3.5 \text{ V} < V_{\text{IN}} < 10 \text{ V}$	2.5			V
		$T_J = -40^\circ\text{C}$ to $125^\circ\text{C}$ , $3.5 \text{ V} < V_{\text{IN}} < 10 \text{ V}$	2.450	2.550		
	TPS77628	$T_J = 25^\circ\text{C}$ , $3.8 \text{ V} < V_{\text{IN}} < 10 \text{ V}$	2.8			V
		$T_J = -40^\circ\text{C}$ to $125^\circ\text{C}$ , $3.8 \text{ V} < V_{\text{IN}} < 10 \text{ V}$	2.744	2.856		
TPS77633	$T_J = 25^\circ\text{C}$ , $4.3 \text{ V} < V_{\text{IN}} < 10 \text{ V}$	3.3			V	
	$T_J = -40^\circ\text{C}$ to $125^\circ\text{C}$ , $4.3 \text{ V} < V_{\text{IN}} < 10 \text{ V}$	3.234	3.366			
Quiescent current (GND current) $\overline{\text{EN}} = 0 \text{ V}$ , (see Note 2)		$10 \mu\text{A} < I_O < 500 \text{ mA}$ , $T_J = 25^\circ\text{C}$	85			$\mu\text{A}$
		$I_O = 500 \text{ mA}$ , $T_J = -40^\circ\text{C}$ to $125^\circ\text{C}$	125			
Output voltage line regulation ( $\Delta V_O/V_O$ ) (see Notes 2 and 3)		$V_O + 1 \text{ V} < V_I \leq 10 \text{ V}$ , $T_J = 25^\circ\text{C}$	0.01			%/V
Load regulation			3			mV
Output noise voltage (TPS77x18)		$\text{BW} = 200 \text{ Hz}$ to $100 \text{ kHz}$ , $I_C = 500 \text{ mA}$ $C_O = 10 \mu\text{F}$ , $T_J = 25^\circ\text{C}$	53			$\mu\text{V}_{\text{rms}}$
Output current limit		$V_O = 0 \text{ V}$	1.7	2.4		A
Thermal shutdown junction temperature			150			$^\circ\text{C}$
Standby current		$\overline{\text{EN}} = V_I$ , $T_J = 25^\circ\text{C}$ , $2.7 \text{ V} < V_I < 10 \text{ V}$	1			$\mu\text{A}$
		$\overline{\text{EN}} = V_I$ , $T_J = -40^\circ\text{C}$ to $125^\circ\text{C}$ $2.7 \text{ V} < V_I < 10 \text{ V}$	10			$\mu\text{A}$
FB input current	TPS77601	$\text{FB} = 1.5 \text{ V}$	2			nA
High level enable input voltage			1.7			V
Low level enable input voltage			0.9			V
Power supply ripple rejection (see Note 2)		$f = 1 \text{ KHz}$ , $C_O = 10 \mu\text{F}$ , $T_J = 25^\circ\text{C}$	60			dB

NOTES: 2. Test condition for minimum IN operating voltage is 2.7 V or  $V_O(\text{typ}) + 1 \text{ V}$ , whichever is greater. Test condition for maximum IN voltage is 10V.

3. If  $V_O \leq 1.8 \text{ V}$  then  $V_{\text{Imin}} = 2.7 \text{ V}$ ,  $V_{\text{Imax}} = 10 \text{ V}$ :

$$\text{Line Reg. (mV)} = (\%/V) \times \frac{V_O(V_{\text{Imax}} - 2.7 \text{ V})}{100} \times 1000$$

If  $V_O \geq 2.5 \text{ V}$  then  $V_{\text{Imin}} = V_O + 1 \text{ V}$ ,  $V_{\text{Imax}} = 10 \text{ V}$ :

$$\text{Line Reg. (mV)} = (\%/V) \times \frac{V_O(V_{\text{Imax}} - (V_O + 1 \text{ V}))}{100} \times 1000$$



**TPS77601-EP, TPS77615-EP, TPS77618-EP, TPS77625-EP  
TPS77628-EP, TPS77633-EP WITH PG OUTPUT  
FAST-TRANSIENT-RESPONSE 500-mA LOW-DROPOUT VOLTAGE REGULATORS**

SGLS176A – AUGUST 2003 – REVISED MARCH 2007

electrical characteristics over recommended operating free-air temperature range,  
 $V_I = V_O(\text{typ}) + 1 \text{ V}$ ,  $I_O = 1 \text{ mA}$ ,  $\overline{\text{EN}} = 0 \text{ V}$ ,  $C_O = 10 \mu\text{F}$  (unless otherwise noted) (continued)

PARAMETER		TEST CONDITIONS	MIN	TYP	MAX	UNIT
PG	Minimum input voltage for valid PG	$I_{O(\text{PG})} = 300 \mu\text{A}$		1.1		V
	Trip threshold voltage	$V_O$ decreasing	92		98	% $V_O$
	Hysteresis voltage	Measured at $V_O$		0.5		% $V_O$
	Output low voltage	$V_I = 2.7 \text{ V}$ , $I_{O(\text{PG})} = 1 \text{ mA}$		0.15	0.4	V
	Leakage current	$V(\text{PG}) = 5 \text{ V}$			1	$\mu\text{A}$
Input current ( $\overline{\text{EN}}$ )		$\overline{\text{EN}} = 0 \text{ V}$	-1	0	1	$\mu\text{A}$
		$\overline{\text{EN}} = V_I$	-1		1	
Dropout voltage (see Note 4)		TPS77628	$I_O = 500 \text{ mA}$ , $T_J = 25^\circ\text{C}$		285	mV
			$I_O = 500 \text{ mA}$ , $T_J = -40^\circ\text{C}$ to $125^\circ\text{C}$		410	
		TPS77633	$I_O = 500 \text{ mA}$ , $T_J = 25^\circ\text{C}$		169	
			$I_O = 500 \text{ mA}$ , $T_J = -40^\circ\text{C}$ to $125^\circ\text{C}$		287	

NOTE 4:  $I_N$  voltage equals  $V_O(\text{typ}) - 100 \text{ mV}$ ; TPS77615, TPS77618, and TPS77625 dropout voltage limited by input voltage range limitations (i.e., TPS77633 input voltage needs to drop to 3.2 V for purpose of this test).

**PICAL CHARACTERISTICS**

**Table of Graphs**

			FIGURE
$V_O$	Output voltage	vs Output current	2, 3, 4
		vs Free-air temperature	5, 6, 7
	Ground current	vs Free-air temperature	8
	Power supply ripple rejection	vs Frequency	9
	Output spectral noise density	vs Frequency	10
$Z_O$	Output impedance	vs Frequency	11
$V_{DO}$	Dropout voltage	vs Input voltage	12
		vs Free-air temperature	13
	Input voltage (min)	vs Output voltage	14
	Line transient response		15, 17
	Load transient response		16, 18
$V_O$	Output voltage	vs Time	19
	Equivalent series resistance (ESR)	vs Output current	21 – 24



**TPS77601-EP, TPS77615-EP, TPS77618-EP, TPS77625-EP  
 TPS77628-EP, TPS77633-EP WITH PG OUTPUT  
 FAST-TRANSIENT-RESPONSE 500-mA LOW-DROPOUT VOLTAGE REGULATORS**

SGLS176A – AUGUST 2003 – REVISED MARCH 2007

**TYPICAL CHARACTERISTICS**

**TPS77x33  
 OUTPUT VOLTAGE  
 vs  
 OUTPUT CURRENT**

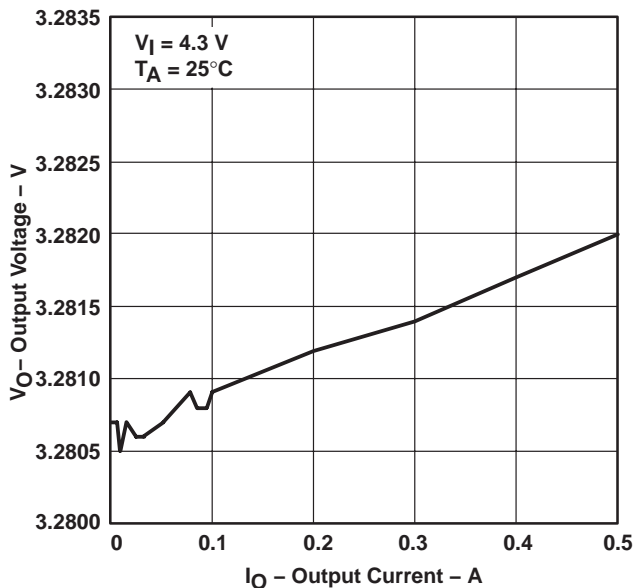

**Figure 2**

**TPS77x15  
 OUTPUT VOLTAGE  
 vs  
 OUTPUT CURRENT**

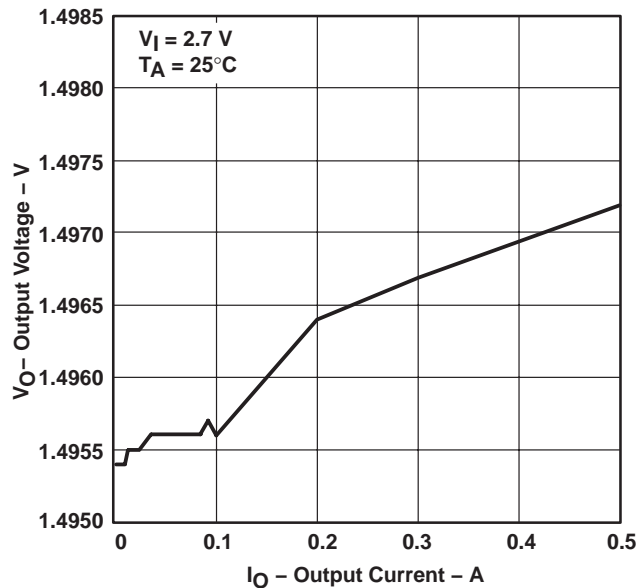

**Figure 3**

**TPS77x25  
 OUTPUT VOLTAGE  
 vs  
 OUTPUT CURRENT**

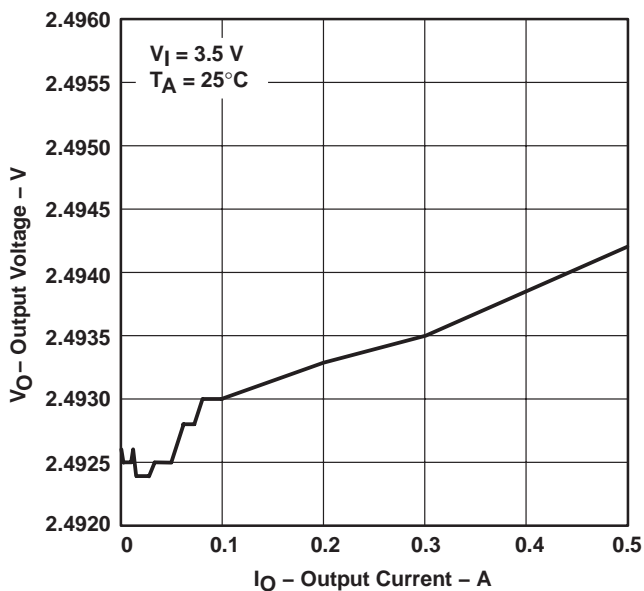

**Figure 4**

**TPS77x33  
 OUTPUT VOLTAGE  
 vs  
 FREE-AIR TEMPERATURE**

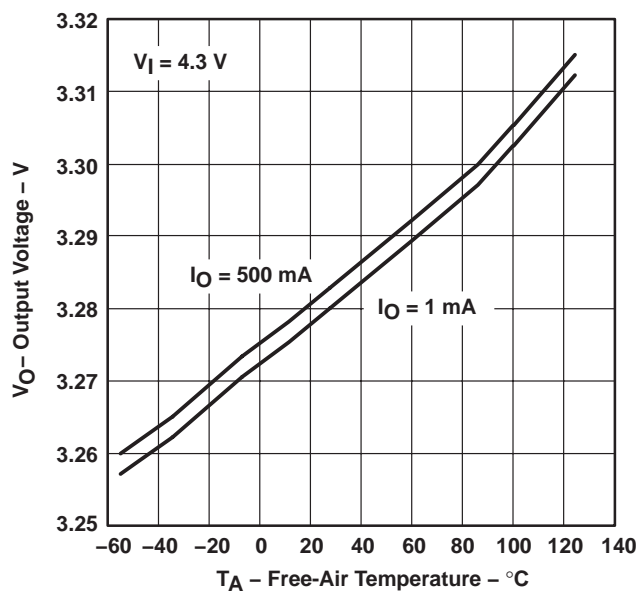

**Figure 5**





**TPS77601-EP, TPS77615-EP, TPS77618-EP, TPS77625-EP  
TPS77628-EP, TPS77633-EP WITH PG OUTPUT  
FAST-TRANSIENT-RESPONSE 500-mA LOW-DROPOUT VOLTAGE REGULATORS**

SGLS176A – AUGUST 2003 – REVISED MARCH 2007

**TYPICAL CHARACTERISTICS**

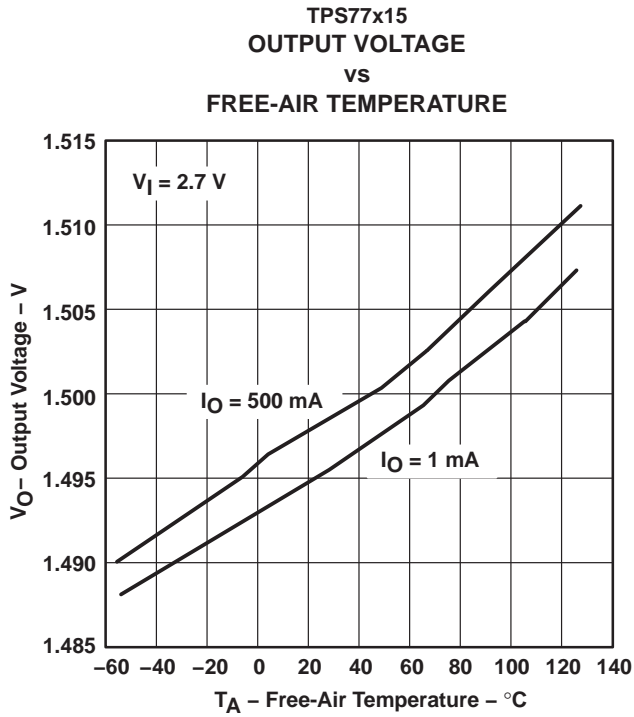

Figure 6

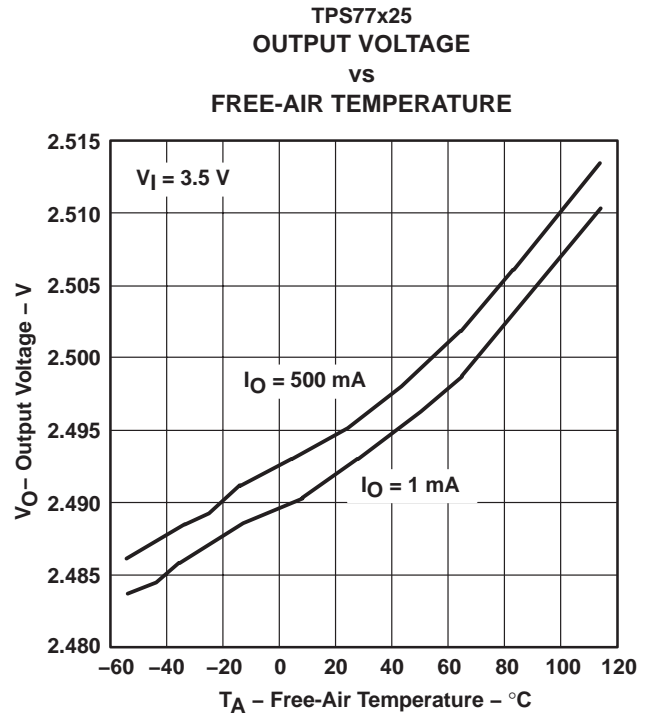

Figure 7

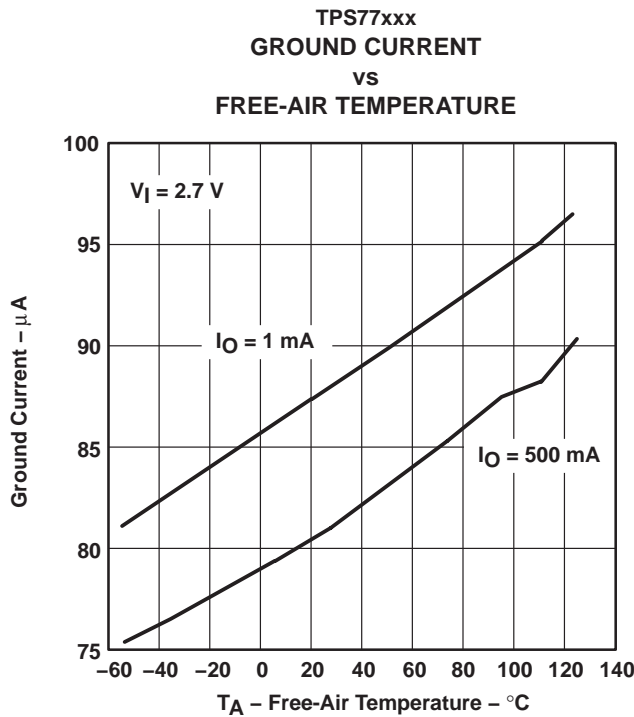

Figure 8

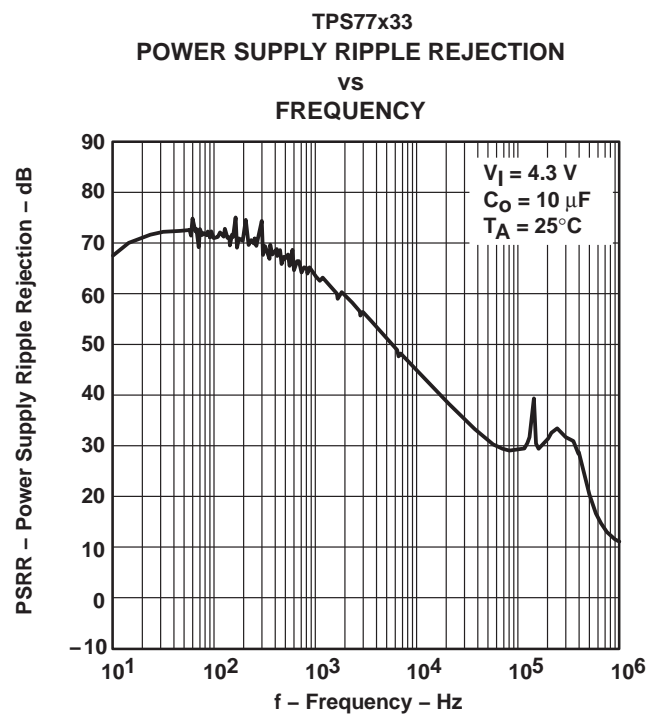

Figure 9

**TPS77601-EP, TPS77615-EP, TPS77618-EP, TPS77625-EP  
 TPS77628-EP, TPS77633-EP WITH PG OUTPUT  
 FAST-TRANSIENT-RESPONSE 500-mA LOW-DROPOUT VOLTAGE REGULATORS**

SGLS176A – AUGUST 2003 – REVISED MARCH 2007

**TYPICAL CHARACTERISTICS**

**TPS77x33  
 OUTPUT SPECTRAL NOISE DENSITY  
 VS  
 FREQUENCY**

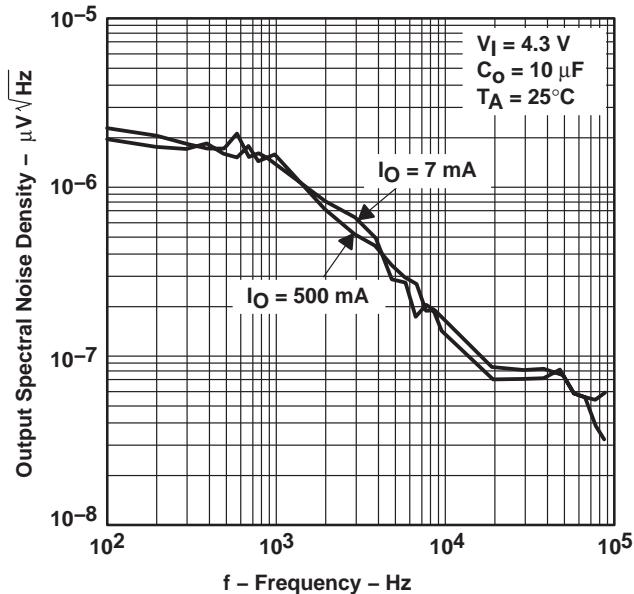

**Figure 10**

**TPS77x33  
 OUTPUT IMPEDANCE  
 VS  
 FREQUENCY**

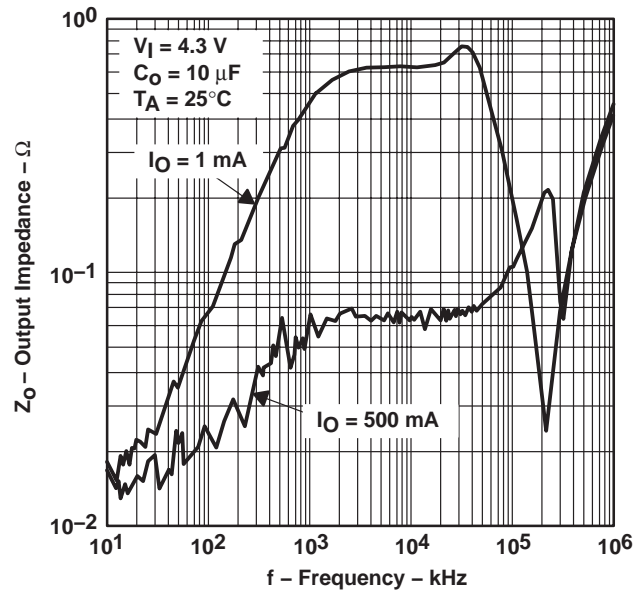

**Figure 11**

**TPS77x01  
 DROPOUT VOLTAGE  
 VS  
 INPUT VOLTAGE**

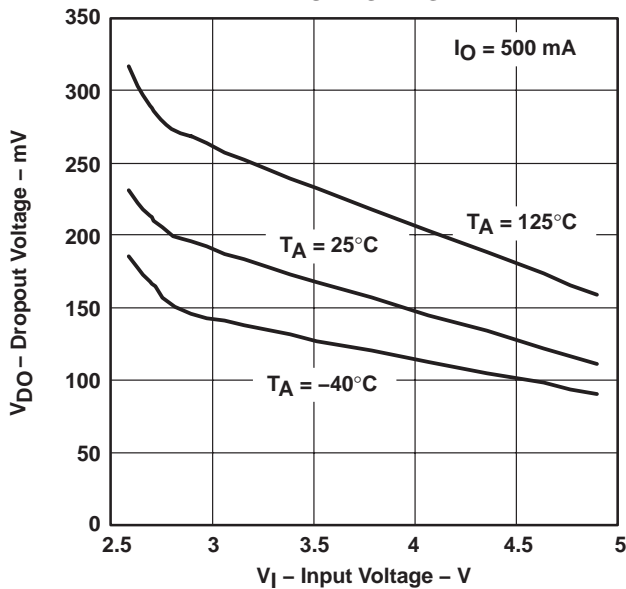

**Figure 12**

**TPS77x33  
 DROPOUT VOLTAGE  
 VS  
 FREE-AIR TEMPERATURE**

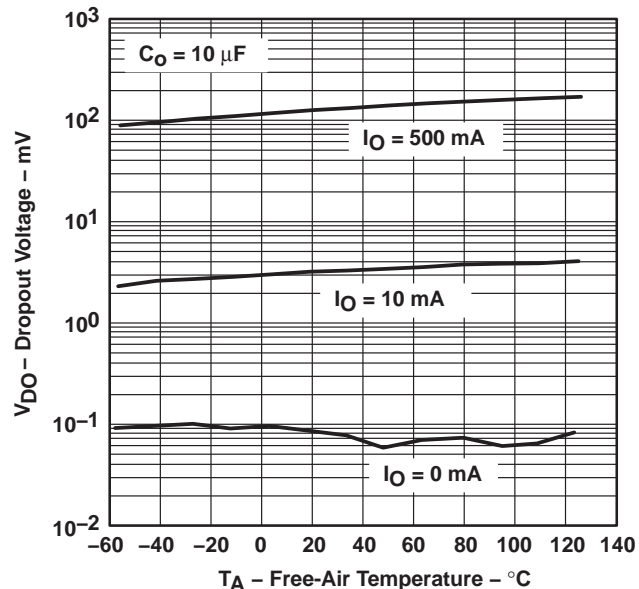

**Figure 13**

**TPS77601-EP, TPS77615-EP, TPS77618-EP, TPS77625-EP  
TPS77628-EP, TPS77633-EP WITH PG OUTPUT  
FAST-TRANSIENT-RESPONSE 500-mA LOW-DROPOUT VOLTAGE REGULATORS**

SGLS176A – AUGUST 2003 – REVISED MARCH 2007

**TYPICAL CHARACTERISTICS**

**INPUT VOLTAGE (MIN)  
vs  
OUTPUT VOLTAGE**

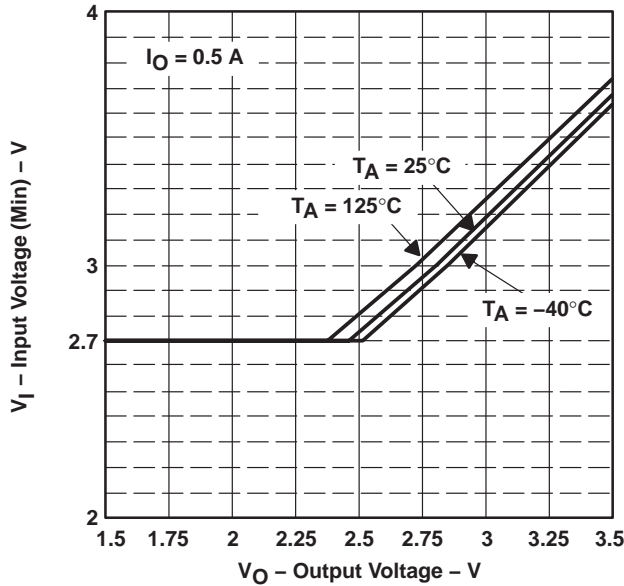

**Figure 14**

**TPS77x15  
LINE TRANSIENT RESPONSE**

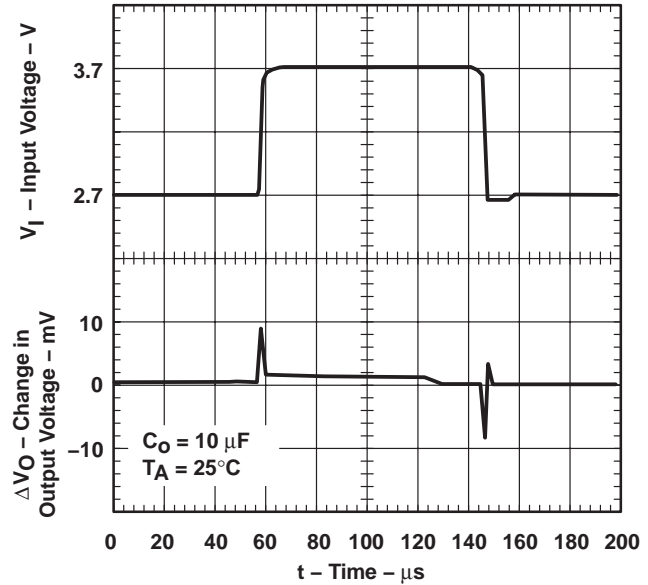

**Figure 15**

**TPS77x15  
LOAD TRANSIENT RESPONSE**

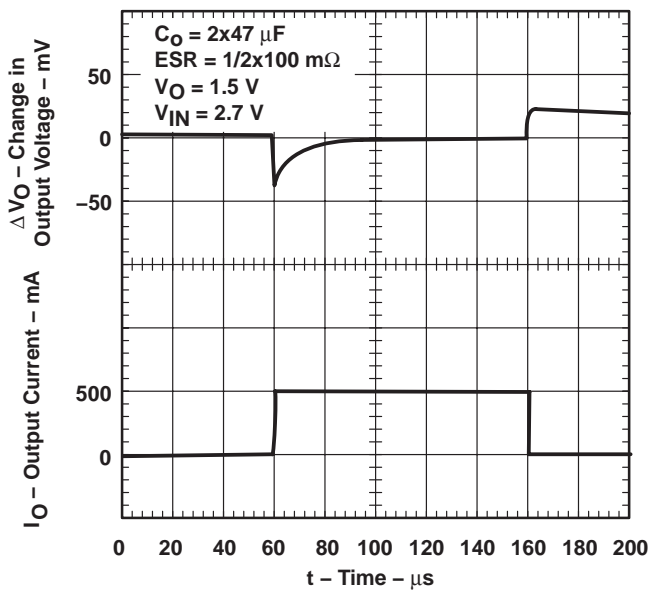

**Figure 16**

**TPS77x33  
LINE TRANSIENT RESPONSE**

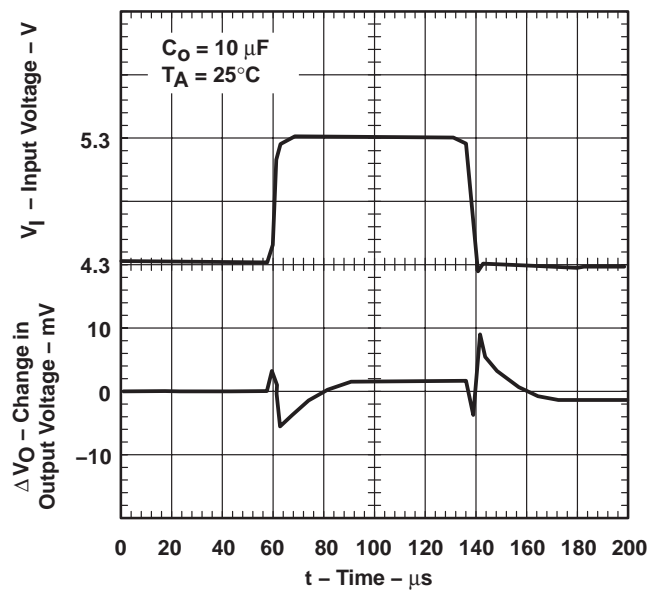

**Figure 17**

**TPS77601-EP, TPS77615-EP, TPS77618-EP, TPS77625-EP  
 TPS77628-EP, TPS77633-EP WITH PG OUTPUT  
 FAST-TRANSIENT-RESPONSE 500-mA LOW-DROPOUT VOLTAGE REGULATORS**  
 SGLS176A – AUGUST 2003 – REVISED MARCH 2007

**TYPICAL CHARACTERISTICS**

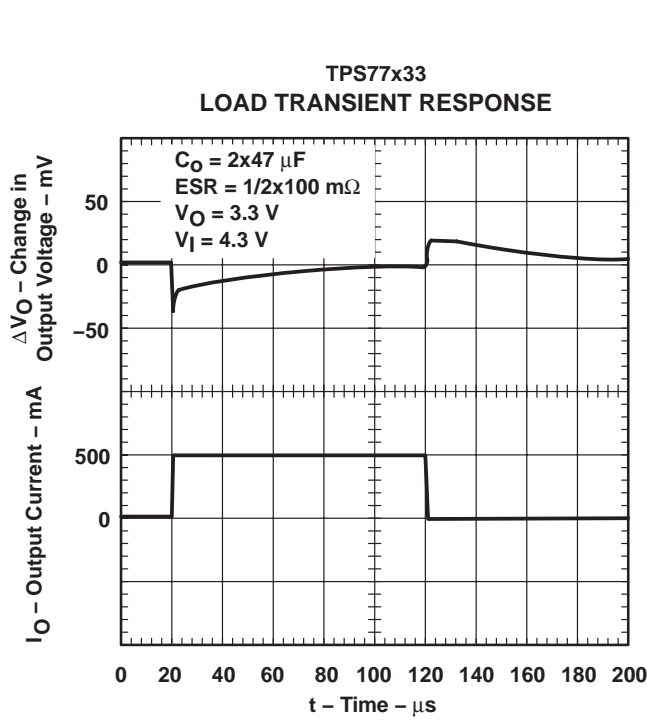

**Figure 18**

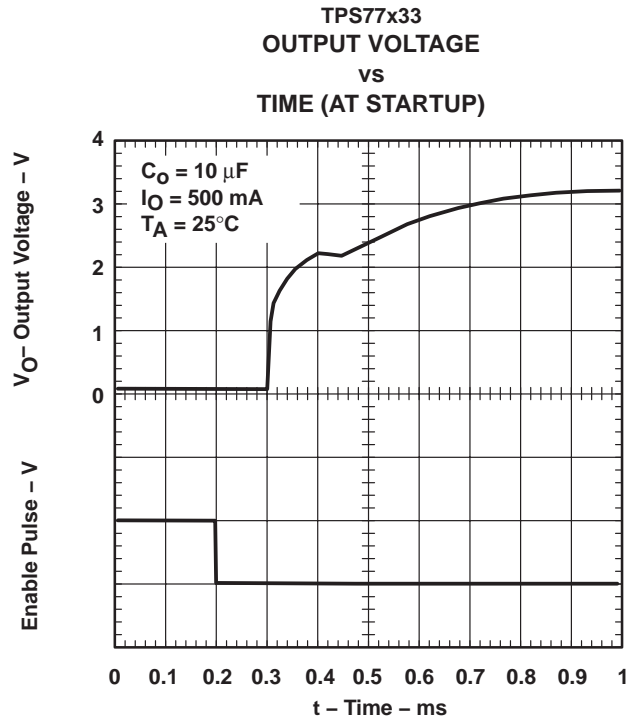

**Figure 19**

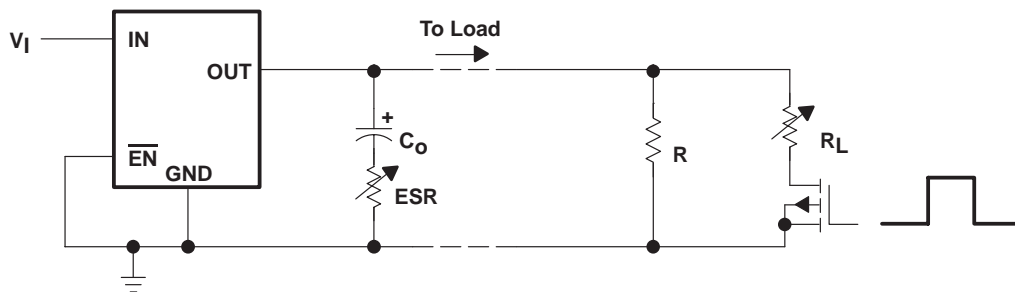

**Figure 20. Test Circuit for Typical Regions of Stability (Figures 21 through 24) (Fixed Output Options)**

**TPS77601-EP, TPS77615-EP, TPS77618-EP, TPS77625-EP  
TPS77628-EP, TPS77633-EP WITH PG OUTPUT  
FAST-TRANSIENT-RESPONSE 500-mA LOW-DROPOUT VOLTAGE REGULATORS**

SGLS176A – AUGUST 2003 – REVISED MARCH 2007

**TYPICAL CHARACTERISTICS**

**TYPICAL REGION OF STABILITY  
EQUIVALENT SERIES RESISTANCE†  
vs  
OUTPUT CURRENT**

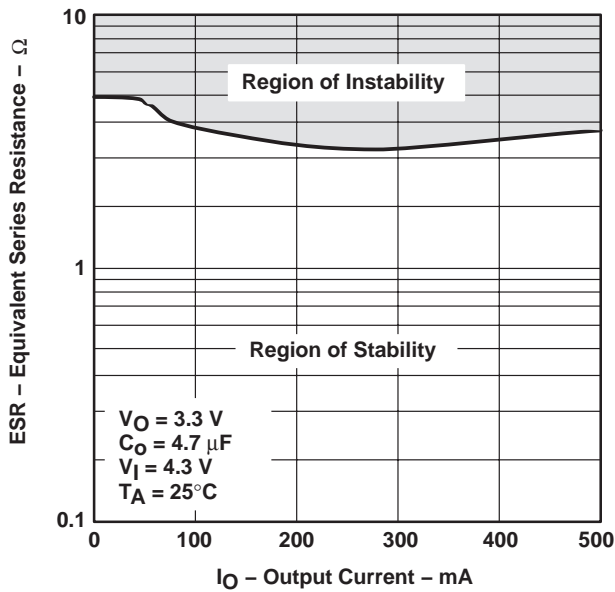

**Figure 21**

**TYPICAL REGION OF STABILITY  
EQUIVALENT SERIES RESISTANCE†  
vs  
OUTPUT CURRENT**

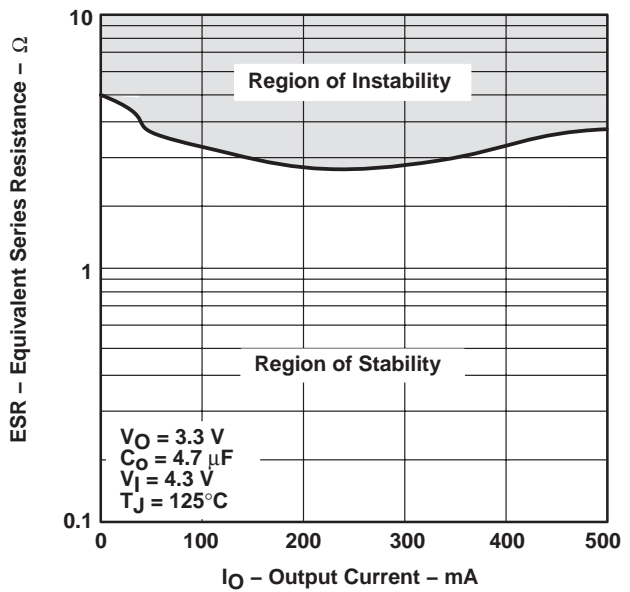

**Figure 22**

**TYPICAL REGION OF STABILITY  
EQUIVALENT SERIES RESISTANCE†  
vs  
OUTPUT CURRENT**

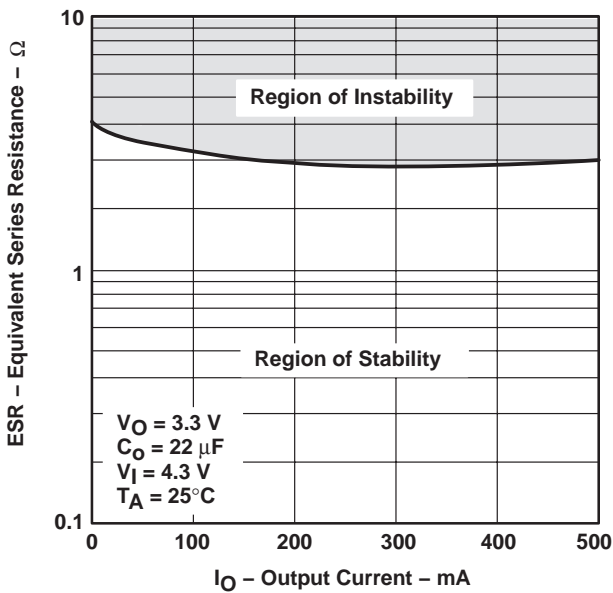

**Figure 23**

**TYPICAL REGION OF STABILITY  
EQUIVALENT SERIES RESISTANCE†  
vs  
OUTPUT CURRENT**

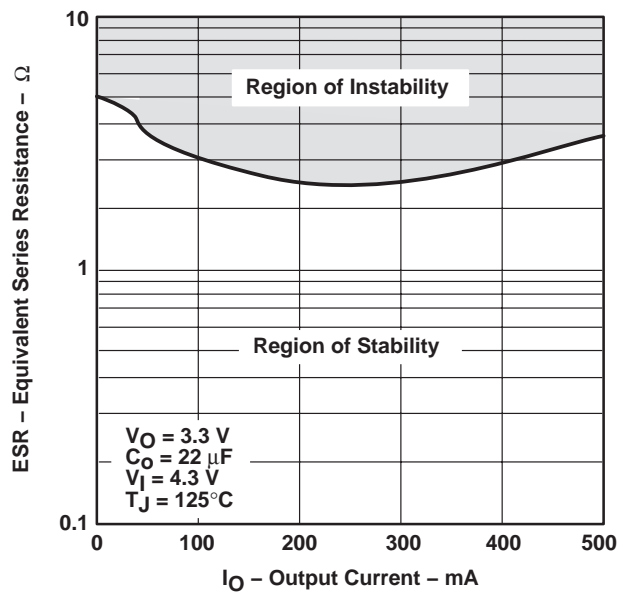

**Figure 24**

† Equivalent series resistance (ESR) refers to the total series resistance, including the ESR of the capacitor, any series resistance added externally, and PWB trace resistance to  $C_O$ .

# TPS77601-EP, TPS77615-EP, TPS77618-EP, TPS77625-EP TPS77628-EP, TPS77633-EP WITH PG OUTPUT FAST-TRANSIENT-RESPONSE 500-mA LOW-DROPOUT VOLTAGE REGULATORS

SGLS176A – AUGUST 2003 – REVISED MARCH 2007

---

## APPLICATION INFORMATION

The TPS776xx family includes five fixed-output voltage regulators (1.5 V, 1.8 V, 2.5 V, 2.8 V, and 3.3 V), and an adjustable regulator, the TPS77601 (adjustable from 1.2 V to 5.5 V).

### device operation

The TPS776xx feature very low quiescent current, which remains virtually constant even with varying loads. Conventional LDO regulators use a pnp pass element, the base current of which is directly proportional to the load current through the regulator ( $I_B = I_C/\beta$ ). The TPS776xx use a PMOS transistor to pass current; because the gate of the PMOS is voltage driven, operating current is low and invariable over the full load range.

Another pitfall associated with the pnp-pass element is its tendency to saturate when the device goes into dropout. The resulting drop in  $\beta$  forces an increase in  $I_B$  to maintain the load. During power up, this translates to large start-up currents. Systems with limited supply current may fail to start up. In battery-powered systems, it means rapid battery discharge when the voltage decays below the minimum required for regulation. The TPS776xx quiescent currents remain low even when the regulator drops out, eliminating both problems.

The TPS776xx family also features a shutdown mode that places the output in the high-impedance state (essentially equal to the feedback-divider resistance) and reduces quiescent current to 2  $\mu$ A. If the shutdown feature is not used,  $\overline{EN}$  should be tied to ground.

### minimum load requirements

The TPS776xx family is stable even at zero load; no minimum load is required for operation.

### FB—pin connection (adjustable version only)

The FB pin is an input pin to sense the output voltage and close the loop for the adjustable option. The output voltage is sensed through a resistor divider network to close the loop as it is shown in Figure 26. Normally, this connection should be as short as possible; however, the connection can be made near a critical circuit to improve performance at that point. Internally, FB connects to a high-impedance wide-bandwidth amplifier and noise pickup feeds through to the regulator output. Routing the FB connection to minimize/avoid noise pickup is essential.

### external capacitor requirements

An input capacitor is not usually required; however, a ceramic bypass capacitor (0.047  $\mu$ F or larger) improves load transient response and noise rejection if the TPS776xx is located more than a few inches from the power supply. A higher-capacitance electrolytic capacitor may be necessary if large (hundreds of milliamps) load transients with fast rise times are anticipated.

Like all low dropout regulators, the TPS776xx require an output capacitor connected between OUT and GND to stabilize the internal control loop. The minimum recommended capacitance value is 10  $\mu$ F and the ESR (equivalent series resistance) must be between 50 m $\Omega$  and 1.5  $\Omega$ . Capacitor values 10  $\mu$ F or larger are acceptable, provided the ESR is less than 1.5  $\Omega$ . Solid tantalum electrolytic, aluminum electrolytic, and multilayer ceramic capacitors are all suitable, provided they meet the requirements described previously.

**TPS77601-EP, TPS77615-EP, TPS77618-EP, TPS77625-EP  
TPS77628-EP, TPS77633-EP WITH PG OUTPUT  
FAST-TRANSIENT-RESPONSE 500-mA LOW-DROPOUT VOLTAGE REGULATORS**

SGLS176A – AUGUST 2003 – REVISED MARCH 2007

**APPLICATION INFORMATION**

**external capacitor requirements (continued)**

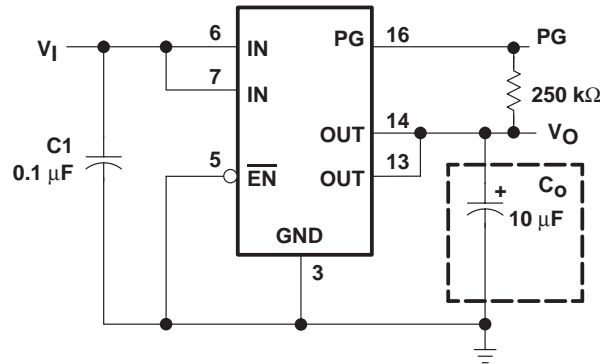

**Figure 25. Typical Application Circuit (Fixed Versions)**

**programming the TPS77601 adjustable LDO regulator**

The output voltage of the TPS77601 adjustable regulator is programmed using an external resistor divider as shown in Figure 26. The output voltage is calculated using:

$$V_O = V_{ref} \times \left(1 + \frac{R1}{R2}\right) \quad (1)$$

Where:

$$V_{ref} = 1.1834 \text{ V typ (the internal reference voltage)}$$

Resistors R1 and R2 should be chosen for approximately 10-μA divider current. Lower value resistors can be used but offer no inherent advantage and waste more power. Higher values should be avoided as leakage currents at FB increase the output voltage error. The recommended design procedure is to choose R2 = 110 kΩ to set the divider current at approximately 10 μA and then calculate R1 using:

$$R1 = \left(\frac{V_O}{V_{ref}} - 1\right) \times R2 \quad (2)$$

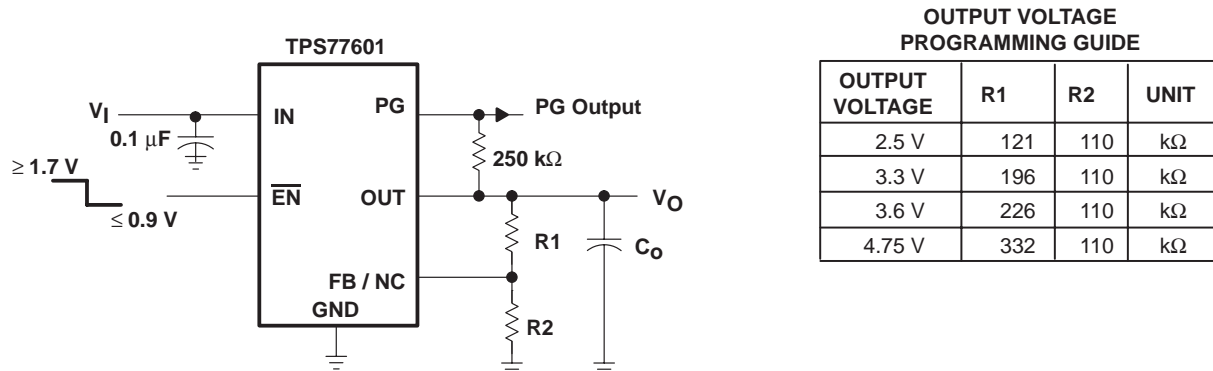

**Figure 26. TPS77601 Adjustable LDO Regulator Programming**

# TPS77601-EP, TPS77615-EP, TPS77618-EP, TPS77625-EP TPS77628-EP, TPS77633-EP WITH PG OUTPUT FAST-TRANSIENT-RESPONSE 500-mA LOW-DROPOUT VOLTAGE REGULATORS

SGLS176A – AUGUST 2003 – REVISED MARCH 2007

## APPLICATION INFORMATION

### power-good indicator

The TPS776xx features a power-good (PG) output that can be used to monitor the status of the regulator. The internal comparator monitors the output voltage: when the output drops to between 92% and 98% of its nominal regulated value, the PG output transistor turns on, taking the signal low. The open-drain output requires a pullup resistor. If not used, it can be left floating. PG can be used to drive power-on reset circuitry or used as a low-battery indicator.

### regulator protection

The TPS776xx PMOS-pass transistors have a built-in back diode that conducts reverse currents when the input voltage drops below the output voltage (e.g., during power down). Current is conducted from the output to the input and is not internally limited. When extended reverse voltage is anticipated, external limiting may be appropriate.

The TPS776xx also feature internal current limiting and thermal protection. During normal operation, the TPS776xx limit output current to approximately 1.7 A. When current limiting engages, the output voltage scales back linearly until the overcurrent condition ends. While current limiting is designed to prevent gross device failure, care should be taken not to exceed the power dissipation ratings of the package. If the temperature of the device exceeds 150°C(typ), thermal-protection circuitry shuts it down. Once the device has cooled below 130°C(typ), regulator operation resumes.

### power dissipation and junction temperature

Specified regulator operation is assured to a junction temperature of 125°C; the maximum junction temperature should be restricted to 125°C under normal operating conditions. This restriction limits the power dissipation the regulator can handle in any given application. To ensure the junction temperature is within acceptable limits, calculate the maximum allowable dissipation,  $P_{D(max)}$ , and the actual dissipation,  $P_D$ , which must be less than or equal to  $P_{D(max)}$ .

The maximum-power-dissipation limit is determined using the following equation:

$$P_{D(max)} = \frac{T_{Jmax} - T_A}{R_{\theta JA}}$$

Where:

$T_{Jmax}$  is the maximum allowable junction temperature.

$R_{\theta JA}$  is the thermal resistance junction-to-ambient for the package, i.e., 32.6°C/W for the 20-terminal PWP with no airflow.

$T_A$  is the ambient temperature.

The regulator dissipation is calculated using:

$$P_D = (V_I - V_O) \times I_O$$

Power dissipation resulting from quiescent current is negligible. Excessive power dissipation will trigger the thermal protection circuit.



**PACKAGING INFORMATION**

Orderable Device	Status (1)	Package Type	Package Drawing	Pins	Package Qty	Eco Plan (2)	Lead/Ball Finish (6)	MSL Peak Temp (3)	Op Temp (°C)	Device Marking (4/5)	Samples
TPS77601QPWPREP	ACTIVE	HTSSOP	PWP	20	2000	Green (RoHS & no Sb/Br)	CU NIPDAU	Level-2-260C-1 YEAR	-40 to 125	77601QE	<a href="#">Samples</a>
TPS77615QPWPREP	ACTIVE	HTSSOP	PWP	20	2000	Green (RoHS & no Sb/Br)	CU NIPDAU	Level-2-260C-1 YEAR	-40 to 125	77615QE	<a href="#">Samples</a>
TPS77618QPWPREP	ACTIVE	HTSSOP	PWP	20	2000	Green (RoHS & no Sb/Br)	CU NIPDAU	Level-2-260C-1 YEAR	-40 to 125	77618QE	<a href="#">Samples</a>
TPS77625QPWPREP	ACTIVE	HTSSOP	PWP	20	2000	Green (RoHS & no Sb/Br)	CU NIPDAU	Level-2-260C-1 YEAR	-40 to 125	77625QE	<a href="#">Samples</a>
TPS77633QPWPREP	ACTIVE	HTSSOP	PWP	20	2000	Green (RoHS & no Sb/Br)	CU NIPDAU	Level-2-260C-1 YEAR	-40 to 125	77633QE	<a href="#">Samples</a>
V62/03631-07XE	ACTIVE	HTSSOP	PWP	20	2000	Green (RoHS & no Sb/Br)	CU NIPDAU	Level-2-260C-1 YEAR	-40 to 125	77601QE	<a href="#">Samples</a>
V62/03631-08XE	ACTIVE	HTSSOP	PWP	20	2000	Green (RoHS & no Sb/Br)	CU NIPDAU	Level-2-260C-1 YEAR	-40 to 125	77615QE	<a href="#">Samples</a>
V62/03631-09XE	ACTIVE	HTSSOP	PWP	20	2000	Green (RoHS & no Sb/Br)	CU NIPDAU	Level-2-260C-1 YEAR	-40 to 125	77618QE	<a href="#">Samples</a>
V62/03631-10XE	ACTIVE	HTSSOP	PWP	20	2000	Green (RoHS & no Sb/Br)	CU NIPDAU	Level-2-260C-1 YEAR	-40 to 125	77625QE	<a href="#">Samples</a>
V62/03631-12XE	ACTIVE	HTSSOP	PWP	20	2000	Green (RoHS & no Sb/Br)	CU NIPDAU	Level-2-260C-1 YEAR	-40 to 125	77633QE	<a href="#">Samples</a>

(1) The marketing status values are defined as follows:

**ACTIVE:** Product device recommended for new designs.

**LIFEBUY:** TI has announced that the device will be discontinued, and a lifetime-buy period is in effect.

**NRND:** Not recommended for new designs. Device is in production to support existing customers, but TI does not recommend using this part in a new design.

**PREVIEW:** Device has been announced but is not in production. Samples may or may not be available.

**OBSOLETE:** TI has discontinued the production of the device.

(2) Eco Plan - The planned eco-friendly classification: Pb-Free (RoHS), Pb-Free (RoHS Exempt), or Green (RoHS & no Sb/Br) - please check <http://www.ti.com/productcontent> for the latest availability information and additional product content details.

**TBD:** The Pb-Free/Green conversion plan has not been defined.

**Pb-Free (RoHS):** TI's terms "Lead-Free" or "Pb-Free" mean semiconductor products that are compatible with the current RoHS requirements for all 6 substances, including the requirement that lead not exceed 0.1% by weight in homogeneous materials. Where designed to be soldered at high temperatures, TI Pb-Free products are suitable for use in specified lead-free processes.

**Pb-Free (RoHS Exempt):** This component has a RoHS exemption for either 1) lead-based flip-chip solder bumps used between the die and package, or 2) lead-based die adhesive used between the die and leadframe. The component is otherwise considered Pb-Free (RoHS compatible) as defined above.

**Green (RoHS & no Sb/Br):** TI defines "Green" to mean Pb-Free (RoHS compatible), and free of Bromine (Br) and Antimony (Sb) based flame retardants (Br or Sb do not exceed 0.1% by weight in homogeneous material)

- (3) MSL, Peak Temp. - The Moisture Sensitivity Level rating according to the JEDEC industry standard classifications, and peak solder temperature.
- (4) There may be additional marking, which relates to the logo, the lot trace code information, or the environmental category on the device.
- (5) Multiple Device Markings will be inside parentheses. Only one Device Marking contained in parentheses and separated by a "~" will appear on a device. If a line is indented then it is a continuation of the previous line and the two combined represent the entire Device Marking for that device.
- (6) Lead/Ball Finish - Orderable Devices may have multiple material finish options. Finish options are separated by a vertical ruled line. Lead/Ball Finish values may wrap to two lines if the finish value exceeds the maximum column width.

**Important Information and Disclaimer:**The information provided on this page represents TI's knowledge and belief as of the date that it is provided. TI bases its knowledge and belief on information provided by third parties, and makes no representation or warranty as to the accuracy of such information. Efforts are underway to better integrate information from third parties. TI has taken and continues to take reasonable steps to provide representative and accurate information but may not have conducted destructive testing or chemical analysis on incoming materials and chemicals. TI and TI suppliers consider certain information to be proprietary, and thus CAS numbers and other limited information may not be available for release.

In no event shall TI's liability arising out of such information exceed the total purchase price of the TI part(s) at issue in this document sold by TI to Customer on an annual basis.

**OTHER QUALIFIED VERSIONS OF TPS77601-EP, TPS77615-EP, TPS77618-EP, TPS77625-EP, TPS77633-EP :**

- Catalog: [TPS77601](#), [TPS77615](#), [TPS77618](#), [TPS77625](#), [TPS77633](#)
- Automotive: [TPS77601-Q1](#), [TPS77615-Q1](#), [TPS77618-Q1](#), [TPS77625-Q1](#), [TPS77633-Q1](#)

NOTE: Qualified Version Definitions:

- Catalog - TI's standard catalog product
- Automotive - Q100 devices qualified for high-reliability automotive applications targeting zero defects

**TAPE AND REEL INFORMATION**

**QUADRANT ASSIGNMENTS FOR PIN 1 ORIENTATION IN TAPE**

\*All dimensions are nominal

Device	Package Type	Package Drawing	Pins	SPQ	Reel Diameter (mm)	Reel Width W1 (mm)	A0 (mm)	B0 (mm)	K0 (mm)	P1 (mm)	W (mm)	Pin1 Quadrant
TPS77601QPWPREP	HTSSOP	PWP	20	2000	330.0	16.4	6.95	7.1	1.6	8.0	16.0	Q1
TPS77615QPWPREP	HTSSOP	PWP	20	2000	330.0	16.4	6.95	7.1	1.6	8.0	16.0	Q1
TPS77618QPWPREP	HTSSOP	PWP	20	2000	330.0	16.4	6.95	7.1	1.6	8.0	16.0	Q1
TPS77625QPWPREP	HTSSOP	PWP	20	2000	330.0	16.4	6.95	7.1	1.6	8.0	16.0	Q1
TPS77633QPWPREP	HTSSOP	PWP	20	2000	330.0	16.4	6.95	7.1	1.6	8.0	16.0	Q1

**TAPE AND REEL BOX DIMENSIONS**

\*All dimensions are nominal

Device	Package Type	Package Drawing	Pins	SPQ	Length (mm)	Width (mm)	Height (mm)
TPS77601QPWPREP	HTSSOP	PWP	20	2000	350.0	350.0	43.0
TPS77615QPWPREP	HTSSOP	PWP	20	2000	350.0	350.0	43.0
TPS77618QPWPREP	HTSSOP	PWP	20	2000	350.0	350.0	43.0
TPS77625QPWPREP	HTSSOP	PWP	20	2000	350.0	350.0	43.0
TPS77633QPWPREP	HTSSOP	PWP	20	2000	350.0	350.0	43.0

# MECHANICAL DATA

PWP (R-PDSO-G20)

PowerPAD™ PLASTIC SMALL OUTLINE



4073225-4/1 05/11

- NOTES:
- All linear dimensions are in millimeters.
  - This drawing is subject to change without notice.
  - Body dimensions do not include mold flash or protrusions. Mold flash and protrusion shall not exceed 0.15 per side.
  - This package is designed to be soldered to a thermal pad on the board. Refer to Technical Brief, PowerPad Thermally Enhanced Package, Texas Instruments Literature No. SLMA002 for information regarding recommended board layout. This document is available at [www.ti.com](http://www.ti.com) <<http://www.ti.com>>.
  - See the additional figure in the Product Data Sheet for details regarding the exposed thermal pad features and dimensions.
  - Falls within JEDEC MO-153

PowerPAD is a trademark of Texas Instruments.

## THERMAL PAD MECHANICAL DATA

### PWP (R-PDSO-G20) PowerPAD™ SMALL PLASTIC OUTLINE

#### THERMAL INFORMATION

This PowerPAD™ package incorporates an exposed thermal pad that is designed to be attached to a printed circuit board (PCB). The thermal pad must be soldered directly to the PCB. After soldering, the PCB can be used as a heatsink. In addition, through the use of thermal vias, the thermal pad can be attached directly to the appropriate copper plane shown in the electrical schematic for the device, or alternatively, can be attached to a special heatsink structure designed into the PCB. This design optimizes the heat transfer from the integrated circuit (IC).

For additional information on the PowerPAD package and how to take advantage of its heat dissipating abilities, refer to Technical Brief, PowerPAD Thermally Enhanced Package, Texas Instruments Literature No. SLMA002 and Application Brief, PowerPAD Made Easy, Texas Instruments Literature No. SLMA004. Both documents are available at [www.ti.com](http://www.ti.com).

The exposed thermal pad dimensions for this package are shown in the following illustration.

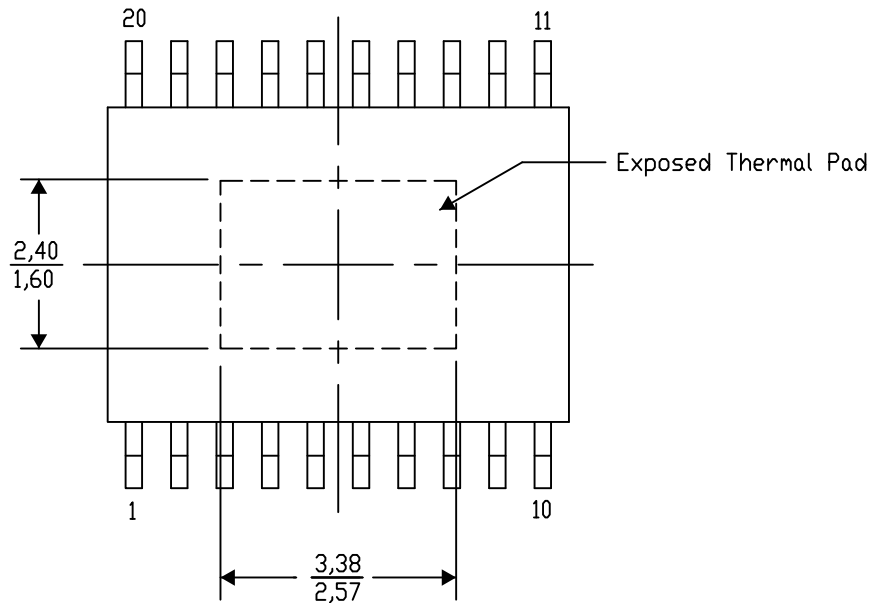

Top View

Exposed Thermal Pad Dimensions

4206332-13/AO 01/16

NOTE: A. All linear dimensions are in millimeters

PowerPAD is a trademark of Texas Instruments

PWP (R-PDSO-G20)

PowerPAD™ PLASTIC SMALL OUTLINE

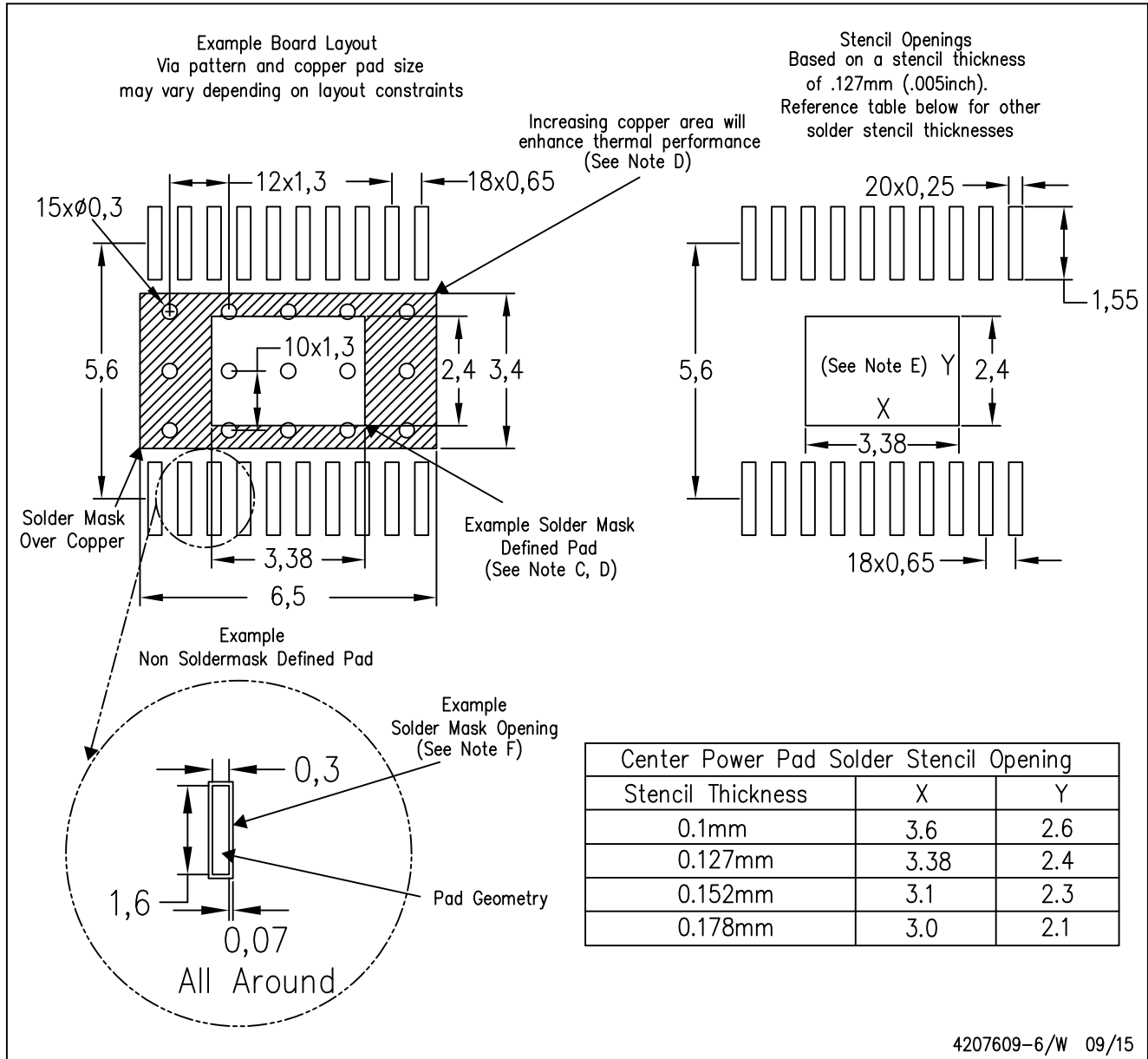

- NOTES:
- A. All linear dimensions are in millimeters.
  - B. This drawing is subject to change without notice.
  - C. Customers should place a note on the circuit board fabrication drawing not to alter the center solder mask defined pad.
  - D. This package is designed to be soldered to a thermal pad on the board. Refer to Technical Brief, PowerPad Thermally Enhanced Package, Texas Instruments Literature No. SLMA002, SLMA004, and also the Product Data Sheets for specific thermal information, via requirements, and recommended board layout. These documents are available at [www.ti.com](http://www.ti.com) <<http://www.ti.com>>. Publication IPC-7351 is recommended for alternate designs.
  - E. Laser cutting apertures with trapezoidal walls and also rounding corners will offer better paste release. Customers should contact their board assembly site for stencil design recommendations. Example stencil design based on a 50% volumetric metal load solder paste. Refer to IPC-7525 for other stencil recommendations.
  - F. Customers should contact their board fabrication site for solder mask tolerances between and around signal pads.

## THERMAL PAD MECHANICAL DATA

### PWP (R-PDSO-G20) PowerPAD™ SMALL PLASTIC OUTLINE

#### THERMAL INFORMATION

This PowerPAD™ package incorporates an exposed thermal pad that is designed to be attached to a printed circuit board (PCB). The thermal pad must be soldered directly to the PCB. After soldering, the PCB can be used as a heatsink. In addition, through the use of thermal vias, the thermal pad can be attached directly to the appropriate copper plane shown in the electrical schematic for the device, or alternatively, can be attached to a special heatsink structure designed into the PCB. This design optimizes the heat transfer from the integrated circuit (IC).

For additional information on the PowerPAD package and how to take advantage of its heat dissipating abilities, refer to Technical Brief, PowerPAD Thermally Enhanced Package, Texas Instruments Literature No. SLMA002 and Application Brief, PowerPAD Made Easy, Texas Instruments Literature No. SLMA004. Both documents are available at [www.ti.com](http://www.ti.com).

The exposed thermal pad dimensions for this package are shown in the following illustration.

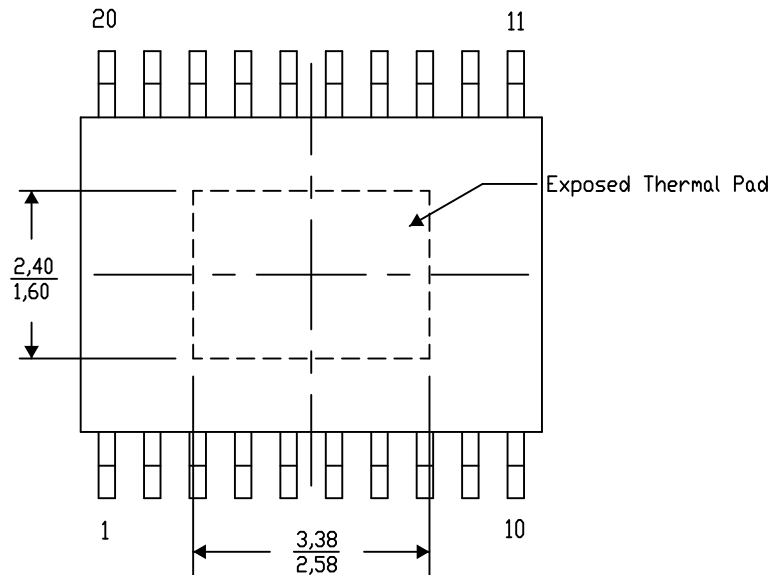

Top View

Exposed Thermal Pad Dimensions

4206332-21/AO 01/16

NOTE: A. All linear dimensions are in millimeters

PowerPAD is a trademark of Texas Instruments



## IMPORTANT NOTICE AND DISCLAIMER

TI PROVIDES TECHNICAL AND RELIABILITY DATA (INCLUDING DATASHEETS), DESIGN RESOURCES (INCLUDING REFERENCE DESIGNS), APPLICATION OR OTHER DESIGN ADVICE, WEB TOOLS, SAFETY INFORMATION, AND OTHER RESOURCES "AS IS" AND WITH ALL FAULTS, AND DISCLAIMS ALL WARRANTIES, EXPRESS AND IMPLIED, INCLUDING WITHOUT LIMITATION ANY IMPLIED WARRANTIES OF MERCHANTABILITY, FITNESS FOR A PARTICULAR PURPOSE OR NON-INFRINGEMENT OF THIRD PARTY INTELLECTUAL PROPERTY RIGHTS.

These resources are intended for skilled developers designing with TI products. You are solely responsible for (1) selecting the appropriate TI products for your application, (2) designing, validating and testing your application, and (3) ensuring your application meets applicable standards, and any other safety, security, or other requirements. These resources are subject to change without notice. TI grants you permission to use these resources only for development of an application that uses the TI products described in the resource. Other reproduction and display of these resources is prohibited. No license is granted to any other TI intellectual property right or to any third party intellectual property right. TI disclaims responsibility for, and you will fully indemnify TI and its representatives against, any claims, damages, costs, losses, and liabilities arising out of your use of these resources.

TI's products are provided subject to TI's Terms of Sale ([www.ti.com/legal/termsofsale.html](http://www.ti.com/legal/termsofsale.html)) or other applicable terms available either on [ti.com](http://ti.com) or provided in conjunction with such TI products. TI's provision of these resources does not expand or otherwise alter TI's applicable warranties or warranty disclaimers for TI products.

Mailing Address: Texas Instruments, Post Office Box 655303, Dallas, Texas 75265  
Copyright © 2019, Texas Instruments Incorporated