

## LM137QML 3-Terminal Adjustable Negative Regulators

### 1 Features

- SMD 5962-99517
- Available TID Qualified to 30 krad(Si)
- Output Voltage Adjustable from  $-37\text{ V}$  to  $-1.2\text{ V}$
- 1.5A Output Current Specified,  $-55^{\circ}\text{C}$  to  $+150^{\circ}\text{C}$
- Line Regulation Typically 0.01%/V
- Load Regulation Typically 0.3%
- Excellent Thermal Regulation, 0.002%/W
- 77 dB Ripple Rejection
- Excellent Rejection of Thermal Transients
- 50 ppm/ $^{\circ}\text{C}$  Temperature Coefficient
- Temperature-independent Current Limit
- Internal Thermal Overload Protection
- Standard 3-lead Transistor Package
- Output is Short Circuit Protected

### 2 Applications

- Multipurpose Power Supply
- On-card Voltage Regulation
- Programmable Voltage Supply
- Precision Current Supply
- Harsh Environments

### 3 Description

The LM137 are adjustable 3-terminal negative voltage regulators capable of supplying in excess of 1.5 A over an output voltage range of  $-37\text{ V}$  to  $-1.2\text{ V}$ . These regulators are exceptionally easy to apply, requiring only 2 external resistors to set the output voltage and 1 output capacitor for frequency compensation. The circuit design has been optimized for excellent regulation and low thermal transients. Further, the LM137 series features internal current limiting, thermal shutdown and safe-area compensation, making them virtually blowout-proof against overloads.

The LM137 serve a wide variety of applications including local on-card regulation, programmable-output voltage regulation or precision current regulation. The LM137 are ideal complements to the LM117 adjustable positive regulators.

#### Device Information<sup>(1)</sup>

PART NUMBER	SMD NUMBER	PACKAGE
LM137K/883		TO-3 (K)
LM137H/883		TO-39 (NDT)
LM137H1PQMLV	5962P9951708VXA 30 krad	TO-39 (NDT)
LM137H-MD8		Die
LM137KG-MD8		Die
LM137KG-MW8		Wafer

(1) For all available packages, see the orderable addendum at the end of the data sheet.

#### Simplified Schematic

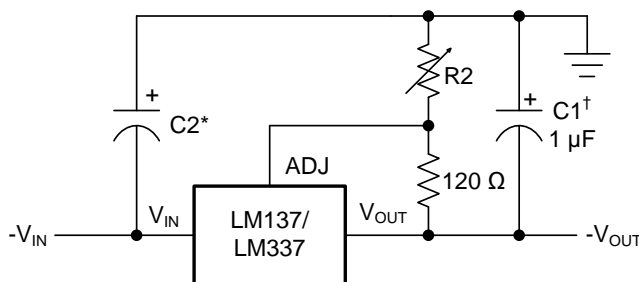



## 5 Pin Configuration and Functions

**TO-3 Metal Can Package  
Package K  
(Bottom View)**

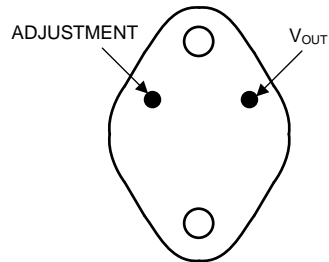

NOTE: Case is Input

**T0-39 Metal Can Package  
Package NDT  
(Bottom View)**

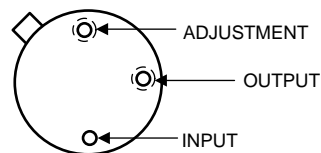

NOTE: Case Is Input

### Pin Functions

NAME	PIN		I/O	DESCRIPTION
	NUMBER			
	K	NDT		
ADJUSTMENT	1	1	O	Adjustment
INPUT	Case	3/Case	I	Input
OUTPUT /V <sub>OUT</sub>	2	2	O	Output

## 6 Specifications

### 6.1 Absolute Maximum Ratings<sup>(1)</sup>

			UNIT
Power Dissipation <sup>(2)</sup>		Internally Limited	
Input-Output Voltage Differential		40	V
Operating Ambient Temperature		$-55 \leq T_A \leq +125$	°C
Operating Junction Temperature		$-55 \leq T_J \leq +150$	°C
Storage Temperature		$-65 \leq T_A \leq +150$	°C
Maximum Junction Temperature		150	°C
Lead Temperature (Soldering, 10 sec.)		300	°C
Maximum Power Dissipation (@25°C)	T0–3	28	W
	T0–39	2.5	W
Package Weight (typical)	T0–3	12,750	mg
	T0–39 Metal Can	955	mg

- (1) Absolute Maximum Ratings indicate limits beyond which damage to the device may occur. These are stress ratings only, which do not imply functional operation of the device at these or any other conditions beyond those indicated under *Recommended Operating Conditions*. For ensured specifications and test conditions, see the Electrical Characteristics. The ensured specifications apply only for the test conditions listed. Some performance characteristics may degrade when the device is not operated under the listed test conditions.
- (2) The maximum power dissipation must be derated at elevated temperatures and is dictated by  $T_{Jmax}$  (maximum junction temperature),  $R_{\theta JA}$  (package junction to ambient thermal resistance), and  $T_A$  (ambient temperature). The maximum allowable power dissipation at any temperature is  $P_{Dmax} = (T_{Jmax} - T_A)/R_{\theta JA}$  or the number given in the Absolute Maximum Ratings, whichever is lower.

### 6.2 ESD Ratings

		VALUE	UNIT
$V_{(ESD)}$	Electrostatic discharge	Human-body model (HBM), per ANSI/ESDA/JEDEC JS-001 <sup>(1)</sup>	±4000 V

- (1) JEDEC document JEP155 states that 500-V HBM allows safe manufacturing with a standard ESD control process. Manufacturing with less than 500-V HBM is possible with the necessary precautions. Pins listed as ±4000 V may actually have higher performance. Human body model, 100 pF discharged through 1.5 KΩ.

### 6.3 Recommended Operating Conditions

	MIN	MAX	UNIT
$T_A$		$-55 \leq T_A \leq +125$	°C
Input Voltage	-41.25	-4.25	V

### 6.4 Thermal Information

THERMAL METRIC <sup>(1)</sup>	TO-3 METAL CAN	TO-39 METAL CAN	UNIT
	2 PINS	3 PINS	
$R_{\theta JA}$ Junction-to-ambient thermal resistance	40 (Still Air)	174 (Still Air @ 0.5W)	°C/W
	14 (500 LFM)	64 (500 LFM @ 0.5W)	
$R_{\theta JC}$ Junction-to-case thermal resistance	4	15 (@ 1.0W)	

- (1) For more information about traditional and new thermal metrics, see the *IC Package Thermal Metrics* application report, [SPRA953](http://www.ti.com/lit/zip/Spra953).

## 6.5 Quality Conformance Inspection

**Table 1. Mil-Std-883, Method 5005 — Group A<sup>(1)</sup>**

SUBGROUP	DESCRIPTION	TEMP (°C)
1	Static tests at	+25
2	Static tests at	+125
3	Static tests at	-55
4	Dynamic tests at	+25
5	Dynamic tests at	+125
6	Dynamic tests at	-55
7	Functional tests at	+25
8A	Functional tests at	+125
8B	Functional tests at	-55
9	Switching tests at	+25
10	Switching tests at	+125
11	Switching tests at	-55

(1) Group "A" sample only, test at all temps.

## 6.6 LM137H 883 Electrical Characteristics DC Parameters

The following conditions apply, unless otherwise specified.  $V_{IN} = -4.25V$ ,  $I_L = 8mA$ ,  $V_{OUT} = V_{Ref}^{(1)(2)}$

PARAMETER	TEST CONDITIONS	SUB-GROUPS	MIN	MAX	UNIT	
$V_{Ref}$	Reference Voltage	1	-1.275	-1.225	V	
		2, 3	-1.3	-1.2	V	
		$V_{IN} = -42 V$	1	-1.275	-1.225	V
		$V_{IN} = -41.3 V$	2, 3	-1.3	-1.2	V
$I_Q$	Minimum Load Current	$V_{OUT} = -1.7 V$	1, 2, 3		3.0	mA
		$V_{OUT} = -1.7 V$ , $V_{IN} = -11.75 V$	1, 2, 3		3.0	mA
		$V_{OUT} = -1.7 V$ , $V_{IN} = -42 V$	1		5.0	mA
		$V_{OUT} = -1.7 V$ , $V_{IN} = -41.3 V$	2, 3		5.0	mA
$R_{Line}$	Line Regulation	$-42 V \leq V_{IN} \leq -4.25 V$	1	-9.0	9.0	mV
		$-41.3 V \leq V_{IN} \leq -4.25 V$	2, 3	-23	23	mV
$R_{Load}$	Load Regulation	$5 mA \leq I_L \leq 500 mA$ , $V_{IN} = -6.25 V$	1, 2, 3	-25	25	mV
		$5mA \leq I_L \leq 500 mA$ , $V_{IN} = -14.5 V$	1	-25	25	mV
		$5mA \leq I_L \leq 150 mA$ , $V_{IN} = -40 V$	1, 2, 3	-25	25	mV
$I_{Adj}$	Adjustment Pin Current	$I_L = 5 mA$	1, 2, 3		100	$\mu A$
		$V_{IN} = -42 V$	1		100	$\mu A$
		$V_{IN} = -41.3 V$	2, 3		100	$\mu A$
$\Delta I_{Adj} / V_{Line}$	Adjust Pin Current Change vs. Line Voltage	$-42 V \leq V_{IN} \leq -4.25 V$ , $I_L = 5 mA$	1	-5.0	5.0	$\mu A$
		$-41.3 V \leq V_{IN} \leq -4.25 V$ , $I_L = 5 mA$	2, 3	-5.0	5.0	$\mu A$
$\Delta I_{Adj} / I_{Load}$	Adjust Pin Current Change vs. Load Current	$5 mA \leq I_L \leq 500 mA$ , $V_{IN} = -6.5 V$	1, 2, 3	-5.0	5.0	$\mu A$
$V_{Rth}$	Thermal Regulation	$V_{IN} = -14.5 V$ , $I_L = 500 mA$ , $t = 10 mS$	1	-5.0	5.0	mV
		$V_{IN} = -14.5 V$ , $I_L = 5 mA$ , $t = 10 mS$	1	-5.0	5.0	mV
$I_{CL}$	Current Limit	$V_{IN} = -5 V$	1, 2, 3	-1.8	-0.5	A
		$V_{IN} = -40 V$	1, 2, 3	-0.65	-0.15	A
$V_O$	Output Voltage	1	-1.28	-1.22	V	
		2, 3	-1.3	-1.2	V	

(1)  $V_{IN} = -41.3V$  at  $+125^\circ C$  and  $-55^\circ C$

(2)  $-41.3V \leq V_{IN} \leq -4.25V$  at  $+125^\circ C$  and  $-55^\circ C$

## 6.7 LM137H 883 Electrical Characteristics AC Parameters

PARAMETER	TEST CONDITIONS	SUB-GROUPS	MIN	MAX	UNIT
$R_R$	Ripple Rejection Ratio (1)	$V_{IN} = -6.25 V$ , $V_{OUT} = V_{Ref}$ , $I_L = 125 mA$ , $e_i = 1V_{RMS}$ , $F = 120 Hz$	4,5,6	66	dB

(1) Test at  $+25^\circ C$ , ensured but not tested at  $+125^\circ C$  and  $-55^\circ C$

## 6.8 LM137K 883 Electrical Characteristics DC Parameters

The following conditions apply, unless otherwise specified.  $V_{IN} = -4.25V$ ,  $I_L = 8mA$ ,  $V_{OUT} = V_{Ref}^{(1)(2)}$

PARAMETER	TEST CONDITIONS	SUB-GROUPS	MIN	MAX	UNIT	
$V_{Ref}$	Reference Voltage	1	-1.275	-1.225	V	
		2, 3	-1.3	-1.2	V	
		$V_{IN} = -42V$	1	-1.275	-1.225	V
		$V_{IN} = -41.3V$	2, 3	-1.3	-1.2	V
$I_Q$	Minimum Load Current	$V_{OUT} = -1.7V$	1, 2, 3		3.0	mA
		$V_{OUT} = -1.7V$ , $V_{IN} = -11.75V$	1, 2, 3		3.0	mA
		$V_{OUT} = -1.7V$ , $V_{IN} = -42V$	1		5.0	mA
		$V_{OUT} = -1.7V$ , $V_{IN} = -41.3V$	2, 3		5.0	mA
$R_{Line}$	Line Regulation	$-42V \leq V_{IN} \leq -4.25V$	1	-9.0	9.0	mV
		$-41.3V \leq V_{IN} \leq -4.25V$	2, 3	-23	23	mV
$R_{Load}$	Load Regulation	$V_{IN} = -6.25V$ , $8mA \leq I_L \leq 1.5A$	1, 2, 3	-25	25	mV
		$V_{IN} = -14.5V$ , $8mA \leq I_L \leq 1.5A$	1	-25	25	mV
		$V_{IN} = -40V$ , $8mA \leq I_L \leq 300mA$	1	-25	25	mV
		$V_{IN} = -40V$ , $8mA \leq I_L \leq 250mA$	2, 3	-25	25	mV
$I_{Adj}$	Adjustment Pin Current		1, 2, 3		100	$\mu A$
		$V_{IN} = -42V$	1		100	$\mu A$
		$V_{IN} = -41.3V$	2, 3		100	$\mu A$
$\Delta I_{Adj} / V_{Line}$	Adjust Pin Current Change vs. Line Voltage	$-42V \leq V_{IN} \leq -4.25V$	1	-5.0	5.0	$\mu A$
		$-41.3V \leq V_{IN} \leq -4.25V$	2, 3	-5.0	5.0	$\mu A$
$\Delta I_{Adj} / I_{Load}$	Adjust Pin Current Change vs. Load Current	$8mA \leq I_L \leq 1.5A$ , $V_{IN} = -6.25V$	1, 2, 3	-5.0	5.0	$\mu A$
$V_{Rth}$	Thermal Regulation	$V_{IN} = -14.5V$ , $I_L = 1.5mA$ , $t = 10mS$	1	-5.0	5.0	mV
		$V_{IN} = -14.5V$ , $I_L = 8mA$ , $t = 10mS$	1	-5.0	5.0	mV
$I_{CL}$	Current Limit	$V_{IN} = -5V$	1, 2, 3	-3.5	-1.5	A
		$V_{IN} = -40V$	1, 2, 3	-1.2	-0.24	A

(1)  $V_{IN} = -41.3V$  at  $+125^\circ C$  and  $-55^\circ C$

(2)  $-41.3V \leq V_{IN} \leq -4.25V$  at  $+125^\circ C$  and  $-55^\circ C$

## 6.9 LM137K 883 Electrical Characteristics AC Parameters

PARAMETER	TEST CONDITIONS	SUB-GROUPS	MIN	MAX	UNIT
$R_R$	Ripple Rejection Ratio (1)	$V_{IN} = -6.25V$ , $V_{OUT} = V_{Ref}$ , $f = 120Hz$ , $I_L = 0.5A$ , $e_i = 1V_{RMS}$	4,5,6	66	dB

(1) Test at  $+25^\circ C$ , ensured but not tested at  $+125^\circ C$  and  $-55^\circ C$

## 6.10 LM137H RH Electrical Characteristics DC Parameters 5962P9951708VXA

The following conditions apply, unless otherwise specified. <sup>(1)</sup>

PARAMETER	TEST CONDITIONS	SUB-GROUPS	MIN	MAX	UNIT	
$V_{OUT}$	Output Voltage	$V_{IN} = -4.25\text{ V}, I_L = 5\text{ mA}$	1	-1.275	-1.225	V
			2, 3	-1.3	-1.2	V
		$V_{IN} = -4.25\text{ V}, I_L = 500\text{ mA}$	1	-1.275	-1.225	V
			2, 3	-1.3	-1.2	V
		$V_{IN} = -41.25\text{ V}, I_L = 5\text{ mA}$	1	-1.275	-1.225	V
			2, 3	-1.3	-1.2	V
	$V_{IN} = -41.25\text{ V}, I_L = 50\text{ mA}$	1	-1.275	-1.225	V	
		2, 3	-1.3	-1.2	V	
$V_{R\text{ Line}}$	Line Regulation	$V_{IN} = -41.25\text{ V to } -4.25\text{ V}, I_L = 5\text{ mA}$	1	-9.0	9.0	mV
			2, 3	-23	23	mV
$V_{R\text{ Load}}$	Load Regulation	$V_{IN} = -6.25\text{ V}, I_L = 5\text{ mA to } 500\text{ mA}$	1	-12	12	mV
			2, 3	-24	24	mV
		$V_{IN} = -41.25\text{ V}, I_L = 5\text{ mA to } 50\text{ mA}$	1	-6.0	6.0	mV
			2, 3	-12	12	mV
		$V_{IN} = -6.25\text{ V}, I_L = 5\text{ mA to } 200\text{ mA}$	1	-6.0	6.0	mV
			2, 3	-12	12	mV
$V_{Rth}$	Thermal Regulation	$V_{IN} = -14.6\text{ V}, I_L = 500\text{ mA}$	1	-5.0	5.0	mV
$I_{Adj}$	Adjust Pin Current	$V_{IN} = -4.25\text{ V}, I_L = 5\text{ mA}$	1, 2, 3	25	100	$\mu\text{A}$
		$V_{IN} = -41.25\text{ V}, I_L = 5\text{ mA}$	1, 2, 3	25	100	$\mu\text{A}$
$\Delta I_{Adj} / V_{Line}$	Adjust Pin Current Change vs. Line Voltage	$V_{IN} = -41.25\text{ V to } -4.25\text{ V}, I_L = 5\text{ mA}$	1, 2, 3	-5.0	5.0	$\mu\text{A}$
$\Delta I_{Adj} / I_{Load}$	Adjust Pin Current Change vs. Load Current	$V_{IN} = -6.25\text{ V}, I_L = 5\text{ mA to } 500\text{ mA}$	1, 2, 3	-5.0	5.0	$\mu\text{A}$
$I_{OS}$	Output Short Circuit Current	$V_{IN} = -4.25\text{ V}$	1, 2, 3	0.5	1.8	A
		$V_{IN} = -40\text{ V}$	1, 2, 3	0.05	0.5	A
$V_{OUT\text{ Recovery}}$	Output Voltage Recovery After Output Short Circuit Current	$V_{IN} = -4.25\text{ V}$	1	-1.275	-1.225	V
			2, 3	-1.3	-1.2	V
		$V_{IN} = -40\text{ V}$	1	-1.275	-1.225	V
			2, 3	-1.3	-1.2	V
$I_Q$	Minimum Load Current	$V_{IN} = -4.25\text{ V}$	1, 2, 3	0.2	3.0	mA
		$V_{IN} = -14.25\text{ V}$	1, 2, 3	0.2	3.0	mA
		$V_{IN} = -41.25\text{ V}$	1, 2, 3	1.0	5.0	mA
$V_{Start}$	Voltage Start-up	$V_{IN} = -4.25\text{ V}, I_L = 500\text{ mA}$	1	-1.275	-1.225	V
			2, 3	-1.3	-1.2	V
$V_{OUT}$	Output Voltage <sup>(2)</sup>	$V_{IN} = -6.25\text{ V}, I_L = 5\text{ mA}$	2	-1.3	-1.2	V

(1) Pre and post irradiation limits are identical to those listed under AC and DC electrical characteristics except as listed in the Post Radiation Limits Table. These parts may be dose rate sensitive in a space environment and demonstrate enhanced low dose rate effect. Radiation end point limits for the noted parameters are specified only for the conditions as specified in Mil-Std-883, Method 1019.5, Condition A.

(2) Tested at +125°C; correlated to +150°C



## 6.11 LM137H RH Electrical Characteristics AC Parameters 5962P9951708VXA

The following conditions apply, unless otherwise specified.<sup>(1)</sup>

PARAMETER		TEST CONDITIONS	SUB-GROUPS	MIN	MAX	UNIT
$\Delta V_{IN} / \Delta V_{OUT}$	Ripple Rejection	$V_{IN} = -6.25\text{ V}$ , $I_L = 125\text{ mA}$ , $e_i = 1V_{RMS}$ at 2400 Hz	9	48		dB
$V_{NO}$	Output Noise Voltage	$V_{IN} = -6.25\text{ V}$ , $I_L = 50\text{ mA}$	9		120	$\mu V_{RMS}$
$\Delta V_{OUT} / \Delta V_{IN}$	Line Transient Response	$V_{IN} = -6.25\text{ V}$ , $V_{Pulse} = -1\text{ V}$ , $I_L = 50\text{ mA}$	9		80	mV/V
$\Delta V_O / \Delta I_L$	Load Transient Response <sup>(2)</sup>	$V_{IN} = -6.25\text{ V}$ , $I_L = 50\text{ mA}$ , $\Delta I_L = 200\text{ mA}$	9		60	mV

(1) Pre and post irradiation limits are identical to those listed under AC and DC electrical characteristics except as listed in the Post Radiation Limits Table. These parts may be dose rate sensitive in a space environment and demonstrate enhanced low dose rate effect. Radiation end point limits for the noted parameters are specified only for the conditions as specified in Mil-Std-883, Method 1019.5, Condition A.

(2) Limit of 0.3mV/mA is equivalent to 60mV

## 6.12 LM137H RH Electrical Characteristics DC Parameters Drift Values 5962P9951708VXA

The following conditions apply, unless otherwise specified.<sup>(1)</sup>

Delta calculations performed on QMLV devices at group B, subgroup 5 only.

PARAMETER		TEST CONDITIONS	SUB-GROUPS	MIN	MAX	UNIT
$V_{OUT}$	Output Voltage	$V_{IN} = -4.25\text{ V}$ , $I_L = 5\text{ mA}$	1	-0.01	0.01	V
		$V_{IN} = -4.25\text{ V}$ , $I_L = 500\text{ mA}$	1	-0.01	0.01	V
		$V_{IN} = -41.25\text{ V}$ , $I_L = 5\text{ mA}$	1	-0.01	0.01	V
		$V_{IN} = -41.25\text{ V}$ , $I_L = 50\text{ mA}$	1	-0.01	0.01	V
$V_{R\text{ Line}}$	Line Regulation	$V_{IN} = -41.25\text{ V to } -4.25\text{ V}$ , $I_L = 5\text{ mA}$	1	-4.0	4.0	mV
$I_{Adj}$	Adjust Pin Current	$V_{IN} = -4.25\text{ V}$ , $I_L = 5\text{ mA}$	1	-10	10	$\mu\text{A}$
		$V_{IN} = -41.25\text{ V}$ , $I_L = 5\text{ mA}$	1	-10	10	$\mu\text{A}$

(1) Pre and post irradiation limits are identical to those listed under AC and DC electrical characteristics except as listed in the Post Radiation Limits Table. These parts may be dose rate sensitive in a space environment and demonstrate enhanced low dose rate effect. Radiation end point limits for the noted parameters are specified only for the conditions as specified in Mil-Std-883, Method 1019.5, Condition A.

## 6.13 LM137H RH Electrical Characteristics DC Parameters Post Radiation Limits +25°C 5962P9951708VXA

The following conditions apply, unless otherwise specified.<sup>(1)</sup>

PARAMETER		TEST CONDITIONS	SUB-GROUPS	MIN	MAX	UNIT
$V_{OUT}$	Output Voltage	$V_{IN} = -41.25\text{ V}$ , $I_L = 5\text{ mA}$	1	-1.30	-1.225	V
		$V_{IN} = -41.25\text{ V}$ , $I_L = 50\text{ mA}$	1	-1.30	-1.225	V
$V_{R\text{ Line}}$	Line Regulation	$V_{IN} = -41.25\text{ V to } -4.25\text{ V}$ , $I_L = 5\text{ mA}$	1	-9.0	+50	mV
$I_{Adj}$	Adjust Pin Current	$V_{IN} = -41.25\text{ V}$ , $I_L = 5\text{ mA}$	1	25	140	$\mu\text{A}$
$\Delta I_{Adj} / V_{Line}$	Adjust Pin Current Change vs. Line Voltage	$V_{IN} = -41.25\text{ V to } -4.25\text{ V}$ , $I_L = 5\text{ mA}$	1	-70	+20	$\mu\text{A}$
$V_{OUT\text{ Recovery}}$	Output Voltage Recovery After Output Short Circuit Current	$V_{IN} = -40\text{ V}$	1	-1.30	-1.225	V

(1) Pre and post irradiation limits are identical to those listed under AC and DC electrical characteristics except as listed in the Post Radiation Limits Table. These parts may be dose rate sensitive in a space environment and demonstrate enhanced low dose rate effect. Radiation end point limits for the noted parameters are specified only for the conditions as specified in Mil-Std-883, Method 1019.5, Condition A.

### 6.14 Typical Performance Characteristics

(NDT & K Packages)

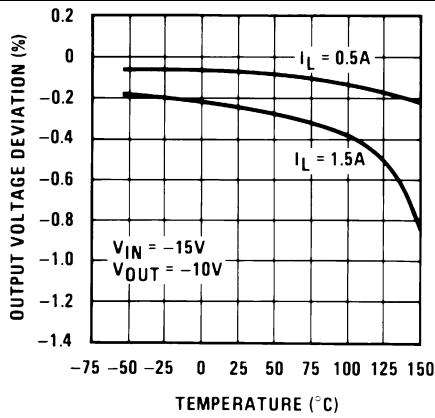

Figure 1. Load Regulation

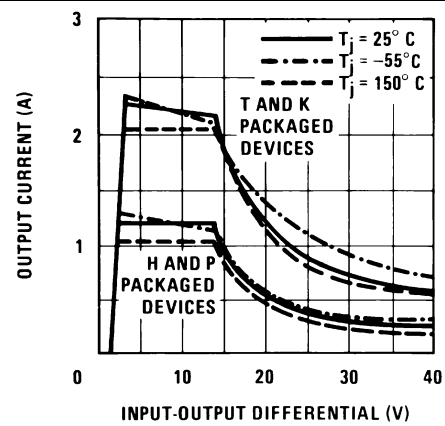

Figure 2. Current Limit

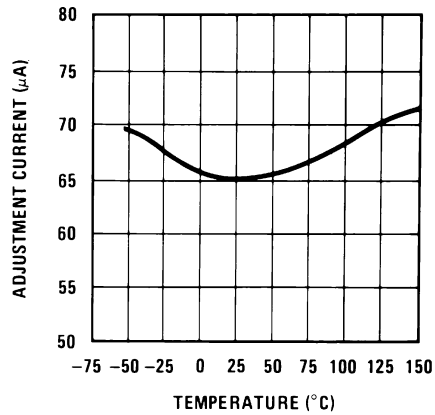

Figure 3. Adjustment Current

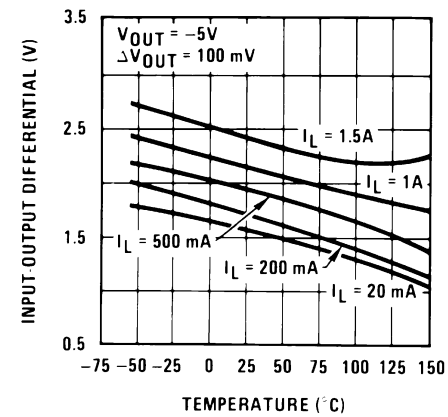

Figure 4. Dropout Voltage

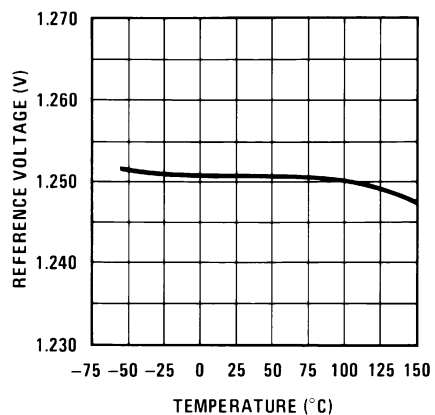

Figure 5. Temperature Stability

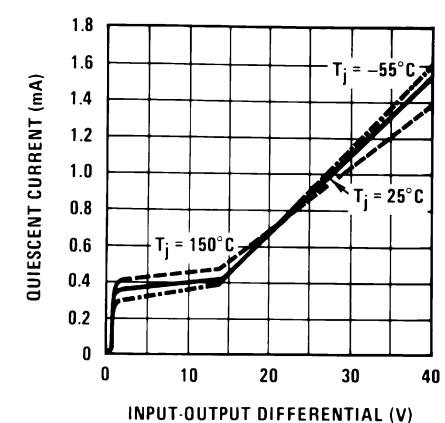

Figure 6. Minimum Operating Current

Typical Performance Characteristics (continued)

(NDT & K Packages)

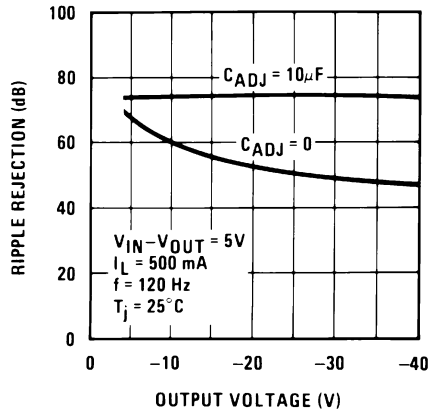

Figure 7. Ripple Rejection

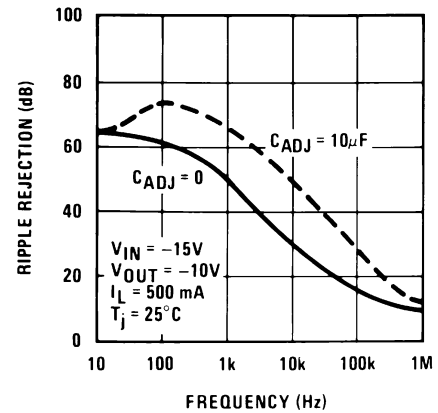

Figure 8. Ripple Rejection

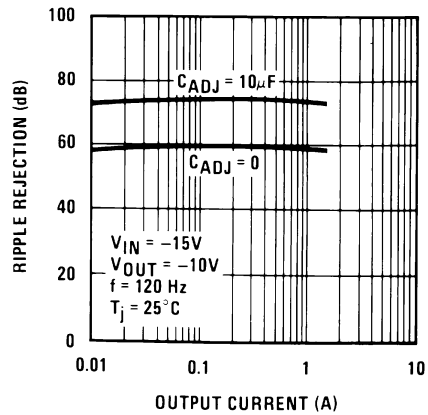

Figure 9. Ripple Rejection

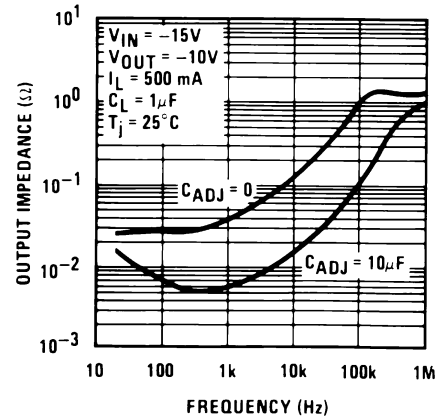

Figure 10. Output Impedance

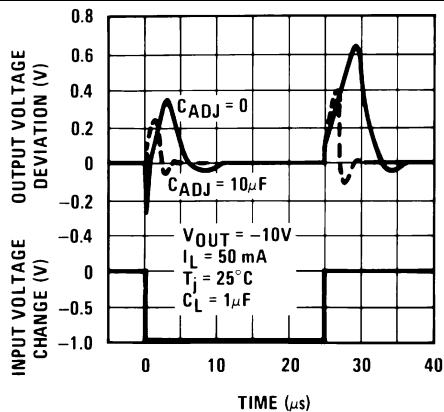

Figure 11. Line Transient Response

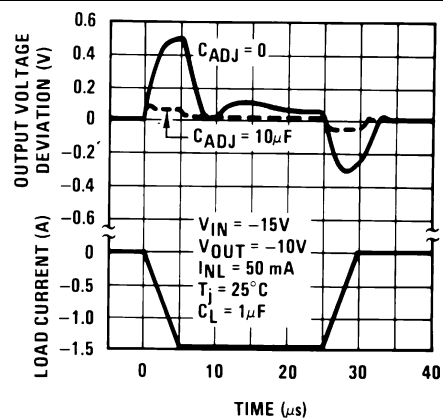

Figure 12. Load Transient Response



## 8 Application and Implementation

### NOTE

Information in the following applications sections is not part of the TI component specification, and TI does not warrant its accuracy or completeness. TI's customers are responsible for determining suitability of components for their purposes. Customers should validate and test their design implementation to confirm system functionality.

### 8.1 Application Information and Schematic Diagram

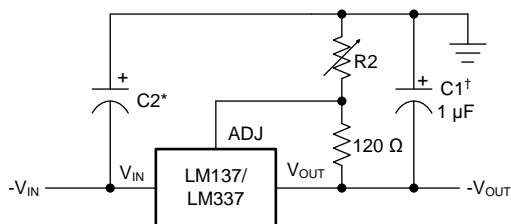

Full output current not available at high input-output voltages

$$-V_{OUT} = 1.25 \left( V_1 + \frac{R_2}{120} \right) + (-I_{ADJ} \times R_2)$$

†C1 = 1 μF solid tantalum or 10 μF aluminum electrolytic required for stability

\*C2 = 1 μF solid tantalum is required only if regulator is more than 4" from power-supply filter capacitor

Output capacitors in the range of 1 μF to 1000 μF of aluminum or tantalum electrolytic are commonly used to provide improved output impedance and rejection of transients

Figure 14. Adjustable Negative Voltage Regulator

### 8.2 Typical Applications

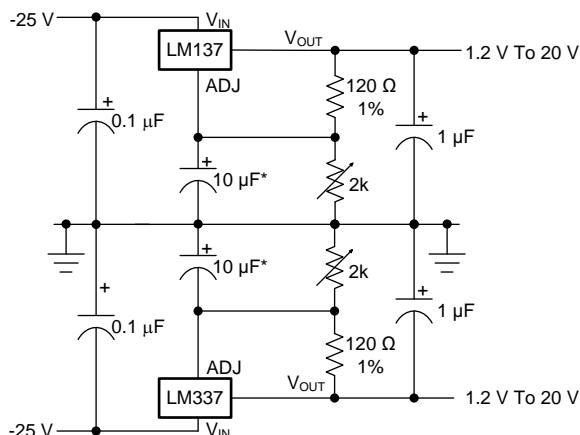

Full output current not available at high input-output voltages

\*The 10 μF capacitors are optional to improve ripple rejection

Figure 15. Adjustable Lab Voltage Regulator

Typical Applications (continued)

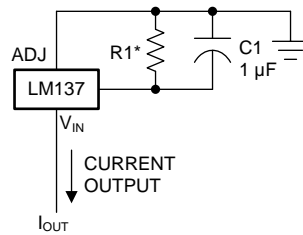
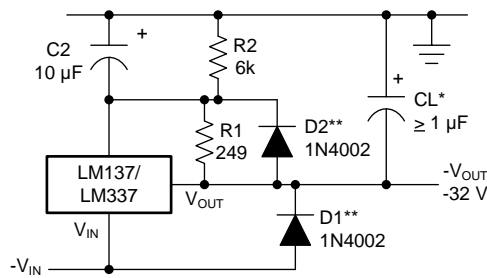

Figure 16. Current Regulator

$$I_{OUT} = \frac{1.250 \text{ V}}{R1}$$

$$*0.8 \Omega \leq R1 \leq 120 \Omega$$

(1)



\*When CL is larger than 20 μF, D1 protects the LM137 in case the input supply is shorted

\*\*When C2 is larger than 10 μF and -VOUT is larger than -25V, D2 protects the LM137 in case the output is shorted

Figure 17. Negative Regulator with Protection Diodes

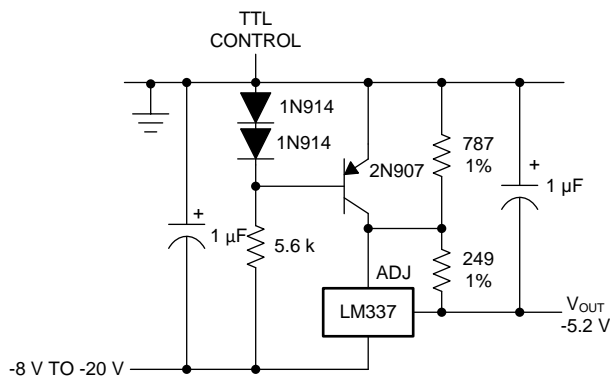

\*Minimum output ≈ -1.3V when control input is low

Figure 18. -5.2V Regulator with Electronic Shutdown\*

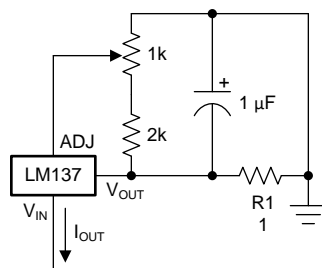

Figure 19. Adjustable Current Regulator

Typical Applications (continued)

$$I_{OUT} = \left( \frac{1.5 \text{ V}}{R1} \right) \pm 15\% \text{ adjustable} \quad (2)$$

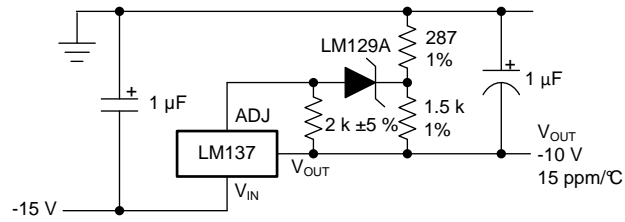
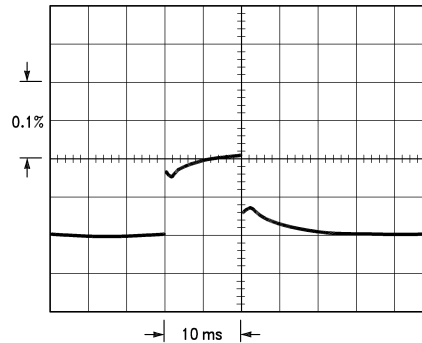

Figure 20. High Stability -10V Regulator

## 9 Power Supply Recommendations

### 9.1 Thermal Regulation

When power is dissipated in an IC, a temperature gradient occurs across the IC chip affecting the individual IC circuit components. With an IC regulator, this gradient can be especially severe since power dissipation is large. Thermal regulation is the effect of these temperature gradients on output voltage (in percentage output change) per Watt of power change in a specified time. Thermal regulation error is independent of electrical regulation or temperature coefficient, and occurs within 5 ms to 50 ms after a change in power dissipation. Thermal regulation depends on IC layout as well as electrical design. The thermal regulation of a voltage regulator is defined as the percentage change of  $V_{OUT}$ , per Watt, within the first 10 ms after a step of power is applied. The LM137's specification is 0.02%/W, max.



LM137,  $V_{OUT} = -10V$   $V_{IN} - V_{OUT} = -40V$   
 Horizontal sensitivity, 5 ms/div  $I_L = 0A \rightarrow 0.25A \rightarrow 0A$

**Figure 21.**

In [Figure 21](#), a typical LM137's output drifts only 3 mV (or 0.03% of  $V_{OUT} = -10V$ ) when a 10W pulse is applied for 10 ms. This performance is thus well inside the specification limit of  $0.02\%/W \times 10W = 0.2\%$  max. When the 10W pulse is ended, the thermal regulation again shows a 3 mV step as the LM137 chip cools off. Note that the load regulation error of about 8 mV (0.08%) is additional to the thermal regulation error. In [Figure 22](#), when the 10W pulse is applied for 100 ms, the output drifts only slightly beyond the drift in the first 10 ms, and the thermal error stays well within 0.1% (10 mV).

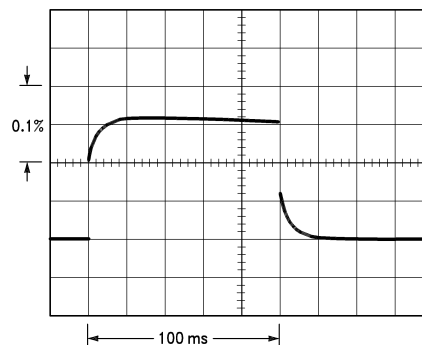

LM137,  $V_{OUT} = -10V$   $V_{IN} - V_{OUT} = -40V$   
 Horizontal sensitivity, 20 ms/div  $I_L = 0A \rightarrow 0.25A \rightarrow 0A$

**Figure 22.**



## 10 Device and Documentation Support

### 10.1 Receiving Notification of Documentation Updates

To receive notification of documentation updates, navigate to the device product folder on ti.com. In the upper right corner, click on *Alert me* to register and receive a weekly digest of any product information that has changed. For change details, review the revision history included in any revised document.

### 10.2 Community Resources

The following links connect to TI community resources. Linked contents are provided "AS IS" by the respective contributors. They do not constitute TI specifications and do not necessarily reflect TI's views; see TI's [Terms of Use](#).

**TI E2E™ Online Community** *TI's Engineer-to-Engineer (E2E) Community*. Created to foster collaboration among engineers. At e2e.ti.com, you can ask questions, share knowledge, explore ideas and help solve problems with fellow engineers.

**Design Support** *TI's Design Support* Quickly find helpful E2E forums along with design support tools and contact information for technical support.

### 10.3 Trademarks

E2E is a trademark of Texas Instruments.  
All other trademarks are the property of their respective owners.

### 10.4 Electrostatic Discharge Caution



These devices have limited built-in ESD protection. The leads should be shorted together or the device placed in conductive foam during storage or handling to prevent electrostatic damage to the MOS gates.

### 10.5 Glossary

[SLYZ022](#) — *TI Glossary*.

This glossary lists and explains terms, acronyms, and definitions.

## 11 Mechanical, Packaging, and Orderable Information

The following pages include mechanical, packaging, and orderable information. This information is the most current data available for the designated devices. This data is subject to change without notice and revision of this document. For browser-based versions of this data sheet, refer to the left-hand navigation.

**PACKAGING INFORMATION**

Orderable Device	Status (1)	Package Type	Package Drawing	Pins	Package Qty	Eco Plan (2)	Lead finish/ Ball material (6)	MSL Peak Temp (3)	Op Temp (°C)	Device Marking (4/5)	Samples
5962P9951708VXA	ACTIVE	TO	NDT	3	20	Non-RoHS & Non-Green	Call TI	Call TI	-55 to 125	LM137H1PQMLV 5962P9951708VXA Q ACO 5962P9951708VXA Q >T	<a href="#">Samples</a>
LM137H MD8	ACTIVE	DIESALE	Y	0	120	RoHS & Green	Call TI	Level-1-NA-UNLIM	-55 to 125		<a href="#">Samples</a>
LM137H/883	ACTIVE	TO	NDT	3	20	RoHS & Green	Call TI	Level-1-NA-UNLIM	-55 to 125	LM137H/883 Q ACO LM137H/883 Q >T	<a href="#">Samples</a>
LM137H1PQMLV	ACTIVE	TO	NDT	3	20	Non-RoHS & Green	Call TI	Level-1-NA-UNLIM	-55 to 125	LM137H1PQMLV 5962P9951708VXA Q ACO 5962P9951708VXA Q >T	<a href="#">Samples</a>
LM137K/883	ACTIVE	TO	K	2	50	Non-RoHS & Non-Green	Call TI	Call TI	-55 to 125	(LM120H-15P+, LM13 7K) /883 Q ACO /883 Q >T	<a href="#">Samples</a>
LM137KG MD8	ACTIVE	DIESALE	Y	0	120	RoHS & Green	Call TI	Level-1-NA-UNLIM	-55 to 125		<a href="#">Samples</a>
LM137KG-MW8	ACTIVE	WAFERSALE	YS	0	1	RoHS & Green	Call TI	Level-1-NA-UNLIM	-55 to 125		<a href="#">Samples</a>

(1) The marketing status values are defined as follows:

**ACTIVE:** Product device recommended for new designs.

**LIFEBUY:** TI has announced that the device will be discontinued, and a lifetime-buy period is in effect.

**NRND:** Not recommended for new designs. Device is in production to support existing customers, but TI does not recommend using this part in a new design.

**PREVIEW:** Device has been announced but is not in production. Samples may or may not be available.

**OBSOLETE:** TI has discontinued the production of the device.

(2) **RoHS:** TI defines "RoHS" to mean semiconductor products that are compliant with the current EU RoHS requirements for all 10 RoHS substances, including the requirement that RoHS substance do not exceed 0.1% by weight in homogeneous materials. Where designed to be soldered at high temperatures, "RoHS" products are suitable for use in specified lead-free processes. TI may reference these types of products as "Pb-Free".

**RoHS Exempt:** TI defines "RoHS Exempt" to mean products that contain lead but are compliant with EU RoHS pursuant to a specific EU RoHS exemption.

**Green:** TI defines "Green" to mean the content of Chlorine (Cl) and Bromine (Br) based flame retardants meet JS709B low halogen requirements of <=1000ppm threshold. Antimony trioxide based flame retardants must also meet the <=1000ppm threshold requirement.

- (3) MSL, Peak Temp. - The Moisture Sensitivity Level rating according to the JEDEC industry standard classifications, and peak solder temperature.
- (4) There may be additional marking, which relates to the logo, the lot trace code information, or the environmental category on the device.
- (5) Multiple Device Markings will be inside parentheses. Only one Device Marking contained in parentheses and separated by a "~" will appear on a device. If a line is indented then it is a continuation of the previous line and the two combined represent the entire Device Marking for that device.
- (6) Lead finish/Ball material - Orderable Devices may have multiple material finish options. Finish options are separated by a vertical ruled line. Lead finish/Ball material values may wrap to two lines if the finish value exceeds the maximum column width.

**Important Information and Disclaimer:** The information provided on this page represents TI's knowledge and belief as of the date that it is provided. TI bases its knowledge and belief on information provided by third parties, and makes no representation or warranty as to the accuracy of such information. Efforts are underway to better integrate information from third parties. TI has taken and continues to take reasonable steps to provide representative and accurate information but may not have conducted destructive testing or chemical analysis on incoming materials and chemicals. TI and TI suppliers consider certain information to be proprietary, and thus CAS numbers and other limited information may not be available for release.

In no event shall TI's liability arising out of such information exceed the total purchase price of the TI part(s) at issue in this document sold by TI to Customer on an annual basis.

**OTHER QUALIFIED VERSIONS OF LM137QML, LM137QML-SP :**

- Military : [LM137QML](#)
- Space : [LM137QML-SP](#)

NOTE: Qualified Version Definitions:

- Military - QML certified for Military and Defense Applications
- Space - Radiation tolerant, ceramic packaging and qualified for use in Space-based application

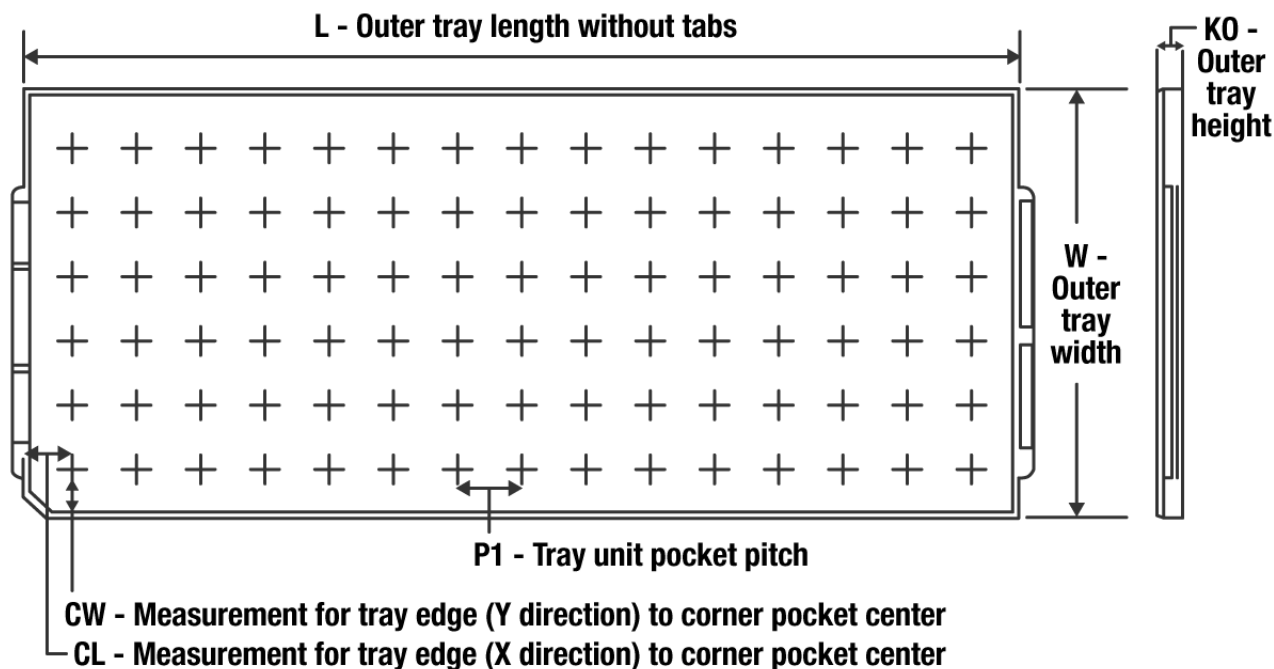
**TRAY**

Chamfer on Tray corner indicates Pin 1 orientation of packed units.

\*All dimensions are nominal

Device	Package Name	Package Type	Pins	SPQ	Unit array matrix	Max temperature (°C)	L (mm)	W (mm)	K0 (µm)	P1 (mm)	CL (mm)	CW (mm)
5962P9951708VXA	NDT	TO-CAN	3	20	2 X 10	150	126.49	61.98	8890	11.18	12.95	18.54
LM137H/883	NDT	TO-CAN	3	20	2 X 10	150	126.49	61.98	8890	11.18	12.95	18.54
LM137H1PQMLV	NDT	TO-CAN	3	20	2 X 10	150	126.49	61.98	8890	11.18	12.95	18.54
LM137K/883	K	TO-CAN	2	50	9 X 6	NA	292.1	215.9	25654	3.87	22.3	25.4

NDT0003A

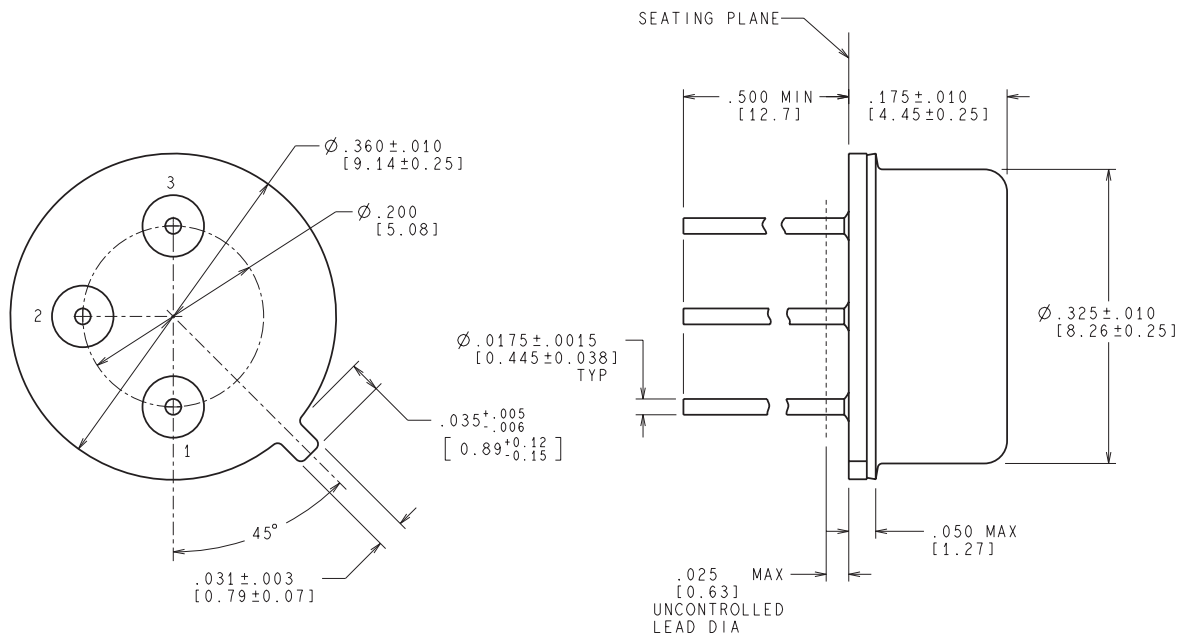

CONTROLLING DIMENSION IS INCH  
VALUES IN [ ] ARE MILLIMETERS

MIL-PRF-38535  
CONFIGURATION CONTROL

H03A (Rev D)

K0002A



# PACKAGE OUTLINE

TO-CAN - 7.747 mm max height

TRANSISTOR OUTLINE

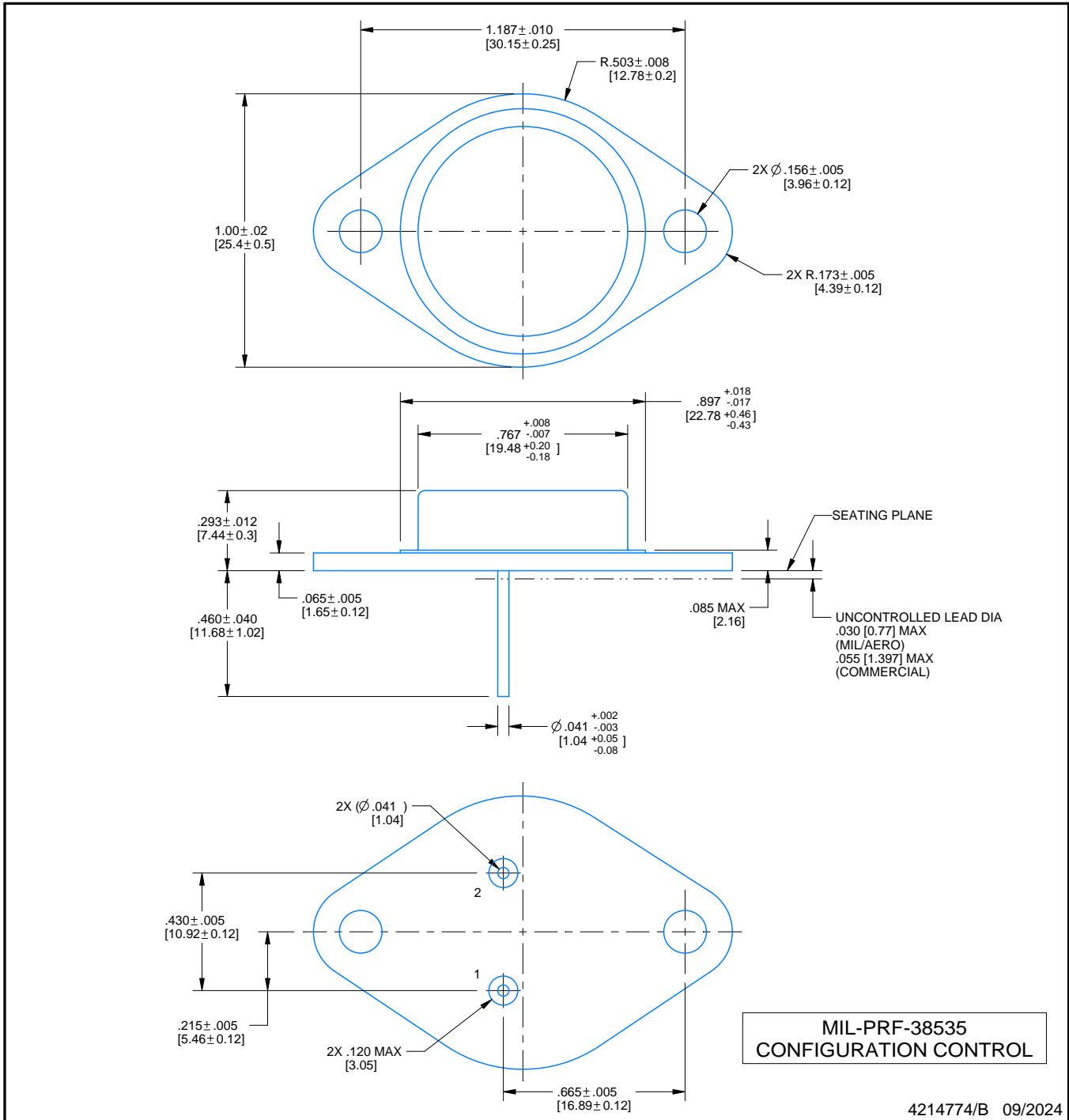

**NOTES:**

1. Linear dimensions are in inches [millimeters]. Dimensions in parenthesis are for reference only. Controlling dimensions are in inches. Dimensioning and tolerancing per ASME Y14.5M.
2. This drawing is subject to change without notice.
3. Leads not to be bent greater than 15°.

## IMPORTANT NOTICE AND DISCLAIMER

TI PROVIDES TECHNICAL AND RELIABILITY DATA (INCLUDING DATA SHEETS), DESIGN RESOURCES (INCLUDING REFERENCE DESIGNS), APPLICATION OR OTHER DESIGN ADVICE, WEB TOOLS, SAFETY INFORMATION, AND OTHER RESOURCES "AS IS" AND WITH ALL FAULTS, AND DISCLAIMS ALL WARRANTIES, EXPRESS AND IMPLIED, INCLUDING WITHOUT LIMITATION ANY IMPLIED WARRANTIES OF MERCHANTABILITY, FITNESS FOR A PARTICULAR PURPOSE OR NON-INFRINGEMENT OF THIRD PARTY INTELLECTUAL PROPERTY RIGHTS.

These resources are intended for skilled developers designing with TI products. You are solely responsible for (1) selecting the appropriate TI products for your application, (2) designing, validating and testing your application, and (3) ensuring your application meets applicable standards, and any other safety, security, regulatory or other requirements.

These resources are subject to change without notice. TI grants you permission to use these resources only for development of an application that uses the TI products described in the resource. Other reproduction and display of these resources is prohibited. No license is granted to any other TI intellectual property right or to any third party intellectual property right. TI disclaims responsibility for, and you will fully indemnify TI and its representatives against, any claims, damages, costs, losses, and liabilities arising out of your use of these resources.

TI's products are provided subject to [TI's Terms of Sale](#) or other applicable terms available either on [ti.com](https://www.ti.com) or provided in conjunction with such TI products. TI's provision of these resources does not expand or otherwise alter TI's applicable warranties or warranty disclaimers for TI products.

TI objects to and rejects any additional or different terms you may have proposed.

Mailing Address: Texas Instruments, Post Office Box 655303, Dallas, Texas 75265  
Copyright © 2024, Texas Instruments Incorporated