

# LM3633 Complete Lighting Power Solution for Smartphone Handsets

Check for Samples: [LM3633](#)

## 1 Features

- Drives Three Parallel High-Voltage LED Strings for Display and Keypad Lighting
- High-Voltage Strings Capable of up to 40-V Output Voltage and up to 90% Efficiency
- Up to 30-mA per Current Sink (Both Backlight and Indicator)
- 11-Bit High-Voltage LED Dimming
- PWM Input for Content Adjustable Brightness Control (CABC)
- Integrated 1-A/40-V MOSFET
- Adaptive Boost Output to LED Voltages
- Six Low-Voltage Current Sinks for Indicator LEDs
- Integrated Charge Pump for Improved Efficiency and  $V_{IN}$  Operating Range
- Internal Pattern Generation Engine for Each Indicator LED
- Fully Configurable LED Grouping and Control
- Four Programmable Overvoltage Protection Thresholds (16 V, 24 V, 32 V, and 40 V)
- Programmable 500-kHz and 1-MHz Switching Frequency
- Overcurrent Protection
- Thermal Shutdown Protection
- 27 mm<sup>2</sup> Total Solution Size

## 2 Applications

- Power Source for Smart Phone Illumination
- Display, Keypad and Indicator Illumination
- RGB Indicator Driver

## 3 Description

The LM3633 11-bit LED driver provides high-performance backlight dimming for 1, 2, or 3 parallel high-voltage LED strings while delivering up to 90% efficiency. The boost converter with integrated 1-A, 40-V MOSFET automatically adjusts to LED forward voltage to minimize headroom voltage and effectively improve LED efficiency.

The LM3633 is a complete power source for backlight, keypad, and indicator LEDs in smartphone handsets. The high-voltage inductive boost converter provides the power for three parallel LED strings (HVLED1, HVLED2 and HVLED3). The integrated charge pump provides the bias for the six low-voltage indicator LEDs (LVLED1-LVLED6). All low-voltage current sinks can have a programmable pattern modulated onto their output current for a wide variety of blinking patterns.

An additional feature is a Pulse Width Modulation (PWM) control input for content adjustable backlight control, which can be used to control any high-voltage current sink.

The LM3633 is fully programmable via an I<sup>2</sup>C-compatible interface. The device operates over a 2.7-V to 5.5-V input voltage range and a -40°C to 85°C temperature range.

### Device Information<sup>(1)</sup>

PART NUMBER	PACKAGE	BODY SIZE (MAX)
LM3633	DSBGA (20)	2.04 mm x 1.78 mm

(1) For all available packages, see the orderable addendum at the end of the datasheet.

### Simplified Schematic

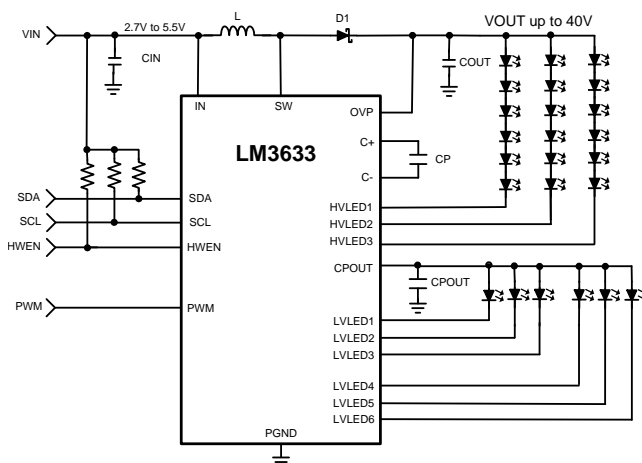

### Dual String Efficiency vs $V_{IN}$

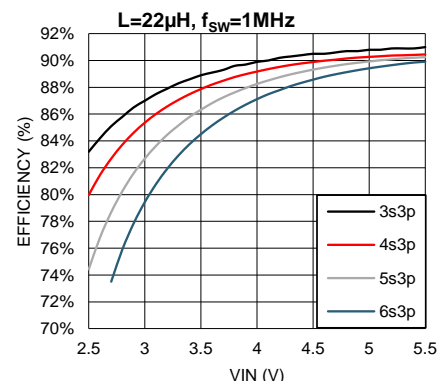

## Table of Contents

<b>1 Features</b> .....	<b>1</b>	7.4 Device Functional Modes .....	<b>12</b>
<b>2 Applications</b> .....	<b>1</b>	7.5 Register Descriptions .....	<b>24</b>
<b>3 Description</b> .....	<b>1</b>	<b>8 Applications and Implementation</b> .....	<b>33</b>
<b>4 Revision History</b> .....	<b>2</b>	8.1 Application Information .....	<b>33</b>
<b>5 Pin Configuration and Functions</b> .....	<b>3</b>	8.2 Typical Application .....	<b>33</b>
<b>6 Specifications</b> .....	<b>4</b>	8.3 Initialization Set Up .....	<b>45</b>
6.1 Absolute Maximum Ratings .....	<b>4</b>	<b>9 Power Supply Recommendations</b> .....	<b>48</b>
6.2 Handling Ratings .....	<b>4</b>	<b>10 Layout</b> .....	<b>48</b>
6.3 Recommended Operating Conditions .....	<b>4</b>	10.1 Layout Guidelines (Boost) .....	<b>48</b>
6.4 Thermal Information .....	<b>4</b>	10.2 Layout Guidelines (Charge Pump).....	<b>51</b>
6.5 Electrical Characteristics.....	<b>5</b>	10.3 Layout Example .....	<b>52</b>
6.6 Timing Requirements .....	<b>7</b>	<b>11 Device and Documentation Support</b> .....	<b>53</b>
6.7 Typical Characteristics .....	<b>8</b>	11.1 Device Support.....	<b>53</b>
<b>7 Detailed Description</b> .....	<b>10</b>	11.2 Trademarks .....	<b>53</b>
7.1 Overview .....	<b>10</b>	11.3 Electrostatic Discharge Caution.....	<b>53</b>
7.2 Functional Block Diagram .....	<b>10</b>	11.4 Glossary .....	<b>53</b>
7.3 Feature Description .....	<b>10</b>	<b>12 Mechanical, Packaging, and Orderable Information</b> .....	<b>53</b>

## 4 Revision History

Date	Revision	Notes
June 2014	*	Initial release

## 5 Pin Configuration and Functions

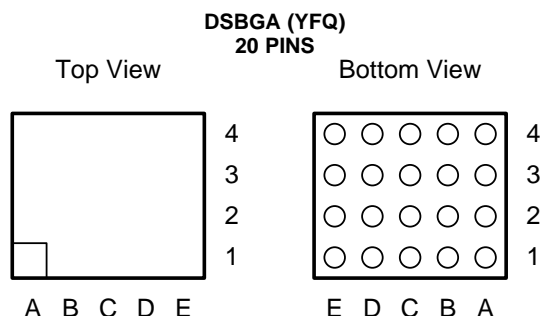

### Pin Functions

PIN		DESCRIPTION
NAME	NUMBER	
C-	A1	Integrated charge pump flying capacitor negative pin. Connect a 1- $\mu$ F ceramic capacitor between C+ and C-.
C+	A2	Integrated charge pump flying capacitor positive pin. Connect a 1- $\mu$ F ceramic capacitor between C+ and C-.
CPOUT	A3	Integrated charge pump output pin. Bypass CPOUT to GND with a 1- $\mu$ F ceramic capacitor.
IN	A4	Input voltage connection. Bypass IN to GND with a minimum 2.2- $\mu$ F ceramic capacitor.
HVLED1	B1	Input pin to high-voltage current sink 1 (40 V max). The boost converter regulates the minimum of HVLED1, HVLED2 and HVLED3 to $V_{HR}$ .
SDA	B2	Serial data connection for I <sup>2</sup> C-Compatible Interface.
OVP	B3	Overvoltage sense input. Connect OVP to the positive pin of the inductive boost output capacitor (COUT).
GND	B4	Ground
HVLED2	C1	Input pin to high-voltage current sink 2 (40 V max). The boost converter regulates the minimum of HVLED1, HVLED2 and HVLED3 to $V_{HR}$ .
SCL	C2	Serial clock connection for I <sup>2</sup> C-Compatible Interface.
PWM	C3	PWM brightness control input for CABC operation. PWM is a high-impedance input and cannot be left floating.
SW	C4	Drain connection for the internal NFET. Connect SW to the junction of the inductor and the Schottky diode anode.
HVLED3	D1	Input pin to high-voltage current sink 3 (40 V max). The boost converter regulates the minimum of HVLED1, HVLED2 and HVLED3 to $V_{HR}$ .
HWEN	D2	Hardware enable input. Drive this pin high to enable the device. Drive this pin low to force the device into a low power shutdown. HWEN is a high-impedance input and cannot be left floating.
LVLED6	D3	Low-voltage current sink 6
LVLED5	D4	Low-voltage current sink 5
LVLED1	E1	Low-voltage current sink 1
LVLED2	E2	Low-voltage current sink 2
LVLED3	E3	Low-voltage current sink 3
LVLED4	E4	Low-voltage current sink 4

## 6 Specifications

### 6.1 Absolute Maximum Ratings

over operating free-air temperature range (unless otherwise noted)<sup>(1)</sup>

	MIN	MAX	UNIT
V <sub>IN</sub> to GND	-0.3	6	V
V <sub>SW</sub> , V <sub>OVP</sub> , V <sub>HVLED1</sub> , V <sub>HVLED2</sub> , V <sub>HVLED3</sub> to GND	-0.3	45	
V <sub>SCL</sub> , V <sub>SDA</sub> , V <sub>PWM</sub> to GND	-0.3	6	
V <sub>HWEN</sub> , V <sub>CPOUT</sub> to GND, V <sub>C-</sub> , V <sub>C+</sub>	-0.3	6	
V <sub>LVLED1</sub> - V <sub>LVLED6</sub> , to GND	-0.3	6	
Continuous power dissipation		Internally Limited	
Junction temperature (T <sub>J-MAX</sub> )		150	°C

- (1) Stresses beyond those listed under absolute maximum ratings may cause permanent damage to the device. These are stress ratings only, which do not imply functional operation of the device at these or any other conditions beyond those indicated under recommended operating conditions. Exposure to absolute-maximum-rated conditions for extended periods may affect device reliability.

### 6.2 Handling Ratings

	MIN	MAX	UNIT	
T <sub>stg</sub> Storage temperature range	-65	150	°C	
V <sub>(ESD)</sub> Electrostatic discharge	Human body model (HBM), per ANSI/ESDA/JEDEC JS-001, all pins <sup>(1)</sup>	-1000	1000	V
	Charged device model (CDM), per JEDEC specification JESD22-C101, all pins <sup>(2)</sup>	-250	250	

- (1) JEDEC document JEP155 states that 500-V HBM allows safe manufacturing with a standard ESD control process.

- (2) JEDEC document JEP157 states that 250-V CDM allows safe manufacturing with a standard ESD control process.

### 6.3 Recommended Operating Conditions

over operating free-air temperature range (unless otherwise noted)

	MIN	NOM	MAX	UNIT
V <sub>IN</sub> to GND	2.7		5.5	V
V <sub>SW</sub> , V <sub>OVP</sub> , V <sub>HVLED1</sub> , V <sub>HVLED2</sub> , V <sub>HVLED3</sub> to GND, V <sub>PWM</sub> , V <sub>HWEN</sub> , V <sub>SDA</sub> , V <sub>SCL</sub>	0		40	
V <sub>LVLED1</sub> - V <sub>LVLED6</sub> to GND	0		6	
Junction temperature (T <sub>J</sub> ) <sup>(1) (2)</sup>	-40		125	°C

- (1) Internal thermal shutdown circuitry protects the device from permanent damage. Thermal shutdown engages at T<sub>J</sub> = 140°C (typ.) and disengages at T<sub>J</sub> = 125°C (typ.).

- (2) In applications where high power dissipation and/or poor package thermal resistance is present, the maximum ambient temperature may have to be derated. Maximum ambient temperature (T<sub>A-MAX</sub>) is dependent on the maximum operating junction temperature (T<sub>J-MAX-OP</sub> = 125°C), the maximum power dissipation of the device in the application (P<sub>D-MAX</sub>), and the junction-to ambient thermal resistance of the part/package in the application (θ<sub>JA</sub>), as given by the following equation: T<sub>A-MAX</sub> = T<sub>J-MAX-OP</sub> - (θ<sub>JA</sub> × P<sub>D-MAX</sub>).

### 6.4 Thermal Information

THERMAL METRIC <sup>(1)</sup>		DSBGA (20 PINS)	UNIT
R <sub>θJA</sub>	Thermal resistance junction-to-ambient	55.3	°C/W

- (1) For more information about traditional and new thermal metrics, see the *IC Package Thermal Metrics* application report, [SPRA953](#).

## 6.5 Electrical Characteristics

Limits apply over the full operating ambient temperature range ( $-40^{\circ}\text{C} \leq T_A \leq 85^{\circ}\text{C}$ ) and  $V_{IN} = 3.6\text{ V}$ , unless otherwise specified.<sup>(1)(2)</sup>

PARAMETER		TEST CONDITIONS		MIN	TYP	MAX	UNIT
<b>SUPPLY VOLTAGE (IN PIN)</b>							
$I_{SHDN}$	Shutdown current	$2.7\text{ V} \leq V_{IN} \leq 5.5\text{ V}$ , HWEN = GND			1	5.5	$\mu\text{A}$
<b>THERMAL SHUTDOWN</b>							
$T_{SD}$	Thermal shutdown				140		$^{\circ}\text{C}$
	Hysteresis				15		
<b>BOOST CONVERTER AND HVLED</b>							
$I_{HVLED(1/2/3)}$	Output current regulation (HVLED1, HVLED2 or HVLED3)	Full-scale current = 20.2 mA, PWM off, brightness code = max, exponential mapping, auto headroom off, HVLED1 Bank A, HVLED2/3 Bank B	$2.7\text{ V} \leq V_{IN} \leq 5.5\text{ V}$	18.38 (-9%)	20.2	22.02 (9%)	mA
			$T_A = 25^{\circ}\text{C}$	-3.4%	$\pm 2.0\%$	3.2%	
			$T_A = 25^{\circ}\text{C}$ , $3.0\text{ V} \leq V_{IN} \leq 4.5\text{ V}$	-3.6%		3.4%	
			$T_A = 25^{\circ}\text{C}$		$\pm 2.0\%$		
$I_{MATCH\_HV}$	HVLED1 to HVLED2 or HVLED3 matching <sup>(3)</sup>	PWM off, exponential mapping, auto headroom off HVLED1,2,3 = Bank A,	$2.7\text{ V} \leq V_{IN} \leq 5.5\text{ V}$ , $I_{LED} = 20.2\text{ mA}$	-2.5%		2.5%	
			$T_A = 25^{\circ}\text{C}$ , $I_{LED} = 20.2\text{ mA}$	-2.0%		1.7%	
			$2.7\text{ V} \leq V_{IN} \leq 5.5\text{ V}$ , $I_{LED} = 500\text{ }\mu\text{A}$	-8.5%		8.5%	
$I_{LED\_MIN}$	Minimum LED current	Full-scale current = 20.2 mA, Exponential Mapping			6.0		$\mu\text{A}$
$V_{REG\_CS}$	Regulated current sink headroom voltage	Auto headroom off, $T_A = 25^{\circ}\text{C}$			400		mV
$V_{HR\_HV}$	Minimum current sink headroom voltage for HVLED current sinks	$I_{LED} = 95\%$ of nominal, full-scale current = 20.2 mA, auto headroom off	$2.7\text{ V} \leq V_{IN} \leq 5.5\text{ V}$			285	
			$T_A = 25^{\circ}\text{C}$			190	
$R_{DSON}$	NMOS switch on resistance	$I_{SW} = 500\text{ mA}$ , $T_A = 25^{\circ}\text{C}$			0.3		$\Omega$
$I_{CL\_BOOST}$	NMOS switch current limit			880		1120	mA
		$T_A = 25^{\circ}\text{C}$			1000		
$V_{OVP}$	Output overvoltage protection	ON threshold OVP select bits = 11	$2.7\text{ V} \leq V_{IN} \leq 5.5\text{ V}$	38.75		41.1	V
			$T_A = 25^{\circ}\text{C}$		40		
			Hysteresis	$T_A = 25^{\circ}\text{C}$		1	
$f_{SW}$	Switching frequency	Boost frequency select bit = 0	$2.7\text{ V} \leq V_{IN} \leq 5.5\text{ V}$	450		550	kHz
			$T_A = 25^{\circ}\text{C}$		500		
			$2.7\text{ V} \leq V_{IN} \leq 5.5\text{ V}$	900		1100	
			$T_A = 25^{\circ}\text{C}$		1000		
$D_{MAX}$	Maximum duty cycle	$2.7\text{ V} \leq V_{IN} \leq 5.5\text{ V}$			94%		
<b>CHARGE PUMP AND LVLED</b>							
$I_{LVLED(1/2/3/4/5/6)}$	Output current regulation (low-voltage current sinks)	Full-scale current = 20.2 mA, brightness code = 0xFF	$2.7\text{ V} \leq V_{IN} \leq 5.5\text{ V}$	18.38	20.2	22.02	mA

(1) All voltages are with respect to the potential at the GND pin.

(2) Minimum and Maximum limits are verified by design, test, or statistical analysis. Typical (Typ) numbers are not verified, but do represent the most likely norm. Unless otherwise specified, conditions for typical specifications are:  $V_{IN} = 3.6\text{ V}$  and  $T_A = 25^{\circ}\text{C}$ .

(3) LED current sink matching in the high-voltage current sinks (HVLED1 through HVLED3) is given as the maximum matching value between any two current sinks, where the matching between any two high voltage current sinks (X and Y) is given as  $(I_{HVLEDX} - I_{HVLEDY}) - I_{AVE(X-Y)} / (I_{AVE(X-Y)}) \times 100$ . In this test all three HVLED current sinks are assigned to Bank A.

## Electrical Characteristics (continued)

Limits apply over the full operating ambient temperature range ( $-40^{\circ}\text{C} \leq T_A \leq 85^{\circ}\text{C}$ ) and  $V_{\text{IN}} = 3.6\text{ V}$ , unless otherwise specified.<sup>(1)(2)</sup>

PARAMETER		TEST CONDITIONS		MIN	TYP	MAX	UNIT
$I_{\text{MATCH\_LV}}$	LVLED current sink matching <sup>(4)</sup>	Full-scale current = 20.2 mA	$2.7\text{ V} \leq V_{\text{IN}} \leq 5.5\text{ V}$	-3.1%		2%	
$V_{\text{HR\_LV}}$	Minimum current sink headroom voltage for LVLED current sinks	$I_{\text{LED}} = 95\%$ of nominal, full-scale current = 20.2 mA	$T_A = 25^{\circ}\text{C}$		80	125	mV
$V_{\text{GTH}}$	Threshold for gain transition	$2.7\text{ V} \leq V_{\text{IN}} \leq 5.5\text{ V}$	$T_A = 25^{\circ}\text{C}$	65		190	
$V_{\text{CPOUT}}$	Charge Pump Output Voltage	2X Gain	$T_A = 25^{\circ}\text{C}$		4.42		
$I_{\text{CL\_PUMP}}$	Charge pump current limit	1X Gain, output referred	$3\text{ V} \leq V_{\text{IN}} \leq 5.5\text{ V}$	180	350		mA
		2X Gain	$T_A = 25^{\circ}\text{C}$		240		
$R_{\text{OUT}}$	Charge pump output resistance	1X Gain	$T_A = 25^{\circ}\text{C}$		1.1		$\Omega$
<b>HWEN INPUT</b>							
$V_{\text{HWEN\_L}}$	Logic low	$2.7\text{ V} \leq V_{\text{IN}} \leq 5.5\text{ V}$		0		0.4	V
$V_{\text{HWEN\_H}}$	Logic High	$2.7\text{ V} \leq V_{\text{IN}} \leq 5.5\text{ V}$		1.2		$V_{\text{IN}}$	
<b>PWM INPUT</b>							
$V_{\text{PWM\_L}}$	Input logic low	$2.7\text{ V} \leq V_{\text{IN}} \leq 5.5\text{ V}$		0		400	mV
$V_{\text{PWM\_H}}$	Input logic high	$2.7\text{ V} \leq V_{\text{IN}} \leq 5.5\text{ V}$		1.36		$V_{\text{IN}}$	
$t_{\text{PWM}}$	Minimum PWM input pulse	$2.7\text{ V} \leq V_{\text{IN}} \leq 5.5\text{ V}$ , PWM Zero Detect Enabled				0.75	$\mu\text{s}$
<b>I<sup>2</sup>C-COMPATIBLE VOLTAGE SPECIFICATIONS (SCL, SDA)</b>							
$V_{\text{IL}}$	Input logic low	$2.7\text{ V} \leq V_{\text{IN}} \leq 5.5\text{ V}$		0		400	mV
$V_{\text{IH}}$	Input logic high	$2.7\text{ V} \leq V_{\text{IN}} \leq 5.5\text{ V}$		1.35		$V_{\text{IN}}$	V
$V_{\text{OL}}$	Output logic low (SDA)	$2.7\text{ V} \leq V_{\text{IN}} \leq 5.5\text{ V}$ , $I_{\text{LOAD}} = 3\text{ mA}$				400	mV

- (4) LED current sink matching in the low-voltage current sinks (LVLED1 through LVLED3 or LVLED4 through LVLED6) is given as the maximum matching value between any two current sinks, where the matching between any two low voltage current sinks (X and Y) is given as  $(I_{\text{LVLEDX}} \text{ ( or } I_{\text{LVLEDY}}) - I_{\text{AVE(X-Y)}}) / (I_{\text{AVE(X-Y)}}) \times 100$ . In this test LVLED1-3 current sinks are assigned to Bank C and LVLED4-6 are assigned to Bank F.

## 6.6 Timing Requirements

Limits apply over the full operating ambient temperature range ( $-40^{\circ}\text{C} \leq T_A \leq 85^{\circ}\text{C}$ ) and  $V_{IN} = 3.6\text{ V}$ , unless otherwise specified.<sup>(1)(2)</sup>

PARAMETER	TEST CONDITIONS	MIN	TYP	MAX	UNIT
<b>I<sup>2</sup>C-COMPATIBLE TIMING SPECIFICATIONS (SCL, SDA)<sup>(3)</sup>, Figure 1</b>					
$t_1$	SCL (Clock Period)	$2.7\text{ V} \leq V_{IN} \leq 5.5\text{ V}$		2.5	$\mu\text{s}$
$t_2$	Data In setup time to SCL high	$2.7\text{ V} \leq V_{IN} \leq 5.5\text{ V}$		100	ns
$t_3$	Data out stable after SCL low	$2.7\text{ V} \leq V_{IN} \leq 5.5\text{ V}$		0	
$t_4$	SDA low setup time to SCL low (Start)	$2.7\text{ V} \leq V_{IN} \leq 5.5\text{ V}$		100	
$t_5$	SDA high hold time after SCL high (Stop)	$2.7\text{ V} \leq V_{IN} \leq 5.5\text{ V}$		100	
<b>INTERNAL POR THRESHOLD AND HWEN TIMING SPECIFICATION</b>					
$V_{POR}$	POR reset release voltage threshold	VIN ramp time = 100 $\mu\text{s}$	1.7	2.1	V
		VIN ramp time = 100 $\mu\text{s}$ , $T_A = 25^{\circ}\text{C}$	1.9		
$t_{HWEN}$	First I <sup>2</sup> C start pulse after HWEN high	POR reset complete, $2.7\text{ V} \leq V_{IN} \leq 5.5\text{ V}$	20		$\mu\text{s}$
		POR reset complete, $T_A = 25^{\circ}\text{C}$	5		

- (1) All voltages are with respect to the potential at the GND pin.
- (2) Minimum and Maximum limits are verified by design, test, or statistical analysis. Typical (Typ) numbers are not verified, but do represent the most likely norm. Unless otherwise specified, conditions for typical specifications are:  $V_{IN} = 3.6\text{ V}$  and  $T_A = 25^{\circ}\text{C}$ .
- (3) SCL and SDA must be glitch-free in order for proper brightness control to be realized.

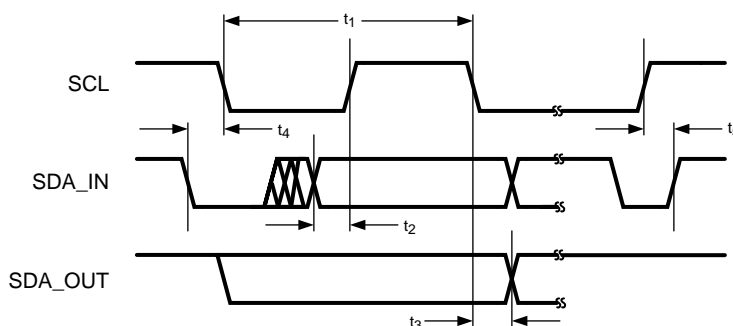

Figure 1. I<sup>2</sup>C-Compatible Interface Timing

## 6.7 Typical Characteristics

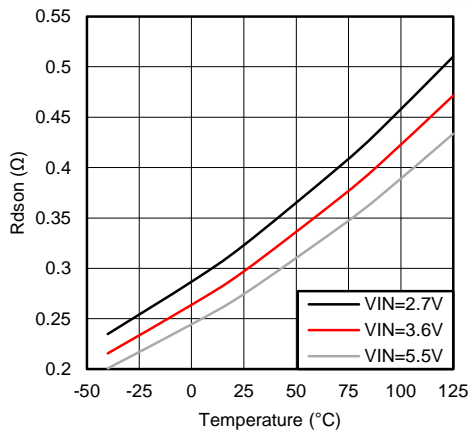

Figure 2. NMOS  $R_{DSON}$  vs Temperature

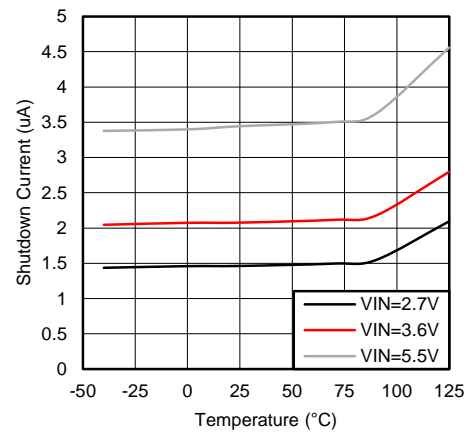

Figure 3. Shutdown  $I_Q$  vs Temperature

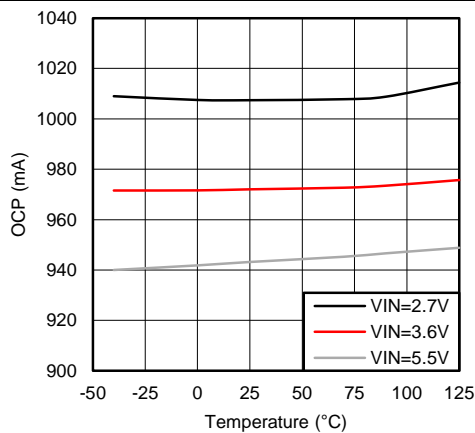

Figure 4. Boost OCP vs Temperature

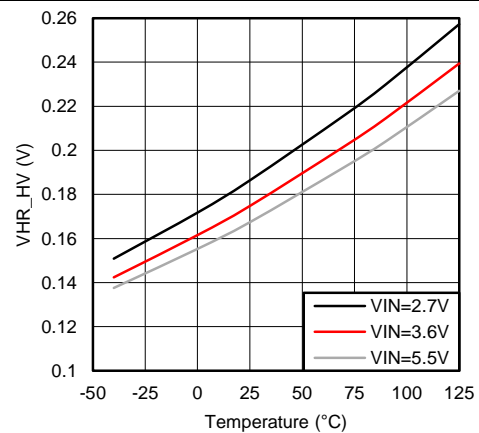

Figure 5.  $V_{HR\_HV}$  vs Temperature

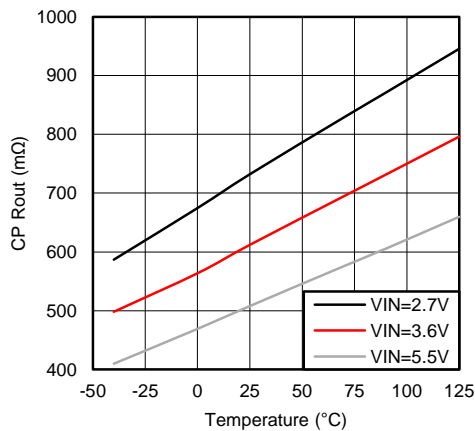

Figure 6. Charge Pump  $R_{OUT}$  vs Temperature

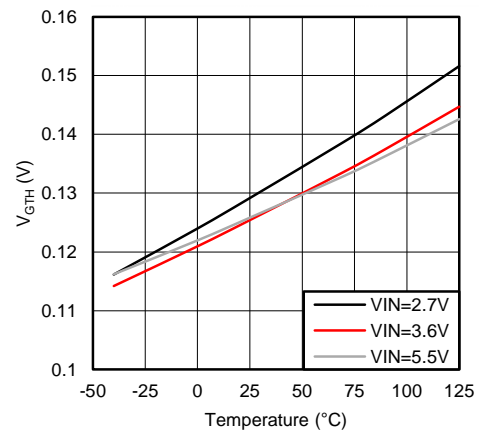

Figure 7. Low Voltage LED  $V_{GTH}$  vs Temperature



Typical Characteristics (continued)

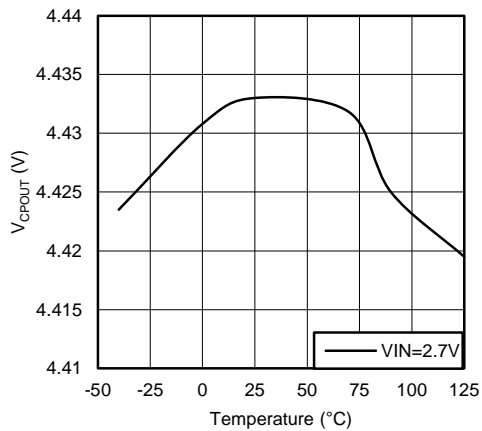

Figure 8. Charge Pump 2X Mode V<sub>CPOUT</sub> vs Temperature

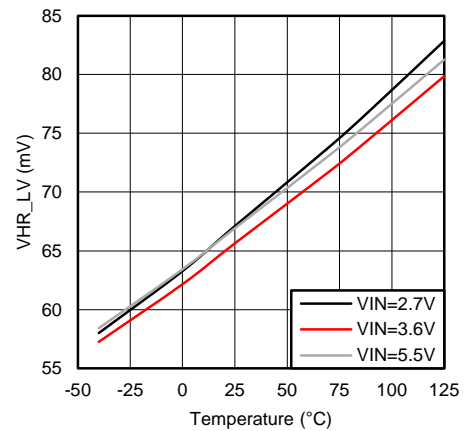

Figure 9. V<sub>HR\_LV</sub> vs Temperature

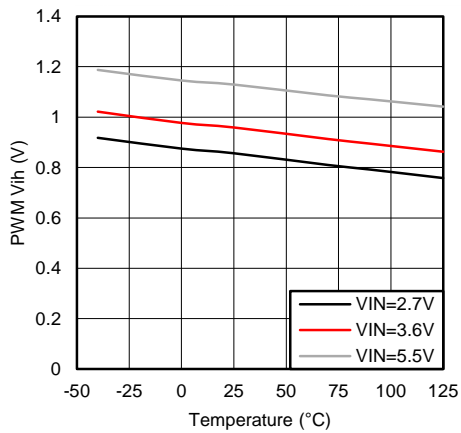

Figure 10. PWM V<sub>IH</sub> vs Temperature

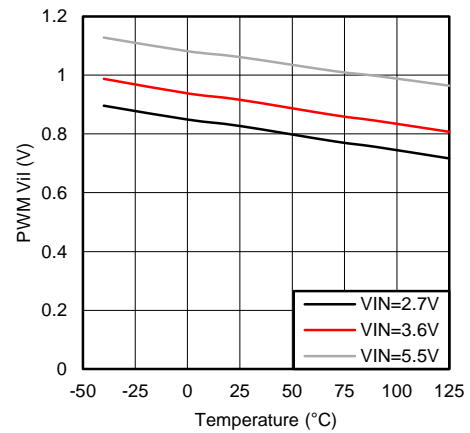

Figure 11. PWM V<sub>IL</sub> vs Temperature

## 7 Detailed Description

### 7.1 Overview

The LM3633 provides the power for three high-voltage LED strings and six low-voltage LEDs. The three high-voltage LED strings are powered from an integrated boost converter. The six low-voltage LEDs are powered from an integrated 2X charge pump. The device is programmable over an I<sup>2</sup>C-compatible interface. Additional features include a Pulse Width Modulation (PWM) input for content adjustable brightness control and 6 programmable pattern generators for RGB and indicator blinking functions on the low-voltage LEDs.

### 7.2 Functional Block Diagram

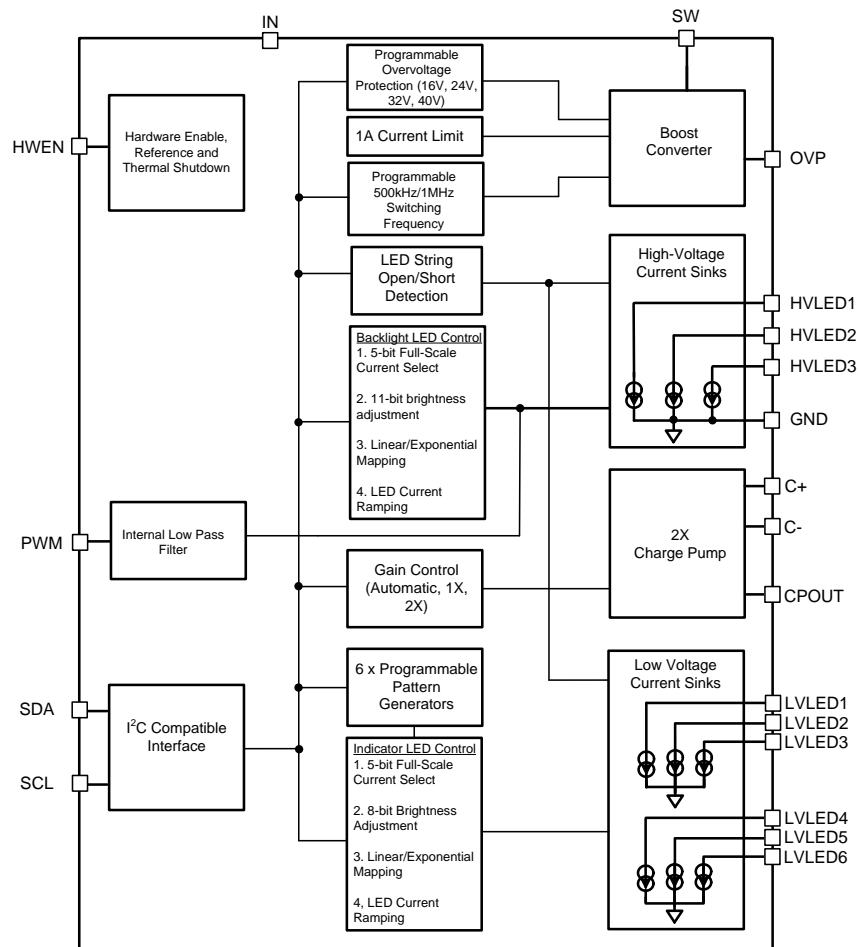

### 7.3 Feature Description

#### 7.3.1 Control Bank Mapping

Control of the LM3633's current sinks is not done directly, but through the programming of Control Banks. The current sinks are then assigned to the programmed Control Bank. This allows a wide variety of current control possibilities where LEDs can be grouped and controlled via specific Control Banks (see [Figure 12](#) and [Figure 17](#)).

## Feature Description (continued)

### 7.3.1.1 High-Voltage Control Banks (A and B)

There are 2 high-voltage control banks (A and B). All three high-voltage current sinks can be assigned to either Control Bank A or Control Bank B. Assigning all three current sinks to the same control bank allows for better LED current matching. Assigning a current sink to a different control bank allows for independent current sink programming. The high-voltage control bank mapping is done via bits [2:0] of the HVLED Current Sink Output Configuration register (see [Table 5](#)).

### 7.3.1.2 Low-Voltage Control Banks (C, D, E, F, G, and H)

There are 6 low-voltage control banks (C, D, E, F, G, and H). LVLED1 to LVLED3 can be assigned to control bank C or can be assigned to independent control banks (LVLED2 to Control Bank D and LVLED3 to Control Bank E). LVLED4 to LVLED6 can be assigned to control bank F or can be assigned to independent control banks (LVLED5 to Control Bank G and LVLED6 to Control Bank H). Assigning low-voltage current sinks to the same control bank allows for the best matching between LEDs. Assigning low-voltage current sinks to different control banks allows for each current sink to be programmed with different current levels. When the pattern generator is disabled the low-voltage ramp up/down times (Start-up/Shutdown and Run-Time) are controlled by the LVLED Controls C to E and Controls F to H Ramp Time register (see [Table 11](#)).

### 7.3.2 Pattern Generator

The LM3633 contains 6 independently programmable pattern generators for each low-voltage control bank. Each pattern generator can have its own separate pattern: delays from turnon, high and low-current settings, and pattern high and low times. There are two sets of rise and fall time control registers. One set is assigned to Control Banks C to E and the other set is assigned to Control Banks F to H. All other settings are independent (see [Figure 17](#)).

### 7.3.3 PWM Input

The PWM input which can be assigned to either of the high-voltage control banks. When assigned to a control bank, the programmed current in the control bank becomes a function of the duty cycle ( $D_{PWM}$ ) at the PWM input and the control bank brightness setting. When PWM is disabled,  $D_{PWM}$  is equal to one.

### 7.3.4 HWEN Input

HWEN is the global hardware enable to the LM3633. HWEN must be pulled high to enable the device. HWEN is a high-impedance input so it cannot be left floating. When HWEN is pulled low, the LM3633 is placed in shutdown, and all the registers are reset to their default state.

### 7.3.5 Thermal Shutdown

The LM3633 contains a thermal shutdown protection. In the event the die temperature reaches 140°C (typ), the boost, charge pump, and current sinks shut down until the die temperature drops to typically 125°C (typ).

## 7.4 Device Functional Modes

### 7.4.1 High-Voltage LED Control

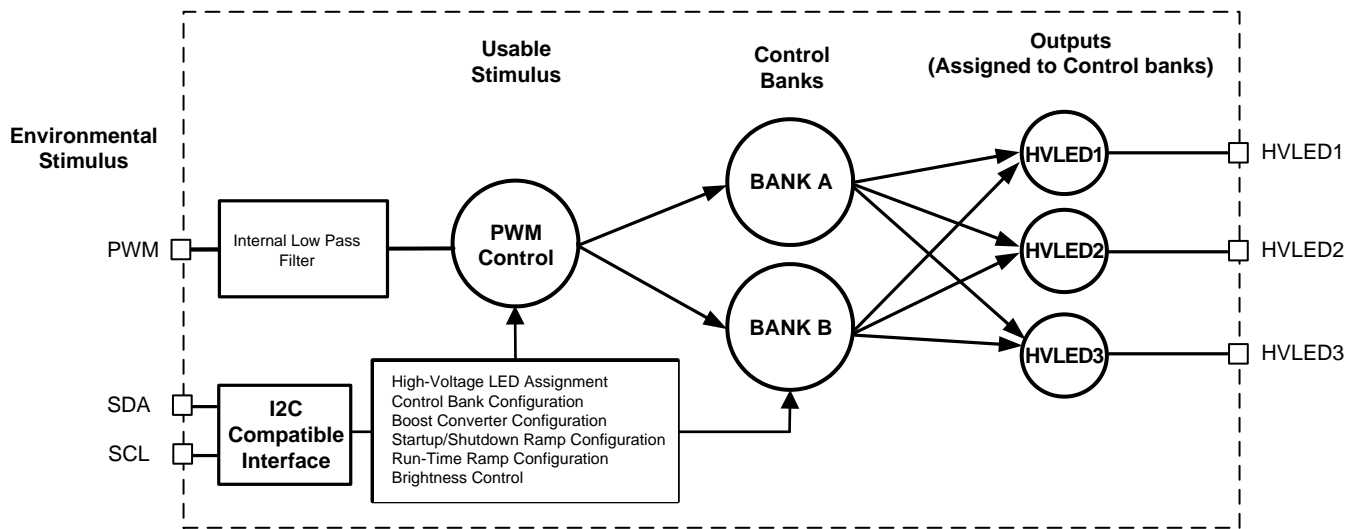

Figure 12. High-Voltage Functional Control Diagram

#### 7.4.1.1 High-Voltage Boost Converter

The high-voltage boost converter provides power for the three high-voltage current sinks (HVLED1, HVLED2 and HVLED3). The boost circuit operates using a 4.7- $\mu$ H to 22- $\mu$ H inductor and a 1- $\mu$ F output capacitor. The selectable 500-kHz or 1-MHz switching frequency allows for use of small external components and provides for high boost-converter efficiency. HVLED1, HVLED2, and HVLED3 feature an adaptive current regulation scheme where the feedback point (HVLED1, HVLED2, and HVLED3) regulates the LED headroom voltage to  $V_{HR\_HV}$ . When there are different voltage requirements in the high-voltage LED strings (string mismatch), the LM3633 regulates the feedback point of the highest voltage string to  $V_{HR\_HV}$  and drops the excess voltage of the lower-voltage string across the lower string(s) current sink.

#### 7.4.1.2 High-Voltage Current Sinks (HVLED1, HVLED2 and HVLED3)

HVLED1, HVLED2, and HVLED3 control the current in the high-voltage LED strings as configured by Control Bank A or Control Bank B. Each Control Bank has 5-bit full-scale current programmability and 11-bit brightness control. High-voltage current sinks are assigned to a control bank through the HVLED Current Sink Output Configuration register (see [Table 5](#)).

#### 7.4.1.3 High-Voltage Current String Biasing

Each high-voltage current string can be powered from the LM3633 boost output ( $C_{OUT}$ ) or from an external source. The feedback enable bits (HVLED Current Sink Feedback Enables register bits [2:0]) determine where the high-voltage current string anodes are connected. When set to '1' (default) the high-voltage current sink inputs are included in the boost feedback loop. This allows the boost converter to adjust its output voltage to maintain the LED headroom voltage  $V_{HR\_HV}$  at the current sink input.

When powered from alternate sources the feedback enable bits should be set to '0'. This removes the particular current sink from the boost feedback loop. In these configurations the application must ensure that the headroom voltage across the high-voltage current sink is high enough to prevent the current sink from going into dropout (see the [Figure 63](#) for data on the high-voltage LED current vs  $V_{HR\_HV}$ ).

Setting the HVLED Current Sink Feedback Enables register bits also determines triggering of the shorted high-voltage LED String Fault flag (see [Fault Flags/Protection Features](#) section).

## Device Functional Modes (continued)

### 7.4.1.4 Boost Switching-Frequency Select

The LM3633 boost converter has two switching frequency settings. The switching frequency setting is controlled via the Boost Frequency Select bit (bit 0 in the Boost Control register). Operating at the 500-kHz switching frequency results in better efficiency under lighter load conditions due to the decreased switching losses. In this mode the inductor must be between 10  $\mu\text{H}$  and 22  $\mu\text{H}$ . Operating at the 1-MHz switching frequency results in better efficiency under higher load conditions due to in lower conduction losses in the MOSFETs and inductor. In this mode the inductor can be between 4.7  $\mu\text{H}$  and 22  $\mu\text{H}$ .

### 7.4.1.5 Automatic Switching Frequency Shift

The LM3633 has an automatic frequency-select mode (bit 3 in the Boost Control register) to optimize the frequency vs load dependent losses. In Auto-Frequency mode the boost converter switching frequency is changed based on the high-voltage LED current. The threshold (Control A and Control B brightness code) at which the frequency switchover occurs is programmable via the Auto-Frequency Threshold register. The Auto-Frequency Threshold register contains an 8-bit code which is compared to the 8 MSBs of the brightness code. When the brightness code is greater than the Auto-Frequency Threshold value the boost converter switching frequency is 1 MHz. When the brightness code is less than or equal to the Auto-Frequency Threshold register the boost converter switching frequency is 500 kHz. The default value in the Auto-Frequency Threshold register is set for the default full-scale current setting (20.2 mA).

Figure 13 shows the LED efficiency improvement (3p5s LED configuration with a 4.7- $\mu\text{H}$  inductor) when the auto-frequency feature is enabled. When the LED brightness is less than or equal to 0x6C, the switching frequency is 500 kHz, and it improves the LED efficiency by up to 6%. When the LED brightness is greater than 0x6C, the switching frequency is 1 MHz, and it improves LED efficiency by up to 2.2%.

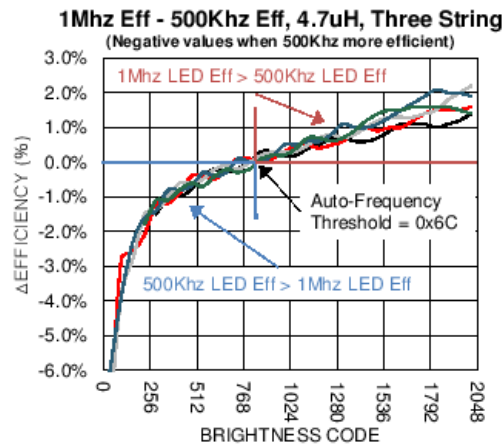

Figure 13. Auto-Frequency Boost Efficiency Improvement

Table 1 summarizes the general recommendations for auto-frequency threshold setting vs inductance values and LED string configurations. These are general recommendations — the optimum auto-frequency threshold setting should be evaluated for each application

Table 1. Auto-Frequency Threshold Settings

INDUCTOR ( $\mu\text{H}$ )	THREE STRING			TWO STRING		
	AUTO-FREQUENCY THRESHOLD	PEAK EFFICIENCY IMPROVEMENT (%)	PEAK CONFIGURATION	AUTO-FREQUENCY THRESHOLD	PEAK EFFICIENCY IMPROVEMENT (%)	PEAK CONFIGURATION
4.7	6C	2.2	3p5s	AC	1.1	2p6s
10	74	1.7	3p4s	B4	1.3	2p5s
22	7C	0.7	3p3s	BC	0.7	2p4s

### 7.4.1.6 Brightness Register Current Control

The Brightness Register Current Control allows simple user-adjustable current control by writing directly to the appropriate control bank brightness register. The current for Control Bank A and B is a function of the full-scale LED current, the 11-bit code in the respective brightness register, and the PWM input duty cycle (if PWM is enabled). The Control Bank A and B brightness should always be written with LSBs first and MSBs last.

#### 7.4.1.6.1 8-Bit Control (Preferred)

The preferred operating mode is to control the high-voltage LED brightness by setting the Control Bank LSB register (3 LSBs) to zero, using only the Control Bank MSB register (8 MSBs). In 8-bit control mode the LM3633 controls the 3 LSBs to ramp the high-voltage LED current using all 11 bits.

#### 7.4.1.6.2 11-Bit Control

In this mode of operation, both Control Bank LSB and MSB registers must be written whenever a change in Brightness is required. The high-voltage LED current does not change until the Control Bank MSB register is written. If the brightness change affects only the 3 LSBs, the Control Bank MSB register (8 MSBs) must be rewritten to change the high-voltage LED current.

### 7.4.1.7 PWM Control

The LM3633 PWM input can be enabled for Control Bank A or B (see Table 21). Once enabled, the LED current becomes a function of the code in the Control Brightness registers and the PWM input-duty cycle.

The PWM input accepts a logic level voltage and internally filters it to an analog-control voltage. This results in a linear response of duty cycle to current, where 100% duty cycle corresponds to the programmed brightness code multiplied by the Full-Scale Current setting.

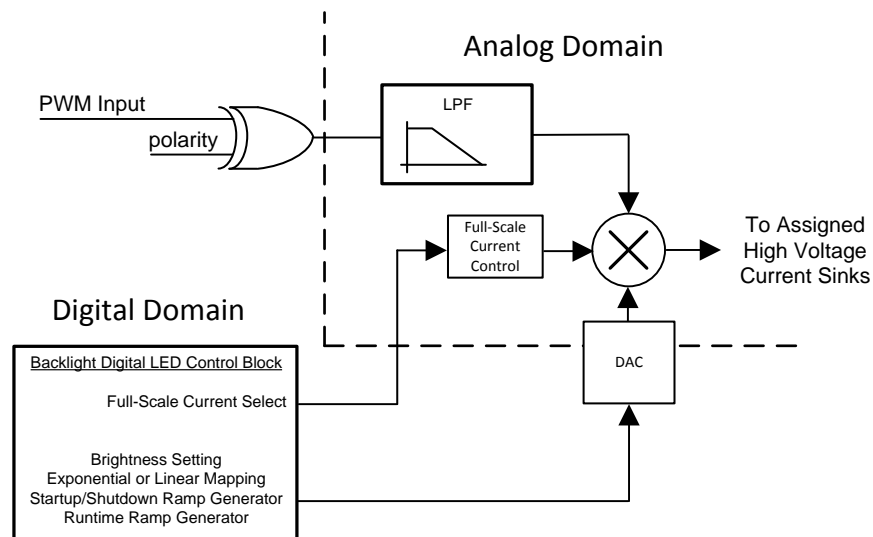

Figure 14. PWM Input Architecture

#### 7.4.1.7.1 PWM Input Frequency Range

The usable input frequency range for the PWM input is governed on the low end by the cutoff frequency of the internal low-pass filter (540 Hz, Q = 0.33) and on the high end by the propagation delays through the internal logic. For frequencies below 2 kHz the current ripple begins to become a larger portion of the DC LED current. Additionally, at lower PWM frequencies the boost output voltage ripple increases, causing a non-linear response from the PWM duty cycle to the average LED current due to the response time of the boost and current-sink dropout. For the best response of current vs. duty cycle, the PWM input frequency should be kept between 2 kHz and 100 kHz.

#### 7.4.1.7.2 PWM Input Polarity

The PWM Input can be set for active low polarity, where the LED current is a function of the negative duty cycle. This is set via the PWM Configuration register (see [Table 21](#)).

#### 7.4.1.7.3 PWM Zero Detection

The LM3633 incorporates a feature to detect when the PWM input is near zero. When this feature is enabled the minimum PWM input pulse must be greater than  $t_{P_{PWM}}$  (see [Electrical Characteristics](#)). Bit 3 in the PWM Configuration register is used to enable or disable PWM zero detection.

#### 7.4.1.8 Start-up/Shutdown Ramp

The high-voltage LED start-up and shutdown ramp times are independently programmable in the Control A and Control B Start-Up/Shutdown Ramp Time register (see [Table 7](#)). There are 16 different start-up and 16 different shutdown times. The start-up times can be programmed independently from the shutdown times, but each Control bank is not independently programmable.

The start-up ramp time is the period from when the Control Bank is enabled to when the LED current reaches its initial set point. The shutdown ramp time is the period from when the Control Bank is disabled to when the LED current reaches 0.

#### 7.4.1.9 Run-Time Ramp

Current ramping from one brightness level to the next is programmed via the Control A and Control B Run-Time Transition Time register (see [Table 9](#)). There are 16 different ramp-up times and 16 different ramp-down times. The ramp-up time can be programmed independently from the ramp-down time, but each Control Bank cannot be independently programmed. For example, programming a ramp-up or ramp-down time is a global setting for all high-voltage LED Control Banks.

#### 7.4.1.10 High-Voltage Control A/B Ramp Select

The LM3633 provides three options for configuring Control A and Control B ramp times. When the run-time ramp select bits are set to 00 the control bank uses both the start-up/shutdown and run-time ramp times. When the run-time ramp select bits are set to 01 the control bank uses the start-up/shutdown ramp times for both startup/shutdown and run-time. When the run-time ramp select bits are set to 1x the control bank uses a zero  $\mu$ sec run-time ramp.

#### 7.4.1.11 LED Current Mapping Modes

All control banks can be programmed for either exponential or linear mapping modes (see [Figure 19](#)). These modes determine the transfer characteristic of backlight code to LED current. Independent mapping of Control Bank A and B is not allowed; both banks use the same mapping mode.

#### 7.4.1.12 Exponential Mapping

In Exponential Mapping Mode the current ramp (either up or down) appears to the human eye as a more uniform transition than the linear ramp. This is due to the logarithmic response of the eye.

##### 7.4.1.12.1 8-Bit Code Calculation

In 8-bit Exponential Mapping Mode the brightness code-to-backlight current transfer function is given by the equation:

$$I_{LED} = I_{LED\_FULLSCALE} \times 0.85 \left( 44 - \frac{Code + 1}{5.8181818} \right) \times D_{PWM} \quad (1)$$

Where  $I_{LED\_FULLSCALE}$  is the full-scale LED current setting (see [Table 13](#)), Code is the 8-bit brightness code in the Control Brightness MSB register and  $D_{PWM}$  is the PWM Duty Cycle.

##### 7.4.1.12.2 11-Bit Code Calculation

In 11-bit Exponential Mapping Mode the brightness code-to-backlight current transfer function is given by the equation:

$$I_{LED} = I_{LED\_FULLSCALE} \times 0.85 \left( 44 - \frac{\text{Code}}{5.8181818} + 1 \right) \times D_{PWM} \quad (2)$$

Where  $I_{LED\_FULLSCALE}$  is the full-scale LED current setting (see [Table 13](#)), Code is the 11-bit brightness code in the Control Brightness MSB and LSB registers and  $D_{PWM}$  is the PWM Duty Cycle.

#### 7.4.1.13 Linear Mapping

In Linear Mapping Mode the brightness code-to-backlight current has a linear relationship.

##### 7.4.1.13.1 8-Bit Code Calculation

In Linear Mapping Mode the brightness code-to-backlight current has a linear relationship and follows the equation:

$$I_{LED} = I_{LED\_FULLSCALE} \times \frac{1}{255} \times \text{Code} \times D_{PWM} \quad (3)$$

Where  $I_{LED\_FULLSCALE}$  is the full-scale LED current setting, Code is the 8-bit brightness code in the Control Brightness MSB register and  $D_{PWM}$  is the PWM Duty Cycle.

##### 7.4.1.13.2 11-Bit Code Calculation

In Linear Mapping Mode the brightness code-to-backlight current has a linear relationship and follows the equation:

$$I_{LED} = I_{LED\_FULLSCALE} \times \frac{1}{2047} \times \text{Code} \times D_{PWM} \quad (4)$$

Where  $I_{LED\_FULLSCALE}$  is the full-scale LED current setting, Code is the 11-bit brightness code in the Control Brightness MSB and LSB registers and  $D_{PWM}$  is the PWM Duty Cycle.

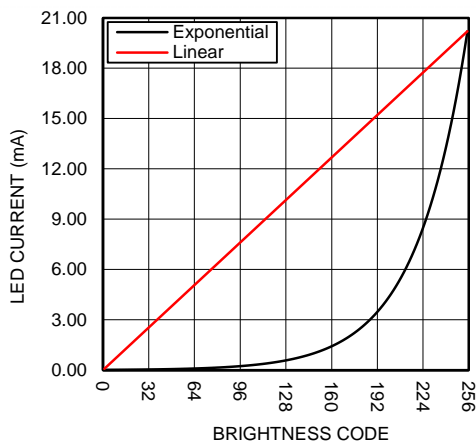

Figure 15. LED Current Mapping Modes (8-bit)

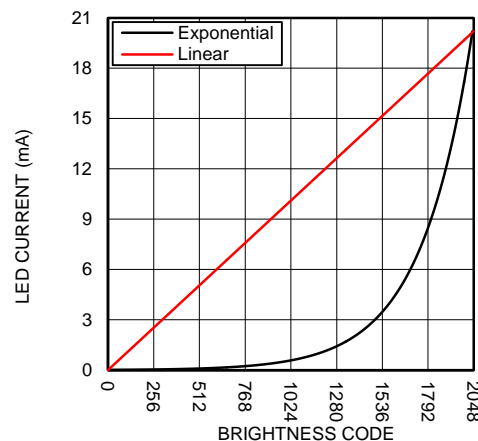

Figure 16. LED Current Mapping Modes (11-bit)



## 7.4.2 Low-Voltage LED Control

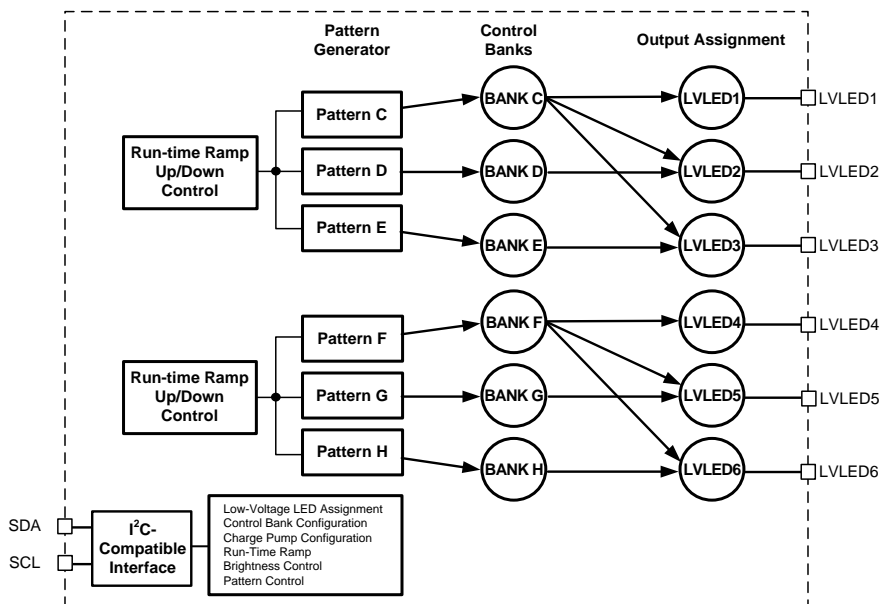

Figure 17. Low-Voltage LED Functional Control Diagram

### 7.4.2.1 Integrated Charge Pump

The LM3633 features an integrated (2X/1X) charge pump capable of supplying LVLED1 to LVLED6 current. The fixed 1-MHz switching frequency allows for use of tiny 1- $\mu$ F ceramic flying capacitors (CP) and output capacitor (CPOUT). The charge pump can supply the power for the low-voltage LEDs connected to LVLED1 to LVLED6 and can operate in 4 different modes: disabled, automatic gain, 1X gain, or 2X gain (see Figure 18).

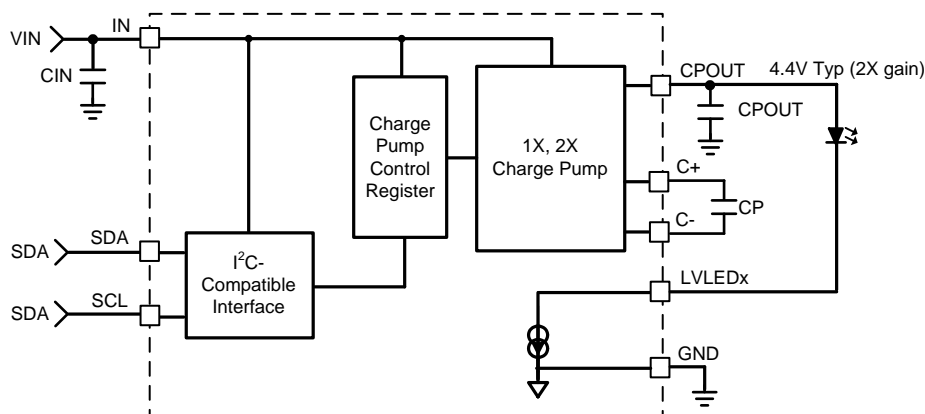

Figure 18. Integrated Charge Pump

### 7.4.2.2 Charge Pump Disabled

With the charge pump disabled, the path from IN to CPOUT is high impedance. Additionally, with the charge pump disabled, the low-voltage current sinks can still be active, thus allowing the low-voltage LEDs to be biased from external sources (see [Low-Voltage LED Biasing](#) section). Disabling the charge pump also has no influence on the state of the low-voltage current sinks. For instance, if a low-voltage current string is set to have its anode connected to CPOUT, and the charge pump is disabled, the current sink continues to try to sink current.

### 7.4.2.3 Automatic Gain

In Automatic Gain Mode the charge-pump-gain transition is actively selected to maintain LED current regulation in the CPOUT-connected, low-voltage current sinks. At higher input voltages the charge pump operates in Pass Mode (1x gain) allowing the voltage at CPOUT to track the input voltage. As  $V_{IN}$  drops, the voltage on the low-voltage current sink(s) drops also. Once any of the active, CPOUT-connected, low-voltage current sink input voltages reach  $V_{HR\_LV}$  (see [Electrical Characteristics](#)), the charge pump automatically switches to a gain of 2x thus preventing dropout (see [2X Gain](#)). Once the charge pump switches over to 2X gain it remains in 2X gain until the active low-voltage current sinks are turned off (enable bit or brightness code 0), even if the current sink input voltage goes above the switch over threshold.

### 7.4.2.4 Automatic Gain (Flying Capacitor Detection)

In Automatic Gain Mode the LM3633 starts up and automatically detects if there is a flying capacitor (CP) connected between C+ and C-. If there is, Automatic Gain Mode operates normally. If the detection circuitry does not detect a connected flying capacitor, the LM3633 automatically switches to 1X Gain mode.

### 7.4.2.5 1X Gain

In 1X Gain Mode the charge pump passes  $V_{IN}$  directly through to the output capacitor (CPOUT). There is a resistive drop between IN and CPOUT in the 1X Gain Mode (typically 1.1  $\Omega$ ) which should be accounted for when determining the headroom requirement for the low-voltage current sinks. In forced 1X Gain Mode the charge pump does not switch; thus, the CP and CPOUT can be omitted from the circuit.

### 7.4.2.6 2X Gain

In 2X Gain Mode the internal charge pump doubles  $V_{IN}$  and post-regulates CPOUT to, typically, 4.4 V. This allows for biasing LEDs whose forward voltages are greater than the input supply ( $V_{IN}$ ).

### 7.4.2.7 Low-Voltage Current Sinks (LVLED1 to LVLED6)

Low-voltage current sinks LVLED1 to LVLED6 each provide the current for a single LED as configured via Control Banks C to H. Each control bank has 8-bit brightness control and 5-bit full-scale current programmability. The low-voltage current sinks can be controlled directly through a dedicated brightness register or with different blinking patterns via the 6 internal pattern generators. Configuration of the low-voltage current sinks is done through the low-voltage Control Bank C to H (LVLED1, LVLED2, and LVLED3 to Control Bank C to E and LVLED4, LVLED5, and LVLED6 to Control Bank F to H). (See [Table 6](#).)

### 7.4.2.8 Low-Voltage LED Biasing

Each low-voltage LED can be powered from the LM3633 charge pump output (CPOUT) or from an external source. When powered from CPOUT the feedback enable bit (LVLED Current Sink Feedback Enables Register bits [5:0]) for that particular low-voltage current sink must be set to '1' (default). This allows for the specific low-voltage current sink to have control over the charge pumps gain control (see [Automatic Gain](#) section).

When powered from alternate sources (such as  $V_{IN}$ ) the feedback enable bit for the particular low-voltage current sink must be set to '0'. This removes the particular current sink from the charge pump feedback loop. In these configurations the application must ensure that the headroom voltage across the low-voltage current sink is high enough to prevent the low-voltage current sinks from going into dropout (see [Figure 64](#) for data on the low-voltage LED current vs headroom voltage).

The LVLEDX feedback enable bits also determine how the shorted low-voltage LED String fault flag is triggered (see [Fault Flags/Protection Features](#)).

### 7.4.2.9 Brightness Register Current Control

The LM3633 features brightness register current control for simple user-adjustable current control set by writing directly to the appropriate Control Bank Brightness Registers. The current for the low-voltage LED Control Bank C to H is a function of the full-scale LED current and the 8-bit code in the respective brightness register. The control bank brightness register code represents the percentage of the full-scale LED current. This percentage of full-scale current is different depending on the selected mapping mode (see [Table 12](#)).

### 7.4.2.10 LED Current Mapping Modes

All control banks can be programmed for either exponential or linear mapping modes (see Figure 19). These modes determine the transfer characteristic of brightness code to LED current. All low-voltage control banks use the same mapping mode.

#### 7.4.2.11 Exponential Mapping

In Exponential Mapping Mode the current ramp (either up or down) appears to the human eye as a more uniform transition than the linear ramp. This is due to the logarithmic response of the eye.

In Exponential Mapping Mode the brightness code-to-current transfer function is given by the equation:

$$I_{LED} = I_{LED\_FULLSCALE} \times 0.85^{\left(44 - \frac{Code + 1}{5.8181818}\right)} \quad (5)$$

Where  $I_{LED\_FULLSCALE}$  is the full-scale LED current setting (see Table 13) and Code is the brightness code in the brightness register.

#### 7.4.2.12 Linear Mapping

In Linear Mapping Mode the brightness code-to-current has a linear relationship and follows the equation:

$$I_{LED} = I_{LED\_FULLSCALE} \times \frac{1}{255} \times Code \quad (6)$$

Where  $I_{LED\_FULLSCALE}$  is the full-scale LED current setting and Code is the brightness code in the brightness register.

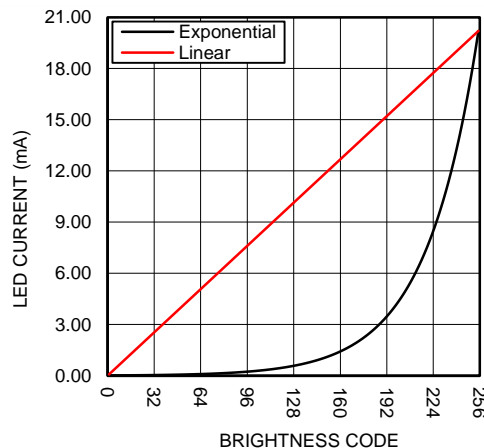

Figure 19. LED Current Mapping Modes

#### 7.4.2.13 Start-up/Shutdown Ramp

The start-up and shutdown ramp times are independently programmable in the Control C to Control H Start-Up/Shutdown Ramp-Time registers (see Table 8). There are 8 different start-up and 8 different shutdown times. The start-up times can be programmed independently from the shutdown times. The start-up ramp time is from when the Control Bank is enabled to when the LED current reaches its initial set point. The shutdown ramp time is from when the Control Bank is disabled to when the LED current reaches 0.

#### 7.4.2.14 Run-Time Ramp

Current ramping from one brightness level to the next is programmed via the Control C to E and Control F to H Ramp-Time registers (see Table 11). There are 8 different ramp-up times and 8 different ramp-down times. The ramp-up time can be programmed independently from the ramp-down time, but each Control Bank cannot be independently programmed. There is one ramp time register which is common to Control Bank C to E and one ramp time register which is common to Control Bank F to H. This register sets the ramp-up and ramp-down times for both direct brightness control and pattern generator modes of operation.

### 7.4.3 Low-Voltage LED Pattern Generator

The LM3633 contains 6 programmable pattern generators (one for each low-voltage control bank). Each pattern generator has the ability to drive a unique programmable pattern. Each pattern generator has its own set of registers available for pattern programming. The programmable patterns are : delay time, high period, low period, high brightness, and low brightness (see [Figure 20](#)). The ramp-up and ramp-down times are controlled by the Control C to E and Control F to H Ramp-Time register. (See [Table 11](#).)

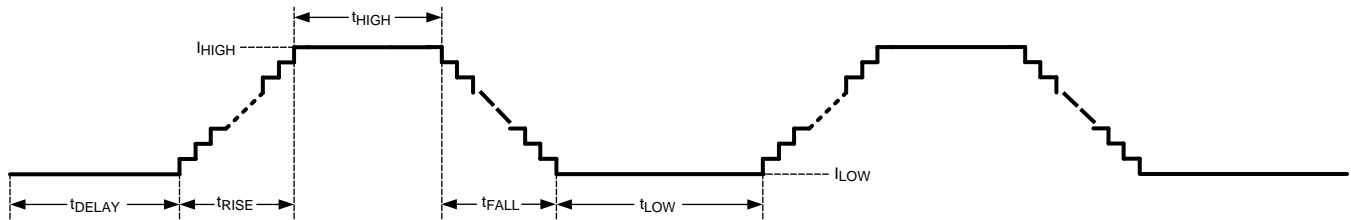

**Figure 20. Pattern Generator Timing**

#### 7.4.3.1 Delay Time

The delay time ( $t_{\text{DELAY}}$ ) is the delay from when the pattern is enabled to when the LED current begins ramping up in the control bank assigned current source(s). The pattern starts when the respective Control Bank Enable register is written high if the Pattern Generator is enabled. There is one  $t_{\text{DELAY}}$  register for each pattern generator (6 total). The selectable times are programmed with the lower 6 bits of the  $t_{\text{DELAY}}$  registers. The times are split into 2 groups where codes 0x00 to 0x3C are short durations from 16.384 ms (code 0x00) up to 999.424 ms (code 0x3C) or 16.384 ms/bit. The higher codes (0x3D to 0x7F) select  $t_{\text{DELAY}}$  from 1130.496 ms up to 9781.248 ms, or 131.072 ms/bit (see [Table 27](#)).

#### 7.4.3.2 Rise Time

The LED current rise time ( $t_{\text{RISE}}$ ) is the time the LED current takes to move from the low-current brightness level ( $I_{\text{LOW}}$ ) to the high-current brightness level ( $I_{\text{HIGH}}$ ). The rise time of the LED current ( $t_{\text{RISE}}$ ) is set via the Control C to E and Control F to H Ramp-Time registers. There are 8 available ramp-up time settings (see [Table 11](#)). There is one ramp-time register which is common to Control Bank C to E and one ramp-time register which is common to Control Bank F to H.

#### 7.4.3.3 Fall Time

The LED current fall time ( $t_{\text{FALL}}$ ) is the time the LED current takes to move from the high-current brightness level ( $I_{\text{HIGH}}$ ) to the low-current brightness level ( $I_{\text{LOW}}$ ). The fall time of the LED current ( $t_{\text{FALL}}$ ) is set via the Control C to E and Control F to H Ramp Time registers. There are 8 available ramp-down settings (see [Table 11](#)). There is one ramp-time register which is common to Control Bank C to E and one ramp-time register which is common to Control Bank F to H.

#### 7.4.3.4 High Period

The LED current high period ( $t_{\text{HIGH}}$ ) is the duration that the LED pattern spends at the high LED current set point ( $t_{\text{HIGH}}$ ). The  $t_{\text{HIGH}}$  times are programmed via the Pattern Generator High-Time registers. The programmable times are broken into 2 groups. The first set (from code 0x00 to 0x3C) increases the  $t_{\text{HIGH}}$  time in steps of 16.384 ms. The second set (from code 0x3D to 0x7F) increases the  $t_{\text{HIGH}}$  time in steps of 131.072 ms (see [Table 29](#)).

#### 7.4.3.5 Low Period

The LED current low period ( $t_{\text{LOW}}$ ) is the duration that the LED current spends at the low LED current set point ( $I_{\text{LOW}}$ ). The  $t_{\text{LOW}}$  times are programmed via the Pattern Generator Low-Time registers. There are 256  $t_{\text{LOW}}$  settings that are broken into 3 groups of linearly increasing times. The first set (from code 0x00 to 0x3C) increases the  $t_{\text{LOW}}$  time in steps of 16.384 ms. The second set (from code 0x3D to 0x7F) increases the  $t_{\text{LOW}}$  time in steps of 131.072 ms. The third set (from code 0x80 to 0xFF) increases the  $t_{\text{LOW}}$  time in steps of 524.288 ms (see [Table 28](#)).

### 7.4.3.6 Low-Level Brightness

The LED current low brightness level ( $I_{LOW}$ ) is the LED current set point that the pattern rests at during the  $t_{LOW}$  period. This level is set via the Pattern Generator Low-Level Brightness registers (BREG\_L\_C to BREG\_L\_H). The brightness level has 8 bits of programmability.  $I_{LOW}$  is a function of the Control Bank full-scale current setting and the code in the Pattern Generator Low-Level Brightness registers.

For exponential mapping  $I_{LOW}$  is:

$$I_{LOW} = I_{LED\_FULLSCALE} \times 0.85^{\left(44 - \frac{BREG\_L\_X + 1}{5.8181818}\right)} \quad (7)$$

For linear mapping  $I_{LOW}$  is:

$$I_{LOW} = I_{LED\_FULLSCALE} \times \frac{1}{255} \times BREG\_L\_X \quad (8)$$

BREG\_L\_X is the Pattern Generator Low-Level Brightness Register setting for the specific Control Bank.

### 7.4.3.7 High-Level Brightness

The LED current high brightness level ( $I_{HIGH}$ ) is the LED current set point that the pattern rests at during the  $t_{HIGH}$  period. This high-current level is set via the Control Banks Brightness Register (BREG\_H\_C to BREG\_H\_H). The brightness level has 8 bits of programmability.  $I_{HIGH}$  is a function of the Control Bank full-scale current setting and the code in the Control Banks Brightness Register, prior to the Mapping Mode selected.

For exponential mapping  $I_{HIGH}$  is:

$$I_{HIGH} = I_{LED\_FULLSCALE} \times 0.85^{\left(44 - \frac{BREG\_H\_X + 1}{5.8181818}\right)} \quad (9)$$

For linear mapping  $I_{HIGH}$  is:

$$I_{HIGH} = I_{LED\_FULLSCALE} \times \frac{1}{255} \times BREG\_H\_X \quad (10)$$

BREG\_H\_X is the Control Banks Brightness Register setting for the specific Control Bank.

## 7.4.4 Fault Flags/Protection Features

The LM3633 contains both an LED open-fault and LED short-fault detection. These fault detections are designed to be used in production-level testing and not during normal operation. For the fault flags to operate they must be enabled via the LED Fault Enable Register (see [Table 35](#)). The [Open LED String \(HVLED\)](#), [Shorted LED String \(HVLED\)](#), [Open LED \(LVLED\)](#), and [Shorted LED \(LVLED\)](#) sections detail proper procedure for reading back open and short faults in both the high-voltage LED and low-voltage LED strings.

### 7.4.4.1 Open LED String (HVLED)

An open LED string is detected when the voltage at the input to any active high-voltage current sink has fallen below 200 mV, and the boost output voltage has hit the OVP threshold. This test assumes that the HVLED string being detected for an open is connected to the LM3633 boost output (COUT+) (see [Table 31](#)). For an HVLED string not connected to the LM3633 boost output voltage, but connected to another voltage source, the boost output does not trigger the OVP flag. In this case an open LED string is not detected.

The procedure for detecting an open fault in the HVLED current sinks (provided they are connected to the boost output voltage) is:

- Apply power to the LM3633
- Enable Open Fault (Register 0xB4, bit [0] = 1)
- Assign HVLED1, HVLED2 and HVLED3 to Bank A (Register 0x10, Bits [2:0] = (0, 0, 0))
- Set the start-up ramp times to the fastest setting (Register 0x12 = 0x00)
- Set Bank A full-scale current to 20.2 mA (Register 0x20 = 0x13)
- Configure HVLED1, HVLED2, and HVLED3 for LED string anode connected to C<sub>OUT</sub> (Register 0x28, bits[2:0] = (1,1,1))

- Set Bank A brightness to maximum (Register 0x41 = 0xFF)
- Enable Bank A (Register 0x2B Bit[0] = 1)
- Wait 4 ms
- Read back bits[2:0] of register 0xB0. Bit [0] = 1 (HVLED1 open). Bit [1] = 1 (HVLED2 open). Bit [2] = 1 (HVLED3 open)
- Disable all banks (Register 0x2B = 0x00)

#### 7.4.4.2 Shorted LED String (HVLED)

The LM3633 features an LED short-fault flag indicating one or more of the HVLED strings have experienced a short. The method for detecting a shorted HVLED strings is if the current sink is enabled and the string voltage ( $V_{OUT} - V_{HVLED1/2/3}$ ) falls to below ( $V_{IN} - 1$  V). This test must be performed on one HVLED string at a time. Performing the test with both current sinks enabled can result in a faulty reading if one of the strings is shorted and the others are not.

The procedure for detecting a short in an HVLED string is:

- Apply power to the LM3633
- Enable Short Fault (Register 0xB4, bit [1] = 1)
- Enable Feedback on the HVLED Current Sinks (Register 0x28, bits[2:0] = (1,1,1))
- Assign HVLED1 to Bank A (Register 0x10, Bits [2:0] = (1, 1, 0))
- Set the start-up ramp times to the fastest setting (Register 0x12 = 0x00)
- Set Bank A full-scale current to 20.2 mA (Register 0x20 = 0x13)
- Set Bank A brightness to max (Register 0x41 = 0xFF)
- Enable Bank A (Register 0x2B Bit[0] = 1)
- Wait 4 ms
- Read back bits[0] of register 0xB2. 1 = HVLED1 short.
- Disable all banks (Register 0x2B = 0x00)
- Repeat the procedure for the HVLED2 and HVLED3 strings

#### 7.4.4.3 Open LED (LVLED)

The LM3633 features an open-LED-fault flag indicating one or more of the active low-voltage LED strings are open. An open in a low-voltage LED string is flagged if the voltage at the input to any active low-voltage current sink goes below  $V_{HR\_LV}$  (typically 80 mV).

Since the open LED detect is flagged when any active current sink input falls below  $V_{HR\_LV}$ , certain configurations can result in falsely triggering an open. These include:

1. LED anode is tied to CPOUT, charge pump is in 1X gain, and  $V_{IN}$  drops low enough to bring any active LVLED current sink below  $V_{HR\_LV}$ .
2. LED anode is not tied to CPOUT and  $V_{LED\_ANODE}$  goes low enough to bring any active LVLED current sink below  $V_{HR\_LV}$ .

The following list describes a test procedure that can be used in detecting an open in the LVLED strings:

- Apply power to the LM3633
- Enable Open Fault (Register 0xB4, bit [0] = 1)
- Assign LVLED1, LVLED2, and LVLED3 to Bank C and LVLED4, LVLED5, and LVLED6 to Bank F (Register 0x11 = 0x00)
- Set the start-up ramp times to the fastest setting (Registers 0x14 and 0x17 = 0x00)
- Set Bank C and Bank F full-scale current to 20.2 mA (Registers 0x22 and 0x25 = 0x13)
- Configure all LVLED strings for Anode connected to CPOUT (register 0x29 bits[5:0]=1)
- Force the Charge Pump into 2X gain (Register 0x2A Bits[2:1] = 11). Ensure that CPOUT and CP are in the circuit and that ( $V_{CPOUT}$  is  $> V_{FLVLED} + V_{HR\_LV}$ )
- Set Bank C and Bank F brightness to max (Registers 0x42 and 0x45 = 0xFF)
- Enable Bank C and Bank F (Register 0x2B Bits[5,2] = 1)
- Wait 4 ms
- Read back bits[5:0] of register 0xB1 (1 indicates an open, and a 0 indicates normal operation (see [Table 32](#)))

- Disable all banks (Register 0x2B = 0x00)

#### 7.4.4.4 Shorted LED (LVLED)

The LM3633 features an LED short-fault flag indicating when any active low-voltage LED is shorted (Anode to Cathode). A short in a low-voltage LED is determined when the LED voltage ( $V_{CPOUT} - V_{HR\_LV}$ ) falls below 1 V.

A procedure for determining a short in an LVLED string is detailed below:

- Apply Power
- Enable Short Fault (Register 0xB4, bit [1] = 1)
- Assign LVLED1, LVLED2, and LVLED3 to Bank C and LVLED4, LVLED5, and LVLED6 to Bank F (Register 0x11 = 0x00)
- Set the start-up ramp times to the fastest setting (Registers 0x14 and 0x17 = 0x00)
- Set Bank C and Bank F full-scale current to 20.2 mA (Registers 0x22 and 0x25 = 0x13)
- Enable Feedback on the LVLED Current Sinks (Register 0x29 = 0x3F)
- Set Charge Pump to 1X gain (Register 0x2A = 0x40)
- Set Bank C and Bank F brightness to max (Register 0x42 and 0x45 = 0xFF)
- Enable Bank C and Bank F (Register 0x2B Bits[5,2] = 1)
- Wait 4 ms
- Read bits[5:0] from register 0xB3. A 1 indicates short, and a 0 indicates normal operation (see [Table 34](#)).
- Disable all banks (Register 0x2B = 0x00)

#### 7.4.4.5 Overvoltage Protection (Inductive Boost)

The overvoltage protection threshold (OVP) on the LM3633 has 4 different programmable options: 16 V, 24 V, 32 V, and 40 V. The OVP protects the device and associated circuitry from high voltages in the event a high-voltage LED string becomes open. During normal operation, the LM3633 inductive boost converter boosts the output up so as to maintain  $V_{HR}$  at the active, high-voltage (COUT connected) current sink inputs. When a high-voltage LED string becomes open, the feedback mechanism is broken, and the boost converter over-boosts the output. When the output voltage reaches the OVP threshold the boost converter stops switching, thus allowing the output node to discharge. When the output discharges to  $V_{OVP}$  minus 1 V, the boost converter begins switching again. The OVP sense is at the OVP pin, so this pin must be connected directly to the inductive boost output capacitor positive pin.

For high-voltage current sinks that have the HVLED Current Sink Feedback Enables setting such that the high-voltage current sinks anodes are not connected to COUT (feedback is disabled), the overvoltage sense mechanism is not in place to protect the input to the high-voltage current sink. In this situation the application must ensure that the voltage at HVLED1, HVLED2, or HVLED3 does not exceed 40 V.

The default setting for OVP is set at 16 V. For applications that require higher than 16 V at the boost output, the OVP threshold must be programmed to a higher level after power up.

#### 7.4.4.6 Current Limit (Inductive Boost)

The NMOS switch current limit for the LM3633 inductive boost is set at 1 A (typ). When the current through the LM3633 NFET switch hits this overcurrent protection threshold (OCP), the device turns the NFET off, and the inductor's energy is discharged into the output capacitor. Switching is then resumed at the next cycle. The current limit protection circuitry can operate continuously each switching cycle. The result is that during high-output power conditions the device can run continuously in current limit. Under these conditions the LM3633 inductive boost converter stops regulating the headroom voltage across the high-voltage current sinks. This results in a drop in the LED current.

#### 7.4.4.7 Current Limit (Charge Pump)

The LM3633 charge pump output current limit is set high enough so that the device supports 29.8 mA (maximum full-scale current) in all LVLED current sinks. (This is typically 29.5 mA x 6 = 179 mA.) For 1X gain the output current limit is typically 350 mA ( $V_{IN} = 3.6$  V). For 2X gain the current limit is typically 240 mA (output referred), with a typical limit on the input current of 480 mA. [Figure 67](#) and [Figure 68](#) detail the charge pump current limit vs  $V_{IN}$  at both 1X and 2X gain settings.

## 7.4.5 I<sup>2</sup>C-Compatible Interface

### 7.4.5.1 Start and Stop Conditions

The LM3633 is controlled via an I<sup>2</sup>C-compatible interface. START and STOP conditions classify the beginning and the end of the I<sup>2</sup>C session. A START condition is defined as SDA transitioning from HIGH to LOW while SCL is HIGH. A STOP condition is defined as SDA transitioning from LOW to HIGH while SCL is HIGH. The I<sup>2</sup>C master always generates START and STOP conditions. The I<sup>2</sup>C bus is considered busy after a START condition and free after a STOP condition. During data transmission the I<sup>2</sup>C master can generate repeated START conditions. A START and a repeated START condition are equivalent function-wise. The data on SDA must be stable during the HIGH period of the clock signal (SCL). In other words, the state of SDA can only be changed when SCL is LOW.

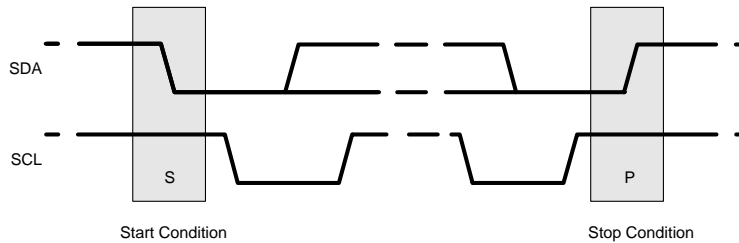

Figure 21. Start and Stop Sequences

### 7.4.5.2 I<sup>2</sup>C-Compatible Address

The chip address for the LM3633 is 0110110 (36h). After the START condition, the I<sup>2</sup>C master sends the 7-bit chip address followed by an eighth read or write bit (R/W). R/W = 0 indicates a WRITE, and R/W = 1 indicates a READ. The second byte following the chip address selects the register address to which the data is written. The third byte contains the data for the selected register.

### 7.4.5.3 Transferring Data

Every byte on the SDA line must be eight bits long, with the most significant bit (MSB) transferred first. Each byte of data must be followed by an acknowledge bit (ACK). The acknowledge related clock pulse (9th clock pulse) is generated by the master. The master releases SDA (HIGH) during the 9th clock pulse. The LM3633 pulls down SDA during the 9th clock pulse signifying an acknowledge. An acknowledge is generated after each byte has been received.

## 7.5 Register Descriptions

Table 2 lists the available registers within the LM3633.

Table 2. LM3633 Register Descriptions

Name	Address	Power On Reset	Operation
Revision	0x00	0x00	Dynamic
Software Reset	0x01	0x00	Dynamic
HVLED Current Sink Output Configuration	0x10	0x06	Static
LVLED Current Sink Output Configuration	0x11	0x36	Static
Control A Start-Up/Shutdown Ramp Time	0x12	0x00	Static
Control B Start-Up/Shutdown Ramp Time	0x13	0x00	Static
Control C Start-Up/Shutdown Ramp Time	0x14	0x00	Static
Control D Start-Up/Shutdown Ramp Time	0x15	0x00	Static
Control E Start-Up/Shutdown Ramp Time	0x16	0x00	Static
Control F Start-Up/Shutdown Ramp Time	0x17	0x00	Static
Control G Start-Up/Shutdown Ramp Time	0x18	0x00	Static
Control H Start-Up/Shutdown Ramp Time	0x19	0x00	Static
Control A and Control B Runtime Ramp Time	0x1A	0x00	Static



**Register Descriptions (continued)**
**Table 2. LM3633 Register Descriptions (continued)**

Name	Address	Power On Reset	Operation
Control A and Control B Runtime Ramp Configuration	0x1B	0x00	Static
Control C to E Runtime Ramp Time	0x1C	0x00	Static
Control F to H Runtime Ramp Time	0x1D	0x00	Static
Reserved	0x1E	0x33	Static
Brightness Configuration	0x1F	0x00	Static <sup>(1)</sup>
Control A Full-Scale Current Setting	0x20	0x13	Static
Control B Full-Scale Current Setting	0x21	0x13	Static
Control C Full-Scale Current Setting	0x22	0x13	Static
Control D Full-Scale Current Setting	0x23	0x13	Static
Control E Full-Scale Current Setting	0x24	0x13	Static
Control F Full-Scale Current Setting	0x25	0x13	Static
Control G Full-Scale Current Setting	0x26	0x13	Static
Control H Full-Scale Current Setting	0x27	0x13	Static
HVLED Current Sink Feedback Enable	0x28	0x07	Static
LVLED Current Sink Feedback Enable	0x29	0x3F	Static
Charge Pump Control	0x2A	0x00	Dynamic <sup>(2)</sup>
Control Bank Enables	0x2B	0x00	Dynamic <sup>(3)</sup>
Pattern Generator Enable	0x2C	0x00	Dynamic
Boost Control	0x2D	0x00	Static
Auto-Frequency Threshold	0x2E	0xCF	Static
PWM Configuration	0x2F	0x04	Dynamic <sup>(4)</sup>
Reserved	0x30	0x0B	Static
Reserved	0x31	0x00	Static
Control A Brightness LSB	0x40	0x00	Dynamic <sup>(5)</sup>
Control A Brightness MSB	0x41	0x00	Dynamic
Control B Brightness LSB	0x42	0x00	Dynamic <sup>(5)</sup>
Control B Brightness MSB	0x43	0x00	Dynamic
Control C Brightness	0x44	0x00	Dynamic
Control D Brightness	0x45	0x00	Dynamic
Control E Brightness	0x46	0x00	Dynamic
Control F Brightness	0x47	0x00	Dynamic
Control G Brightness	0x48	0x00	Dynamic
Control H Brightness	0x49	0x00	Dynamic
Control C Pattern Generator Delay Time	0x50	0x00	Static
Control C Pattern Generator Low Time	0x51	0x00	Static
Control C Pattern Generator High Time	0x52	0x00	Static
Control C Pattern Generator Low-Level Brightness	0x53	0x00	Dynamic
Control D Pattern Generator Delay Time	0x60	0x00	Static
Control D Pattern Generator Low Time	0x61	0x00	Static
Control D Pattern Generator High Time	0x62	0x00	Static
Control D Pattern Generator Low-Level Brightness	0x63	0x00	Dynamic

- (1) This register requires special handling due to the control of both high-voltage and low-voltage LEDs.
- (2) Only the charge pump enable bit is dynamic; the charge pump gain select bits should only be changed when the charge pump is disabled.
- (3) This register requires special handling due to the control of both high-voltage and low-voltage LEDs.
- (4) The PWM input should always be in the inactive state when setting the Control Bank PWM Enable bit. The PWM configuration bits should only be changed when the PWM is disabled for both Control Banks.
- (5) The Control Brightness MSB Register must be written for the Control Brightness LSB Register value to take effect.

**Register Descriptions (continued)**
**Table 2. LM3633 Register Descriptions (continued)**

Name	Address	Power On Reset	Operation
Control E Pattern Generator Delay Time	0x70	0x00	Static
Control E Pattern Generator Low Time	0x71	0x00	Static
Control E Pattern Generator High Time	0x72	0x00	Static
Control E Pattern Generator Low-Level Brightness	0x73	0x00	Dynamic
Control F Pattern Generator Delay Time	0x80	0x00	Static
Control F Pattern Generator Low Time	0x81	0x00	Static
Control F Pattern Generator High Time	0x82	0x00	Static
Control F Pattern Generator Low-Level Brightness	0x83	0x00	Dynamic
Control G Pattern Generator Delay Time	0x90	0x00	Static
Control G Pattern Generator Low Time	0x91	0x00	Static
Control G Pattern Generator High Time	0x92	0x00	Static
Control G Pattern Generator Low-Level Brightness	0x93	0x00	Dynamic
Control H Pattern Generator Delay Time	0xA0	0x00	Static
Control H Pattern Generator Low Time	0xA1	0x00	Static
Control H Pattern Generator High Time	0xA2	0x00	Static
Control H Pattern Generator Low-Level Brightness	0xA3	0x00	Dynamic
HVLED Open Faults	0xB0	0x00	Production Test Only
LVLED Open Faults	0xB1	0x00	Production Test Only
HVLED Short Faults	0xB2	0x00	Production Test Only
LVLED Short Faults	0xB3	0x00	Production Test Only
LED Fault Enable	0xB4	0x00	Production Test Only

**Table 3.  
Revision (Address 0x00)**

Bits [7:4] Not Used	Bits [3:0] Silicon Revision
Reserved	xxxx Rev. A Silicon

**Table 4. Software Reset (Address 0x01)**

Bits [7:1] Not Used	Bit [0] Silicon Revision
Reserved	0 = Normal Operation 1 = Software Reset (self-clearing)

**Table 5. HVLED Current Sink Output Configuration (Address 0x10)**

Bits [7:3] Not Used	Bit [2] HVLED3 Configuration	Bit [1] HVLED2 Configuration	Bit [0] HVLED1 Configuration
Reserved	0 = Control A 1 = Control B (default)	0 = Control A 1 = Control B (default)	0 = Control A (default) 1 = Control B

**Table 6. LVLED Current Sink Output Configuration (Address 0x11)**

Bits [7:6] Not Used	Bit [5] LVLED6 Configuration	Bit [4] LVLED5 Configuration	Bit [3] Not Used	Bit [2] LVLED3 Configuration	Bit [1] LVLED2 Configuration	Bit [0] Not Used
Reserved	0 = Control F 1 = Control H (default)	0 = Control F 1 = Control G (default)	LVLED4	0 = Control C 1 = Control E (default)	0 = Control C 1 = Control D (default)	LVLED1

**Table 7. Control A and Control B Start-up/Shutdown Ramp Time (Address 0x12 Through 0x13)**

Bits [7:4] Start-up Ramp	Bits [3:0] Shutdown Ramp
0000 = 2048 $\mu$ s (default)	0000 = 2048 $\mu$ s (default)
0001 = 262 ms	0001 = 262 ms
0010 = 524 ms	0010 = 524 ms
0011 = 1.049 s	0011 = 1.049 s
0100 = 2.097 s	0100 = 2.097 s
0101 = 4.194 s	0101 = 4.194 s
0110 = 8.389 s	0110 = 8.389 s
0111 = 16.78 s	0111 = 16.78 s
1000 = 33.55 s	1000 = 33.55 s
1001 = 41.94 s	1001 = 41.94 s
1010 = 50.33 s	1010 = 50.33 s
1011 = 58.72 s	1011 = 58.72 s
1100 = 67.11 s	1100 = 67.11 s
1101 = 83.88 s	1101 = 83.88 s
1110 = 100.66 s	1110 = 100.66 s
1111 = 117.44 s	1111 = 117.44 s

**Table 8. Control C to Control H Start-up/Shutdown Ramp Time (Address 0x14 Through 0x19)**

Bit [7] Not Used	Bits [6:4] Start-up Transition Time	Bit [3] Not Used	Bits [2:0] Shutdown Transition Time
Reserved	000 = 2048 $\mu$ s (default) 001 = 262 ms 010 = 524 ms 011 = 1.049 s 100 = 2.097 s 101 = 4.194 s 110 = 8.389 s 111 = 16.78 s	Reserved	000 = 2048 $\mu$ s (default) 001 = 262 ms 010 = 524 ms 011 = 1.049 s 100 = 2.097 s 101 = 4.194 s 110 = 8.389 s 111 = 16.78 s

**Table 9. Control A and Control B Run-Time Ramp Time (Address 0x1A)**

Bits [7:4] Transition Time Ramp Up	Bits [3:0] Transition Time Ramp Down
000 = 2048 $\mu$ s (default)	000 = 2048 $\mu$ s (default)
001 = 262 ms	001 = 262 ms
010 = 524 ms	010 = 524 ms
011 = 1.049 s	011 = 1.049 s
100 = 2.097 s	100 = 2.097 s
101 = 4.194 s	101 = 4.194 s
110 = 8.389 s	110 = 8.389 s
111 = 16.78 s	111 = 16.78 s
1000 = 33.55 s	1000 = 33.55 s
1001 = 41.94 s	1001 = 41.94 s
1010 = 50.33 s	1010 = 50.33 s
1011 = 58.72 s	1011 = 58.72 s
1100 = 67.11 s	1100 = 67.11 s
1101 = 83.88 s	1101 = 83.88 s
1110 = 100.66 s	1110 = 100.66 s
1111 = 117.44 s	1111 = 117.44 s

**Table 10. Control A and Control B Run-Time Ramp Configuration (Address 0x1B)**

Bits [7:4] Not Used	Bits [3:2] Control B Run-time Ramp Select	Bits [1:0] Control A Run-time Ramp Select
Reserved	00 = Controls A and B Runtime Ramp Times (default) 01 = Control B Start-up and Shutdown Ramp Times 1x = Ramp disabled	00 = Controls A and B Runtime Ramp Times (default) 01 = Control A Start-up and Shutdown Ramp Times 1x = Ramp disabled

**Table 11. Controls C to E and Controls F to H Ramp Time (Address 0x1C and 0x1D)**

Bit [7] Not Used	Bits [6:4] Transition Time Ramp Up	Bit [3] Not Used	Bits [2:0] Transition Time Ramp Down
Reserved	000 = 2048 $\mu$ s (default) 001 = 262 ms 010 = 524 ms 011 = 1.049 s 100 = 2.097 s 101 = 4.194 s 110 = 8.389 s 111 = 16.78 s	Reserved	000 = 2048 $\mu$ s (default) 001 = 262 ms 010 = 524 ms 011 = 1.049 s 100 = 2.097 s 101 = 4.194 s 110 = 8.389 s 111 = 16.78 s

**Table 12. Control A to Control H Brightness Configuration (Address 0x1F)**

Bits [7:4] Not Used	Bit [3] Control B Dither Disable	Bit [2] Control A Dither Disable	Bit [1] Controls C, D, E, F, G, H Mapping Mode	Bit [0] Control A/B Mapping Mode
Reserved	0 Enable (default) 1 Disable	0 Enable (default) 1 Disable	0 Exponential (default) 1 Linear	0 Exponential (default) 1 Linear

**Table 13. Control A to Control H Full-Scale Current Setting (Address 0x20 Through 0x27)**

Bits [7:5] Not Used	Bits [4:0] Controls A, B, C, D, E, F, G, H Full-Scale Current Select Bits
Reserved	00000 = 5 mA 10011 = 20.2 mA (default) 11111 = 29.8 mA (0.8 mA steps, FS = 5 mA + code * 0.8 mA)

**Table 14. HVLED Current Sink Feedback Enable (Address 0x28)**

Bits [7:3] Not Used	Bit [2] HVLED3 Feedback Enable	Bit [1] HVLED2 Feedback Enable	Bit [0] HVLED1 Feedback Enable
Reserved	0 = LED anode is NOT CONNECTED to COUT 1 = LED anode is CONNECTED to COUT (default)	0 = LED anode is NOT CONNECTED to COUT 1 = LED anode is CONNECTED to COUT (default)	0 = LED anode is NOT CONNECTED to COUT 1 = LED anode is CONNECTED to COUT (default)

**Table 15. LVLED Current Sink Feedback Enable (Address 0x29)**

Bits [7:6] Not Used	Bit [5] LVLED6 Feedback Enable	Bit [4] LVLED5 Feedback Enable	Bit [3] LVLED4 Feedback Enable	Bit [2] LVLED3 Feedback Enable	Bit [1] LVLED2 Feedback Enable	Bit [0] LVLED1 Feedback Enable
Reserved	0 = LED anode is NOT CONNECTED to CPOUT 1 = LED anode is CONNECTED to CPOUT (default)	0 = LED anode is NOT CONNECTED to CPOUT 1 = LED anode is CONNECTED to CPOUT (default)	0 = LED anode is NOT CONNECTED to CPOUT 1 = LED anode is CONNECTED to CPOUT (default)	0 = LED anode is NOT CONNECTED to CPOUT 1 = LED anode is CONNECTED to CPOUT (default)	0 = LED anode is NOT CONNECTED to CPOUT 1 = LED anode is CONNECTED to CPOUT (default)	0 = LED anode is NOT CONNECTED to CPOUT 1 = LED anode is CONNECTED to CPOUT (default)

**Table 16. Charge Pump Control (Address 0x2A)**

Bits [7:3] Not Used	Bits [2:1] Gain Select	Bit [0] Charge Pump Disable
N/A	0X = Automatic gain select (default) 10 = Gain set at 1X 11 = Gain set at 2X	0 = Enable (default) 1 = Disable

**Table 17. Control Bank Enable (Address 0x2B)**

Bit [7] Control H Enable	Bit [6] Control G Enable	Bit [5] Control F Enable	Bit [4] Control E Enable	Bit [3] Control D Enable	Bit [2] Control C Enable	Bit [1] Control B Enable	Bit [0] Control A Enable
0 = Disable (default) 1 = Enable	0 = Disable (default) 1 = Enable	0 = Disable (default) 1 = Enable	0 = Disable (default) 1 = Enable	0 = Disable (default) 1 = Enable	0 = Disable (default) 1 = Enable	0 = Disable (default) 1 = Enable	0 = Disable (default) 1 = Enable

**Table 18. Pattern Generator Enable (Address 0x2C)**

Bit [7] Control H Pattern Generator Enable	Bit [6] Control G Pattern Generator Enable	Bit [5] Control F Pattern Generator Enable	Bit [4] Control E Pattern Generator Enable	Bit [3] Control D Pattern Generator Enable	Bit [2] Control C Pattern Generator Enable	Bits [1:0] Not Used
0 = Disable (default) 1 = Enable	0 = Disable (default) 1 = Enable	0 = Disable (default) 1 = Enable	0 = Disable (default) 1 = Enable	0 = Disable (default) 1 = Enable	0 = Disable (default) 1 = Enable	Reserved

**Table 19. Boost Control (Address 0x2D)**

Bits [7:5] Not Used	Bit [4] Auto-Headroom Enable	Bit [3] Auto-Frequency Enable	Bits [2:1] Boost OVP Select	Bit [0] Boost Frequency Select
Reserved	0 = Disable (default) 1 = Enable	0 = Disable (default) 1 = Enable	00 = 16 V (default) 01 = 24 V 10 = 32 V 11 = 40 V	0 = 500 kHz (default) 1 = 1 MHz

**Table 20. Auto-Frequency Threshold (Address 0x2E)**

Bits [7:0]
Auto-Frequency Threshold (default = 11001111)

**Table 21. PWM Configuration (Address 0x2F)**

Bits [7:4] Not Used	Bit [3] PWM Zero Detection Enable	Bit [2] PWM Polarity	Bit [1] Control B PWM Enable	Bit [0] Control A PWM Enable
Reserved	0 = Disable 1 = Enable (default)	0 = Active Low 1 = Active High (default)	0 = Disable (default) 1 = Enable	0 = Disable (default) 1 = Enable

**Table 22. Control A Brightness LSB (Address 0x40)**

Bits [7:3] Not Used	Bits [2:0] Control A Brightness [2:0]
Reserved	Brightness LSB

**Table 23. Control A Brightness MSB (Address 0x41)**

Bits [7:0] Control A Brightness [10:3]
Brightness MSB (LED current ramping does not start until the MSB is written, LSB must always be written before MSB)

**Table 24. Control B Brightness LSB (Address 0x42)**

Bits [7:3] Not Used	Bits [2:0] Control B Brightness [2:0]
Reserved	Brightness LSB

**Table 25. Control B Brightness MSB (Address 0x43)**

Bits [7:0] Control B Brightness [10:3]
Brightness MSB (LED current ramping does not start until the MSB is written, LSB must always be written before MSB)

**Table 26. Control C to Control H Brightness (Address 0x44 Through 0x49)**

Bits [7:0] Control C-H Brightness [7:0] (BREGH_X)
Brightness Code (refer to <a href="#">High-Level Brightness</a> )

### 7.5.1 Pattern Generator Registers

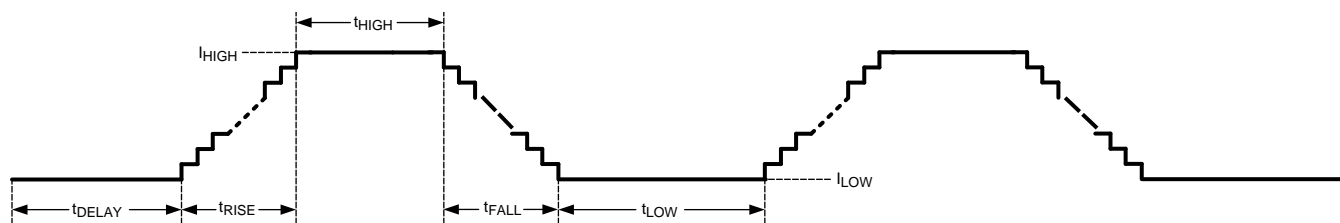
**Figure 22. Pattern Generator Timing**
**Table 27. Control C to Control H Pattern Generator Delay Time (Address 0x50, 0x60, 0x70, 0x80, 0x90, 0xA0)**

Bit [7]	Bits [6:0] $t_{DELAY}$ times
Reserved	0x00 = 16.384 ms (16.384 ms/step) (default)
	0x01 = 32.768 ms
	:
	:
	0x3B = 983.05 ms
	0x3C = 999.424 ms
	0x3D = 1130.496 ms (131.072 ms/step)
	0x3E = 1261.568 ms
	:
	0x7F = 9781.248 ms

**Table 28. Control C to Control H Pattern Generator Low Time (Address 0x51, 0x61, 0x71, 0x81, 0x91, 0xA1)**

Bits [7:0]
$t_{Low}$ times
0x00 = 16.384 ms (16.384 ms/step) (default)
0x01 = 32.768 ms
:
:
0x3B = 983.05 ms
0x3C = 999.424 ms
0x3D = 1130.496 ms (131.072 ms/step)
0x3E = 1261.568 ms
:

**Table 28. Control C to Control H Pattern Generator Low Time (Address 0x51, 0x61, 0x71, 0x81, 0x91, 0xA1) (continued)**

Bits [7:0]
:
0x7F = 9781.248 ms
0x80 = 10.305536 s (524.288 ms/step)
:
:
0xFF = 76.890112 s

**Table 29. Control C to Control H Pattern Generator High Time (Address 0x52, 0x62, 0x72, 0x82, 0x92, 0xA2)**

Bit [7] Not Used	Bits [6:0] t <sub>HIGH</sub> times
	0x00 = 16.384 ms (16.384 ms/step) (default)
	0x01 = 32.768 ms
	:
	:
	0x3B = 983.05 ms
	0x3C = 999.424 ms
	0x3D = 1130.496 ms (131.072 ms/step)
	0x3E = 1261.568 ms
	:
	:
	0x7F = 9781.248 ms

**Table 30. Control C to Control H Pattern Generator Low-Level Brightness (Address 0x53, 0x63, 0x73, 0x83, 0x93, 0xA3)**

Bits [7:0] Controls C to H Low-Level Brightness (BREGL_X)
Brightness Code (refer to <a href="#">Low-Level Brightness</a> )

**Table 31. HVLED Open Faults (Address 0xB0)**

Bits [7:3] Not Used	Bit [2] HVLED3 Open	Bit [1] HVLED2 Open	Bit [0] HVLED1 Open
Reserved	0 = Normal Operation 1 = Open	0 = Normal Operation 1 = Open	0 = Normal Operation 1 = Open

**Table 32. LVLED Open Faults (Address 0xB1)**

Bits [7:6] Not Used	Bit [5] LVLED6 Open	Bit [4] LVLED5 Open	Bit [3] LVLED4 Open	Bit [2] LVLED3 Open	Bit [1] LVLED2 Open	Bit [0] LVLED1 Open
Reserved	0 = Normal Operation 1 = Open	0 = Normal Operation 1 = Open	0 = Normal Operation 1 = Open	0 = Normal Operation 1 = Open	0 = Normal Operation 1 = Open	0 = Normal Operation 1 = Open

**Table 33. HVLED Short Faults (Address 0xB2)**

Bits [7:3] Not Used	Bit [2] HVLED3 Short	Bit [1] HVLED2 Short	Bit [0] HVLED1 Short
Reserved	0 = Normal Operation 1 = Short	0 = Normal Operation 1 = Short	0 = Normal Operation 1 = Short

**Table 34. LVLED Short Faults (Address 0xB3)**

Bits [7:6] Not Used	Bit [5] LVLED6 Short	Bit [4] LVLED5 Short	Bit [3] LVLED4 Short	Bit [2] LVLED3 Short	Bit [1] LHVLED2 Short	Bit [0] LVLED1 Short
Reserved	0 = Normal Operation 1 = Short	0 = Normal Operation 1 = Short	0 = Normal Operation 1 = Short	0 = Normal Operation 1 = Short	0 = Normal Operation 1 = Short	0 = Normal Operation 1 = Short

**Table 35. LED Fault Enable (Address 0xB4)**

Bits [7:2] Not Used	Bit [1] Short Faults Enable	Bit [0] Open Faults Enable
Reserved	0 = Disable (default) 1 = Enable	0 = Disable (default) 1 = Enable



## 8 Applications and Implementation

### 8.1 Application Information

The LM3633 provides a complete high-performance, high-voltage LED and low-voltage-indicator LED lighting solution for mobile handsets. The LM3633 is highly configurable and can support the high-voltage LED configurations summarized in Table 36. The LM3633 utilizes internal ramp-time generators to provide smooth 11-bit high-voltage LED dimming while requiring only an 8-bit command from the host controller. The LM3633EVM is available with GUI software to aid understanding of the LM3633 operation.

Table 36. Supported High-Voltage LED Configurations

NUMBER OF HIGH-VOLTAGE LED STRINGS	MAXIMUM NUMBER OF SERIES HIGH-VOLTAGE LEDs
3	6
2	10
1	10

### 8.2 Typical Application

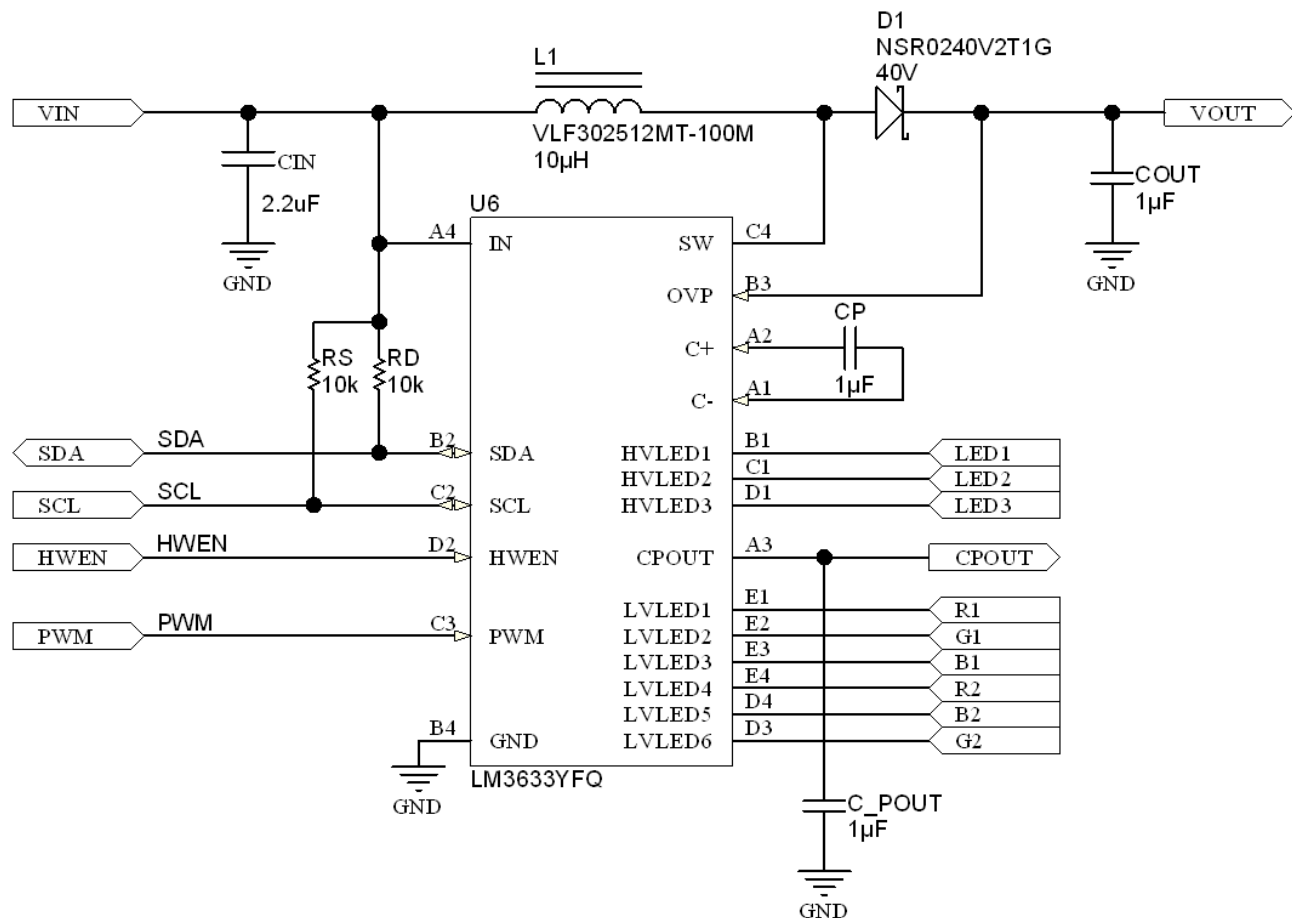

Figure 23. LM3633 Simplified Schematic

**Typical Application (continued)**
**Table 37. Application Circuit Component List**

COMPONENT	MANUFACTURER	VALUE	PART NUMBER	SIZE	CURRENT/VOLTAGE RATING (Resistance)
L	TDK	10 $\mu$ H	VLF302512MT-100M	2.5mm x 3.0mm x 1.2mm	620 mA/0.25 $\Omega$
COUT		1 $\mu$ F	C2012X5R1H105	0805	50 V
CIN		2.2 $\mu$ F	C1005X5R1A225	0402	10 V
CPOUT/CP		1 $\mu$ F	C1005X5R1A105	0402	10 V
WLED			312WBCW(A)	0603	30 mA/3.3 V (typ.)
Diode	On-Semi		NSR0240V2T1G	SOD-523	40 V, 250 mA

**8.2.1 Design Requirements**
**Table 38. Design Parameters**

DESIGN PARAMETER	EXAMPLE VALUE
Full-scale current setting	20.2 mA
Minimum Input Voltage	3.0 V
LED series/parallel configuration	6s3p
LED maximum forward voltage ( $V_f$ )	3.5 V
Efficiency	80

The designer needs to know the following

- Full-scale current setting
- Minimum input voltage
- LED series/parallel configuration
- LED maximum  $V_f$  voltage
- LM3633 Efficiency for LED configuration

The full-scale current setting, number of led strings, number of series LEDs, and minimum input voltage are needed in order to calculate the peak input current. This information guides the designer to make the appropriate inductor selection for the application.

The LM3633 boost converter output voltage ( $V_{OUT}$ ) is calculated as follows: number of series LEDs \*  $V_f$  + 0.4V

The LM3633 boost converter output current ( $I_{OUT}$ ) is calculated as follows: number of parallel LED strings \* Full-scale current

The LM3633 peak input current ( $I_{IN\_PK}$ ) is calculated as follows:  $V_{OUT} * I_{OUT} / \text{Minimum } V_{IN} / \text{Efficiency}$

$$I_{IN\_PK} > V_{OUT} \times I_{OUT} \div \text{Minimum } V_{IN} \div \text{Efficiency}$$

$$V_{OUT} = 21.4 \text{ V} = 6 \times 3.5 \text{ V} + 0.4 \text{ V}$$

$$I_{OUT} = 0.0606 \text{ A} = 0.0202 \times 3$$

$$I_{IN\_PK} > 0.54 \text{ A} = 21.4 \text{ V} \times 0.0606 \text{ A} \div 3.0 \text{ V} \div 0.8$$

(11)

**8.2.2 Detailed Design Procedure**
**8.2.2.1 Boost Converter Maximum Output Power (Boost)**

Maximum output power of the LM3633 is governed by two factors: the peak current limit ( $I_{CL} = 880 \text{ mA min}$ ), and the maximum output voltage ( $V_{OVP}$ ). When the application causes either of these limits to be reached it is possible that the proper current regulation and matching between LED current strings is not met.

### 8.2.2.1.1 Peak Current Limited

In the case of a peak current limited situation, the NFET switch turns off for the remainder of the switching period when the inductor current peak hits the LM3633 current limit. If this happens each switching cycle the LM3633 regulates the inductor current peak instead of the headroom across the current sinks. This can result in the dropout of the boost output connected current sinks, and the LED current dropping below its programmed level.

The peak current in a boost converter is dependent on the value of the inductor, total LED current in the boost ( $I_{OUT}$ ), the boost output voltage ( $V_{OUT}$ ) (which is the highest voltage LED string +  $V_{HR}$ ), the input voltage ( $V_{IN}$ ), the switching frequency, and the efficiency (Output Power/Input Power). Additionally, the peak current is different depending on whether the inductor current is continuous during the entire switching period (CCM), or discontinuous (DCM) where it goes to 0 before the switching period ends. For Continuous Conduction Mode the peak inductor current is given by:

$$I_{PEAK} = \frac{I_{OUT} \times V_{OUT}}{V_{IN} \times \text{efficiency}} + \left[ \frac{V_{IN}}{2 \times f_{SW} \times L} \times \left( 1 - \frac{V_{IN} \times \text{efficiency}}{V_{OUT}} \right) \right] \quad (12)$$

For Discontinuous Conduction Mode the peak inductor current is given by:

$$I_{PEAK} = \sqrt{\frac{2 \times I_{OUT}}{f_{SW} \times L \times \text{efficiency}} \times (V_{OUT} - V_{IN} \times \text{efficiency})} \quad (13)$$

To determine which mode the circuit is operating in (CCM or DCM) it is necessary to perform a calculation to test whether the inductor current ripple is less than the anticipated input current ( $I_{IN}$ ). If  $\Delta I_L$  is less than  $I_{IN}$  then the device operates in CCM. If  $\Delta I_L$  is greater than  $I_{IN}$  then the device is operating in DCM.

$$\frac{I_{OUT} \times V_{OUT}}{V_{IN} \times \text{efficiency}} > \frac{V_{IN}}{f_{SW} \times L} \times \left( 1 - \frac{V_{IN} \times \text{efficiency}}{V_{OUT}} \right) \quad (14)$$

Typically at currents high enough to reach the LM3633 peak current limit, the device operates in CCM.

The following figures show the output current and voltage derating for a 10- $\mu\text{H}$  and a 22- $\mu\text{H}$  inductor. These plots take equations (1) and (2) from above and plot  $V_{OUT}$  and  $I_{OUT}$  with varying  $V_{IN}$ , a constant peak current of 880 mA ( $I_{CL\_MIN}$ ), 500-kHz switching frequency, and a constant efficiency of 85%. Using these curves gives a good design guideline on selecting the correct inductor for a given output power requirement. A 10- $\mu\text{H}$  inductor is typically a smaller device with lower on resistance, but the peak currents are higher. A 22- $\mu\text{H}$  inductor provides for lower peak currents, but to match the DC resistance of a 10- $\mu\text{H}$  inductor, a larger-sized device is required.

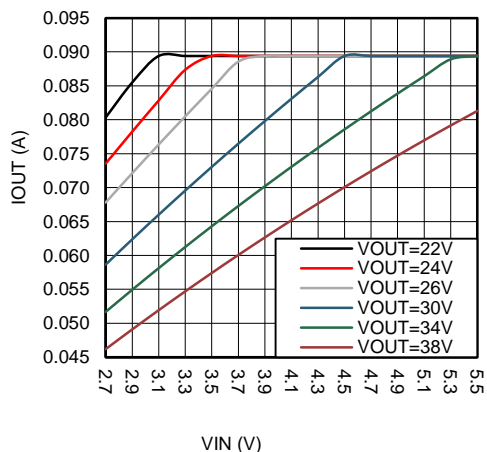

Figure 24. Maximum Output Power (22  $\mu\text{H}$ )

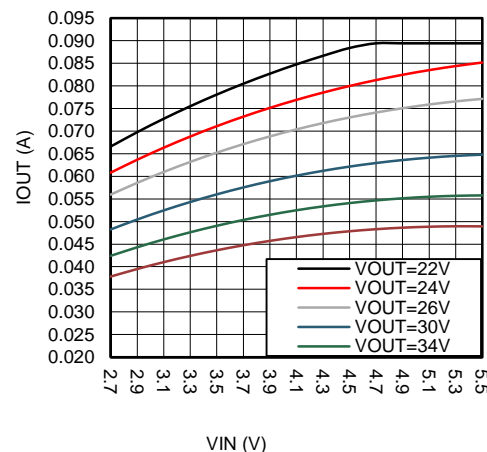

Figure 25. Maximum Output Power (10  $\mu\text{H}$ )

### 8.2.2.1.2 Output Voltage Limited

In the case of a output voltage limited situation ( $V_{OUT} = V_{OVP}$ ), when the boost output voltage hits the LM3633 OVP threshold, the NFET turns off and stays off until the output voltage falls below the hysteresis level (typically 1 V below the OVP threshold). This results in the boost converter regulating the output voltage to the programmed OVP threshold (16 V, 24 V, 32 V, or 40 V), causing the current sinks to go into dropout. The default OVP threshold is set at 16 V. For LED strings higher than typically 4 series LEDs, the OVP has to be programmed higher after power-up or after a HWEN reset.

### 8.2.2.2 Boost Inductor Selection

The boost circuit operates using a 4.7- $\mu$ F to 22- $\mu$ F inductor. The inductor selected must have a saturation current greater than the peak operating current.

### 8.2.2.3 Output Capacitor Selection

The LM3633 inductive boost converter requires a 1.0- $\mu$ F (X5R or X7R) ceramic capacitor to filter the output voltage. The voltage rating of the capacitor depends on the selected OVP setting. For the 16-V setting a 16-V capacitor must be used. For the 24-V setting a 25-V capacitor must be used. For the 32-V setting, a 35-V capacitor must be used. For the 40-V setting a 50-V capacitor must be used. Pay careful attention to the capacitor tolerance and DC bias response. For proper operation the degradation in capacitance due to tolerance, DC bias, and temperature, should stay above 0.4  $\mu$ F. This might require placing two devices in parallel in order to maintain the required output capacitance over the device operating range, and series LED configuration.

### 8.2.2.4 Schottky Diode Selection

The Schottky diode must have a reverse breakdown voltage greater than the LM3633 maximum output voltage (see [Overvoltage Protection \(Inductive Boost\)](#) section). Additionally, the diode must have an average current rating high enough to handle the LM3633 maximum output current, and at the same time the diode peak current rating must be high enough to handle the peak inductor current. Schottky diodes are required due to their lower forward voltage drop (0.3 V to 0.5 V) and their fast recovery time.

### 8.2.2.5 Input Capacitor Selection

The input capacitor on the LM3633 filters the voltage ripple due to the switching action of the inductive boost and the capacitive charge-pump doubler. A ceramic capacitor of at least 2.2- $\mu$ F (X5R or X7R) must be used to filter the input voltage.

### 8.2.2.6 Maximum Output Power (Charge Pump)

The maximum output power available from the LM3633 charge pump is determined by the maximum output voltage available from the charge pump. In 1X gain the charge pump operates in Pass Mode so the voltage at CPOUT tracks  $V_{IN}$  (less the drop across the charge-pump pass switch). In this case the maximum output power is given as:

$$P_{OUT\_MAX} = I_{LVLED\_TOTAL} \times (V_{IN} - I_{LVLED\_TOTAL} \times R_{CP}) \quad (15)$$

where  $R_{CP}$  is the resistance from  $V_{IN}$  to CPOUT and  $I_{LVLED\_TOTAL}$  is the maximum programmed current in the LVLED strings.

In 2X gain the voltage at CPOUT ( $V_{CPOUT\_2X}$ ) is regulated to typically 4.4 V. In this case the maximum output power is given by:

$$P_{OUT\_MAX} = I_{LVLED\_TOTAL} \times V_{CPOUT\_2X} \quad (16)$$

Both equations assume there is sufficient headroom at the top side of the low-voltage current sinks to ensure the LED current remains in regulation ( $V_{HR\_LV}$ ) in the electrical table.

### 8.2.2.7 Charge Pump Flying Capacitor Selection

The charge pump flying capacitor must quickly charge up to the input voltage and then supply the current to the output every switching cycle (1 MHz). This fast switching action requires a 1.0- $\mu$ F (X5R or X7R) ceramic capacitor connected to the C+ and C– pins with a low inductive connection.

### 8.2.2.8 Charge Pump Output Capacitor Selection

The charge pump output capacitor filters the switched charge from the flying capacitor every switching cycle (1 MHz). This fast switching action requires a 1.0- $\mu$ F (X5R or X7R) ceramic capacitor connected to the CPOUT pin with a low-inductive connection.

### 8.2.2.9 Charge Pump Input Capacitor Selection

The input capacitor for the LM3633 charge pump is the same one used for the LM3633 inductive boost converter (see [Input Capacitor Selection](#)).

### 8.2.3 Application Performance Plots

$V_{IN} = 3.6$  V,  $V_{LED} = 3.2$  V @ 20 mA, Typical Application Circuit,  $T_A = 25^\circ\text{C}$ , Full-Scale Current = 20.2 mA unless otherwise specified. Efficiency is  $V_{OUT} \times (I_{HVLED1} + I_{HVLED2} + I_{HVLED3}) / (V_{IN} \times I_{IN})$ , matching curves are  $(\Delta I_{LED\_MAX} / I_{LED\_AVE})$ . See [Table 37](#).

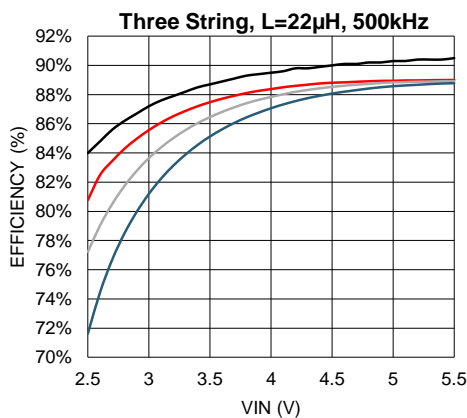

Top to Bottom: 3x3, 3x4, 3x5, 3x6 (LEDs)

Figure 26. Efficiency vs  $V_{IN}$ , Three String

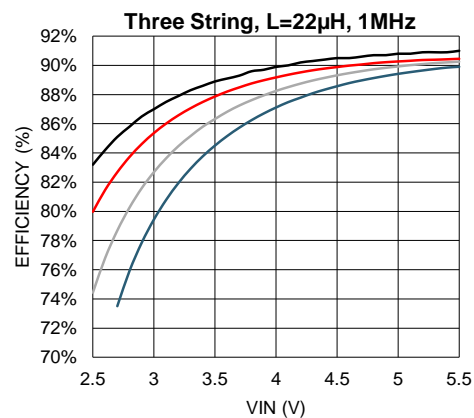

Top to Bottom: 3x3, 3x4, 3x5, 3x6 (LEDs)

Figure 27. Efficiency vs  $V_{IN}$ , Three String

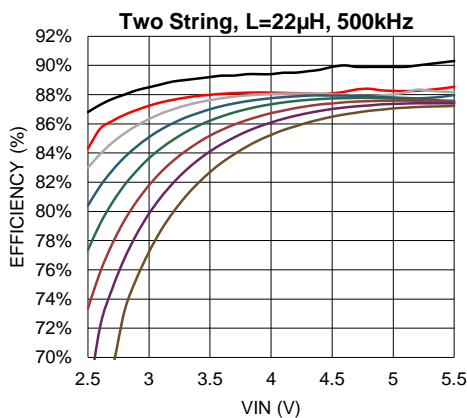

Top to Bottom: 2x3, 2x4, 2x5, 2x6, 2x7, 2x8, 2x9, 2x10 (LEDs)

Figure 28. Efficiency vs  $V_{IN}$ , Dual String

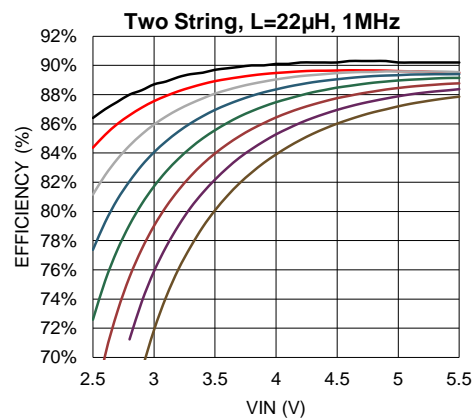

Top to Bottom: 2x3, 2x4, 2x5, 2x6, 2x7, 2x8, 2x9, 2x10 (LEDs)

Figure 29. Efficiency vs  $V_{IN}$ , Dual String

$V_{IN} = 3.6\text{ V}$ ,  $V_{LED} = 3.2\text{ V @ } 20\text{ mA}$ , Typical Application Circuit,  $T_A = 25^\circ\text{C}$ , Full-Scale Current = 20.2 mA unless otherwise specified. Efficiency is  $V_{OUT} \times (I_{HVLED1} + I_{HVLED2} + I_{HVLED3}) / (V_{IN} \times I_{IN})$ , matching curves are  $(\Delta I_{LED\_MAX} / I_{LED\_AVE})$ . See Table 37.

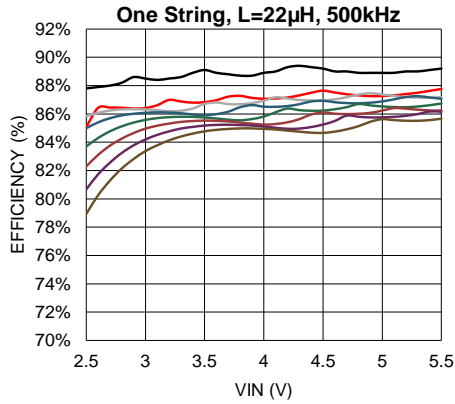

Top to Bottom: 1x3, 1x4, 1x5, 1x6, 1x7, 1x8, 1x9, 1x10 (LEDs)

Figure 30. Efficiency vs  $V_{IN}$ , Single String

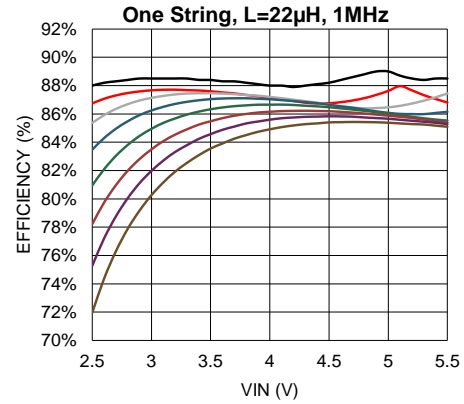

Top to Bottom: 1x3, 1x4, 1x5, 1x6, 1x7, 1x8, 1x9, 1x10 (LEDs)

Figure 31. Efficiency vs  $V_{IN}$ , Single String

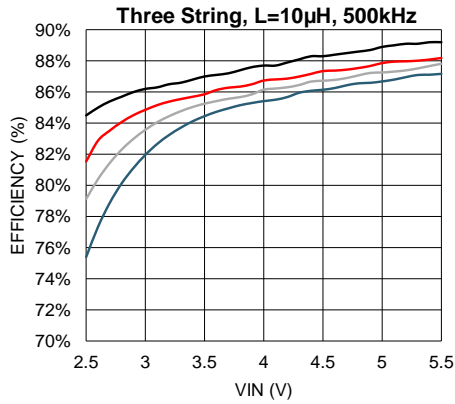

Top to Bottom: 3x3, 3x4, 3x5, 3x6 (LEDs)

Figure 32. Efficiency vs  $V_{IN}$ , Three String

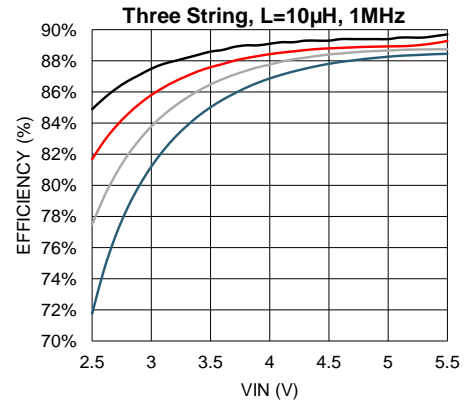

Top to Bottom: 3x3, 3x4, 3x5, 3x6 (LEDs)

Figure 33. Efficiency vs  $V_{IN}$ , Three String

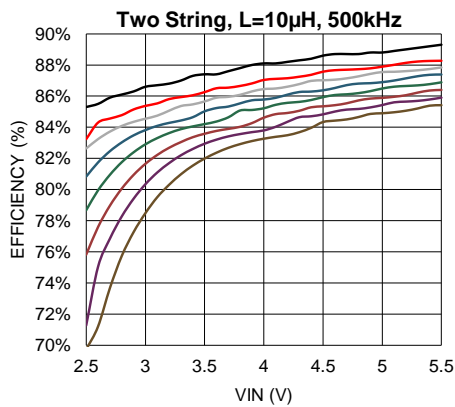

Top to Bottom: 2x3, 2x4, 2x5, 2x6, 2x7, 2x8, 2x9, 2x10 (LEDs)

Figure 34. Efficiency vs  $V_{IN}$ , Dual String

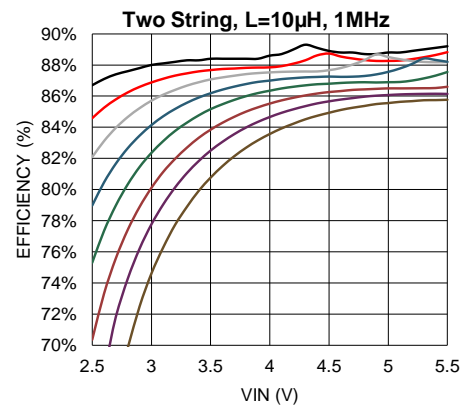

Top to Bottom: 2x3, 2x4, 2x5, 2x6, 2x7, 2x8, 2x9, 2x10 (LEDs)

Figure 35. Efficiency vs  $V_{IN}$ , Dual String

$V_{IN} = 3.6\text{ V}$ ,  $V_{LED} = 3.2\text{ V @ }20\text{ mA}$ , Typical Application Circuit,  $T_A = 25^\circ\text{C}$ , Full-Scale Current = 20.2 mA unless otherwise specified. Efficiency is  $V_{OUT} \times (I_{HVLED1} + I_{HVLED2} + I_{HVLED3}) / (V_{IN} \times I_{IN})$ , matching curves are  $(\Delta I_{LED\_MAX} / I_{LED\_AVE})$ . See Table 37.

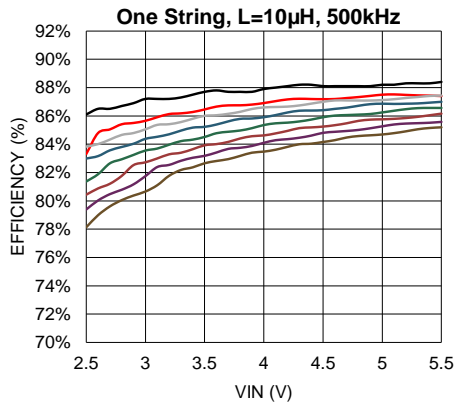

Top to Bottom: 1x3, 1x4, 1x5, 1x6, 1x7, 1x8, 1x9, 1x10 (LEDs)

Figure 36. Efficiency vs  $V_{IN}$ , Single String

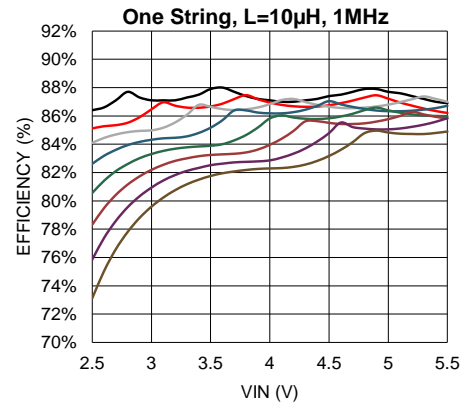

Top to Bottom: 1x3, 1x4, 1x5, 1x6, 1x7, 1x8, 1x9, 1x10 (LEDs)

Figure 37. Efficiency vs  $V_{IN}$ , Single String

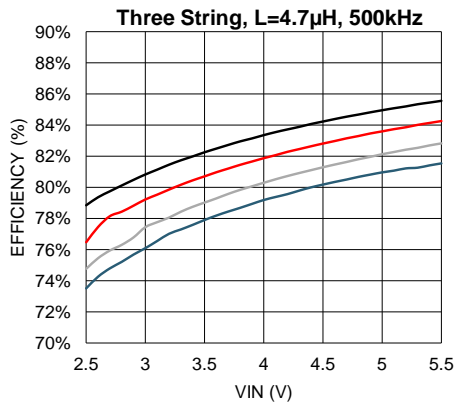

Top to Bottom: 3x3, 3x4, 3x5, 3x6 (LEDs)

Figure 38. Efficiency vs  $V_{IN}$ , Three String

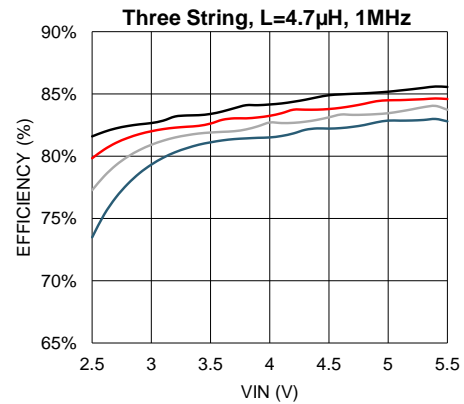

Top to Bottom: 3x3, 3x4, 3x5, 3x6 (LEDs)

Figure 39. Efficiency vs  $V_{IN}$ , Three String

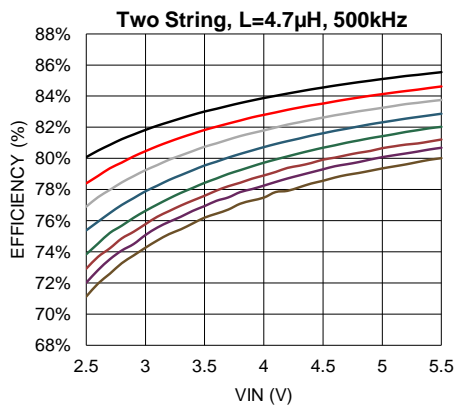

Top to Bottom: 2x3, 2x4, 2x5, 2x6, 2x7, 2x8, 2x9, 2x10 (LEDs)

Figure 40. Efficiency vs  $V_{IN}$ , Dual String

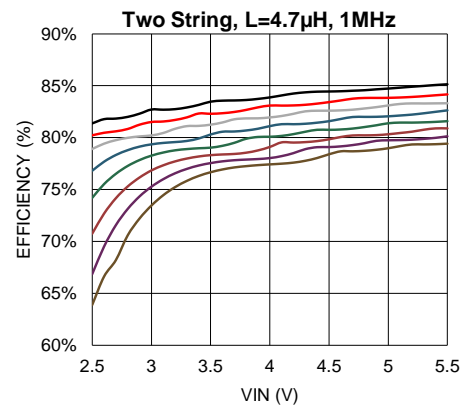

Top to Bottom: 2x3, 2x4, 2x5, 2x6, 2x7, 2x8, 2x9, 2x10 (LEDs)

Figure 41. Efficiency vs  $V_{IN}$ , Dual String

$V_{IN} = 3.6\text{ V}$ ,  $V_{LED} = 3.2\text{ V @ } 20\text{ mA}$ , Typical Application Circuit,  $T_A = 25^\circ\text{C}$ , Full-Scale Current = 20.2 mA unless otherwise specified. Efficiency is  $V_{OUT} \times (I_{HVLED1} + I_{HVLED2} + I_{HVLED3}) / (V_{IN} \times I_{IN})$ , matching curves are  $(\Delta I_{LED\_MAX} / I_{LED\_AVE})$ . See Table 37.

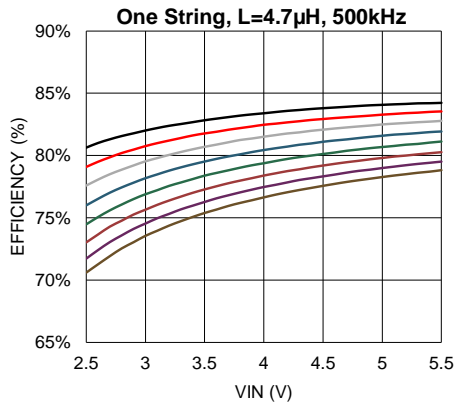

Top to Bottom: 1x3, 1x4, 1x5, 1x6, 1x7, 1x8, 1x9, 1x10 (LEDs)

Figure 42. Efficiency vs  $V_{IN}$ , Single String

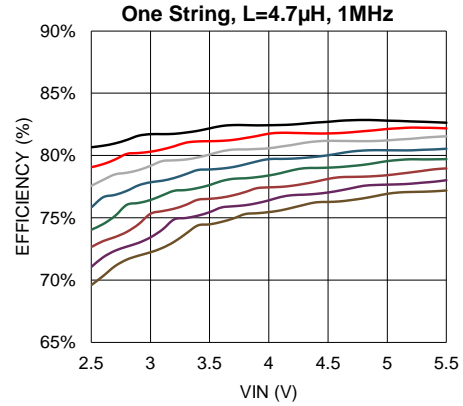

Top to Bottom: 1x3, 1x4, 1x5, 1x6, 1x7, 1x8, 1x9, 1x10 (LEDs)

Figure 43. Efficiency vs  $V_{IN}$ , Single String

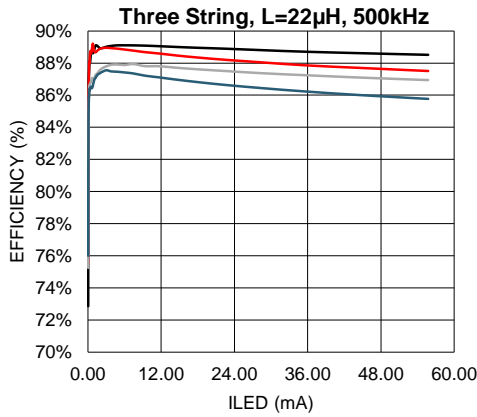

Top to Bottom: 3x3, 3x4, 3x5, 3x6 (LEDs)

Figure 44. Efficiency vs  $I_{LED}$

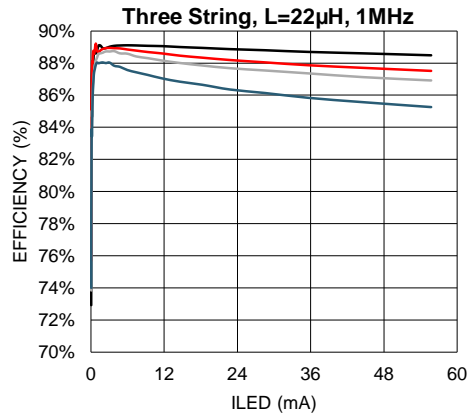

Top to Bottom: 3x3, 3x4, 3x5, 3x6 (LEDs)

Figure 45. Efficiency vs  $I_{LED}$

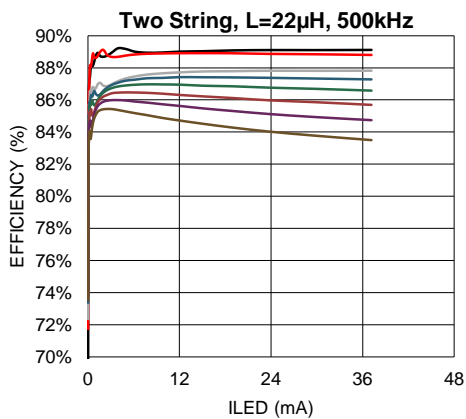

Top to Bottom: 2x3, 2x4, 2x5, 2x6, 2x7, 2x8, 2x9, 2x10 (LEDs)

Figure 46. Efficiency vs  $I_{LED}$

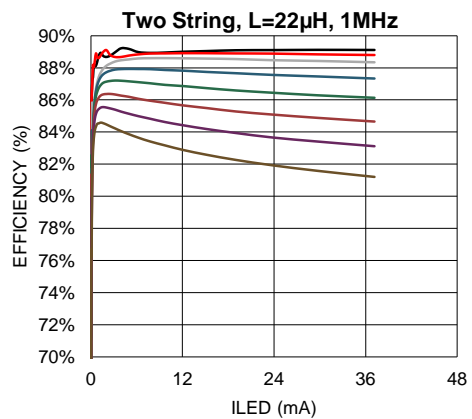

Top to Bottom: 2x3, 2x4, 2x5, 2x6, 2x7, 2x8, 2x9, 2x10 (LEDs)

Figure 47. Efficiency vs  $I_{LED}$



$V_{IN} = 3.6\text{ V}$ ,  $V_{LED} = 3.2\text{ V @ } 20\text{ mA}$ , Typical Application Circuit,  $T_A = 25^\circ\text{C}$ , Full-Scale Current = 20.2 mA unless otherwise specified. Efficiency is  $V_{OUT} \times (I_{HVLED1} + I_{HVLED2} + I_{HVLED3}) / (V_{IN} \times I_{IN})$ , matching curves are  $(\Delta I_{LED\_MAX} / I_{LED\_AVE})$ . See Table 37.

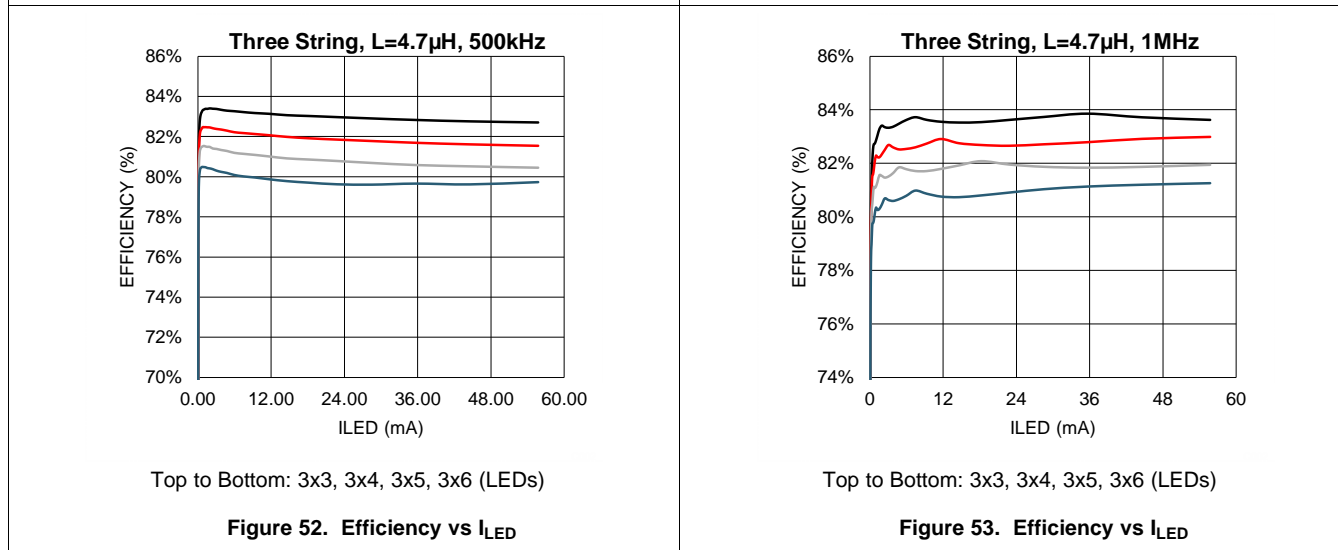
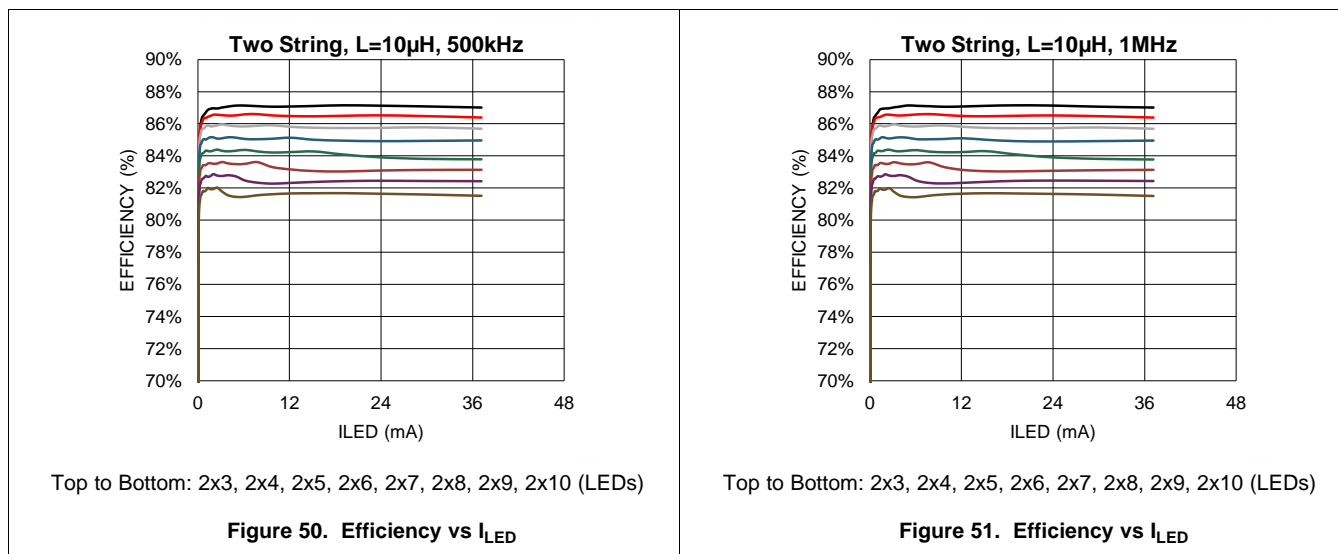
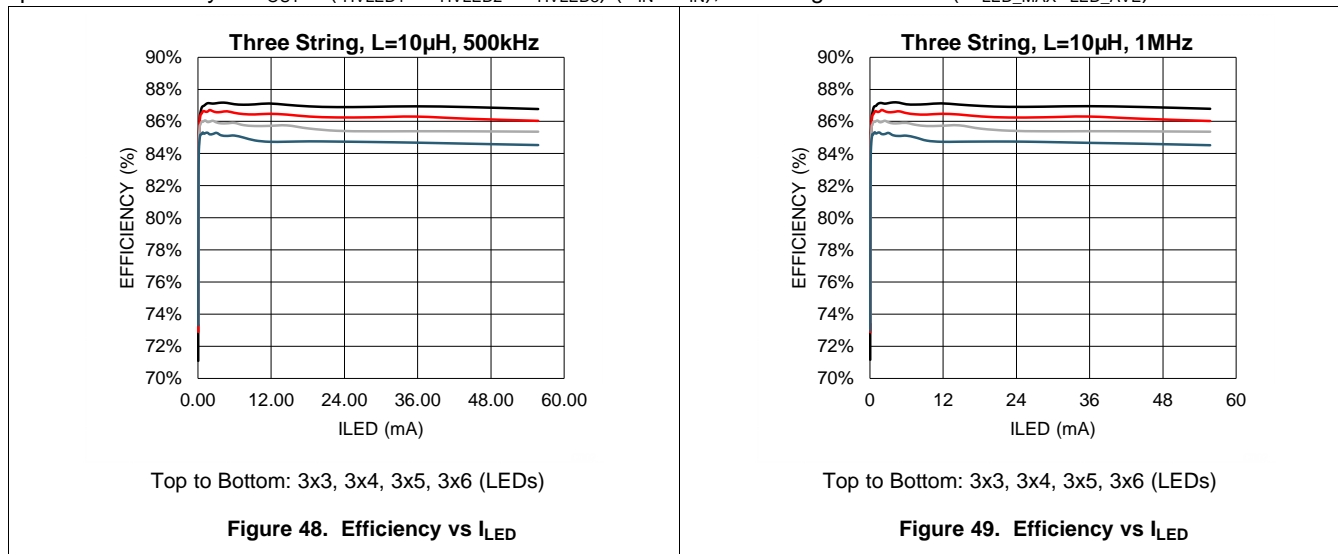

LM3633

SNVS867 – JUNE 2014

www.ti.com

$V_{IN} = 3.6\text{ V}$ ,  $V_{LED} = 3.2\text{ V @ } 20\text{ mA}$ , Typical Application Circuit,  $T_A = 25^\circ\text{C}$ , Full-Scale Current = 20.2 mA unless otherwise specified. Efficiency is  $V_{OUT} \times (I_{HVLED1} + I_{HVLED2} + I_{HVLED3}) / (V_{IN} \times I_{IN})$ , matching curves are  $(\Delta I_{LED\_MAX} / I_{LED\_AVE})$ . See Table 37.

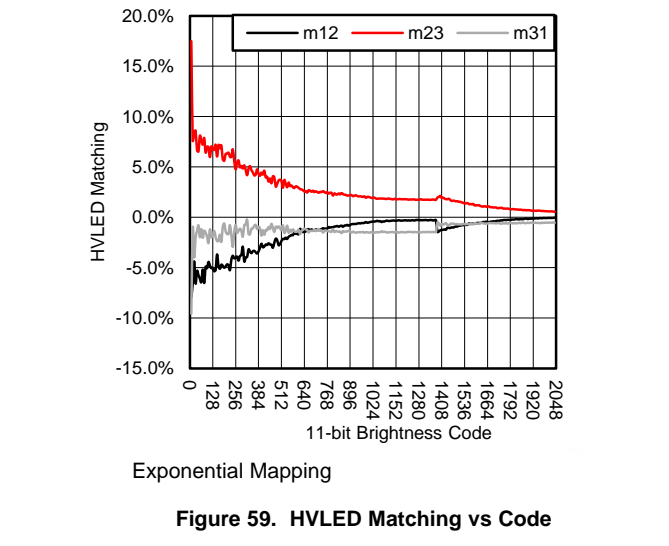
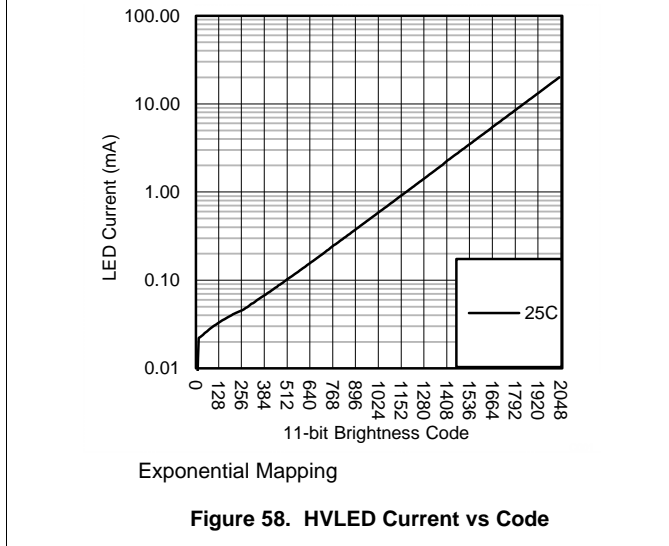
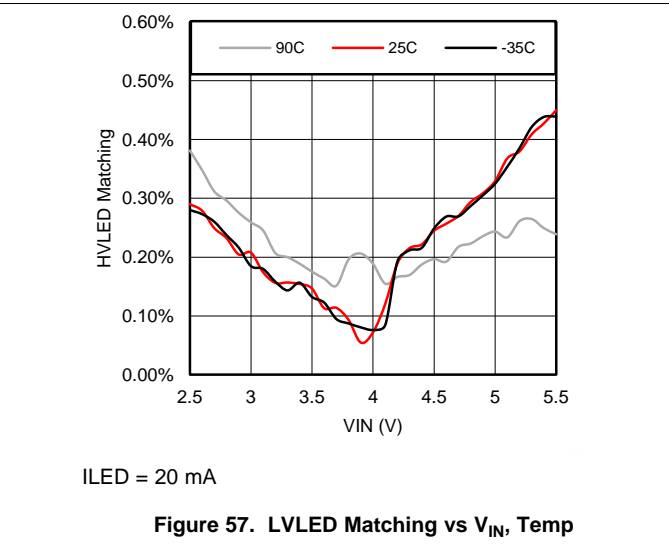
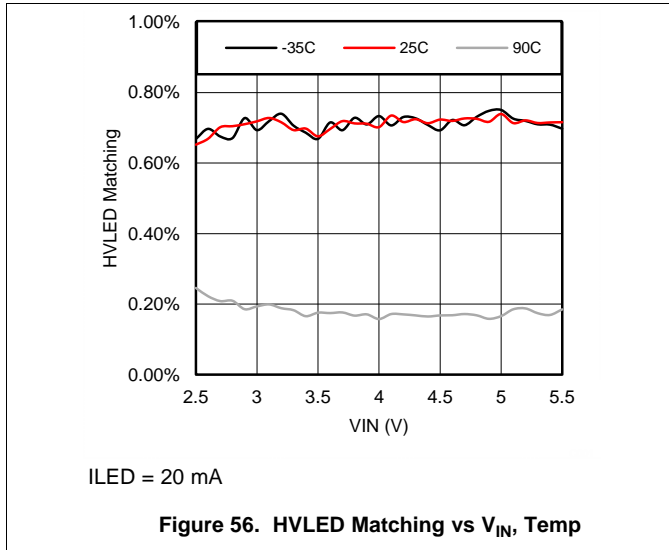
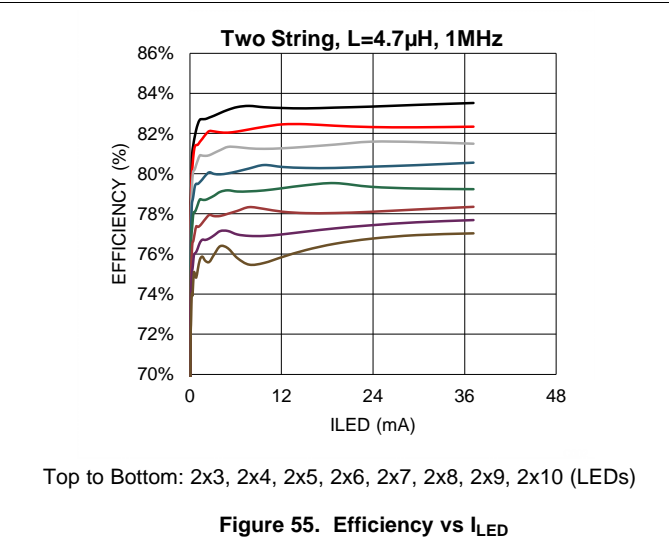
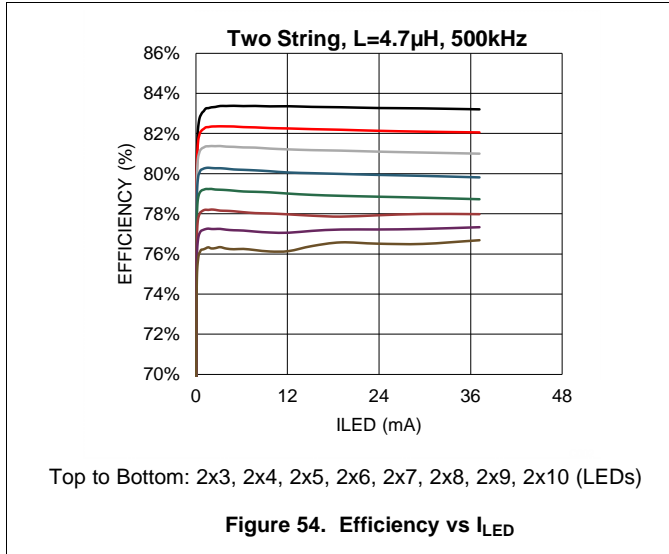

$V_{IN} = 3.6\text{ V}$ ,  $V_{LED} = 3.2\text{ V @ } 20\text{ mA}$ , Typical Application Circuit,  $T_A = 25^\circ\text{C}$ , Full-Scale Current = 20.2 mA unless otherwise specified. Efficiency is  $V_{OUT} \times (I_{HVLED1} + I_{HVLED2} + I_{HVLED3}) / (V_{IN} \times I_{IN})$ , matching curves are  $(\Delta I_{LED\_MAX} / I_{LED\_AVE})$ . See Table 37.

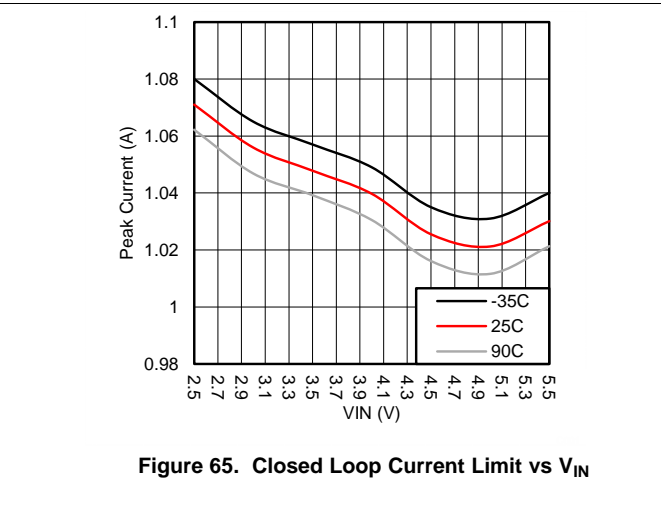
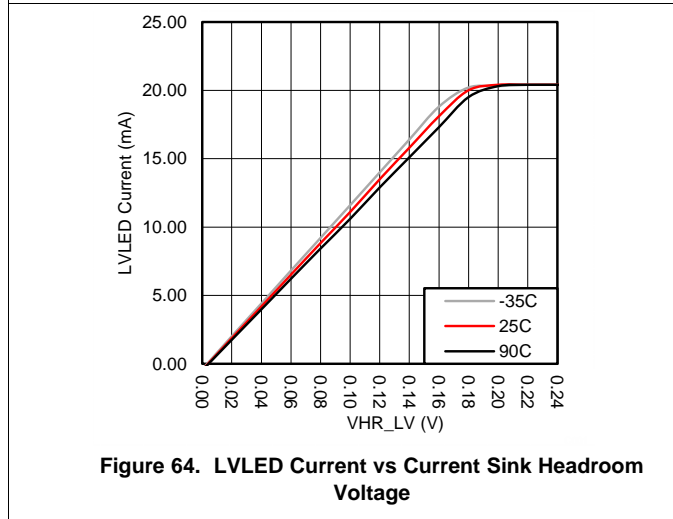
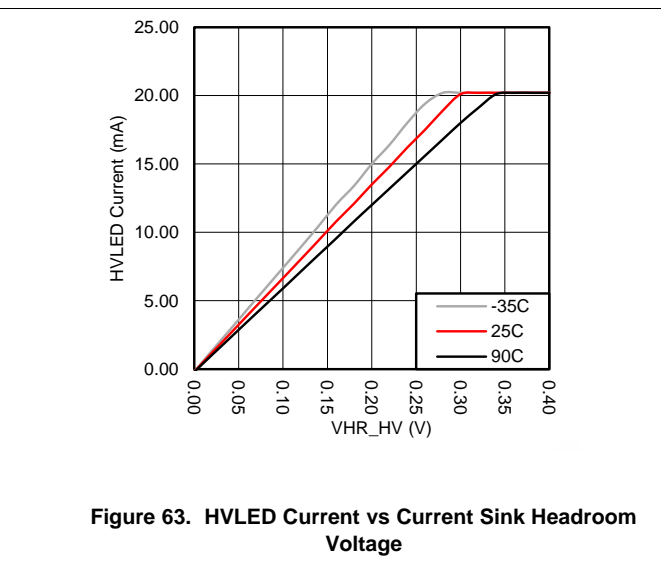
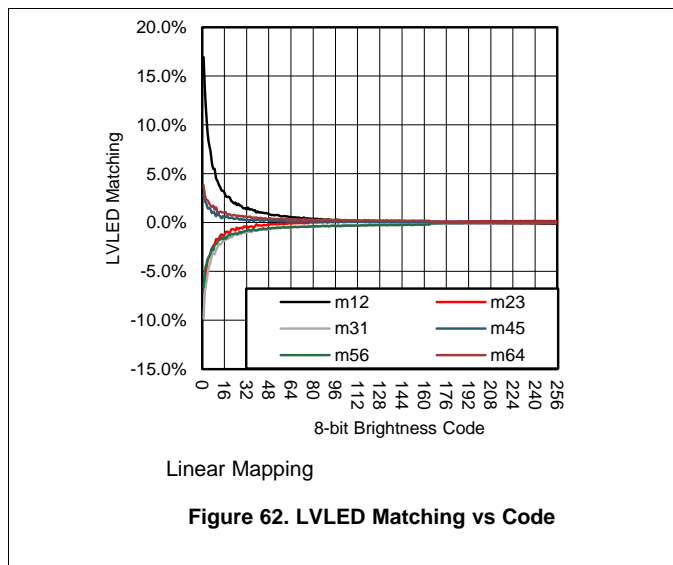
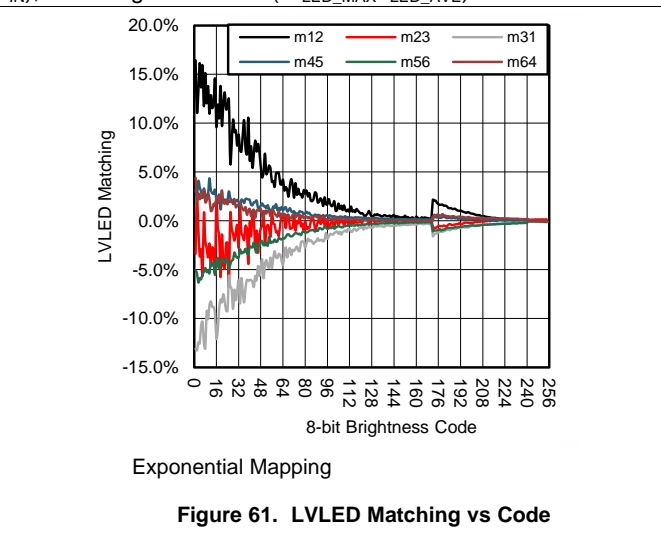
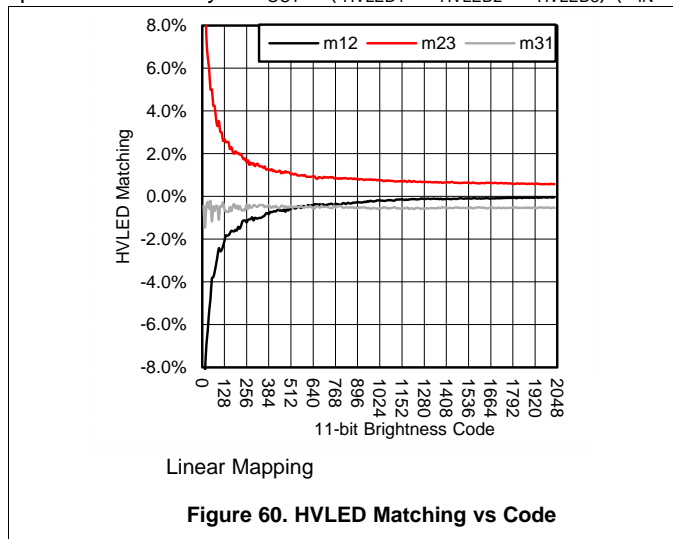

$V_{IN} = 3.6\text{ V}$ ,  $V_{LED} = 3.2\text{ V @ } 20\text{ mA}$ , Typical Application Circuit,  $T_A = 25^\circ\text{C}$ , Full-Scale Current = 20.2 mA unless otherwise specified. Efficiency is  $V_{OUT} \times (I_{HVLED1} + I_{HVLED2} + I_{HVLED3}) / (V_{IN} \times I_{IN})$ , matching curves are  $(\Delta I_{LED\_MAX} / I_{LED\_AVE})$ . See Table 37.

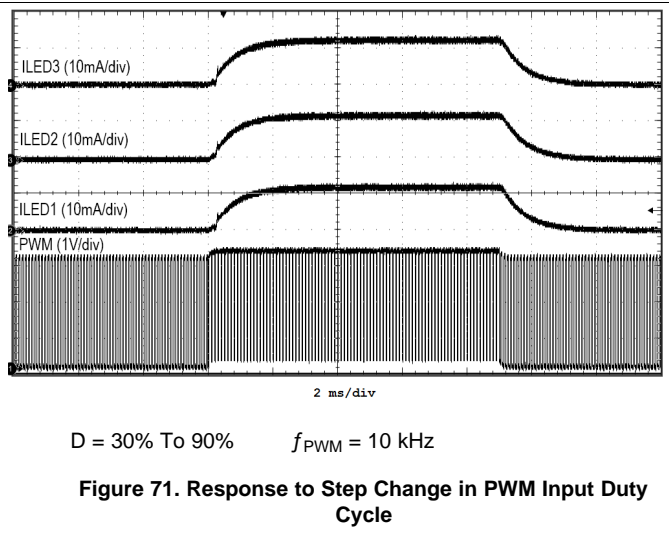
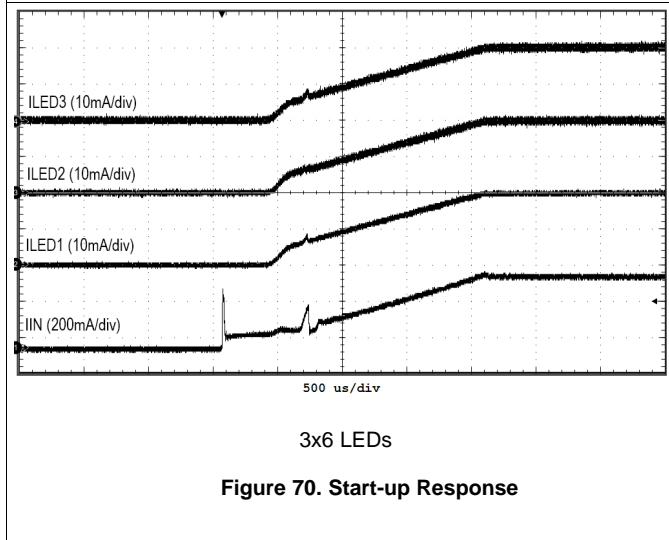
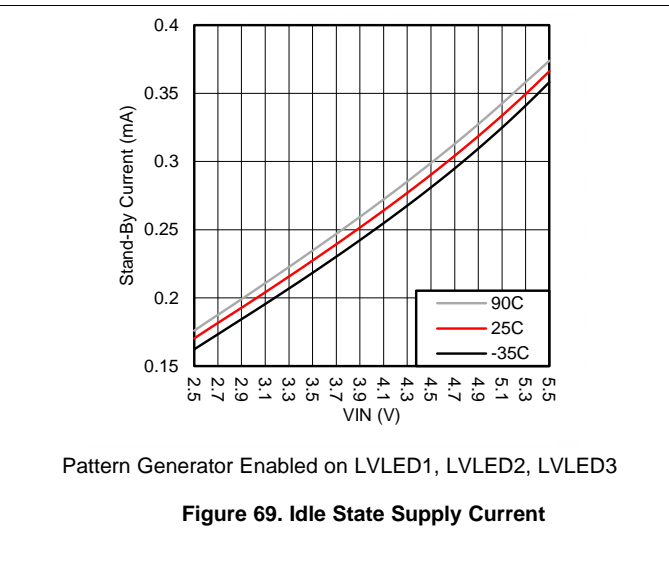
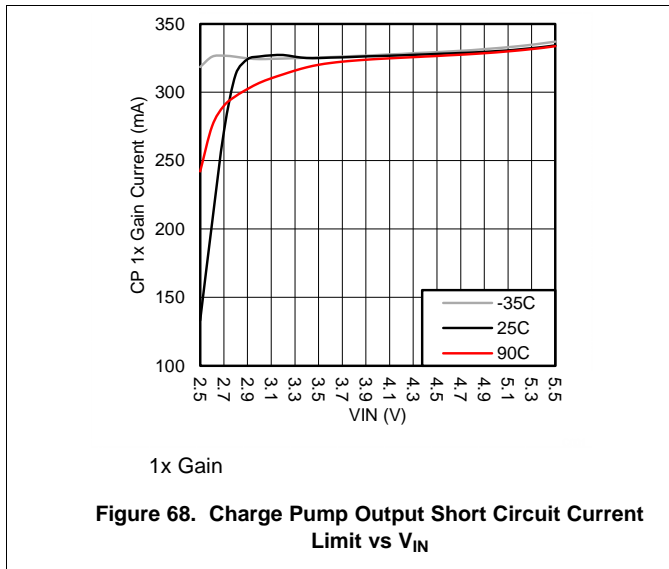
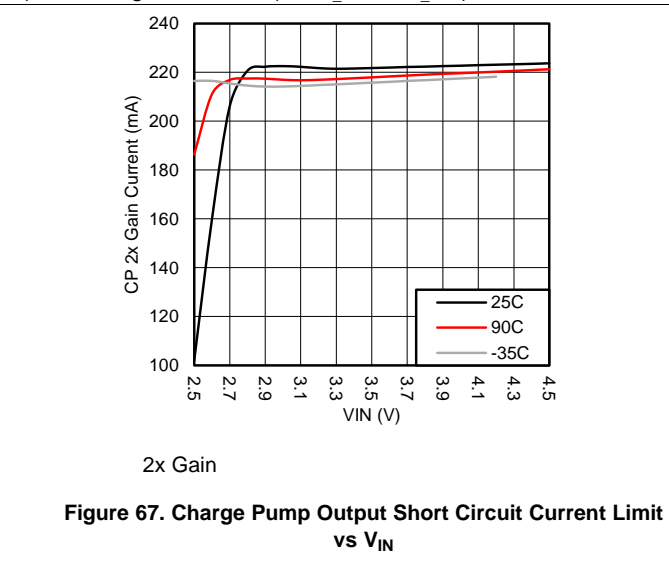
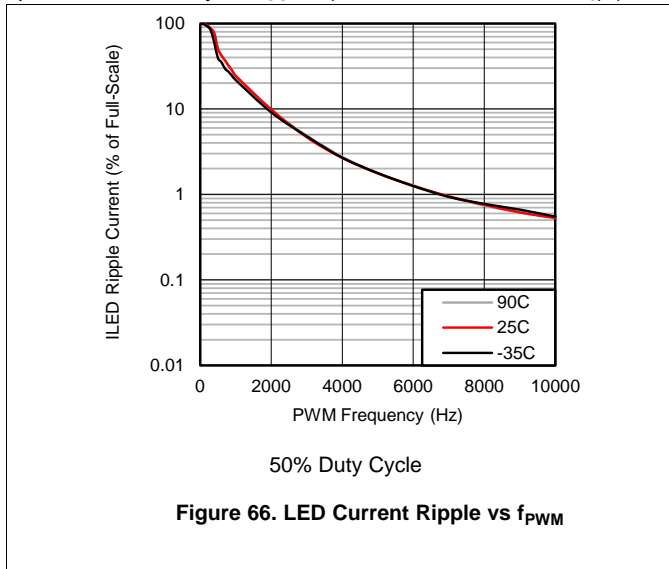

$V_{IN} = 3.6\text{ V}$ ,  $V_{LED} = 3.2\text{ V @ } 20\text{ mA}$ , Typical Application Circuit,  $T_A = 25^\circ\text{C}$ , Full-Scale Current = 20.2 mA unless otherwise specified. Efficiency is  $V_{OUT} \times (I_{HVLED1} + I_{HVLED2} + I_{HVLED3}) / (V_{IN} \times I_{IN})$ , matching curves are  $(\Delta I_{LED\_MAX} / I_{LED\_AVE})$ . See Table 37.

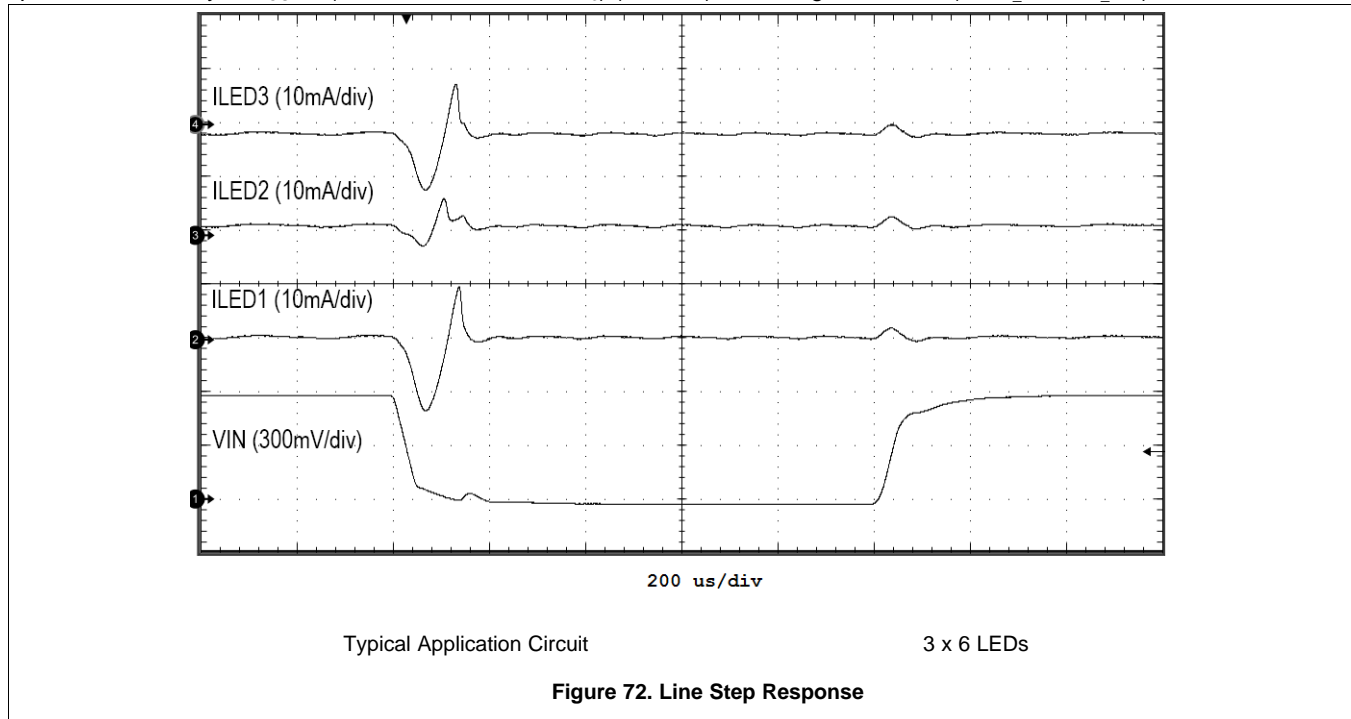

### 8.3 Initialization Set Up

Table 39 shows the minimum number of register writes required for a two-parallel, seven-series LED configuration. This example uses the default settings for ramp times (2048  $\mu\text{sec}$ ), mapping mode (exponential) and full-scale current (20.2 mA). In this mode of operation the LM3633 controls the brightness LSBs to ramp between the 8-bit MSB brightness levels providing 11-bit dimming while requiring only 8-bit commands from the host controller.

**Table 39. Control Bank A, 8-Bit Control, Two-String, Seven Series LED Configuration Example**

REGISTER NAME	ADDRESS	DATA	DESCRIPTION
HVLED Current Sink Output Configuration	0x10	0x04	HVLEDs 1 and 2 assigned to Control Bank A
HVLED Current Sink Feedback Enables	0x28	0x03	Enable feedback on HVLEDs 1 and 2, disable feedback on HVLED 3
Boost Control	0x2D	0x04	OVP = 32V, $f_{sw} = 500\text{ kHz}$
Control Bank Enabled	0x2B	0x01	Enable Control Bank A
Control A Brightness LSB	0x40	0x00	Control A Brightness LSB written only once
Control A Brightness MSB	0x41	User Value	Control A Brightness MSB updated as required

Table 40 shows the minimum number of register writes required for a two-parallel, six-series LED configuration with PWM Enabled. This example uses the default settings for ramp times (2048  $\mu\text{sec}$ ), mapping mode (exponential) and full-scale current (20.2 mA). In this mode of operation the host controller must update both the brightness LSB and MSB registers whenever a brightness change is required.

**Table 40. Control Bank A, 11-Bit Control, Two-String, Six Series LED Configuration Example**

REGISTER NAME	ADDRESS	DATA	DESCRIPTION
HVLED Current Sink Output Configuration	0x10	0x04	HVLEDs 1 and 2 assigned to Control Bank A
HVLED Current Sink Feedback Enables	0x28	0x03	Enable feedback on HVLEDs 1 and 2, disable feedback on HVLED 3

**Table 40. Control Bank A, 11-Bit Control, Two-String, Six Series LED Configuration Example (continued)**

REGISTER NAME	ADDRESS	DATA	DESCRIPTION
Boost Control	0x2D	0x03	OVP = 24V, $f_{sw} = 1$ MHz
PWM Configuration	0x2F	0x0D	PWM Zero Detect = Enabled, PWM Polarity = Active High, Control B PWM = Disabled, Control A PWM = Enabled
Control Bank Enabled	0x2B	0x01	Enable Control Bank A
Control A Brightness LSB	0x40	User Value	Control A Brightness LSB written as required (NOTE: The Brightness LSB change does not take effect until the Brightness MSB register is written.)
Control A Brightness MSB	0x41	User Value	Control A Brightness MSB updated as required <sup>(1)</sup>

(1) Anytime the Brightness LSB is changed the Brightness MSB must be written for the Brightness LSB change to take effect.)

Table 41 shows the minimum number of register writes required for five low-voltage indicator LEDs. This example uses the default settings for ramp times (2048  $\mu$ s), mapping mode (exponential) and charge pump and can be combined with either Table 39 or Table 40 above paying careful attention to the Brightness Configuration and Control Bank Enable registers (these registers control both high-voltage and low-voltage LEDs). In this mode of operation the host controller must update both Controls C and F brightness whenever a low-voltage LED brightness change is required. In this example the indicator LEDs is not synchronized due to the time delay between configuration of the Control C and Control F brightness settings. If synchronization of the indicator LED timing is required the user must enable the Control Bank after writing all Control Bank brightness registers.

**Table 41. Control Bank A Enable with Control Bank C and Control Bank F Low-Voltage LED Configuration Example**

REGISTER NAME	ADDRESS	DATA	DESCRIPTION
LVLED Current Sink Output Configuration	0x11	0x20	LVLEDs 1, 2, and 3 assigned to Control Bank C LVLED 4, 5 assigned to Control Bank F, LVLED 6 assigned to Control Bank H
Control C Full-Scale Current Setting	0x22	0x00	Set Full-Scale current to 5 mA
Control F Full-Scale Current Setting	0x25	0x00	Set Full-Scale current to 5 mA
LVLED Current Sink Feedback Enables	0x29	0x1F	Enable feedback on LVLEDs 1, 2, 3, 4, 5; LVLED 6 disabled
Control Bank Enable	0x2B	0x25	Enable LVLED Control Banks F and C with HVLED Control Bank A (If synchronization of indicator LEDs is required enable Control Bank after Control Banks C and F Brightness register configuration)
Control C Brightness	0x44	User Value	Control C Brightness written as required
Control F Brightness	0x47	User Value	Control F Brightness updated as required

Table 42 shows the minimum number of register writes required to configure the pattern generator for all six low-voltage indicator LEDs. This pattern sequences through all six indicator LEDs using a uniform delay time of 196.608 ms.

**Table 42. Low Voltage LED Pattern Generator Configuration Example**

REGISTER NAME	ADDRESS	DATA	DESCRIPTION
LVLED Current Sink Output Configuration	0x11	0x36	All low-voltage LED current sinks assigned to independent Control Banks
Control C Start-up/Shutdown Ramp Time	0x14	0x33	Set Start-up and Shutdown Ramp time to 1.049 seconds
Control D Start-up/Shutdown Ramp Time	0x15	0x33	Set Start-up and Shutdown Ramp time to 1.049 seconds
Control E Start-up/Shutdown Ramp Time	0x16	0x33	Set Start-up and Shutdown Ramp time to 1.049 seconds
Control F Start-up/Shutdown Ramp Time	0x17	0x33	Set Start-up and Shutdown Ramp time to 1.049 seconds

**Table 42. Low Voltage LED Pattern Generator Configuration Example (continued)**

REGISTER NAME	ADDRESS	DATA	DESCRIPTION
Control G Start-up/Shutdown Ramp Time	0x18	0x33	Set Start-up and Shutdown Ramp time to 1.049 seconds
Control H Start-up/Shutdown Ramp Time	0x19	0x33	Set Start-up and Shutdown Ramp time to 1.049 seconds
Control C/D/E Ramp Time	0x1C	0x33	Set Ramp Up/Down Transition time to 1.049 seconds
Control F/G/H Ramp Time	0x1D	0x33	Set Ramp Up/Down Transition time to 1.049 seconds
Control C Full-Scale Current Setting	0x22	0x00	Set Full-Scale current to 5 mA
Control D Full-Scale Current Setting	0x23	0x00	Set Full-Scale current to 5 mA
Control E Full-Scale Current Setting	0x24	0x00	Set Full-Scale current to 5 mA
Control F Full-Scale Current Setting	0x25	0x00	Set Full-Scale current to 5 mA
Control G Full-Scale Current Setting	0x26	0x00	Set Full-Scale current to 5 mA
Control H Full-Scale Current Setting	0x27	0x00	Set Full-Scale current to 5 mA
Control C Brightness	0x44	0xA5	Control C Brightness
Control D Brightness	0x45	0xA5	Control D Brightness
Control E Brightness	0x46	0xA5	Control E Brightness
Control F Brightness	0x47	0xA5	Control F Brightness
Control G Brightness	0x48	0xA5	Control G Brightness
Control H Brightness	0x49	0xA5	Control H Brightness
Control C Pattern Generator Delay Time	0x50	0x00	Set Control C Delay time to 16.384 ms
Control D Pattern Generator Delay Time	0x60	0x0C	Set Control D Delay time to 212.992 ms
Control E Pattern Generator Delay Time	0x70	0x18	Set Control E Delay time to 409.6 ms
Control F Pattern Generator Delay Time	0x80	0x24	Set Control F Delay time to 606.208 ms
Control G Pattern Generator Delay Time	0x90	0x30	Set Control G Delay time to 802.816 ms
Control H Pattern Generator Delay Time	0xA0	0x3C	Set Control H Delay time to 999.424 ms
Control C Pattern Generator Low Time	0x51	0x3A	Set Control C Low Time to 950.27 ms
Control D Pattern Generator Low Time	0x61	0x3A	Set Control D Low Time to 950.27 ms
Control E Pattern Generator Low Time	0x71	0x3A	Set Control E Low Time to 950.27 ms
Control F Pattern Generator Low Time	0x81	0x3A	Set Control F Low Time to 950.27 ms
Control G Pattern Generator Low Time	0x91	0x3A	Set Control G Low Time to 950.27 ms
Control H Pattern Generator Low Time	0xA1	0x3A	Set Control H Low Time to 950.27 ms
Control C Pattern Generator High Time	0x52	0x40	Set Control C High Time to 1507.33 ms
Control D Pattern Generator High Time	0x62	0x40	Set Control D High Time to 1507.33 ms
Control E Pattern Generator High Time	0x72	0x40	Set Control E High Time to 1507.33 ms

**Table 42. Low Voltage LED Pattern Generator Configuration Example (continued)**

REGISTER NAME	ADDRESS	DATA	DESCRIPTION
Control F Pattern Generator High Time	0x82	0x40	Set Control F High Time to 1507.33 ms
Control G Pattern Generator High Time	0x92	0x40	Set Control G High Time to 1507.33 ms
Control H Pattern Generator High Time	0xA2	0x40	Set Control H High Time to 1507.33 ms
Control C Pattern Generator Low-Level Brightness	0x53	0x01	Set Control C Low-Level Brightness
Control D Pattern Generator Low-Level Brightness	0x63	0x01	Set Control D Low-Level Brightness
Control E Pattern Generator Low-Level Brightness	0x73	0x01	Set Control E Low-Level Brightness
Control F Pattern Generator Low-Level Brightness	0x83	0x01	Set Control F Low-Level Brightness
Control G Pattern Generator Low-Level Brightness	0x93	0x01	Set Control G Low-Level Brightness
Control H Pattern Generator Low-Level Brightness	0xA3	0x01	Set Control H Low-Level Brightness
Pattern Generator Enables	0x2C	0xFC	Enable Control Bank C/D/E/F/G/H Pattern Generators
Control Bank Enables	0x2B	0xFC	Enable Control Banks C/D/E/F/G/H

## 9 Power Supply Recommendations

The LM3633 is designed to operate from an input supply range of 2.7 V to 5.5 V. This input supply should be well regulated and provide the peak current required by the High-voltage LED and Low-voltage LED configurations.

## 10 Layout

### 10.1 Layout Guidelines (Boost)

The LM3633 inductive boost converter detects a high switched voltage (up to  $V_{OVP}$ ) at the SW pin, and a step current (up to  $I_{CL\_BOOST}$ ) through the Schottky diode and output capacitor each switching cycle. The high switching voltage can create interference into nearby nodes due to electric field coupling ( $I = Cdv/dt$ ). The large step current through the diode and the output capacitor can cause a large voltage spike at the SW pin and the OVP pin due to parasitic inductance in the step current conducting path ( $V = Ldi/dt$ ). Board layout guidelines are geared towards minimizing this electric field coupling and conducted noise. [Figure 73](#) highlights these two noise-generating components.



Layout Guidelines (Boost) (continued)

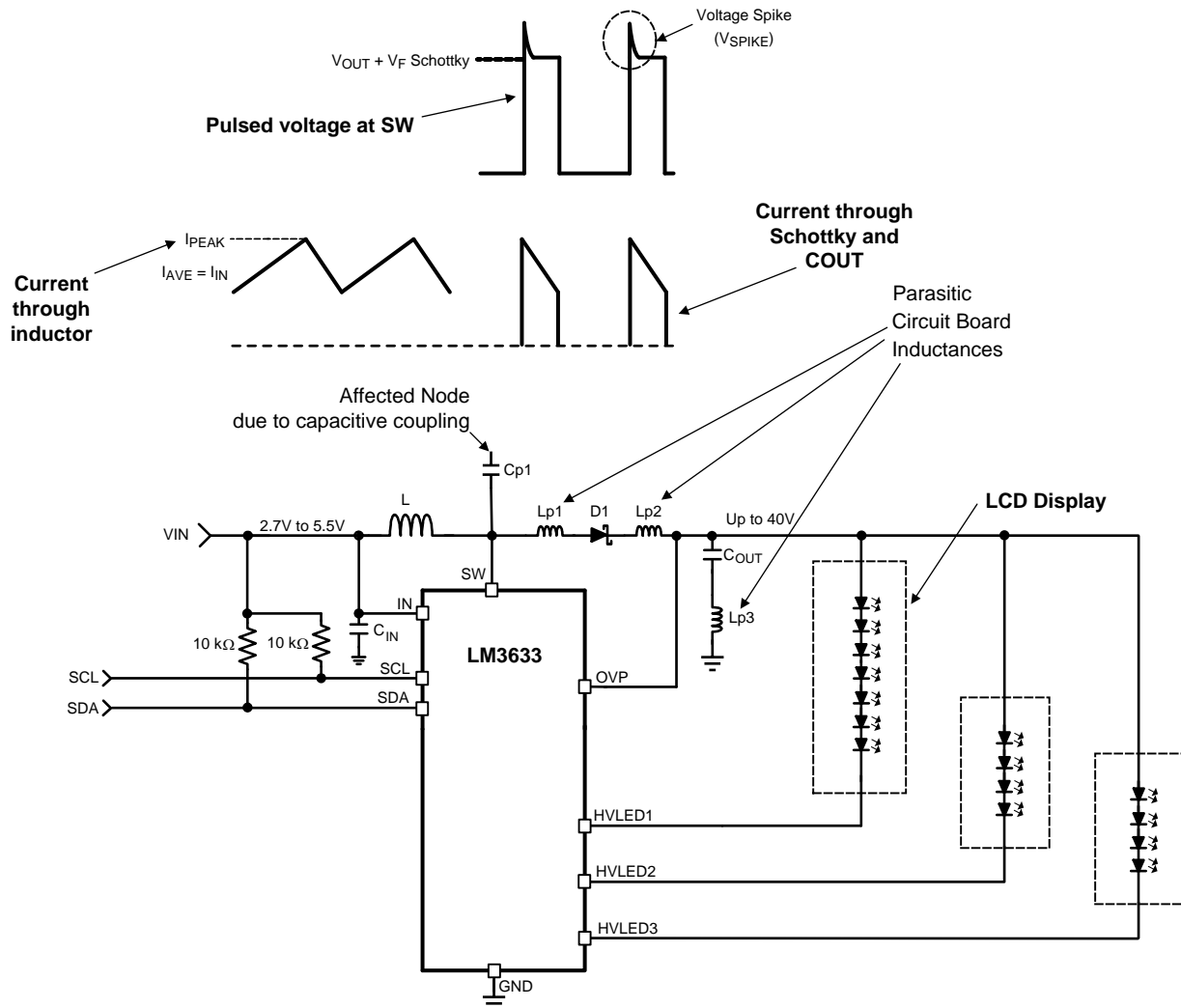

Figure 73. LM3633 Inductive Boost Converter Showing Pulsed Voltage at SW (High dv/dt) and Current Through Schottky and COUT (High di/dt)

The following list details the main (layout sensitive) areas of the LM3633 inductive boost converter in order of decreasing importance:

1. **Output Capacitor**
  - Schottky Cathode to COUT+
  - COUT- to GND
2. **Schottky Diode**
  - SW pin to Schottky Anode
  - Schottky Cathode to COUT+
3. **Inductor**
  - SW Node PCB capacitance to other traces
4. **Input Capacitor**
  - CIN+ to IN pin

## Layout Guidelines (Boost) (continued)

### 10.1.1 Boost Output Capacitor Placement

Because the output capacitor is in the path of the inductor current discharge path it sees a high-current step from 0 to  $I_{PEAK}$  each time the switch turns off and the Schottky diode turns on. Any inductance along this series path from the cathode of the diode through COUT and back into the LM3633 GND pin contributes to voltage spikes ( $V_{SPIKE} = L_P \times di/dt$ ) at SW and OUT. These spikes can potentially over-voltage the SW pin, or feed through to GND. To avoid this, COUT+ must be connected as close as possible to the Cathode of the Schottky diode, and COUT- must be connected as close as possible to the LM3633 GND bump. The best placement for COUT is on the same layer as the LM3633 so as to avoid any vias that can add excessive series inductance.

### 10.1.2 Schottky Diode Placement

In the LM3633 boost circuit the Schottky diode is in the path of the inductor current discharge. As a result the Schottky diode sees a high-current step from 0 to  $I_{PEAK}$  each time the switch turns off and the diode turns on. Any inductance in series with the diode causes a voltage spike ( $V_{SPIKE} = L_P \times di/dt$ ) at SW and OUT. This can potentially over-voltage the SW pin, or feed through to  $V_{OUT}$  and through the output capacitor and into GND. Connecting the anode of the diode as close as possible to the SW pin and the cathode of the diode as close as possible to COUT+ reduces the inductance ( $L_P$ ) and minimize these voltage spikes.

### 10.1.3 Inductor Placement

The node where the inductor connects to the LM3633 SW pin has 2 considerations. First, a large switched voltage (0 to  $V_{OUT} + V_{F\_SCHOTTKY}$ ) appears on this node every switching cycle. This switched voltage can be capacitively coupled into nearby nodes. Second, there is a relatively large current (input current) on the traces connecting the input supply to the inductor and connecting the inductor to the SW pin. Any resistance in this path can cause voltage drops that can negatively affect efficiency and reduce the input operating voltage range.

To reduce the capacitive coupling of the signal on SW into nearby traces, the SW bump-to-inductor connection must be minimized in area. This limits the PCB capacitance from SW to other traces. Additionally, high-impedance nodes that are more susceptible to electric field coupling need to be routed away from SW and not directly adjacent or beneath. This is especially true for traces such as SCL, SDA, HWEN, and PWM. A GND plane placed directly below SW dramatically reduces the capacitance from SW into nearby traces.

Lastly, limit the trace resistance of the VIN-to-inductor connection and from the inductor-to-SW connection, by use of short, wide traces.

### 10.1.4 Boost Input Capacitor Placement

For the LM3633 boost converter, the input capacitor filters the inductor current ripple, and the internal MOSFET driver currents during turnon of the internal power switch. The driver current requirement can range from 50 mA at 2.7 V to over 200 mA at 5.5 V with fast durations of approximately 10 ns to 20 ns. This appears as high di/dt current pulses coming from the input capacitor each time the switch turns on. Close placement of the input capacitor to the IN pin and to the GND pin is critical since any series inductance between IN and CIN+ or CIN- and GND can create voltage spikes that could appear on the VIN supply line and in the GND plane.

Close placement of the input bypass capacitor at the input side of the inductor is also critical. The source impedance (inductance and resistance) from the input supply, along with the input capacitor of the LM3633, form a series RLC circuit. If the output resistance from the source ( $R_S$ ) is low enough the circuit is underdamped and has a resonant frequency (typically the case). Depending on the size of  $L_S$  the resonant frequency could occur below, close to, or above the LM3633 switching frequency. This can cause the supply current ripple to be:

1. Approximately equal to the inductor current ripple when the resonant frequency occurs well above the LM3633 switching frequency;
2. Greater than the inductor current ripple when the resonant frequency occurs near the switching frequency; or
3. Less than the inductor current ripple when the resonant frequency occurs well below the switching frequency.

Figure 74 shows the series RLC circuit formed from the output impedance of the supply and the input capacitor.

The circuit is redrawn for the AC case where the VIN supply is replaced with a short to GND and the LM3633 + Inductor is replaced with a current source ( $\Delta I_L$ ). Equation 1 is the criteria for an underdamped response. Equation 2 is the resonant frequency. Equation 3 is the approximated supply current ripple as a function of  $L_S$ ,  $R_S$ , and  $C_{IN}$ .

## Layout Guidelines (Boost) (continued)

As an example, consider a 3.6-V supply with 0.1  $\Omega$  of series resistance connected to  $C_{IN}$  through 50 nH of connecting traces. This results in an under-damped input-filter circuit with a resonant frequency of 712 kHz. Since both the 1-MHz and 500-kHz switching frequency options lie close to the resonant frequency of the input filter, the supply current ripple is probably larger than the inductor current ripple. In this case, using equation 3, the supply current ripple can be approximated as 1.68 times the inductor current ripple (using a 500 kHz switching frequency) and 0.86 times the inductor current ripple using a 1-MHz switching frequency. Increasing the series inductance ( $L_S$ ) to 500 nH causes the resonant frequency to move to around 225 kHz, and the supply current ripple to be approximately 0.25 times the inductor current ripple (500-kHz switching frequency) and 0.053 times for a 1-MHz switching frequency.

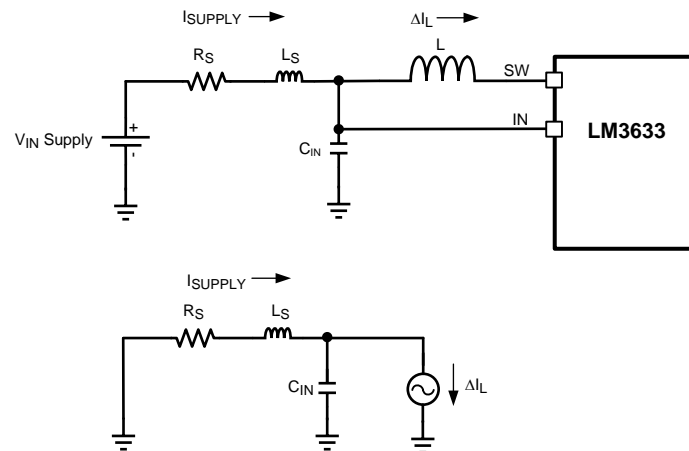

$$1. \frac{1}{L_S \times C_{IN}} > \frac{R_S^2}{4 \times L_S^2}$$

$$2. f_{RESONANT} = \frac{1}{2\pi \sqrt{L_S \times C_{IN}}}$$

$$3. I_{SUPPLYRIPPLE} \approx \Delta I_L \times \frac{1}{\sqrt{R_S^2 + \left(2\pi \times 500 \text{ kHz} \times L_S - \frac{1}{2\pi \times 500 \text{ kHz} \times C_{IN}}\right)^2}}$$

Figure 74. Input RLC Network

## 10.2 Layout Guidelines (Charge Pump)

The charge pump basically has three areas of concern regarding component placement:

1. The flying capacitor (CP)
2. The output capacitor (CPOUT)
3. The input capacitor

### 10.2.1 Flying Capacitor (CP) Placement

The charge pump flying capacitor must quickly charge up to the input voltage and then supply the current to the output every switching cycle. Since the charge-pump switching frequency is 1 MHz, the capacitor must be a low-inductance and low-resistive ceramic. Additionally, there must be a low-inductive connection from CP to the LM3633 flying capacitor pin C+ and C-. This is accomplished by placing CP as close as possible to the LM3633 and on the same layer to avoid vias.

## Layout Guidelines (Charge Pump) (continued)

### 10.2.2 Output Capacitor (CPOUT) Placement

The charge pump output capacitor sees the switched charge from the flying capacitor every switching cycle (1 MHz). This fast switching action requires that a low inductive and low resistive capacitor (ceramic) be used and that CPOUT be connected to the LM3633 CPOUT pin with a low inductive connection. This is done by placing CPOUT as close as possible to the CPOUT and GND pins of the LM3633 and on the same layer as the LM3633 to avoid vias.

### 10.2.3 Charge Pump Input Capacitor Placement

The input capacitor for the LM3633 charge pump is the same one used for the LM3633 inductive boost converter (see [Boost Input Capacitor Placement](#) section).

## 10.3 Layout Example

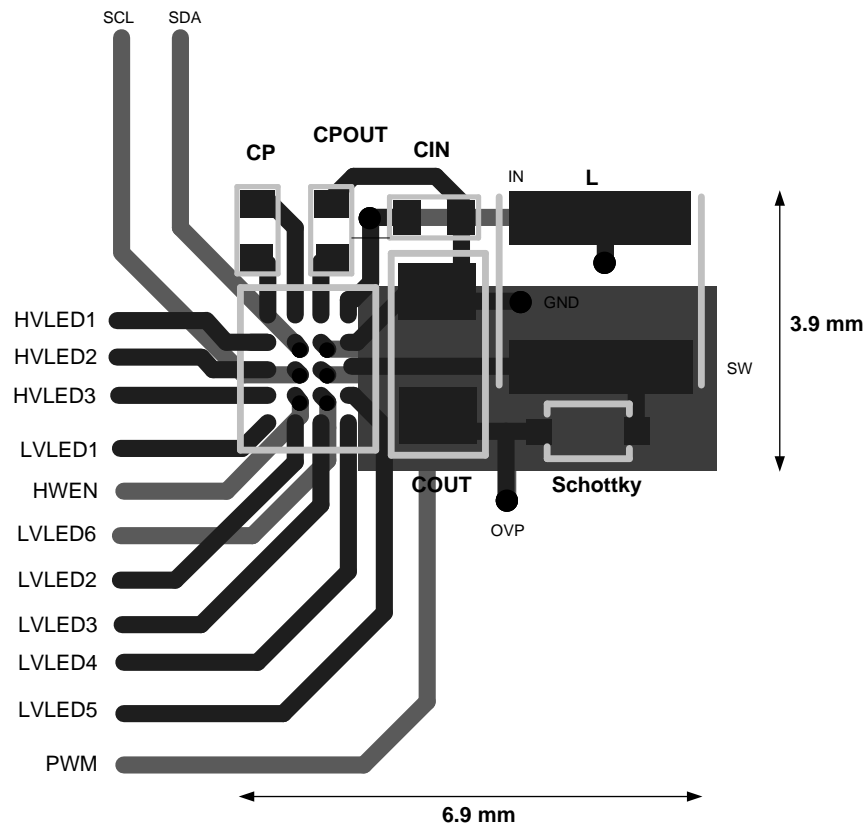

**Figure 75. LM3633 Example Layout**

## 11 Device and Documentation Support

### 11.1 Device Support

#### 11.1.1 Third-Party Products Disclaimer

TI'S PUBLICATION OF INFORMATION REGARDING THIRD-PARTY PRODUCTS OR SERVICES DOES NOT CONSTITUTE AN ENDORSEMENT REGARDING THE SUITABILITY OF SUCH PRODUCTS OR SERVICES OR A WARRANTY, REPRESENTATION OR ENDORSEMENT OF SUCH PRODUCTS OR SERVICES, EITHER ALONE OR IN COMBINATION WITH ANY TI PRODUCT OR SERVICE.

#### 11.2 Trademarks

All trademarks are the property of their respective owners.

#### 11.3 Electrostatic Discharge Caution



This integrated circuit can be damaged by ESD. Texas Instruments recommends that all integrated circuits be handled with appropriate precautions. Failure to observe proper handling and installation procedures can cause damage.

ESD damage can range from subtle performance degradation to complete device failure. Precision integrated circuits may be more susceptible to damage because very small parametric changes could cause the device not to meet its published specifications.

#### 11.4 Glossary

[SLYZ022](#) — *TI Glossary*.

This glossary lists and explains terms, acronyms and definitions.

## 12 Mechanical, Packaging, and Orderable Information

The following pages include mechanical, packaging, and orderable information. This information is the most current data available for the designated devices. This data is subject to change without notice and revision of this document. For browser-based versions of this data sheet, refer to the left-hand navigation.

**PACKAGING INFORMATION**

Orderable Device	Status (1)	Package Type	Package Drawing	Pins	Package Qty	Eco Plan (2)	Lead finish/ Ball material (6)	MSL Peak Temp (3)	Op Temp (°C)	Device Marking (4/5)	Samples
LM3633YFQR	ACTIVE	DSBGA	YFQ	20	3000	RoHS & Green	SNAGCU	Level-1-260C-UNLIM	-40 to 85	633B	<b>Samples</b>

(1) The marketing status values are defined as follows:

**ACTIVE:** Product device recommended for new designs.

**LIFEBUY:** TI has announced that the device will be discontinued, and a lifetime-buy period is in effect.

**NRND:** Not recommended for new designs. Device is in production to support existing customers, but TI does not recommend using this part in a new design.

**PREVIEW:** Device has been announced but is not in production. Samples may or may not be available.

**OBSOLETE:** TI has discontinued the production of the device.

(2) **RoHS:** TI defines "RoHS" to mean semiconductor products that are compliant with the current EU RoHS requirements for all 10 RoHS substances, including the requirement that RoHS substance do not exceed 0.1% by weight in homogeneous materials. Where designed to be soldered at high temperatures, "RoHS" products are suitable for use in specified lead-free processes. TI may reference these types of products as "Pb-Free".

**RoHS Exempt:** TI defines "RoHS Exempt" to mean products that contain lead but are compliant with EU RoHS pursuant to a specific EU RoHS exemption.

**Green:** TI defines "Green" to mean the content of Chlorine (Cl) and Bromine (Br) based flame retardants meet JS709B low halogen requirements of <=1000ppm threshold. Antimony trioxide based flame retardants must also meet the <=1000ppm threshold requirement.

(3) MSL, Peak Temp. - The Moisture Sensitivity Level rating according to the JEDEC industry standard classifications, and peak solder temperature.

(4) There may be additional marking, which relates to the logo, the lot trace code information, or the environmental category on the device.

(5) Multiple Device Markings will be inside parentheses. Only one Device Marking contained in parentheses and separated by a "-" will appear on a device. If a line is indented then it is a continuation of the previous line and the two combined represent the entire Device Marking for that device.

(6) Lead finish/Ball material - Orderable Devices may have multiple material finish options. Finish options are separated by a vertical ruled line. Lead finish/Ball material values may wrap to two lines if the finish value exceeds the maximum column width.

**Important Information and Disclaimer:** The information provided on this page represents TI's knowledge and belief as of the date that it is provided. TI bases its knowledge and belief on information provided by third parties, and makes no representation or warranty as to the accuracy of such information. Efforts are underway to better integrate information from third parties. TI has taken and continues to take reasonable steps to provide representative and accurate information but may not have conducted destructive testing or chemical analysis on incoming materials and chemicals. TI and TI suppliers consider certain information to be proprietary, and thus CAS numbers and other limited information may not be available for release.

In no event shall TI's liability arising out of such information exceed the total purchase price of the TI part(s) at issue in this document sold by TI to Customer on an annual basis.

**TAPE AND REEL INFORMATION**

**QUADRANT ASSIGNMENTS FOR PIN 1 ORIENTATION IN TAPE**

\*All dimensions are nominal

Device	Package Type	Package Drawing	Pins	SPQ	Reel Diameter (mm)	Reel Width W1 (mm)	A0 (mm)	B0 (mm)	K0 (mm)	P1 (mm)	W (mm)	Pin1 Quadrant
LM3633YFQR	DSBGA	YFQ	20	3000	178.0	8.4	1.89	2.2	0.76	4.0	8.0	Q1

**TAPE AND REEL BOX DIMENSIONS**

\*All dimensions are nominal

Device	Package Type	Package Drawing	Pins	SPQ	Length (mm)	Width (mm)	Height (mm)
LM3633YFQR	DSBGA	YFQ	20	3000	208.0	191.0	35.0





## IMPORTANT NOTICE AND DISCLAIMER

TI PROVIDES TECHNICAL AND RELIABILITY DATA (INCLUDING DATA SHEETS), DESIGN RESOURCES (INCLUDING REFERENCE DESIGNS), APPLICATION OR OTHER DESIGN ADVICE, WEB TOOLS, SAFETY INFORMATION, AND OTHER RESOURCES "AS IS" AND WITH ALL FAULTS, AND DISCLAIMS ALL WARRANTIES, EXPRESS AND IMPLIED, INCLUDING WITHOUT LIMITATION ANY IMPLIED WARRANTIES OF MERCHANTABILITY, FITNESS FOR A PARTICULAR PURPOSE OR NON-INFRINGEMENT OF THIRD PARTY INTELLECTUAL PROPERTY RIGHTS.

These resources are intended for skilled developers designing with TI products. You are solely responsible for (1) selecting the appropriate TI products for your application, (2) designing, validating and testing your application, and (3) ensuring your application meets applicable standards, and any other safety, security, regulatory or other requirements.

These resources are subject to change without notice. TI grants you permission to use these resources only for development of an application that uses the TI products described in the resource. Other reproduction and display of these resources is prohibited. No license is granted to any other TI intellectual property right or to any third party intellectual property right. TI disclaims responsibility for, and you will fully indemnify TI and its representatives against, any claims, damages, costs, losses, and liabilities arising out of your use of these resources.

TI's products are provided subject to [TI's Terms of Sale](#) or other applicable terms available either on [ti.com](https://www.ti.com) or provided in conjunction with such TI products. TI's provision of these resources does not expand or otherwise alter TI's applicable warranties or warranty disclaimers for TI products.

TI objects to and rejects any additional or different terms you may have proposed.

Mailing Address: Texas Instruments, Post Office Box 655303, Dallas, Texas 75265  
Copyright © 2024, Texas Instruments Incorporated