

# SN65C1406, SN75C1406 TRIPLE LOW-POWER DRIVERS/RECEIVERS

SLLS148E – MAY 1990 – REVISED OCTOBER 2001

- Meet or Exceed the Requirements of TIA/EIA-232-F and ITU Recommendation V.28
- Very Low Power Consumption . . . 5 mW Typ
- Wide Driver Supply Voltage Range . . .  $\pm 4.5$  V to  $\pm 15$  V
- Driver Output Slew Rate Limited to 30 V/ $\mu$ s Max
- Receiver Input Hysteresis . . . 1000 mV Typ
- Push-Pull Receiver Outputs
- On-Chip Receiver 1- $\mu$ s Noise Filter
- Functionally Interchangeable With Motorola MC145406 and Texas Instruments TL145406
- Package Options Include Plastic Small-Outline (D, DW, NS) Packages and DIPs (N)

SN65C1406 . . . D PACKAGE  
SN75C1406 . . . D, DW, N, OR NS PACKAGE  
(TOP VIEW)

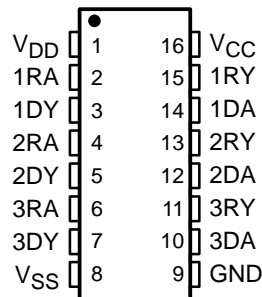

## description

The SN65C1406 and SN75C1406 are low-power BiMOS devices containing three independent drivers and receivers that are used to interface data terminal equipment (DTE) with data circuit-terminating equipment (DCE). These devices are designed to conform to TIA/EIA-232-F. The drivers and receivers of the SN65C1406 and SN75C1406 are similar to those of the SN75C188 quadruple driver and SN75C189A quadruple receiver, respectively. The drivers have a controlled output slew rate that is limited to a maximum of 30 V/ $\mu$ s, and the receivers have filters that reject input noise pulses shorter than 1  $\mu$ s. Both these features eliminate the need for external components.

The SN65C1406 and SN75C1406 are designed using low-power techniques in a BiMOS technology. In most applications, the receivers contained in these devices interface to single inputs of peripheral devices such as ACEs, UARTs, or microprocessors. By using sampling, such peripheral devices are usually insensitive to the transition times of the input signals. If this is not the case, or for other uses, it is recommended that the SN65C1406 and SN75C1406 receiver outputs be buffered by single Schmitt input gates or single gates of the HCMOS, ALS, or 74F logic families.

The SN65C1406 is characterized for operation from  $-40^{\circ}\text{C}$  to  $85^{\circ}\text{C}$ . The SN75C1406 is characterized for operation from  $0^{\circ}\text{C}$  to  $70^{\circ}\text{C}$ .

### AVAILABLE OPTIONS

T <sub>A</sub>	PACKAGED DEVICES			
	SMALL OUTLINE (D)	SMALL OUTLINE (DW)	PLASTIC DIP (N)	PLASTIC SMALL OUTLINE (NS)
$-40^{\circ}\text{C}$ to $85^{\circ}\text{C}$	SN65C1406D	—	—	—
$0^{\circ}\text{C}$ to $70^{\circ}\text{C}$	SN75C1406D	SN75C1406DW	SN75C1406N	SN75C1406NS

The D, DW, and PW packages are available taped and reeled. Add the suffix R to device type (e.g., SN75C1406DR).



Please be aware that an important notice concerning availability, standard warranty, and use in critical applications of Texas Instruments semiconductor products and disclaimers thereto appears at the end of this data sheet.

PRODUCTION DATA information is current as of publication date. Products conform to specifications per the terms of Texas Instruments standard warranty. Production processing does not necessarily include testing of all parameters.

 **TEXAS  
INSTRUMENTS**

POST OFFICE BOX 655303 • DALLAS, TEXAS 75265

Copyright © 2001, Texas Instruments Incorporated

# SN65C1406, SN75C1406 TRIPLE LOW-POWER DRIVERS/RECEIVERS

SLLS148E – MAY 1990 – REVISED OCTOBER 2001

---

## logic diagram (positive logic)

Typical of Each Receiver

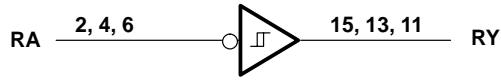

Typical of Each Driver

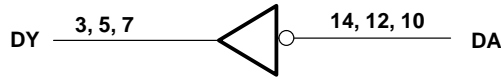

schematics of inputs and outputs

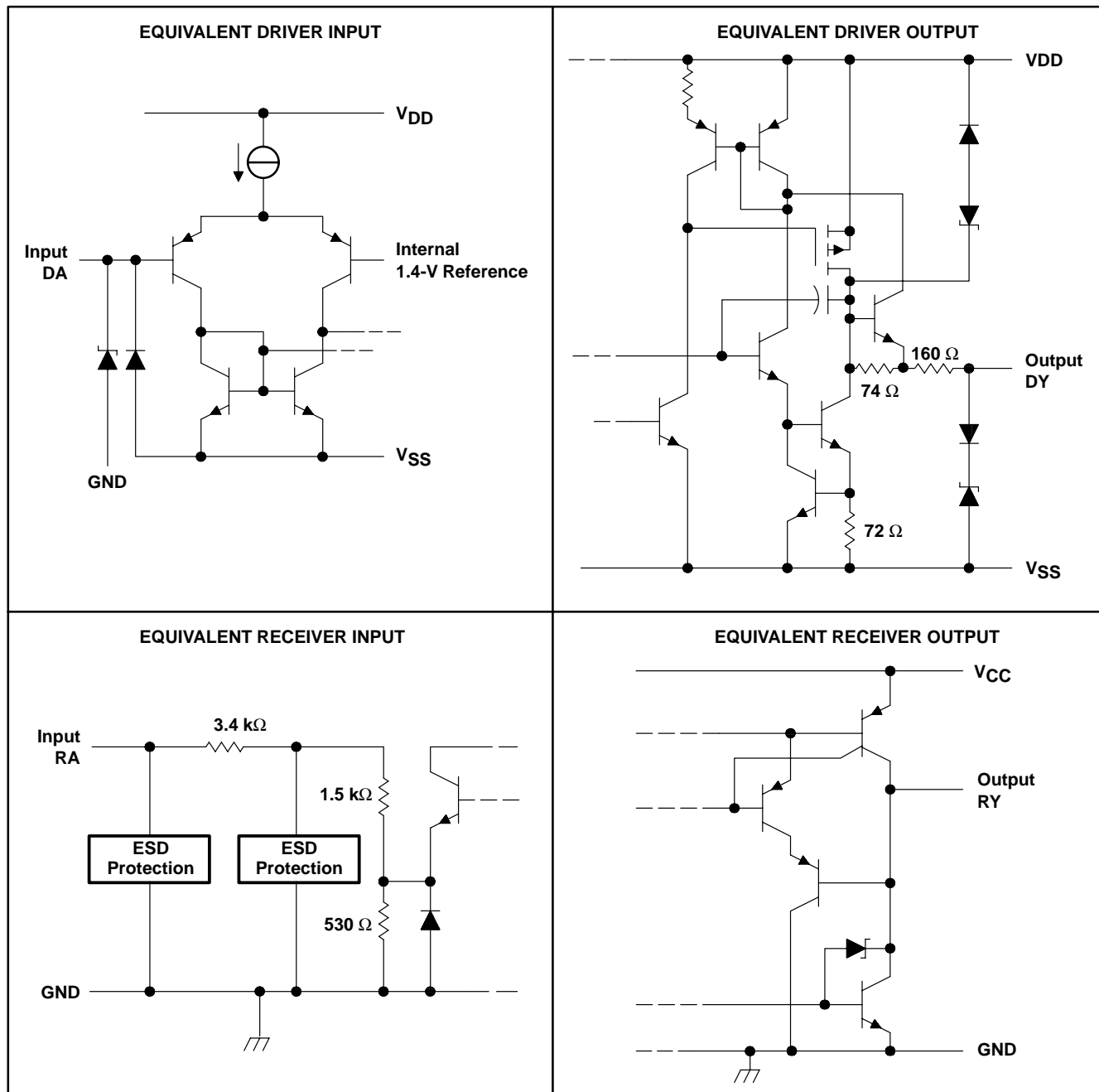

All resistor values shown are nominal.

# SN65C1406, SN75C1406 TRIPLE LOW-POWER DRIVERS/RECEIVERS

SLLS148E – MAY 1990 – REVISED OCTOBER 2001

## absolute maximum ratings over operating free-air temperature range (unless otherwise noted)†

Supply voltage: $V_{DD}$ (see Note 1)	15 V
$V_{SS}$	-15 V
$V_{CC}$	7 V
Input voltage range, $V_I$ : Driver	$V_{SS}$ to $V_{DD}$
Receiver	-30 V to 30 V
Output voltage range, $V_O$ : Driver	$(V_{SS} - 6 V)$ to $(V_{DD} + 6 V)$
Receiver	-0.3 V to $(V_{CC} + 0.3 V)$
Package thermal impedance, $\theta_{JA}$ (see Note 2): D package	73°C/W
DW package	57°C/W
N package	67°C/W
NS package	64°C/W
Lead temperature 1,6 mm (1/16 inch) from case for 10 seconds	260°C
Storage temperature range, $T_{stg}$	-65°C to 150 °C

† Stresses beyond those listed under “absolute maximum ratings” may cause permanent damage to the device. These are stress ratings only, and functional operation of the device at these or any other conditions beyond those indicated under “recommended operating conditions” is not implied. Exposure to absolute-maximum-rated conditions for extended periods may affect device reliability.

- NOTES: 1. All voltages are with respect to the network ground terminal.  
2. The package thermal impedance is calculated in accordance with JESD 51-7.

## recommended operating conditions

		MIN	NOM	MAX	UNIT
$V_{DD}$	Supply voltage	4.5	12	15	V
$V_{SS}$	Supply voltage	-4.5	-12	-15	V
$V_{CC}$	Supply voltage	4.5	5	6	V
$V_I$	Input voltage	Driver	$V_{SS}+2$	$V_{DD}$	V
		Receiver		$\pm 25$	
$V_{IH}$	High-level input voltage	2			V
$V_{IL}$	Low-level input voltage			0.8	V
$I_{OH}$	High-level output current			-1	mA
$I_{OL}$	Low-level output current			3.2	mA
$T_A$	Operating free-air temperature	SN65C1406	-40	85	°C
		SN75C1406	0	70	



DRIVER SECTION

electrical characteristics over operating free-air temperature range,  $V_{DD} = 12\text{ V}$ ,  $V_{SS} = -12\text{ V}$ ,  $V_{CC} = 5\text{ V} \pm 10\%$  (unless otherwise noted)

PARAMETER		TEST CONDITIONS		MIN	TYP†	MAX	UNIT
V <sub>OH</sub>	High-level output voltage	V <sub>IH</sub> = 0.8 V, R <sub>L</sub> = 3 k $\Omega$ , See Figure 1	V <sub>DD</sub> = 5 V, V <sub>SS</sub> = -5 V	4	4.5		V
			V <sub>DD</sub> = 12 V, V <sub>SS</sub> = -12 V	10	10.8		
V <sub>OL</sub>	Low-level output voltage (see Note 3)	V <sub>IH</sub> = 2 V, R <sub>L</sub> = 3 k $\Omega$ , See Figure 1	V <sub>DD</sub> = 5 V, V <sub>SS</sub> = -5 V		-4.4	-4	V
			V <sub>DD</sub> = 12 V, V <sub>SS</sub> = -12 V		-10.7	-10	
I <sub>IH</sub>	High-level input current	V <sub>I</sub> = 5 V, See Figure 2				1	$\mu\text{A}$
I <sub>IL</sub>	Low-level input current	V <sub>I</sub> = 0, See Figure 2				-1	$\mu\text{A}$
I <sub>OS(H)</sub>	High-level short-circuit output current‡	V <sub>I</sub> = 0.8 V, V <sub>O</sub> = 0 or V <sub>SS</sub> , See Figure 1		-7.5	-12	-19.5	mA
I <sub>OS(L)</sub>	Low-level short-circuit output current‡	V <sub>I</sub> = 2 V, V <sub>O</sub> = 0 or V <sub>DD</sub> , See Figure 1		7.5	12	19.5	mA
I <sub>DD</sub>	Supply current from V <sub>DD</sub>	No load, All inputs at 2 V or 0.8 V	V <sub>DD</sub> = 5 V, V <sub>SS</sub> = -5 V		115	250	$\mu\text{A}$
			V <sub>DD</sub> = 12 V, V <sub>SS</sub> = -12 V		115	250	
I <sub>SS</sub>	Supply current from V <sub>SS</sub>	No load, All inputs at 2 V or 0.8 V	V <sub>DD</sub> = 5 V, V <sub>SS</sub> = -5 V		-115	-250	$\mu\text{A}$
			V <sub>DD</sub> = 12 V, V <sub>SS</sub> = -12 V		-115	-250	
r <sub>O</sub>	Output resistance	V <sub>DD</sub> = V <sub>SS</sub> = V <sub>CC</sub> = 0, See Note 4	V <sub>O</sub> = -2 V to 2 V,	300	400		$\Omega$

† All typical values are at T<sub>A</sub> = 25°C.

‡ Not more than one output should be shorted at a time.

NOTES: 3. The algebraic convention, where the more positive (less negative) limit is designated as maximum, is used in this data sheet for logic levels only.

4. Test conditions are those specified by TIA/EIA-232-F.

switching characteristics at T<sub>A</sub> = 25°C, V<sub>DD</sub> = 12 V, V<sub>SS</sub> = -12 V, V<sub>CC</sub> = 5 V  $\pm$  10%

PARAMETER		TEST CONDITIONS		MIN	TYP	MAX	UNIT
t <sub>PLH</sub>	Propagation delay time, low- to high-level output§	R <sub>L</sub> = 3 k $\Omega$ to 7 k $\Omega$ , C <sub>L</sub> = 15 pF, See Figure 3			1.2	3	$\mu\text{s}$
t <sub>PHL</sub>	Propagation delay time, high- to low-level output§	R <sub>L</sub> = 3 k $\Omega$ to 7 k $\Omega$ , C <sub>L</sub> = 15 pF, See Figure 3			2.5	3.5	$\mu\text{s}$
t <sub>TLH</sub>	Transition time, low- to high-level output¶	R <sub>L</sub> = 3 k $\Omega$ to 7 k $\Omega$ , C <sub>L</sub> = 15 pF, See Figure 3		0.53	2	3.2	$\mu\text{s}$
t <sub>THL</sub>	Transition time, high- to low-level output¶	R <sub>L</sub> = 3 k $\Omega$ to 7 k $\Omega$ , C <sub>L</sub> = 15 pF, See Figure 3		0.53	2	3.2	$\mu\text{s}$
t <sub>TLH</sub>	Transition time, low- to high-level output#	R <sub>L</sub> = 3 k $\Omega$ to 7 k $\Omega$ , C <sub>L</sub> = 2500 pF, See Figure 3			1	2	$\mu\text{s}$
t <sub>THL</sub>	Transition time, high- to low-level output#	R <sub>L</sub> = 3 k $\Omega$ to 7 k $\Omega$ , C <sub>L</sub> = 2500 pF, See Figure 3			1	2	$\mu\text{s}$
SR	Output slew rate	R <sub>L</sub> = 3 k $\Omega$ to 7 k $\Omega$ , C <sub>L</sub> = 15 pF, See Figure 3		4	10	30	V/ $\mu\text{s}$

§ t<sub>PHL</sub> and t<sub>PLH</sub> include the additional time due to on-chip slew rate and are measured at the 50% points.

¶ Measured between 10% and 90% points of output waveform

# Measured between 3-V and -3-V points of output waveform (TIA/EIA-232-F conditions) with all unused inputs tied either high or low

# SN65C1406, SN75C1406 TRIPLE LOW-POWER DRIVERS/RECEIVERS

SLLS148E – MAY 1990 – REVISED OCTOBER 2001

## RECEIVER SECTION

electrical characteristics over operating free-air temperature range,  $V_{DD} = 12\text{ V}$ ,  $V_{SS} = -12\text{ V}$ ,  $V_{CC} = 5\text{ V} \pm 10\%$  (unless otherwise noted)

PARAMETER		TEST CONDITIONS	MIN	TYP†	MAX	UNIT
$V_{IT+}$	Positive-going input threshold voltage	See Figure 5	1.7	2	2.55	V
$V_{IT-}$	Negative-going input threshold voltage	See Figure 5	0.65	1	1.25	V
$V_{hys}$	Input hysteresis voltage ( $V_{IT+} - V_{IT-}$ )		600	1000		mV
$V_{OH}$	High-level output voltage	$V_I = 0.75\text{ V}$ , $I_{OH} = -20\text{ }\mu\text{A}$ , See Figure 5 and Note 5	3.5			V
		$V_I = 0.75\text{ V}$ , $I_{OH} = -1\text{ mA}$ , See Figure 5	$V_{CC} = 4.5\text{ V}$	2.8	4.4	
			$V_{CC} = 5\text{ V}$	3.8	4.9	
		$V_{CC} = 5.5\text{ V}$	4.3	5.4		
$V_{OL}$	Low-level output voltage	$V_I = 3\text{ V}$ , $I_{OL} = 3.2\text{ mA}$ , See Figure 5		0.17	0.4	V
$I_{IH}$	High-level input current	$V_I = 2.5\text{ V}$	3.6	4.6	8.3	mA
		$V_I = 3\text{ V}$	0.43	0.55	1	
$I_{IL}$	Low-level input current	$V_I = -2.5\text{ V}$	-3.6	-5	-8.3	mA
		$V_I = -3\text{ V}$	-0.43	-0.55	-1	
$I_{OS(H)}$	High-level short-circuit output current	$V_I = 0.75\text{ V}$ , $V_O = 0$ , See Figure 4		-8	-15	mA
$I_{OS(L)}$	Low-level short-circuit output current	$V_I = V_{CC}$ , $V_O = V_{CC}$ , See Figure 4		13	25	mA
$I_{CC}$	Supply current from $V_{CC}$	No load, All inputs at 0 or 5 V	$V_{DD} = 5\text{ V}$ , $V_{SS} = -5\text{ V}$	320	450	$\mu\text{A}$
			$V_{DD} = 12\text{ V}$ , $V_{SS} = -12\text{ V}$	320	450	

† All typical values are at  $T_A = 25^\circ\text{C}$ .

NOTE 5: If the inputs are left unconnected, the receiver interprets this as an input low and the receiver outputs remain in the high state.

switching characteristics at  $T_A = 25^\circ\text{C}$ ,  $V_{DD} = 12\text{ V}$ ,  $V_{SS} = -12\text{ V}$ ,  $V_{CC} = 5\text{ V} \pm 10\%$  (unless otherwise noted)

PARAMETER		TEST CONDITIONS	MIN	TYP	MAX	UNIT
$t_{PLH}$	Propagation delay time, low- to high-level output	$C_L = 50\text{ pF}$ , $R_L = 5\text{ k}\Omega$ , See Figure 6		3	4	$\mu\text{s}$
$t_{PHL}$	Propagation delay time, high- to low-level output	$C_L = 50\text{ pF}$ , $R_L = 5\text{ k}\Omega$ , See Figure 6		3	4	$\mu\text{s}$
$t_{TLH}$	Transition time, low- to high-level output‡	$C_L = 50\text{ pF}$ , $R_L = 5\text{ k}\Omega$ , See Figure 6		300	450	ns
$t_{THL}$	Transition time, high- to low-level output‡	$C_L = 50\text{ pF}$ , $R_L = 5\text{ k}\Omega$ , See Figure 6		100	300	ns
$t_{W(N)}$	Duration of longest pulse rejected as noise§	$C_L = 50\text{ pF}$ , $R_L = 5\text{ k}\Omega$	1		4	$\mu\text{s}$

‡ Measured between 10% and 90% points of output waveform

§ The receiver ignores any positive- or negative-going pulse that is less than the minimum value of  $t_{W(N)}$  and accepts any positive- or negative-going pulse greater than the maximum of  $t_{W(N)}$ .



PARAMETER MEASUREMENT INFORMATION

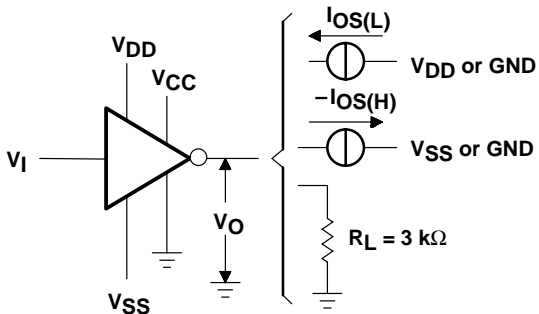

Figure 1. Driver Test Circuit  
 $V_{OH}$ ,  $V_{OL}$ ,  $I_{OS(L)}$ ,  $I_{OS(H)}$

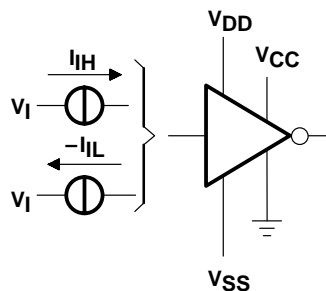
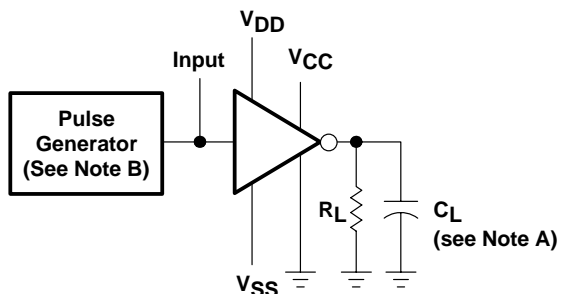
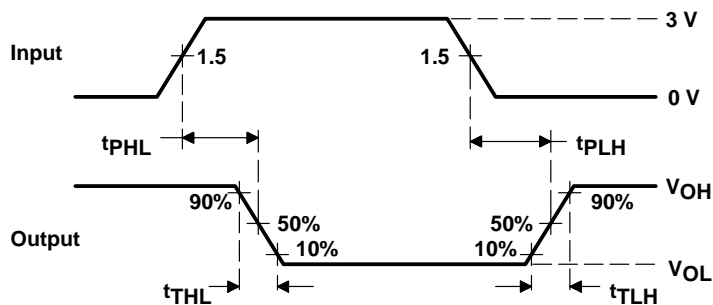

Figure 2. Driver Test Circuit,  $I_{iL}$ ,  $I_{iH}$



TEST CIRCUIT



VOLTAGE WAVEFORMS

NOTES: A.  $C_L$  includes probe and jig capacitance.  
B. The pulse generator has the following characteristics:  $t_w = 25 \mu s$ ,  $PRR = 20 \text{ kHz}$ ,  $Z_O = 50 \Omega$ ,  $t_r = t_f < 50 \text{ ns}$ .

Figure 3. Driver Test Circuit and Voltage Waveforms

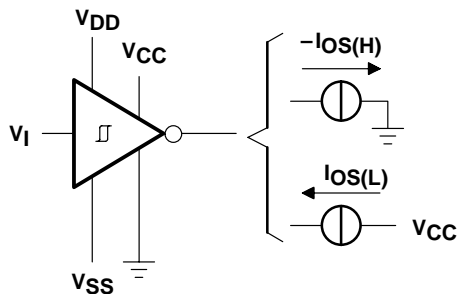

Figure 4. Receiver Test Circuit,  $I_{OS(H)}$ ,  $I_{OS(L)}$

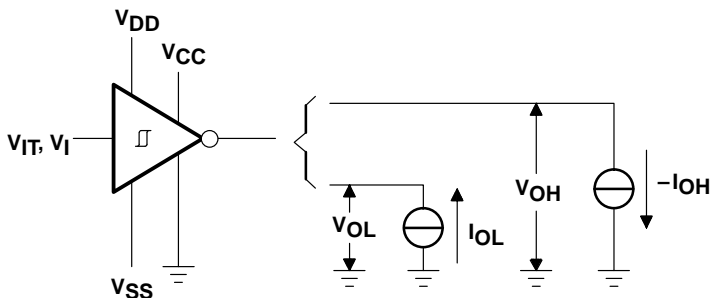
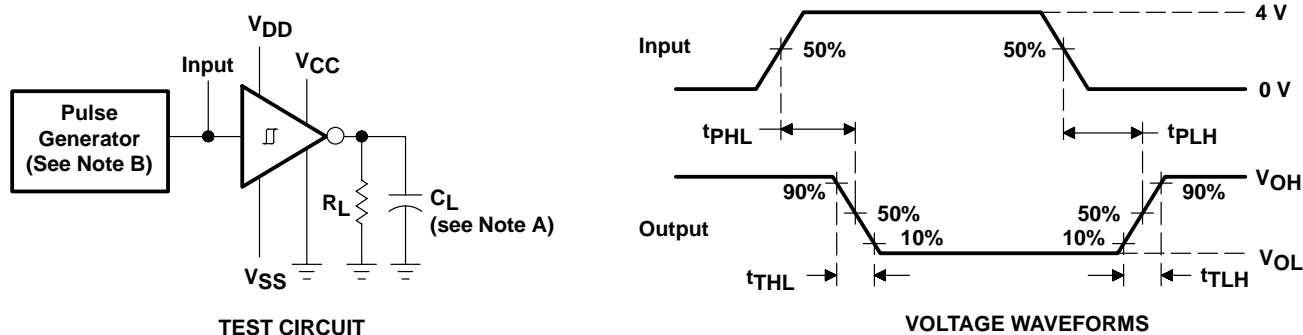

Figure 5. Receiver Test Circuit,  $V_{IT}$ ,  $V_{OL}$ ,  $V_{OH}$

# SN65C1406, SN75C1406 TRIPLE LOW-POWER DRIVERS/RECEIVERS

SLLS148E – MAY 1990 – REVISED OCTOBER 2001

## PARAMETER MEASUREMENT INFORMATION



NOTES: C.  $C_L$  includes probe and jig capacitance.  
D. The pulse generator has the following characteristics:  $t_w = 25 \mu s$ ,  $PRR = 20 \text{ kHz}$ ,  $Z_O = 50 \Omega$ ,  $t_r = t_f < 50 \text{ ns}$ .

Figure 6. Receiver Test Circuit and Voltage Waveforms

## APPLICATION INFORMATION

The TIA/EIA-232-F specification is for data interchange between a host computer and a peripheral at signaling rates up to 20 kbit/s. Many TIA/EIA-232-F devices will operate at higher data rates with lower capacitive loads (short cables). For reliable operation at greater than 20 kbit/s, the designer needs to have control of both ends of the cable. By mixing different types of TIA/EIA-232-F devices and cable lengths, errors can occur at higher frequencies (above 20 kbit/s). When operating within the TIA/EIA-232-F requirements of less than 20 kbit/s and with compliant line circuits, interoperability is assured. For applications operating above 20 kbit/s, the design engineer should consider devices and system designs that meet the TIA/EIA-232-F requirements.



**PACKAGING INFORMATION**

Orderable Device	Status (1)	Package Type	Package Drawing	Pins	Package Qty	Eco Plan (2)	Lead finish/ Ball material (6)	MSL Peak Temp (3)	Op Temp (°C)	Device Marking (4/5)	Samples
SN65C1406D	ACTIVE	SOIC	D	16	40	RoHS & Green	NIPDAU	Level-1-260C-UNLIM	-40 to 85	65C1406	Samples
SN65C1406DR	ACTIVE	SOIC	D	16	2500	RoHS & Green	NIPDAU	Level-1-260C-UNLIM	-40 to 85	65C1406	Samples
SN75C1406D	ACTIVE	SOIC	D	16	40	RoHS & Green	NIPDAU	Level-1-260C-UNLIM	0 to 70	SN75C1406	Samples
SN75C1406DR	ACTIVE	SOIC	D	16	2500	RoHS & Green	NIPDAU	Level-1-260C-UNLIM	0 to 70	SN75C1406	Samples
SN75C1406DW	ACTIVE	SOIC	DW	16	40	RoHS & Green	NIPDAU	Level-1-260C-UNLIM	0 to 70	SN75C1406	Samples
SN75C1406DWR	ACTIVE	SOIC	DW	16	2000	RoHS & Green	NIPDAU	Level-1-260C-UNLIM	0 to 70	SN75C1406	Samples
SN75C1406N	ACTIVE	PDIP	N	16	25	RoHS & Green	NIPDAU	N / A for Pkg Type	0 to 70	SN75C1406N	Samples
SN75C1406NSR	ACTIVE	SO	NS	16	2000	RoHS & Green	NIPDAU	Level-1-260C-UNLIM	0 to 70	SN75C1406	Samples

(1) The marketing status values are defined as follows:

**ACTIVE:** Product device recommended for new designs.

**LIFEBUY:** TI has announced that the device will be discontinued, and a lifetime-buy period is in effect.

**NRND:** Not recommended for new designs. Device is in production to support existing customers, but TI does not recommend using this part in a new design.

**PREVIEW:** Device has been announced but is not in production. Samples may or may not be available.

**OBSOLETE:** TI has discontinued the production of the device.

(2) **RoHS:** TI defines "RoHS" to mean semiconductor products that are compliant with the current EU RoHS requirements for all 10 RoHS substances, including the requirement that RoHS substance do not exceed 0.1% by weight in homogeneous materials. Where designed to be soldered at high temperatures, "RoHS" products are suitable for use in specified lead-free processes. TI may reference these types of products as "Pb-Free".

**RoHS Exempt:** TI defines "RoHS Exempt" to mean products that contain lead but are compliant with EU RoHS pursuant to a specific EU RoHS exemption.

**Green:** TI defines "Green" to mean the content of Chlorine (Cl) and Bromine (Br) based flame retardants meet JS709B low halogen requirements of <=1000ppm threshold. Antimony trioxide based flame retardants must also meet the <=1000ppm threshold requirement.

(3) MSL, Peak Temp. - The Moisture Sensitivity Level rating according to the JEDEC industry standard classifications, and peak solder temperature.

(4) There may be additional marking, which relates to the logo, the lot trace code information, or the environmental category on the device.

(5) Multiple Device Markings will be inside parentheses. Only one Device Marking contained in parentheses and separated by a "~" will appear on a device. If a line is indented then it is a continuation of the previous line and the two combined represent the entire Device Marking for that device.

<sup>(6)</sup> Lead finish/Ball material - Orderable Devices may have multiple material finish options. Finish options are separated by a vertical ruled line. Lead finish/Ball material values may wrap to two lines if the finish value exceeds the maximum column width.

**Important Information and Disclaimer:** The information provided on this page represents TI's knowledge and belief as of the date that it is provided. TI bases its knowledge and belief on information provided by third parties, and makes no representation or warranty as to the accuracy of such information. Efforts are underway to better integrate information from third parties. TI has taken and continues to take reasonable steps to provide representative and accurate information but may not have conducted destructive testing or chemical analysis on incoming materials and chemicals. TI and TI suppliers consider certain information to be proprietary, and thus CAS numbers and other limited information may not be available for release.

In no event shall TI's liability arising out of such information exceed the total purchase price of the TI part(s) at issue in this document sold by TI to Customer on an annual basis.

## TAPE AND REEL INFORMATION



### QUADRANT ASSIGNMENTS FOR PIN 1 ORIENTATION IN TAPE



\*All dimensions are nominal

Device	Package Type	Package Drawing	Pins	SPQ	Reel Diameter (mm)	Reel Width W1 (mm)	A0 (mm)	B0 (mm)	K0 (mm)	P1 (mm)	W (mm)	Pin1 Quadrant
SN65C1406DR	SOIC	D	16	2500	330.0	16.4	6.5	10.3	2.1	8.0	16.0	Q1
SN75C1406DR	SOIC	D	16	2500	330.0	16.4	6.5	10.3	2.1	8.0	16.0	Q1
SN75C1406DWR	SOIC	DW	16	2000	330.0	16.4	10.75	10.7	2.7	12.0	16.0	Q1
SN75C1406NSR	SO	NS	16	2000	330.0	16.4	8.2	10.5	2.5	12.0	16.0	Q1

## TAPE AND REEL BOX DIMENSIONS



\*All dimensions are nominal

Device	Package Type	Package Drawing	Pins	SPQ	Length (mm)	Width (mm)	Height (mm)
SN65C1406DR	SOIC	D	16	2500	340.5	336.1	32.0
SN75C1406DR	SOIC	D	16	2500	340.5	336.1	32.0
SN75C1406DWR	SOIC	DW	16	2000	350.0	350.0	43.0
SN75C1406NSR	SO	NS	16	2000	356.0	356.0	35.0

**TUBE**

\*All dimensions are nominal

Device	Package Name	Package Type	Pins	SPQ	L (mm)	W (mm)	T (μm)	B (mm)
SN65C1406D	D	SOIC	16	40	507	8	3940	4.32
SN75C1406D	D	SOIC	16	40	507	8	3940	4.32
SN75C1406DW	DW	SOIC	16	40	506.98	12.7	4826	6.6
SN75C1406N	N	PDIP	16	25	506	13.97	11230	4.32

D (R-PDSO-G16)

PLASTIC SMALL OUTLINE



- NOTES:
- A. All linear dimensions are in inches (millimeters).
  - B. This drawing is subject to change without notice.
  - C. Body length does not include mold flash, protrusions, or gate burrs. Mold flash, protrusions, or gate burrs shall not exceed 0.006 (0,15) each side.
  - D. Body width does not include interlead flash. Interlead flash shall not exceed 0.017 (0,43) each side.
  - E. Reference JEDEC MS-012 variation AC.

D (R-PDSO-G16)

PLASTIC SMALL OUTLINE



4211283-4/E 08/12

- NOTES:
- A. All linear dimensions are in millimeters.
  - B. This drawing is subject to change without notice.
  - C. Publication IPC-7351 is recommended for alternate designs.
  - D. Laser cutting apertures with trapezoidal walls and also rounding corners will offer better paste release. Customers should contact their board assembly site for stencil design recommendations. Refer to IPC-7525 for other stencil recommendations.
  - E. Customers should contact their board fabrication site for solder mask tolerances between and around signal pads.

# MECHANICAL DATA

NS (R-PDSO-G\*\*)

PLASTIC SMALL-OUTLINE PACKAGE

14-PINS SHOWN



- NOTES:
- A. All linear dimensions are in millimeters.
  - B. This drawing is subject to change without notice.
  - C. Body dimensions do not include mold flash or protrusion, not to exceed 0,15.



## GENERIC PACKAGE VIEW

**DW 16**

**SOIC - 2.65 mm max height**

7.5 x 10.3, 1.27 mm pitch

SMALL OUTLINE INTEGRATED CIRCUIT

This image is a representation of the package family, actual package may vary.  
Refer to the product data sheet for package details.



4224780/A



# DW0016A

# PACKAGE OUTLINE SOIC - 2.65 mm max height

SOIC



4220721/A 07/2016

### NOTES:

- All linear dimensions are in millimeters. Dimensions in parenthesis are for reference only. Dimensioning and tolerancing per ASME Y14.5M.
- This drawing is subject to change without notice.
- This dimension does not include mold flash, protrusions, or gate burrs. Mold flash, protrusions, or gate burrs shall not exceed 0.15 mm, per side.
- This dimension does not include interlead flash. Interlead flash shall not exceed 0.25 mm, per side.
- Reference JEDEC registration MS-013.

# EXAMPLE BOARD LAYOUT

DW0016A

SOIC - 2.65 mm max height

SOIC



LAND PATTERN EXAMPLE  
SCALE:7X



SOLDER MASK DETAILS

4220721/A 07/2016

NOTES: (continued)

6. Publication IPC-7351 may have alternate designs.

7. Solder mask tolerances between and around signal pads can vary based on board fabrication site.

# EXAMPLE STENCIL DESIGN

DW0016A

SOIC - 2.65 mm max height

SOIC



SOLDER PASTE EXAMPLE  
BASED ON 0.125 mm THICK STENCIL  
SCALE:7X

4220721/A 07/2016

NOTES: (continued)

8. Laser cutting apertures with trapezoidal walls and rounded corners may offer better paste release. IPC-7525 may have alternate design recommendations.
9. Board assembly site may have different recommendations for stencil design.

N (R-PDIP-T\*\*)

PLASTIC DUAL-IN-LINE PACKAGE

16 PINS SHOWN



- NOTES:
- A. All linear dimensions are in inches (millimeters).
  - B. This drawing is subject to change without notice.
  - $\triangle C$  Falls within JEDEC MS-001, except 18 and 20 pin minimum body length (Dim A).
  - $\triangle D$  The 20 pin end lead shoulder width is a vendor option, either half or full width.



# PACKAGE OUTLINE

## NS0016A

### SOP - 2.00 mm max height

SOP



4220735/A 12/2021

#### NOTES:

1. All linear dimensions are in millimeters. Dimensions in parenthesis are for reference only. Dimensioning and tolerancing per ASME Y14.5M.
2. This drawing is subject to change without notice.
3. This dimension does not include mold flash, protrusions, or gate burrs. Mold flash, protrusions, or gate burrs shall not exceed 0.15 mm, per side.
4. This dimension does not include interlead flash. Interlead flash shall not exceed 0.25 mm, per side.

# EXAMPLE BOARD LAYOUT

NS0016A

SOP - 2.00 mm max height

SOP



SOLDER MASK DETAILS

4220735/A 12/2021

NOTES: (continued)

5. Publication IPC-7351 may have alternate designs.

6. Solder mask tolerances between and around signal pads can vary based on board fabrication site.

# EXAMPLE STENCIL DESIGN

NS0016A

SOP - 2.00 mm max height

SOP



SOLDER PASTE EXAMPLE  
BASED ON 0.125 mm THICK STENCIL  
SCALE:7X

4220735/A 12/2021

NOTES: (continued)

7. Laser cutting apertures with trapezoidal walls and rounded corners may offer better paste release. IPC-7525 may have alternate design recommendations.
8. Board assembly site may have different recommendations for stencil design.



## IMPORTANT NOTICE AND DISCLAIMER

TI PROVIDES TECHNICAL AND RELIABILITY DATA (INCLUDING DATA SHEETS), DESIGN RESOURCES (INCLUDING REFERENCE DESIGNS), APPLICATION OR OTHER DESIGN ADVICE, WEB TOOLS, SAFETY INFORMATION, AND OTHER RESOURCES "AS IS" AND WITH ALL FAULTS, AND DISCLAIMS ALL WARRANTIES, EXPRESS AND IMPLIED, INCLUDING WITHOUT LIMITATION ANY IMPLIED WARRANTIES OF MERCHANTABILITY, FITNESS FOR A PARTICULAR PURPOSE OR NON-INFRINGEMENT OF THIRD PARTY INTELLECTUAL PROPERTY RIGHTS.

These resources are intended for skilled developers designing with TI products. You are solely responsible for (1) selecting the appropriate TI products for your application, (2) designing, validating and testing your application, and (3) ensuring your application meets applicable standards, and any other safety, security, regulatory or other requirements.

These resources are subject to change without notice. TI grants you permission to use these resources only for development of an application that uses the TI products described in the resource. Other reproduction and display of these resources is prohibited. No license is granted to any other TI intellectual property right or to any third party intellectual property right. TI disclaims responsibility for, and you will fully indemnify TI and its representatives against, any claims, damages, costs, losses, and liabilities arising out of your use of these resources.

TI's products are provided subject to [TI's Terms of Sale](#) or other applicable terms available either on [ti.com](https://www.ti.com) or provided in conjunction with such TI products. TI's provision of these resources does not expand or otherwise alter TI's applicable warranties or warranty disclaimers for TI products.

TI objects to and rejects any additional or different terms you may have proposed.

Mailing Address: Texas Instruments, Post Office Box 655303, Dallas, Texas 75265  
Copyright © 2024, Texas Instruments Incorporated