

TAS5352DDV6EVM

This user's guide describes the operation of the evaluation module for the TAS5352 Digital Amplifier Power Output Stage using TAS5518 Digital Audio PWM Processor from Texas Instruments. The user's guide also provides measurement data and design information like schematic, bill of materials, and printed-circuit board layout.

Contents

1	Overview	3
1.1	TAS5352DDV6EVM Features.....	4
1.2	PCB Key Map	6
2	Quick Setup Guide.....	6
2.1	Electrostatic Discharge Warning.....	6
2.2	Unpacking the EVM	7
2.3	Power Supply Setup.....	7
2.4	Speaker Connection.....	7
2.5	GUI Software Installation	7
3	Protection	8
3.1	Short-Circuit Protection and Fault-Reporting Circuitry	8
3.2	Fault Reporting.....	8
4	TAS5352DDV6EVM Performance.....	9
4.1	THD+N vs Power (BTL – 4 Ω).....	11
4.2	THD+N vs Power (BTL – 6 Ω).....	12
4.3	THD+N vs Power (BTL – 8 Ω).....	12
4.4	THD+N vs Power (PBTL – 2 Ω).....	13
4.5	THD+N vs Power (PBTL – 3 Ω).....	13
4.6	THD+N vs Frequency (BTL –4 Ω)	14
4.7	THD+N vs Frequency (BTL –6 Ω)	14
4.8	THD+N vs Frequency (BTL –8 Ω)	15
4.9	THD+N vs Frequency (PBTL – 2 Ω).....	15
4.10	THD+N vs Frequency (PBTL – 3 Ω).....	16
4.11	FFT Spectrum With –60-dBFS Tone (BTL).....	16
4.12	FFT Spectrum With –60-dBFS Tone (PBTL)	17
4.13	Idle Noise FFT Spectrum (BTL)	17
4.14	Idle Noise FFT Spectrum (PBTL)	18
4.15	Channel Separation.....	18
4.16	Frequency Response (BTL).....	19
4.17	Frequency Response (PBTL).....	19
4.18	High-Current Protection (BTL).....	20
4.19	High-Current Protection (PBTL)	20
4.20	Pop/Click (BTL).....	21
4.21	Pop/Click (PBTL)	21
4.22	Output Stage Efficiency	22
4.23	Subwoofer Lineout THD vs Output Voltage	22
4.24	Subwoofer Lineout THD+N vs Frequency	23
4.25	Subwoofer Lineout Frequency Response.....	23

PurePath Digital, Equibit are trademarks of Texas Instruments.
the Windows is a trademark of Microsoft Corporation.
I²S, I²C are trademarks of Philips Corporation.

5	Related Documentation from Texas Instruments	24
5.1	Additional Documentation	24
Appendix A	Design Documents	25

List of Figures

1	Integrated PurePath Digital™ Amplifier System	5
2	Physical Structure for the TAS5352DDV6EVM (Approximate Layout)	6
3	TAS5518 GUI Window	8
4	THD+N vs Power (BTL – 4 Ω)	11
5	THD+N vs Power (BTL – 6 Ω)	12
6	THD+N vs Power (BTL – 8 Ω)	12
7	THD+N vs Power (PBTL – 2 Ω)	13
8	THD+N vs Power (PBTL – 3 Ω)	13
9	THD+N vs Frequency (BTL –4 Ω)	14
10	THD+N vs Frequency (BTL –6 Ω)	14
11	THD+N vs Frequency (BTL –8 Ω)	15
12	THD+N vs Frequency (PBTL – 2 Ω)	15
13	THD+N vs Frequency (PBTL – 3 Ω)	16
14	FFT Spectrum With –60 dBFS Tone (BTL)	16
15	FFT Spectrum With –60 dBFS Tone (PBTL)	17
16	Idle Noise FFT Spectrum (BTL)	17
17	Idle Noise FFT Spectrum (PBTL)	18
18	Channel Separation	18
19	Frequency Response (BTL)	19
20	Frequency Response (PBTL)	19
21	High-Current Protection (BTL)	20
22	High-Current Protection (PBTL)	20
23	Pop/Click (BTL)	21
24	Pop/Click (PBTL)	21
25	Output Stage Efficiency	22
26	Subwoofer Lineout THD Vs. Output Voltage	22
27	Subwoofer Lineout THD+N vs Frequency	23
28	Subwoofer Lineout Frequency Response	23

List of Tables

1	TAS5352DDV6EVM Specification	3
2	Recommended Supply Voltages	7
3	TAS5352 Warning/Error Signal Decoding	9
4	General Test Conditions	9
5	TAS5518 Register Settings	9
6	Electrical Data	9
7	Audio Performance	10
8	Audio Performance Subwoofer Line Output	10
9	Thermal Specification	11
10	Physical Specifications	11
11	Related Documentation From Texas Instruments	24

1 Overview

The TAS5352DDV6EVM PurePath Digital™ customer evaluation module demonstrates the integrated circuits TAS5352DDV and TAS5518PAG from Texas Instruments (TI).

The TAS5352DDV is a high-performance, integrated stereo Digital Amplifier Power Stage designed to drive four speakers at up to 125 W per channel. The device incorporates TI's Equibit™ technology and is designed to be used with TI's Equibit™ modulators. This system requires only a simple passive demodulation filter to deliver high-quality, high-efficiency audio amplification.

TAS5518PAG is a high-performance, 32-bit (24-bit input) multichannel PurePath Digital™ pulse width modulator (PWM) based on Equibit™ technology with fully symmetrical AD modulation scheme. The device also has digital audio processing (DAP) that provides 48-bit signal processing, advanced performance, and a high level of system integration. The device has interfaces for headphone output and power supply volume control (PSVC).

This EVM is configured with four BTL channels, one PBTL (parallel BTL) channel for the center channel, and a subwoofer lineout using the DRV600 line driver.

The DRV600RTJ is a stereo line driver designed to allow the removal of the DC-blocking capacitors for reduced component count and cost. The DRV600RTJ is ideal for single-supply electronics where size and cost are critical design parameters. The DRV600RTJ is capable of driving 2 V_{rms} into a 600-Ω load with a 3.3-V supply. The DRV600RTJ has a fixed gain of -1.5 V/V. Independent shutdown control for the left and right audio channels is implemented.

This EVM, together with a TI Input-USB board 2, is a complete 5-channel plus subwoofer line output digital audio amplifier system which includes digital input (S/PDIF), analog inputs, interface to a personal computer (PC), and DAP features like digital volume control, input and output mixers, automute, tone controls, loudness, EQ filters, and dynamic range compression (DRC). Configuration options are available for power stage failure protection.

Table 1. TAS5352DDV6EVM Specification

Key Parameters	
Output stage supply voltage:	0 V – 34.5 V
Number of channels	2 x BTL, 1 x PBTL
Load impedance BTL:	4–8 Ω
Load impedance PBTL:	2–8 Ω
Output power BTL	140 W / 4 Ω 10% THD or 1.3 W / 6 Ω / 10% THD
Output power PBTL	268 W / 2 Ω / 10% THD
DNR	>110 dB
PWM processor	TAS5518PAG
Output stage	TAS5352DDV
Other features	DRV600 – Subwoofer line output

Overview

This 5-channel system plus subwoofer line output is designed for home theater applications such as A/V receivers, DVD receivers, DVD minicomponent systems, or home theater in a box (HTIB).

This document covers EVM specifications, audio performance and power efficiency measurements graphs, and design documentation that includes schematics, parts list, layout, and mechanical design.

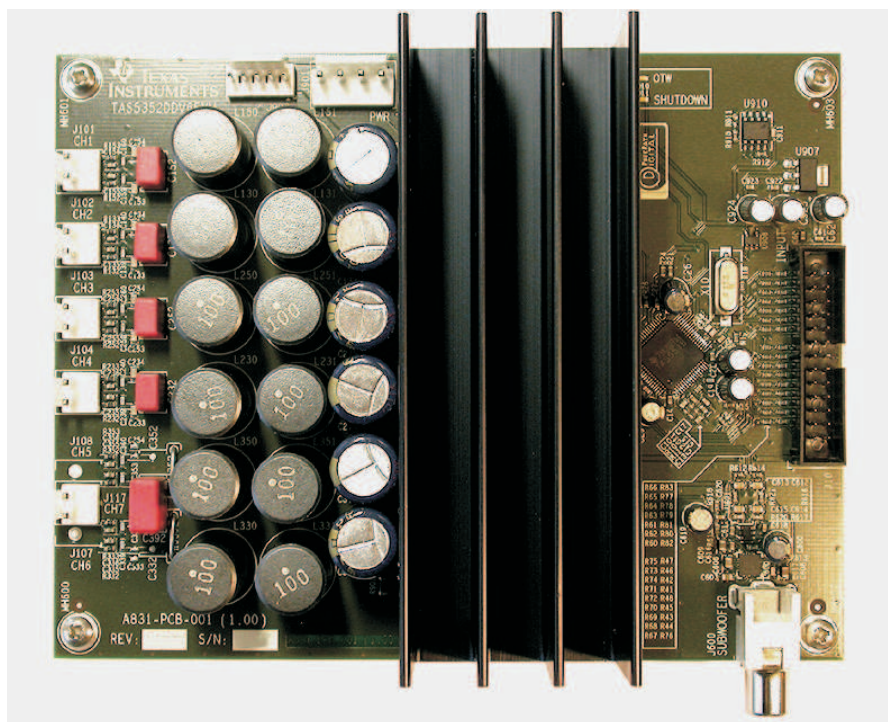

Gerber (layout) files are available at www.ti.com.

The EVM is delivered with cables and an Input-USB board 2 to connect to an input source and be controlled from a PC.

1.1 TAS5352DDV6EVM Features

- 5/6-channel PurePath Digital™ evaluation module
- Subwoofer line output (LFE output)
- Self-contained protection system (short circuit and thermal)
- Standard I²S™ and I²C™/control connector for TI input board
- Double-sided plated-through PCB layout

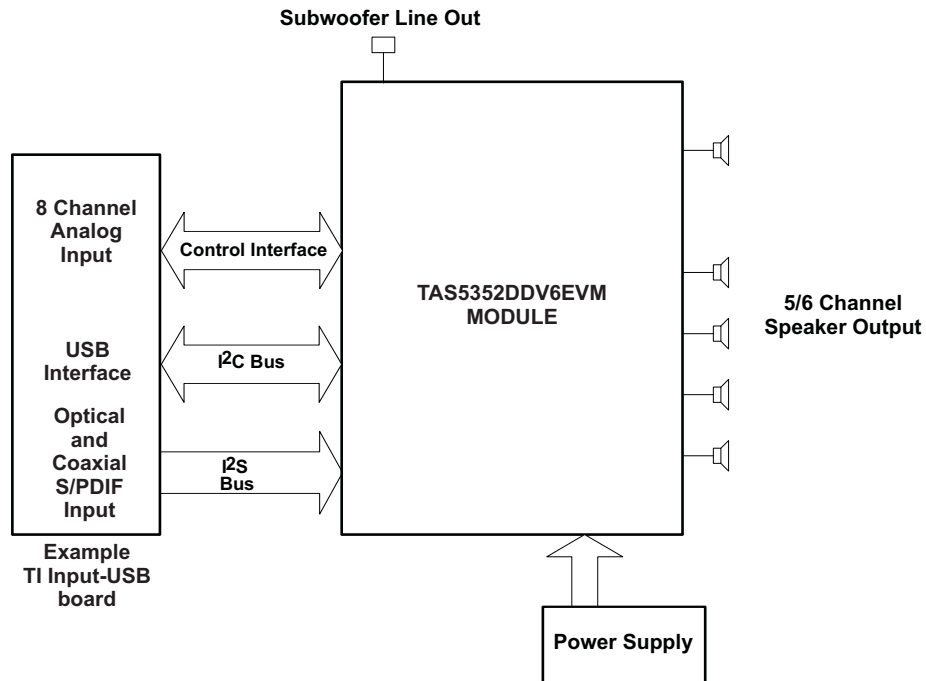
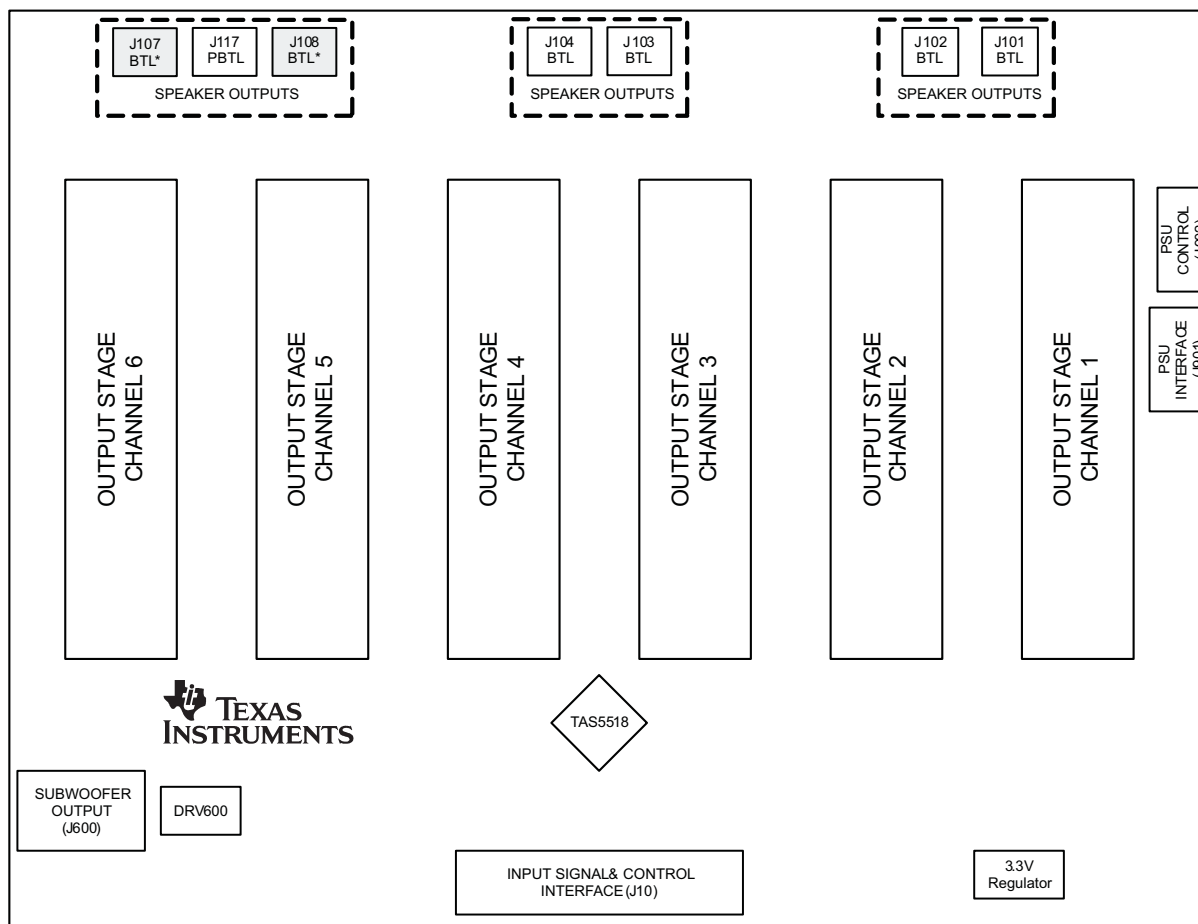

Figure 1. Integrated PurePath Digital™ Amplifier System

1.2 PCB Key Map

Physical structure for the TAS5352DDV6EVM is illustrated in Figure 2.



*: Config Option

Figure 2. Physical Structure for the TAS5352DDV6EVM (Approximate Layout)

2 Quick Setup Guide

This section describes the TAS5352DDV6EVM board in regards to power supplies and system interfaces. The section provides information regarding handling and unpacking, absolute operating conditions, and a description of the factory default switch and jumper configuration.

This section provides a step-by-step guide to configuring the TAS5352DDV6EVM for device evaluation.

2.1 Electrostatic Discharge Warning

Many of the components on the TAS5352DDV6EVM are susceptible to damage by electrostatic discharge (ESD). Customers are advised to observe proper ESD handling precautions when unpacking and handling the EVM, including the use of a grounded wrist strap at an approved ESD workstation.

CAUTION

Failure to observe ESD handling procedures may result in damage to EVM components.

2.2 Unpacking the EVM

On opening the TAS5352DDV6EVM package, check to ensure that the following items are included:

- 1 pc. TAS5352DDV6EVM board using one TAS5518PAG and three TAS5352DDV
- 1 pc. TI Input-USB board 2 for interfacing TAS5352DDV6EVM with SPDIF/analog sources and PC for control
- 1 pc. Signal and Control Interface IDC cable for connection to an I²S front-end like the attached TI Input-USB board 2
- 1 pc. Cable for connecting Input-USB board 2 to a USB port on a PC for TAS5018 control by software
- 1 pc. Power supply cable for a regulated power supply (H-bridge supply)
- 1 pc. AC to DC external 15-V power supply (system supply)
- 4 pc. AC input clips for external 15-V power supply (US, Europe, UK, and Australia)
- 1 pc. PurePath CD-ROM

If any of these items are missing, contact the Texas Instruments Product Information Center nearest you to inquire about a replacement.

Connect Input-USB board 2 to TAS5352DDV6EVM using the delivered IDC cable.

2.3 Power Supply Setup

To power up the EVM, two power supplies are needed. One for system power, logic and gate-drive, and one for output stage supply. The H-bridge power supply is connected to the EVM using the delivered white/black power cable. The system power supply is provided in the enclosed external 15-V wall plug adapter.

Table 2. Recommended Supply Voltages

Description	Voltage Limitations	Current Requirement	Cable
Output stage power supply	0 – 34.5 V	10 A	White/Black

CAUTION

Applying voltages above the limitations given in [Table 2](#) may cause permanent damage to your hardware

Note: The length of power supply cable must be minimized. Increasing length of PSU cable is equal to increasing the distortion for the amplifier at high output levels and low frequencies.

2.4 Speaker Connection

CAUTION

Both positive and negative speaker outputs are floating and may not be connected to ground (e.g., through an oscilloscope)

2.5 GUI Software Installation

The TAS5518 graphical user interface (GUI) provides easy control of all registers in TAS5518. To install the GUI, run the setup file from the PurePath CD-ROM.

After installation, turn on the power supplies, and connect the USB cable to the Input-USB board 2.

Start the GUI program from the Windows™ menu. The start-up of the GUI takes a few seconds.



Figure 3. TAS5518 GUI Window

From the files menu, load the configuration file:

TAS5352DDV6EVM Configuration (1.00).cfg

The file is located on the PurePath CD-ROM. This file contains all settings for a default setup of the EVM.

For easy access of the file, it is recommended to copy the files into the directory where the GUI is installed. The default location is C:\Program Files\Texas Instruments Inc\TAS5518\

For more advanced use of the GUI, see the GUI User's Guide and data sheet for the TAS5518 device.

3 Protection

This section describes the short-circuit protection and fault reporting circuitry of the TAS5352 device.

3.1 Short-Circuit Protection and Fault-Reporting Circuitry

The TAS5352 is a self-protecting device that provides fault reporting (including high-temperature protection and short-circuit protection). The TAS5352 is configured in back-end auto-recovery mode and therefore resets automatically after all errors (M1, M2, and M3 is set low); see the data sheet for further explanation. This means that the device re-starts itself after an error occasion and reports shortly thereafter through the \overline{SD} error signal.

3.2 Fault Reporting

The \overline{OTW} and \overline{SD} outputs from TAS5352 indicate fault conditions. See the TAS5352 data sheet for a description of these pins.

Table 3. TAS5352 Warning/Error Signal Decoding

OTW	SD	Device Condition
0	0	High-temperature error and/or high current error
0	1	High-temperature warning
1	0	Undervoltage lockout or high-current error
1	1	Normal operation, no errors/warnings

The temperature warning signals at the TAS5352DDV6EVM board are wired-OR to one temperature warning signal (\overline{OTW} – pin 22 in control interface connector).

The shutdown signals are wired-OR into one shutdown signal (\overline{SD} – pin 20 in control interface connector).

The shutdown signals together with the temperature warning signal give chip state information as described in Table 3. Device fault-reporting outputs are open-drain outputs.

4 TAS5352DDV6EVM Performance

Table 4. General Test Conditions

General Test Conditions		Notes
Output stage supply voltage:	34.5 V	Laboratory power supply (EA-PS 7065-10A)
Load impedance BTL:	4-8 Ω	
Load impedance PBTl:	2-4 Ω	
Input signal	1 kHz sine	
Sampling frequency	48 kHz	
Gain setting in TAS5518	0 dB	
Measurement filter	AES17 and AUX0025	
TI Input Board	Input-USB 2	Rev 1
EVM configuration file	Ver 1.00	TAS5352DDV6EVM Configuration (1.00).cfg

Note: These test conditions are used for all tests, unless otherwise specified.

Table 5. TAS5518 Register Settings

Register	Register	Value	Notes
Modulation Index Limit Register	0x16	0x02	Set Modulation Index to 97.7%
Master Volume Register	0xD9	0x00 00 00 48	Master Volume set to 0 dB

Note: These register settings are used for all test, unless otherwise specified

Table 6. Electrical Data

Electrical Data		Notes/Conditions
Output power, BTL, 4 Ω :	107 W	1 kHz, unclipped (0dBFS), $T_A = 25^\circ\text{C}$
Output power, BTL, 4 Ω :	140 W	1 kHz, 10% THD+N, $T_A = 25^\circ\text{C}$
Output power, BTL, 6 Ω :	78 W	1 kHz, unclipped (0 dBFS), $T_A = 25^\circ\text{C}$
Output power, BTL, 6 Ω :	103 W	1 kHz, 10% THD+N, $T_A = 25^\circ\text{C}$
Output power, BTL, 8 Ω :	61 W	1 kHz, unclipped (0 dBFS), $T_A = 25^\circ\text{C}$
Output power, BTL, 8 Ω :	80 W	1 kHz, 10% THD+N, $T_A = 25^\circ\text{C}$
Output power, BTL, 2 Ω :	209 W	1 kHz, unclipped (0 dBFS), $T_A = 25^\circ\text{C}$
Output power, BTL, 2 Ω :	268 W	1 kHz, 10% THD+N, $T_A = 25^\circ\text{C}$
Output power, BTL, 3 Ω :	152 W	1 kHz, unclipped (0 dBFS), $T_A = 25^\circ\text{C}$
Output power, BTL, 3 Ω :	200 W	1 kHz, 10% THD+N, $T_A = 25^\circ\text{C}$

Table 6. Electrical Data (continued)

Electrical Data		Notes/Conditions
Maximum peak current, BTL:	>12 A	1-kHz burst, 1 Ω , R _{OC} = 27 k Ω
Maximum peak current, PBTL:	>25 A	1-kHz burst, 1 Ω , R _{OC} = 27 k Ω
Output stage efficiency:	90%	2 x channels, 8 Ω
Damping factor BTL:	7.6	1 kHz, relative to 4 Ω load
Damping factor PBTL:	6.8	1 kHz, relative to 2 Ω load
H-bridge supply current:	<225 mA	1 kHz, -60 dBFS signal
Idle power consumption:	7.8 W	H-Bridge supply, -60 dBFS input signal

Table 7. Audio Performance

Audio Performance			Notes/Conditions
THD+N, BTL, 4 Ω :	1 W	<0.065%	1 kHz
THD+N, BTL, 4 Ω :	10 W	<0.13%	1 kHz
THD+N, BTL, 4 Ω :	50 W	<0.11%	1 kHz
THD+N, BTL, 6 Ω :	1 W	<0.085%	1 kHz
THD+N, BTL, 6 Ω :	10 W	<0.07%	1 kHz
THD+N, BTL, 6 Ω :	50 W	<0.09%	1 kHz
THD+N, BTL, 8 Ω :	1 W	<0.09%	1 kHz
THD+N, BTL, 8 Ω :	10 W	<0.06%	1 kHz
THD+N, BTL, 8 Ω :	50 W	<0.08%	1 kHz
THD+N, PBTL, 2 Ω :	1 W	<0.08%	1 kHz
THD+N, PBTL, 2 Ω :	10 W	<0.14%	1 kHz
THD+N, PBTL, 2 Ω :	50 W	<0.13%	1 kHz
THD+N, PBTL, 2 Ω :	100 W	<0.13%	1 kHz
THD+N, PBTL, 2 Ω :	150 W	<0.31%	1 kHz
THD+N, PBTL, 3 Ω :	1 W	<0.11%	1 kHz
THD+N, PBTL, 3 Ω :	10 W	<0.06%	1 kHz
THD+N, PBTL, 3 Ω :	50 W	<0.09%	1 kHz
THD+N, PBTL, 3 Ω :	100 W	<0.12%	1 kHz
Dynamic range:		>110 dB	Ref: rated power, A-weighted, AES17 filter, 4 ch avg
Noise voltage:		<63 μ Vrms	A-weighted, AES17 filter
Click/pop, DC step BTL:		6 mV	Mute/unmute, no signal, 6 Ω
Click/pop, DC step PBTL:		8 mV	Mute/unmute, no signal, 4 Ω
Channel separation:		>61 dB	1 kHz
Frequency response:		0.0 / -0.7 dB	90 W / 4 Ω , unclipped (0 dBFS)

Table 8. Audio Performance Subwoofer Line Output

Audio Performance			Notes/Conditions
Full-scale output voltage swing,=0 dBFS:		2 Vrms	100 Hz, 10-k Ω load
Full scale output voltage swing,		2.35 Vrms	100 Hz, 10- k Ω load
THD+N, 10 k Ω :	1 V	0.017%	100 Hz
THD+N, 10 k Ω :	100 mV	<0.011%	100 Hz
Frequency response:		+1, -3 dB	20 Hz - 1.7 kHz
Dynamic range:		>105.5 dB	20 Hz - 1.7 kHz
Noise voltage:		<11 μ V	20 Hz - 1.7 kHz

Table 9. Thermal Specification

Thermal specification**	THEATSINK*	Notes/Conditions
Idle, all channels switching	34°C	1 kHz, 15 min, -60 dBFS signal, T _A = 25°C
4x12.5 W, 4 Ω + 1x25 W, 2 Ω (1/8 power)	63°C	1 kHz, 1 hour, T _A = 25°C
2x100 W, 4 Ω	90°C	1 kHz, 5 min, T _A = 25°C

*Measured on surface of heatsink.

Table 10. Physical Specifications

Physical Specifications		Notes/Conditions
PCB dimensions:	124 x 150 x 54	Width x length x height (mm)
Total weight:	380 gr.	Components + PCB + Heatsink + Mechanics

Note: All electrical and audio specifications are typical values.

4.1 THD+N vs Power (BTL – 4 Ω)

Gain: +2.5 dB set in TAS5518

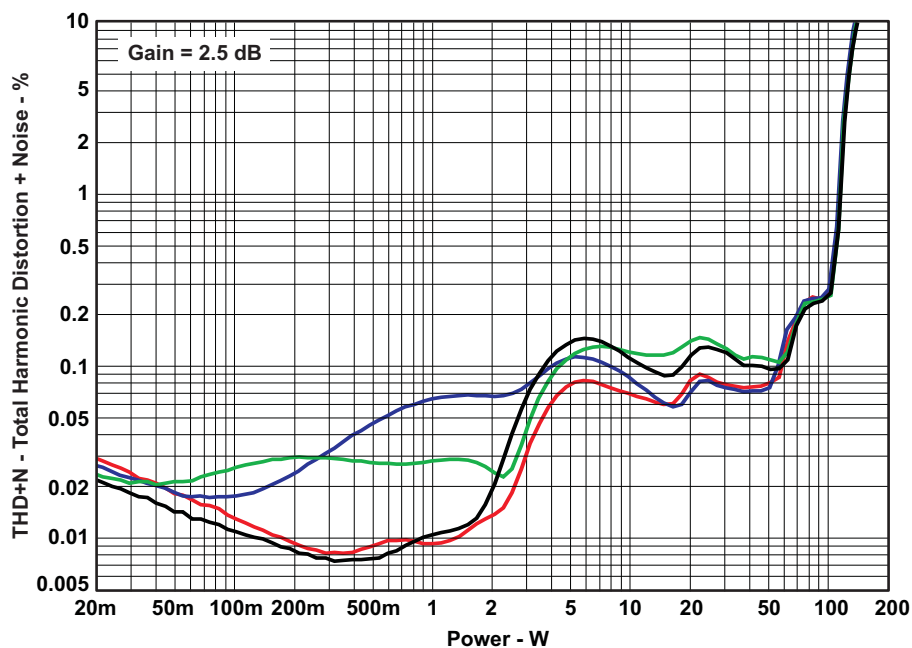

Figure 4. THD+N vs Power (BTL – 4 Ω)

4.2 THD+N vs Power (BTL – 6 Ω)

Gain: +2.5 dB set in TAS5518

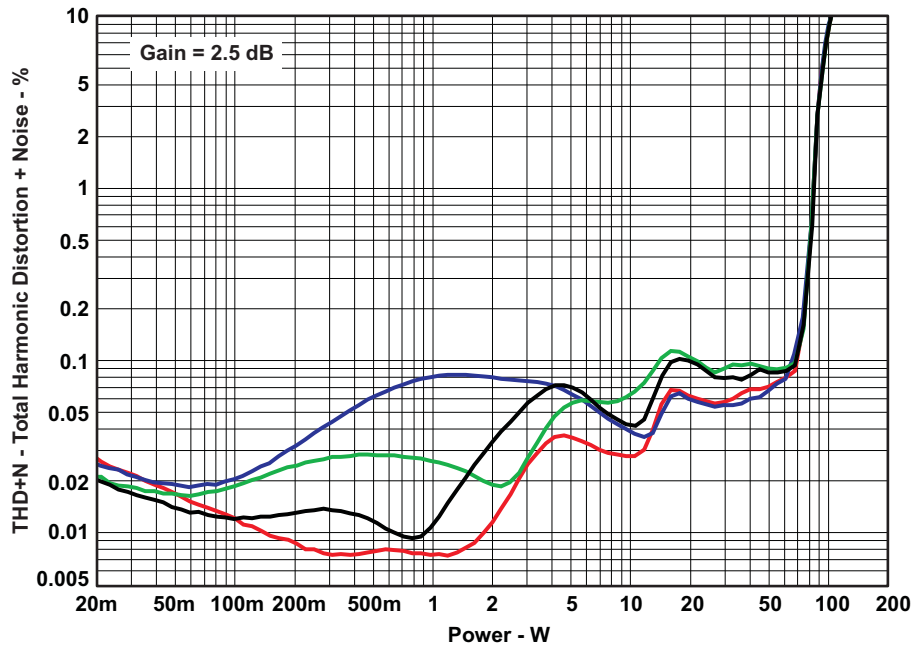

Figure 5. THD+N vs Power (BTL – 6 Ω)

4.3 THD+N vs Power (BTL – 8 Ω)

Gain: +2.5 dB set in TAS5518

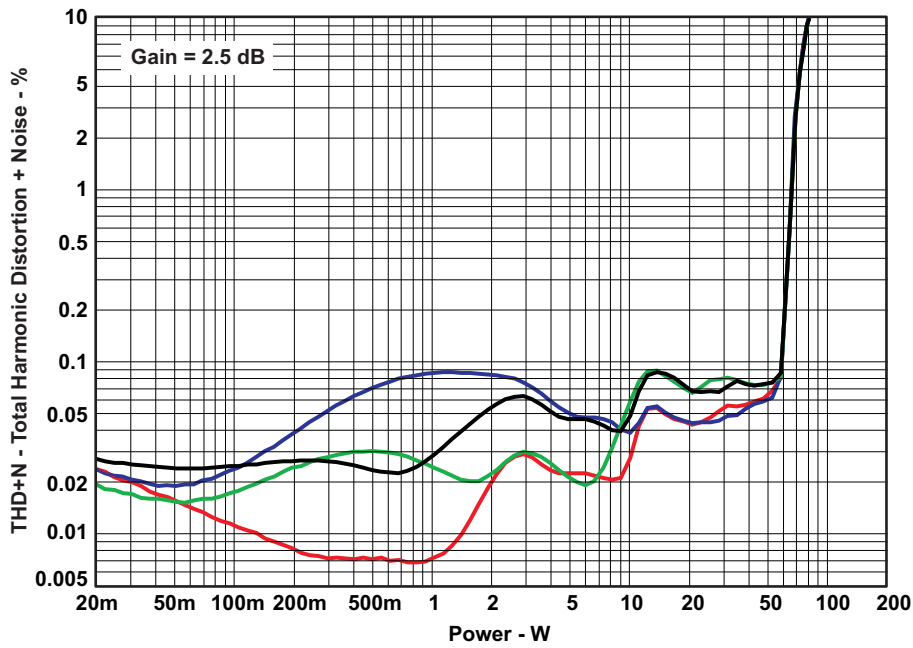

Figure 6. THD+N vs Power (BTL – 8 Ω)

4.4 THD+N vs Power (PBTL – 2 Ω)

Gain: +2.5 dB set in TAS5518

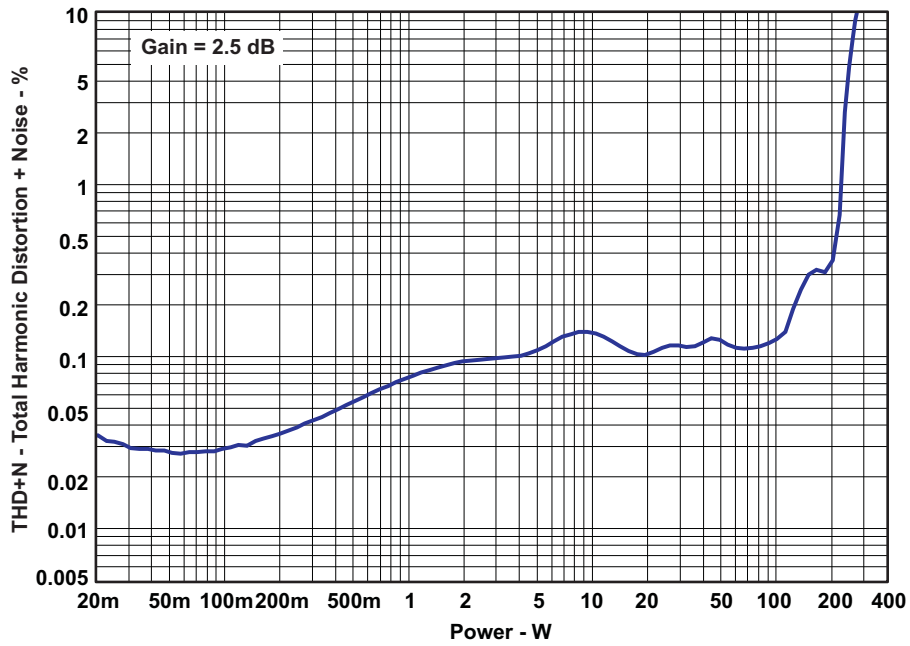

Figure 7. THD+N vs Power (PBTL – 2 Ω)

4.5 THD+N vs Power (PBTL – 3 Ω)

Gain: +2.5 dB set in TAS5518

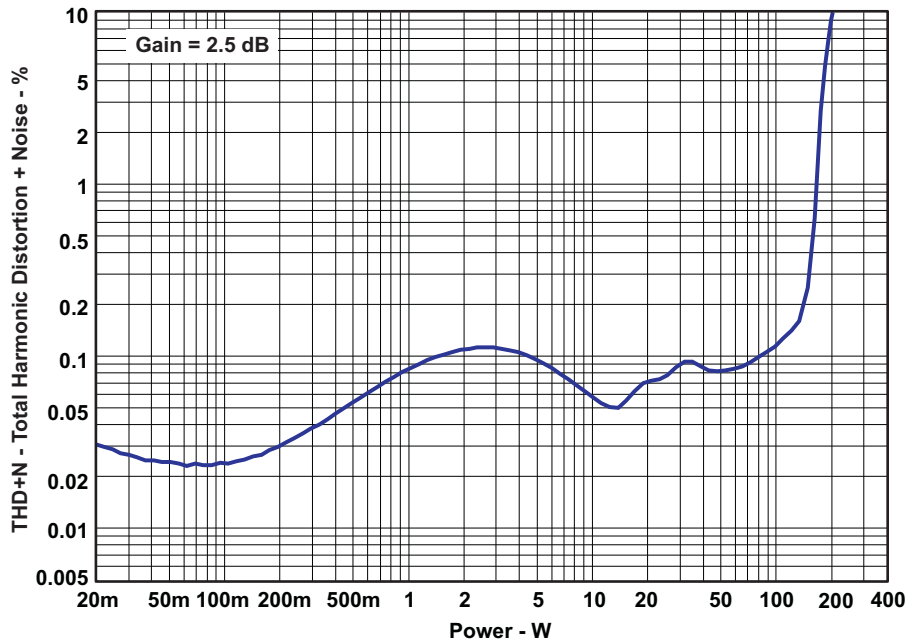

Figure 8. THD+N vs Power (PBTL – 3 Ω)

4.6 THD+N vs Frequency (BTL -4 Ω)

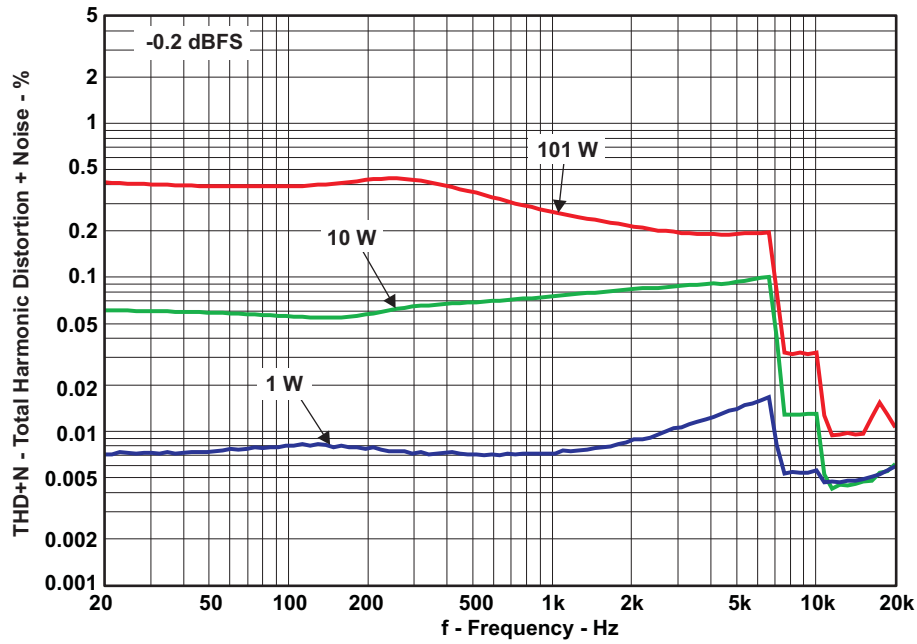

Figure 9. THD+N vs Frequency (BTL -4 Ω)

4.7 THD+N vs Frequency (BTL -6 Ω)

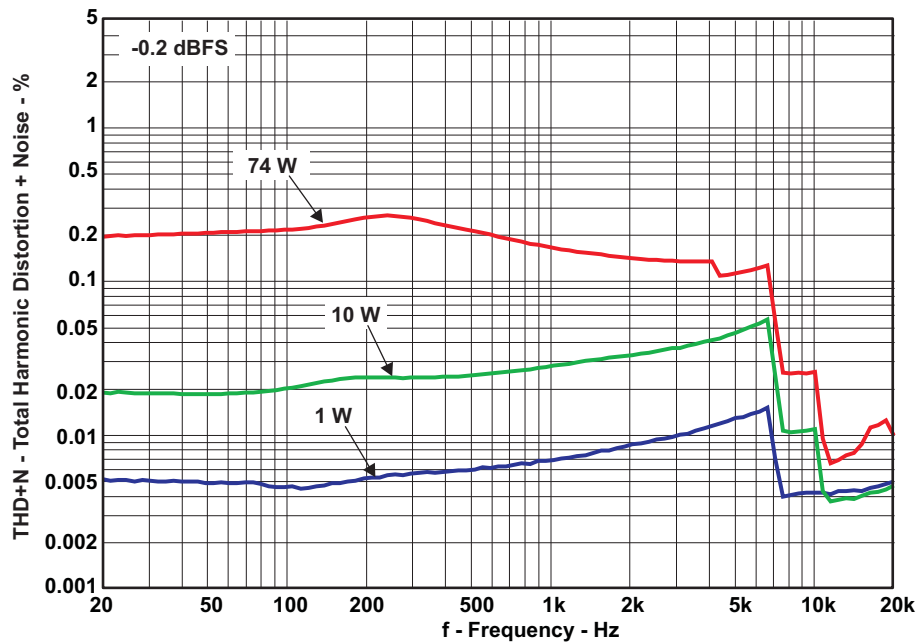

Figure 10. THD+N vs Frequency (BTL -6 Ω)

4.8 THD+N vs Frequency (BTL –8 Ω)

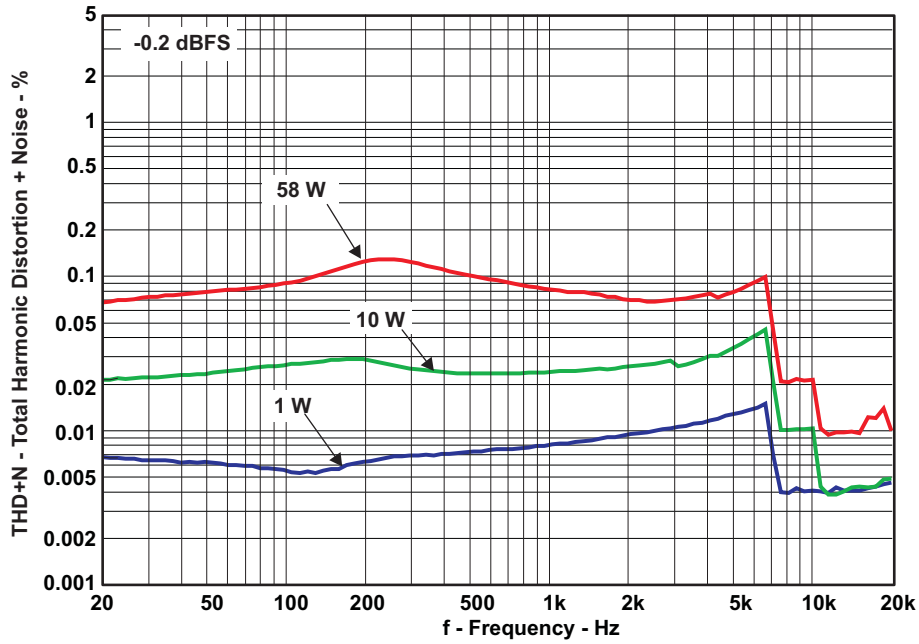

Figure 11. THD+N vs Frequency (BTL –8 Ω)

4.9 THD+N vs Frequency (PBTL – 2 Ω)

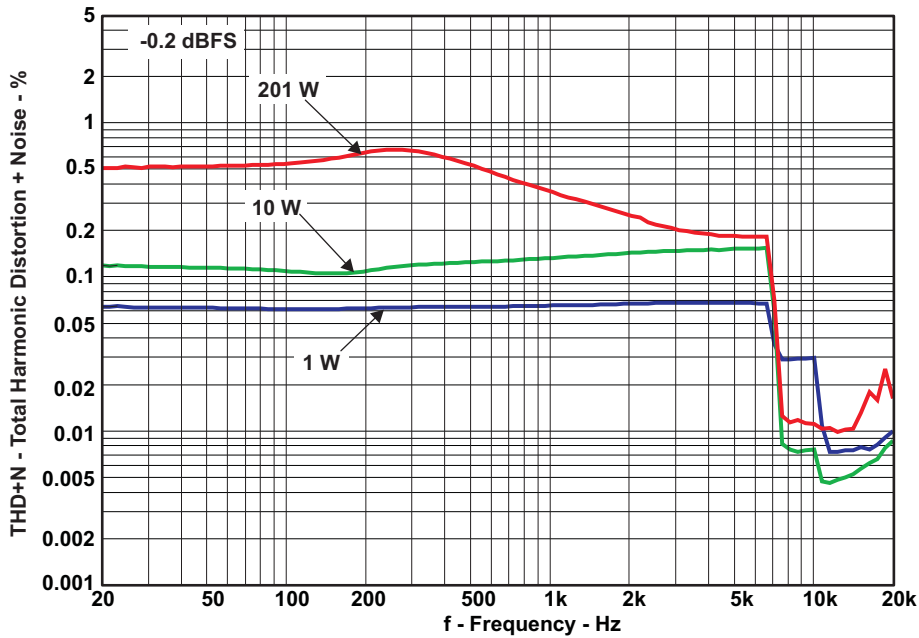

Figure 12. THD+N vs Frequency (PBTL – 2 Ω)

4.10 THD+N vs Frequency (PBTL – 3 Ω)

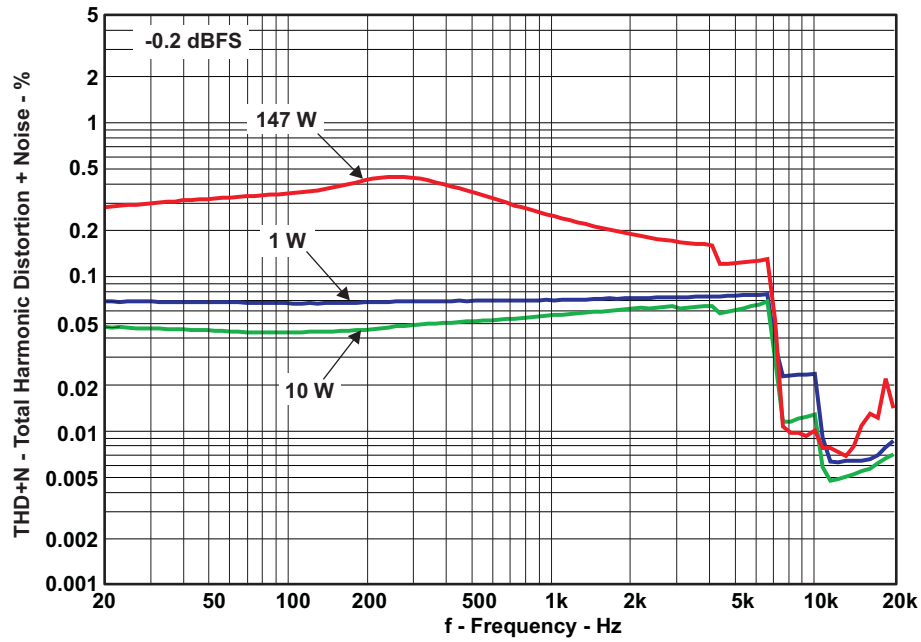

Figure 13. THD+N vs Frequency (PBTL – 3 Ω)

4.11 FFT Spectrum With –60-dBFS Tone (BTL)

Reference voltage is 20.7 V. FFT size 16k.

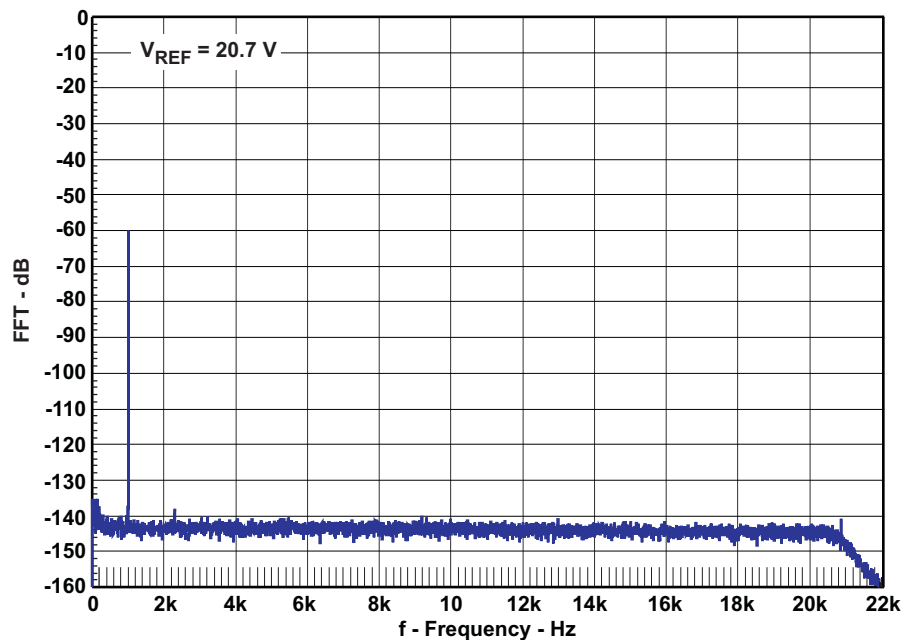

Figure 14. FFT Spectrum With –60 dBFS Tone (BTL)

4.12 FFT Spectrum With -60-dBFS Tone (PBTL)

Reference voltage is 20.6 V. FFT size 16k.

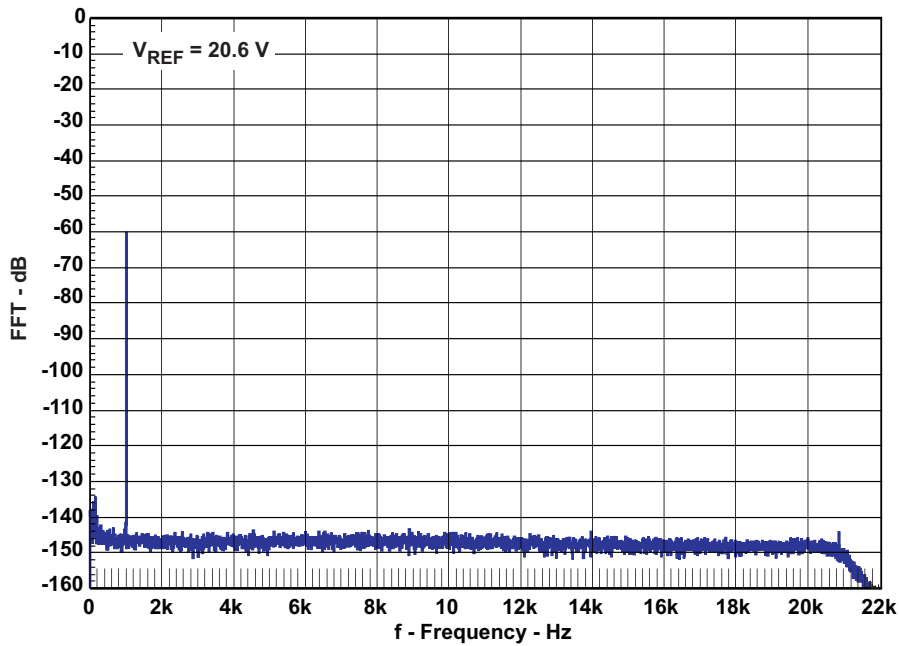

Figure 15. FFT Spectrum With -60 dBFS Tone (PBTL)

4.13 Idle Noise FFT Spectrum (BTL)

Automute disabled – Register x04h set to x60h. Reference voltage is 20.7 V. FFT size 16k.

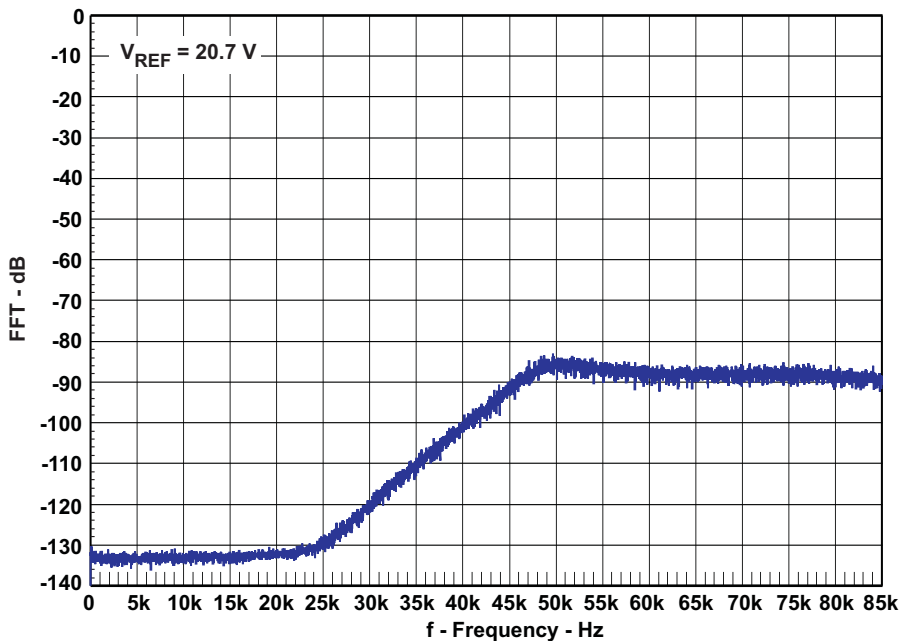

Figure 16. Idle Noise FFT Spectrum (BTL)

4.14 Idle Noise FFT Spectrum (PBTL)

Automute disabled – Register x04h set to x60h. Reference voltage is 20.6 V. FFT size 16k.

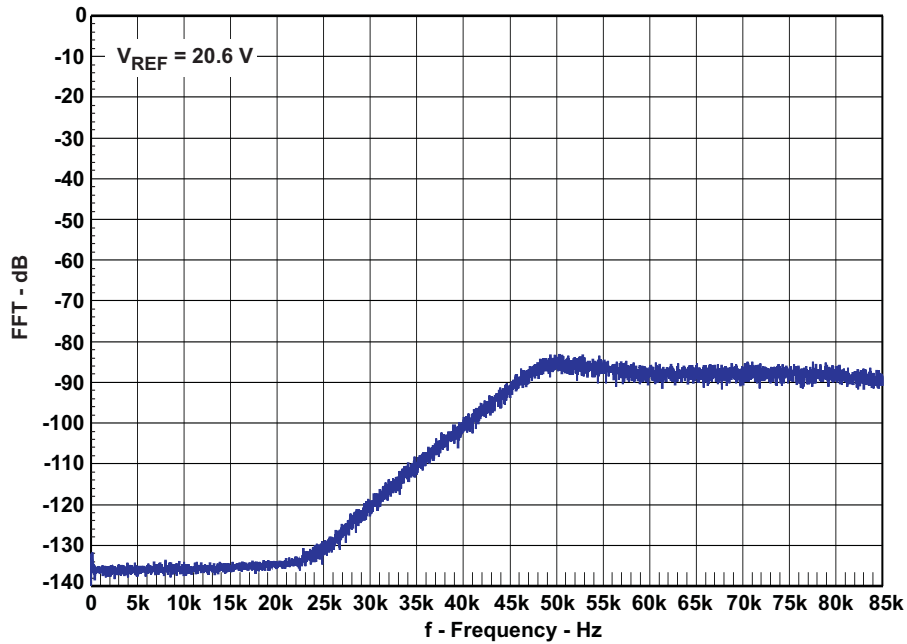

Figure 17. Idle Noise FFT Spectrum (PBTL)

4.15 Channel Separation

Channel separation is tested for two channels in a different package, channel 1 and channel 2. 4-Ω loads are used for both channels. Channel 1 input signal is 0 dBFS; channel 2 is muted. Reference voltage is 20.7 Vrms

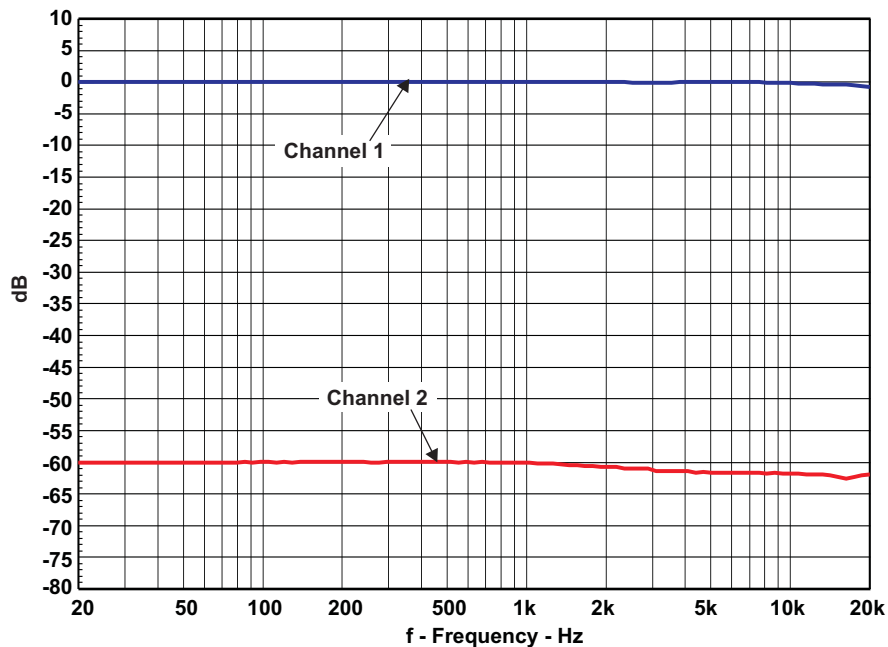

Figure 18. Channel Separation

4.16 Frequency Response (BTL)

Measurement bandwidth filter 80 kHz.

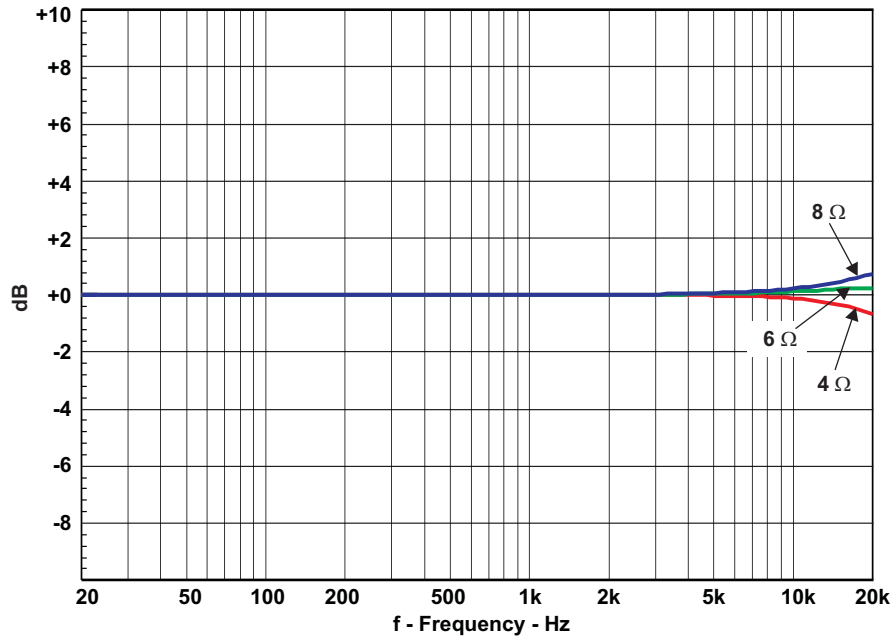

Figure 19. Frequency Response (BTL)

4.17 Frequency Response (PBTl)

Measurement bandwidth filter 80 kHz.

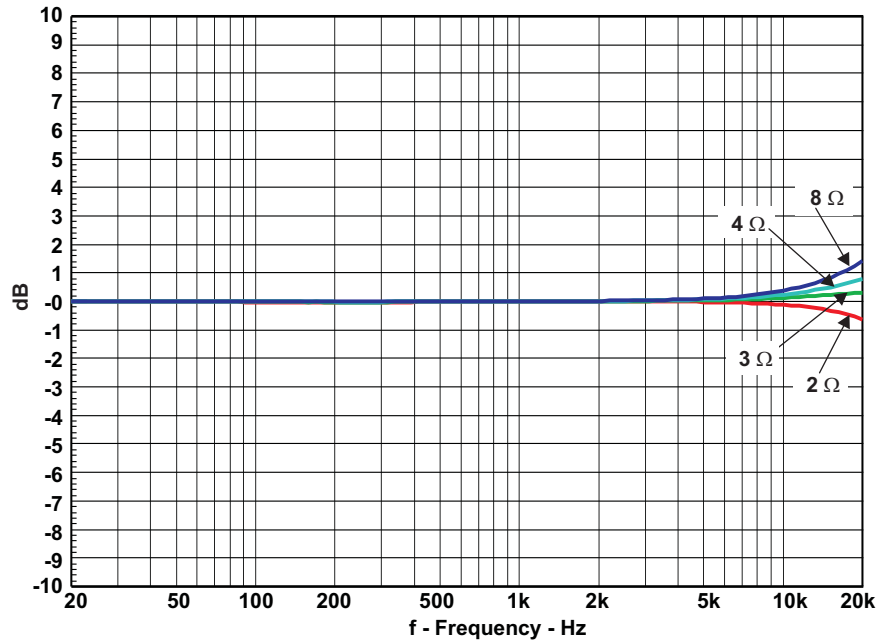

Figure 20. Frequency Response (PBTl)

4.18 High-Current Protection (BTL)

Input is 1-kHz bursted signal; load is 1 Ω .

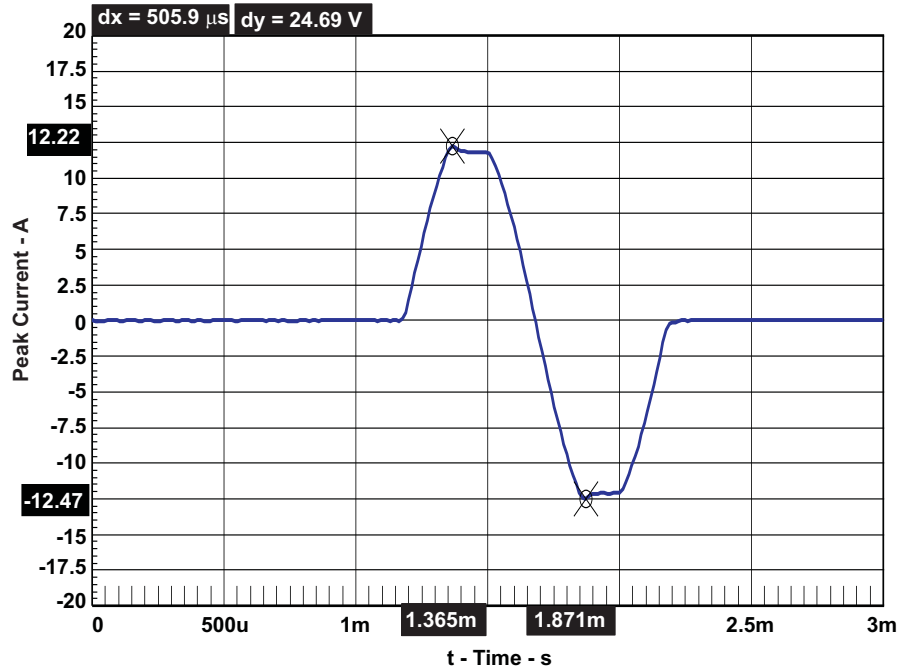

Figure 21. High-Current Protection (BTL)

4.19 High-Current Protection (PBTL)

Input is 1-kHz bursted signal; load is 1 Ω .

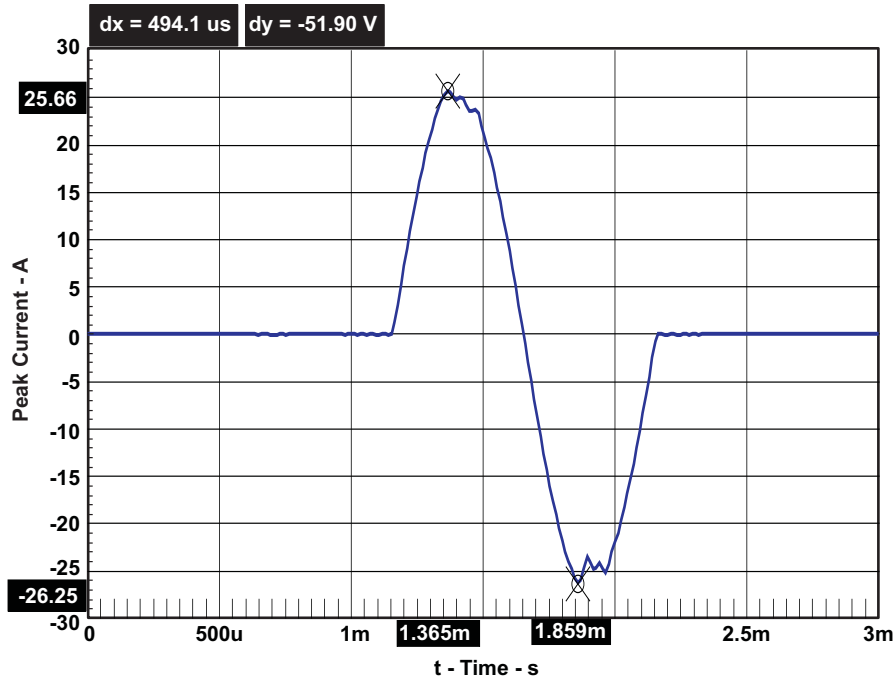

Figure 22. High-Current Protection (PBTL)

4.20 Pop/Click (BTL)

No input signal is applied. The measurement results are presented in frequency domain.

Test with automute disabled – Register x04h set to x60h. No input signal is applied. Load is 4 Ω .

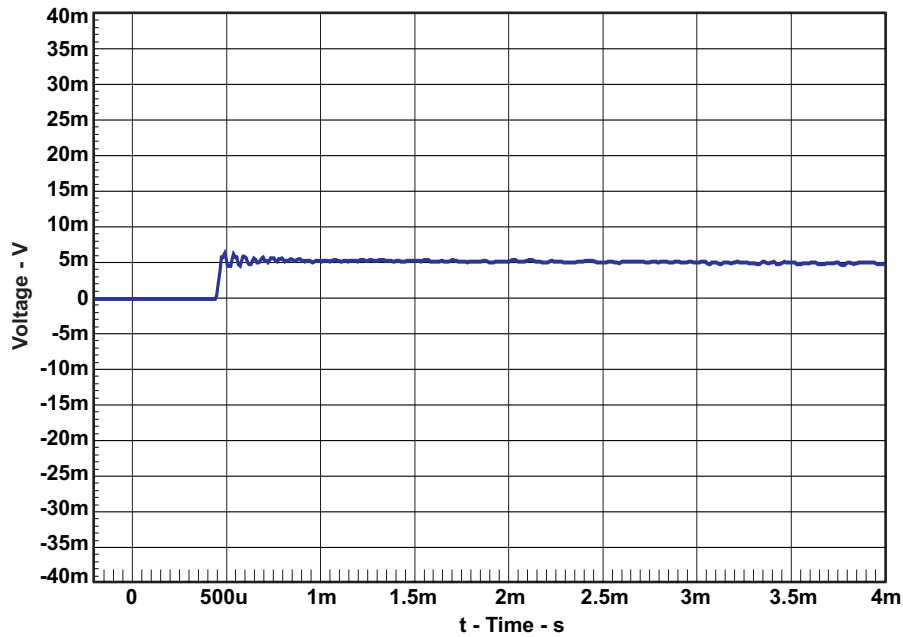

Figure 23. Pop/Click (BTL)

4.21 Pop/Click (PBTL)

No input signal is applied. The measurement results are presented in frequency domain.

Test with automute disabled – Register x04h set to x60h. No input signal is applied. Load is 2 Ω .

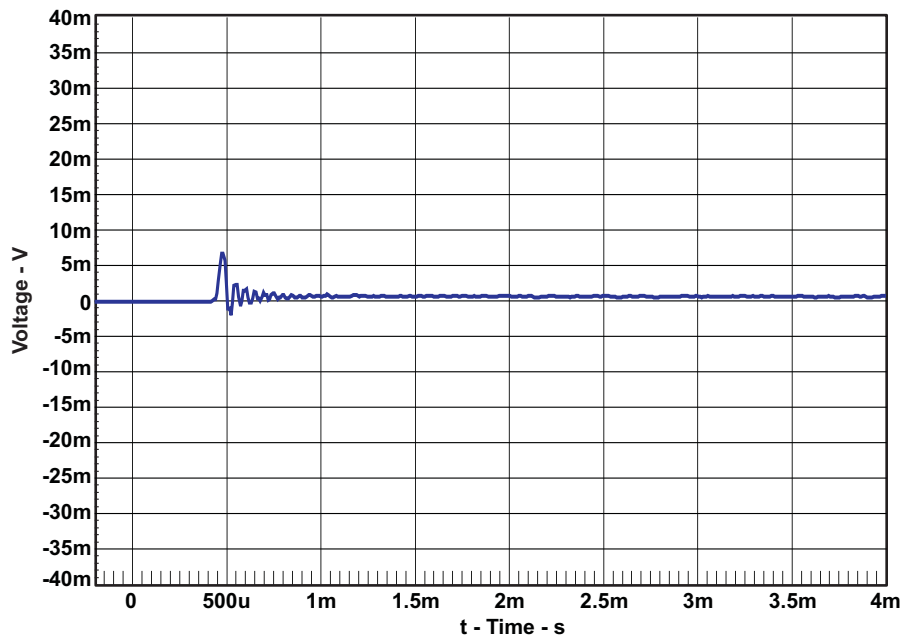

Figure 24. Pop/Click (PBTL)

4.22 Output Stage Efficiency

Efficiency is tested with two channels loaded with 4 Ω. The board has been preheated for 1 hour at 1/8 output power.

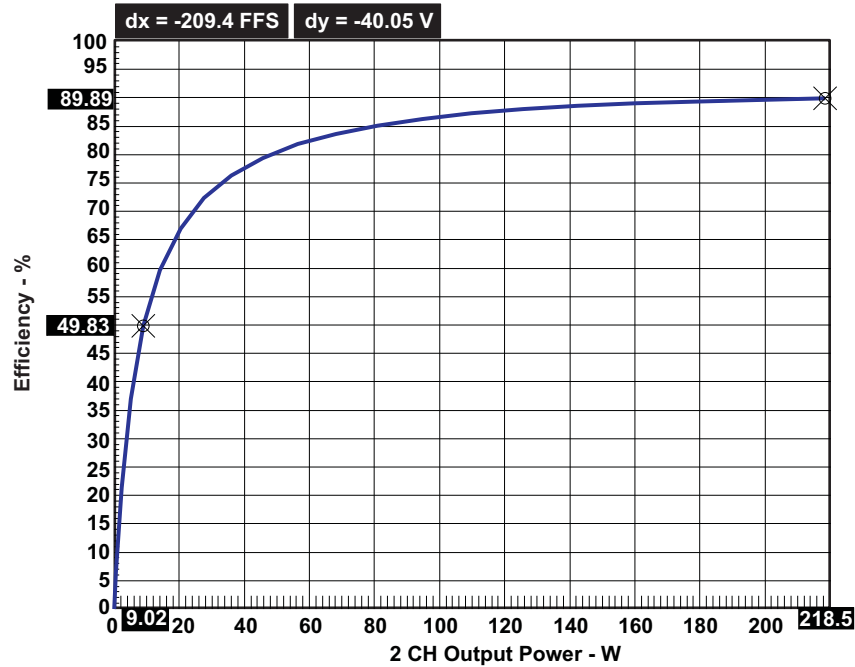

Figure 25. Output Stage Efficiency

4.23 Subwoofer Lineout THD vs Output Voltage

Gain: +2.5 dB set in TAS5518. 100-Hz input

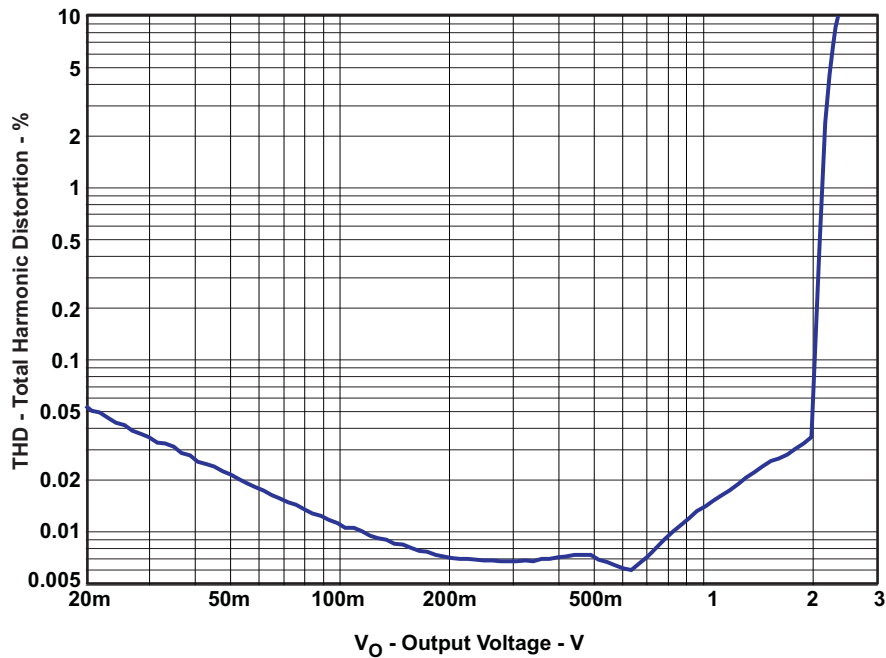

Figure 26. Subwoofer Lineout THD Vs. Output Voltage

4.24 Subwoofer Lineout THD+N vs Frequency

Load is 10 k Ω .

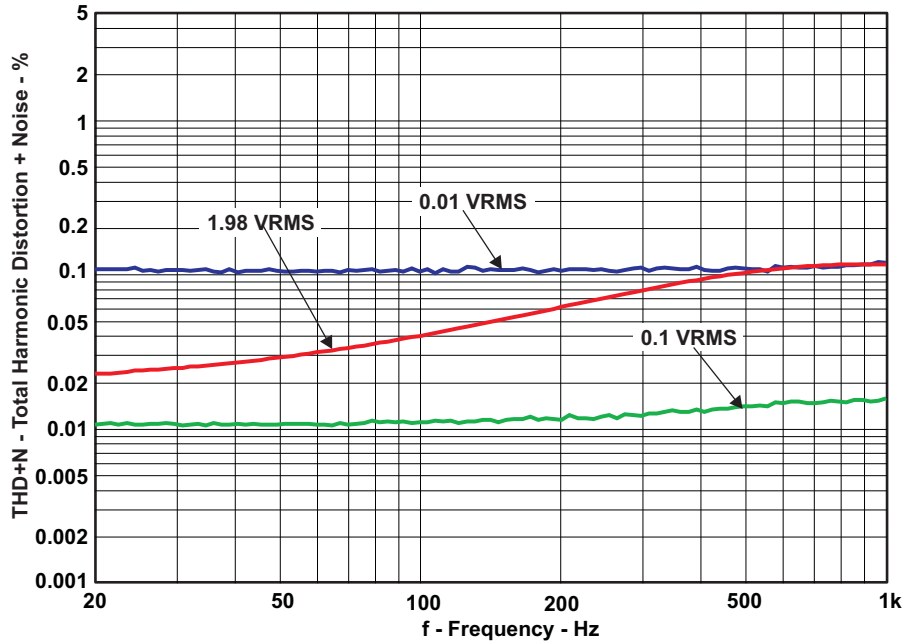

Figure 27. Subwoofer Lineout THD+N vs Frequency

4.25 Subwoofer Lineout Frequency Response

Measurement bandwidth filter is 80 kHz. Load is 10 k Ω .

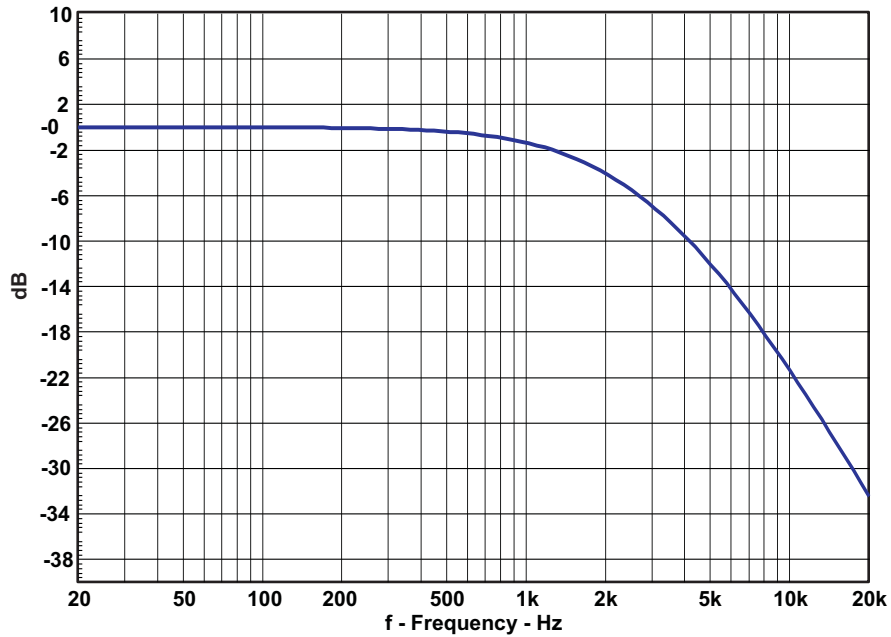

Figure 28. Subwoofer Lineout Frequency Response

5 Related Documentation from Texas Instruments

Table 11 contains a list of data sheets that have detailed descriptions of the integrated circuits used in the design of the TAS5352DDV6EVM. The data sheets can be obtained at the URL <http://www.ti.com>.

Table 11. Related Documentation From Texas Instruments

Part Number	Literature Number
TAS5518	SLES115
TAS5352	SLES204
DRV600	SLOS536
TLV271	SLOS351
TPS3825-33	SLVS165
TLV1117-33C	SLVS561

5.1 Additional Documentation

1. *PC Configuration Tool for TAS5518* (TAS5518 GUI ver. 4.0 or later)
2. *System Design Considerations for True Digital Audio Power Amplifiers* application report ([SLAA117](#))
3. *Digital Audio Measurements* application report ([SLAA114](#))
4. *PSRR for PurePath Digital Audio Amplifiers* application report ([SLEA049](#))
5. *Power Rating in Audio Amplifier* application report ([SLEA047](#))
6. *PurePath Digital AM Interference Avoidance* application report ([SLEA040](#))
7. *Click and Pop Measurements Technique* application report ([SLEA044](#))
8. *Power Supply Recommendations for DVD-Receivers* application report ([SLEA027](#))
9. *Implementation of Power Supply Volume Control* application report ([SLEA038](#))

Appendix A Design Documents

A.1 *TAS5352DDV6EVM Schematic*

Version 1.00 (6 pages)

A.2 *TAS5352DDV6EVM Parts List*

Version 1.00 (2 pages)

A.3 *TAS5352DDV6EVM PCB Specification*

Version 1.00 (1 page)

A.4 *TAS5352DDV6EVM PCB Layers*

Version 1.00 (5 pages)

A.5 *Heatsink Drawing*

Version 1.00 (1 page)



Design Name: **TAS5352DDV6EVM**
 Type: Mass Market Evaluation Module
 File Name: A831-SCH-001.DSN
 Version: 2.00
 Date: 4.Jan 2008
 Design Engineer: Jonas Holm (jlh@ti.com)
 Audio Configuration: 5.1 PurePath Digital Amplifier Design
 1 x TAS5518, 3 x TAS5352DDV
 Interfaces: J10: 26 pin IDC Header for Control, I2C, +5V, +12V and for I2S Audio
 J101-J104, J107, J108, J117: 2 pin 3.96mm Headers for Speakers
 J600: RCA Jack for Subwoofer Line Out
 J901: 4 pin 3.96mm Header for H-Bridge Supply
 J902: 5 pin 2.54 mm Header for PSVC Interface
 Setup: 4 Ohm (BTL) and 2 Ohm (PBTL) Speaker Loads
 +34.5 V H-Bridge Supply Voltage
 Performance: 96 W / 4 Ohm (BTL) unclipped, or 125 W / 4 Ohm (BTL) 10% THD+N
 110 dB Dynamic Range

Page

- 1/8: Front Page and Schematic Disclaimer
- 2/8: Overview - Modulator, Input/Output and Line Output Connectors
- 3/8: 2 Channel BTL Power Stage
- 4/8: 2 Channel BTL Power Stage
- 5/8: 1 Channel PBTL Power Stage
- 6/8: Subwoofer Line Out
- 7/8: Power Supplies & EEPROM
- 8/8: Mechanics

Copyright 2007 Texas Instruments, Inc - All rights reserved - The TI and PurePath Digital logos are trademarks of Texas Instruments.

NOTE1

SCHEMATIC DISCLAIMER

The schematic information and materials ("Materials") provided here are provided by Texas Instruments Incorporated ("TI") as a service to its customers and/or suppliers, and may be used for informational purposes only, and only subject to the following terms. By downloading or viewing these Materials, you are signifying your assent to these terms.

- 1.) These evaluation schematics are intended for use for ENGINEERING DEVELOPMENT AND EVALUATION PURPOSES ONLY and are not considered by Texas Instruments to be fit as a basis for establishing production products or systems. This information may be incomplete in several respects, including but not limited to information relating to required design, marketing, and/or manufacturing-related protective considerations and product safety measures typically found in the end-product incorporating the goods.
- 2.) Accordingly, neither TI nor its suppliers warrant the accuracy or completeness of the information, text, graphics, links or other items contained within the Materials. TI may make changes to the Materials, or to the products described therein, at any time without notice. TI makes no commitment to update the Materials.
- 3.) TI assumes no liability for applications assistance, customer product design, software performance, or services that may be described or referenced in the Materials. The user assumes all responsibility and liability for proper and safe design and handling of goods. Accordingly, the user indemnifies TI from all claims arising from its use of the Materials.
- 4.) TI currently deals with various customers for products, and therefore our arrangement with the user will not be exclusive. TI makes no representations regarding the commercial availability of non-TI components that may be referenced in the Materials.
- 5.) No license is granted under any patent right or other intellectual property right of TI covering or relating to any combination, machine, or process in which such TI products or services might be or are used. Except as expressly provided herein, TI and its suppliers do not grant any express or implied right to you under any patents, copyrights, trademarks, or trade secret information.
- 6.) Performance tests and ratings, to the extent referenced in the Materials, are measured using specific computer systems and/or components and reflect the approximate performance of TI products as measured by those tests. Any difference in system hardware or software design or configuration may affect actual performance. Buyers should consult other sources of information to evaluate the performance of systems or components they are considering purchasing.
- 7.) Resale of TI's products or services with statements different from or beyond the parameters stated by TI for that product or service in official TI data books or data sheets voids all express and any implied warranties for the associated TI product or service, and is an unfair and deceptive business practice, and TI is not responsible for any such use.
- 8.) The Materials are copyrighted and any unauthorized use may violate copyright, trademark, and other laws. You may only download one copy for your internal use only, unless you are specifically licensed to do otherwise by TI in writing. This is a license, not a transfer of title, and is subject to the following restrictions: You may not: (a) modify the Materials (including any associated warranties, conditions, limitations or notices) or use them for any commercial purpose, or any public display, performance, sale or rental; (b) decompile, reverse engineer, or disassemble software Materials except and only to the extent permitted by applicable law; (c) remove any copyright or other proprietary notices from the Materials; (d) transfer the Materials to another person. You agree to prevent any unauthorized copying of the Materials. TI may terminate this license at any time if you are in breach of the terms of this Agreement. Upon termination, you will immediately destroy the Materials.
- 9.) THE MATERIALS ARE PROVIDED "AS IS" WITHOUT ANY EXPRESS OR IMPLIED WARRANTY OF ANY KIND INCLUDING WARRANTIES OF MERCHANTABILITY, NONINFRINGEMENT OF INTELLECTUAL PROPERTY, OR FITNESS FOR ANY PARTICULAR PURPOSE. IN NO EVENT SHALL TI OR ITS SUPPLIERS BE LIABLE FOR ANY DAMAGES WHATSOEVER (INCLUDING, WITHOUT LIMITATION, DAMAGES FOR LOSS OF PROFITS, BUSINESS INTERRUPTION, LOSS OF INFORMATION) ARISING OUT OF THE USE OF OR INABILITY TO USE THE MATERIALS, EVEN IF TI HAS BEEN ADVISED OF THE POSSIBILITY OF SUCH DAMAGES.

Not Used

POWER OUTPUT STAGE (BTL)

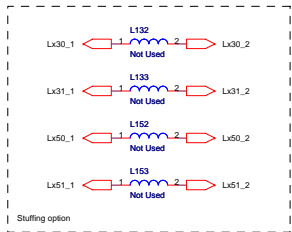
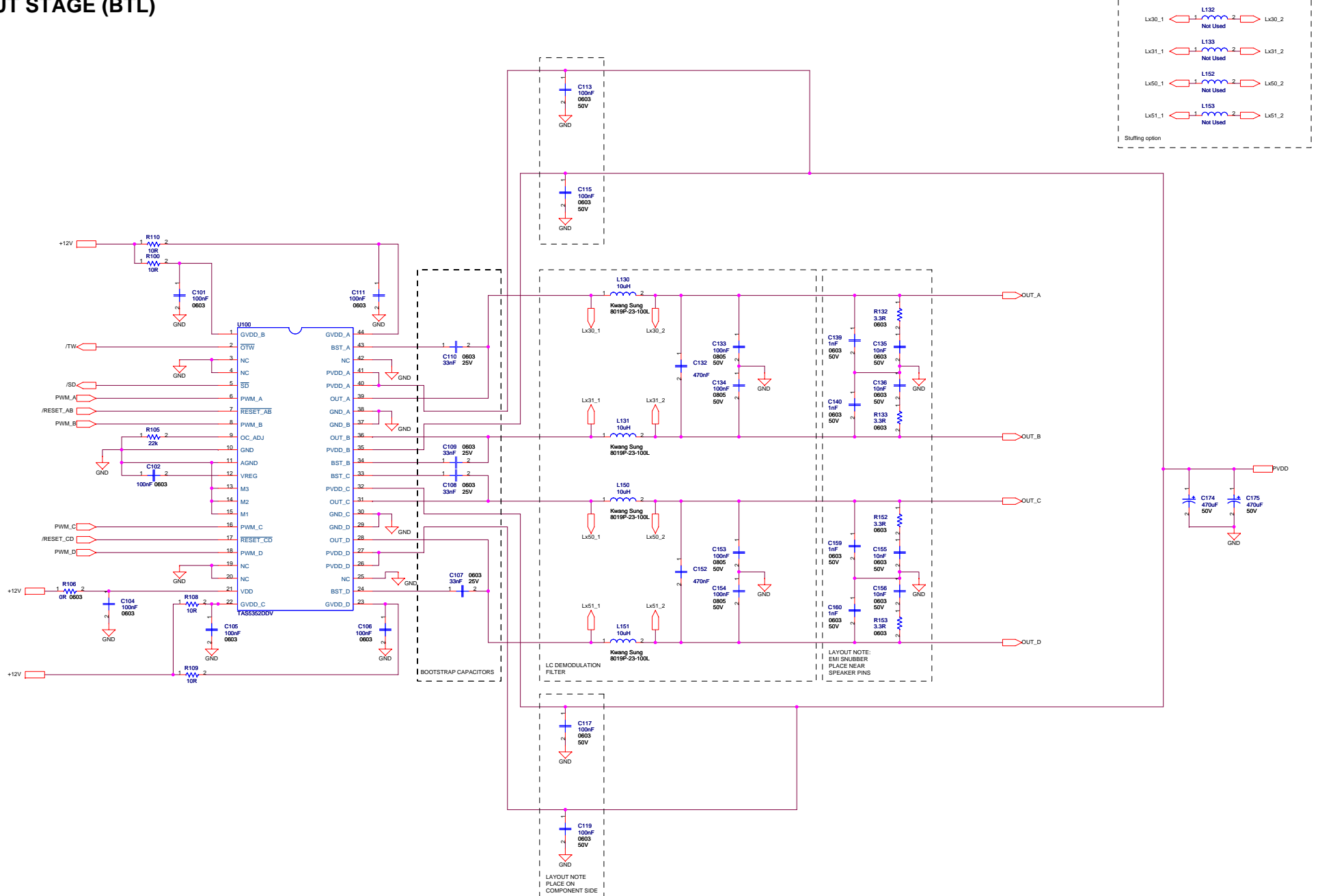

POWER OUTPUT STAGE (BTL)

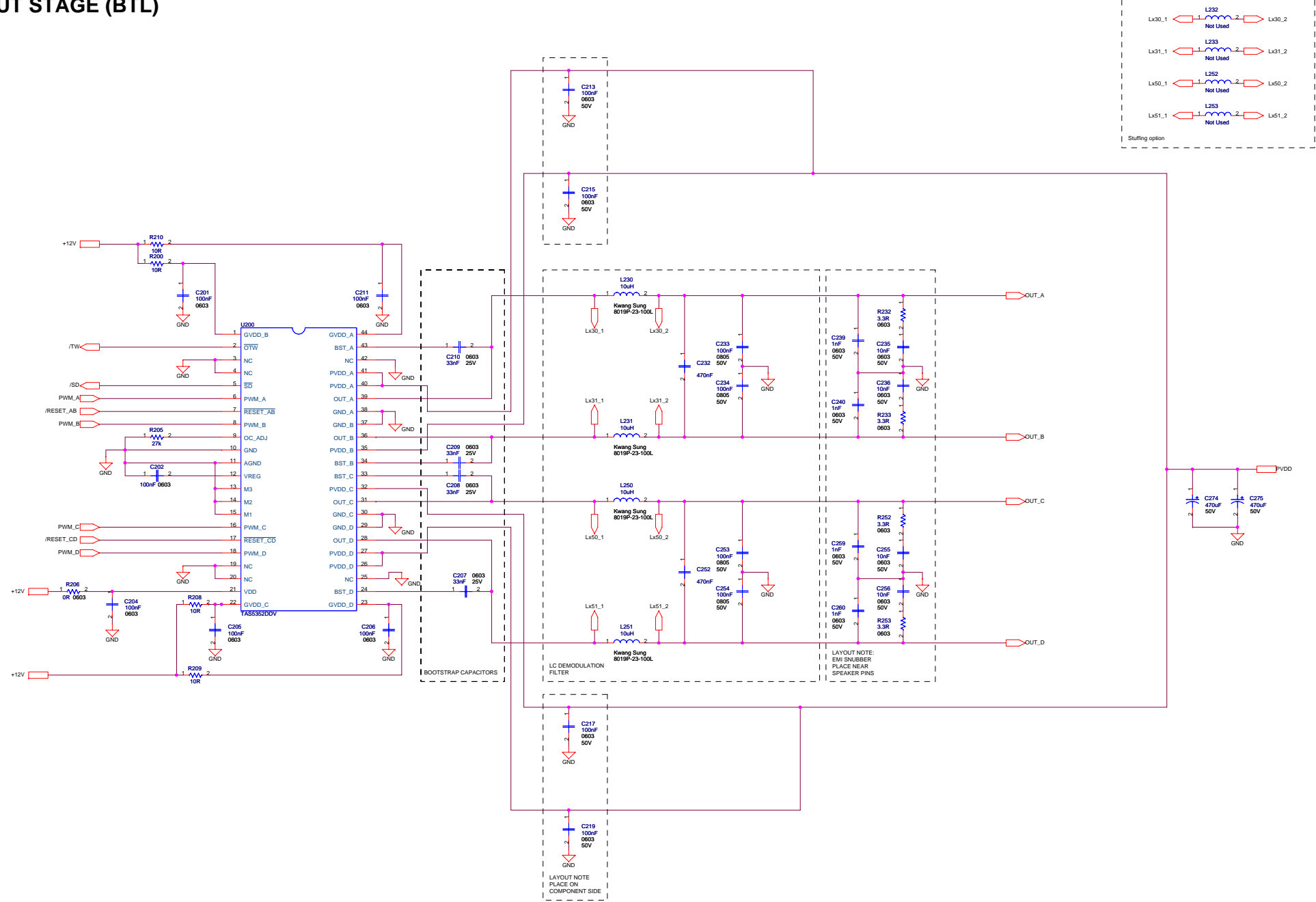

L232
 Lx30_1 Not Used Lx30_2
 L233
 Lx31_1 Not Used Lx31_2
 L252
 Lx50_1 Not Used Lx50_2
 L253
 Lx51_1 Not Used Lx51_2
 Stuffing option

LAYOUT NOTE:
 EMI SNUBBER
 PLACE NEAR
 SPEAKER PINS

LAYOUT NOTE
 PLACE ON
 COMPONENT SIDE

POWER OUTPUT STAGE (PBTL)

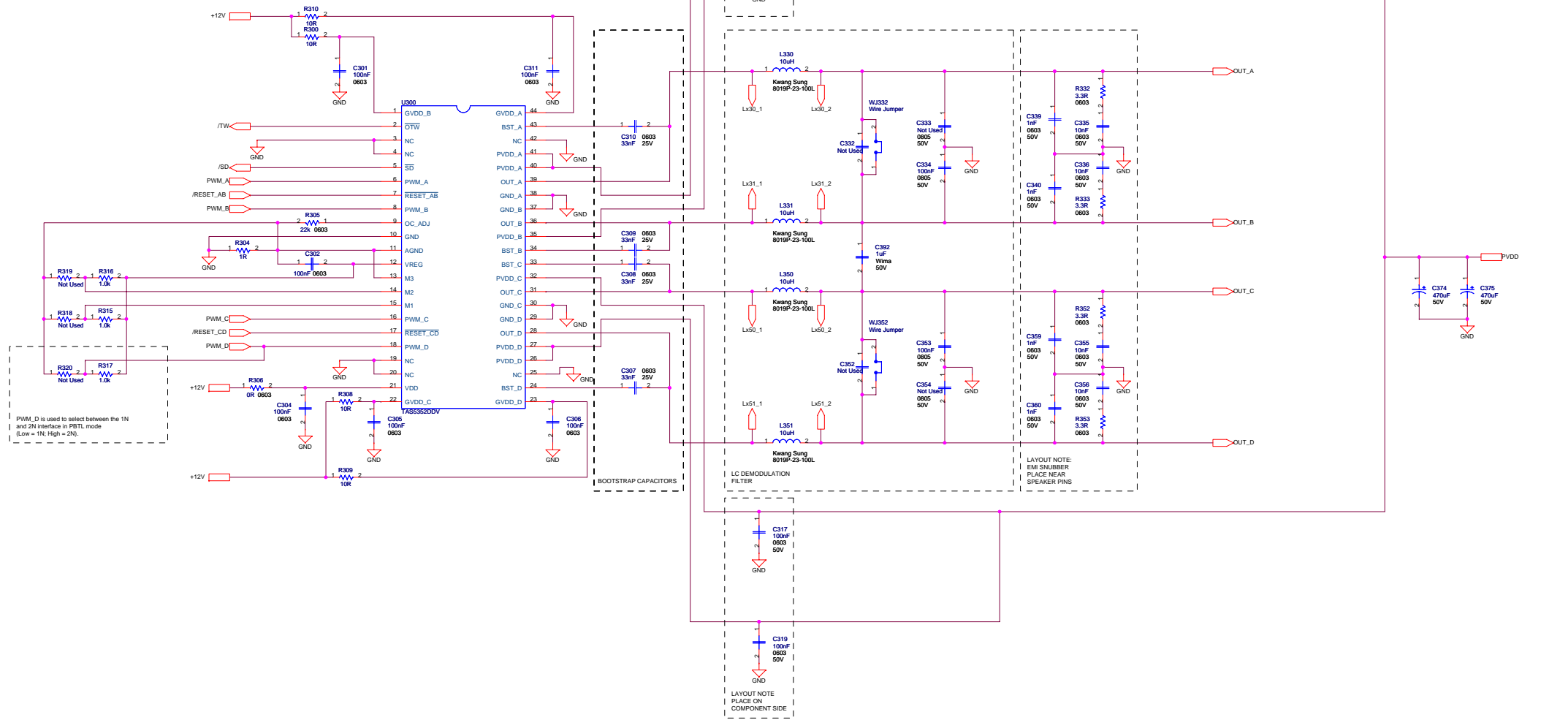
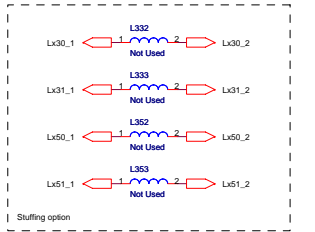

PWM_D is used to select between the 1N and 2N interface in PBTL mode (Low = 1N, High = 2N).

SUBWOOFER LINE OUT

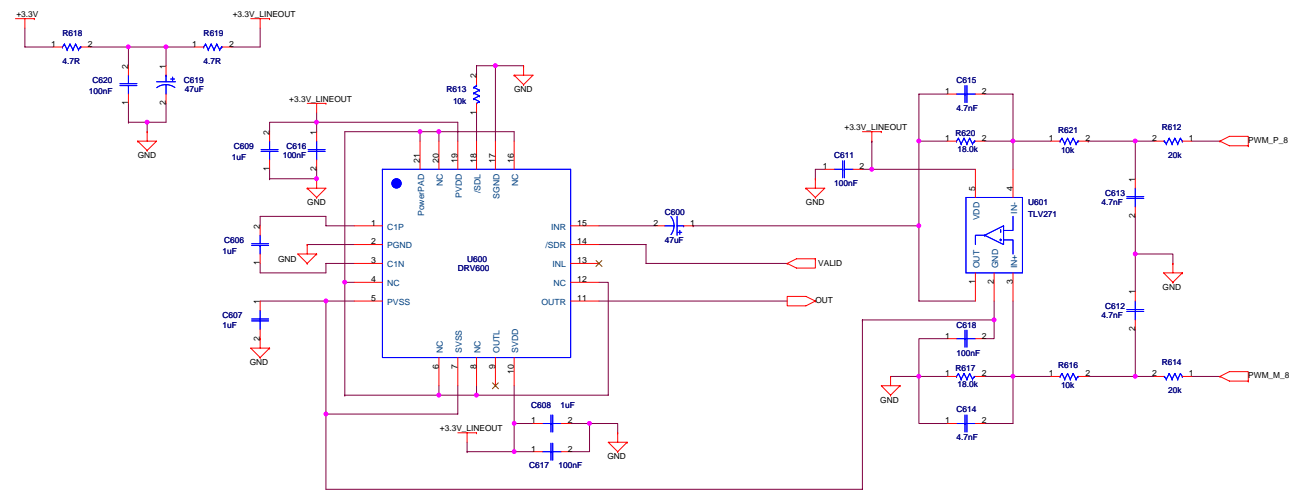

POWER SUPPLIES AND EEPROM

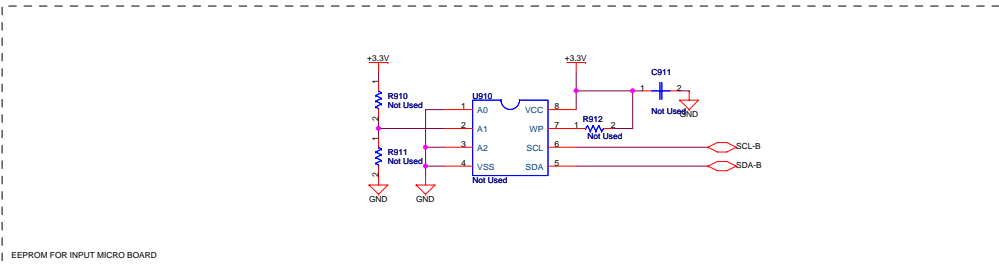
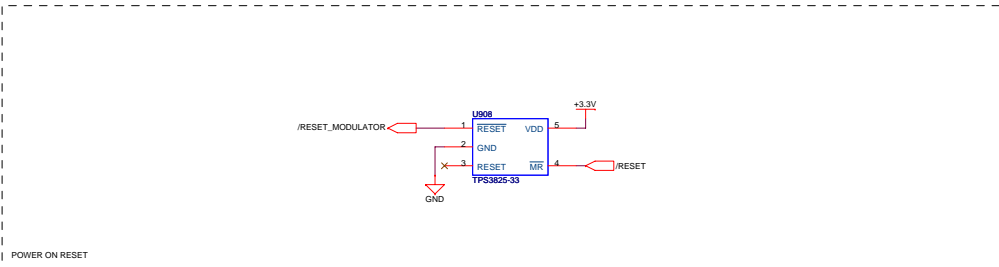
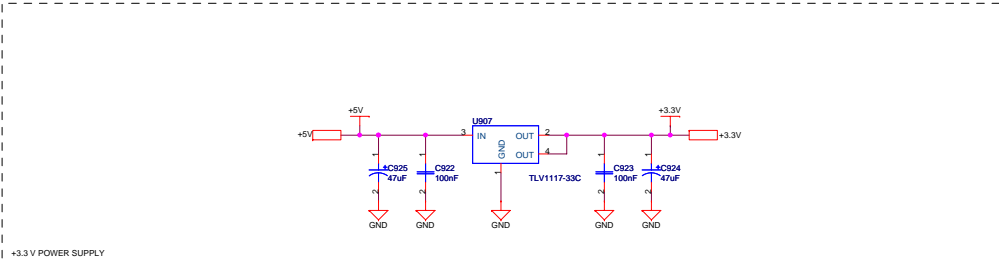
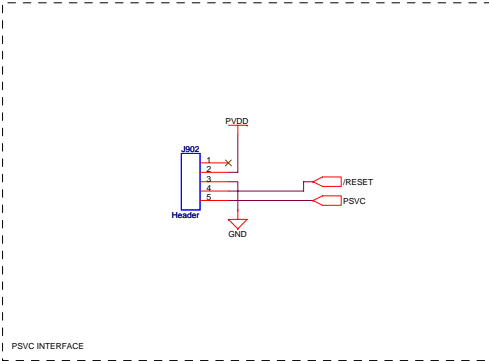
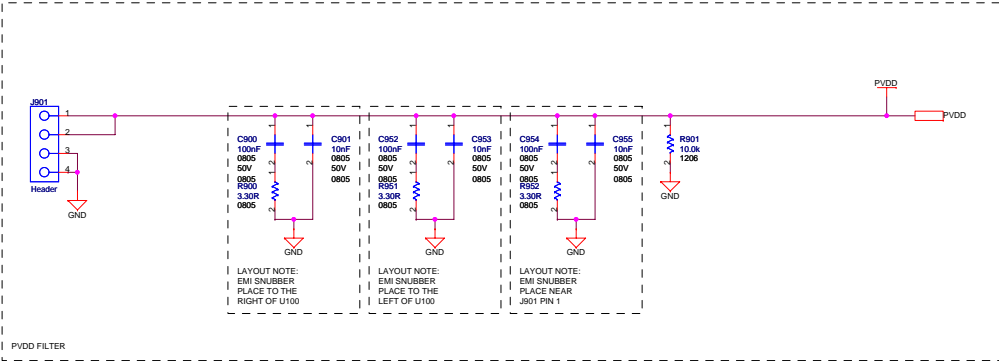

MECHANICS

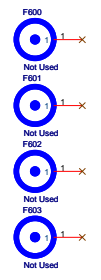
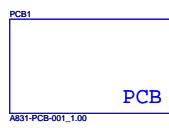
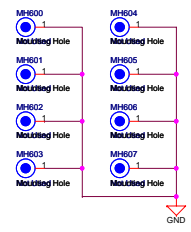
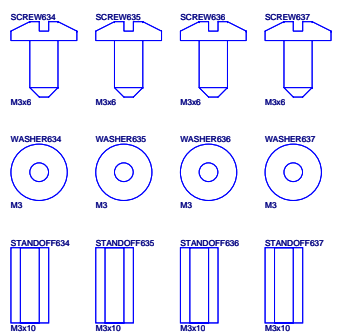
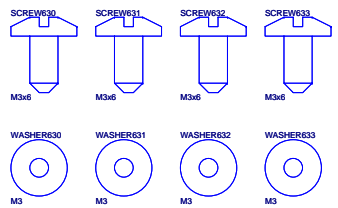
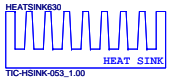

TAS5352DDV6EVM Partslist (2.00)



Qty	Part Reference	Description	Manufacture	First Mfr P/N
1	R901	10.0k / 250mW / 1% / 1206 Thick Film Resistor	Yageo	RC1206FR-0710KL
3	R900 R951 R952	3.30R / 125mW / 1% / 0805 Thick Film Resistor	Yageo	RC0805FR-073R3L
3	R106 R206 R306	0R / 5% / 0603 Thick Film Resistor	Yageo	RC0603JR-070RL
5	R90 R91 R315 R316 R317	1.0k / 100mW / 5% / 0603 Thick Film Resistor	Yageo	RC0603JR-071KL
19	R41 R42 R43 R44 R45 R46 R47 R48 R76 R77 R78 R79 R80 R81 R82 R83 R613 R616 R621	10k / 100mW / 5% / 0603 Thick Film Resistor	Yageo	RC0603JR-0710KL
1	R18	1M / 100mW / 5% / 0603 Thick Film Resistor	Yageo	RC0603JR-071ML
3	R17 R21 R304	1R / 100mW / 5% / 0603 Thick Film Resistor	Yageo	RC0603JR-071RL
12	R100 R108 R109 R110 R200 R208 R209 R210 R300 R308 R309 R310	10R / 100mW / 5% / 0603 Thick Film Resistor	Yageo	RC0603JR-0710RL
2	R617 R620	18.0k / 100mW / 5% / 0603 Thick Film Resistor	Yageo	RC0603JR-0718KL
2	R10 R11	200R / 100mW / 5% / 0603 Thick Film Resistor	Yageo	RC0603JR-07200RL
2	R612 R614	20k / 100mW / 5% / 0603 Thick Film Resistor	Yageo	RC0603JR-0720KL
2	R105 R305	22k / 100mW / 5% / 0603 Thick Film Resistor	Yageo	RC0603JR-0722KL
1	R205	27k / 100mW / 5% / 0603 Thick Film Resistor	Yageo	RC0603JR-0727KL
12	R132 R133 R152 R153 R232 R233 R252 R253 R332 R333 R352 R353	3.3R / 100mW / 5% / 0603 Thick Film Resistor	Yageo	RC0603JR-073R3L
5	R15 R16 R22 R618 R619	4.7R / 100mW / 5% / 0603 Thick Film Resistor	Yageo	RC0603JR-074R7L
29	R24 R26 R27 R28 R29 R30 R31 R32 R33 R35 R36 R37 R38 R60 R61 R62 R63 R64 R65 R66 R67 R68 R69 R70 R71 R72 R73 R74 R75	47R / 100mW / 5% / 0603 Thick Film Resistor	Yageo	RC0603JR-0747RL
3	C901 C953 C955	Ceramic 10nF / 50V / 20% X7R 0805 Capacitor	BC Components	0805B103M500NT
13	C133 C134 C153 C154 C233 C234 C253 C254 C334 C353 C900 C952 C954	Ceramic 100nF / 50V / 20% X7R 0805 Capacitor	BC Components	0805B104M500NT
4	C606 C607 C608 C609	Ceramic 1uF / 16V / 20% X7R 0805 Capacitor	BC Components	0805B105M160NT
4	C612 C613 C614 C615	Ceramic 4.7nF / 50V / 10% X7R 0805 Capacitor	BC Components	0805B472K500NT
14	C10 C13 C135 C136 C155 C156 C235 C236 C255 C256 C335 C336 C355 C356 C11 C12 C14 C15 C17 C21 C22 C25 C27 C28 C30 C60 C61 C101 C102 C104 C105 C106 C111 C201 C202 C204 C205 C206 C211 C301 C302 C304 C305 C306 C311	Ceramic 10nF / 50V / 20% X7R 0603 Capacitor	Vishay	VJ0603Y103MXA
38	C611 C616 C617 C618 C620 C922 C923 C113 C115 C117 C119 C213 C215 C217 C219 C313 C315 C317 C319	Ceramic 100nF / 16V / 20% X7R 0603 Capacitor	Vishay	VJ0603Y104MXJ
12	C107 C108 C109 C110 C207 C208 C209 C210 C307 C308 C309 C310	Ceramic 33nF / 25V / 20% X7R 0603 Capacitor	BC Components	0603B333M250NT
13	C19 C139 C140 C159 C160 C239 C240 C259 C260 C339 C340 C359 C360	Ceramic 1nF / 50V / 10% NP0 0603 Capacitor	BC Components	0603N102K500NT
2	C23 C24	Ceramic 15pF / 50V / 10% NP0 0603 Capacitor	BC Components	0603N150K500NT
9	C16 C20 C26 C29 C62 C600 C619 C924 C925	Electrolytic 47uF / 16V / 20% Aluminium 2mm ø5mm FC Series - Low Impedance Capacitor	Panasonic	EEUFC1C470
6	C174 C175 C274 C275 C374 C375	Electrolytic 470uF / 50V / 20% Aluminium 5mm ø12.5mm FC Series - Low Impedance Capacitor	Panasonic	EEUFC1H471B
1	C392	Metal Film 1uF / 50V / 10% Polyester 7.5mm (W:4.5mm L:10mm) Capacitor	Wima	MKS 4 1uF/10%/50Vdc PCM7.5
4	C132 C152 C232 C252	Metal Film 470nF / 63V / 10% Polyester 5mm (W:4.5mm L:7.2mm) Capacitor	Wima	MKS 2 0.47uF/10%/63Vdc PCM5
12	L130 L131 L150 L151 L230 L231 L250 L251 L330 L331 L350 L351	10uH / Ferrite Inductor	Kwang Sung	8019P-23-100L
2	WJ332 WJ352	Wire Jumper / Wire ø0.9mm (SWG20), Pitch 7.5mm, Copper Tinned Wire Jumper Inductor	n/a	n/a
2	D10 D11	Light Emitting Red Red LED (0603)	Toshiba	TLSU1008
3	U100 U200 U300	TAS5352DDV / STEREO DIGITAL AMPLIFIER POWER STAGE (DDV44)	Texas Instruments	TAS5352DDV
1	U10	TAS5518 / 8 ch PWM processor (AD, DAP, 192kHz, PWM-VOL) (TQFP64)	Texas Instruments	TAS5518PAG
1	U601	TLV271 / RrR Output Opamp (SOT23-5)	Texas Instruments	TLV271CDBVT
1	U600	DRV600 / DirectPath(TM) Audio Line Driver (QFN- 20)	Texas Instruments	DRV600RTJT
1	U908	TPS3825-33 / 3.3V Supply Voltage Supervisor (SOP5-DBV)	Texas Instruments	TPS3825-33DBVT
1	U907	TLV1117-33C / 3.3V/800mA Positive Voltage Regulator (SOT4-DCY)	Texas Instruments	TLV1117-33CDCYR
8	SCREW630 SCREW631 SCREW632 SCREW633 SCREW634 SCREW635 SCREW636 SCREW637	M3x6 Pan Head, Pozidriv, A2 Screw	Bossard	BN 81882 M3x6
8	WASHER630 WASHER631 WASHER632 WASHER633 WASHER634 WASHER635 WASHER636 WASHER637	M3 Stainless Steel Spring Washer	Bossard	BN 760 M3
4	STANDOFF634 STANDOFF635 STANDOFF636 STANDOFF637	M3x10 Aluminium Stand-off	Ettinger	05.03.108
1	J902	5 pins / 1 row / 2.54mm Pitch Vertical Male Friction lock Pin header Header	Molex	22-27-2051

TAS5352DDV6EVM Partslist (2.00)



5	J101 J102 J103 J104 J117	2 pins / 1 row / 3.96mm Pitch Vertical Male Pin header Header	JST	B2P-VH
1	J901	4 pins / 1 row / 3.96mm Pitch Vertical Male Pin header Header	JST	B4P-VH
1	J600	Horizontal Female w. Switch Coax Phono socket	Chunfeng	RJ843-4W
1	J10	profile IDC 26 pins IDC Box header	Molex	87834-2611
1	X10	13.5MHz 13.5MHz SMD Crystal (HCM49)	Citizen	HCM49-13.500MABJT
1	PCB1	A831-PCB-001_1.00 / TAS5352DDV6EVM Printed Circuit Board (ver. 1.00)	Printline	A831-PCB-001(1.00)
1	HEATSINK630	TIC-HSINK-053_1.00 / Heatsink for 3 DDV packages length 114 mm	Phonotech	TIC-HSINK-053(1.00)

TAS5352DDV6EVM (A831)

PCB SPECIFICATION

Version 1.00

BOARD IDENTIFICATION:	A831-PCB-001(1.00)
BOARD TYPE:	DOUBLE-SIDED PLATED-THROUGH BOARD
LAMINATE TYPE:	FR4
LAMINATE THICKNESS:	1.6 mm
COPPER THICKNESS:	70 μm (INCL. PLATING EXTERIOR LAYER)
COPPER PLATING OF HOLES:	>25 μm
MINIMUM HOLE DIAMETER	0.3 mm
SILKSCREEN COMPONENT SIDE:	WHITE - REMOVE SILKSCREEN FROM SOLDER AREA & PRE-TINNED AREAS
SILKSCREEN SOLDER SIDE:	None
SOLDER MASK COMPONENT SIDE:	GREEN
SOLDER MASK SOLDER SIDE:	GREEN
PROTECTIVE COATING:	SOLDER COATING AND CHEMICAL SILVER ON FREE COPPER
ELECTRICAL TEST:	PCB MUST BE ELECTRICAL TESTED
MANUFACTURED TO:	PERFAG 2E (www.perfag.dk)
APERTURE TABLE:	PERFAG 10A (www.perfag.dk)
BOARD SIZE:	114 x 149 mm
COMMENTS:	SEE DRILL INFORMATION FILE (PCBDOC.ZIP).

TEXAS
INSTRUMENTS
TAS5352DDV6EVM

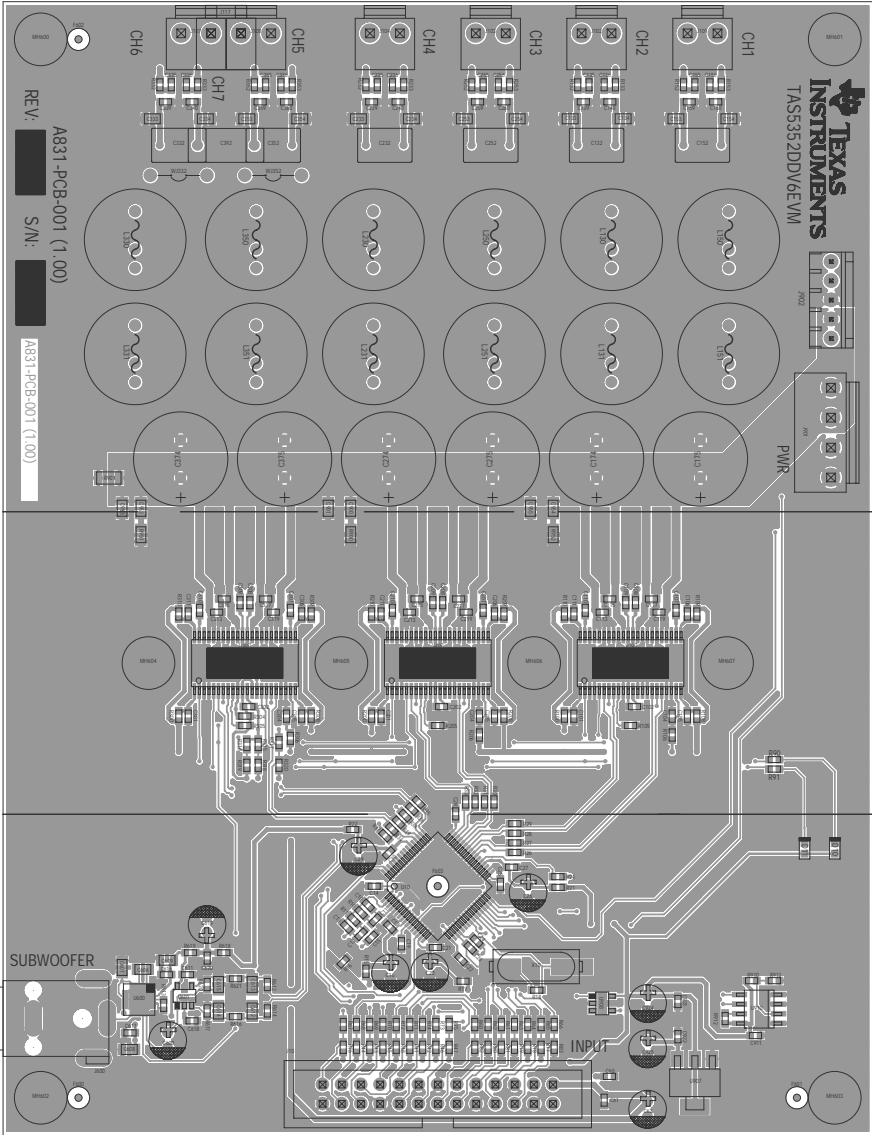

A831-PCB-001 (1.00)
REV. [REDACTED] S/N: [REDACTED]
A831-PCB-001 (1.00)

POS	Texas Instruments Lyngby Hovedgade 4, DK-2800 Lyngby		
	Title TASS352DDV6EVM	Date 2007/NOV/16	
	P/N A831-PCB-001	REV 1	Designer CMS
	LAYER 01 - SHEET 01 OF 06		Engineer Jonas L. Holm

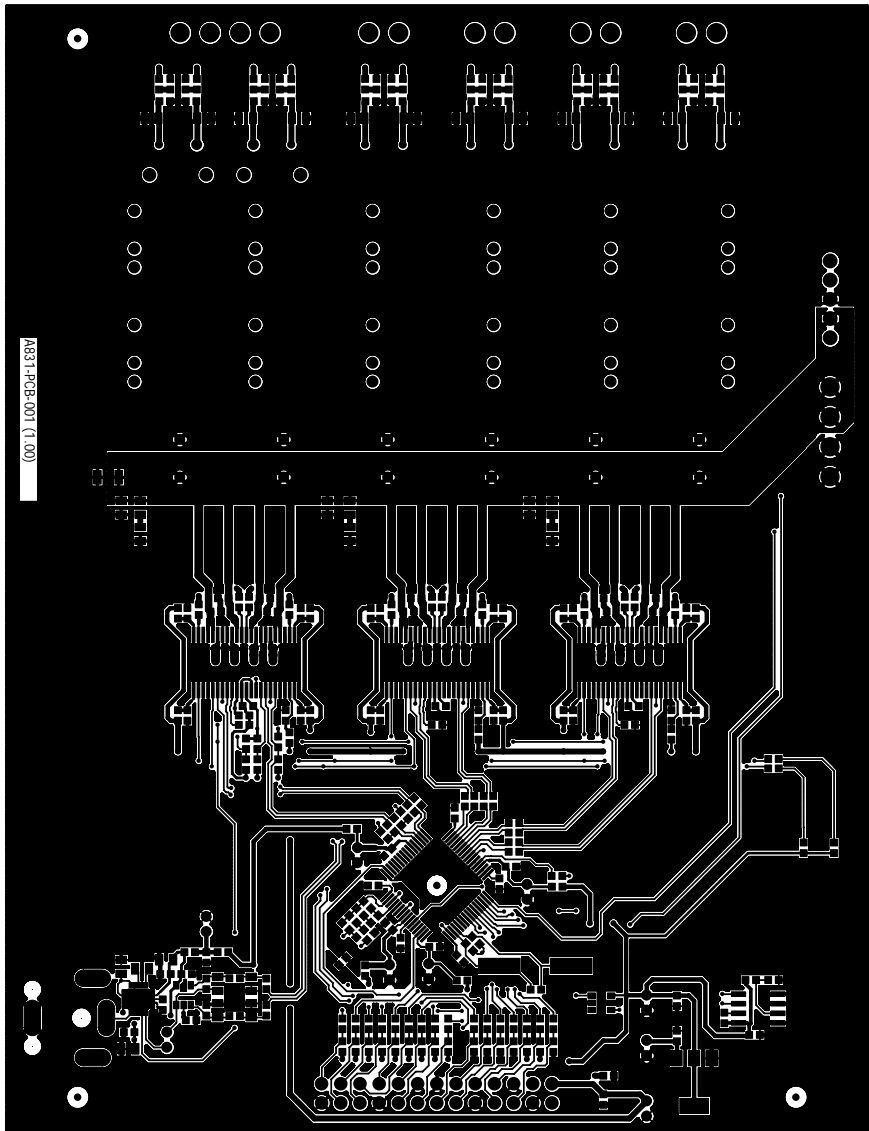

POS	Texas Instruments Lyngby Hovedgade 4, DK-2800 Lyngby		
	Title TASS352DDV6EVM	Date 2007/NOV/16	
	P/N A831-PCB-001	REV 1	Designer CMS
	LAYER 02 - SHEET 02 OF 06	Engineer Jonas L. Holm	

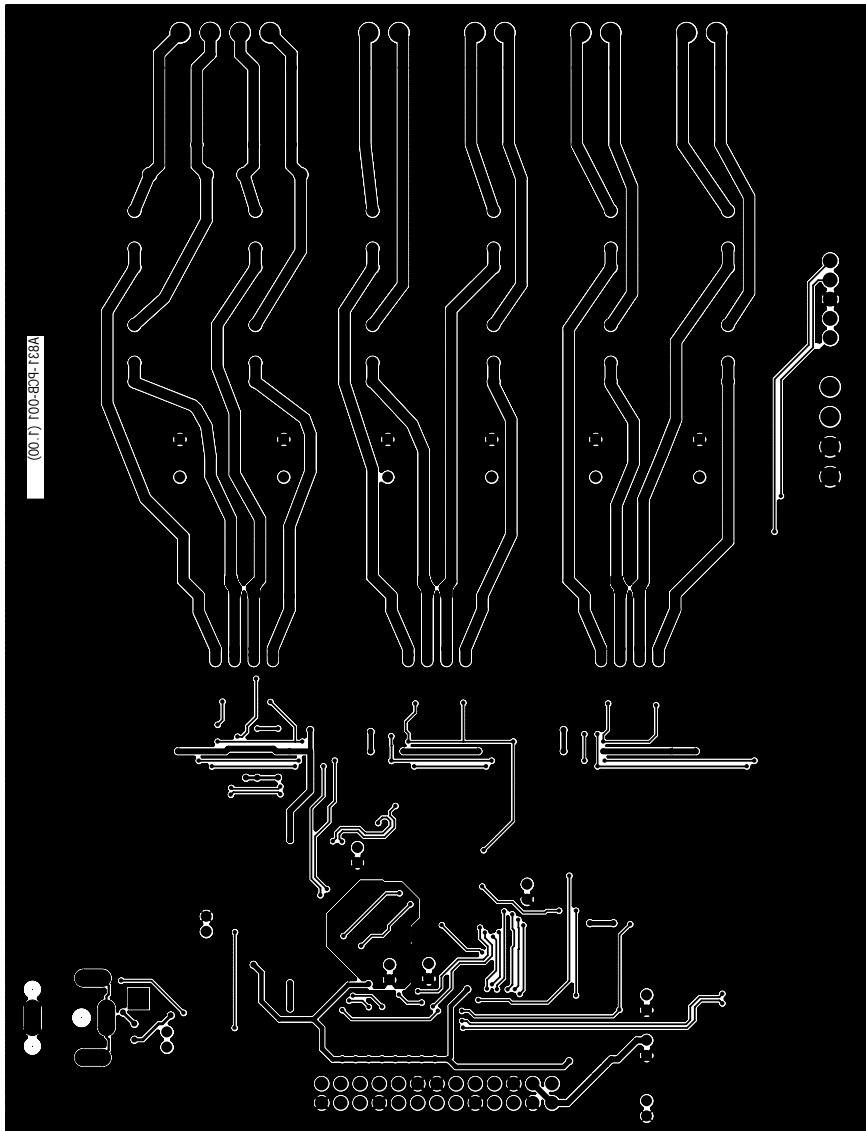

TIC-HSINK-053(1.00)

Heatsink for 3 DDV packages

10.July 2007
TIC-HSINK-053(1.00).dwg

Jonas L. Holm

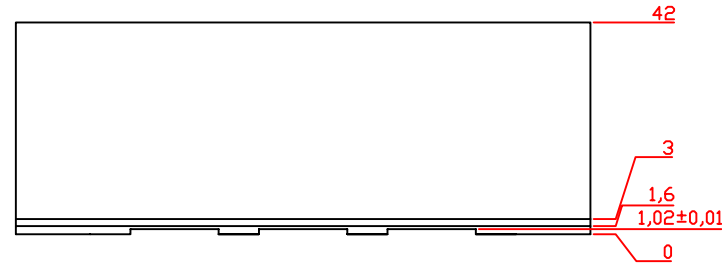
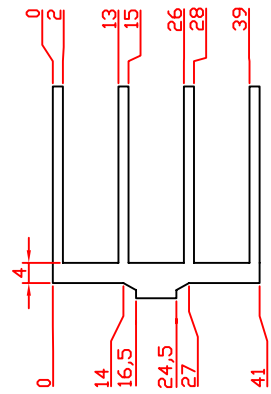
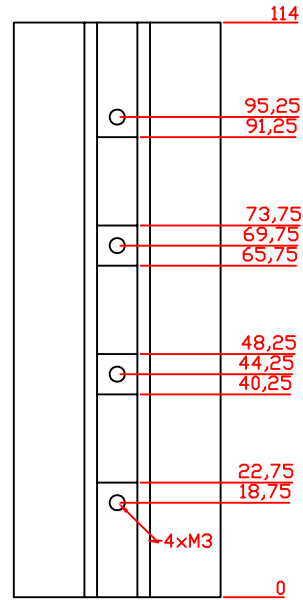

SCALE: 1:1.5
PROFILE: TIC-HSINK-050(1.00)
DIMENSIONS: mm
MATERIAL: ALUMINUM
INTERNAL SCREW THREADS: M3
SURFACE: FREE OF SHARP EDGES
SURFACE TREATMENT: BLACK ANODIZED
TOLERANCES: +/- 0.1 mm

IMPORTANT NOTICE

Texas Instruments Incorporated and its subsidiaries (TI) reserve the right to make corrections, modifications, enhancements, improvements, and other changes to its products and services at any time and to discontinue any product or service without notice. Customers should obtain the latest relevant information before placing orders and should verify that such information is current and complete. All products are sold subject to TI's terms and conditions of sale supplied at the time of order acknowledgment.

TI warrants performance of its hardware products to the specifications applicable at the time of sale in accordance with TI's standard warranty. Testing and other quality control techniques are used to the extent TI deems necessary to support this warranty. Except where mandated by government requirements, testing of all parameters of each product is not necessarily performed.

TI assumes no liability for applications assistance or customer product design. Customers are responsible for their products and applications using TI components. To minimize the risks associated with customer products and applications, customers should provide adequate design and operating safeguards.

TI does not warrant or represent that any license, either express or implied, is granted under any TI patent right, copyright, mask work right, or other TI intellectual property right relating to any combination, machine, or process in which TI products or services are used. Information published by TI regarding third-party products or services does not constitute a license from TI to use such products or services or a warranty or endorsement thereof. Use of such information may require a license from a third party under the patents or other intellectual property of the third party, or a license from TI under the patents or other intellectual property of TI.

Reproduction of TI information in TI data books or data sheets is permissible only if reproduction is without alteration and is accompanied by all associated warranties, conditions, limitations, and notices. Reproduction of this information with alteration is an unfair and deceptive business practice. TI is not responsible or liable for such altered documentation. Information of third parties may be subject to additional restrictions.

Resale of TI products or services with statements different from or beyond the parameters stated by TI for that product or service voids all express and any implied warranties for the associated TI product or service and is an unfair and deceptive business practice. TI is not responsible or liable for any such statements.

TI products are not authorized for use in safety-critical applications (such as life support) where a failure of the TI product would reasonably be expected to cause severe personal injury or death, unless officers of the parties have executed an agreement specifically governing such use. Buyers represent that they have all necessary expertise in the safety and regulatory ramifications of their applications, and acknowledge and agree that they are solely responsible for all legal, regulatory and safety-related requirements concerning their products and any use of TI products in such safety-critical applications, notwithstanding any applications-related information or support that may be provided by TI. Further, Buyers must fully indemnify TI and its representatives against any damages arising out of the use of TI products in such safety-critical applications.

TI products are neither designed nor intended for use in military/aerospace applications or environments unless the TI products are specifically designated by TI as military-grade or "enhanced plastic." Only products designated by TI as military-grade meet military specifications. Buyers acknowledge and agree that any such use of TI products which TI has not designated as military-grade is solely at the Buyer's risk, and that they are solely responsible for compliance with all legal and regulatory requirements in connection with such use.

TI products are neither designed nor intended for use in automotive applications or environments unless the specific TI products are designated by TI as compliant with ISO/TS 16949 requirements. Buyers acknowledge and agree that, if they use any non-designated products in automotive applications, TI will not be responsible for any failure to meet such requirements.

Following are URLs where you can obtain information on other Texas Instruments products and application solutions:

Products

Amplifiers	amplifier.ti.com
Data Converters	dataconverter.ti.com
DSP	dsp.ti.com
Clocks and Timers	www.ti.com/clocks
Interface	interface.ti.com
Logic	logic.ti.com
Power Mgmt	power.ti.com
Microcontrollers	microcontroller.ti.com
RFID	www.ti-rfid.com
RF/IF and ZigBee® Solutions	www.ti.com/lprf

Applications

Audio	www.ti.com/audio
Automotive	www.ti.com/automotive
Broadband	www.ti.com/broadband
Digital Control	www.ti.com/digitalcontrol
Medical	www.ti.com/medical
Military	www.ti.com/military
Optical Networking	www.ti.com/opticalnetwork
Security	www.ti.com/security
Telephony	www.ti.com/telephony
Video & Imaging	www.ti.com/video
Wireless	www.ti.com/wireless

Mailing Address: Texas Instruments, Post Office Box 655303, Dallas, Texas 75265
Copyright © 2008, Texas Instruments Incorporated