

## LM2901B-Q1, LM2901x-Q1 Quadruple Automotive Comparator

### 1 Features

- Qualified for automotive applications
- AEC-Q100 Qualified with the following results:
  - Device temperature grade 1:  $-40^{\circ}\text{C}$  to  $125^{\circ}\text{C}$  ambient operating temperature range
  - Device HBM ESD classification levels:
    - Class 1C for "AV" version
    - Class 2 for all other versions
  - Device CDM ESD classification level C3
- Improved 2 kV HBM ESD for "B" device
- Single supply or dual supplies
- Low supply-current independent of supply voltage 200  $\mu\text{A}$  typical per comparator ("B" Versions)
- Low input bias current 3.5 nA typical ("B" device)
- Low input offset current 0.5 nA typ ("B" device)
- Low input offset voltage  $\pm 0.37$  mV typ ("B" device)
- Common-mode input voltage range includes ground
- Differential input voltage range equal to maximum-rated supply voltage  $\pm 36$  V
- Output compatible with TTL, MOS, and CMOS
- For single version in SOT, see the TL331-Q1 (SLVS969)
- For dual version in multiple packages, see the LM2903x-Q1 (SLCS141)
- **Functional Safety-Capable**
  - [Documentation available to aid functional safety system design](#)

### 2 Applications

- **Automotive**
  - [HEV/EV and power train](#)
  - [Infotainment and cluster](#)
  - [Body control module](#)
- **Industrial**
- **Appliances**

### 3 Description

The LM2901B-Q1 device is the next generation version of the industry-standard LM2901x-Q1 comparator family. This next generation family provides outstanding value for cost-sensitive applications, with features including lower offset voltage, higher supply voltage capability, lower supply current, lower input bias current, lower propagation delay, and improved 2kV ESD performance with drop-in replacement convenience.

All devices consist of four independent voltage comparators that are designed to operate over a wide range of voltages. Operation from dual supplies also is possible as long as the difference between the two supplies is within 2 V to 36 V, and VCC is at least 1.5 V more positive than the input common-mode voltage. The outputs can be connected to other open-collector outputs.

The "V" versions operate up to 32V, and the "B" version operates up to 36V. All are qualified for the AEC-Q100 Grade 1 temperature range of  $-40^{\circ}\text{C}$  to  $+125^{\circ}\text{C}$ .

#### Device Information

PART NUMBER	PACKAGE <sup>(1)</sup>	BODY SIZE (NOM)
LM2901B-Q1	TSSOP (14)	4.40 mm × 5.00 mm
LM2901-Q1	SOIC (14)	3.91 mm × 8.65 mm
LM2901A-Q1		
LM2901B-Q1 (Preview)	SOT-23 (14)	4.20 mm × 2.00 mm
	X2QFN (14)	2.00 mm × 2.00 mm
	WQFN (16)	3.00 mm × 3.00 mm

(1) For all available packages, see the orderable addendum at the end of the data sheet.

#### Family Comparison Table

Specification	LM2901B-Q1	LM2901-Q1	LM2901V-Q1	LM2901AV-Q1	Units
Supply Voltage	2 to 36	2 to 30	2 to 32	2 to 32	V
Total Supply Current (5 V to 36 V maximum)	0.6 to 0.8	1 to 2.5	1 to 2.5	1 to 2.5	mA
Temperature Range	$-40$ to $125$	$-40$ to $125$	$-40$ to $125$	$-40$ to $125$	$^{\circ}\text{C}$
ESD (HBM)	2000	2000	2000	1000	V
Offset Voltage (maximum overtemp)	$\pm 5.5$	$\pm 15$	$\pm 15$	$\pm 4$	mV
Input Bias Current (typical / maximum)	3.5 / 25	25 / 250	25 / 250	25 / 250	nA
Response Time (typical)	1	1.3	1.3	1.3	$\mu\text{sec}$



## Table of Contents

<b>1 Features</b> .....	1	6.14 Typical Characteristics: LM2901x-Q1.....	16
<b>2 Applications</b> .....	1	<b>7 Detailed Description</b> .....	17
<b>3 Description</b> .....	1	7.1 Overview.....	17
<b>4 Revision History</b> .....	2	7.2 Functional Block Diagram.....	17
<b>5 Pin Configuration and Functions</b> .....	3	7.3 Feature Description.....	17
<b>6 Specifications</b> .....	5	7.4 Device Functional Modes.....	17
6.1 Absolute Maximum Ratings for LM2901B-Q1.....	5	<b>8 Application and Implementation</b> .....	18
6.2 Absolute Maximum Ratings for LM2901x-Q1.....	5	8.1 Application Information.....	18
6.3 ESD Ratings for LM2901B-Q1.....	6	8.2 Typical Application.....	18
6.4 ESD Ratings for LM2901x-Q1.....	6	<b>9 Power Supply Recommendations</b> .....	20
6.5 Recommended Operating Conditions for LM2901B-Q1.....	6	<b>10 Layout</b> .....	20
6.6 Recommended Operating Conditions for LM2901x-Q1.....	6	10.1 Layout Guidelines.....	20
6.7 Thermal Information for LM2901B-Q1.....	7	10.2 Layout Example.....	20
6.8 Thermal Information for LM2901x-Q1.....	7	<b>11 Device and Documentation Support</b> .....	21
6.9 Electrical Characteristics for LM2901B-Q1.....	8	11.1 Documentation Support.....	21
6.10 Switching Characteristics for LM2901B-Q1.....	8	11.2 Related Links.....	21
6.11 Electrical Characteristics for LM2901x-Q1.....	9	11.3 Trademarks.....	21
6.12 Switching Characteristics for LM2901x-Q1.....	9	11.4 Electrostatic Discharge Caution.....	21
6.13 Typical Characteristics: LM2901B-Q1.....	10	11.5 Glossary.....	21
		<b>12 Mechanical, Packaging, and Orderable Information</b> .....	21

## 4 Revision History

<b>Changes from Revision F (May 2021) to Revision G (March 2023)</b>	<b>Page</b>
• Updated front page <i>Features</i> and <i>Description</i> text for "B" version.....	1
• Updated front page CDM ESD Classifications.....	1
• Added front page <i>Family Comparison</i> Table.....	1
• Added "B" device description, electrical tables, graphs and pinouts throughout.....	5

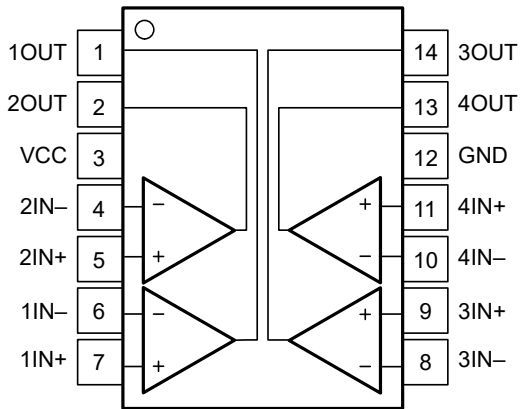
---

<b>Changes from Revision E (January 2015) to Revision F (May 2021)</b>	<b>Page</b>
• Updated front page HBM ESD Classification.....	1
• Updated the numbering format for tables, figures, and cross-references throughout the document.....	1
• Added separate line for 1kV LM2901AV-Q1 HBM in ESD Ratings table.....	6
• Changed incorrect text in Apps Section Feature Description.....	17
• Changed incorrect Layout Example pinout.....	20

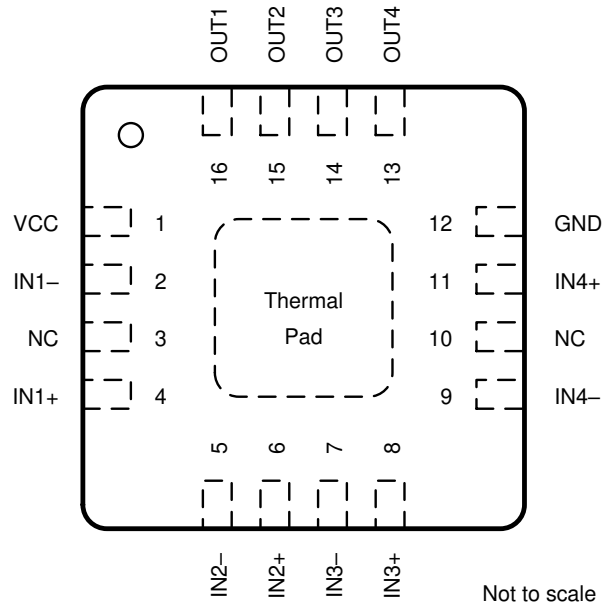
---

<b>Changes from Revision D (April 2008) to Revision E (January 2015)</b>	<b>Page</b>
• Added AEC-Q100 results to the <i>Features</i> section.....	1
• Added <i>ESD Ratings</i> table, <i>Feature Description</i> section, <i>Device Functional Modes</i> , <i>Application and Implementation</i> section, <i>Power Supply Recommendations</i> section, <i>Layout</i> section, <i>Device and Documentation Support</i> section, and <i>Mechanical, Packaging, and Orderable Information</i> section.....	1
• Added the common-mode voltage note to the $V_{ICR}$ parameter in the <i>Electrical Characteristics</i> table.....	9

## 5 Pin Configuration and Functions

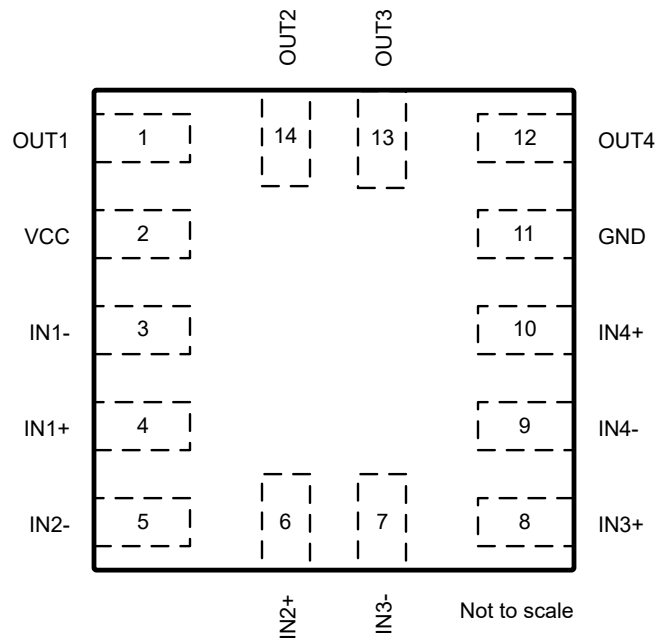


**Figure 5-1. D, PW and DYY Packages  
 14-Pin SOIC, TSSOP and SOT-23  
 Top View**



NOTE: Connect exposed thermal pad directly to GND pin.

**Figure 5-2. RTE Package  
 16-Pad WQFN With Exposed Thermal Pad  
 Top View**



**Figure 5-3. RUC Package  
 14-Pad X2QFN  
 Top View**

**Table 5-1. Pin Functions**

NAME <sup>(1)</sup>	PIN			I/O	DESCRIPTION
	SOIC, TSSOP, DYY	X2QFN	WQFN		
OUT1 <sup>(1)</sup>	1	14	16	Output	Output pin of the comparator 2
OUT2 <sup>(1)</sup>	2	1	15	Output	Output pin of the comparator 1
V <sub>CC</sub>	3	2	1	—	Positive supply
IN2- <sup>(1)</sup>	4	3	5	Input	Negative input pin of the comparator 1
IN2+ <sup>(1)</sup>	5	4	6	Input	Positive input pin of the comparator 1
IN1- <sup>(1)</sup>	6	5	2	Input	Negative input pin of the comparator 2
IN1+ <sup>(1)</sup>	7	6	4	Input	Positive input pin of the comparator 2
IN3-	8	7	7	Input	Negative input pin of the comparator 3
IN3+	9	8	8	Input	Positive input pin of the comparator 3
IN4-	10	9	9	Input	Negative input pin of the comparator 4
IN4+	11	10	11	Input	Positive input pin of the comparator 4
GND	12	11	12	—	Negative supply
OUT4	13	12	13	Output	Output pin of the comparator 4
OUT3	14	13	14	Output	Output pin of the comparator 3
NC	—	—	3	—	No Internal Connection - Leave floating or GND
NC	—	—	10	—	No Internal Connection - Leave floating or GND
Thermal Pad	—	—	PAD	—	Connect directly to GND pin

(1) Some manufacturers transpose the names of channels 1 & 2. Electrically the pinouts are identical, just a difference in channel naming convention.

## 6 Specifications

### 6.1 Absolute Maximum Ratings for LM2901B-Q1

over operating free-air temperature range (unless otherwise noted)<sup>(1)</sup>

	MIN	MAX	UNIT
Supply voltage: $V_S = (V+) - (V-)$	-0.3	38	V
Differential input voltage: $V_{ID}$ <sup>(2)</sup>		±38	V
Input pins (IN+, IN-)	-0.3	38	V
Current into input pins (IN+, IN-)		-50	mA
Output pin (OUT)	-0.3	38	V
Output sink current		25	mA
Output short-circuit duration <sup>(3)</sup>		Unlimited	s
Junction temperature, $T_J$	TBD	150	°C
Storage temperature, $T_{stg}$	-65	150	°C

- (1) Stresses beyond those listed under *Absolute Maximum Ratings* may cause permanent damage to the device. These are stress ratings only, which do not imply functional operation of the device at these or any other conditions beyond those indicated under *Recommended Operating Conditions*. Exposure to absolute-maximum-rated conditions for extended periods may affect device reliability.
- (2) Differential voltages are at IN+ with respect to IN-
- (3) Short circuits from outputs to V+ can cause excessive heating and eventual destruction.

### 6.2 Absolute Maximum Ratings for LM2901x-Q1

over operating free-air temperature range (unless otherwise noted)<sup>(1)</sup>

	MIN	MAX	UNIT
Supply voltage, $V_{CC}$ <sup>(2)</sup>		36	V
Differential input voltage, $V_{ID}$ <sup>(3)</sup>		±36	
Input voltage range, $V_I$ (either input)	-0.3	36	
Output voltage, $V_O$		36	mA
Output current, $I_O$		20	
Duration of output short circuit to ground <sup>(4)</sup>		Unlimited	
Operating virtual junction temperature, $T_J$		150	°C
Storage temperature, $T_{stg}$	-65	150	°C

- (1) Operation outside the Absolute Maximum Ratings may cause permanent device damage. Absolute Maximum Ratings do not imply functional operation of the device at these or any other conditions beyond those listed under Recommended Operating Conditions. If used outside the Recommended Operating Conditions but within the Absolute Maximum Ratings, the device may not be fully functional, and this may affect device reliability, functionality, performance, and shorten the device lifetime.
- (2) All voltage values, except differential voltages, are with respect to network ground.
- (3) Differential voltages are at IN+ with respect to IN-.
- (4) Short circuits from outputs to  $V_{CC}$  can cause excessive heating and eventual destruction.

### 6.3 ESD Ratings for LM2901B-Q1

			VALUE	UNIT
V <sub>(ESD)</sub>	Electrostatic discharge	Human-body model (HBM), per AEC Q100-002 <sup>(1)</sup>	±2000	V
		Charged-device model (CDM), per AEC Q100-011 <sup>(1)</sup>	±1000	

(1) AEC Q100-002 indicates that HBM stressing shall be in accordance with the ANSI/ESDA/JEDEC JS-001 specification.

### 6.4 ESD Ratings for LM2901x-Q1

			MIN	MAX	UNIT
V <sub>(ESD)</sub>	Electrostatic discharge	Human-body model (HBM), per AEC Q100-002 <sup>(1)</sup> , (LM2901-Q1, LM2901V-Q1)	-2000	2000	V
		Human-body model (HBM), per AEC Q100-002 <sup>(1)</sup> , (LM2901AV-Q1 Only)	-1000	1000	
		Charged-device model (CDM), per AEC Q100-011	-1000	1000	

(1) AEC Q100-002 indicates that HBM stressing shall be in accordance with the ANSI/ESDA/JEDEC JS-001 specification.

### 6.5 Recommended Operating Conditions for LM2901B-Q1

over operating free-air temperature range (unless otherwise noted)

		MIN	MAX	UNIT
Supply voltage: V <sub>S</sub> = (V+) – (V–)		2	36	V
Ambient temperature, T <sub>A</sub> , LM2901B-Q1		–40	125	°C
Input Voltage Range, V <sub>IVR</sub>		(V–) – 0.1	(V+) – 2.0	V

### 6.6 Recommended Operating Conditions for LM2901x-Q1

over operating free-air temperature range (unless otherwise noted)

			MIN	MAX	UNIT
V <sub>CC</sub>	Supply voltage	LM2901-Q1	2	30	V
		LM2901V-Q1, LM2901AV-Q1	2	32	
T <sub>A</sub>	Ambient temperature		–40	125	°C
I <sub>O</sub>	Output current (per comparator)		0	4	mA

## 6.7 Thermal Information for LM2901B-Q1

THERMAL METRIC <sup>(1)</sup>		LM2901B-Q1					UNIT
		D (SOIC)	PW (TSSOP)	DDY (SOT-23)	RTE (QFN)	RUC (X2QFN)	
		14 PINS	14 PINS	14 PINS	16 PINS	14 PINS	
R <sub>θJA</sub>	Junction-to-ambient thermal resistance	111.2	136.6				°C/W
R <sub>θJC(top)</sub>	Junction-to-case (top) thermal resistance	66.9	66.6				
R <sub>θJB</sub>	Junction-to-board thermal resistance	67.8	79.8				
ψ <sub>JT</sub>	Junction-to-top characterization parameter	28.0	17.8				
ψ <sub>JB</sub>	Junction-to-board characterization parameter	67.4	79.3				
R <sub>θJC(bot)</sub>	Junction-to-case (bottom) thermal resistance	-	-	-		-	

- (1) For more information about traditional and new thermal metrics, see the Semiconductor and IC Package Thermal Metrics report, [SPRA953](#).

## 6.8 Thermal Information for LM2901x-Q1

THERMAL METRIC <sup>(1)</sup>		LM2901x-Q1		UNIT
		D (SOIC)	PW (TSSOP)	
		14 PINS	14 PINS	
R <sub>θJA</sub>	Junction-to-ambient thermal resistance <sup>(2)</sup>	88.6	119.1	°C/W
R <sub>θJC(top)</sub>	Junction-to-case (top) thermal resistance	49.1	47.9	°C/W
R <sub>θJB</sub>	Junction-to-board thermal resistance	43.0	60.9	°C/W
ψ <sub>JT</sub>	Junction-to-top characterization parameter	13.6	5.4	°C/W
ψ <sub>JB</sub>	Junction-to-board characterization parameter	42.7	60.3	°C/W

- (1) For more information about traditional and new thermal metrics, see the *Semiconductor and IC Package Thermal Metrics* application report, [SPRA953](#).
- (2) Maximum power dissipation is a function of T<sub>J(max)</sub>, R<sub>θJA</sub>, and T<sub>A</sub>. The maximum allowable power dissipation at any allowable ambient temperature is P<sub>D</sub> = (T<sub>J(max)</sub> - T<sub>A</sub>) / R<sub>θJA</sub>. Operating at the absolute maximum T<sub>J</sub> of 150°C can affect reliability.

## 6.9 Electrical Characteristics for LM2901B-Q1

$V_S = 5\text{ V}$ ,  $V_{CM} = (V-)$ ;  $T_A = 25^\circ\text{C}$  (unless otherwise noted).

PARAMETER		TEST CONDITIONS	MIN	TYP	MAX	UNIT
$V_{IO}$	Input offset voltage	$V_S = 5\text{ to }36\text{V}$	-3.5	$\pm 0.37$	3.5	mV
		$V_S = 5\text{ to }36\text{V}$ , $T_A = -40^\circ\text{C to }+125^\circ\text{C}$	-5.5		5.5	
$I_B$	Input bias current			-3.5	-25	nA
		$T_A = -40^\circ\text{C to }+125^\circ\text{C}$			-50	nA
$I_{OS}$	Input offset current		-25	$\pm 0.5$	25	nA
		$T_A = -40^\circ\text{C to }+125^\circ\text{C}$	-50		50	nA
$V_{CM}$	Common mode range <sup>(1)</sup>	$V_S = 3\text{ to }36\text{V}$	(V-)		(V+) - 1.5	V
		$V_S = 3\text{ to }36\text{V}$ , $T_A = -40^\circ\text{C to }+125^\circ\text{C}$	(V-)		(V+) - 2.0	V
$A_{VD}$	Large signal differential voltage amplification <sup>(2)</sup>	$V_S = 15\text{V}$ , $V_O = 1.4\text{V to }11.4\text{V}$ ; $R_L \geq 15\text{k to }(\text{V}+)$	50	200		V/mV
$V_{OL}$	Low level output Voltage {swing from (V-)}	$I_{SINK} \leq 4\text{mA}$ , $V_{ID} = -1\text{V}$		110	400	mV
		$I_{SINK} \leq 4\text{mA}$ , $V_{ID} = -1\text{V}$ $T_A = -40^\circ\text{C to }+125^\circ\text{C}$			550	mV
$I_{OH-LKG}$	High-level output leakage current	$(\text{V}+) = V_O = 5\text{ V}$ ; $V_{ID} = 1\text{ V}$		0.1	50	nA
		$(\text{V}+) = V_O = 36\text{V}$ ; $V_{ID} = 1\text{ V}$			100	nA
$I_{OL}$	Low level output current	$V_{OL} = 1.5\text{V}$ ; $V_{ID} = -1\text{V}$ ; $V_S = 5\text{V}$	6	21		mA
$I_Q$	Quiescent current (all comparators)	$V_S = 5\text{ V}$ , no load		0.8	1.2	mA
		$V_S = 36\text{ V}$ , no load, $T_A = -40^\circ\text{C to }+125^\circ\text{C}$		1	1.6	mA

- (1) The voltage at either input should not be allowed to go negative by more than 0.3 V otherwise output may be incorrect and excessive input current can flow. The upper end of the common-mode voltage range is limited by  $V_{CC} - 2\text{V}$ . However only one input needs to be in the valid common mode range, the other input can go up the maximum  $V_{CC}$  level and the comparator provides a proper output state. Either or both inputs can go to maximum  $V_{CC}$  level without damage.
- (2) This parameter is ensured by design and/or characterization and is not tested in production.

## 6.10 Switching Characteristics for LM2901B-Q1

$V_S = 5\text{V}$ ,  $V_O\text{ PULLUP} = 5\text{V}$ ,  $V_{CM} = V_S/2$ ,  $C_L = 15\text{pF}$ ,  $R_L = 5.1\text{k Ohm}$ ,  $T_A = 25^\circ\text{C}$  (unless otherwise noted).

PARAMETER		TEST CONDITIONS	MIN	TYP	MAX	UNIT
$t_{\text{response}}$	Propagation delay time, high-to-low; Small scale input signal <sup>(1)</sup>	Input overdrive = 5mV, Input step = 100mV		1000		ns
$t_{\text{response}}$	Propagation delay time, high-to-low; TTL input signal <sup>(1)</sup>	TTL input with $V_{\text{ref}} = 1.4\text{V}$		300		ns

- (1) High-to-low and low-to-high refers to the transition at the input.



## 6.11 Electrical Characteristics for LM2901x-Q1

$V_{CC} = 5\text{ V}$ , at specified free-air temperature (unless otherwise noted)

PARAMETER	TEST CONDITIONS <sup>(1)</sup>		$T_A$ <sup>(2)</sup>	MIN	TYP	MAX	UNIT
$V_{IO}$ Input offset voltage	$V_{IC} = V_{ICR(min)}$ , $V_O = 1.4\text{ V}$ , $V_{CC} = 5\text{ V}$ to MAX <sup>(3)</sup>	Non A devices	25°C		2	7	mV
			Full range			15	
		A suffix devices	25°C		1	2	
			Full range			4	
$I_{IO}$ Input offset current	$V_O = 1.4\text{ V}$		25°C		5	50	nA
			Full range			200	
$I_{IB}$ Input bias current	$V_O = 1.4\text{ V}$		25°C		-25	-250	nA
			Full range			-500	
$V_{ICR}$ Common-mode input-voltage range <sup>(4)</sup>			25°C	0	$V_{CC} - 1.5$		V
			Full range	0	$V_{CC} - 2$		
$A_{VD}$ Large-signal differential-voltage amplification	$V_{CC} = 15\text{ V}$ , $V_O = 1.4\text{ V}$ to 11.4 V, $R_L \geq 15\text{ k}\Omega$ to $V_{CC}$		25°C	25	100		V/mV
$I_{OH}$ High-level output current	$V_{ID} = 1\text{ V}$	$V_{OH} = 5\text{ V}$	25°C		0.1	50	nA
		$V_{OH} = V_{CC}\text{ MAX}^{(3)}$	Full range			1	$\mu\text{A}$
$V_{OL}$ Low-level output voltage	$V_{ID} = -1\text{ V}$	$I_{OL} = 4\text{ mA}$	25°C		150	400	mV
			Full range			700	
$I_{OL}$ Low-level output current	$V_{ID} = -1\text{ V}$	$V_{OL} = 1.5\text{ V}$	25°C	6	16		mA
$I_{CC}$ Supply current (four comparators)	$V_O = 2.5\text{ V}$ , No load	$V_{CC} = 5\text{ V}$	25°C		0.8	2	
		$V_{CC} = \text{MAX}^{(3)}$			1	2.5	

(1) All characteristics are measured with zero common-mode input voltage, unless otherwise specified.

(2) Full range (MIN to MAX) is  $-40^\circ\text{C}$  to  $125^\circ\text{C}$ . All characteristics are measured with zero common-mode input voltage, unless otherwise specified.

(3)  $V_{CC}\text{ MAX} = 30\text{ V}$  for non-V devices and  $32\text{ V}$  for V-suffix devices.

(4) The voltage at either the input or common mode should not be allowed to negative by more than  $0.3\text{ V}$ . The upper end of the common-mode voltage range is  $V_{CC+} - 1.5\text{ V}$ ; however, one input can exceed  $V_{CC}$ , and the comparator will provide a proper output state as long as the other input remains in the common-mode range. Either or both inputs can go to  $30\text{ V}$  without damage.

## 6.12 Switching Characteristics for LM2901x-Q1

$V_{CC} = 5\text{ V}$ ,  $T_A = 25^\circ\text{C}$

PARAMETER	TEST CONDITIONS		MIN	TYP	MAX	UNIT
Response time <sup>(2)</sup>	$R_L$ connected to $5\text{ V}$ through $5.1\text{ k}\Omega$ , $C_L = 15\text{ pF}^{(1)}$	100-mV input step with 5-mV overdrive		1.3		$\mu\text{s}$
		TTL-level input step		0.3		

(1)  $C_L$  includes probe and jig capacitance.

(2) The response time specified is the interval between the input step function and the instant when the output crosses  $1.4\text{ V}$ .

### 6.13 Typical Characteristics: LM2901B-Q1

$T_A = 25^\circ\text{C}$ ,  $V_S = 5\text{ V}$ ,  $R_{\text{PULLUP}} = 5.1\text{ k}$ ,  $C_L = 15\text{ pF}$ ,  $V_{\text{CM}} = 0\text{ V}$ ,  $V_{\text{UNDERDRIVE}} = 100\text{ mV}$ ,  $V_{\text{OVERDRIVE}} = 100\text{ mV}$  unless otherwise noted.

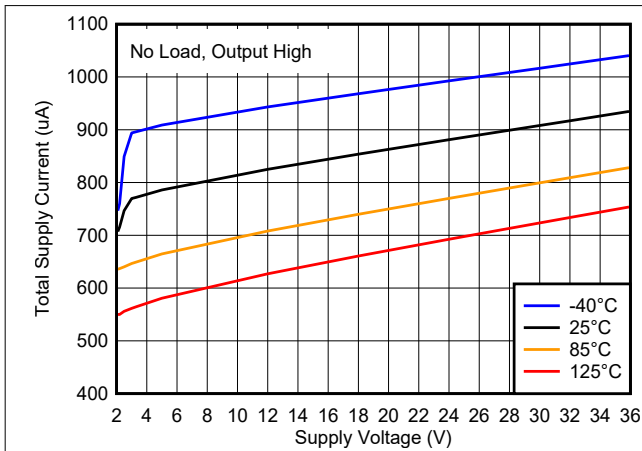


Figure 6-1. Total Supply Current vs. Supply Voltage

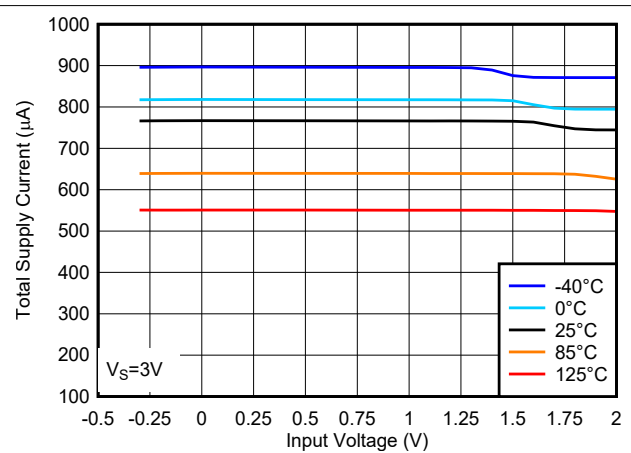


Figure 6-2. Total Supply Current vs. Input Voltage at 3V

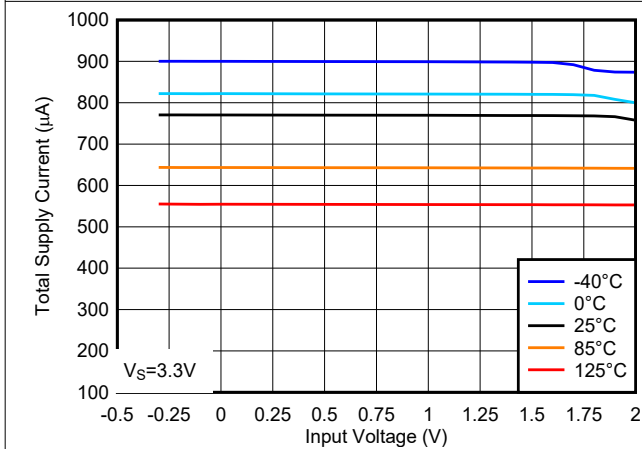


Figure 6-3. Total Supply Current vs. Input Voltage at 3.3V

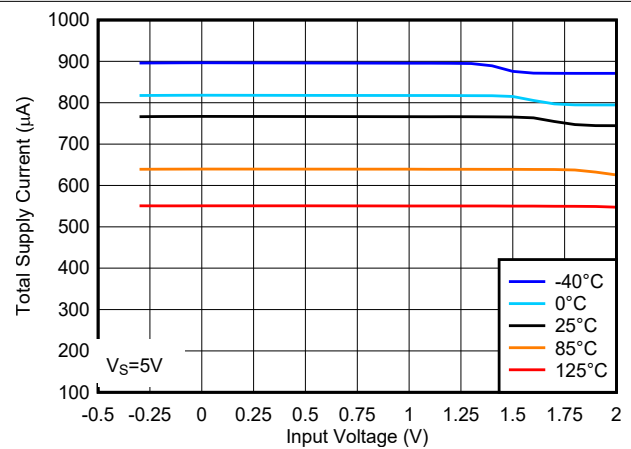


Figure 6-4. Total Supply Current vs. Input Voltage at 5V

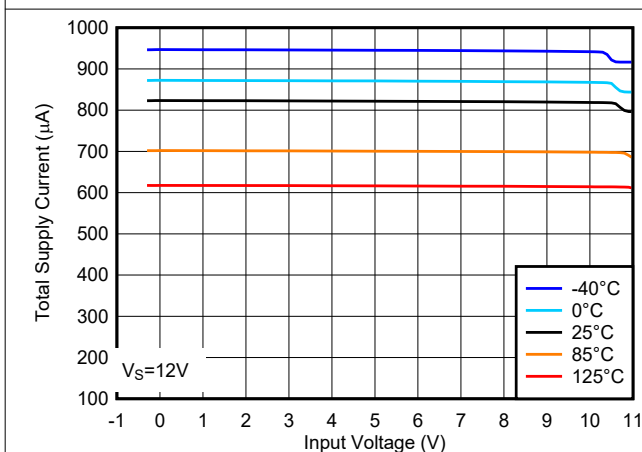


Figure 6-5. Total Supply Current vs. Input Voltage at 12V

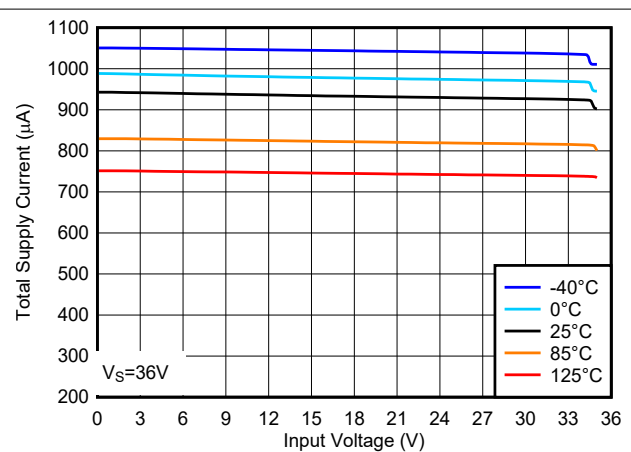
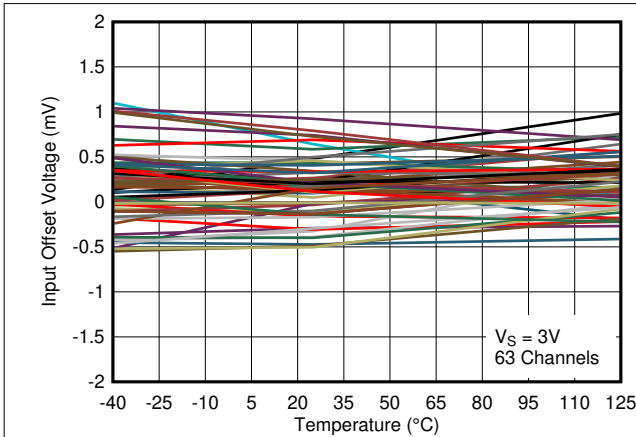


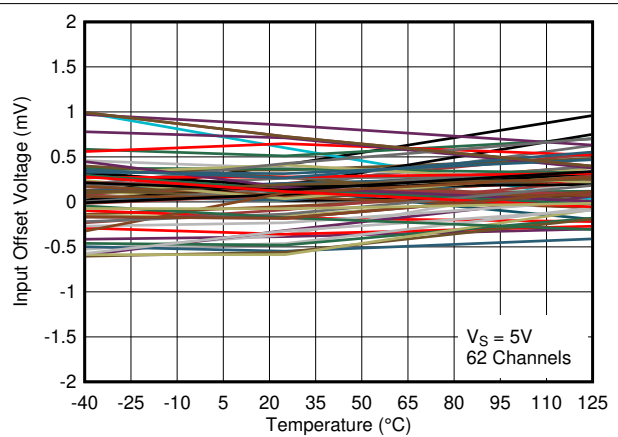
Figure 6-6. Total Supply Current vs. Input Voltage at 36V

### 6.13 Typical Characteristics: LM2901B-Q1 (continued)

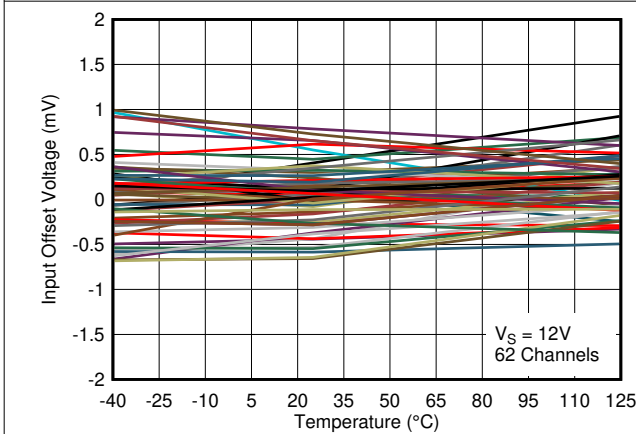
$T_A = 25^\circ\text{C}$ ,  $V_S = 5\text{ V}$ ,  $R_{\text{PULLUP}} = 5.1\text{ k}$ ,  $C_L = 15\text{ pF}$ ,  $V_{\text{CM}} = 0\text{ V}$ ,  $V_{\text{UNDERDRIVE}} = 100\text{ mV}$ ,  $V_{\text{OVERDRIVE}} = 100\text{ mV}$  unless otherwise noted.



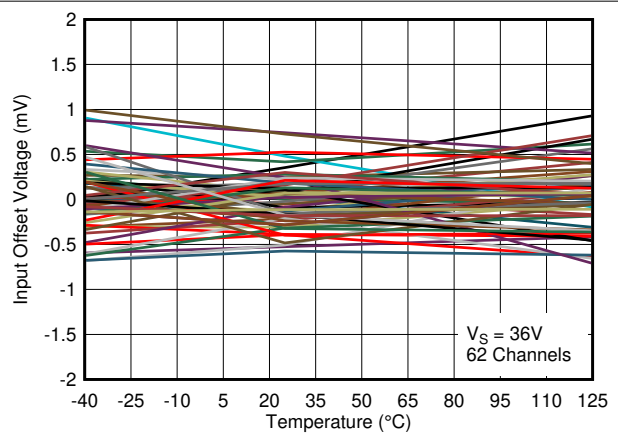
**Figure 6-7. Input Offset Voltage vs. Temperature at 3V**



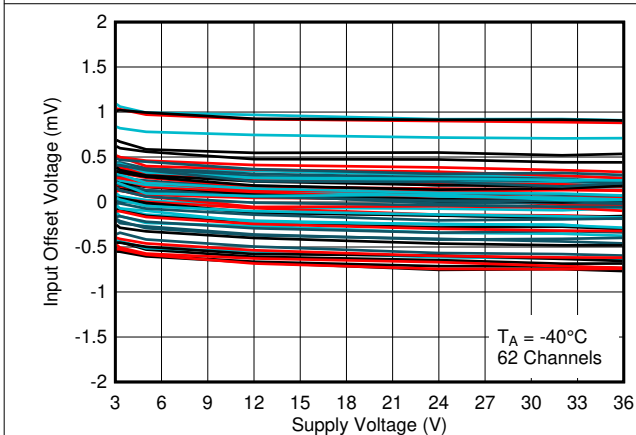
**Figure 6-8. Input Offset Voltage vs. Temperature at 5V**



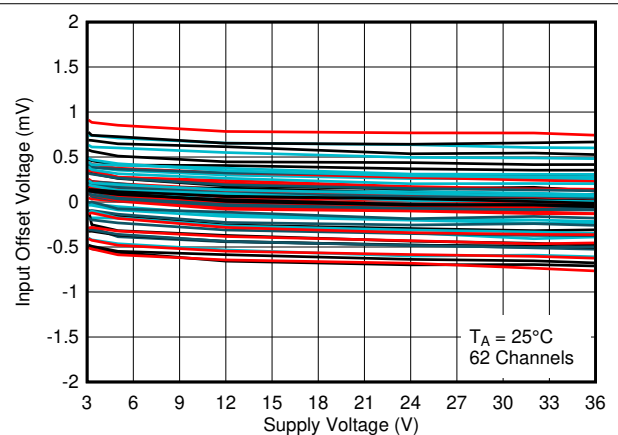
**Figure 6-9. Input Offset Voltage vs. Temperature at 12V**



**Figure 6-10. Input Offset Voltage vs. Temperature at 36V**



**Figure 6-11. Input Offset Voltage vs. Supply Voltage at  $-40^\circ\text{C}$**



**Figure 6-12. Input Offset Voltage vs. Supply Voltage at  $25^\circ\text{C}$**

### 6.13 Typical Characteristics: LM2901B-Q1 (continued)

$T_A = 25^\circ\text{C}$ ,  $V_S = 5\text{ V}$ ,  $R_{\text{PULLUP}} = 5.1\text{ k}$ ,  $C_L = 15\text{ pF}$ ,  $V_{\text{CM}} = 0\text{ V}$ ,  $V_{\text{UNDERDRIVE}} = 100\text{ mV}$ ,  $V_{\text{OVERDRIVE}} = 100\text{ mV}$  unless otherwise noted.

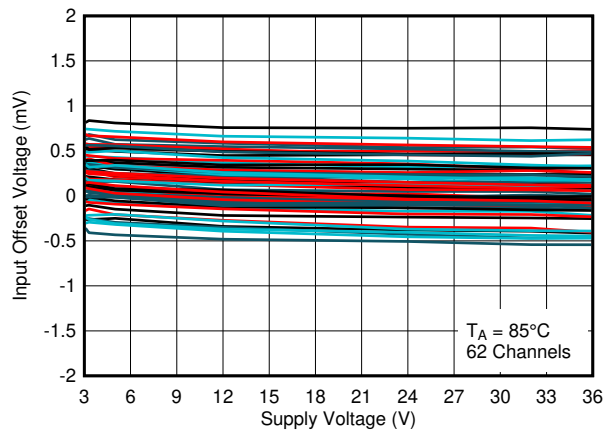


Figure 6-13. Input Offset Voltage vs. Supply Voltage at 85°C

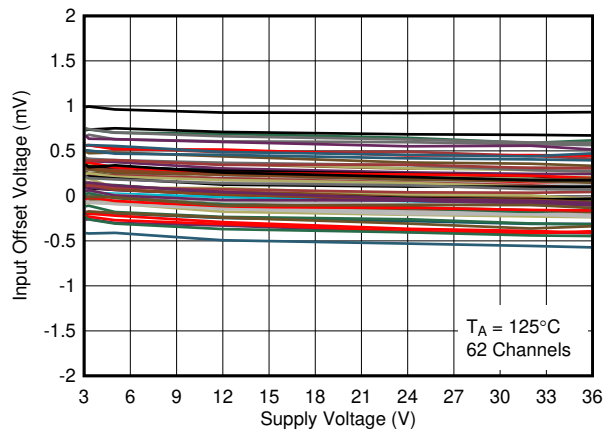


Figure 6-14. Input Offset Voltage vs. Supply Voltage at 125°C

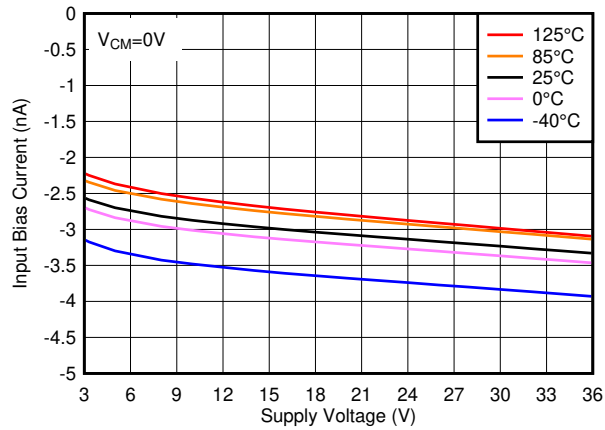


Figure 6-15. Input Bias Current vs. Supply Voltage

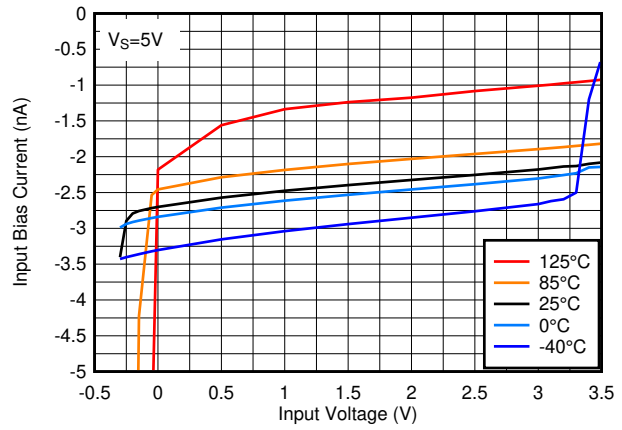


Figure 6-16. Input Bias Current vs. Input Voltage at 5V

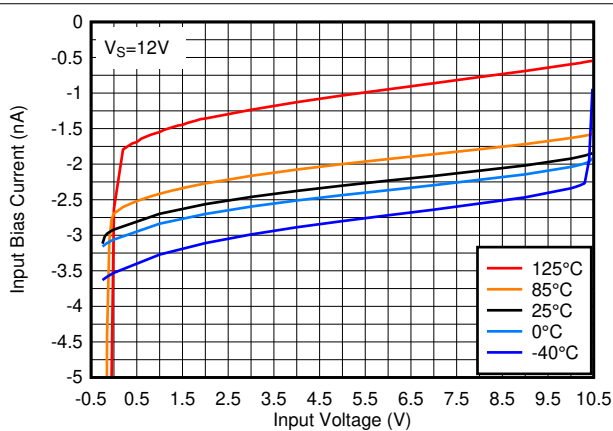


Figure 6-17. Input Bias Current vs. Input Voltage at 12V

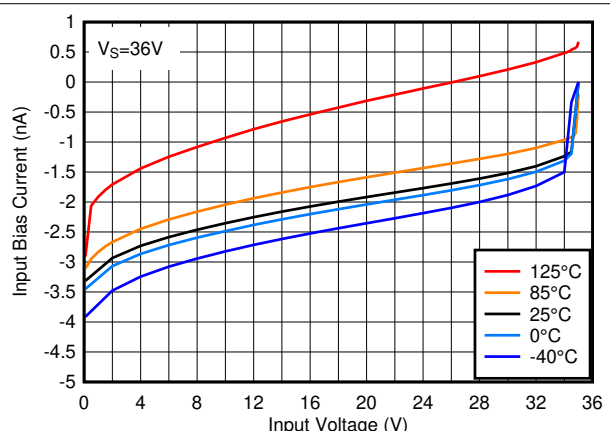
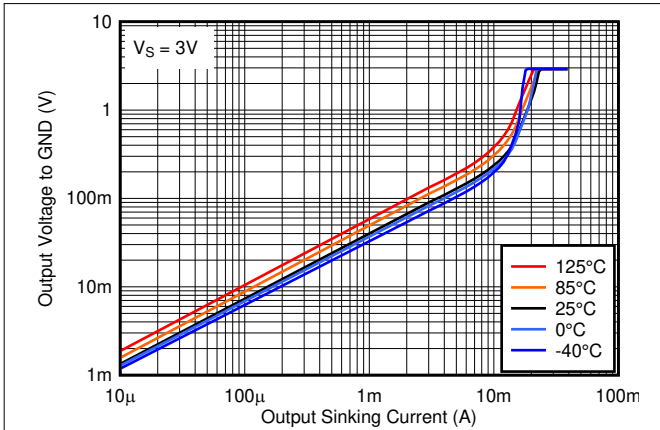


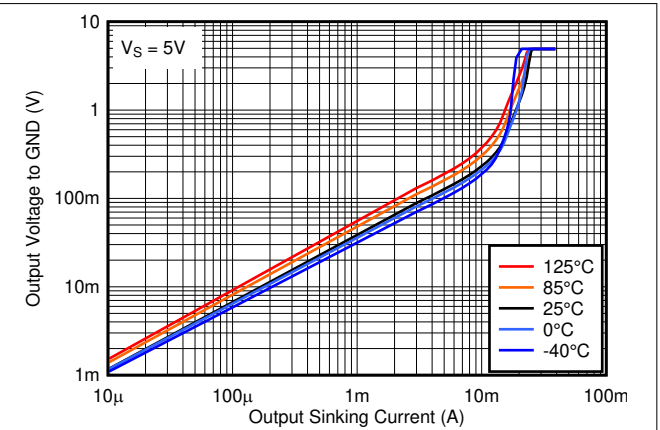
Figure 6-18. Input Bias Current vs. Input Voltage at 36V

### 6.13 Typical Characteristics: LM2901B-Q1 (continued)

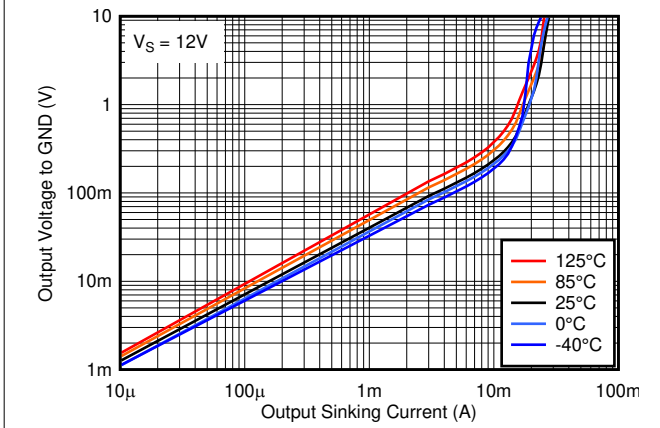
$T_A = 25^\circ\text{C}$ ,  $V_S = 5\text{ V}$ ,  $R_{\text{PULLUP}} = 5.1\text{k}$ ,  $C_L = 15\text{ pF}$ ,  $V_{\text{CM}} = 0\text{ V}$ ,  $V_{\text{UNDERDRIVE}} = 100\text{ mV}$ ,  $V_{\text{OVERDRIVE}} = 100\text{ mV}$  unless otherwise noted.



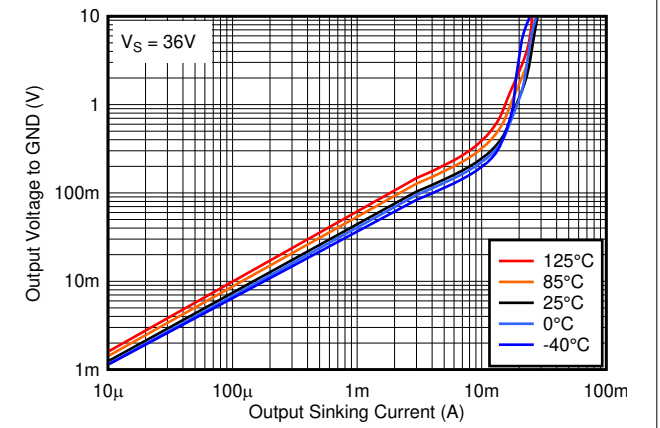
**Figure 6-19. Output Low Voltage vs. Output Sinking Current at 3V**



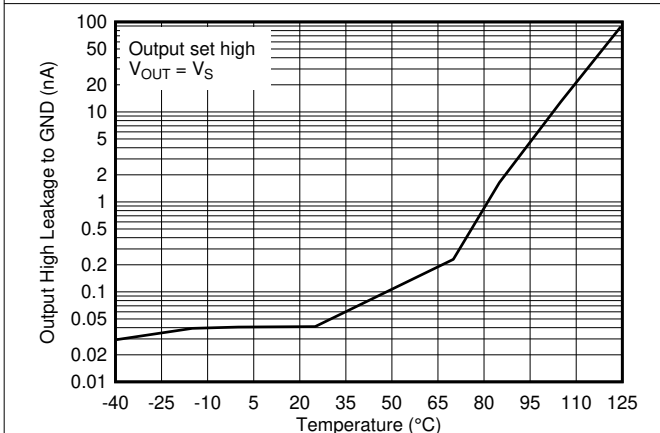
**Figure 6-20. Output Low Voltage vs. Output Sinking Current at 5V**



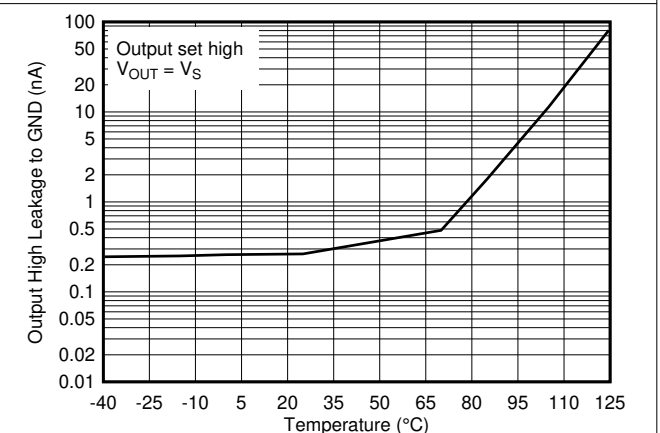
**Figure 6-21. Output Low Voltage vs. Output Sinking Current at 12V**



**Figure 6-22. Output Low Voltage vs. Output Sinking Current at 36V**



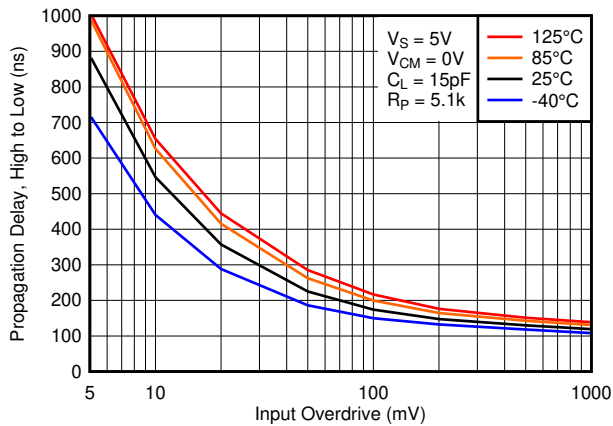
**Figure 6-23. Output High Leakage Current vs. Temperature at 5V**



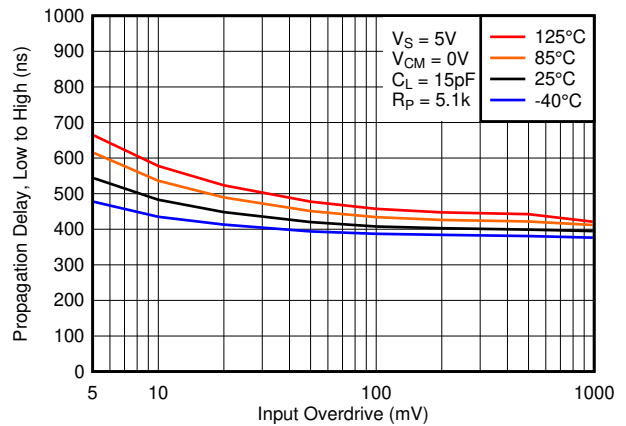
**Figure 6-24. Output High Leakage Current vs. Temperature at 36V**

### 6.13 Typical Characteristics: LM2901B-Q1 (continued)

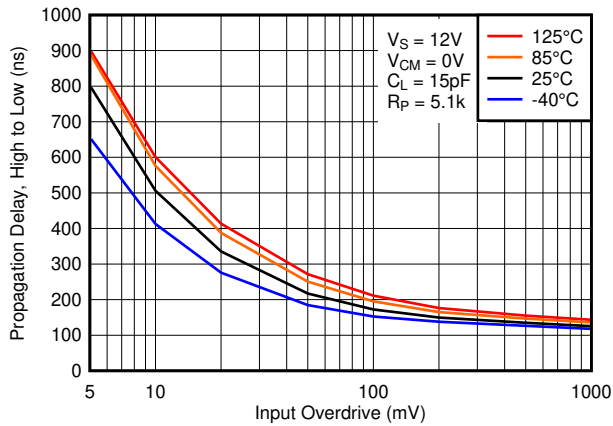
$T_A = 25^\circ\text{C}$ ,  $V_S = 5\text{ V}$ ,  $R_{\text{PULLUP}} = 5.1\text{ k}$ ,  $C_L = 15\text{ pF}$ ,  $V_{\text{CM}} = 0\text{ V}$ ,  $V_{\text{UNDERDRIVE}} = 100\text{ mV}$ ,  $V_{\text{OVERDRIVE}} = 100\text{ mV}$  unless otherwise noted.



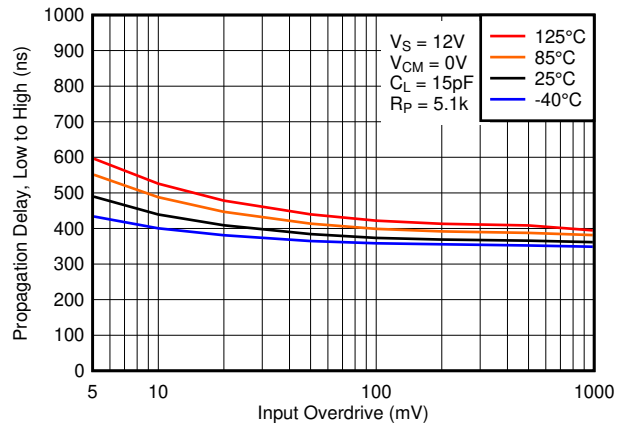
**Figure 6-25. High to Low Propagation Delay vs. Input Overdrive Voltage, 5V**



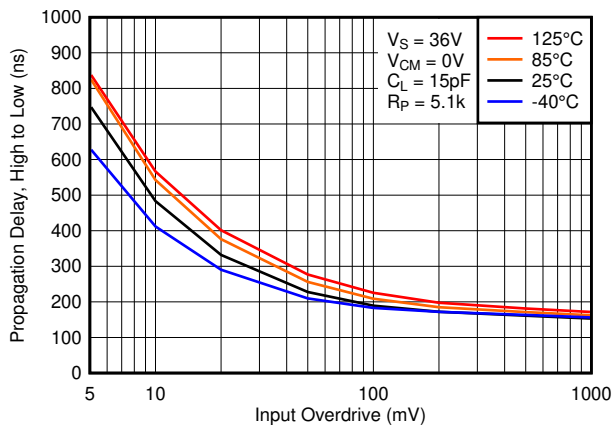
**Figure 6-26. Low to High Propagation Delay vs. Input Overdrive Voltage, 5V**



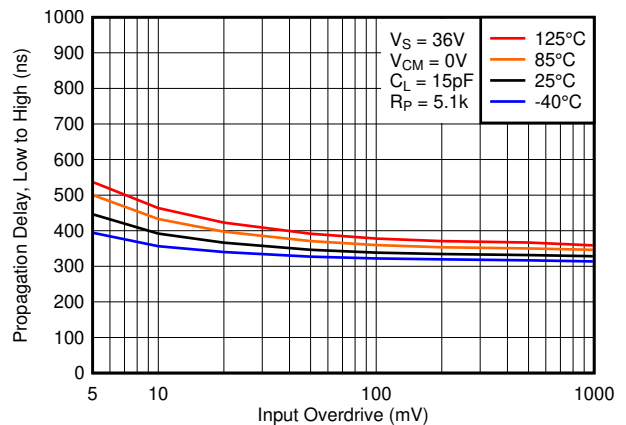
**Figure 6-27. High to Low Propagation Delay vs. Input Overdrive Voltage, 12V**



**Figure 6-28. Low to High Propagation Delay vs. Input Overdrive Voltage, 12V**



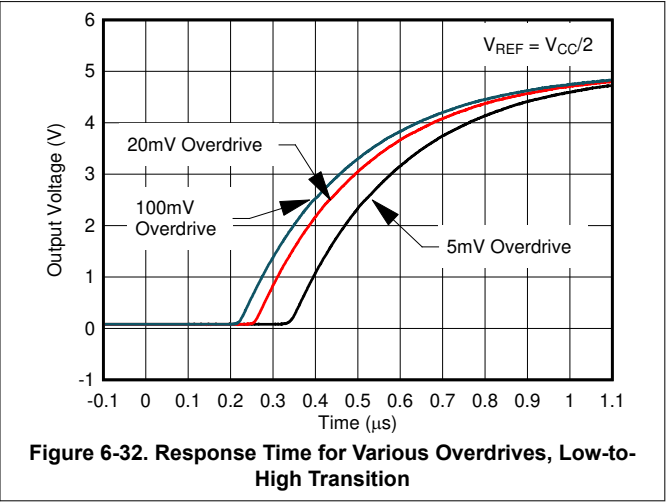
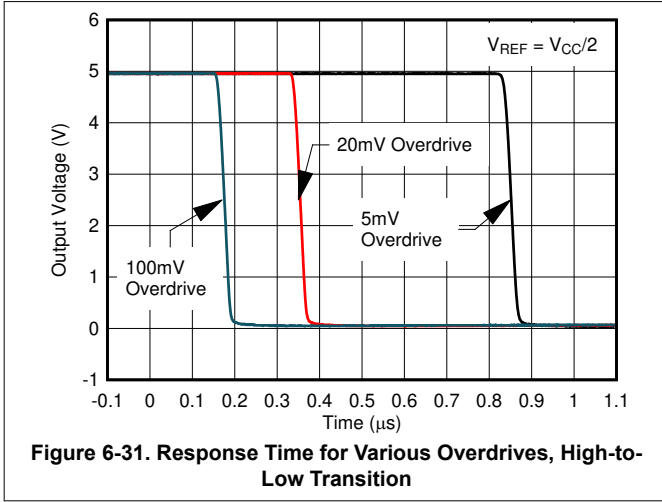
**Figure 6-29. High to Low Propagation Delay vs. Input Overdrive Voltage, 36V**



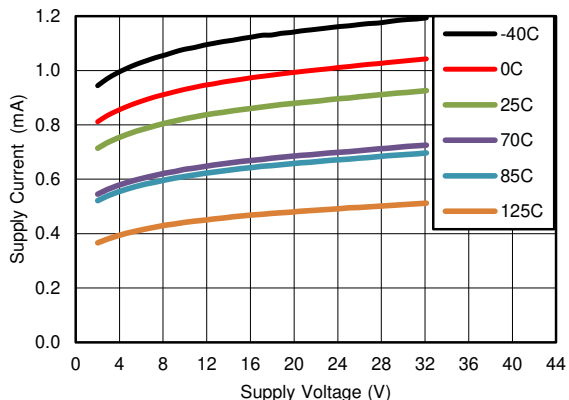
**Figure 6-30. Low to High Propagation Delay vs. Input Overdrive Voltage, 36V**

### 6.13 Typical Characteristics: LM2901B-Q1 (continued)

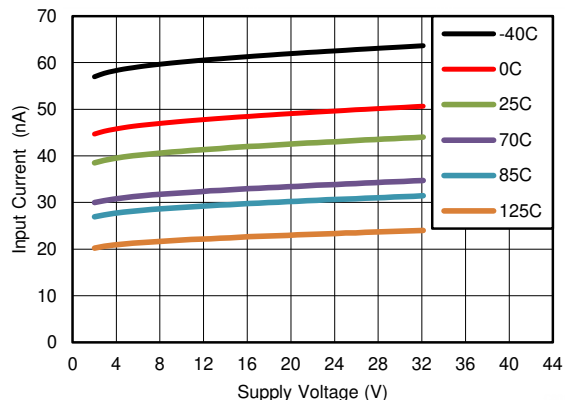
$T_A = 25^\circ\text{C}$ ,  $V_S = 5\text{ V}$ ,  $R_{\text{PULLUP}} = 5.1\text{ k}$ ,  $C_L = 15\text{ pF}$ ,  $V_{\text{CM}} = 0\text{ V}$ ,  $V_{\text{UNDERDRIVE}} = 100\text{ mV}$ ,  $V_{\text{OVERDRIVE}} = 100\text{ mV}$  unless otherwise noted.



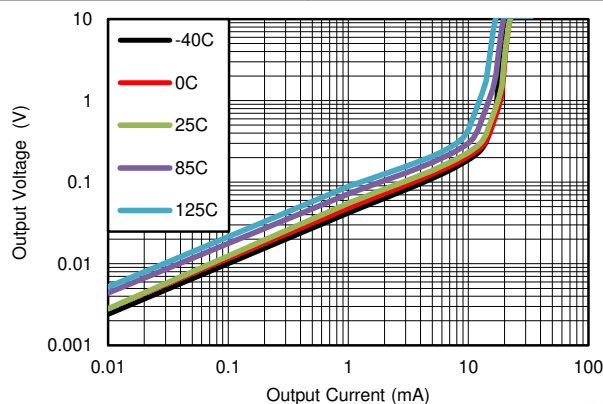
## 6.14 Typical Characteristics: LM2901x-Q1



**Figure 6-33. Supply Current vs Supply Voltage**



**Figure 6-34. Input Bias Current vs Supply Voltage**



**Figure 6-35. Output Saturation Voltage**



## 7 Detailed Description

### 7.1 Overview

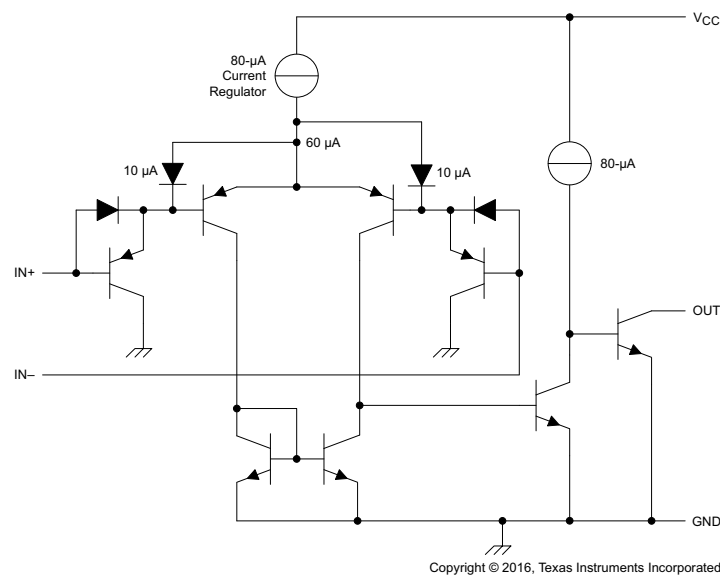
The LM2901-Q1 family is a quad comparator with the ability to operate up to 36 V on the supply pin. This standard device has proven ubiquity and versatility across a wide range of applications. This is due to its very wide supply voltages range (2 V to 36 V), low  $I_q$  and fast response.

This device is AEC-Q100 qualified and can operate over a wide temperature range of  $-40^{\circ}\text{C}$  to  $125^{\circ}\text{C}$ .

The open-drain output allows the user to configure the output's logic low voltage ( $V_{OL}$ ) and can be utilized to enable the comparator to be used in AND functionality.

The "B" versions add dedicated ESD protections on all the pins for improved ESD performance as well as improved negative input voltage handling. Please see Application Note [SNOAA35](#) for more information

### 7.2 Functional Block Diagram



### 7.3 Feature Description

LM2901-Q1 family consists of a PNP Darlington pair input, allowing the device to operate with very high gain and fast response with minimal input bias current. The input Darlington pair creates a limit on the input common mode voltage capability, allowing LM2901-Q1 to accurately function from ground to  $V_{CC}-1.5\text{V}$  differential input. This enables much head room for modern day supplies of 3.3 V and 5.0 V.

The output consists of an open drain NPN (pull-down or low side) transistor. The output NPN will sink current when the negative input voltage is higher than the positive input voltage and the offset voltage. The  $V_{OL}$  is resistive and will scale with the output current. Please see [Figure 6-19](#), [Figure 6-20](#) and [Figure 6-21](#) for  $V_{OL}$  values with respect to the output current.

The special pinout of this device separates input pins from the output pins to reduce parasitic coupling between input and output.

### 7.4 Device Functional Modes

#### 7.4.1 Voltage Comparison

The LM2901-Q1 family of devices operates solely as a voltage comparator, comparing the differential voltage between the positive and negative pins and outputs a logic low or high impedance (logic high with pullup) based on the input differential polarity.

## 8 Application and Implementation

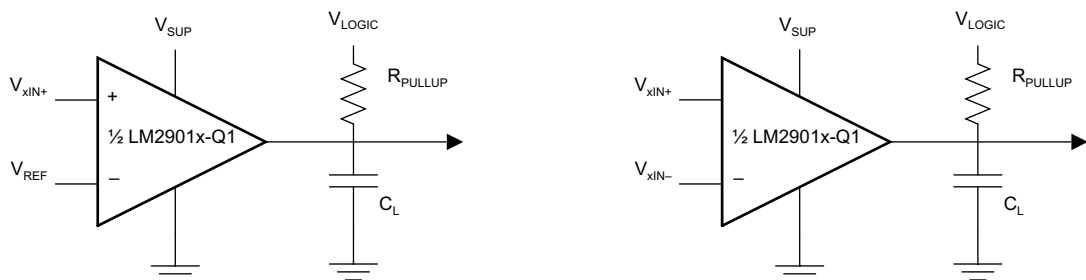
### Note

Information in the following applications sections is not part of the TI component specification, and TI does not warrant its accuracy or completeness. TI's customers are responsible for determining suitability of components for their purposes, as well as validating and testing their design implementation to confirm system functionality.

### 8.1 Application Information

LM2901-Q1 family will typically be used to compare a single signal to a reference or two signals against each other. Many users take advantage of the open drain output to drive the comparison logic output to a logic voltage level to an MCU or logic device. The wide supply range and high voltage capability makes LM2901-Q1 optimal for level shifting to a higher or lower voltage.

### 8.2 Typical Application



Copyright © 2016, Texas Instruments Incorporated

**Figure 8-1. Single-Ended and Differential Comparator Configurations**

#### 8.2.1 Design Requirements

For this design example, use the parameters listed in [Table 8-1](#) as the input parameters.

**Table 8-1. Design Parameters**

PARAMETER	EXAMPLE VALUE
Input voltage range	0 V to $V_{SUP} - 1.5$ V
Supply voltage	2 V to 36 V
Logic supply voltage	2 V to 36 V
Output current ( $R_{PULLUP}$ )	1 $\mu$ A to 20 mA
Input overdrive voltage	100 mV
Reference voltage	2.5 V
Load capacitance ( $C_L$ )	15 pF

#### 8.2.2 Detailed Design Procedure

##### 8.2.2.1 Input Voltage Range

When choosing the input voltage range, the input common mode voltage range ( $V_{ICR}$ ) must be taken in to account. If temperature operation is above or below 25°C the  $V_{ICR}$  can range from 0 V to  $V_{CC-} - 2.0$  V. This limits the input voltage range to as high as  $V_{CC-} - 2.0$  V and as low as 0 V. Operation outside of this range can yield incorrect comparisons.

Below is a list of input voltage situation and their outcomes:

1. When both IN- and IN+ are both within the common mode range:
  - a. If IN- is higher than IN+ and the offset voltage, the output is low and the output transistor is sinking current

- b. If IN- is lower than IN+ and the offset voltage, the output is high impedance and the output transistor is not conducting
- 2. When IN- is higher than common mode and IN+ is within common mode, the output is low and the output transistor is sinking current
- 3. When IN+ is higher than common mode and IN- is within common mode, the output is high impedance and the output transistor is not conducting
- 4. When IN- and IN+ are both higher than common mode, the output is low and the output transistor is sinking current. The "B" version output will go high.

**8.2.2.2 Minimum Overdrive Voltage**

The overdrive voltage is the differential voltage produced between the positive and negative inputs of the comparator over the offset voltage ( $V_{IO}$ ). To make an accurate comparison the overdrive voltage ( $V_{OD}$ ) must be higher than the input offset voltage ( $V_{IO}$ ). The overdrive voltage can also determine the response time of the comparator, with the response time decreasing as the overdrive increases. Figure 8-2 and Figure 8-3 show positive and negative response times with respect to overdrive voltage.

**8.2.2.3 Output and Drive Current**

Output current is determined by the load/pull-up resistance and logic/pull-up voltage. The output current will produce an output low voltage ( $V_{OL}$ ) which is proportional to the output current. Use Figure 6-19, Figure 6-20, and Figure 6-21 to determine  $V_{OL}$  based on the output current.

The output current can also effect the transient response. More will be explained in the next section.

**8.2.2.4 Response Time**

The transient response can be determined by the load capacitance ( $C_L$ ), load or pullup resistance ( $R_{PULLUP}$ ), and equivalent collector-emitter resistance ( $R_{CE}$ ).

Use Equation 1 and Equation 2 to calculate the approximate values of the rise time ( $t_r$ ) and fall time ( $t_f$ ).

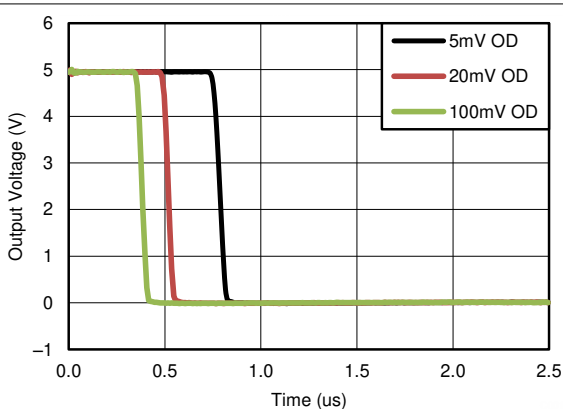
$$t_P \approx R_{PULLUP} \times C_L \tag{1}$$

$$t_N \approx R_{CE} \times C_L \tag{2}$$

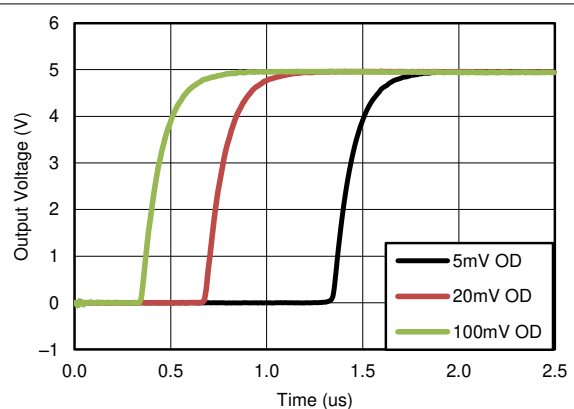
To find the value of  $R_{CE}$ , use the slope of Figure 6-35 in the linear region at the desired temperature, or divide  $V_{OL}$  by  $I_O$ .

**8.2.3 Application Curves**

The following curves were generated with 5 V on  $V_{CC}$  and  $V_{LOGIC}$ ,  $R_{PULLUP} = 5.1 \text{ k}\Omega$ , and 50-pF scope probe.



**Figure 8-2. Response Time for Various Overdrives Negative Transition**



**Figure 8-3. Response Time for Various Overdrives Positive Transition**

## 9 Power Supply Recommendations

For fast response and comparison applications with noisy or AC inputs, TI recommends using a bypass capacitor on the supply pin to reject any variation on the supply voltage. This variation can take away from some of the input common mode range of the comparator and create an inaccurate comparison.

## 10 Layout

### 10.1 Layout Guidelines

For accurate comparator applications without hysteresis it is important maintain a stable power supply with minimized noise and glitches, which can affect the high level input common mode voltage range. In order to achieve this, it is best to add a bypass capacitor between the supply voltage and ground. This should be implemented on the positive power supply and negative supply (if available).

### 10.2 Layout Example

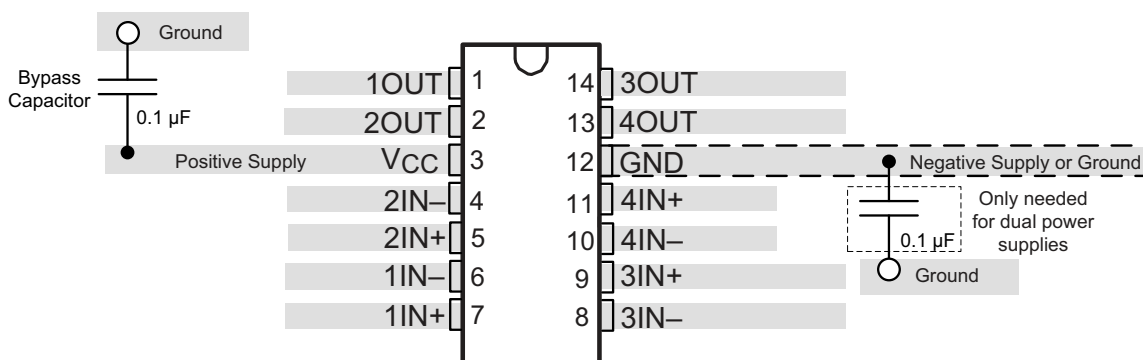


Figure 10-1. LM2901x-Q1 Layout Example

## 11 Device and Documentation Support

### 11.1 Documentation Support

#### 11.1.1 Related Documentation

For related documentation, see the following:

TL331-Q1 *Single Differential Comparator*, [SLVS969](#)

#### 11.2 Related Links

The table below lists quick access links. Categories include technical documents, support and community resources, tools and software, and quick access to sample or buy.

**Table 11-1. Related Links**

PARTS	PRODUCT FOLDER	SAMPLE & BUY	TECHNICAL DOCUMENTS	TOOLS & SOFTWARE	SUPPORT & COMMUNITY
LM2901-Q1	<a href="#">Click here</a>	<a href="#">Click here</a>	<a href="#">Click here</a>	<a href="#">Click here</a>	<a href="#">Click here</a>
LM2901V-Q1	<a href="#">Click here</a>	<a href="#">Click here</a>	<a href="#">Click here</a>	<a href="#">Click here</a>	<a href="#">Click here</a>
LM2901AV-Q1	<a href="#">Click here</a>	<a href="#">Click here</a>	<a href="#">Click here</a>	<a href="#">Click here</a>	<a href="#">Click here</a>
LM2901B-Q1	<a href="#">Click here</a>	<a href="#">Click here</a>	<a href="#">Click here</a>	<a href="#">Click here</a>	<a href="#">Click here</a>

#### 11.3 Trademarks

All trademarks are the property of their respective owners.

#### 11.4 Electrostatic Discharge Caution



This integrated circuit can be damaged by ESD. Texas Instruments recommends that all integrated circuits be handled with appropriate precautions. Failure to observe proper handling and installation procedures can cause damage.

ESD damage can range from subtle performance degradation to complete device failure. Precision integrated circuits may be more susceptible to damage because very small parametric changes could cause the device not to meet its published specifications.

#### 11.5 Glossary

[TI Glossary](#) This glossary lists and explains terms, acronyms, and definitions.

## 12 Mechanical, Packaging, and Orderable Information

The following pages include mechanical, packaging, and orderable information. This information is the most current data available for the designated devices. This data is subject to change without notice and revision of this document. For browser-based versions of this data sheet, refer to the left-hand navigation.

**PACKAGING INFORMATION**

Orderable Device	Status (1)	Package Type	Package Drawing	Pins	Package Qty	Eco Plan (2)	Lead finish/ Ball material (6)	MSL Peak Temp (3)	Op Temp (°C)	Device Marking (4/5)	Samples
LM2901AVQDRG4Q1	OBSOLETE	SOIC	D	14		TBD	Call TI	Call TI	-40 to 125	2901AVQ	
LM2901AVQDRQ1	ACTIVE	SOIC	D	14	2500	RoHS & Green	NIPDAU	Level-1-260C-UNLIM	-40 to 125	2901AVQ	<a href="#">Samples</a>
LM2901AVQPWRG4Q1	ACTIVE	TSSOP	PW	14	2000	RoHS & Green	NIPDAU	Level-1-260C-UNLIM	-40 to 125	2901AVQ	<a href="#">Samples</a>
LM2901AVQPWRQ1	ACTIVE	TSSOP	PW	14	2000	RoHS & Green	NIPDAU	Level-1-260C-UNLIM	-40 to 125	2901AVQ	<a href="#">Samples</a>
LM2901BQDRQ1	ACTIVE	SOIC	D	14	3000	RoHS & Green	NIPDAU	Level-1-260C-UNLIM	-40 to 125	LM2901BQ	<a href="#">Samples</a>
LM2901BQPWRQ1	ACTIVE	TSSOP	PW	14	3000	RoHS & Green	NIPDAU	Level-1-260C-UNLIM	-40 to 125	2901BQ	<a href="#">Samples</a>
LM2901BWRTERQ1	ACTIVE	WQFN	RTE	16	5000	RoHS & Green	NIPDAU	Level-1-260C-UNLIM	-40 to 125	2901BQ	<a href="#">Samples</a>
LM2901QDRG4Q1	LIFEBUY	SOIC	D	14	2500	RoHS & Green	NIPDAU	Level-1-260C-UNLIM	-40 to 125	2901Q1	
LM2901QDRQ1	ACTIVE	SOIC	D	14	2500	RoHS & Green	NIPDAU	Level-1-260C-UNLIM	-40 to 125	2901Q1	<a href="#">Samples</a>
LM2901QPWRG4Q1	ACTIVE	TSSOP	PW	14	2000	RoHS & Green	NIPDAU	Level-1-260C-UNLIM	-40 to 125	2901Q1	<a href="#">Samples</a>
LM2901QPWRQ1	ACTIVE	TSSOP	PW	14	2000	RoHS & Green	NIPDAU	Level-1-260C-UNLIM	-40 to 125	2901Q1	<a href="#">Samples</a>
LM2901VQDRG4Q1	OBSOLETE	SOIC	D	14		TBD	Call TI	Call TI	-40 to 125	2901VQ1	
LM2901VQDRQ1	ACTIVE	SOIC	D	14	2500	RoHS & Green	NIPDAU	Level-1-260C-UNLIM	-40 to 125	2901VQ1	<a href="#">Samples</a>
LM2901VQPWRG4Q1	ACTIVE	TSSOP	PW	14	2000	RoHS & Green	NIPDAU	Level-1-260C-UNLIM	-40 to 125	2901VQ	<a href="#">Samples</a>
LM2901VQPWRQ1	ACTIVE	TSSOP	PW	14	2000	RoHS & Green	NIPDAU	Level-1-260C-UNLIM	-40 to 125	2901VQ	<a href="#">Samples</a>

(1) The marketing status values are defined as follows:

**ACTIVE:** Product device recommended for new designs.

**LIFEBUY:** TI has announced that the device will be discontinued, and a lifetime-buy period is in effect.

**NRND:** Not recommended for new designs. Device is in production to support existing customers, but TI does not recommend using this part in a new design.

**PREVIEW:** Device has been announced but is not in production. Samples may or may not be available.

**OBSOLETE:** TI has discontinued the production of the device.

(2) **RoHS:** TI defines "RoHS" to mean semiconductor products that are compliant with the current EU RoHS requirements for all 10 RoHS substances, including the requirement that RoHS substance do not exceed 0.1% by weight in homogeneous materials. Where designed to be soldered at high temperatures, "RoHS" products are suitable for use in specified lead-free processes. TI may reference these types of products as "Pb-Free".

**RoHS Exempt:** TI defines "RoHS Exempt" to mean products that contain lead but are compliant with EU RoHS pursuant to a specific EU RoHS exemption.

**Green:** TI defines "Green" to mean the content of Chlorine (Cl) and Bromine (Br) based flame retardants meet JS709B low halogen requirements of  $\leq 1000$ ppm threshold. Antimony trioxide based flame retardants must also meet the  $\leq 1000$ ppm threshold requirement.

(3) MSL, Peak Temp. - The Moisture Sensitivity Level rating according to the JEDEC industry standard classifications, and peak solder temperature.

(4) There may be additional marking, which relates to the logo, the lot trace code information, or the environmental category on the device.

(5) Multiple Device Markings will be inside parentheses. Only one Device Marking contained in parentheses and separated by a "~" will appear on a device. If a line is indented then it is a continuation of the previous line and the two combined represent the entire Device Marking for that device.

(6) Lead finish/Ball material - Orderable Devices may have multiple material finish options. Finish options are separated by a vertical ruled line. Lead finish/Ball material values may wrap to two lines if the finish value exceeds the maximum column width.

**Important Information and Disclaimer:** The information provided on this page represents TI's knowledge and belief as of the date that it is provided. TI bases its knowledge and belief on information provided by third parties, and makes no representation or warranty as to the accuracy of such information. Efforts are underway to better integrate information from third parties. TI has taken and continues to take reasonable steps to provide representative and accurate information but may not have conducted destructive testing or chemical analysis on incoming materials and chemicals. TI and TI suppliers consider certain information to be proprietary, and thus CAS numbers and other limited information may not be available for release.

In no event shall TI's liability arising out of such information exceed the total purchase price of the TI part(s) at issue in this document sold by TI to Customer on an annual basis.

**OTHER QUALIFIED VERSIONS OF LM2901-Q1, LM2901AV-Q1, LM2901B-Q1, LM2901V-Q1 :**

- Catalog : [LM2901](#), [LM2901AV](#), [LM2901B](#), [LM2901V](#)

NOTE: Qualified Version Definitions:

- Catalog - TI's standard catalog product

**TAPE AND REEL INFORMATION**

**QUADRANT ASSIGNMENTS FOR PIN 1 ORIENTATION IN TAPE**


\*All dimensions are nominal

Device	Package Type	Package Drawing	Pins	SPQ	Reel Diameter (mm)	Reel Width W1 (mm)	A0 (mm)	B0 (mm)	K0 (mm)	P1 (mm)	W (mm)	Pin1 Quadrant
LM2901AVQPWRG4Q1	TSSOP	PW	14	2000	330.0	12.4	6.9	5.6	1.6	8.0	12.0	Q1
LM2901AVQPWRQ1	TSSOP	PW	14	2000	330.0	12.4	6.9	5.6	1.6	8.0	12.0	Q1
LM2901BQDRQ1	SOIC	D	14	3000	330.0	16.4	6.5	9.0	2.1	8.0	16.0	Q1
LM2901BQPWRQ1	TSSOP	PW	14	3000	330.0	12.4	6.9	5.6	1.6	8.0	12.0	Q1
LM2901BWRTERQ1	WQFN	RTE	16	5000	330.0	12.4	3.3	3.3	1.1	8.0	12.0	Q2
LM2901QPWRG4Q1	TSSOP	PW	14	2000	330.0	12.4	6.9	5.6	1.6	8.0	12.0	Q1
LM2901QPWRQ1	TSSOP	PW	14	2000	330.0	12.4	6.9	5.6	1.6	8.0	12.0	Q1
LM2901VQPWRG4Q1	TSSOP	PW	14	2000	330.0	12.4	6.9	5.6	1.6	8.0	12.0	Q1
LM2901VQPWRQ1	TSSOP	PW	14	2000	330.0	12.4	6.9	5.6	1.6	8.0	12.0	Q1



**TAPE AND REEL BOX DIMENSIONS**


\*All dimensions are nominal

Device	Package Type	Package Drawing	Pins	SPQ	Length (mm)	Width (mm)	Height (mm)
LM2901AVQPWRG4Q1	TSSOP	PW	14	2000	367.0	367.0	35.0
LM2901AVQPWRQ1	TSSOP	PW	14	2000	356.0	356.0	35.0
LM2901BQDRQ1	SOIC	D	14	3000	356.0	356.0	35.0
LM2901BQPWRQ1	TSSOP	PW	14	3000	356.0	356.0	35.0
LM2901BWRTERQ1	WQFN	RTE	16	5000	367.0	367.0	35.0
LM2901QPWRG4Q1	TSSOP	PW	14	2000	367.0	367.0	35.0
LM2901QPWRQ1	TSSOP	PW	14	2000	356.0	356.0	35.0
LM2901VQPWRG4Q1	TSSOP	PW	14	2000	367.0	367.0	35.0
LM2901VQPWRQ1	TSSOP	PW	14	2000	356.0	356.0	35.0

D (R-PDSO-G14)

PLASTIC SMALL OUTLINE



- NOTES:
- A. All linear dimensions are in inches (millimeters).
  - B. This drawing is subject to change without notice.
  - Body length does not include mold flash, protrusions, or gate burrs. Mold flash, protrusions, or gate burrs shall not exceed 0.006 (0,15) each side.
  - Body width does not include interlead flash. Interlead flash shall not exceed 0.017 (0,43) each side.
  - E. Reference JEDEC MS-012 variation AB.

PW (R-PDSO-G14)

PLASTIC SMALL OUTLINE



4040064-3/G 02/11

- NOTES:
- A. All linear dimensions are in millimeters. Dimensioning and tolerancing per ASME Y14.5M-1994.
  - B. This drawing is subject to change without notice.
  -  Body length does not include mold flash, protrusions, or gate burrs. Mold flash, protrusions, or gate burrs shall not exceed 0,15 each side.
  -  Body width does not include interlead flash. Interlead flash shall not exceed 0,25 each side.
  - E. Falls within JEDEC MO-153

## GENERIC PACKAGE VIEW

**RTE 16**

**WQFN - 0.8 mm max height**

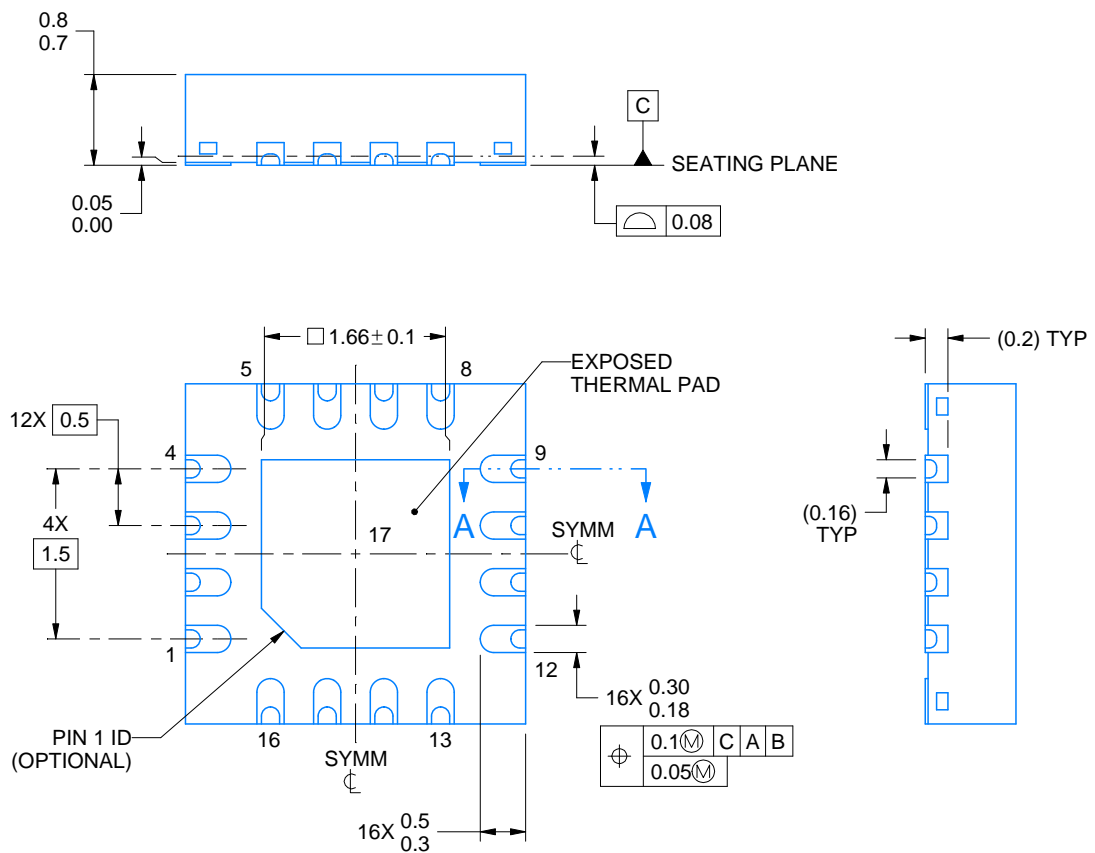
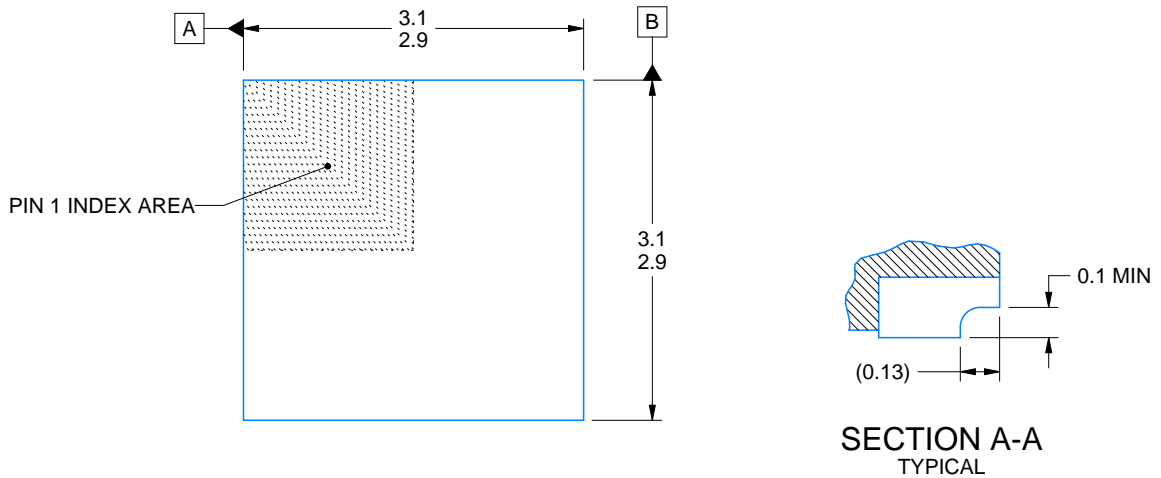
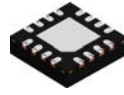
3 x 3, 0.5 mm pitch

PLASTIC QUAD FLATPACK - NO LEAD

This image is a representation of the package family, actual package may vary.  
Refer to the product data sheet for package details.



4225944/A



4224938/C 03/2022

NOTES:

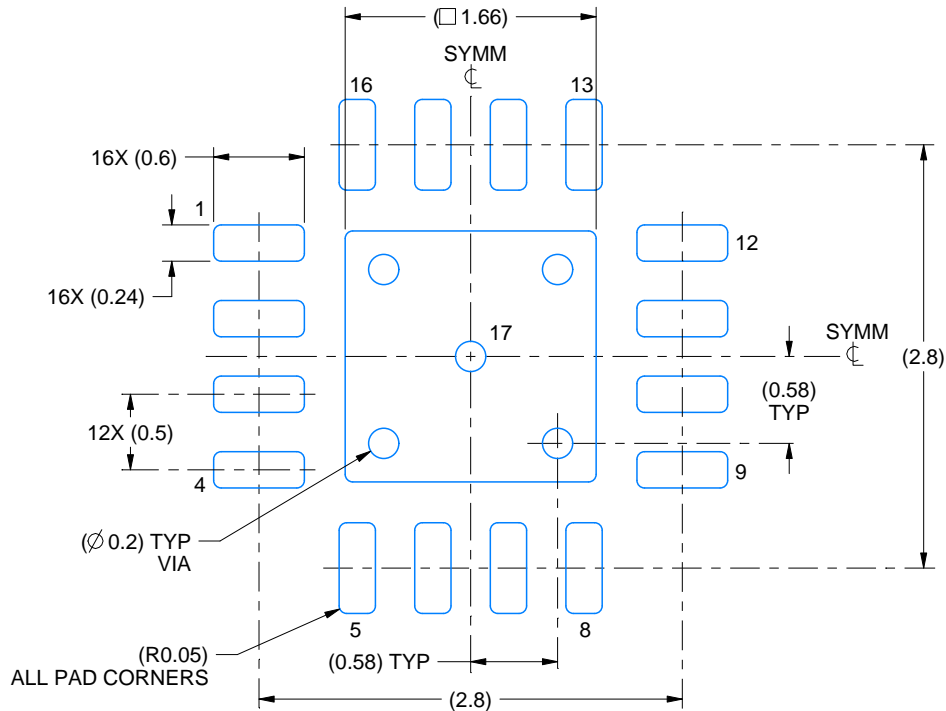
1. All linear dimensions are in millimeters. Any dimensions in parenthesis are for reference only. Dimensioning and tolerancing per ASME Y14.5M.
2. This drawing is subject to change without notice.
3. The package thermal pad must be soldered to the printed circuit board for thermal and mechanical performance.

# EXAMPLE BOARD LAYOUT

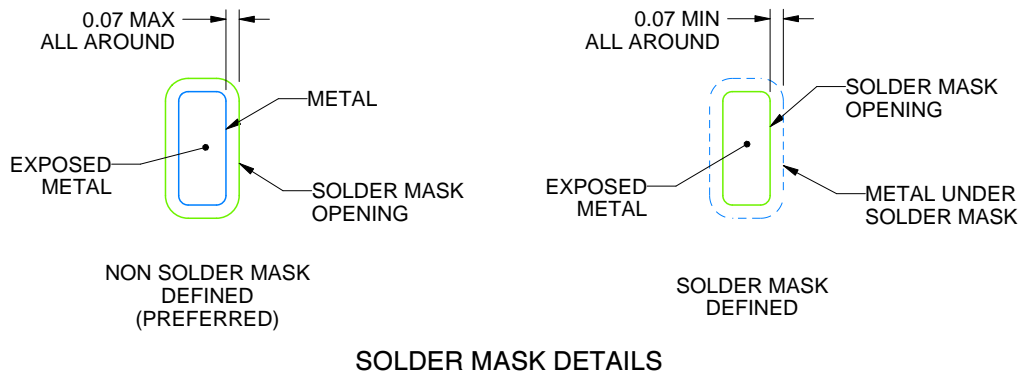
RTE0016K

WQFN - 0.8 mm max height

PLASTIC QUAD FLATPACK - NO LEAD



LAND PATTERN EXAMPLE  
EXPOSED METAL SHOWN  
SCALE:20X



SOLDER MASK DETAILS

4224938/C 03/2022

NOTES: (continued)

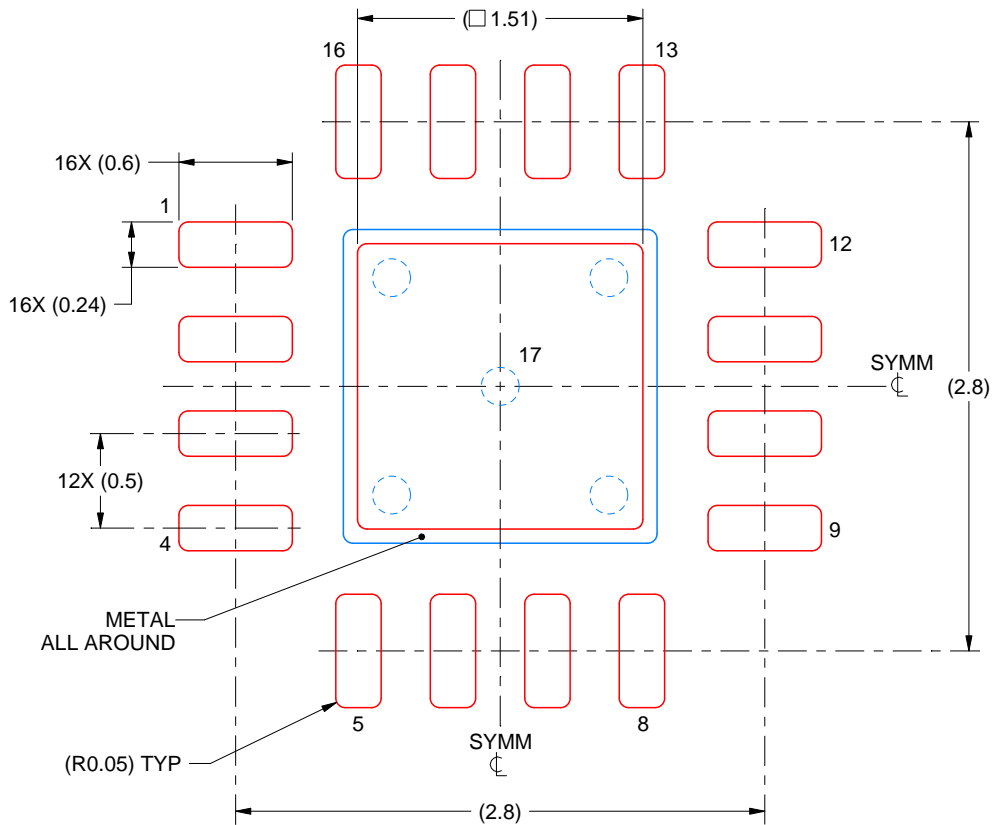
4. This package is designed to be soldered to a thermal pad on the board. For more information, see Texas Instruments literature number SLUA271 ([www.ti.com/lit/sluea271](http://www.ti.com/lit/sluea271)).
5. Vias are optional depending on application, refer to device data sheet. If any vias are implemented, refer to their locations shown on this view. It is recommended that vias under paste be filled, plugged or tented.

# EXAMPLE STENCIL DESIGN

RTE0016K

WQFN - 0.8 mm max height

PLASTIC QUAD FLATPACK - NO LEAD



**SOLDER PASTE EXAMPLE**  
BASED ON 0.125 mm THICK STENCIL

EXPOSED PAD 17:  
84% PRINTED SOLDER COVERAGE BY AREA UNDER PACKAGE  
SCALE:25X

4224938/C 03/2022

NOTES: (continued)

6. Laser cutting apertures with trapezoidal walls and rounded corners may offer better paste release. IPC-7525 may have alternate design recommendations.

## IMPORTANT NOTICE AND DISCLAIMER

TI PROVIDES TECHNICAL AND RELIABILITY DATA (INCLUDING DATA SHEETS), DESIGN RESOURCES (INCLUDING REFERENCE DESIGNS), APPLICATION OR OTHER DESIGN ADVICE, WEB TOOLS, SAFETY INFORMATION, AND OTHER RESOURCES "AS IS" AND WITH ALL FAULTS, AND DISCLAIMS ALL WARRANTIES, EXPRESS AND IMPLIED, INCLUDING WITHOUT LIMITATION ANY IMPLIED WARRANTIES OF MERCHANTABILITY, FITNESS FOR A PARTICULAR PURPOSE OR NON-INFRINGEMENT OF THIRD PARTY INTELLECTUAL PROPERTY RIGHTS.

These resources are intended for skilled developers designing with TI products. You are solely responsible for (1) selecting the appropriate TI products for your application, (2) designing, validating and testing your application, and (3) ensuring your application meets applicable standards, and any other safety, security, regulatory or other requirements.

These resources are subject to change without notice. TI grants you permission to use these resources only for development of an application that uses the TI products described in the resource. Other reproduction and display of these resources is prohibited. No license is granted to any other TI intellectual property right or to any third party intellectual property right. TI disclaims responsibility for, and you will fully indemnify TI and its representatives against, any claims, damages, costs, losses, and liabilities arising out of your use of these resources.

TI's products are provided subject to [TI's Terms of Sale](#) or other applicable terms available either on [ti.com](https://www.ti.com) or provided in conjunction with such TI products. TI's provision of these resources does not expand or otherwise alter TI's applicable warranties or warranty disclaimers for TI products.

TI objects to and rejects any additional or different terms you may have proposed.

Mailing Address: Texas Instruments, Post Office Box 655303, Dallas, Texas 75265  
Copyright © 2024, Texas Instruments Incorporated