

SN65DSI83-Q1 Automotive Single-Channel MIPI® DSI to Single-Link LVDS Bridge

1 Features

- Qualified for Automotive Applications
- AEC-Q100 Qualified With the Following Results:
 - Device Temperature Grade 2: –40°C to +105°C Ambient Operating Temperature
 - Device HBM ESD Classification Level 3A
 - Device CDM ESD Classification Level C6
- Implements MIPI® D-PHY Version 1.00.00 Physical Layer Front-End and Display Serial Interface (DSI) Version 1.02.00
- Single-Channel DSI Receiver Configurable for One, Two, Three, or Four D-PHY Data Lanes Per Channel Operating up to 1 Gbps Per Lane
- Supports 18-bpp and 24-bpp DSI Video Packets with RGB666 and RGB888 Formats
- Maximum Resolution up to 60 fps WUXGA 1920 × 1200 at 18 bpp and 24 bpp Color With Reduced Blanking. Suitable for 60 fps 1366 × 768 / 1280 × 800 at 18 bpp and 24 bpp
- Output for Single-Link LVDS
- Supports Single Channel DSI to Single-Link LVDS Operating Mode
- LVDS Output Clock Range of 25 MHz to 154 MHz
- LVDS Pixel Clock May be Sourced from Free-Running Continuous D-PHY Clock or External Reference Clock (REFCLK)
- 1.8-V Main V_{CC} Power Supply
- Low Power Features Include SHUTDOWN Mode, Reduced LVDS Output Voltage Swing, Common Mode, and MIPI Ultra-Low Power State (ULPS) Support
- LVDS Channel SWAP, LVDS PIN Order Reverse Feature for Ease of PCB Routing
- Packaged in 64-pin 10-mm × 10-mm HTQFP (PAP) PowerPAD™ IC Package

2 Applications

- Infotainment Head Unit With Integrated Display
- Infotainment Head Unit With Remote Display
- Infotainment Rear-Seat Entertainment
- Hybrid Automotive Cluster
- Portable Navigation Device
- Navigation
- Industrial Human Machine Interface (HMI) and Displays

3 Description

The SN65DSI83-Q1 DSI-to-LVDS bridge features a single-channel MIPI D-PHY receiver front-end configuration with four lanes per channel operating at 1 Gbps per lane and a maximum input bandwidth of 4 Gbps. The bridge decodes MIPI DSI 18-bpp RGB666 and 24-bpp RGB888 packets and converts the formatted video data-stream to an LVDS output operating at pixel clocks operating from 25 MHz to 154 MHz, offering a Single-Link LVDS with four data lanes per link.

The SN65DSI83-Q1 device can support up to WUXGA 1920 × 1200 at 60 frames per second, at 24 bpp with reduced blanking. The SN65DSI83-Q1 device is also suitable for applications using 60 fps 1366 × 768/1280 × 800 at 18 bpp and 24 bpp. Partial line buffering is implemented to accommodate the data stream mismatch between the DSI and LVDS interfaces.

The SN65DSI83-Q1 device is implemented in a small outline 10-mm × 10-mm HTQFP package with a 0.5-mm pitch, and operates across a temperature range from –40°C to +105°C.

Device Information⁽¹⁾

PART NUMBER	PACKAGE	BODY SIZE (NOM)
SN65DSI83-Q1	HTQFP (64)	10.00 mm × 10.00 mm

(1) For all available packages, see the orderable addendum at the end of the data sheet.

SN65DSI83-Q1 Schematic

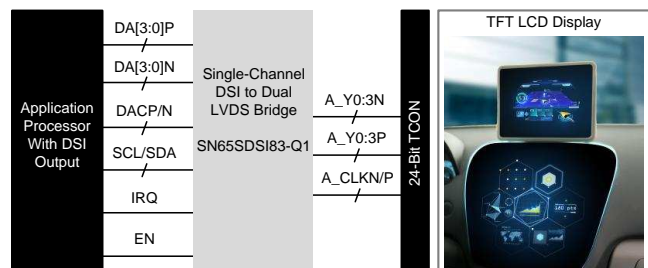

Copyright © 2016, Texas Instruments Incorporated



Table of Contents

1 Features	1	8.5 Register Maps	23
2 Applications	1	9 Application and Implementation	37
3 Description	1	9.1 Application Information.....	37
4 Revision History	2	9.2 Typical Application	38
5 Pin Configuration and Functions	3	10 Power Supply Recommendations	43
6 Specifications	6	10.1 V _{CC} Power Supply.....	43
6.1 Absolute Maximum Ratings	6	10.2 V _{CORE} Power Supply	43
6.2 ESD Ratings.....	6	11 Layout	43
6.3 Recommended Operating Conditions.....	6	11.1 Layout Guidelines	43
6.4 Thermal Information	6	11.2 Layout Example	44
6.5 Electrical Characteristics.....	7	12 Device and Documentation Support	45
6.6 Switching Characteristics.....	9	12.1 Documentation Support	45
7 Parameter Measurement Information	10	12.2 Receiving Notification of Documentation Updates	45
8 Detailed Description	13	12.3 Community Resource.....	45
8.1 Overview	13	12.4 Trademarks	45
8.2 Functional Block Diagram	13	12.5 Electrostatic Discharge Caution.....	45
8.3 Feature Description.....	13	12.6 Glossary	45
8.4 Programming.....	21	13 Mechanical, Packaging, and Orderable Information	46

4 Revision History

Changes from Original (December 2016) to Revision A

Page

• Deleted figure <i>RESET and Initialization Timing Definition While V_{CC} is High</i>	12
• Changed the paragraph following Figure 8	15
• Changed <i>Recommended Initialization Sequence</i> To: <i>Initialization Sequence</i>	16
• Changed Table 2	16
• Changed item 3 in <i>Video Stop and Restart Sequence</i> From: Drive all DSI input lanes including DSI CLK lane to LP11. To: Drive all DSI data lanes to LP11, but keep the DSI CLK lanes in HS.	37

5 Pin Configuration and Functions

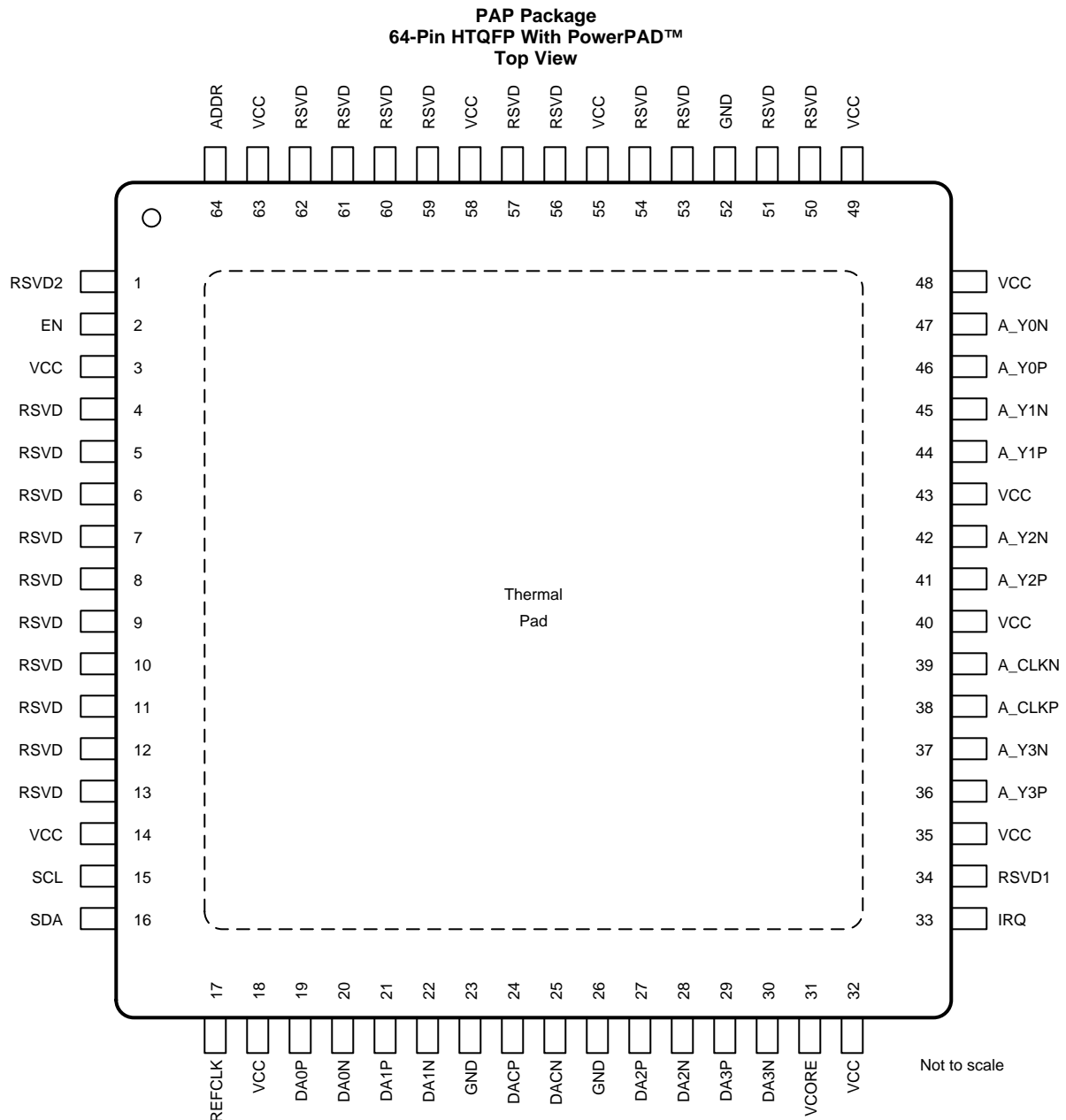

See the [Layout](#) section for layout information.

Pin Functions

PIN		TYPE	DESCRIPTION
NAME	NO.		
ADDR	64	I/O	Local I ² C interface target address select. See Table 3 . In normal operation this pin is an input. When the ADDR pin is programmed high, it must be tied to the same 1.8-V power rails where the SN65DSI83-Q1 VCC 1.8-V power rail is connected
A_CLKP	38	O	LVDS channel A, LVDS clock output
A_CLKN	39		
A_Y0P	46	O	LVDS channel A, LVDS data output 0
A_Y0N	47		
A_Y1P	44	O	LVDS channel A, LVDS data output 1
A_Y1N	45		
A_Y2P	41	O	LVDS channel A, LVDS data output 2
A_Y2N	42		
A_Y3P	36	O	LVDS channel A, LVDS data output 3. A_Y3P and A_Y3N must be left not connected (NC) for 18-bpp panels
A_Y3N	37		
DA0P	19	I	MIPI D-PHY channel A, data lane 0; data rate up to 1 Gbps
DA0N	20		
DA1P	21	I	MIPI D-PHY channel A, data lane 1; data rate up to 1 Gbps
DA1N	22		
DA2P	27	I	MIPI D-PHY channel A, data lane 2; data rate up to 1 Gbps
DA2N	28		
DA3P	29	I	MIPI D-PHY channel A, data lane 3; data rate up to 1 Gbps
DA3N	30		
DACP	24	I	MIPI D-PHY channel A, clock lane; data rate up to 1 Gbps
DACN	25		
EN	2	I	Chip enable and reset. The device is reset (shutdown) when the EN pin is low
GND	23, 26, 52	G	Reference ground
IRQ	33	O	Interrupt signal
REFCLK	17	I	This pin is an optional external reference clock for the LVDS pixel clock. If an external reference clock is not used, this pin must be pulled to ground with an external resistor. The source of the reference clock must be placed as close as possible with a series resistor near the source to reduce EMI

Pin Functions (continued)

PIN		TYPE	DESCRIPTION
NAME	NO.		
RSVD	4	RSVD	Reserved and leave them unconnected
	5		
	6		
	7		
	8		
	9		
	10		
	11		
	12		
	13		
	50		
	51		
	53		
	54		
	56		
	57		
59			
60			
61			
62			
RSVD1	34	I/O	Reserved. This pin must be left unconnected for normal operation
RSVD2	1	I	Reserved. This pin must be left unconnected for normal operation
SCL	15	I	Local I ² C interface clock
SDA	16	I/O	Local I ² C interface data
V _{CC}	3	—	1.8-V power supply
	14		
	18		
	32		
	35		
	40		
	43		
	48		
	49		
	55		
58			
63			
VCORE	31	P	1.1-V output from the voltage regulator. This pin must have a 1-μF external capacitor to ground
PowerPAD	—	—	Reference ground

6 Specifications

6.1 Absolute Maximum Ratings

over operating free-air temperature range (unless otherwise noted)⁽¹⁾

		MIN	MAX	UNIT	
V _{CC}	Supply voltage	-0.3	2.175	V	
	Input voltage	CMOS input pins	-0.5	2.175	V
		DSI input pins (DAxP, DAxN)	-0.4	1.4	V
T _A	Operating free-air temperature	-40	105	°C	
T _J	Junction temperature	-40	115	°C	
T _{stg}	Storage temperature	-65	150	°C	

- (1) Stresses beyond those listed under *Absolute Maximum Ratings* may cause permanent damage to the device. These are stress ratings only, which do not imply functional operation of the device at these or any other conditions beyond those indicated under *Recommended Operating Conditions*. Exposure to absolute-maximum-rated conditions for extended periods may affect device reliability.

6.2 ESD Ratings

		VALUE	UNIT
V _(ESD)	Electrostatic discharge	Human-body model (HBM), per AEC Q100-002 ⁽¹⁾	±4000
		Charged-device model (CDM), per AEC Q100-011	±1000

- (1) AEC Q100-002 indicates that HBM stressing shall be in accordance with the ANSI/ESDA/JEDEC JS-001 specification.

6.3 Recommended Operating Conditions

over operating free-air temperature range (unless otherwise noted)

		MIN	NOM	MAX	UNIT
V _{CC}	V _{CC} power supply	1.65	1.8	1.95	V
V _{PSN}	Supply noise on any V _{CC} pin	$f_{(noise)} > 1 \text{ MHz}$		0.05	V
V _(DSI)	DSI input pin voltage	-50		1350	mV
f _(I2C)	Local I ² C input frequency			400	kHz
f _{HS(CLK)}	DSI high-speed (HS) clock input frequency	40		500	MHz
t _{su}	DSI HS data to clock setup time; see Figure 1	0.15			UI ⁽¹⁾
t _h	DSI HS data to clock hold time; see Figure 1	0.15			UI ⁽¹⁾
Z _{OD(LVDS)}	LVDS output differential impedance	90		132	Ω
T _C	Case temperature			92.2	°C

- (1) The unit interval (UI) is one half of the period of the HS clock; at 500 MHz the minimum setup and hold time is 150 ps.

6.4 Thermal Information

THERMAL METRIC ⁽¹⁾		SN65DSI83-Q1	UNIT
		PAP (HTQFP)	
		64 PINS	
R _{θJA}	Junction-to-ambient thermal resistance	36.1	°C/W
R _{θJC(top)}	Junction-to-case (top) thermal resistance	18.2	°C/W
R _{θJB}	Junction-to-board thermal resistance	20.6	°C/W
ψ _{JT}	Junction-to-top characterization parameter	0.8	°C/W
ψ _{JB}	Junction-to-board characterization parameter	20.5	°C/W
R _{θJC(bot)}	Junction-to-case (bottom) thermal resistance	2.2	°C/W

- (1) For more information about traditional and new thermal metrics, see the [Semiconductor and IC Package Thermal Metrics](#) application report.

6.5 Electrical Characteristics

over operating free-air temperature range (unless otherwise noted)

PARAMETER		TEST CONDITIONS	MIN	TYP ⁽¹⁾	MAX	UNIT
V _{IL}	Low-level control signal input voltage				0.3 × V _{CC}	V
V _{IH}	High-level control signal input voltage		0.7 × V _{CC}			V
V _{OH}	High-level output voltage	I _{OH} = -4 mA	1.25			V
V _{OL}	Low-level output voltage	I _{OL} = 4 mA			0.4	V
I _{LKG}	Input failsafe leakage current	V _{CC} = 0; V _{CC(PIN)} = 1.8 V			±30	μA
I _{IH}	High level input current	Any input terminal			±30	μA
I _{IL}	Low level input current	Any input terminal			±30	μA
I _{OZ}	High-impedance output current	CMOS output terminals			±10	μA
I _{OS}	Short-circuit output current	Any output driving GND short			±50	mA
I _{CC}	Device active current	See ⁽²⁾		77	124	mA
I _{ULPS}	Device standby current	All data and clock lanes are in ultra-low power state (ULPS)		7.7	14	mA
I _{RST}	Shutdown current	EN = 0			130	μA
R _{EN}	EN control input resistor			200		kΩ

- (1) All typical values are at V_{CC} = 1.8 V and T_A = 25°C
 (2) SN65DSI83-Q1: SINGLE Channel DSI to SINGLE Channel DSI, 1280 × 800
 (a) Number of LVDS lanes = 3 data lanes + 1 CLK lane
 (b) Number of DSI lanes = 4 data lanes + 1 CLK lane
 (c) LVDS CLK OUT = 83 M
 (d) DSI CLK = 500 M
 (e) RGB888, LVDS 18 bpp
 Maximum values are at V_{CC} = 1.95 V and T_A = 85°C

Electrical Characteristics (continued)

over operating free-air temperature range (unless otherwise noted)

PARAMETER		TEST CONDITIONS	MIN	TYP ⁽¹⁾	MAX	UNIT
MIPI DSI INTERFACE						
V _{IH-LP}	LP receiver input high threshold	See Figure 2	880			mV
V _{IL-LP}	LP receiver input low threshold	See Figure 2			550	mV
V _{ID}	HS differential input voltage		100		270	mV
V _{IDT}	HS differential input voltage threshold				50	mV
V _{IL-ULPS}	LP receiver input low threshold; ultra-low power state (ULPS)				300	mV
V _{CM-HS}	HS common mode voltage; steady-state		70		330	mV
ΔV _{CM-HS}	HS common mode peak-to-peak variation including symbol delta and interference				100	mV
V _{IH-HS}	HS single-ended input high voltage	See Figure 2			460	mV
V _{IL-HS}	HS single-ended input low voltage	See Figure 2	–40			mV
V _{TERM-EN}	HS termination enable; single-ended input voltage (both Dp AND Dn apply to enable)	Termination is switched simultaneous for Dn and Dp			450	mV
R _{DIFF-HS}	HS mode differential input impedance		80		125	Ω
LVDS OUTPUT						
V _{Odl}	Steady-state differential output voltage A _Y x P/N	CSR 0x19.3:2=00 100 Ω near end termination	180	245	330	mV
		CSR 0x19.3:2=01 100 Ω near end termination	215	293	392	
		CSR 0x19.3:2=10 100 Ω near end termination	250	341	455	
		CSR 0x19.3:2=11 100 Ω near end termination	290	389	515	
		CSR 0x19.3:2=00 200 Ω near end termination	150	204	275	
		CSR 0x19.3:2=01 200 Ω near end termination	200	271	365	
		CSR 0x19.3:2=10 200 Ω near end termination	250	337	450	
		CSR 0x19.3:2=11 200 Ω near end termination	300	402	535	
V _{Odl}	Steady-state differential output voltage for A _{CLKP/N}	CSR 0x19.3:2=00 near end termination	140	191	262	mV
		CSR 0x19.3:2=01 100 Ω near end termination	168	229	315	
		CSR 0x19.3:2=10 100 Ω near end termination	195	266	365	
		CSR 0x19.3:2=11 100 Ω near end termination	226	303	415	
		CSR 0x19.3:2=00 200 Ω near end termination	117	159	220	
		CSR 0x19.3:2=01 200 Ω near end termination	156	211	295	
		CSR 0x19.3:2=10 200 Ω near end termination	195	263	362	
		CSR 0x19.3:2=11 200 Ω near end termination	234	314	435	
Δ V _{Odl}	Change in steady-state differential output voltage between opposite binary states	RL = 100 Ω			35	mV
V _{OC(SS)}	Steady state common-mode output voltage ⁽³⁾	CSR 0x19.6 = 1 and CSR 0x1B.6 = 1 Figure 3	0.75	0.9	1.13	V
		CSR 0x19.6 = 0 see Figure 3	1	1.25	1.5	
V _{OC(PP)}	Peak-to-peak common-mode output voltage	see Figure 3			35	mV
R _{LVDS_D IS}	Pulldown resistance for disabled LVDS outputs			1		kΩ

 (3) Tested at V_{CC} = 1.8V, T_A = –40°C for MIN, T_A = 25°C for TYP, T_A = 105°C for MAX.

6.6 Switching Characteristics

over operating free-air temperature range (unless otherwise noted)

PARAMETER		TEST CONDITIONS	MIN	TYP ⁽¹⁾	MAX	UNIT
DSI						
t_{GS}	DSI LP glitch suppression pulse width				300	ps
LVDS						
t_c	Output clock period		6.49		40	ns
t_w	High-level output clock (CLK) pulse duration			$4/7 t_c$		ns
t_0	Delay time, CLK \uparrow to 1st serial bit position		-0.15		0.15	ns
t_1	Delay time, CLK \uparrow to 2nd serial bit position		$1/7 t_c - 0.15$		$1/7 t_c + 0.15$	ns
t_2	Delay time, CLK \uparrow to 3rd serial bit position	$t_c = 6.49$ ns; Input clock jitter < 25 ps (REFCLK) See Figure 4	$2/7 t_c - 0.15$		$2/7 t_c + 0.15$	ns
t_3	Delay time, CLK \uparrow to 4th serial bit position		$3/7 t_c - 0.15$		$3/7 t_c + 0.15$	ns
t_4	Delay time, CLK \uparrow to 5th serial bit position		$4/7 t_c - 0.15$		$4/7 t_c + 0.15$	ns
t_5	Delay time, CLK \uparrow to 6th serial bit position		$5/7 t_c - 0.15$		$5/7 t_c + 0.15$	ns
t_6	Delay time, CLK \uparrow to 7th serial bit position		$6/7 t_c - 0.15$		$6/7 t_c + 0.15$	ns
t_r	Differential output rise time		See Figure 4		180	
t_f	Differential output fall time				500	
EN, ULPS, RESET						
t_{en}	Enable time from EN or ULPS	$t_{c(o)} = 12.9$ ns			1	ms
t_{dis}	Disable time to standby; see	$t_{c(o)} = 12.9$ ns			0.1	ms
t_{reset}	Reset yime		10			ms
REFCLK						
F_{REFCLK}	REFCLK frequency. Supported frequencies: 25 MHz - 154 MHz		25		154	MHz
t_r, t_f	REFCLK rise and fall time		100×10^{-12}		1×10^{-9}	s
t_{pj}	REFCLK peak-to-peak phase jitter				50	ps
Duty	REFCLK duty cycle		40%	50%	60%	
REFCLK or DSI CLK (DACP/N)						
SSC_CLKIN	SSC enabled Input CLK center spread depth ⁽²⁾		0.5%	1%	2%	
	Modulation frequency		30		60	kHz

(1) All typical values are at $V_{CC} = 1.8$ V and $T_A = 25^\circ\text{C}$

(2) For EMI reduction purpose, the SN65DSI83-Q1 supports the center spreading of the LVDS CLK output through the REFCLK or DSI CLK input. The center spread CLK input to the REFCLK or DSI CLK is passed through to the LVDS CLK output A_CLKP/N.

7 Parameter Measurement Information

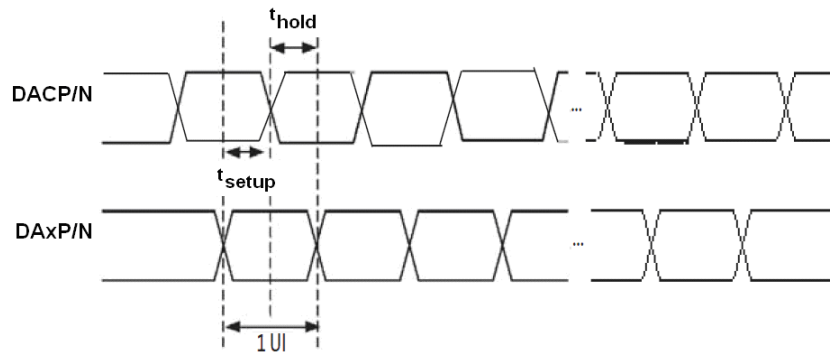

Figure 1. DSI HS Mode Receiver Timing Definitions

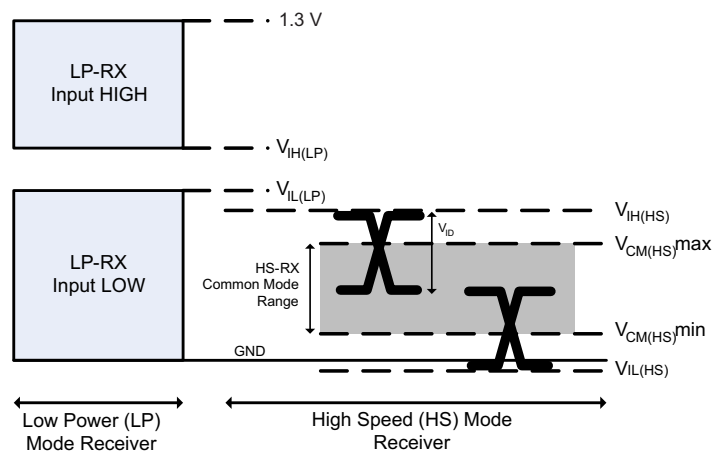

Figure 2. DSI Receiver Voltage Definitions

Parameter Measurement Information (continued)

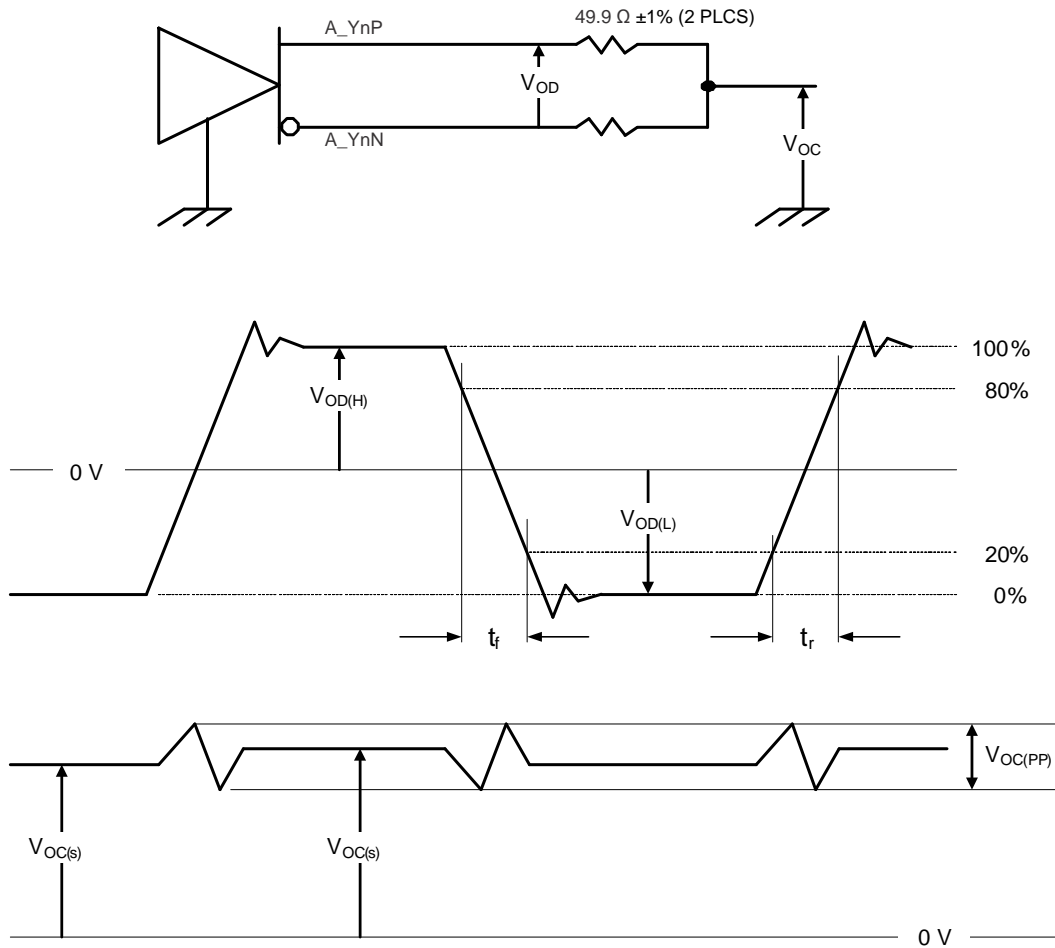

Figure 3. Test Load and Voltage Definitions for LVDS Outputs

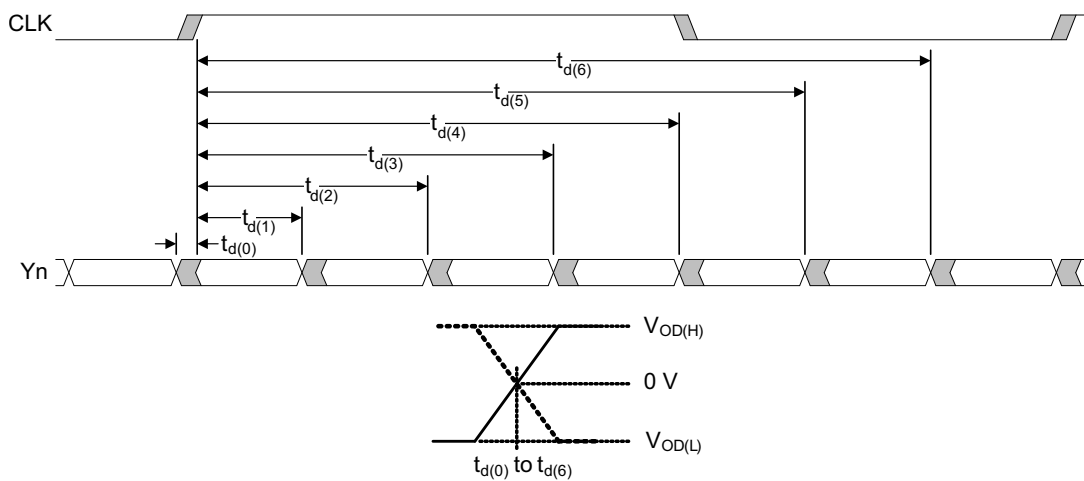
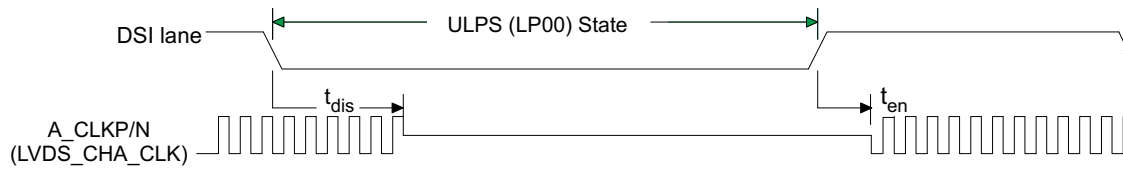

Figure 4. SN65DSI83-Q1 LVDS Timing Definitions

Parameter Measurement Information (continued)

- (1) See the [ULPS](#) section of the data sheet for the ULPS entry and exit sequence.
- (2) ULPS entry and exit protocol and timing requirements must be met according to the MIPI DPHY specification.

Figure 5. ULPS Timing Definition

8 Detailed Description

8.1 Overview

The SN65DSI83-Q1 DSI to LVDS bridge device features a single-channel MIPI® D-PHY receiver front-end configuration with four lanes per channel operating at 1 Gbps per lane; a maximum input bandwidth of 4 Gbps. The bridge decodes MIPI DSI 18-bpp RGB666 and 24-bpp RGB888 packets and converts the formatted video data stream to an LVDS output operating at pixel clocks operating from 25 MHz to 154 MHz, offering a Single-Link LVDS with four data lanes per link.

8.2 Functional Block Diagram

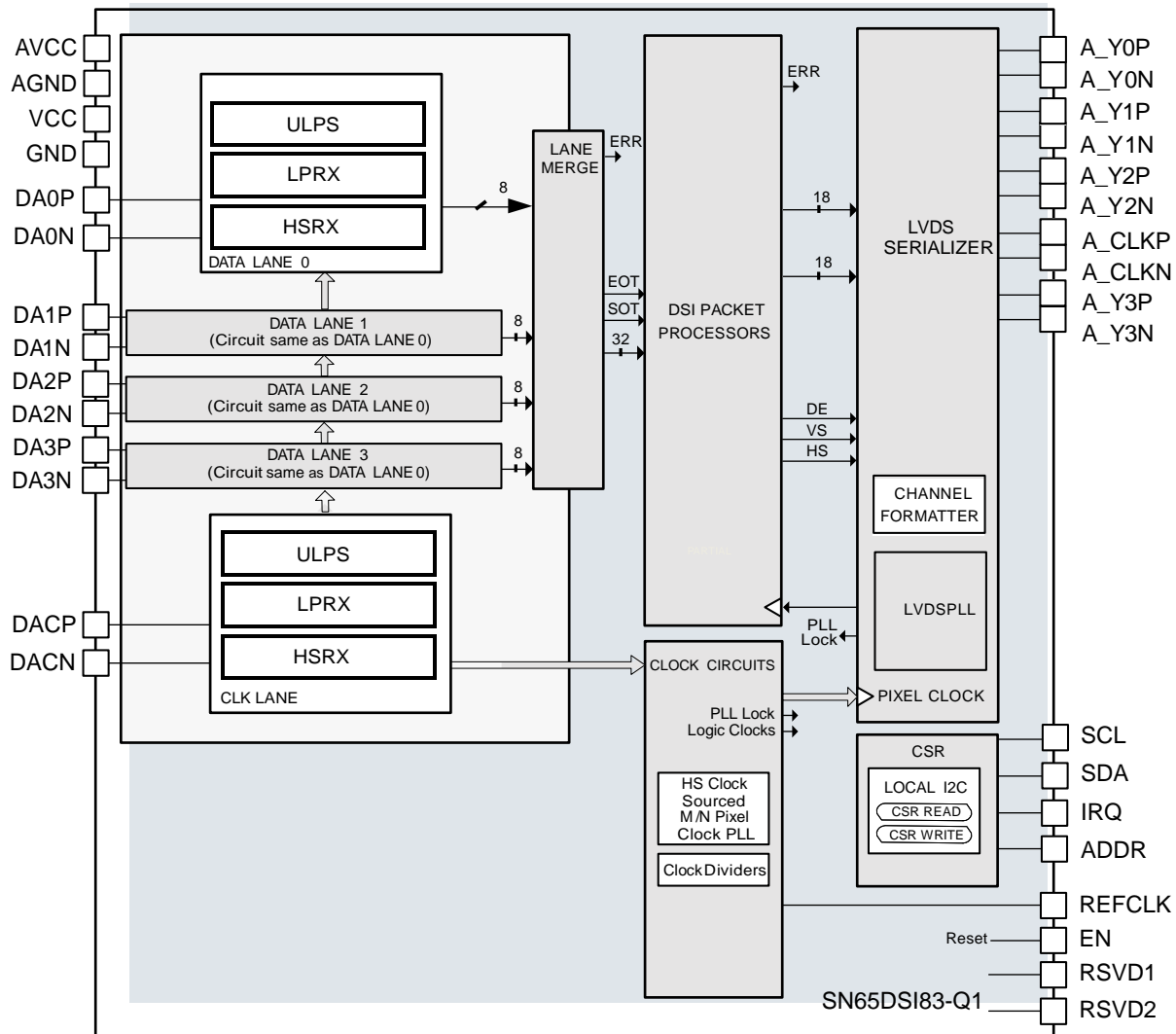

8.3 Feature Description

8.3.1 Clock Configurations and Multipliers

The LVDS clock may be derived from the DSI channel A clock, or from an external reference clock source. When the MIPI D-PHY channel A HS clock is used as the LVDS clock source, the D-PHY clock lane must operate in HS free-running (continuous) mode. This feature eliminates the need for an external reference clock reducing system costs.

Feature Description (continued)

The reference clock source is selected by HS_CLK_SRC (CSR 0x0A.0) programmed through the local I²C interface. If an external reference clock is selected, it is multiplied by the factor in REFCLK_MULTIPLIER (CSR 0x0B.1:0) to generate the LVDS output clock. When an external reference clock is selected, it must be between 25 MHz and 154 MHz. If the DSI channel A clock is selected, it is divided by the factor in DSI_CLK_DIVIDER (CSR 0x0B.7:3) to generate the LVDS output clock. Additionally, LVDS_CLK_RANGE (CSR 0x0A.3:1) and CH_DSI_CLK_RANGE (CSR 0x12) must be set to the frequency range of the LVDS output clock and DSI Channel A input clock respectively for the internal PLL to operate correctly. After these settings are programmed, PLL_EN (CSR 0x0D.0) must be set to enable the internal PLL.

8.3.2 ULPS

The SN65DSI83-Q1 device supports the MIPI defined ULPS. While the device is in the ULPS, the CSR registers are accessible via I²C interface. ULPS sequence must be issued to all active DSI CLK and, or DSI data lanes of the enabled DSI channels for the SN65DSI83-Q1 device to enter the ULPS. The following sequence must be followed to enter and exit the ULPS.

1. The host issues a ULPS entry sequence to all DSI CLK and data lanes enabled.
2. When the host is ready to exit the ULPS mode, the host issues a ULPS exit sequence to all DSI CLK and data lanes that need to be active in normal operation.
3. Wait for the PLL_LOCK bit (CSR 0x0A.7) to be set.
4. Set the SOFT_RESET bit (CSR 0x09.0).
5. Device resumes normal operation (that is, video streaming resumes on the panel).

8.3.3 LVDS Pattern Generation

The SN65DSI83-Q1 device supports a pattern generation feature on LVDS channels. This feature can be used to test the LVDS output path and LVDS panels in a system platform. The pattern generation feature can be enabled by setting the CHA_TEST_PATTERN bit at address 0x3C. No DSI data is received while the pattern generation feature is enabled.

There are three modes available for LVDS test pattern generation. The mode of test pattern generation is determined by register configuration, as shown in [Table 1](#).

Table 1. Video Registers

ADDRESS BIT	REGISTER NAME
0x20.7:0	CHA_ACTIVE_LINE_LENGTH_LOW
0x21.3:0	CHA_ACTIVE_LINE_LENGTH_HIGH
0x24.7:0	CHA_VERTICAL_DISPLAY_SIZE_LOW
0x25.3:0	CHA_VERTICAL_DISPLAY_SIZE_HIGH
0x2C.7:0	CHA_HSYNC_PULSE_WIDTH_LOW
0x2D.1:0	CHA_HSYNC_PULSE_WIDTH_HIGH
0x30.7:0	CHA_VSYNC_PULSE_WIDTH_LOW
0x31.1:0	CHA_VSYNC_PULSE_WIDTH_HIGH
0x34.7:0	CHA_HORIZONTAL_BACK_PORCH
0x36.7:0	CHA_VERTICAL_BACK_PORCH
0x38.7:0	CHA_HORIZONTAL_FRONT_PORCH
0x3A.7:0	CHA_VERTICAL_FRONT_PORCH

8.3.4 Reset Implementation

When the EN pin is deasserted (low), the SN65DSI83-Q1 device is in SHUTDOWN or RESET state. In this state, CMOS inputs are ignored, the MIPI D-PHY inputs are disabled and outputs are high impedance. Transitioning the EN input from a low to a high level after the V_{CC} supply has reached the minimum operating voltage as shown in [Figure 6](#) is critical. This transition is achieved by a control signal to the EN input, or by an external capacitor connected between EN and GND.

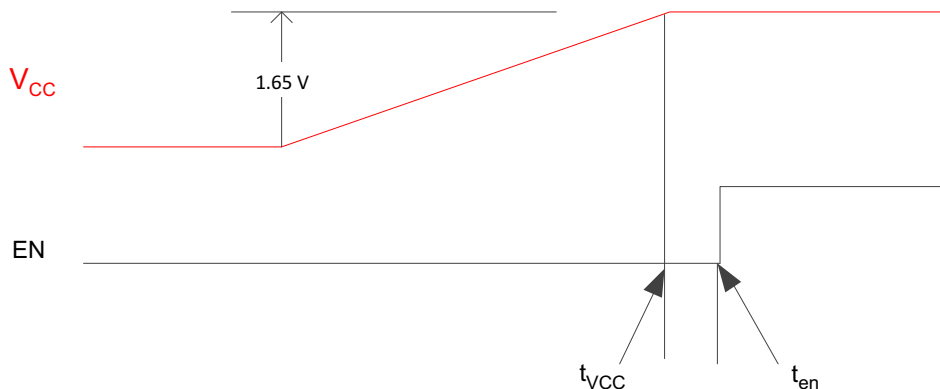

Figure 6. Cold-Start V_{CC} Ramp Up to EN

When implementing the external capacitor, the size of the external capacitor depends on the power up ramp of the V_{CC} supply, where a slower ramp-up results in a larger value external capacitor. Consider an approximately 200-nF capacitor as a reasonable first estimate for the size of the external capacitor.

Figure 7 and Figure 8 show both EN implementations.

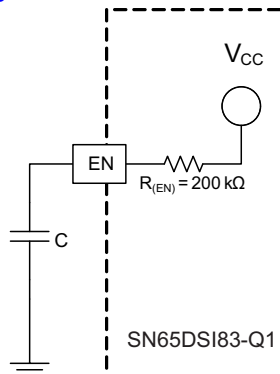

Figure 7. External Capacitor Controlled EN

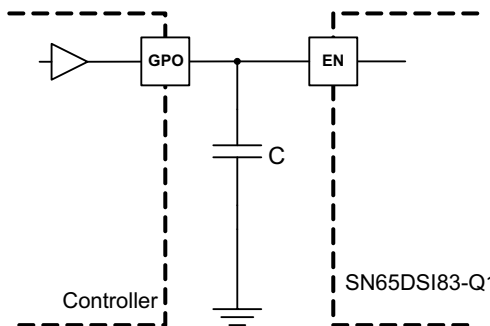

Figure 8. EN Input from Active Controller

When the SN65DSI83-Q1 is reset while V_{CC} is high, the EN pin must be held low for at least 10 ms before being asserted high as described in Table 2 to be sure that the device is properly reset. The DSI CLK lane MUST be in HS and the DSI data lanes MUST be driven to LP11 while the device is in reset before the EN pin is asserted per the timing described in Table 2.

8.3.5 Initialization Sequence

Use the following initialization sequence to setup the SN65DSI83-Q1. This sequence is required for proper operation of the device. Steps 9 through 11 in the sequence are optional. Also see [Figure 6](#).

Table 2. Initialization Sequence

INITIALIZATION SEQUENCE NUMBER	INITIALIZATION SEQUENCE DESCRIPTION
Init seq 1	Power on
Init seq 2	After power is applied and stable, the DSI CLK lanes MUST be in HS state and the DSI data lanes MUST be driven to LP11 state
Init seq 3	Set EN pin to Low
Wait 10 ms ⁽¹⁾	
Init seq 4	Tie EN pin to High
Wait 10 ms ⁽¹⁾	
Init seq 5	Initialize all CSR registers to their appropriate values based on the implementation (The SN65DSI8x is not functional until the CSR registers are initialized)
Init seq 6	Set the PLL_EN bit (CSR 0x0D.0)
Wait 10 ms ⁽¹⁾	
Init seq 7	Set the SOFT_RESET bit (CSR 0x09.0)
Wait 10 ms ⁽¹⁾	
Init seq 8	Change DSI data lanes to HS state and start DSI video stream
Wait 5 ms ⁽¹⁾	
Init seq 9	Read back all registers and confirm they were correctly written
Init seq 10	Write 0xFF to CSR 0xE5 to clear the error registers
Wait 1 ms ⁽¹⁾	
Init seq 11	Read CSR 0xE5. If CSR 0xE5 != 0x00, then go back to step #2 and re-initialize

(1) Minimum recommended delay. It is fine to exceed these.

8.3.6 LVDS Output Formats

The SN65DSI83-Q1 device processes DSI packets and produces video data driven to the LVDS interface in an industry standard format. Single-Link LVDS is supported by the SN65DSI83-Q1 device. During conditions such as the default condition, and some video synchronization periods, where no video stream data is passing from the DSI input to the LVDS output, the SN65DSI83-Q1 device transmits zero value pixel data on the LVDS outputs while maintaining transmission of the vertical sync and horizontal sync status.

[Figure 9](#) illustrates a Single-Link LVDS 18-bpp application.

[Figure 10](#) illustrates a Single-Link 24-bpp application using Format 2, controlled by CHA_24BPP_FORMAT1 (CSR 0x18.1). In data Format 2, the two MSB per color are transferred on the Y3P/N LVDS lane.

[Figure 11](#) illustrates a 24-bpp Single-Link application using Format 1. In data Format 1, the two LSB per color are transferred on the Y3P/N LVDS lane.

[Figure 12](#) illustrates a Single-Link LVDS application where 24-bpp data is received from DSI and converted to 18 bpp data for transmission to an 18-bpp panel. This application is configured by setting CHA_24BPP_FORMAT1 (CSR 0x18.1) to 1 and CHA_24BPP_MODE (CSR 0x18.3) to 0. In this configuration, the SN65DSI83-Q1 device does not transmit the 2 LSB per color since the Y3P and Y3N LVDS lane is disabled.

NOTE

[Figure 9](#), [Figure 10](#), [Figure 11](#), and [Figure 12](#) only illustrate a few example applications for the SN65DSI83-Q1 device. Other applications are also supported.

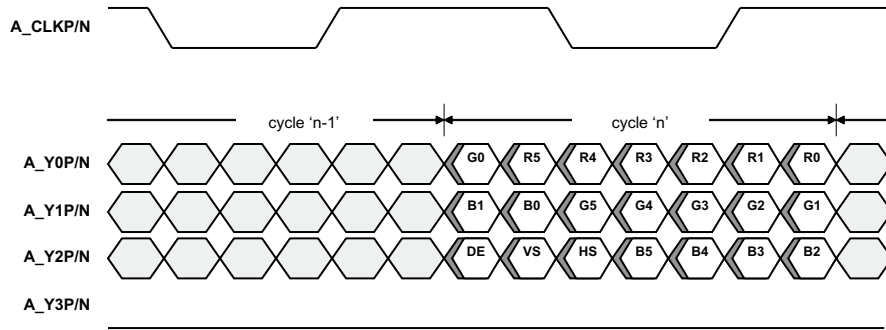

DE = Data Enable; A_Y3P/N are Output Low

Figure 9. LVDS Output Data; Single-Link 18 bpp

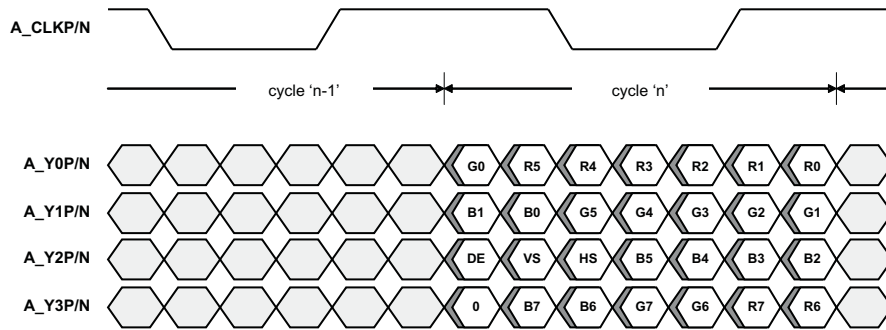

DE = Data Enable

Figure 10. LVDS Output Data (Format 2); Single-Link 24 bpp

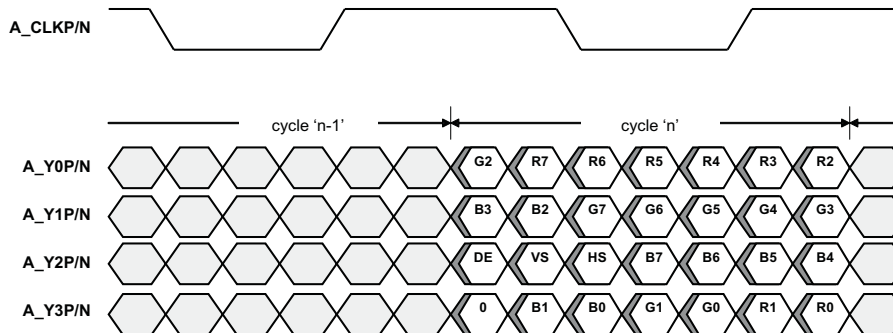

DE = Data Enable

Figure 11. LVDS Output Data (Format 1); Single-Link 24 bpp

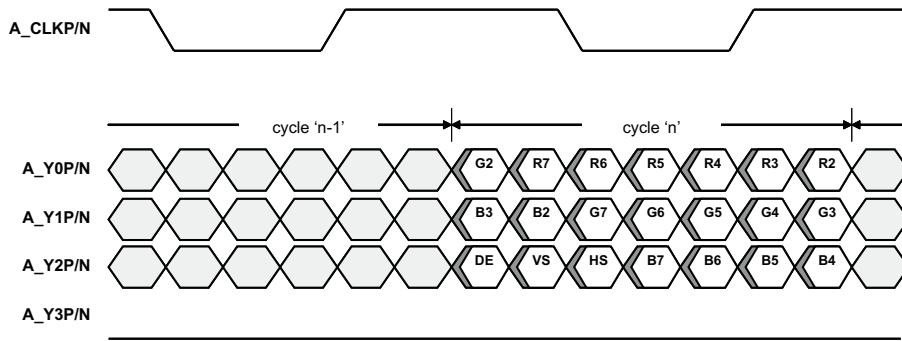

DE = Data Enable; A_Y3P and A_Y3N are output low; A_Y3P and A_Y3N are output low

Figure 12. LVDS Output Data (Format 1); 24 bpp to Single-Link 18 bpp Conversion

8.3.7 DSI Lane Merging

The SN65DSI83-Q1 supports four DSI data lanes per input channel, and may be configured to support one, two, or three DSI data lanes per channel. Unused DSI input pins on the SN65DSI83-Q1 must be left unconnected or driven to LP11 state. The bytes received from the data lanes are merged in HS mode to form packets that carry the video stream. DSI data lanes are bit and byte aligned.

Figure 13 shows the lane merging function for each channel; 4-Lane, 3-Lane, and 2-Lane modes are illustrated.

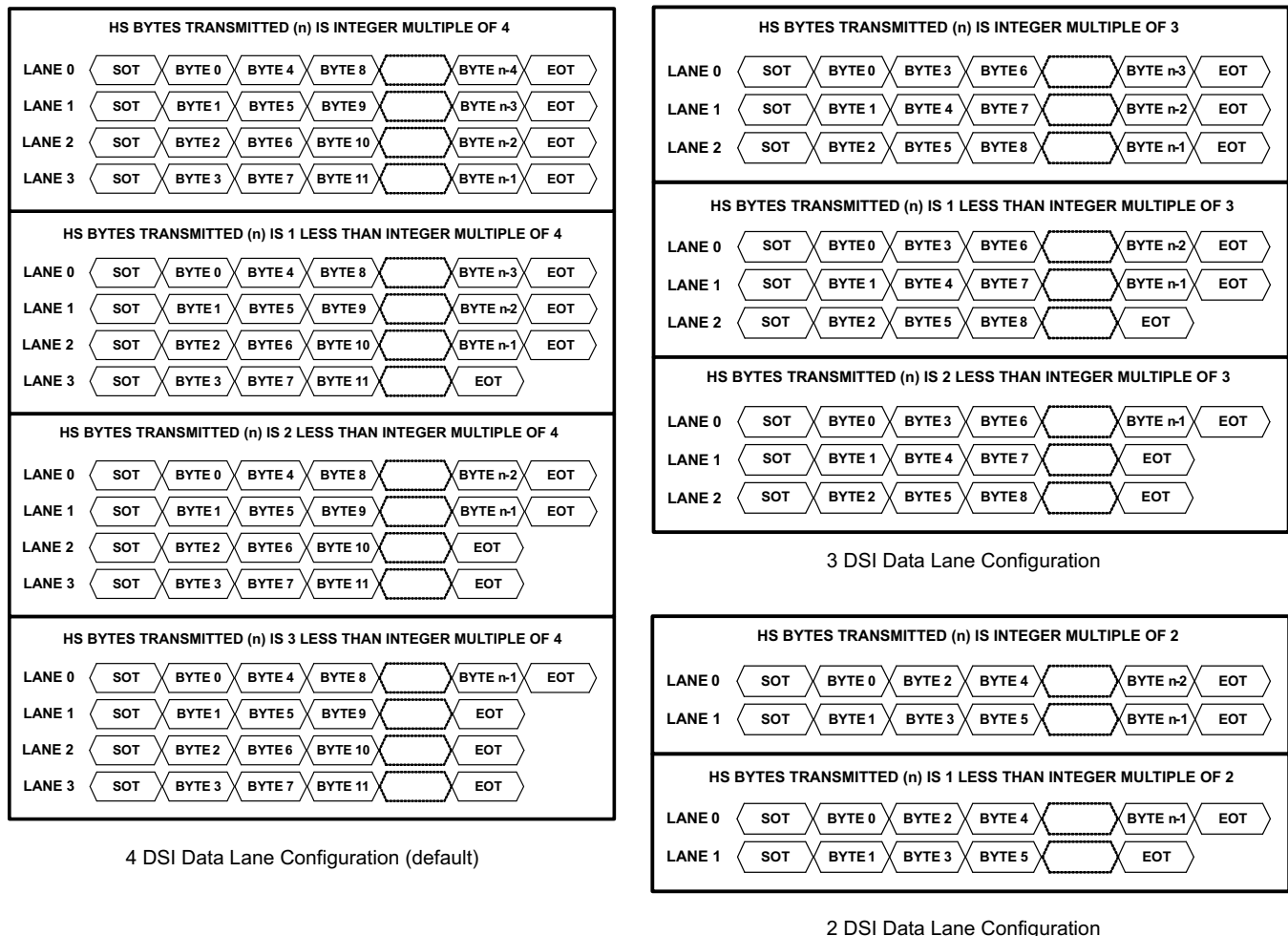

Figure 13. SN65DSI83-Q1 DSI Lane Merging Illustration

8.3.8 DSI Pixel Stream Packets

The SN65DSI83-Q1 processes 18-bpp (RGB666) and 24-bpp (RGB888) DSI packets as shown in Figure 14, Figure 15, and Figure 16.

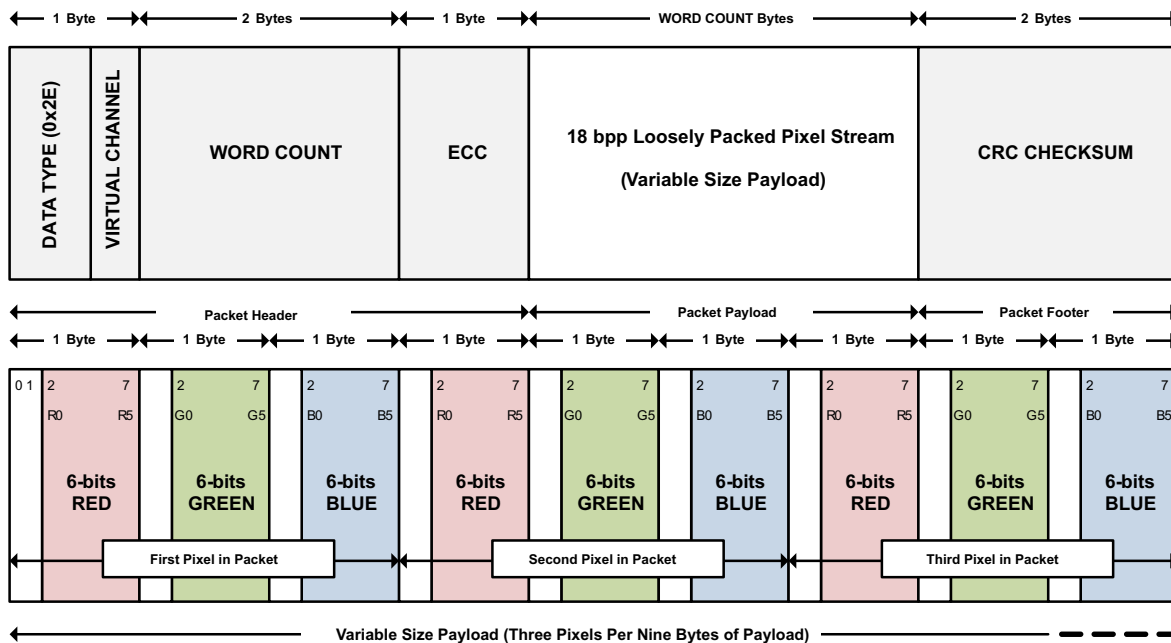

Figure 14. 18-bpp (Loosely Packed) DSI Packet Structure

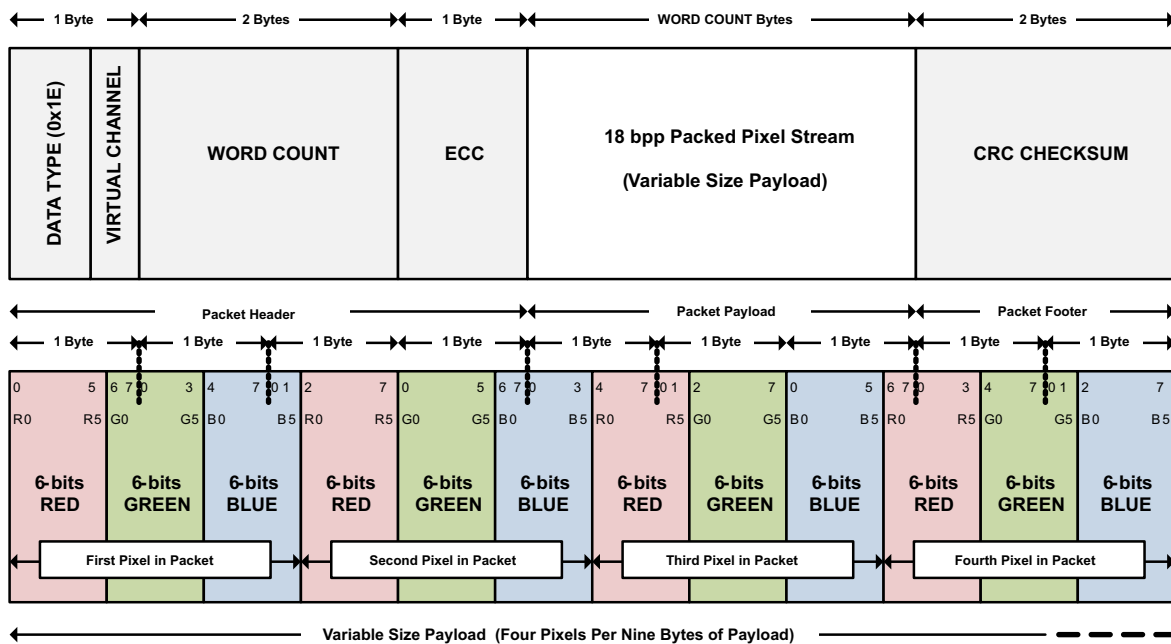

Figure 15. 18-bpp (Tightly Packed) DSI Packet Structure

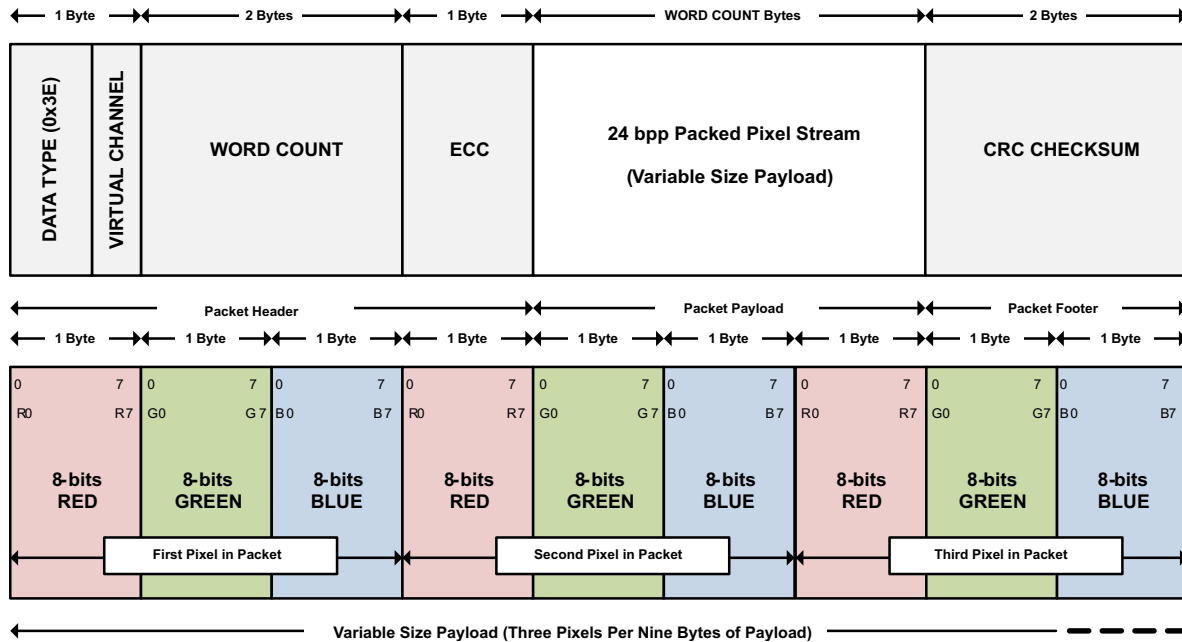

Figure 16. 24-bpp DSI Packet Structure

8.3.9 DSI Video Transmission Specifications

The SN65DSI83-Q1 supports burst video mode and non-burst video mode with sync events or with sync pulses packet transmission as described in the DSI specification. The burst mode supports time-compressed pixel stream packets that leave added time per scan line for power savings LP mode. The SN65DSI83-Q1 requires a transition to LP mode once per frame to enable PHY synchronization with the DSI host processor; however, for a robust and low-power implementation, the transition to LP mode is recommended on every video line.

Figure 17 shows the DSI video transmission applied to SN65DSI83-Q1 applications. In all applications, the LVDS output rate must be less than or equal to the DSI input rate. The first line of a video frame shall start with a VSS packet, and all other lines start with VSE or HSS. The position of the synchronization packets in time is of utmost importance since this has a direct impact on the visual performance of the display panel; that is, these packets generate the HS and VS (horizontal and vertical sync) signals on the LVDS interface after the delay programmed into CHA_SYNC_DELAY_LOW/HIGH (CSR 0x28.7:0 and 0x29.3:0).

As required in the DSI specification, the SN65DSI83-Q1 requires that pixel stream packets contain an integer number of pixels (i.e. end on a pixel boundary); it is recommended to transmit an entire scan line on one pixel stream packet. When a scan line is broken in to multiple packets, inter-packet latency shall be considered such that the video pipeline (ie. pixel queue or partial line buffer) does not run empty (i.e. under-run); during scan line processing, if the pixel queue runs empty, the SNDSI83-Q1 transmits zero data (18'b0 or 24'b0) on the LVDS interface.

NOTE

When the HS clock is used as a source for the LVDS pixel clock, the LP mode transitions apply only to the data lanes, and the DSI clock lane remains in the HS mode during the entire video transmission.

The SN65DSI83-Q1 does not support the DSI Virtual Channel capability or reverse direction (peripheral to processor) transmissions.

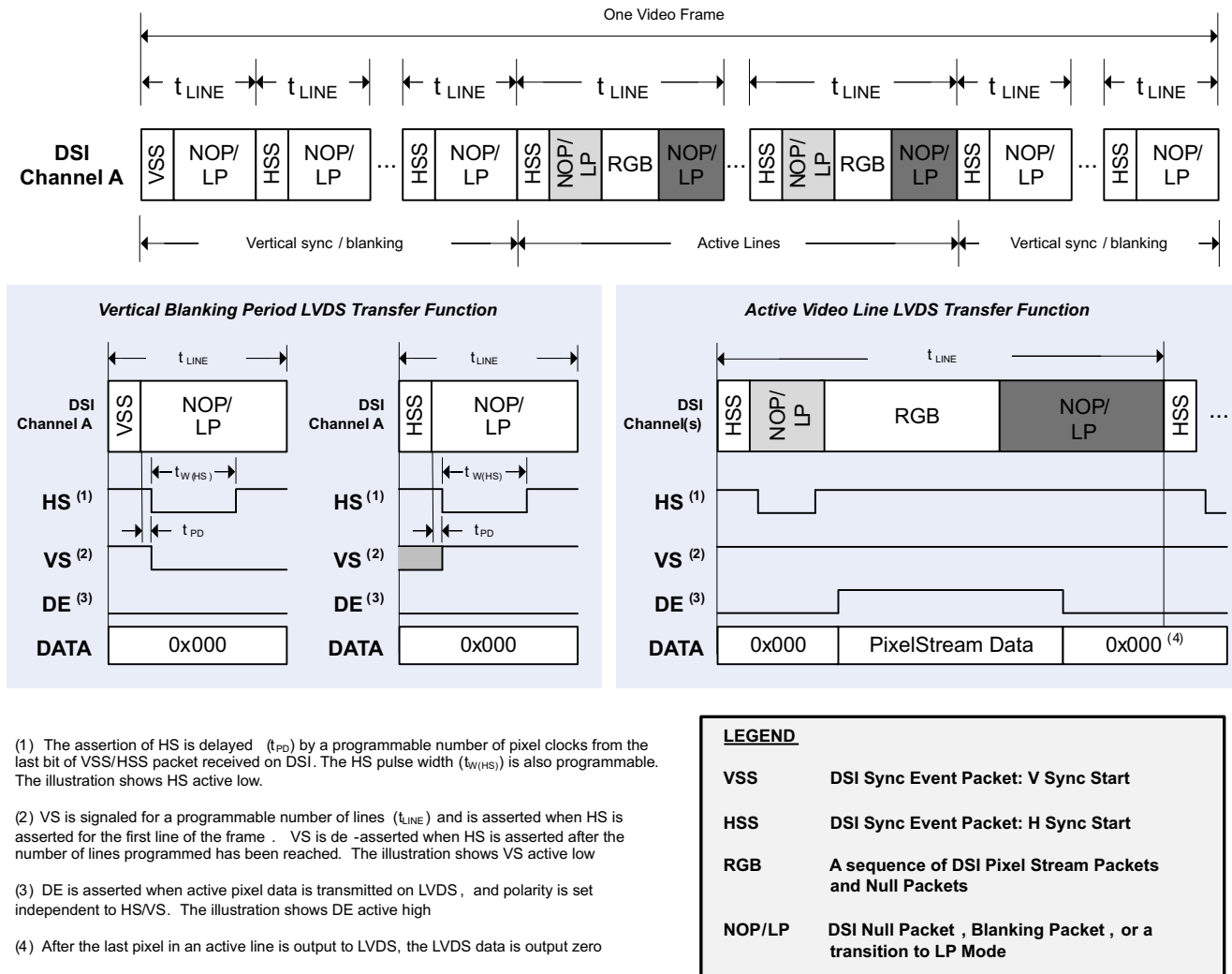

Figure 17. DSI Channel Transmission and Transfer Function

8.4 Programming

8.4.1 Local I²C Interface Overview

The SN65DSI83-Q1 device local I²C interface is enabled when EN is input high, access to the CSR registers is supported during ULPS. The SCL and SDA pins are used for I²C clock and I²C data respectively. The SN65DSI83-Q1 device I²C interface conforms to the 2-wire serial interface defined by the I²C Bus Specification, Version 2.1 (January 2000) and supports fast mode transfers up to 400 kbps.

The device address byte is the first byte received following the start condition from the master device. The 7-bit device address for SN65DSI83-Q1 device is factory preset to 010110X with the least significant bit being determined by the ADDR control input. Table 3 clarifies the SN65DSI83-Q1 device target address.

Table 3. SN65DSI83-Q1 I²C Target Address Description (1)(2)

BIT 7 (MSB)	BIT 6	BIT 5	BIT 4	BIT 3	BIT 2	BIT 1	BIT 0 (W/R)
0	1	0	1	1	0	ADDR	0/1

(1) When ADDR = 1, Address cycle is 0x5A (write) and 0x5B (read)

(2) When ADDR = 0, Address cycle is 0x58 (write) and 0x59 (read)

The following procedure is followed to write to the SN65DSI83-Q1 device I²C registers:

1. The master initiates a write operation by generating a start condition (S), followed by the SN65DSI83-Q1 device 7-bit address and a zero-value W/R bit to indicate a write cycle.
2. The SN65DSI83-Q1 device acknowledges the address cycle.
3. The master presents the subaddress (I²C register within SN65DSI83-Q1 device) to be written, consisting of one byte of data, MSB-first.
4. The SN65DSI83-Q1 device acknowledges the subaddress cycle.
5. The master presents the first byte of data to be written to the I²C register.
6. The SN65DSI83-Q1 device acknowledges the byte transfer.
7. The master may continue presenting additional bytes of data to be written, with each byte transfer completing with an acknowledge from the SN65DSI83-Q1 device.
8. The master terminates the write operation by generating a stop condition (P).

The following procedure is followed to read the SN65DSI83-Q1 I²C registers:

1. The master initiates a read operation by generating a start condition (S), followed by the SN65DSI83-Q1 device 7-bit address and a one-value W/R bit to indicate a read cycle.
2. The SN65DSI83-Q1 device acknowledges the address cycle.
3. The SN65DSI83-Q1 device transmits the contents of the memory registers MSB-first starting at register 00h. If a write to the SN65DSI83-Q1 I²C register occurred prior to the read, then the SN65DSI83-Q1 device starts at the subaddress specified in the write.
4. The SN65DSI83-Q1 device waits for either an acknowledge (ACK) or a not-acknowledge (NACK) from the master after each byte transfer; the I²C master acknowledges reception of each data byte transfer.
5. If an ACK is received, the SN65DSI83-Q1 device transmits the next byte of data.
6. The master terminates the read operation by generating a stop condition (P).

The following procedure is followed for setting a starting subaddress for I²C reads:

1. The master initiates a write operation by generating a start condition (S), followed by the SN65DSI83-Q1 device 7-bit address and a zero-value W/R bit to indicate a write cycle.
2. The SN65DSI83-Q1 device acknowledges the address cycle.
3. The master presents the subaddress (I²C register within the SN65DSI83-Q1 device) to be written, consisting of one byte of data, MSB first.
4. The SN65DSI83-Q1 device acknowledges the subaddress cycle.
5. The master terminates the write operation by generating a stop condition (P).

8.5 Register Maps

8.5.1 Control and Status Registers Overview

Many of the SN65DSI83-Q1 functions are controlled by the Control and Status Registers (CSR). All CSR registers are accessible through the local I²C interface.

See the following tables for the SN65DSI83-Q1 CSR descriptions. Reserved or undefined bit fields should not be modified. Otherwise, the device may operate incorrectly.

8.5.1.1 CSR Bit Field Definitions – ID Registers

8.5.1.1.1 Registers 0x00 – 0x08

Figure 18. Registers 0x00 – 0x08

7	6	5	4	3	2	1	0
Reserved							
R							

LEGEND: R/W = Read/Write; R = Read only; -n = value after reset

Table 4. Registers 0x00 – 0x08 Field Descriptions

Bit	Field	Type	Reset	Description
7-0	Reserved	R		Reserved Addresses 0x08 - 0x00 = {0x01, 0x20, 0x20, 0x20, 0x44, 0x53, 0x49, 0x38, 0x35}

8.5.1.2 CSR Bit Field Definitions – Reset and Clock Registers

8.5.1.2.1 Register 0x09

Figure 19. Register 0x09

7	6	5	4	3	2	1	0
Reserved							SOFT_RESET
R							W

LEGEND: R/W = Read/Write; R = Read only; -n = value after reset

Table 5. Register 0x09 Field Descriptions

Bit	Field	Type	Reset	Description
7-1	Reserved	R		Reserved
0	SOFT_RESET	W	0	This bit automatically clears when set to '1' and returns zeros when read. This bit must be set after the CSR's are updated. This bit must also be set after making any changes to the DIS clock rate or after changing between DSI burst and non-burst modes. 0 – No action (default) 1 – Reset device to default condition excluding the CSR bits.

8.5.1.2.2 Register 0x0A
Figure 20. Register 0x0A

7	6	5	4	3	2	1	0
PLL_EN_STAT	Reserved			LVDS_CLK_RANGE			HS_CLK_SRC
R	R			R/W			R/W

LEGEND: R/W = Read/Write; R = Read only; -n = value after reset

Table 6. Register 0x0A Field Descriptions

Bit	Field	Type	Reset	Description
7	PLL_EN_STAT	R	0	0 – PLL not enabled (default) 1 – PLL enabled Note: After PLL_EN_STAT = 1, wait at least 3ms for PLL to lock.
6-4	Reserved	R		
3-1	LVDS_CLK_RANGE	R/W	101	This field selects the frequency range of the LVDS output clock. 000 – 25 MHz ≤ LVDS_CLK < 37.5 MHz 001 – 37.5 MHz ≤ LVDS_CLK < 62.5 MHz 010 – 62.5 MHz ≤ LVDS_CLK < 87.5 MHz 011 – 87.5 MHz ≤ LVDS_CLK < 112.5 MHz 100 – 112.5 MHz ≤ LVDS_CLK < 137.5 MHz 101 – 137.5 MHz ≤ LVDS_CLK ≤ 154 MHz (default) 110 – Reserved 111 – Reserved
0	HS_CLK_SRC	R/W	0	0 – LVDS pixel clock derived from input REFCLK (default) 1 – LVDS pixel clock derived from MIPI D-PHY channel A HS continuous clock

8.5.1.2.3 Register 0x0B
Figure 21. Register 0x0B

7	6	5	4	3	2	1	0
DSI_CLK_DIVIDER					Reserved	REFCLK_MULTIPLIER	
R/W					R	R/W	

LEGEND: R/W = Read/Write; R = Read only; -n = value after reset

Table 7. Register 0x0B Field Descriptions

Bit	Field	Type	Reset	Description
7-3	DSI_CLK_DIVIDER	R/W	00000	When CSR 0x0A.0 = '1', this field controls the divider used to generate the LVDS output clock from the MIPI D-PHY Channel A HS continuous clock. When CSR 0x0A.0 = '0', this field must be programmed to 00000. 00000 – LVDS clock = source clock (default) 00001 – Divide by 2 00010 – Divide by 3 00011 – Divide by 4 • • • 10111 – Divide by 24 11000 – Divide by 25 11001 through 11111 – Reserved
2	Reserved	R		
1-0	REFCLK_MULTIPLIER	R/W	00	When CSR 0x0A.0 = '0', this field controls the multiplier used to generate the LVDS output clock from the input REFCLK. When CSR 0x0A.0 = '1', this field must be programmed to 00. 00 – LVDS clock = source clock (default) 01 – Multiply by 2 10 – Multiply by 3 11 – Multiply by 4

8.5.1.2.4 Register 0x0D
Figure 22. Register 0x0D

7	6	5	4	3	2	1	0
Reserved							PLL_EN
R							R/W

LEGEND: R/W = Read/Write; R = Read only; -n = value after reset

Table 8. Register 0x0D Field Descriptions

Bit	Field	Type	Reset	Description
7-1	Reserved	R		Reserved
0	PLL_EN	R/W	0	When this bit is set, the PLL is enabled with the settings programmed into CSR 0x0A and CSR 0x0B. The PLL should be disabled before changing any of the settings in CSR 0x0A and CSR 0x0B. The input clock source must be active and stable before the PLL is enabled. 0 – PLL disabled (default) 1 – PLL enabled

8.5.1.3 CSR Bit Field Definitions – DSI Registers
8.5.1.3.1 Register 0x10
Figure 23. Register 0x10

7	6	5	4	3	2	1	0
Reserved			CHA_DSI_LANES		Reserved		SOT_ERR_TO L_DIS
R			R/W		R		

LEGEND: R/W = Read/Write; R = Read only; -n = value after reset

Table 9. Register 0x10 Field Descriptions

Bit	Field	Type	Reset	Description
7-5	Reserved	R		Reserved
4-3	CHA_DSI_LANES	R/W	11	This field controls the number of lanes that are enabled for DSI Channel A. 00 – Four lanes are enabled 01 – Three lanes are enabled 10 – Two lanes are enabled 11 – One lane is enabled (default) Note: Unused DSI input pins on the SN65DSI83-Q1 should be left unconnected.
2-1	Reserved	R		Reserved
0	SOT_ERR_TOL_DIS	R/W	0	0 – Single bit errors are tolerated for the start of transaction SoT leader sequence (default) 1 – No SoT bit errors are tolerated

8.5.1.3.2 Register 0x11
Figure 24. Register 0x11

7	6	5	4	3	2	1	0
CHA_DSI_DATA_EQ		Reserved		CHA_DSI_CLK_EQ		Reserved	
R/W		R		R/W		R	

LEGEND: R/W = Read/Write; R = Read only; -n = value after reset

Table 10. Register 0x11 Field Descriptions

Bit	Field	Type	Reset	Description
7-6	CHA_DSI_DATA_EQ	R/W	00	This field controls the equalization for the DSI Channel A Data Lanes 00 – No equalization (default) 01 – 1 dB equalization 10 – Reserved 11 – 2 dB equalization
5-4	Reserved	R		Reserved
3-2	CHA_DSI_CLK_EQ	R/W	00	This field controls the equalization for the DSI Channel A Clock 00 – No equalization (default) 01 – 1 dB equalization 10 – Reserved 11 – 2 dB equalization
1-0	Reserved	R		Reserved

8.5.1.3.3 Register 0x12
Figure 25. Register 0x12

7	6	5	4	3	2	1	0
CHA_DSI_CLK_RANGE							
R/W							

LEGEND: R/W = Read/Write; R = Read only; -n = value after reset

Table 11. Register 0x12 Field Descriptions

Bit	Field	Type	Reset	Description
7-0	CHA_DSI_CLK_RANGE	R/W	0	This field specifies the DSI Clock frequency range in 5 MHz increments for the DSI Channel A Clock 0x00 through 0x07 – Reserved 0x08 – 40 ≤ frequency < 45 MHz 0x09 – 45 ≤ frequency < 50 MHz ... 0x63 – 495 ≤ frequency < 500 MHz 0x64 – 500 MHz 0x65 through 0xFF – Reserved

8.5.1.4 CSR Bit Field Definitions – LVDS Registers

8.5.1.4.1 Register 0x18

Figure 26. Register 0x18

7	6	5	4	3	2	1	0
DE_NEG_POLARITY	HS_NEG_POLARITY	VS_NEG_POLARITY	Reserved	CHA_24BPP_MODE	Reserved	CHA_24BPP_FORMAT1	Reserved
R/W	R/W	R/W	R	R/W	R	R/W	R

LEGEND: R/W = Read/Write; R = Read only; -n = value after reset

Table 12. Register 0x18 Field Descriptions

Bit	Field	Type	Reset	Description
7	DE_NEG_POLARITY	R/W	0	0 – DE is positive polarity driven '1' during active pixel transmission on LVDS (default) 1 – DE is negative polarity driven '0' during active pixel transmission on LVDS
6	HS_NEG_POLARITY	R/W	1	0 – HS is positive polarity driven '1' during corresponding sync conditions 1 – HS is negative polarity driven '0' during corresponding sync (default)
5	VS_NEG_POLARITY	R/W	1	0 – VS is positive polarity driven '1' during corresponding sync conditions 1 – VS is negative polarity driven '0' during corresponding sync (default)
4	Reserved	R		Reserved. Do not write to this field. Must remain at default.
3	CHA_24BPP_MODE	R/W	0	0 – Force 18bpp; LVDS channel A lane 4 (A_Y3P/N) is disabled (default) 1 – Force 24bpp; LVDS channel A lane 4 (B_Y3P/N) is enabled
2	Reserved	R		Reserved. Do not write to this field. Must remain at default.
1	CHA_24BPP_FORMAT1	R/W	0	This field selects the 24bpp data format 0 – LVDS channel A lane A_Y3P/N transmits the 2 most significant bits (MSB) per color; Format 2 (default) 1 – LVDS channel B lane A_Y3P/N transmits the 2 least significant bits (LSB) per color; Format 1 Note1: This field must be '0' when 18bpp data is received from DSI. Note2: If this field is set to '1' and CHA_24BPP_MODE is '0', the SN65DSI83-Q1 will convert 24bpp data to 18bpp data for transmission to an 18bpp panel. In this configuration, the SN65DSI83-Q1 will not transmit the 2 LSB per color on LVDS channel A, because LVDS channel A lane A_Y3P/N is disabled.
0	Reserved	R		Reserved. Do not write to this field. Must remain at default.

8.5.1.4.2 Register 0x19

Figure 27. Register 0x19

7	6	5	4	3	2	1	0
Reserved	CHA_LVDS_VOCM	Reserved	Reserved	CHA_LVDS_VOD_SWING	Reserved	Reserved	Reserved
R	R/W	R	R	R/W	R	R	R

LEGEND: R/W = Read/Write; R = Read only; -n = value after reset

Table 13. Register 0x19 Field Descriptions

Bit	Field	Type	Reset	Description
7	Reserved	R		Reserved. Do not write to this filed. Must remain at default.
6	CHA_LVDS_VOVM	R/W	0	This field controls the common mode output voltage for LVDS Channel A 0 – 1.2V (default) 1 – 0.9V (CSR 0x1B.5:4 CHA_LVDS_CM_ADJUST must be set to '01b')
5-4	Reserved	R		Reserved. Do not write to this filed. Must remain at default.
3-2	CHA_LVDS_VOD_SWING	R/W	01	This field controls the differential output voltage for LVDS Channel A. See the Electrical Characteristics table for V _{OD} for each setting: 00, 01 (default), 10, 11.
1-0	Reserved	R		Reserved. Do not write to this filed. Must remain at default.

8.5.1.4.3 Register 0x1A
Figure 28. Register 0x1A

7	6	5	4	3	2	1	0
Reserved		CHA_REVERSE_LVDS		Reserved		CHA_LVDS_TERM	Reserved
R		R/W		R		R/W	R

LEGEND: R/W = Read/Write; R = Read only; -n = value after reset

Table 14. Register 0x1A Field Descriptions

Bit	Field	Type	Reset	Description
7-6	Reserved	R		Reserved. Do not write to this filed. Must remain at default.
5	CHA_REVERSE_LVDS	R/W	0	This bit controls the order of the LVDS pins for Channel A. 0 – Normal LVDS Channel A pin order. LVDS Channel A pin order is the same as listed in the Terminal Assignments Section. (default) 1 – Reversed LVDS Channel A pin order. LVDS Channel A pin order is remapped as follows: <ul style="list-style-type: none"> • A_Y0P → A_Y3P • A_Y0N → A_Y3N • A_Y1P → A_CLKP • A_Y1N → A_CLKN • A_Y2P → A_Y2P • A_Y2N → A_Y2N • A_CLKP → A_Y1P • A_CLKN → A_Y1N • A_Y3P → A_Y0P • A_Y3N → A_Y0N
4-2	Reserved	R		Reserved. Do not write to this filed. Must remain at default.
1	CHA_LVDS_TERM	R/W	1	This bit controls the near end differential termination for LVDS Channel A. This bit also affects the output voltage for LVDS Channel A. 0 – 100Ω differential termination 1 – 200Ω differential termination (default)
0	Reserved	R		Reserved. Do not write to this filed. Must remain at default.

8.5.1.4.4 Register 0x1B
Figure 29. Register 0x1B

7	6	5	4	3	2	1	0
Reserved		CHA_LVDS_CM_ADJUST		Reserved			
R		R/W		R			

LEGEND: R/W = Read/Write; R = Read only; -n = value after reset

Table 15. Register 0x1B Field Descriptions

Bit	Field	Type	Reset	Description
7-6	Reserved	R		Reserved
5-4	CHA_LVDS_CM_ADJUST	R/W	00	This field can be used to adjust the common mode output voltage for LVDS Channel A. 00 – No change to common mode voltage (default) 01 – Adjust common mode voltage down 3% 10 – Adjust common mode voltage up 3% 11 – Adjust common mode voltage up 6%
3-0	Reserved	R		Reserved

Note for all video registers:

1. TEST PATTERN GENERATION PURPOSE ONLY registers are for test pattern generation use only. Others are for normal operation unless the test pattern generation feature is enabled.

8.5.1.5 CSR Bit Field Definitions – Video Registers
8.5.1.5.1 Register 0x20
Figure 30. Register 0x20

7	6	5	4	3	2	1	0
CHA_ACTIVE_LINE_LENGTH_LOW							
R/W							

LEGEND: R/W = Read/Write; R = Read only; -n = value after reset

Table 16. Register 0x20 Field Descriptions

Bit	Field	Type	Reset	Description
7-0	CHA_ACTIVE_LINE_LENGTH_LO W	R/W	0	This field controls the length in pixels of the active horizontal line line that are received on DSI Channel A and output to LVDS Channel A in single LVDS Channel mode(CSR 0x18.4=1), Channel A and B in dual LVDS Channel mode(CSR 0x18.4=0). The value in this field is the lower 8 bits of the 12-bit value for the horizontal line length.

8.5.1.5.2 Register 0x21
Figure 31. Register 0x21

7	6	5	4	3	2	1	0
Reserved				CHA_ACTIVE_LINE_LENGTH_HIGH			
R				R/W			

LEGEND: R/W = Read/Write; R = Read only; -n = value after reset

Table 17. Register 0x21 Field Descriptions

Bit	Field	Type	Reset	Description
7-4	Reserved	R		Reserved
3-0	CHA_ACTIVE_LINE_LENGTH_HIGH	R/W	0	This field controls the length in pixels of the active horizontal line that are received on DSI Channel A and output to LVDS Channel A in single LVDS Channel mode(CSR 0x18.4=1), Channel A and B in dual LVDS Channel mode(CSR 0x18.4=0). The value in this field is the upper 4 bits of the 12-bit value for the horizontal line length.

8.5.1.5.3 Register 0x24
Figure 32. Register 0x24

7	6	5	4	3	2	1	0
CHA_VERTICAL_DISPLAY_SIZE_LOW							
R/W							

LEGEND: R/W = Read/Write; R = Read only; -n = value after reset

Table 18. Register 0x24 Field Descriptions

Bit	Field	Type	Reset	Description
7-0	CHA_VERTICAL_DISPLAY_SIZE_LOW	R/W	0	TEST PATTERN GENERATION PURPOSE ONLY. This field controls the vertical display size in lines for LVDS Channel A in single LVDS Channel mode(CSR 0x18.4=1), Channel A and B in dual LVDS Channel mode(CSR 0x18.4=0). The value in this field is the lower 8 bits of the 12-bit value for the vertical display size.

8.5.1.5.4 Register 0x25
Figure 33. Register 0x25

7	6	5	4	3	2	1	0
Reserved				CHA_VERTICAL_DISPLAY_SIZE_HIGH			
R				R/W			

LEGEND: R/W = Read/Write; R = Read only; -n = value after reset

Table 19. Register 0x25 Field Descriptions

Bit	Field	Type	Reset	Description
7-4	Reserved	R		Reserved
3-0	CHA_VERTICAL_DISPLAY_SIZE_HIGH	R/W	0	TEST PATTERN GENERATION PURPOSE ONLY. This field controls the vertical display size in lines for LVDS Channel A in single LVDS Channel mode(CSR 0x18.4=1), Channel A and B in dual LVDS Channel mode(CSR 0x18.4=0). The value in this field is the upper 4 bits of the 12-bit value for the vertical display size.

8.5.1.5.5 Register 0x28

Figure 34. Register 0x28

7	6	5	4	3	2	1	0
CHA_SYNC_DELAY_LOW							
R/W							

LEGEND: R/W = Read/Write; R = Read only; -n = value after reset

Table 20. Register 0x28 Field Descriptions

Bit	Field	Type	Reset	Description
7-0	CHA_SYNC_DELAY_LOW	R/W	0	This field controls the delay in pixel clocks from when an HSync or VSync is received on the DSI to when it is transmitted on the LVDS interface for Channel A in single LVDS Channel mode(CSR 0x18.4=1), Channel A and B in dual LVDS Channel mode(CSR 0x18.4=0). The delay specified by this field is in addition to the pipeline and synchronization delays in the SN65DSI83-Q1. The additional delay is approximately 10 pixel clocks. The Sync delay must be programmed to at least 32 pixel clocks to ensure proper operation. The value in this field is the lower 8 bits of the 12-bit value for the Sync delay.

8.5.1.5.6 Register 0x29
Figure 35. Register 0x29

7	6	5	4	3	2	1	0
Reserved				CHA_SYNC_DELAY_HIGH			
R				R/W			

LEGEND: R/W = Read/Write; R = Read only; -n = value after reset

Table 21. Register 0x29 Field Descriptions

Bit	Field	Type	Reset	Description
7-4	Reserved	R		Reserved
3-0	CHA_SYNC_DELAY_HIGH	R/W	0	This field controls the delay in pixel clocks from when an HSync or VSync is received on the DSI to when it is transmitted on the LVDS interface for Channel A in single LVDS Channel mode(CSR 0x18.4=1), Channel A and B in dual LVDS Channel mode(CSR 0x18.4=0). The delay specified by this field is in addition to the pipeline and synchronization delays in the SN65DSI83-Q1. The additional delay is approximately 10 pixel clocks. The Sync delay must be programmed to at least 32 pixel clocks to ensure proper operation. The value in this field is the upper 4 bits of the 12-bit value for the Sync delay.

8.5.1.5.7 Register 0x2C
Figure 36. Register 0x2C

7	6	5	4	3	2	1	0
CHA_HSYNC_PULSE_WIDTH_LOW							
R/W							

LEGEND: R/W = Read/Write; R = Read only; -n = value after reset

Table 22. Register 0x2C Field Descriptions

Bit	Field	Type	Reset	Description
7-0	CHA_HSYNC_PULSE_WIDTH_LO W	R/W	0	This field controls the width in pixel clocks of the HSync Pulse Width for LVDS Channel A in single LVDS Channel mode(CSR 0x18.4=1), Channel A and B in dual LVDS Channel mode(CSR 0x18.4=0). The value in this field is the lower 8 bits of the 10-bit value for the HSync Pulse Width.

8.5.1.5.8 Register 0x2D
Figure 37. Register 0x2D

7	6	5	4	3	2	1	0
Reserved						CHA_HSYNC_PULSE_WIDTH_HIGH	
R						R/W	

LEGEND: R/W = Read/Write; R = Read only; -n = value after reset

Table 23. Register 0x2D Field Descriptions

Bit	Field	Type	Reset	Description
7-2	Reserved	R		Reserved
1-0	CHA_HSYNC_PULSE_WIDTH_HIGH	R/W	0	This field controls the width in pixel clocks of the HSync Pulse Width for LVDS Channel A in single LVDS Channel mode(CSR 0x18.4=1), Channel A and B in dual LVDS Channel mode(CSR 0x18.4=0). The value in this field is the upper 2 bits of the 10-bit value for the HSync Pulse Width.

8.5.1.5.9 Register 0x30
Figure 38. Register 0x30

7	6	5	4	3	2	1	0
CHA_VSYNC_PULSE_WIDTH_LOW							
R/W							

LEGEND: R/W = Read/Write; R = Read only; -n = value after reset

Table 24. Register 0x30 Field Descriptions

Bit	Field	Type	Reset	Description
7-0	CHA_VSYNC_PULSE_WIDTH_LOW	R/W	0	This field controls the length in lines of the VSync Pulse Width for LVDS Channel A in single LVDS Channel mode(CSR 0x18.4=1), Channel A and B in dual LVDS Channel mode(CSR 0x18.4=0). The value in this field is the lower 8 bits of the 10-bit value for the VSync Pulse Width.

8.5.1.5.10 Register 0x31
Figure 39. Register 0x31

7	6	5	4	3	2	1	0
Reserved						CHA_VSYNC_PULSE_WIDTH_HIGH	
R						R/W	

LEGEND: R/W = Read/Write; R = Read only; -n = value after reset

Table 25. Register 0x31 Field Descriptions

Bit	Field	Type	Reset	Description
7-2	Reserved	R		Reserved
1-0	CHA_VSYNC_PULSE_WIDTH_HIGH	R/W	0	This field controls the length in lines of the VSync Pulse Width for LVDS Channel A in single LVDS Channel mode(CSR 0x18.4=1), Channel A and B in dual LVDS Channel mode(CSR 0x18.4=0). The value in this field is the upper 2 bits of the 10-bit value for the VSync Pulse Width.

8.5.1.5.11 Register 0x34

Figure 40. Register 0x34

7	6	5	4	3	2	1	0
CHA_HORIZONTAL_BACK_PORCH							
R/W							

LEGEND: R/W = Read/Write; R = Read only; -n = value after reset

Table 26. Register 0x34 Field Descriptions

Bit	Field	Type	Reset	Description
7-0	CHA_HORIZONTAL_BACK_PORCH	R/W	0	This field controls the time in pixel clocks between the end of the HSync Pulse and the start of the active video data for LVDS Channel A in single LVDS Channel mode(CSR 0x18.4=1), Channel A and B in dual LVDS Channel mode(CSR 0x18.4=0).

8.5.1.5.12 Register 0x36
Figure 41. Register 0x36

7	6	5	4	3	2	1	0
CHA_VERTICAL_BACK_PORCH							
R/W							

LEGEND: R/W = Read/Write; R = Read only; -n = value after reset

Table 27. Register 0x36 Field Descriptions

Bit	Field	Type	Reset	Description
7-0	CHA_VERTICAL_BACK_PORCH	R/W	0	TEST PATTERN GENERATION PURPOSE ONLY. This field controls the number of lines between the end of the VSync Pulse and the start of the active video data for LVDS Channel A in single LVDS Channel mode(CSR 0x18.4=1), Channel A and B in dual LVDS Channel mode(CSR 0x18.4=0).

8.5.1.5.13 Register 0x38
Figure 42. Register 0x38

7	6	5	4	3	2	1	0
CHA_HORIZONTAL_FRONT_PORCH							
R/W							

LEGEND: R/W = Read/Write; R = Read only; -n = value after reset

Table 28. Register 0x38 Field Descriptions

Bit	Field	Type	Reset	Description
7-0	CHA_HORIZONTAL_FRONT_PORCH	R/W	0	TEST PATTERN GENERATION PURPOSE ONLY. This field controls the time in pixel clocks between the end of the active video data and the start of the HSync Pulse for LVDS Channel A in single LVDS Channel mode(CSR 0x18.4=1), Channel A and B in dual LVDS Channel mode(CSR 0x18.4=0).

8.5.1.5.14 Register 0x3A
Figure 43. Register 0x3A

7	6	5	4	3	2	1	0
CHA_VERTICAL_FRONT_PORCH							
R/W							

LEGEND: R/W = Read/Write; R = Read only; -n = value after reset

Table 29. Register 0x3A Field Descriptions

Bit	Field	Type	Reset	Description
7-0	CHA_VERTICAL_FRONT_PORCH	R/W	0	TEST PATTERN GENERATION PURPOSE ONLY. This field controls the number of lines between the end of the active video data and the start of the VSync Pulse for LVDS Channel A in single LVDS Channel mode(CSR 0x18.4=1), Channel A and B in dual LVDS Channel mode(CSR 0x18.4=0).

8.5.1.5.15 Register 0x3C
Figure 44. Register 0x3C

7	6	5	4	3	2	1	0
Reserved			CHA_TEST_P ATTERN	Reserved			
R			R/W	R			

LEGEND: R/W = Read/Write; R = Read only; -n = value after reset

Table 30. Register 0x3C Field Descriptions

Bit	Field	Type	Reset	Description
7-5	Reserved	R		Reserved
4	CHA_TEST_PATTERN	R/W	0	TEST PATTERN GENERATION PURPOSE ONLY. When this bit is set, the SN65DSI83-Q1 will generate a video test pattern based on the values programmed into the Video Registers for LDS Channel A in single LVDS Channel mode(CSR 0x18.4=1), Channel A and B in dual LVDS Channel mode(CSR 0x18.4=0).
3-0	Reserved	R		Reserved

8.5.1.6 CSR Bit Field Definitions – IRQ Registers
8.5.1.6.1 Register 0xE0
Figure 45. Register 0xE0

7	6	5	4	3	2	1	0
Reserved							IRQ_EN
R							R/W

LEGEND: R/W = Read/Write; R = Read only; -n = value after reset

Table 31. Register 0xE0 Field Descriptions

Bit	Field	Type	Reset	Description
7-1	Reserved	R		Reserved
0	IRQ_EN	R/W	0	When enabled by this field, the IRQ output is driven high to communicate IRQ events. 0 – IRQ output is high-impedance (default) 1 – IRQ output is driven high when a bit is set in registers 0xE5 that also has the corresponding IRQ_EN bit set to enable the interrupt condition

8.5.1.6.2 Register 0xE1
Figure 46. Register 0xE1

7	6	5	4	3	2	1	0
CHA_SYNC_ERR_EN	CHA_CRC_ERR_EN	CHA_UNC_EC_C_ERR_EN	CHA_COR_EC_C_ERR_EN	CHA_LLP_ERR_EN	CHA_SOT_BIT_ERR_EN	Reserved	PLL_UNLOCK_EN
R/W	R/W	R/W	R/W	R/W	R/W	R	R/W

LEGEND: R/W = Read/Write; R = Read only; -n = value after reset

Table 32. Register 0xE1 Field Descriptions

Bit	Field	Type	Reset	Description
7	CHA_SYNC_ERR_EN	R/W	0	0 – CHA_SYNC_ERR is masked 1 – CHA_SYNC_ERR is enabled to generate IRQ events
6	CHA_CRC_ERR_EN	R/W	0	0 – CHA_CRC_ERR is masked 1 – CHA_CRC_ERR is enabled to generate IRQ events
5	CHA_UNC_ECC_ERR_EN	R/W	0	0 – CHA_UNC_ECC_ERR is masked 1 – CHA_UNC_ECC_ERR is enabled to generate IRQ events
4	CHA_COR_ECC_ERR_EN	R/W	0	0 – CHA_COR_ECC_ERR is masked 1 – CHA_COR_ECC_ERR is enabled to generate IRQ events
3	CHA_LLP_ERR_EN	R/W	0	0 – CHA_LLP_ERR is masked 1 – CHA_LLP_ERR is enabled to generate IRQ events
2	CHA_SOT_BIT_ERR_EN	R/W	0	0 – CHA_SOT_BIT_ERR is masked 1 – CHA_SOT_BIT_ERR is enabled to generate IRQ events
1	Reserved	R		Reserved
0	PLL_UNLOCK_EN	R/W	0	0 – PLL_UNLOCK is masked 1 – PLL_UNLOCK is enabled to generate IRQ events

8.5.1.6.3 Register 0xE5
Figure 47. Register 0xE5

7	6	5	4	3	2	1	0
CHA_SYNCH_ERR	CHA_CRC_ERR	CHA_UNC_EC_C_ERR	CHA_COR_EC_C_ERR	CHA_LL_P_ERR	CHA_SOT_BIT_ERR	Reserved	PLL_UNLOCK
R/W	R/W	R/W	R/W	R/W	R/W	R	R/W

LEGEND: R/W = Read/Write; R = Read only; -n = value after reset

Table 33. Register 0xE5 Field Descriptions

Bit	Field	Type	Reset	Description
7	CHA_SYNCH_ERR	R/W	0	When the DSI channel A packet processor detects an HS or VS synchronization error, that is, an unexpected sync packet; this bit is set; this bit is cleared by writing a '1' value.
6	CHA_CRC_ERR	R/W	0	When the DSI channel A packet processor detects a data stream CRC error, this bit is set; this bit is cleared by writing a '1' value.
5	CHA_UNC_ECC_ERR	R/W	0	When the DSI channel A packet processor detects an uncorrectable ECC error, this bit is set; this bit is cleared by writing a '1' value.
4	CHA_COR_ECC_ERR	R/W	0	When the DSI channel A packet processor detects a correctable ECC error, this bit is set; this bit is cleared by writing a '1' value.
3	CHA_LL_P_ERR	R/W	0	When the DSI channel A packet processor detects a low level protocol error, this bit is set; this bit is cleared by writing a '1' value. Low level protocol errors include SoT and EoT sync errors, Escape Mode entry command errors, LP transmission sync errors, and false control errors. Lane merge errors are reported by this status condition.
2	CHA_SOT_BIT_ERR	R/W	0	When the DSI channel A packet processor detects an SoT leader sequence bit error, this bit is set; this bit is cleared by writing a '1' value.
1	Reserved	R		Reserved
0	PLL_UNLOCK	R/W	1	This bit is set whenever the PLL Lock status transitions from LOCK to UNLOCK.

9 Application and Implementation

NOTE

Information in the following applications sections is not part of the TI component specification, and TI does not warrant its accuracy or completeness. TI's customers are responsible for determining suitability of components for their purposes. Customers should validate and test their design implementation to confirm system functionality.

9.1 Application Information

The SN65DSI83-Q1 device is primarily targeted for portable applications such as tablets and smart phones that utilize the MIPI DSI video format. The SN65DSI83-Q1 device can be used between a GPU with DSI output and a video panel with LVDS inputs.

9.1.1 Video STOP and Restart Sequence

When the system requires to stop outputting video to the display, TI recommends to use the following sequence for the SN65DSI83-Q1 device:

1. Clear the PLL_EN bit to 0 (CSR 0x0D.0).
2. Stop video streaming on DSI inputs.
3. Drive all DSI data lanes to LP11, but keep the DSI CLK lanes in HS.

When the system is ready to restart the video streaming.

1. Start video streaming on DSI inputs.
2. Set the PLL_EN bit to 1 (CSR 0x0D.0).
3. Wait for minimum of 3 ms.
4. Set the SOFT_RESET bit (0x09.0).

9.1.2 Reverse LVDS Pin Order Option

For ease of PCB routing, the SN65DSI83-Q1 device supports reversing the pin order via configuration register programming. The order of the LVDS pin for LVDS channel A can be reversed by setting the address 0x1A bit 5 CHA_REVERSE_LVDS. See the corresponding register bit definition for details.

9.1.3 IRQ Usage

The SN65DSI83-Q1 device provides an IRQ pin that can be used to indicate when certain errors occur on DSI. The IRQ output is enabled through the IRQ_EN bit (CSR 0xE0.0). The IRQ pin is asserted when an error occurs on DSI, the corresponding error enable bit is set, and the IRQ_EN bit is set. An error is cleared by writing a 1 to the corresponding error status bit.

NOTE

If the SOFT_RESET bit is set while the DSI video stream is active, some of the error status bits may be set.

NOTE

If the DSI video stream is stopped, some of the error status bits may be set. These error status bits must be cleared before restarting the video stream.

NOTE

If the DSI video stream starts before the device is configured, some of the error status bits may be set. TI recommends to start streaming after the device is correctly configured as recommended in the initialization sequence in the [Initialization Sequence](#) section.

9.2 Typical Application

Figure 48 shows a typical application using the SN65DSI83-Q1 device for a single channel DSI receiver to interface a single-channel DSI application processor to an LVDS single-link 18 bit-per-pixel panel supporting 1280 × 800 WXGA resolutions at 60 frames per second.

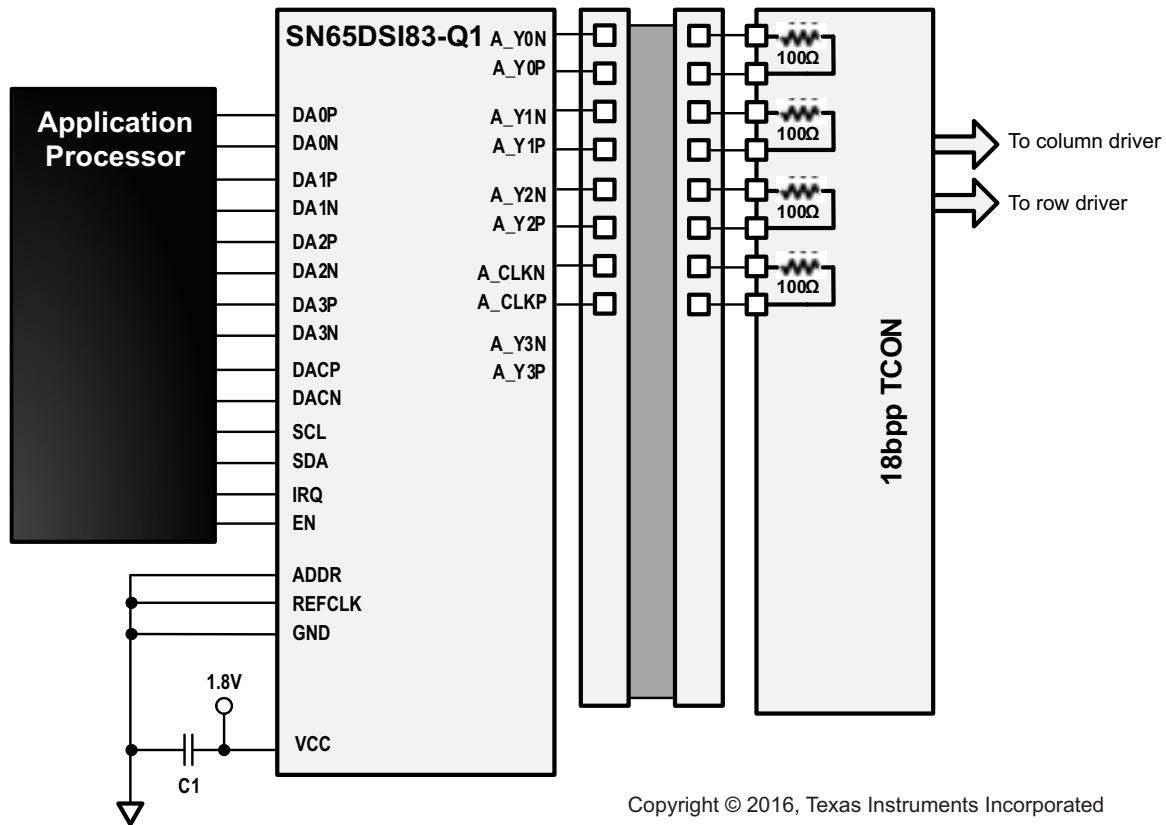

Figure 48. Typical WXGA 18-bpp Panel Application

9.2.1 Design Requirements

Table 34 shows the SN65DSI83-Q1 design parameters.

Table 34. Design Parameters

DESIGN PARAMETERS	EXAMPLE VALUE
VCC	1.8 V (±5%)
Clock source (REFCLK or DSIA_CLK)	DSIA_CLK
REFCKL frequency	N/A
DSIA clock frequency	500 MHz
PANEL INFORMATION	
Pixel clock (MHz)	83 MHz
Horizontal active (pixels)	1280
Horizontal blanking (pixels)	384
Vertical active (lines)	800
Vertical blanking (lines)	30
Horizontal sync offset (pixels)	64
Horizontal sync pulse width (pixels)	128
Vertical sync offset (lines)	3
Vertical sync pulse width (lines)	7

Table 34. Design Parameters (continued)

DESIGN PARAMETERS	EXAMPLE VALUE
PANEL INFORMATION (continued)	
Horizontal sync pulse polarity	Negative
Vertical sync pulse polarity	Negative
Color bit depth (6 bpc or 8 bpc)	6-bit
Number of LVDS lanes	1 × [3 Data Lanes + 1 Clock Lane]
DSI INFORMATION	
Number of DSI lanes	1 × [4 Data Lanes + 1 Clock Lane]
DSI clock frequency(MHz)	500 MHz
Dual DSI configuration(odd/even or left/right)	N/A

9.2.2 Detailed Design Procedure

The video resolution parameters required by the panel need to be programmed into the SN65DSI83-Q1 device. For this example, the parameters programmed are the following:

Horizontal Active = 1280 or 0x500

CHA_ACTIVE_LINE_LENGTH_LOW = 0x00

CHA_ACTIVE_LINE_LENGTH_HIGH = 0x05

Vertical Active = 800 or 0x320

CHA_VERTICAL_DISPLAY_SIZE_LOW = 0x20

CHA_VERTICAL_DISPLAY_SIZE_HIGH = 0x03

Horizontal Pulse Width = 128 or 0x80

CHA_HSYNC_PULSE_WIDTH_LOW = 0x80

CHA_HSYNC_PULSE_WIDTH_HIGH = 0x00

Vertical Pulse Width = 7

CHA_VSYNC_PULSE_WIDTH_LOW = 0x07

CHA_VSYNC_PULSE_WIDTH_HIGH = 0x00

Horizontal Backporch = HorizontalBlanking – (HorizontalSyncOffset + HorizontalSyncPulseWidth)

Horizontal Backporch = 384 – (64 + 128)

Horizontal Backporch = 192 or 0xC0

CHA_HORIZONTAL_BACK_PORCH = 0xC0

Vertical Backporch = VerticalBlanking – (VerticalSyncOffset + VerticalSyncPulseWidth)

Vertical Backporch = 30 – (3 + 7)

Vertical Backporch = 20 or 0x14

CHA_VERTICAL_BACK_PORCH = 0x14

SN65DSI83-Q1

SLLSEW7A – DECEMBER 2016 – REVISED JUNE 2018

www.ti.com

Horizontal Frontporch = HorizontalSyncOffset

Horizontal Frontporch = 64 or 0x40

CHA_HORIZONTAL_FRONT_PORCH = 0x40

Vertical Frontporch = VerticalSyncOffset

Vertical Frontporch = 3

CHA_VERTICAL_FRONT_PORCH = 0x03

The pattern generation feature can be enabled by setting the CHA_TEST_PATTERN bit at address 0x3C and configuring the TEST PATTERN GENERATION PURPOSE ONLY register as shown in [Table 30](#).

LVDS clock is derived from the DSI channel A clock. When the MIPI D-PHY channel A HS clock is used as the LVDS clock source, it is divided by the factor in DSI_CLK_DIVIDER (CSR 0x0B.7:3) to generate the LVDS output clock. Additionally, LVDS_CLK_RANGE (CSR 0x0A.3:1) and CH_DSI_CLK_RANGE (CSR 0x12) must be set to the frequency range of the LVDS output clock and DSI Channel A input clock respectively for the internal PLL to operate correctly. After these settings are programmed, PLL_EN (CSR 0x0D.0) must be set to enable the internal PLL.

LVDS_CLK_RANGE = 2 – 62.5 MHz ≤ LVDS_CLK < 87.5 MHz

HS_CLK_SRC = 1 – LVDS pixel clock derived from MIPI D-PHY channel A

DSI_CLK_DIVIDER = 00101 – Divide by 6

CHA_DSI_LANES = 00 – Four lanes are enabled

CHA_DSI_CLK_RANGE = 0x64 – 500 MHz

9.2.2.1 Example Script

This example configures the SN65DSI83-Q1 device for the following configuration:

```

<aardvark>
<configure i2c="1" spi="1" gpio="0" tpower="1" pullups="1"/>
<i2c_bitrate khz="100"/>

=====SOFTRESET=====
<i2c_write addr="0x2D" count="1" radix="16">09 01</i2c_write> <sleep ms="10"/>

=====PLL_EN(bit 0) - Enable LAST after addr 0A and 0B configured=====
<i2c_write addr="0x2D" count="1" radix="16">0D 00</i2c_write> <sleep ms="10"/>

=====HS_CLK_SRC bit0===
=====LVDS_CLK_Range bit 3:1=====
<i2c_write addr="0x2D" count="1" radix="16"> 0A 05</i2c_write> <sleep ms="10"/>

=====DSI_CLK_DIVIDER bit7:3=====
=====RefCLK multiplier(bit1:0)=====
=====00 - LVDSclk=source clk, 01 - x2, 10 -x3, 11 - x4=====
<i2c_write addr="0x2D" count="1" radix="16">0B 28</i2c_write> <sleep ms="10"/>

=====DSI Ch Config Left_Right Pixels(bit7 - 0 for A ODD, B EVEN, 1 for the other config)=====
=====DSI Ch Mode(bit6:5) 00 - Dual, 01 - single, 10 - two single =====

=====SOT_ERR_TOL_DIS(bit0)=====
<i2c_write addr="0x2D" count="1" radix="16">10 26</i2c_write> <sleep ms="10"/>

====500M====
<i2c_write addr="0x2D" count="1" radix="16">12 64</i2c_write> <sleep ms="10"/>

=====bit7: DE_Pol, bit6:HS_Pol, bit5:VS_Pol, bit4: LVDS Link Cfg, bit3:CHA 24bpp, bit2: CHB 24bpp,
bit1: CHA 24bpp fmt1, bit0: CHB 24bpp fmt1=====
<i2c_write addr="0x2D" count="1" radix="16">18 72</i2c_write> <sleep ms="10"/>
<i2c_write addr="0x2D" count="1" radix="16">19 00</i2c_write> <sleep ms="10"/>

=====CHA_LINE_LENGTH_LOW=====
<i2c_write addr="0x2D" count="1" radix="16">20 00</i2c_write> <sleep ms="10"/>

=====CHA_LINE_LENGTH_HIGH=====
<i2c_write addr="0x2D" count="1" radix="16">21 05</i2c_write> <sleep ms="10"/>

=====CHA_VERTICAL_DISPLAY_SIZE_LOW=====
<i2c_write addr="0x2D" count="1" radix="16">24 00</i2c_write> <sleep ms="10"/>

=====CHA_VERTICAL_DISPLAY_SIZE_HIGH=====
<i2c_write addr="0x2D" count="1" radix="16">25 04</i2c_write> <sleep ms="10"/>

=====CHA_SYNC_DELAY_LOW=====
<i2c_write addr="0x2D" count="1" radix="16">28 20</i2c_write> <sleep ms="10"/>

=====CHA_SYNC_DELAY_HIGH=====
<i2c_write addr="0x2D" count="1" radix="16">29 01</i2c_write> <sleep ms="10"/>

=====CHA_HSYNC_PULSE_WIDTH_LOW=====
<i2c_write addr="0x2D" count="1" radix="16">2C 80</i2c_write> <sleep ms="10"/>

=====CHA_HSYNC_PULSE_WIDTH_HIGH=====
<i2c_write addr="0x2D" count="1" radix="16">2D 00</i2c_write> <sleep ms="10"/>

=====CHA_VSYNC_PULSE_WIDTH_LOW=====
<i2c_write addr="0x2D" count="1" radix="16">30 07</i2c_write> <sleep ms="10"/>

=====CHA_VSYNC_PULSE_WIDTH_HIGH=====
<i2c_write addr="0x2D" count="1" radix="16">31 00</i2c_write> <sleep ms="10"/>

=====CHA_HOR_BACK_PORCH=====
<i2c_write addr="0x2D" count="1" radix="16">34 C0</i2c_write> <sleep ms="10"/>

=====CHA_VER_BACK_PORCH=====
<i2c_write addr="0x2D" count="1" radix="16">36 00</i2c_write> <sleep ms="10"/>

=====CHA_HOR_FRONT_PORCH=====

```

```

<i2c_write addr="0x2D" count="1" radix="16">38 00</i2c_write> <sleep ms="10"/>

=====CHA_VER_FRONT_PORCH=====
<i2c_write addr="0x2D" count="1" radix="16">3A 00</i2c_write> <sleep ms="10"/>

=====CHA/CHB TEST PATTERN(bit4 CHA, bit0 CHB)=====
<i2c_write addr="0x2D" count="1" radix="16">3C 00</i2c_write> <sleep ms="10"/>

=====PLL_EN(bit 0) - Enable LAST after addr 0A and 0B configured=====
<i2c_write addr="0x2D" count="1" radix="16">0D 01</i2c_write> <sleep ms="10"/>

=====Read=====
<i2c_write addr="0x2D" count="1" radix="16">00</i2c_write> <sleep ms="10"/>

=====Read=====
<i2c_write addr="0x2D" count="256" radix="16">00</i2c_write> <sleep ms="10"/>

</aardvark>

```

9.2.3 Application Curve

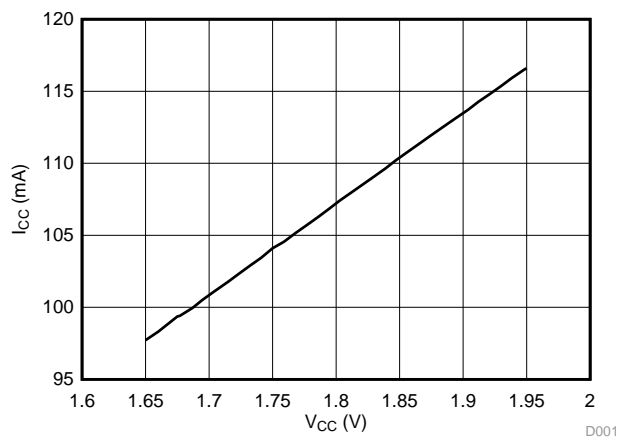

- B. SN65DSI83-Q1: SINGLE Channel DSI to SINGLE Channel DSI, 1280 x 800
 - a. number of LVDS lanes = 3 data lanes + 1 CLK lane
 - b. number of DSI lanes = 4 data lanes + 1 CLK lane
 - c. LVDS CLK OUT = 83 M
 - d. DSI CLK = 500 M
 - e. RGB666, LVDS 18 bpp

Figure 49. Power Consumption

10 Power Supply Recommendations

10.1 V_{CC} Power Supply

Each VCC power supply pin must have a 100-nF capacitor to ground connected as close as possible to the SN65DSI83-Q1 device. It is recommended to have one bulk capacitor (1 μ F to 10 μ F) on it. It is also recommended to have the pins connected to a solid power plane.

10.2 V_{CORE} Power Supply

This pin must have a 100-nF capacitor to ground connected as close as possible to the SN65DSI83-Q1 device. It is recommended to have one bulk capacitor (1 μ F to 10 μ F) on it. It is also recommended to have the pins connected to a solid power plane.

11 Layout

11.1 Layout Guidelines

11.1.1 Package Specific

For the PAP package, to minimize the power supply noise floor, provide good decoupling near the SN65DSI83-Q1 device power pins. The use of four ceramic capacitors (2 \times 0.1 μ F and 2 \times 0.01 μ F) provides good performance. At the least, TI recommends to install one 0.1- μ F and one 0.01- μ F capacitor near the SN65DSI83-Q1 device. To avoid large current loops and trace inductance, the trace length between decoupling capacitor and device power inputs pins must be minimized. Placing the capacitor underneath the SN65DSI83-Q1 device on the bottom of the PCB is often a good choice.

11.1.2 Differential Pairs

- Differential pairs must be routed with controlled 100- Ω differential impedance (\pm 20%) or 50- Ω single-ended impedance (\pm 15%).
- Keep away from other high speed signals
- Keep lengths to within 5 mils of each other.
- Length matching must be near the location of mismatch.
- Each pair must be separated at least by 3 times the signal trace width.
- The use of bends in differential traces must be kept to a minimum. When bends are used, the number of left and right bends must be as equal as possible and the angle of the bend must be \geq 135 degrees. This arrangement minimizes any length mismatch caused by the bends and therefore minimizes the impact that bends have on EMI.
- Route all differential pairs on the same of layer.
- The number of vias must be kept to a minimum. It is recommended to keep the via count to 2 or less.
- Keep traces on layers adjacent to ground plane.
- Do NOT route differential pairs over any plane split.
- Adding Test points cause impedance discontinuity and therefore negatively impacts signal performance. If test points are used, they must be placed in series and symmetrically. They must not be placed in a manner that causes a stub on the differential pair.

11.1.3 Ground

TI recommends that only one board ground plane be used in the design. This provides the best image plane for signal traces running above the plane. The thermal pad of the SN65DSI83-Q1 must be connected to this plane with vias.

SN65DSI83-Q1

SLLSEW7A – DECEMBER 2016 – REVISED JUNE 2018

www.ti.com

11.2 Layout Example

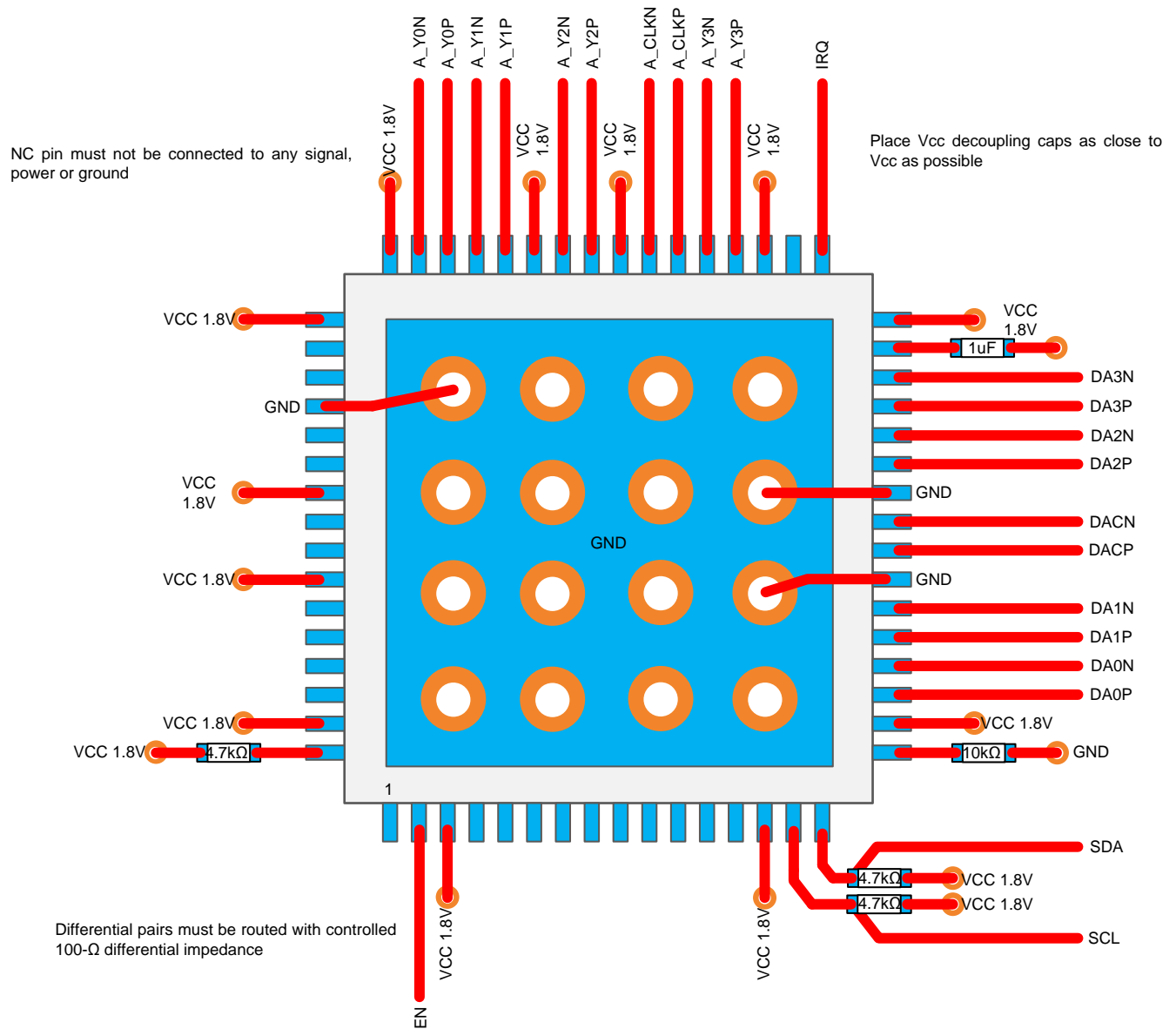

Copyright © 2016, Texas Instruments Incorporated

Figure 50. SN65DSI83-Q1 Layout Example

12 Device and Documentation Support

12.1 Documentation Support

12.1.1 Related Documentation

For related documentation see the following:

- [SN65DSI8x Video Configuration Guide and Configuration Tool Software Users Manual](#)
- [SN65DSI83, SN65DSI84, and SN65DSI85 Hardware Implementation Guide](#)

12.2 Receiving Notification of Documentation Updates

To receive notification of documentation updates, navigate to the device product folder on [ti.com](#). In the upper right corner, click on *Alert me* to register and receive a weekly digest of any product information that has changed. For change details, review the revision history included in any revised document.

12.3 Community Resource

The following links connect to TI community resources. Linked contents are provided "AS IS" by the respective contributors. They do not constitute TI specifications and do not necessarily reflect TI's views; see TI's [Terms of Use](#).

TI E2E™ Online Community *TI's Engineer-to-Engineer (E2E) Community*. Created to foster collaboration among engineers. At [e2e.ti.com](#), you can ask questions, share knowledge, explore ideas and help solve problems with fellow engineers.

Design Support *TI's Design Support* Quickly find helpful E2E forums along with design support tools and contact information for technical support.

12.4 Trademarks

PowerPAD, E2E are trademarks of Texas Instruments.
MIPI is a registered trademark of Arasan Chip Systems, Inc.
All other trademarks are the property of their respective owners.

12.5 Electrostatic Discharge Caution



These devices have limited built-in ESD protection. The leads should be shorted together or the device placed in conductive foam during storage or handling to prevent electrostatic damage to the MOS gates.

12.6 Glossary

[SLYZ022](#) — *TI Glossary*.

This glossary lists and explains terms, acronyms, and definitions.

13 Mechanical, Packaging, and Orderable Information

The following pages include mechanical, packaging, and orderable information. This information is the most current data available for the designated devices. This data is subject to change without notice and revision of this document. For browser-based versions of this data sheet, refer to the left-hand navigation.

PACKAGING INFORMATION

Orderable Device	Status (1)	Package Type	Package Drawing	Pins	Package Qty	Eco Plan (2)	Lead finish/ Ball material (6)	MSL Peak Temp (3)	Op Temp (°C)	Device Marking (4/5)	Samples
SN65DSI83TPAPRQ1	ACTIVE	HTQFP	PAP	64	1000	RoHS & Green	Call TI NIPDAU	Level-3-260C-168 HR	-40 to 105	DSI83TQ1	Samples

(1) The marketing status values are defined as follows:

ACTIVE: Product device recommended for new designs.

LIFEBUY: TI has announced that the device will be discontinued, and a lifetime-buy period is in effect.

NRND: Not recommended for new designs. Device is in production to support existing customers, but TI does not recommend using this part in a new design.

PREVIEW: Device has been announced but is not in production. Samples may or may not be available.

OBSELETE: TI has discontinued the production of the device.

(2) **RoHS:** TI defines "RoHS" to mean semiconductor products that are compliant with the current EU RoHS requirements for all 10 RoHS substances, including the requirement that RoHS substance do not exceed 0.1% by weight in homogeneous materials. Where designed to be soldered at high temperatures, "RoHS" products are suitable for use in specified lead-free processes. TI may reference these types of products as "Pb-Free".

RoHS Exempt: TI defines "RoHS Exempt" to mean products that contain lead but are compliant with EU RoHS pursuant to a specific EU RoHS exemption.

Green: TI defines "Green" to mean the content of Chlorine (Cl) and Bromine (Br) based flame retardants meet JS709B low halogen requirements of <=1000ppm threshold. Antimony trioxide based flame retardants must also meet the <=1000ppm threshold requirement.

(3) MSL, Peak Temp. - The Moisture Sensitivity Level rating according to the JEDEC industry standard classifications, and peak solder temperature.

(4) There may be additional marking, which relates to the logo, the lot trace code information, or the environmental category on the device.

(5) Multiple Device Markings will be inside parentheses. Only one Device Marking contained in parentheses and separated by a "-" will appear on a device. If a line is indented then it is a continuation of the previous line and the two combined represent the entire Device Marking for that device.

(6) Lead finish/Ball material - Orderable Devices may have multiple material finish options. Finish options are separated by a vertical ruled line. Lead finish/Ball material values may wrap to two lines if the finish value exceeds the maximum column width.

Important Information and Disclaimer:The information provided on this page represents TI's knowledge and belief as of the date that it is provided. TI bases its knowledge and belief on information provided by third parties, and makes no representation or warranty as to the accuracy of such information. Efforts are underway to better integrate information from third parties. TI has taken and continues to take reasonable steps to provide representative and accurate information but may not have conducted destructive testing or chemical analysis on incoming materials and chemicals. TI and TI suppliers consider certain information to be proprietary, and thus CAS numbers and other limited information may not be available for release.

In no event shall TI's liability arising out of such information exceed the total purchase price of the TI part(s) at issue in this document sold by TI to Customer on an annual basis.

OTHER QUALIFIED VERSIONS OF SN65DSI83-Q1 :

- Catalog : [SN65DSI83](#)

NOTE: Qualified Version Definitions:

- Catalog - TI's standard catalog product

TAPE AND REEL INFORMATION

QUADRANT ASSIGNMENTS FOR PIN 1 ORIENTATION IN TAPE

*All dimensions are nominal

Device	Package Type	Package Drawing	Pins	SPQ	Reel Diameter (mm)	Reel Width W1 (mm)	A0 (mm)	B0 (mm)	K0 (mm)	P1 (mm)	W (mm)	Pin1 Quadrant
SN65DSI83TPAPRQ1	HTQFP	PAP	64	1000	330.0	24.4	13.0	13.0	1.5	16.0	24.0	Q2

TAPE AND REEL BOX DIMENSIONS

*All dimensions are nominal

Device	Package Type	Package Drawing	Pins	SPQ	Length (mm)	Width (mm)	Height (mm)
SN65DSI83TPAPRQ1	HTQFP	PAP	64	1000	367.0	367.0	55.0

GENERIC PACKAGE VIEW

PAP 64

HTQFP - 1.2 mm max height

10 x 10, 0.5 mm pitch

QUAD FLATPACK

This image is a representation of the package family, actual package may vary.
Refer to the product data sheet for package details.

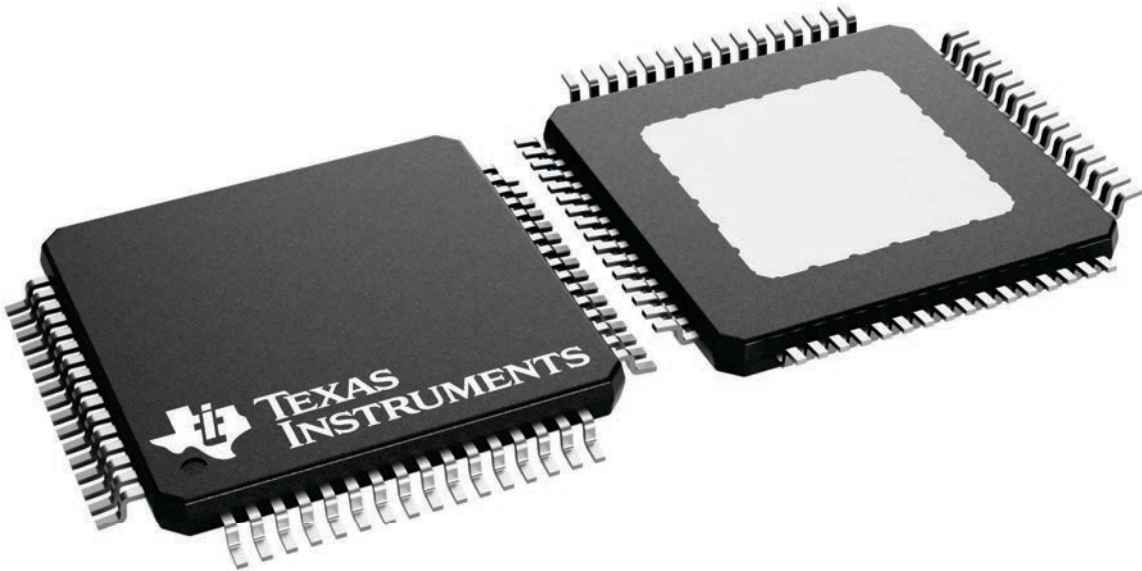

4226442/A

PAP0064Q

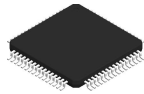

PACKAGE OUTLINE

PowerPAD™ TQFP - 1.2 mm max height

PLASTIC QUAD FLATPACK

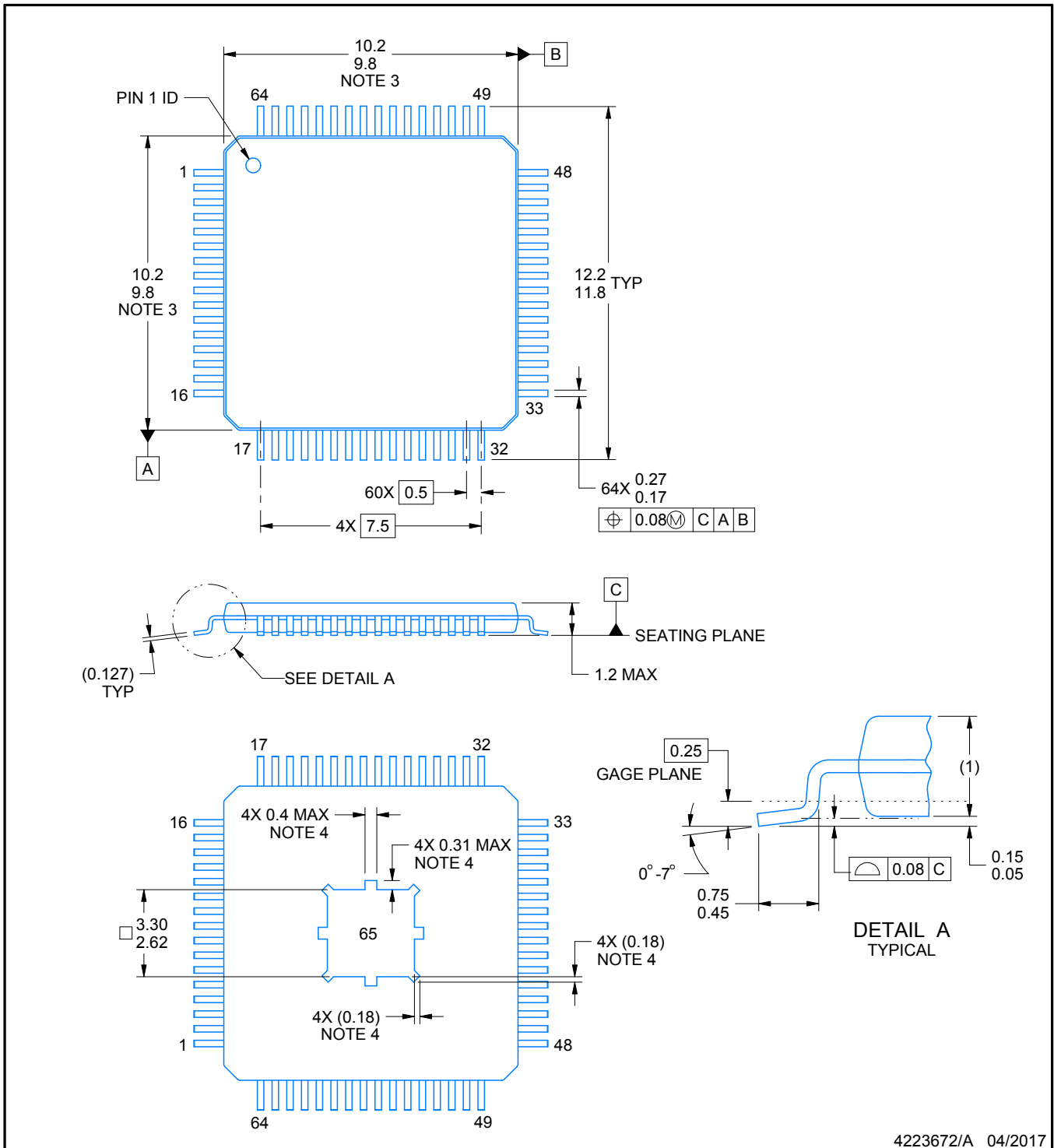

4223672/A 04/2017

NOTES:

PowerPAD is a trademark of Texas Instruments.

1. All linear dimensions are in millimeters. Any dimensions in parenthesis are for reference only. Dimensioning and tolerancing per ASME Y14.5M.
2. This drawing is subject to change without notice.
3. This dimension does not include mold flash, protrusions, or gate burrs.
4. Strap features may not be present.
5. Reference JEDEC registration MS-026.

EXAMPLE BOARD LAYOUT

PAP0064Q

PowerPAD™ TQFP - 1.2 mm max height

PLASTIC QUAD FLATPACK

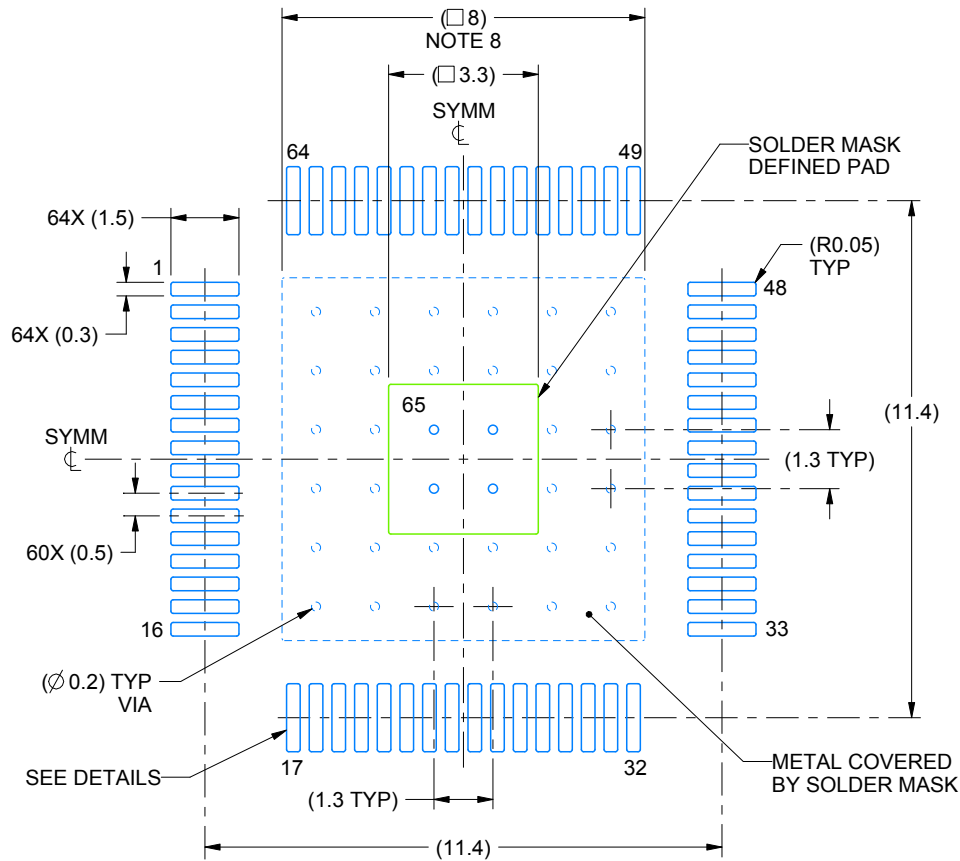

LAND PATTERN EXAMPLE
EXPOSED METAL SHOWN
SCALE:6X

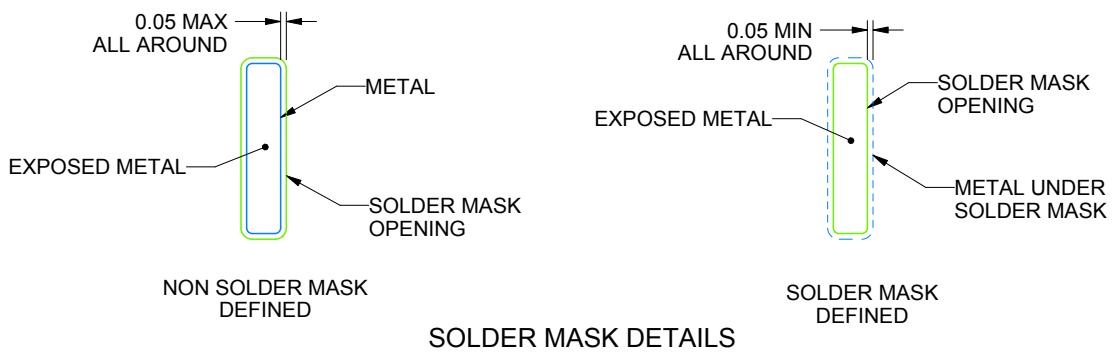

SOLDER MASK DETAILS

4223672/A 04/2017

NOTES: (continued)

6. Publication IPC-7351 may have alternate designs.
7. Solder mask tolerances between and around signal pads can vary based on board fabrication site.
8. This package is designed to be soldered to a thermal pad on the board. See technical brief, Powerpad thermally enhanced package, Texas Instruments Literature No. SLMA002 (www.ti.com/lit/slma002) and SLMA004 (www.ti.com/lit/slma004).
9. Vias are optional depending on application, refer to device data sheet. It is recommended that vias under paste be filled, plugged or tented.
10. Size of metal pad may vary due to creepage requirement.

EXAMPLE STENCIL DESIGN

PAP0064Q

PowerPAD™ TQFP - 1.2 mm max height

PLASTIC QUAD FLATPACK

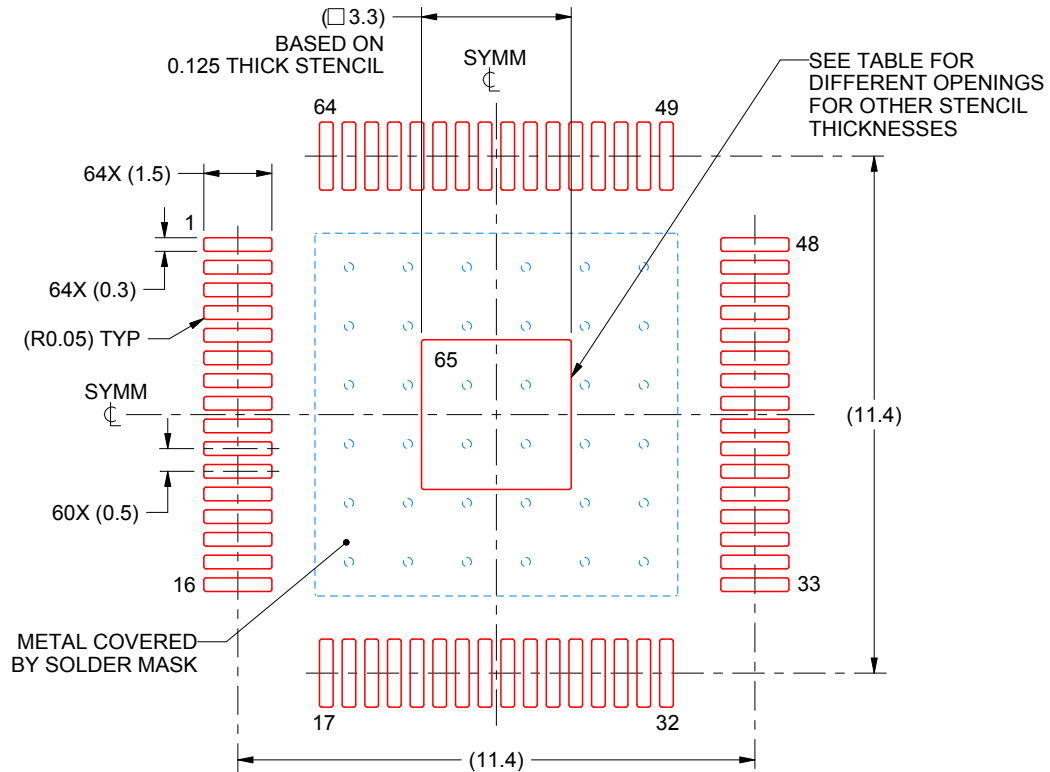

SOLDER PASTE EXAMPLE
 EXPOSED PAD
 100% PRINTED SOLDER COVERAGE BY AREA
 SCALE:6X

STENCIL THICKNESS	SOLDER STENCIL OPENING
0.1	3.69 X 3.69
0.125	3.3 X 3.3 (SHOWN)
0.15	3.01 X 3.01
0.175	2.79 X 2.79

4223672/A 04/2017

NOTES: (continued)

11. Laser cutting apertures with trapezoidal walls and rounded corners may offer better paste release. IPC-7525 may have alternate design recommendations.
12. Board assembly site may have different recommendations for stencil design.

IMPORTANT NOTICE AND DISCLAIMER

TI PROVIDES TECHNICAL AND RELIABILITY DATA (INCLUDING DATA SHEETS), DESIGN RESOURCES (INCLUDING REFERENCE DESIGNS), APPLICATION OR OTHER DESIGN ADVICE, WEB TOOLS, SAFETY INFORMATION, AND OTHER RESOURCES "AS IS" AND WITH ALL FAULTS, AND DISCLAIMS ALL WARRANTIES, EXPRESS AND IMPLIED, INCLUDING WITHOUT LIMITATION ANY IMPLIED WARRANTIES OF MERCHANTABILITY, FITNESS FOR A PARTICULAR PURPOSE OR NON-INFRINGEMENT OF THIRD PARTY INTELLECTUAL PROPERTY RIGHTS.

These resources are intended for skilled developers designing with TI products. You are solely responsible for (1) selecting the appropriate TI products for your application, (2) designing, validating and testing your application, and (3) ensuring your application meets applicable standards, and any other safety, security, regulatory or other requirements.

These resources are subject to change without notice. TI grants you permission to use these resources only for development of an application that uses the TI products described in the resource. Other reproduction and display of these resources is prohibited. No license is granted to any other TI intellectual property right or to any third party intellectual property right. TI disclaims responsibility for, and you will fully indemnify TI and its representatives against, any claims, damages, costs, losses, and liabilities arising out of your use of these resources.

TI's products are provided subject to [TI's Terms of Sale](#) or other applicable terms available either on [ti.com](https://www.ti.com) or provided in conjunction with such TI products. TI's provision of these resources does not expand or otherwise alter TI's applicable warranties or warranty disclaimers for TI products.

TI objects to and rejects any additional or different terms you may have proposed.

Mailing Address: Texas Instruments, Post Office Box 655303, Dallas, Texas 75265
Copyright © 2024, Texas Instruments Incorporated