

## TLV62065 3-MHz 2-A Step-Down Converter in 2 x 2 WSON Package

### 1 Features

- $V_{IN}$  Range from 2.9 V to 5.5 V
- Up to 97% Efficiency
- Power-Save Mode / 3-MHz Fixed PWM Mode
- Output Voltage Accuracy in PWM Mode  $\pm 2.0\%$
- Output Capacitor Discharge Function
- Typical 18- $\mu$ A Quiescent Current
- 100% Duty Cycle for Lowest Dropout
- Available in a 2 mm x 2 mm x 0.75 mm WSON

### 2 Applications

- Point-of-Load (POL)
- Notebooks, Pocket PCs
- Portable Media Players
- Set-Top Boxes

### 3 Description

The TLV62065 device is a high efficiency synchronous step-down DC–DC converter. It provides up to 2-A output current.

With an input voltage range of 2.9 V to 5.5 V, the device is a perfect fit for power conversion from a 5-V or 3.3-V system supply rail. The TLV62065 operates at 3-MHz fixed frequency and enters power-save mode operation at light load currents to maintain high efficiency over the entire load current range. For low noise applications, TLV62065 can be forced into fixed frequency PWM mode by pulling the MODE pin high.

In the shutdown mode, the current consumption is reduced to less than 1  $\mu$ A and an internal circuit discharges the output capacitor.

TLV62065 operates with a 1- $\mu$ H inductor and 10- $\mu$ F output capacitor.

The TLV62065 is available in a small 2 mm x 2 mm x 0.75 mm 8-pin WSON package.

#### Device Information<sup>(1)</sup>

PART NUMBER	PACKAGE	BODY SIZE (NOM)
SLVSAC4	WSON (8)	2.00 mm x 2.00 mm

(1) For all available packages, see the orderable addendum at the end of the data sheet.

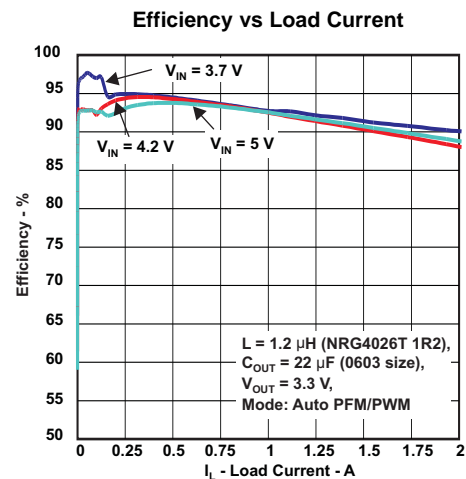
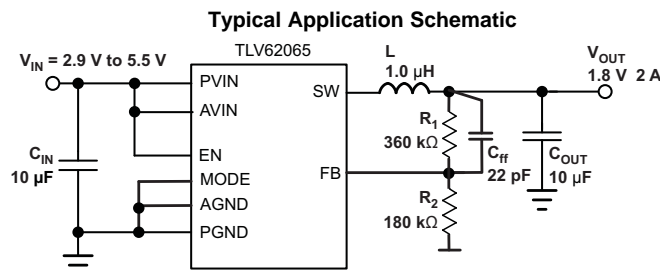

## Table of Contents

<b>1 Features</b> .....	<b>1</b>	7.4 Device Functional Modes.....	<b>8</b>
<b>2 Applications</b> .....	<b>1</b>	<b>8 Application and Implementation</b> .....	<b>11</b>
<b>3 Description</b> .....	<b>1</b>	8.1 Application Information.....	<b>11</b>
<b>4 Revision History</b> .....	<b>2</b>	8.2 Typical Application .....	<b>11</b>
<b>5 Pin Configuration and Functions</b> .....	<b>3</b>	<b>9 Power Supply Recommendations</b> .....	<b>16</b>
<b>6 Specifications</b> .....	<b>4</b>	<b>10 Layout</b> .....	<b>17</b>
6.1 Absolute Maximum Ratings .....	4	10.1 Layout Guidelines .....	17
6.2 ESD Ratings .....	4	10.2 Layout Example .....	17
6.3 Recommended Operating Conditions.....	4	<b>11 Device and Documentation Support</b> .....	<b>18</b>
6.4 Thermal Information .....	4	11.1 Device Support.....	18
6.5 Electrical Characteristics.....	5	11.2 Community Resources.....	18
6.6 Typical Characteristics.....	6	11.3 Trademarks .....	18
<b>7 Detailed Description</b> .....	<b>7</b>	11.4 Electrostatic Discharge Caution.....	18
7.1 Overview .....	7	11.5 Glossary .....	18
7.2 Functional Block Diagram .....	7	<b>12 Mechanical, Packaging, and Orderable</b>	
7.3 Feature Description.....	8	<b>Information</b> .....	<b>18</b>

## 4 Revision History

NOTE: Page numbers for previous revisions may differ from page numbers in the current version.

### Changes from Revision A (July 2012) to Revision B

Page

- Added *ESD Ratings* table, *Feature Description* section, *Device Functional Modes*, *Application and Implementation* section, *Power Supply Recommendations* section, *Layout* section, *Device and Documentation Support* section, and *Mechanical, Packaging, and Orderable Information* section ..... **1**

## 5 Pin Configuration and Functions

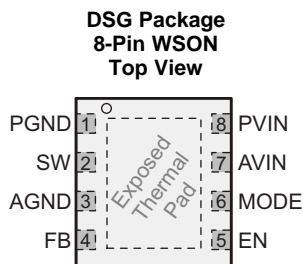

### Pin Functions

PIN		TYPE <sup>(1)</sup>	DESCRIPTION
NAME	NO.		
AGND	3	I	Analog GND supply pin for the control circuit.
AVIN	7	I	Analog $V_{IN}$ power supply for the control circuit. Need to be connected to PVIN and input capacitor.
EN	5	I	This is the enable pin of the device. Pulling this pin to low forces the device into shutdown mode. Pulling this pin to high enables the device. This pin must be terminated
Exposed Thermal Pad	—	—	For good thermal performance, this pad must be soldered to the land pattern on the PCB. This pad should be used as device GND.
FB	4	I	Feedback pin for the internal regulation loop. Connect the external resistor divider to this pin. In case of fixed output voltage option, connect this pin directly to the output capacitor
MODE	6	I	MODE pin = High forces the device to operate in fixed frequency PWM mode. MODE pin = Low enables the power save mode with automatic transition from PFM mode to fixed frequency PWM mode. This pin must be terminated.
PGND	1	P	GND supply pin for the output stage.
PVIN	8	P	$V_{IN}$ power supply pin for the output stage.
SW	2	O	This is the switch pin and is connected to the internal MOSFET switches. Connect the external inductor between this terminal and the output capacitor.

(1) I = Input, O = Output, P = Power

## 6 Specifications

### 6.1 Absolute Maximum Ratings

over operating free-air temperature range (unless otherwise noted)<sup>(1)</sup>

		MIN	MAX	UNIT
Voltage <sup>(2)</sup>	AVIN, PVIN	−0.3	7	V
	EN, MODE, FB	−0.3	$V_{IN} + 0.3 < 7$	V
	SW	−0.3	7	V
Current (source)	Peak output	Internally limited		A
Junction temperature, T <sub>J</sub>		−40	125	°C
Storage temperature, T <sub>stg</sub>		−65	150	°C

- (1) Stresses beyond those listed under *absolute maximum ratings* may cause permanent damage to the device. These are stress ratings only and functional operation of the device at these or any other conditions beyond those indicated under *recommended operating conditions* is not implied. Exposure to absolute-maximum-rated conditions for extended periods may affect device reliability.
- (2) All voltage values are with respect to network ground terminal.

### 6.2 ESD Ratings

		VALUE	UNIT
V <sub>(ESD)</sub> Electrostatic discharge	Human body model (HBM), per ANSI/ESDA/JEDEC JS-001 <sup>(1)</sup>	±2000	V
	Charged-device model (CDM), per JEDEC specification JESD22-C101 <sup>(2)</sup>	±1000	
	Machine model	±200	

- (1) JEDEC document JEP155 states that 500-V HBM allows safe manufacturing with a standard ESD control process.
- (2) JEDEC document JEP157 states that 250-V CDM allows safe manufacturing with a standard ESD control process.

### 6.3 Recommended Operating Conditions

		MIN	NOM	MAX	UNIT
AV <sub>IN</sub> , PV <sub>IN</sub>	Supply voltage	2.9		5.5	V
	Output current capability			2000	mA
	Output voltage range for adjustable voltage	0.8		V <sub>IN</sub>	V
L	Effective inductance	0.7	1	1.6	μH
C <sub>OUT</sub>	Effective output capacitance	4.5	10	22	μF
T <sub>A</sub>	Operating ambient temperature <sup>(1)</sup>	−40		85	°C
T <sub>J</sub>	Operating junction temperature	−40		125	°C

- (1) In applications where high power dissipation and/or poor package thermal resistance is present, the maximum ambient temperature may have to be derated. Maximum ambient temperature (T<sub>A(max)</sub>) is dependent on the maximum operating junction temperature (T<sub>J(max)</sub>), the maximum power dissipation of the device in the application (P<sub>D(max)</sub>), and the junction-to-ambient thermal resistance of the part/package in the application (R<sub>θJA</sub>), as given by the following equation:  $T_{A(max)} = T_{J(max)} - (R_{\theta JA} \times P_{D(max)})$

### 6.4 Thermal Information

THERMAL METRIC <sup>(1)</sup>		TLV62065	UNIT
		DSG (WSON)	
		8 PINS	
R <sub>θJA</sub>	Junction-to-ambient thermal resistance	64.6	°C/W
R <sub>θJC(top)</sub>	Junction-to-case (top) thermal resistance	82.6	°C/W
R <sub>θJB</sub>	Junction-to-board thermal resistance	34.5	°C/W
Ψ <sub>JT</sub>	Junction-to-top characterization parameter	1.8	°C/W
Ψ <sub>JB</sub>	Junction-to-board characterization parameter	34.9	°C/W
R <sub>θJC(bot)</sub>	Junction-to-case (bottom) thermal resistance	6.8	°C/W

- (1) For more information about traditional and new thermal metrics, see the *Semiconductor and IC Package Thermal Metrics* application report, [SPRA953](#).

## 6.5 Electrical Characteristics

Over full operating ambient temperature range. Typical values are at  $T_A = 25^\circ\text{C}$ . Unless otherwise noted, specifications apply for condition  $V_{IN} = EN = 3.6\text{ V}$ . External components  $C_{IN} = 10\ \mu\text{F}$  0603,  $C_{OUT} = 10\ \mu\text{F}$  0603,  $L = 1.0\ \mu\text{H}$  (see the parameter measurement information).

PARAMETER		TEST CONDITIONS	MIN	TYP	MAX	UNIT
<b>SUPPLY</b>						
$V_{IN}$	Input voltage range		2.9		5.5	V
$I_Q$	Operating quiescent current	$I_{OUT} = 0\ \text{mA}$ , device operating in PFM mode and device not switching		18		$\mu\text{A}$
$I_{SD}$	Shutdown current	$EN = \text{GND}$ , current into AVIN and PVIN combined		0.1	1	$\mu\text{A}$
$V_{UVLO}$	Undervoltage lockout threshold	Falling	1.73	1.78	1.83	V
		Rising	1.9	1.95	1.99	
<b>ENABLE, MODE</b>						
$V_{IH}$	High level input voltage	$2.9\ \text{V} \leq V_{IN} \leq 5.5\ \text{V}$	1.0		5.5	V
$V_{IL}$	Low level input voltage	$2.9\ \text{V} \leq V_{IN} \leq 5.5\ \text{V}$	0		0.4	V
$I_{IN}$	Input bias current	$EN$ , Mode tied to GND or AVIN		0.01	1	$\mu\text{A}$
<b>POWER SWITCH</b>						
$R_{DS(on)}$	High-side MOSFET on-resistance	$V_{IN} = 3.6\ \text{V}^{(1)}$		120	180	$\text{m}\Omega$
		$V_{IN} = 5\ \text{V}^{(1)}$		95	150	
$R_{DS(on)}$	Low-side MOSFET on-resistance	$V_{IN} = 3.6\ \text{V}^{(1)}$		90	130	$\text{m}\Omega$
		$V_{IN} = 5\ \text{V}^{(1)}$		75	100	
$I_{LIMF}$	Forward current limit MOSFET high-side and low-side	$3\ \text{V} \leq V_{IN} \leq 3.6\ \text{V}$	2300	2750		mA
$T_{SD}$	Thermal shutdown	Increasing junction temperature		150		$^\circ\text{C}$
	Thermal shutdown hysteresis	Decreasing junction temperature		10		
<b>OSCILLATOR</b>						
$f_{SW}$	Oscillator frequency	$2.9\ \text{V} \leq V_{IN} \leq 5.5\ \text{V}$	2.6	3	3.4	MHz
<b>OUTPUT</b>						
$V_{ref}$	Reference voltage			600		mV
$V_{FB(PWM)}$	Feedback voltage PWM mode	PWM operation, $MODE = V_{IN}$ , $2.9\ \text{V} \leq V_{IN} \leq 5.5\ \text{V}$ , 0 mA load	-2%	0%	2%	
$V_{FB(PFM)}$	Feedback voltage PFM mode, voltage positioning	Device in PFM mode, voltage positioning active <sup>(2)</sup>		1%		
$V_{FB}$	Load regulation			-0.5%		A
	Line regulation			0%		V
$R_{(Discharge)}$	Internal discharge resistor	Activated with $EN = \text{GND}$ , $2.9\ \text{V} \leq V_{IN} \leq 5.5\ \text{V}$ , $0.8 \leq V_{OUT} \leq 3.6\ \text{V}$		200		$\Omega$
$t_{START}$	Start-up time	Time from active EN to reach 95% of $V_{OUT}$		500		$\mu\text{s}$

(1) Maximum value applies for  $T_J = 85^\circ\text{C}$

(2) In PFM mode, the internal reference voltage is set to typ.  $1.01 \times V_{ref}$ . See the parameter measurement information.

## 6.6 Typical Characteristics

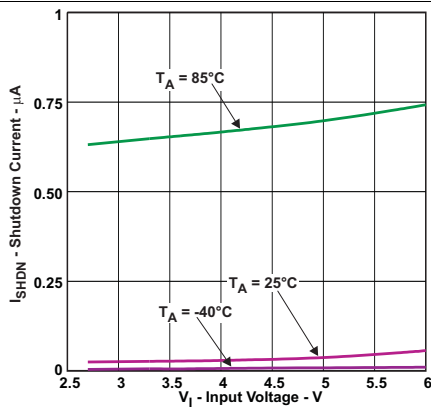

Figure 1. Shutdown Current vs Input Voltage

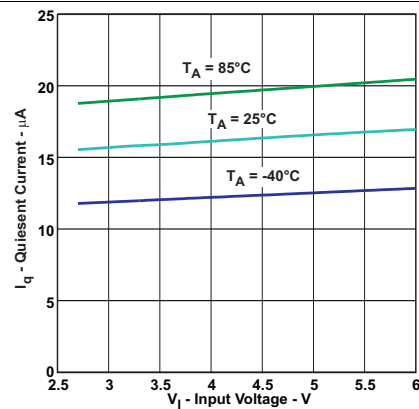

Figure 2. Quiescent Current vs Input Voltage

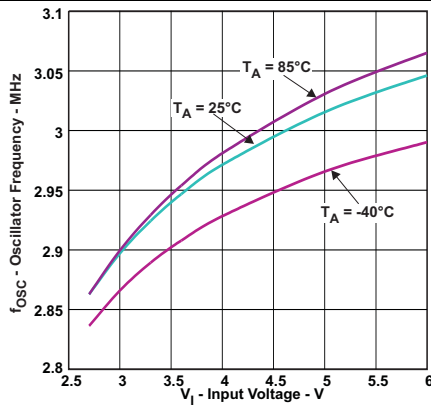

Figure 3. Oscillator Frequency vs Input Voltage

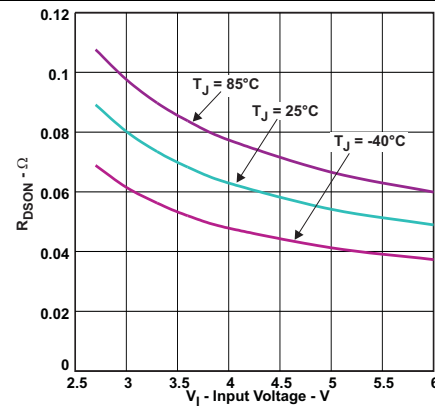

Figure 4.  $R_{DS(on)}$  Low-Side Switch

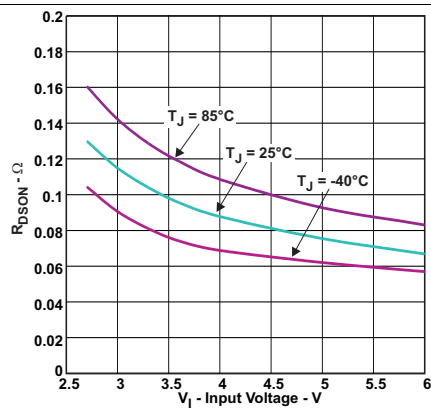

Figure 5.  $R_{DS(on)}$  High-Side Switch

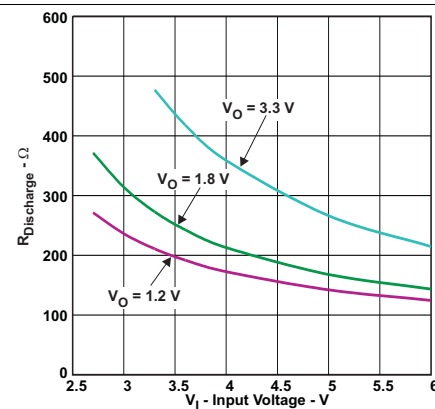

Figure 6.  $R_{Discharge}$  vs Input Voltage

## 7 Detailed Description

### 7.1 Overview

The TLV62065 step-down converter operates with typically 3-MHz fixed frequency pulse width modulation (PWM) at moderate to heavy load currents. At light load currents the converter can automatically enter power-save mode and operates then in pulse frequency modulation (PFM) mode.

During PWM operation, the converter use a unique fast response voltage mode controller scheme with input voltage feed-forward to achieve good line and load regulation allowing the use of small ceramic input and output capacitors. At the beginning of each clock cycle initiated by the clock signal, the high-side MOSFET switch is turned on. The current flows now from the input capacitor through the high-side MOSFET switch through the inductor to the output capacitor and load. During this phase, the current ramps up until the PWM comparator trips and the control logic will turn off the switch. The current limit comparator will also turn off the switch in case the current limit of the high-side MOSFET switch is exceeded. After a dead time preventing shoot through current, the low-side MOSFET rectifier is turned on and the inductor current ramps down. The current flows now from the inductor to the output capacitor and to the load. It returns back to the inductor through the low-side MOSFET rectifier.

The next cycle will be initiated by the clock signal again turning off the low-side MOSFET rectifier and turning on the high-side MOSFET switch.

### 7.2 Functional Block Diagram

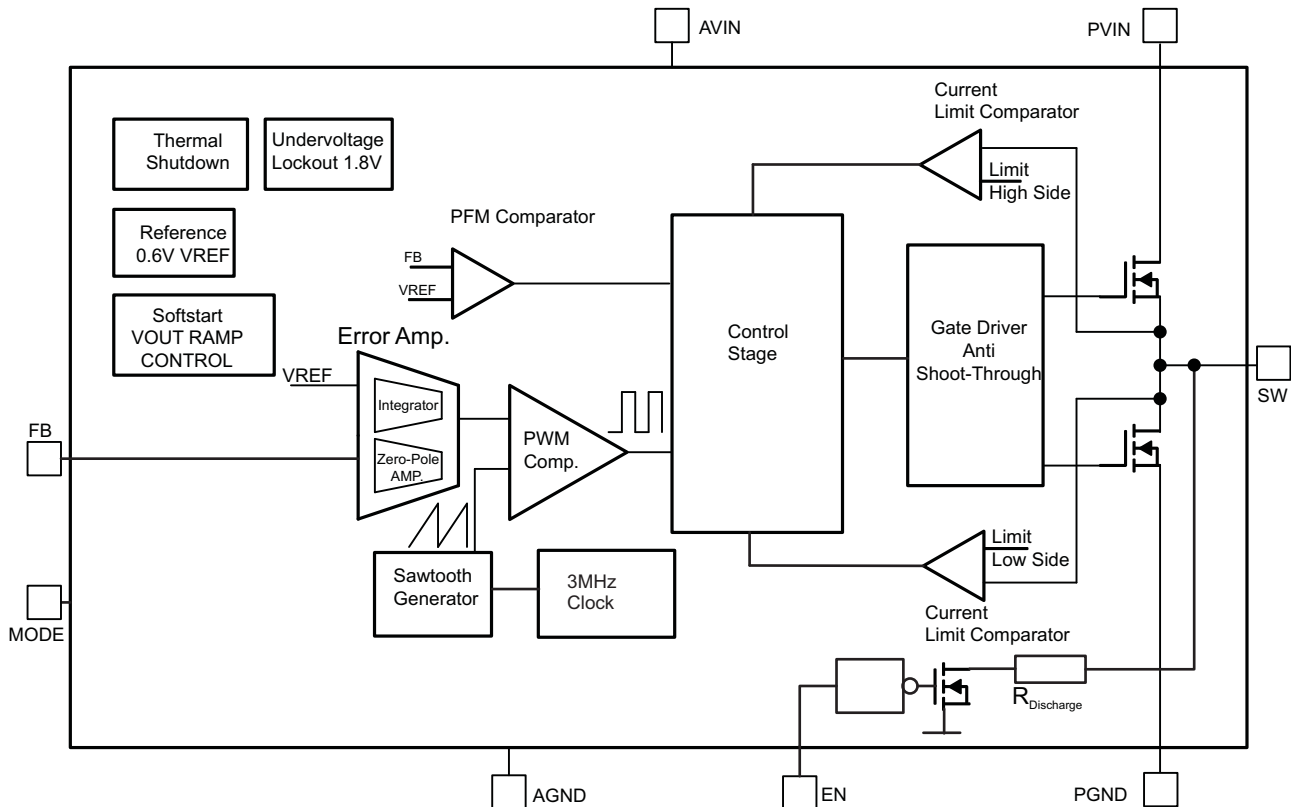

## 7.3 Feature Description

### 7.3.1 Mode Selection

The MODE pin allows mode selection between forced PWM mode and power-save mode.

Connecting this pin to GND enables the power-save mode with automatic transition between PWM and PFM mode. Pulling the MODE pin high forces the converter to operate in fixed frequency PWM mode even at light load currents. This allows simple filtering of the switching frequency for noise-sensitive applications. In this mode, the efficiency is lower compared to the power-save mode during light loads.

The condition of the MODE pin can be changed during operation and allows efficient power management by adjusting the operation mode of the converter to the specific system requirements.

### 7.3.2 Enable

The device is enabled by setting EN pin to high. At first, the internal reference is activated and the internal analog circuits are settled. Afterwards, the soft-start is activated and the output voltage is ramped up. The output voltage reaches 95% of its nominal value within  $t_{\text{START}}$  of typically 500  $\mu\text{s}$  after the device has been enabled. The EN input can be used to control power sequencing in a system with various DC–DC converters. The EN pin can be connected to the output of another converter, to drive the EN pin high and getting a sequencing of supply rails. With EN = GND, the device enters shutdown mode. In this mode, all circuits are disabled and the SW pin is connected to PGND through an internal resistor to discharge the output.

### 7.3.3 Undervoltage Lockout

The undervoltage lockout circuit prevents the device from malfunctioning at low input voltages and from excessive discharge of the battery. It disables the output stage of the converter once the falling  $V_{\text{IN}}$  trips the undervoltage lockout threshold  $V_{\text{UVLO}}$ . The undervoltage lockout threshold  $V_{\text{UVLO}}$  for falling  $V_{\text{IN}}$  is typically 1.78 V. The device starts operation once the rising  $V_{\text{IN}}$  trips the undervoltage lockout threshold  $V_{\text{UVLO}}$  again at typically 1.95 V.

### 7.3.4 Thermal Shutdown

As soon as the junction temperature,  $T_{\text{J}}$ , exceeds 150°C (typical) the device goes into thermal shutdown. In this mode, the high-side and low-side MOSFETs are turned off. The device continues its operation with a soft-start once the junction temperature falls below the thermal shutdown hysteresis.

## 7.4 Device Functional Modes

### 7.4.1 Soft-Start

The TLV62065 has an internal soft-start circuit that controls the ramp up of the output voltage. Once the converter is enabled and the input voltage is above the undervoltage lockout threshold  $V_{\text{UVLO}}$  the output voltage ramps up from 5% to 95% of its nominal value within  $t_{\text{Ramp}}$  of typically 250  $\mu\text{s}$ .

This limits the inrush current in the converter during start-up and prevents possible input voltage drops when a battery or high impedance power source is used.

During soft-start, the switch current limit is reduced to 1/3 of its nominal value  $I_{\text{LIMF}}$  until the output voltage reaches 1/3 of its nominal value. Once the output voltage trips this threshold, the device operates with its nominal current limit  $I_{\text{LIMF}}$ .

### 7.4.2 Power-Save Mode

At TLV62065 pulling the MODE pin low enables power-save mode. If the load current decreases, the converter enters power-save mode operation automatically. During power save mode the converter skips switching and operates with reduced frequency in PFM mode with a minimum quiescent current to maintain high efficiency. The converter positions the output voltage typically +1% above the nominal output voltage. This voltage positioning feature minimizes voltage drops caused by a sudden load step.

The transition from PWM mode to PFM mode occurs once the inductor current in the low-side MOSFET switch becomes zero, which indicates discontinuous conduction mode.



## Device Functional Modes (continued)

During the power-save mode, the output voltage is monitored with a PFM comparator. As the output voltage falls below the PFM comparator threshold of  $V_{OUTnominal} + 1\%$ , the device starts a PFM current pulse. For this the high-side MOSFET switch will turn on and the inductor current ramps up. After the ON-time expires the switch will be turned off and the low-side MOSFET switch will be turned on until the inductor current becomes zero.

The converter effectively delivers a current to the output capacitor and the load. If the load is below the delivered current the output voltage will rise. If the output voltage is equal or higher than the PFM comparator threshold, the device stops switching and enters a sleep mode with typical 18- $\mu$ A current consumption.

In case the output voltage is still below the PFM comparator threshold, further PFM current pulses will be generated until the PFM comparator threshold is reached. The converter starts switching again once the output voltage drops below the PFM comparator threshold due to the load current.

The PFM mode is exited and PWM mode entered in case the output current can no longer be supported in PFM mode.

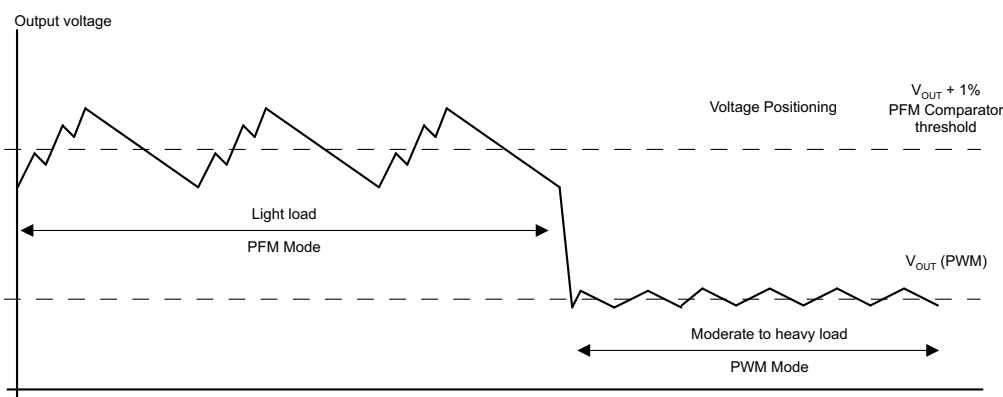

**Figure 7. Power-Save Mode Operation With Automatic Mode Transition**

### 7.4.2.1 100% Duty Cycle Low Dropout Operation

The device starts to enter 100% duty cycle mode as the input voltage comes close to the nominal output voltage. In order to maintain the output voltage, the high-side MOSFET switch is turned on 100% for one or more cycles.

With further decreasing  $V_{IN}$  the high-side MOSFET switch is turned on completely. In this case the converter offers a low input-to-output voltage difference. This is particularly useful in battery-powered applications to achieve longest operation time by taking full advantage of the whole battery voltage range.

The minimum input voltage to maintain regulation depends on the load current and output voltage, and can be calculated by [Equation 1](#):

$$V_{INmin} = V_{Omax} + I_{Omax} \times (R_{DS(on)max} + R_L)$$

where

- $I_{Omax}$  = maximum output current
- $R_{DS(on)max}$  = maximum P-channel switch  $R_{DS(on)}$
- $R_L$  = DC resistance of the inductor
- $V_{Omax}$  = nominal output voltage plus maximum output voltage tolerance

(1)

## Device Functional Modes (continued)

### 7.4.3 Internal Current Limit / Fold-back Current Limit for Short-Circuit Protection

During normal operation the high-side and low-side MOSFET switches are protected by its current limits  $I_{LIMF}$ . Once the high-side MOSFET switch reaches its current limit, it is turned off and the low-side MOSFET switch is turned on. The high-side MOSFET switch can only turn on again, once the current in the low-side MOSFET switch decreases below its current limit  $I_{LIMF}$ . The device is capable to provide peak inductor currents up to its internal current limit  $I_{LIMF}$ .

As soon as the switch current limits are hit and the output voltage falls below 1/3 of the nominal output voltage due to overload or short circuit condition, the foldback current limit is enabled. In this case the switch current limit is reduced to 1/3 of the nominal value  $I_{LIMF}$ .

Due to the short-circuit protection is enabled during start-up, the device does not deliver more than 1/3 of its nominal current limit  $I_{LIMF}$  until the output voltage exceeds 1/3 of the nominal output voltage. This needs to be considered when a load is connected to the output of the converter, which acts as a current sink.

### 7.4.4 Output Capacitor Discharge

With EN = GND, the device enters shutdown mode and all internal circuits are disabled. The SW pin is connected to PGND through an internal resistor to discharge the output capacitor. This feature ensures a start-up in a discharged output capacitor once the converter is enabled again and prevents *floating* charge on the output capacitor. The output voltage ramps up monotonic starting from 0 V.

## 8 Application and Implementation

### NOTE

Information in the following applications sections is not part of the TI component specification, and TI does not warrant its accuracy or completeness. TI's customers are responsible for determining suitability of components for their purposes. Customers should validate and test their design implementation to confirm system functionality.

### 8.1 Application Information

The TLV62065 is a high-efficiency synchronous step-down DC/DC converter providing up to 2-A output current.

### 8.2 Typical Application

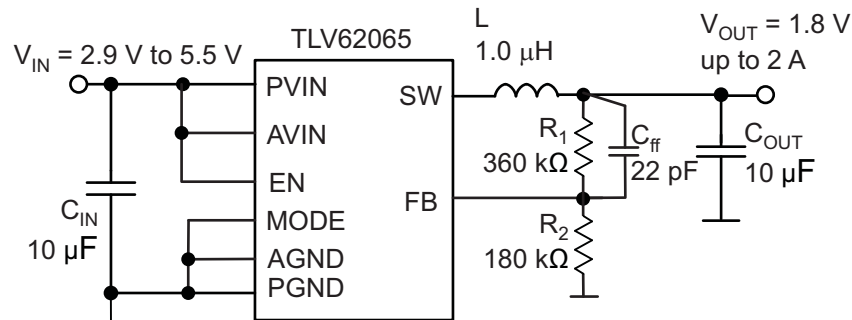

Figure 8. TLV62065 1.8-V Adjustable Output Voltage Configuration

#### 8.2.1 Design Requirements

The device operates over an input voltage range from 2.9 V to 5.5 V. The output voltage is adjustable using an external feedback divider.

#### 8.2.2 Detailed Design Procedure

##### 8.2.2.1 Output Voltage Setting

The output voltage can be calculated by Equation 2 with an internal reference voltage  $V_{REF}$  typically 0.6 V.

$$V_{OUT} = V_{REF} \times \left( 1 + \frac{R_1}{R_2} \right) \quad (2)$$

To minimize the current through the feedback divider network,  $R_2$  should be within the range of 120 kΩ to 360 kΩ. The sum of  $R_1$  and  $R_2$  should not exceed approximately 1 MΩ, to keep the network robust against noise. An external feed-forward capacitor  $C_{ff}$  is required for optimum regulation performance. Lower resistor values can be used.  $R_1$  and  $C_{ff}$  places a zero in the loop. The right value for  $C_{ff}$  can be calculated by Equation 3 and Equation 4:

$$f_z = \frac{1}{2 \times \pi \times R_1 \times C_{ff}} = 25 \text{ kHz} \quad (3)$$

$$C_{ff} = \frac{1}{2 \times \pi \times R_1 \times 25 \text{ kHz}} \quad (4)$$

## Typical Application (continued)

### 8.2.2.2 Output Filter Design (Inductor and Output Capacitor)

The internal compensation network of TLV62065 is optimized for a LC output filter with a corner frequency of:

$$f_c = \frac{1}{2 \times \pi \times \sqrt{(1\mu\text{H} \times 10\mu\text{F})}} = 50\text{kHz}$$

The device operates with nominal inductors of 1.0  $\mu\text{H}$  to 1.2  $\mu\text{H}$  and with 10  $\mu\text{F}$  to 22  $\mu\text{F}$  small X5R and X7R ceramic capacitors. Please refer to the lists of inductors and capacitors. The device is optimized for a 1- $\mu\text{H}$  inductor and 10- $\mu\text{F}$  output capacitor.

#### 8.2.2.2.1 Inductor Selection

The inductor value has a direct effect on the ripple current. The selected inductor has to be rated for its DC resistance and saturation current. The inductor ripple current ( $\Delta I_L$ ) decreases with higher inductance and increases with higher  $V_I$  or  $V_O$ .

[Equation 5](#) calculates the maximum inductor current in PWM mode under static load conditions. The saturation current of the inductor should be rated higher than the maximum inductor current as calculated with [Equation 6](#). This is recommended because during heavy load transient the inductor current rises above the calculated value.

$$\Delta I_L = V_{\text{out}} \times \frac{1 - \frac{V_{\text{out}}}{V_{\text{in}}}}{L \times f} \quad (5)$$

$$I_{L_{\text{max}}} = I_{\text{outmax}} + \frac{\Delta I_L}{2}$$

where

- $f$  = Switching frequency (3 MHz typical)
  - $L$  = Inductor value
  - $\Delta I_L$  = Peak-to-peak inductor ripple current
  - $I_{L_{\text{max}}}$  = Maximum inductor current
- (6)

A more conservative approach is to select the inductor current rating just for the switch current limit  $I_{L_{\text{LIMF}}}$  of the converter.

The total losses of the coil have a strong impact on the efficiency of the DC–DC conversion and consist of both the losses in the DC resistance  $R_{\text{DC}}$  and the following frequency-dependent components:

- The losses in the core material (magnetic hysteresis loss, especially at high switching frequencies)
- Additional losses in the conductor from the skin effect (current displacement at high frequencies)
- Magnetic field losses of the neighboring windings (proximity effect)
- Radiation losses

**Table 1. List of Inductors**

DIMENSIONS [mm <sup>3</sup> ]	INDUCTANCE $\mu\text{H}$	INDUCTOR TYPE	SUPPLIER
3.2 x 2.5 x 1.0 max	1.0	LQM32PN (MLCC)	Murata
3.7 x 4 x 1.8 max	1.0	LQH44 (wire wound)	Murata
4.0 x 4.0 x 2.6 max	1.2	NRG4026T (wire wound)	Taiyo Yuden
3.5 x 3.7 x 1.8 max	1.2	DE3518 (wire wound)	TOKO

### 8.2.2.2.2 Output Capacitor Selection

The advanced fast-response voltage mode control scheme of the TLV62065 allows the use of tiny ceramic capacitors. Ceramic capacitors with low ESR values have the lowest output voltage ripple and are recommended. The output capacitor requires either an X7R or X5R dielectric. Y5V and Z5U dielectric capacitors, aside from their wide variation in capacitance over temperature, become resistive at high frequencies and may not be used. For most applications a nominal 10- $\mu\text{F}$  or 22- $\mu\text{F}$  capacitor is suitable. At small ceramic capacitors, the DC-bias effect decreases the effective capacitance. Therefore a 22- $\mu\text{F}$  capacitor can be used for output voltages higher than 2 V, see list of capacitors.

In case additional ceramic capacitors in the supplied system are connected to the output of the DC–DC converter, the output capacitor  $C_{\text{OUT}}$  need to be decreased in order not to exceed the recommended effective capacitance range. In this case a loop stability analysis must be performed as described later.

At nominal load current, the device operates in PWM mode and the RMS ripple current is calculated by Equation 7:

$$I_{\text{RMS}C_{\text{out}}} = V_{\text{out}} \times \frac{1 - \frac{V_{\text{out}}}{V_{\text{in}}}}{L \times f} \times \frac{1}{2 \times \sqrt{3}} \quad (7)$$

### 8.2.2.2.3 Input Capacitor Selection

Because of the nature of the buck converter having a pulsating input current, a low ESR input capacitor is required for best input voltage filtering and minimizing the interference with other circuits caused by high input voltage spikes. For most applications a 10- $\mu\text{F}$  ceramic capacitor is recommended. The input capacitor can be increased without any limit for better input voltage filtering.

Take care when using only small ceramic input capacitors. When a ceramic capacitor is used at the input and the power is being supplied through long wires, such as from a wall adapter, a load step at the output or VIN step on the input can induce ringing at the VIN pin. This ringing can couple to the output and be mistaken as loop instability or could even damage the part by exceeding the maximum ratings.

**Table 2. List of Capacitors**

CAPACITANCE	TYPE	SIZE [ mm <sup>3</sup> ]	SUPPLIER
10 $\mu\text{F}$	GRM188R60J106M	0603: 1.6 x 0.8 x 0.8	Murata
22 $\mu\text{F}$	GRM188R60G226M	0603: 1.6 x 0.8 x 0.8	Murata
22 $\mu\text{F}$	CL10A226MQ8NRNC	0603: 1.6 x 0.8 x 0.8	Samsung
10 $\mu\text{F}$	CL10A106MQ8NRNC	0603: 1.6 x 0.8 x 0.8	Samsung

### 8.2.2.3 Checking Loop Stability

The first step of circuit and stability evaluation is to look from a steady-state perspective at the following signal:

- Switching node, SW
- Inductor current,  $I_L$
- Output ripple voltage,  $V_{\text{OUT(AC)}}$

These are the basic signals that need to be measured when evaluating a switching converter. When the switching waveform shows large duty cycle jitter or the output voltage or inductor current shows oscillations, the regulation loop may be unstable. This is often a result of board layout and/or wrong L-C output filter combinations. As a next step in the evaluation of the regulation loop, the load transient response is tested. The time between the application of the load transient and the turn on of the P-channel MOSFET, the output capacitor must supply all of the current required by the load.  $V_{\text{OUT}}$  immediately shifts by an amount equal to  $\Delta I_{(\text{LOAD})} \times \text{ESR}$ , where ESR is the effective series resistance of  $C_{\text{OUT}}$ .  $\Delta I_{(\text{LOAD})}$  begins to charge or discharge  $C_{\text{OUT}}$  generating a feedback error signal used by the regulator to return  $V_{\text{OUT}}$  to its steady-state value. The results are most easily interpreted when the device operates in PWM mode at medium to high load currents.

During this recovery time,  $V_{\text{OUT}}$  can be monitored for settling time, overshoot, or ringing; that helps evaluate stability of the converter. Without any ringing, the loop has usually more than 45° of phase margin.

8.2.3 Application Curves

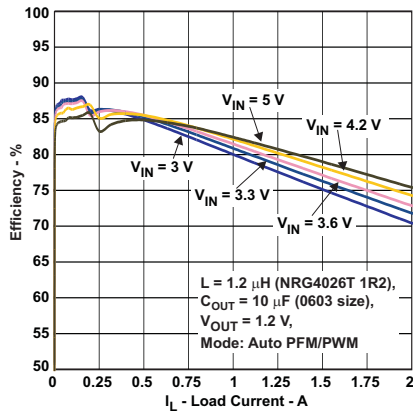

$V_{OUT} = 1.2\text{ V}$

Figure 9. Auto PFM/PWM Mode, Linear Scale

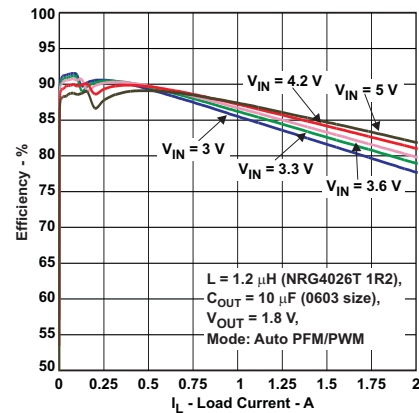

$V_{OUT} = 1.8\text{ V}$

Figure 10. Auto PFM/PWM Mode, Linear Scale

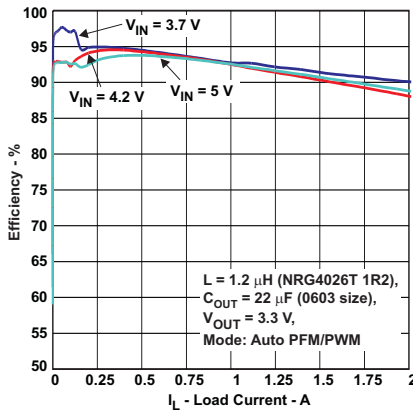

$V_{OUT} = 3.3\text{ V}$

Figure 11. Auto PFM/PWM Mode, Linear Scale

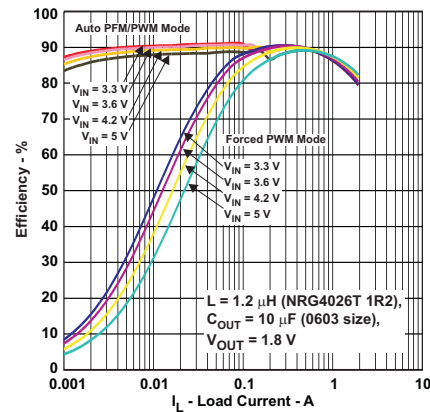

Figure 12. Auto PFM/PWM Mode vs Forced PWM Mode, Logarithmic Scale

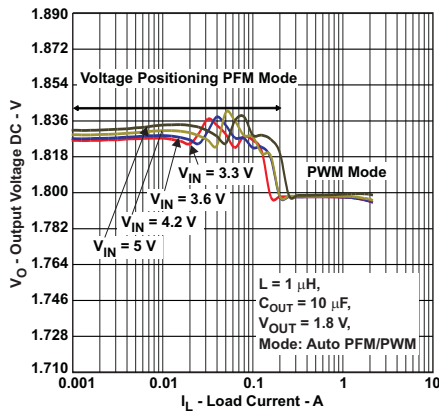

Figure 13. Auto PFM/PWM Mode

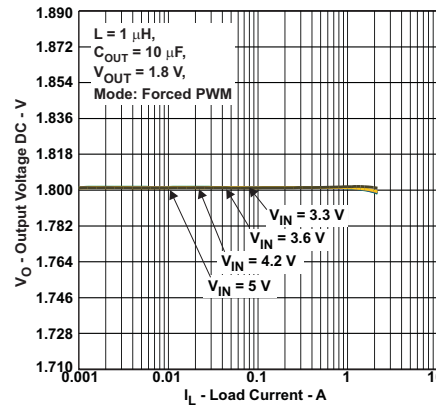

Figure 14. Forced PWM Mode

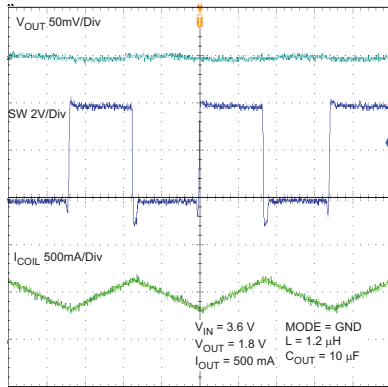

Figure 15. Typical Operation (PWM Mode)

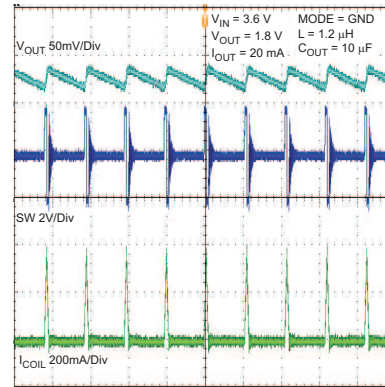

Figure 16. Typical Operation (PFM Mode)

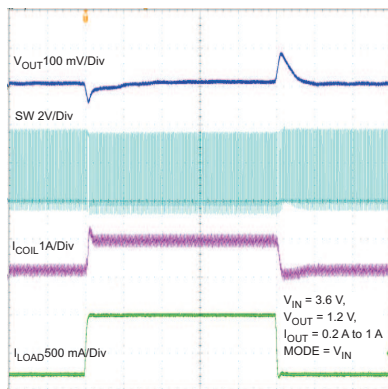

Figure 17. Load Transient Response PWM Mode 0.2 A to 1A

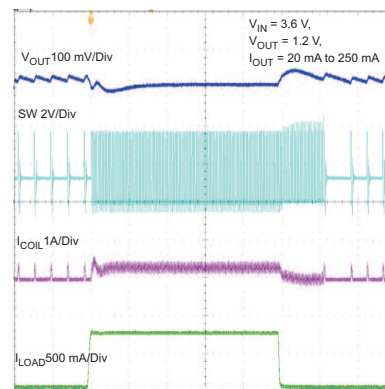

Figure 18. Load Transient PFM Mode 20 mA to 250 mA

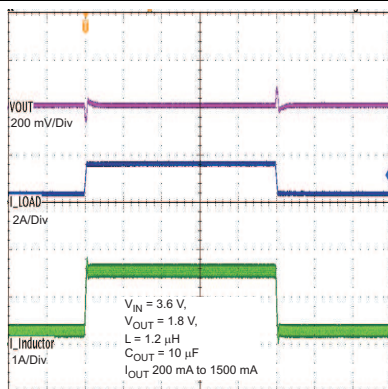

Figure 19. Load Transient Response 200 mA to 1500 mA

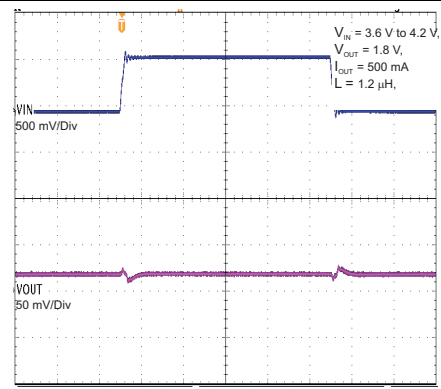

Figure 20. Line Transient Response PWM Mode

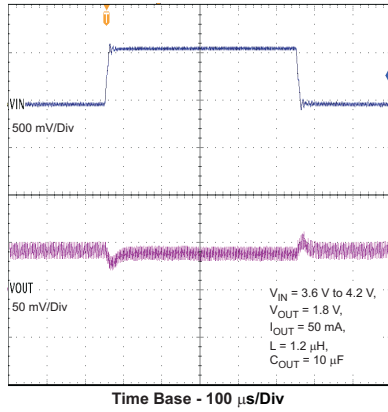

Figure 21. Line Transient PFM Mode

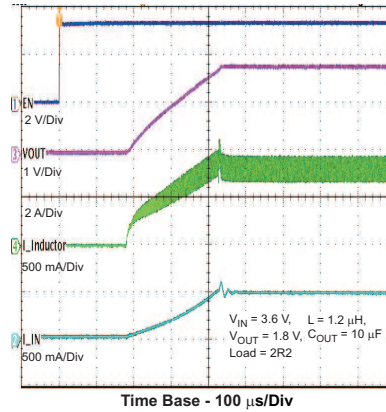

Figure 22. Startup Into Load –  $V_{OUT}$  1.8 V

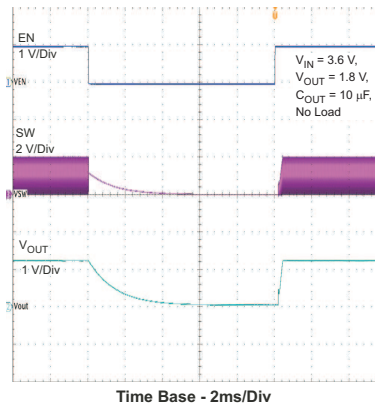

Figure 23. Output Discharge

## 9 Power Supply Recommendations

The power supply to the TLV62065 must have a current rating according to the supply voltage, output voltage, and output current of the TLV62065.



## 10 Layout

### 10.1 Layout Guidelines

As for all switching power supplies, the layout is an important step in the design. Proper function of the device demands careful attention to PCB layout. Take care in board layout to get the specified performance. If the layout is not carefully done, the regulator could show poor line and/or load regulation, stability issues as well as EMI and thermal problems. It is critical to provide a low inductance, impedance ground path. Therefore, use wide and short traces for the main current paths. The input capacitor should be placed as close as possible to the IC pins as well as the inductor and output capacitor.

Connect the AGND and PGND pins of the device to the exposed thermal pad land of the PCB and use this pad as a star point. Use a common power PGND node and a different node for the signal AGND to minimize the effects of ground noise. The FB divider network should be connected right to the output capacitor and the FB line must be routed away from noisy components and traces (for example, SW line).

Due to the small package of this converter and the overall small solution size, the thermal performance of the PCB layout is important. For good thermal performance a four or more layer PCB design is recommended. The exposed thermal pad of the IC must be soldered on the power pad area on the PCB to achieve proper thermal connection. Additionally, for good thermal performance, the exposed thermal pad on the PCB needs to be connected to an inner GND plane with sufficient via connections.

### 10.2 Layout Example

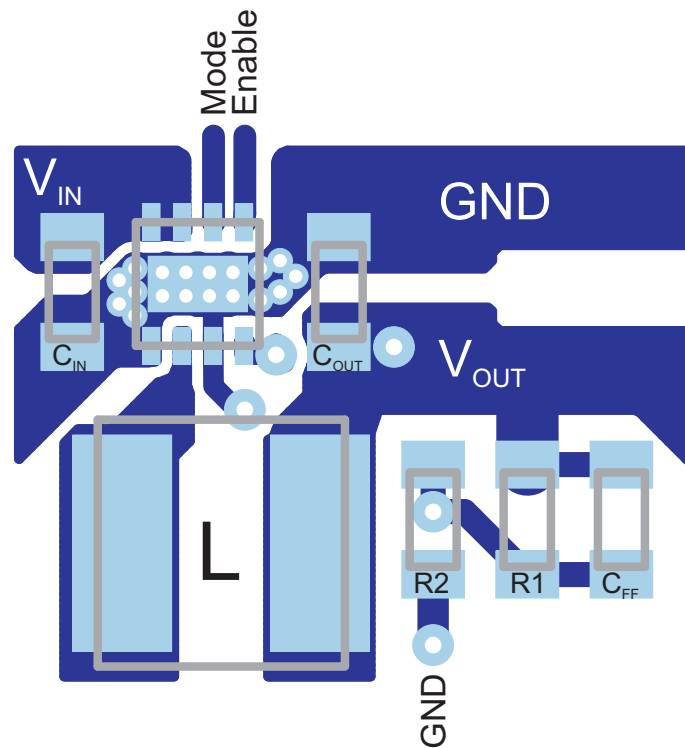

Figure 24. PCB Layout

## 11 Device and Documentation Support

### 11.1 Device Support

#### 11.1.1 Third-Party Products Disclaimer

TI'S PUBLICATION OF INFORMATION REGARDING THIRD-PARTY PRODUCTS OR SERVICES DOES NOT CONSTITUTE AN ENDORSEMENT REGARDING THE SUITABILITY OF SUCH PRODUCTS OR SERVICES OR A WARRANTY, REPRESENTATION OR ENDORSEMENT OF SUCH PRODUCTS OR SERVICES, EITHER ALONE OR IN COMBINATION WITH ANY TI PRODUCT OR SERVICE.

### 11.2 Community Resources

The following links connect to TI community resources. Linked contents are provided "AS IS" by the respective contributors. They do not constitute TI specifications and do not necessarily reflect TI's views; see TI's [Terms of Use](#).

**TI E2E™ Online Community** *TI's Engineer-to-Engineer (E2E) Community*. Created to foster collaboration among engineers. At [e2e.ti.com](http://e2e.ti.com), you can ask questions, share knowledge, explore ideas and help solve problems with fellow engineers.

**Design Support** *TI's Design Support* Quickly find helpful E2E forums along with design support tools and contact information for technical support.

### 11.3 Trademarks

E2E is a trademark of Texas Instruments.  
All other trademarks are the property of their respective owners.

### 11.4 Electrostatic Discharge Caution



These devices have limited built-in ESD protection. The leads should be shorted together or the device placed in conductive foam during storage or handling to prevent electrostatic damage to the MOS gates.

### 11.5 Glossary

[SLYZ022](#) — *TI Glossary*.

This glossary lists and explains terms, acronyms, and definitions.

## 12 Mechanical, Packaging, and Orderable Information

The following pages include mechanical, packaging, and orderable information. This information is the most current data available for the designated devices. This data is subject to change without notice and revision of this document. For browser-based versions of this data sheet, refer to the left-hand navigation.

**PACKAGING INFORMATION**

Orderable part number	Status (1)	Material type (2)	Package   Pins	Package qty   Carrier	RoHS (3)	Lead finish/ Ball material (4)	MSL rating/ Peak reflow (5)	Op temp (°C)	Part marking (6)
<a href="#">TLV62065DSGR</a>	Active	Production	WSON (DSG)   8	3000   LARGE T&R	Yes	NIPDAU   NIPDAUAG	Level-2-260C-1 YEAR	-40 to 85	QVB
TLV62065DSGR.A	Active	Production	WSON (DSG)   8	3000   LARGE T&R	Yes	NIPDAU	Level-2-260C-1 YEAR	-40 to 85	QVB
TLV62065DSGRG4	Active	Production	WSON (DSG)   8	3000   LARGE T&R	Yes	NIPDAU	Level-2-260C-1 YEAR	-40 to 85	QVB
TLV62065DSGRG4.A	Active	Production	WSON (DSG)   8	3000   LARGE T&R	Yes	NIPDAU	Level-2-260C-1 YEAR	-40 to 85	QVB
<a href="#">TLV62065DSGT</a>	Active	Production	WSON (DSG)   8	250   SMALL T&R	Yes	NIPDAU   NIPDAUAG	Level-2-260C-1 YEAR	-40 to 85	QVB
TLV62065DSGT.A	Active	Production	WSON (DSG)   8	250   SMALL T&R	Yes	NIPDAU	Level-2-260C-1 YEAR	-40 to 85	QVB

(1) **Status:** For more details on status, see our [product life cycle](#).

(2) **Material type:** When designated, preproduction parts are prototypes/experimental devices, and are not yet approved or released for full production. Testing and final process, including without limitation quality assurance, reliability performance testing, and/or process qualification, may not yet be complete, and this item is subject to further changes or possible discontinuation. If available for ordering, purchases will be subject to an additional waiver at checkout, and are intended for early internal evaluation purposes only. These items are sold without warranties of any kind.

(3) **RoHS values:** Yes, No, RoHS Exempt. See the [TI RoHS Statement](#) for additional information and value definition.

(4) **Lead finish/Ball material:** Parts may have multiple material finish options. Finish options are separated by a vertical ruled line. Lead finish/Ball material values may wrap to two lines if the finish value exceeds the maximum column width.

(5) **MSL rating/Peak reflow:** The moisture sensitivity level ratings and peak solder (reflow) temperatures. In the event that a part has multiple moisture sensitivity ratings, only the lowest level per JEDEC standards is shown. Refer to the shipping label for the actual reflow temperature that will be used to mount the part to the printed circuit board.

(6) **Part marking:** There may be an additional marking, which relates to the logo, the lot trace code information, or the environmental category of the part.

Multiple part markings will be inside parentheses. Only one part marking contained in parentheses and separated by a "~" will appear on a part. If a line is indented then it is a continuation of the previous line and the two combined represent the entire part marking for that device.

**Important Information and Disclaimer:** The information provided on this page represents TI's knowledge and belief as of the date that it is provided. TI bases its knowledge and belief on information provided by third parties, and makes no representation or warranty as to the accuracy of such information. Efforts are underway to better integrate information from third parties. TI has taken and continues to take reasonable steps to provide representative and accurate information but may not have conducted destructive testing or chemical analysis on incoming materials and chemicals. TI and TI suppliers consider certain information to be proprietary, and thus CAS numbers and other limited information may not be available for release.

In no event shall TI's liability arising out of such information exceed the total purchase price of the TI part(s) at issue in this document sold by TI to Customer on an annual basis.



**TAPE AND REEL INFORMATION**

**QUADRANT ASSIGNMENTS FOR PIN 1 ORIENTATION IN TAPE**

\*All dimensions are nominal

Device	Package Type	Package Drawing	Pins	SPQ	Reel Diameter (mm)	Reel Width W1 (mm)	A0 (mm)	B0 (mm)	K0 (mm)	P1 (mm)	W (mm)	Pin1 Quadrant
TLV62065DSGR	WSON	DSG	8	3000	180.0	8.4	2.3	2.3	1.15	4.0	8.0	Q2
TLV62065DSGRG4	WSON	DSG	8	3000	180.0	8.4	2.3	2.3	1.15	4.0	8.0	Q2
TLV62065DSGT	WSON	DSG	8	250	180.0	8.4	2.3	2.3	1.15	4.0	8.0	Q2

**TAPE AND REEL BOX DIMENSIONS**

\*All dimensions are nominal

Device	Package Type	Package Drawing	Pins	SPQ	Length (mm)	Width (mm)	Height (mm)
TLV62065DSGR	WSON	DSG	8	3000	210.0	185.0	35.0
TLV62065DSGRG4	WSON	DSG	8	3000	210.0	185.0	35.0
TLV62065DSGT	WSON	DSG	8	250	210.0	185.0	35.0

## GENERIC PACKAGE VIEW

**DSG 8**

**WSON - 0.8 mm max height**

2 x 2, 0.5 mm pitch

PLASTIC SMALL OUTLINE - NO LEAD

This image is a representation of the package family, actual package may vary.  
Refer to the product data sheet for package details.



4224783/A

# DSG0008A



# PACKAGE OUTLINE

## WSON - 0.8 mm max height

PLASTIC SMALL OUTLINE - NO LEAD



ALTERNATIVE TERMINAL SHAPE TYPICAL



SIDE WALL METAL THICKNESS DIM A	
OPTION 1	OPTION 2
0.1	0.2



4218900/E 08/2022

### NOTES:

1. All linear dimensions are in millimeters. Any dimensions in parenthesis are for reference only. Dimensioning and tolerancing per ASME Y14.5M.
2. This drawing is subject to change without notice.
3. The package thermal pad must be soldered to the printed circuit board for thermal and mechanical performance.



# EXAMPLE BOARD LAYOUT

DSG0008A

WSON - 0.8 mm max height

PLASTIC SMALL OUTLINE - NO LEAD



LAND PATTERN EXAMPLE  
SCALE:20X



SOLDER MASK DETAILS

4218900/E 08/2022

NOTES: (continued)

4. This package is designed to be soldered to a thermal pad on the board. For more information, see Texas Instruments literature number SLUA271 ([www.ti.com/lit/slua271](http://www.ti.com/lit/slua271)).
5. Vias are optional depending on application, refer to device data sheet. If any vias are implemented, refer to their locations shown on this view. It is recommended that vias under paste be filled, plugged or tented.

# EXAMPLE STENCIL DESIGN

DSG0008A

WSON - 0.8 mm max height

PLASTIC SMALL OUTLINE - NO LEAD



SOLDER PASTE EXAMPLE  
BASED ON 0.125 mm THICK STENCIL

EXPOSED PAD 9:  
87% PRINTED SOLDER COVERAGE BY AREA UNDER PACKAGE  
SCALE:25X

4218900/E 08/2022

NOTES: (continued)

6. Laser cutting apertures with trapezoidal walls and rounded corners may offer better paste release. IPC-7525 may have alternate design recommendations.

## IMPORTANT NOTICE AND DISCLAIMER

TI PROVIDES TECHNICAL AND RELIABILITY DATA (INCLUDING DATASHEETS), DESIGN RESOURCES (INCLUDING REFERENCE DESIGNS), APPLICATION OR OTHER DESIGN ADVICE, WEB TOOLS, SAFETY INFORMATION, AND OTHER RESOURCES "AS IS" AND WITH ALL FAULTS, AND DISCLAIMS ALL WARRANTIES, EXPRESS AND IMPLIED, INCLUDING WITHOUT LIMITATION ANY IMPLIED WARRANTIES OF MERCHANTABILITY, FITNESS FOR A PARTICULAR PURPOSE OR NON-INFRINGEMENT OF THIRD PARTY INTELLECTUAL PROPERTY RIGHTS.

These resources are intended for skilled developers designing with TI products. You are solely responsible for (1) selecting the appropriate TI products for your application, (2) designing, validating and testing your application, and (3) ensuring your application meets applicable standards, and any other safety, security, regulatory or other requirements.

These resources are subject to change without notice. TI grants you permission to use these resources only for development of an application that uses the TI products described in the resource. Other reproduction and display of these resources is prohibited. No license is granted to any other TI intellectual property right or to any third party intellectual property right. TI disclaims responsibility for, and you fully indemnify TI and its representatives against any claims, damages, costs, losses, and liabilities arising out of your use of these resources.

TI's products are provided subject to [TI's Terms of Sale](#), [TI's General Quality Guidelines](#), or other applicable terms available either on [ti.com](#) or provided in conjunction with such TI products. TI's provision of these resources does not expand or otherwise alter TI's applicable warranties or warranty disclaimers for TI products. Unless TI explicitly designates a product as custom or customer-specified, TI products are standard, catalog, general purpose devices.

TI objects to and rejects any additional or different terms you may propose.

Copyright © 2025, Texas Instruments Incorporated

Last updated 10/2025