

TPS56x219A 4.5-V to 17-V Input, 2-A, 3-A Synchronous Step-Down Voltage Regulator in 8 Pin SOT-23

1 Features

- TPS562219A: 2-A Converter With Integrated 133-m Ω and 80-m Ω FETs
- TPS563219A: 3-A Converter With Integrated 68-m Ω and 39-m Ω FETs
- D-CAP2™ Mode Control with 650-kHz Switching Frequency
- Input Voltage Range: 4.5 V to 17 V
- Output Voltage Range: 0.76 V to 7 V
- 650-kHz Switching Frequency
- Low Shutdown Current Less than 10 μ A
- 1% Feedback Voltage Accuracy (25°C)
- Startup from Pre-Biased Output Voltage
- Cycle By Cycle Overcurrent Limit
- Hiccup-mode Under Voltage Protection
- Non-latch OVP, UVLO and TSD Protections
- Adjustable Soft Start
- Power Good Output

2 Applications

- Digital TV Power Supply
- High Definition Blu-ray Disc™ Players
- Networking Home Terminal
- Digital Set Top Box (STB)

3 Description

The TPS562219A and TPS563219A are simple, easy-to-use, 2-A, 3-A synchronous step-down converters in 8 pin SOT-23 package.

The devices are optimized to operate with minimum external component counts and optimized to achieve low standby current.

These switch mode power supply (SMPS) devices employ D-CAP2™ mode control providing a fast transient response and supporting both low equivalent series resistance (ESR) output capacitors such as specialty polymer and ultra-low ESR ceramic capacitors with no external compensation components.

The devices always operate in continuous conduction mode, which reduces the output ripple voltage in light load compared to discontinuous conduction mode. The TPS562219A and TPS563219A are available in a 8-pin 1.6 × 2.9 (mm) SOT (DDF) package, and specified from –40°C to 85°C of ambient temperature.

Device Information⁽¹⁾

PART NUMBER	PACKAGE	BODY SIZE (NOM)
TPS562219A	SOT (8)	1.60 mm × 2.90 mm
TPS563219A		

(1) For all available packages, see the orderable addendum at the end of the datasheet.

Simplified Schematic

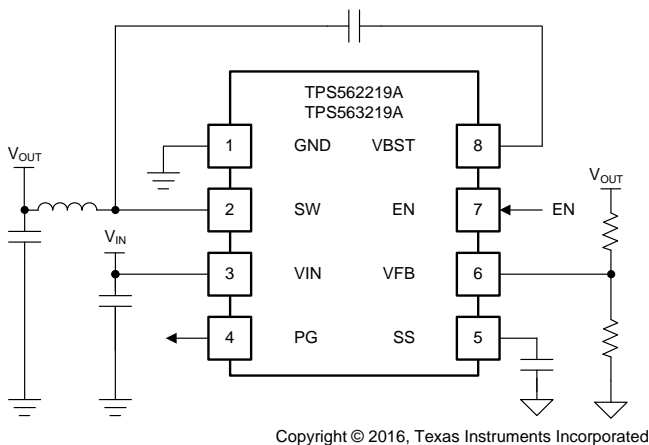

TPS562219A Transient Response

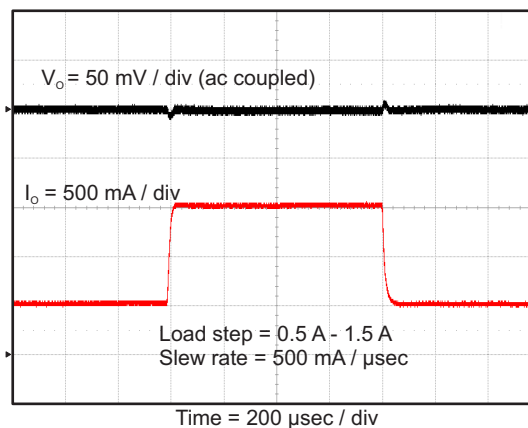

Table of Contents

1 Features	1	8 Application and Implementation	13
2 Applications	1	8.1 Application Information.....	13
3 Description	1	8.2 Typical Application	13
4 Revision History	2	9 Power Supply Recommendations	21
5 Pin Configuration and Functions	3	10 Layout	21
6 Specifications	4	10.1 Layout Guidelines	21
6.1 Absolute Maximum Ratings	4	10.2 Layout Example	21
6.2 ESD Ratings	4	11 Device and Documentation Support	22
6.3 Recommended Operating Conditions.....	4	11.1 Device Support	22
6.4 Thermal Information	4	11.2 Documentation Support	22
6.5 Electrical Characteristics.....	5	11.3 Related Links	22
6.6 Timing Requirements.....	5	11.4 Receiving Notification of Documentation Updates	22
6.7 Typical Characteristics.....	6	11.5 Community Resources.....	22
7 Detailed Description	10	11.6 Trademarks	22
7.1 Overview	10	11.7 Electrostatic Discharge Caution.....	22
7.2 Functional Block Diagram	10	11.8 Glossary	22
7.3 Feature Description.....	10	12 Mechanical, Packaging, and Orderable	
7.4 Device Functional Modes.....	12	Information	22

4 Revision History

DATE	REVISION	NOTES
November 2016	*	Initial release.

5 Pin Configuration and Functions

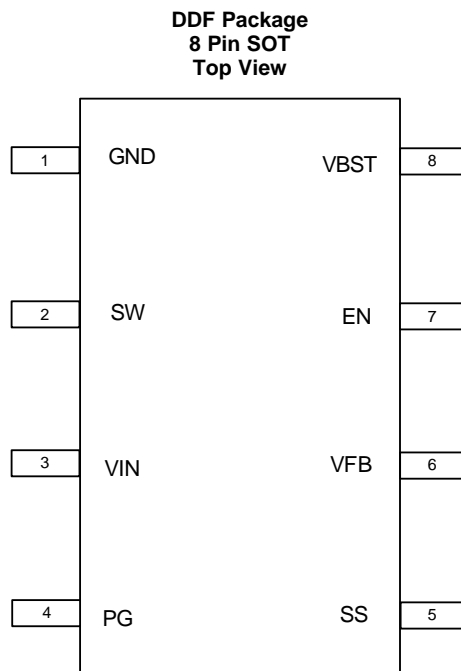

Pin Functions

PIN		DESCRIPTION
NAME	NO.	
GND	1	Ground pin Source terminal of low-side power NFET as well as the ground terminal for controller circuit. Connect sensitive VFB to this GND at a single point.
SW	2	Switch node connection between high-side NFET and low-side NFET.
VIN	3	Input voltage supply pin. The drain terminal of high-side power NFET.
PG	4	Power good open drain output
SS	5	Soft-start control. An external capacitor should be connected to GND.
VFB	6	Converter feedback input. Connect to output voltage with feedback resistor divider.
EN	7	Enable input control. Active high and must be pulled up to enable the device.
VBST	8	Supply input for the high-side NFET gate drive circuit. Connect 0.1 μ F capacitor between VBST and SW pins.

6 Specifications

6.1 Absolute Maximum Ratings

 $T_J = -40^{\circ}\text{C}$ to 150°C (unless otherwise noted) ⁽¹⁾

		MIN	MAX	UNIT
Input voltage range	VIN, EN	-0.3	19	V
	VBST	-0.3	25	V
	VBST (10 ns transient)	-0.3	27.5	V
	VBST (vs SW)	-0.3	6.5	V
	VFB, PG	-0.3	6.5	V
	SS	-0.3	5.5	V
	SW	-2	19	V
	SW (10 ns transient)	-3.5	21	V
Operating junction temperature, T_J		-40	150	$^{\circ}\text{C}$
Storage temperature, T_{stg}		-55	150	$^{\circ}\text{C}$

(1) Stresses beyond those listed under *Absolute Maximum Ratings* may cause permanent damage to the device. These are stress ratings only, which do not imply functional operation of the device at these or any other conditions beyond those indicated under *Recommended Operating Conditions*. Exposure to absolute-maximum-rated conditions for extended periods may affect device reliability.

6.2 ESD Ratings

			VALUE	UNIT
$V_{(ESD)}$	Electrostatic discharge	Human body model (HBM), per ANSI/ESDA/JEDEC JS-001 ⁽¹⁾	± 2000	V
		Charged device model (CDM), per JEDEC specification JESD22-C101 ⁽²⁾	± 500	

(1) JEDEC document JEP155 states that 500-V HBM allows safe manufacturing with a standard ESD control process.

(2) JEDEC document JEP157 states that 250-V CDM allows safe manufacturing with a standard ESD control process.

6.3 Recommended Operating Conditions

 $T_J = -40^{\circ}\text{C}$ to 150°C (unless otherwise noted)

		MIN	MAX	UNIT	
V_{IN}	Supply input voltage range	4.5	17	V	
V_I	Input voltage range	VBST	-0.1	23	V
		VBST (10 ns transient)	-0.1	26	
		VBST(vs SW)	-0.1	6	
		EN	-0.1	17	
		VFB, PG	-0.1	5.5	
		SS	-0.1	5	
		SW	-1.8	17	
		SW (10 ns transient)	-3.5	20	
T_A	Operating free-air temperature	-40	85	$^{\circ}\text{C}$	

6.4 Thermal Information

THERMAL METRIC ⁽¹⁾		TPS562219A	TPS563219A	UNIT
		DDF (SOT)		
		8 PINS		
$R_{\theta JA}$	Junction-to-ambient thermal resistance	106.1	87.0	$^{\circ}\text{C}/\text{W}$
$R_{\theta JC(top)}$	Junction-to-case (top) thermal resistance	49.1	41.6	$^{\circ}\text{C}/\text{W}$
$R_{\theta JB}$	Junction-to-board thermal resistance	10.9	14.6	$^{\circ}\text{C}/\text{W}$
Ψ_{JT}	Junction-to-top characterization parameter	8.6	4.7	$^{\circ}\text{C}/\text{W}$
Ψ_{JB}	Junction-to-board characterization parameter	10.8	14.6	$^{\circ}\text{C}/\text{W}$

(1) For more information about traditional and new thermal metrics, see the [Semiconductor and IC Package Thermal Metrics](#) application report.

6.5 Electrical Characteristics

 $T_J = -40^{\circ}\text{C}$ to 150°C , $V_{IN} = 12\text{ V}$ (unless otherwise noted)

PARAMETER		TEST CONDITIONS	MIN	TYP	MAX	UNIT
SUPPLY CURRENT						
I_{VIN}	Operating – non-switching supply current	V_{IN} current, $T_A = 25^{\circ}\text{C}$, $EN = 5\text{ V}$, $V_{FB} = 0.8\text{ V}$		650	900	μA
I_{VINDN}	Shutdown supply current	V_{IN} current, $T_A = 25^{\circ}\text{C}$, $EN = 0\text{ V}$		3	10	μA
LOGIC THRESHOLD						
V_{ENH}	EN high-level input voltage	EN	1.6			V
V_{ENL}	EN low-level input voltage	EN			0.6	V
R_{EN}	EN pin resistance to GND	$V_{EN} = 12\text{ V}$	225	450	900	$\text{k}\Omega$
V_{FB} VOLTAGE AND DISCHARGE RESISTANCE						
V_{FBTH}	V_{FB} threshold voltage	$T_A = 25^{\circ}\text{C}$, $V_O = 1.05\text{ V}$	757	765	773	mV
		$T_A = 0^{\circ}\text{C}$ to 85°C , $V_O = 1.05\text{ V}^{(1)}$	753		777	
		$T_A = -40^{\circ}\text{C}$ to 85°C , $V_O = 1.05\text{ V}^{(1)}$	751		779	
I_{VFB}	V_{FB} input current	$V_{FB} = 0.8\text{ V}$, $T_A = 25^{\circ}\text{C}$		0	± 0.1	μA
MOSFET						
$R_{DS(on)h}$	High side switch resistance	$T_A = 25^{\circ}\text{C}$, $V_{BST} - SW = 5.5\text{ V}$, TPS562219A		133		m Ω
		$T_A = 25^{\circ}\text{C}$, $V_{BST} - SW = 5.5\text{ V}$, TPS563219A		68		
$R_{DS(on)l}$	Low side switch resistance	$T_A = 25^{\circ}\text{C}$, TPS562219A		80		m Ω
		$T_A = 25^{\circ}\text{C}$, TPS563219A		39		
CURRENT LIMIT						
I_{OCL}	Current limit ⁽¹⁾	DC current, $V_{OUT} = 1.05\text{ V}$, $L1 = 2.2\text{ }\mu\text{H}$, TPS562219A	2.5	3.2	4.3	A
		DC current, $V_{OUT} = 1.05\text{ V}$, $L1 = 1.5\text{ }\mu\text{H}$, TPS563219A	3.5	4.2	5.3	
THERMAL SHUTDOWN						
T_{SDN}	Thermal shutdown threshold ⁽¹⁾	Shutdown temperature		155		$^{\circ}\text{C}$
		Hysteresis		35		
SOFT START						
I_{SS}	SS charge current	$V_{SS} = 1.2\text{ V}$	4.2	6	7.8	μA
POWER GOOD						
V_{THPG}	PG threshold	V_{FB} rising (Good)	85%	90%	95%	
		V_{FB} falling (Fault)		85%		
IPG	PG sink current	PG = 0.5 V	0.5	1		mA
OUTPUT UNDERVOLTAGE AND OVERVOLTAGE PROTECTION						
V_{OVP}	Output OVP threshold	OVP Detect		125% \times V_{fbth}		
V_{UVP}	Output UVP threshold	Hiccup detect		65% \times V_{fbth}		
$t_{HiccupOn}$	Hiccup Power On Time			1		cycle
$t_{HiccupOff}$	Hiccup Power Off Time			7		
UVLO						
UVLO	UVLO threshold	Wake up V_{IN} voltage	3.45	3.75	4.05	V
		Hysteresis V_{IN} voltage	0.13	0.32	0.55	

(1) Not production tested.

6.6 Timing Requirements

		MIN	TYP	MAX	UNIT
ON-TIME TIMER CONTROL					
t_{ON}	On time	$V_{IN} = 12\text{ V}$, $V_O = 1.05\text{ V}$	150		ns
$t_{OFF(MIN)}$	Minimum off time	$T_A = 25^{\circ}\text{C}$, $V_{FB} = 0.5\text{ V}$	260	310	ns

6.7 Typical Characteristics

6.7.1 TPS562219A Characteristics

$V_{IN} = 12V$ (unless otherwise noted)

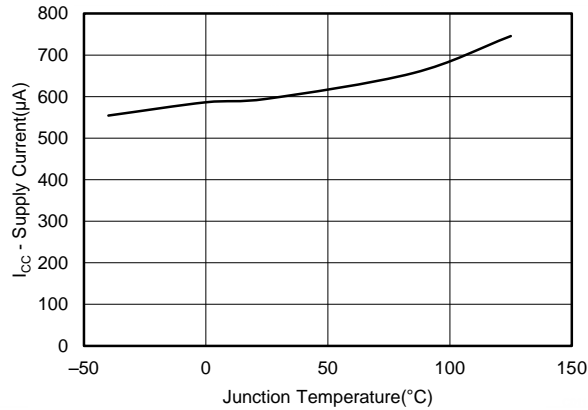

Figure 1. Supply Current vs Junction Temperature

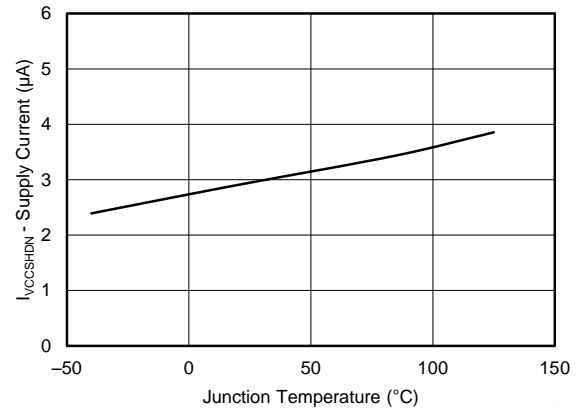

Figure 2. VIN Shutdown Current vs Junction Temperature

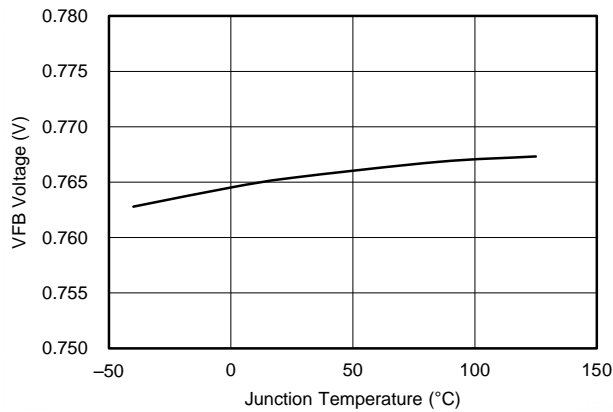

Figure 3. VFB Voltage vs Junction Temperature

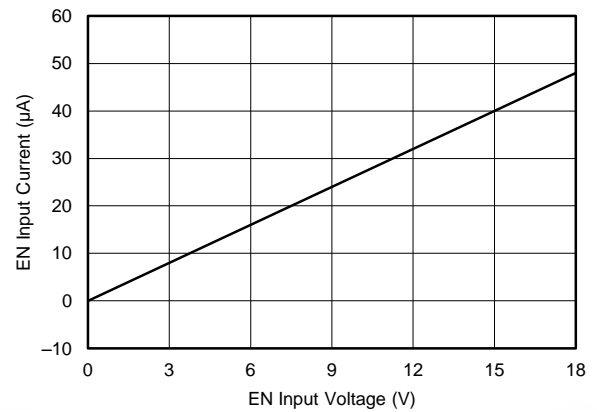

Figure 4. EN Current vs EN Voltage

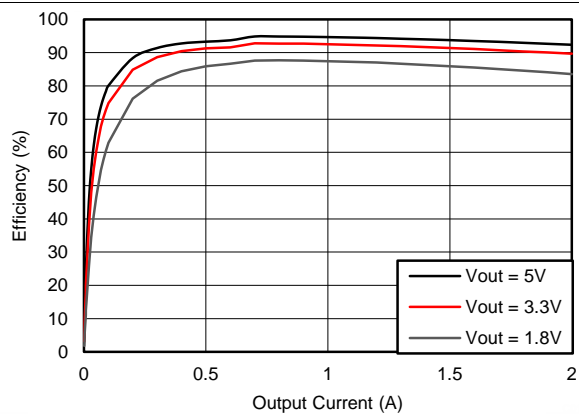

Figure 5. Efficiency vs Output Current

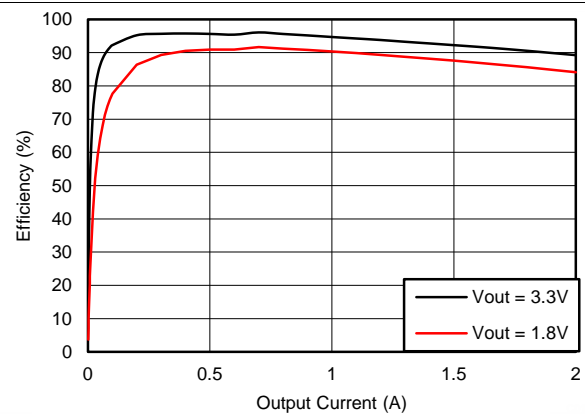

Figure 6. Efficiency vs Output Current ($V_i = 5V$)

TPS562219A Characteristics (continued)

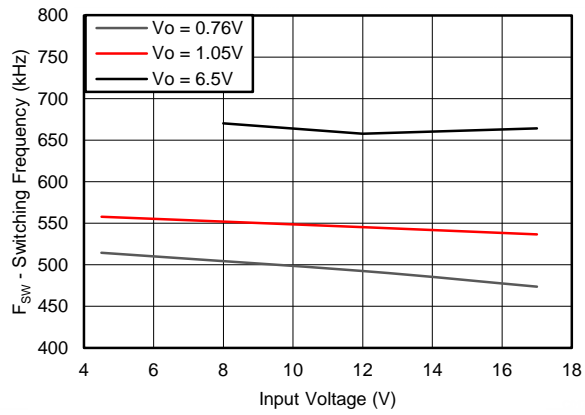

Figure 7. Switching Frequency vs Input Voltage

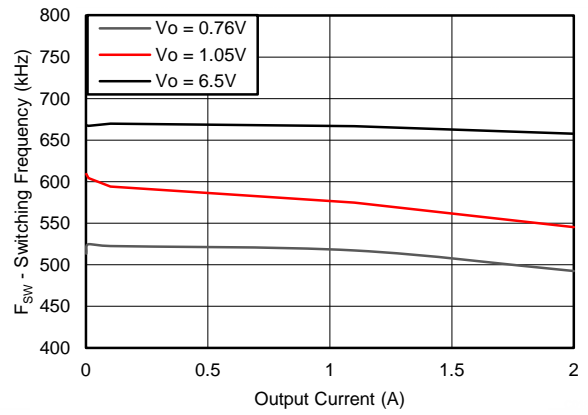

Figure 8. Switching Frequency vs Output Current

6.7.2 TPS563219A Characteristics

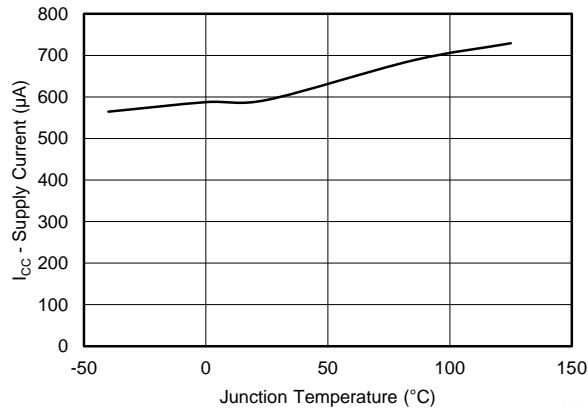

Figure 9. Supply Current vs Junction Temperature

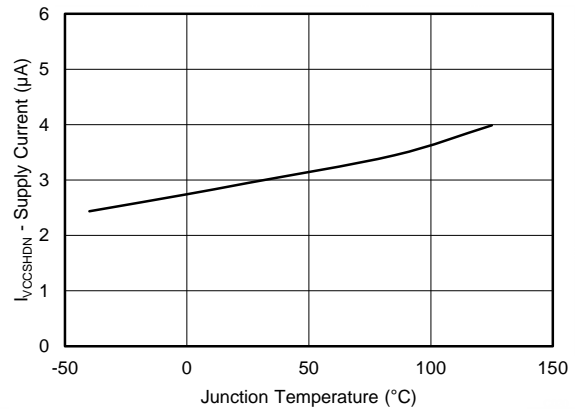

Figure 10. VIN Shutdown Current vs Junction Temperature

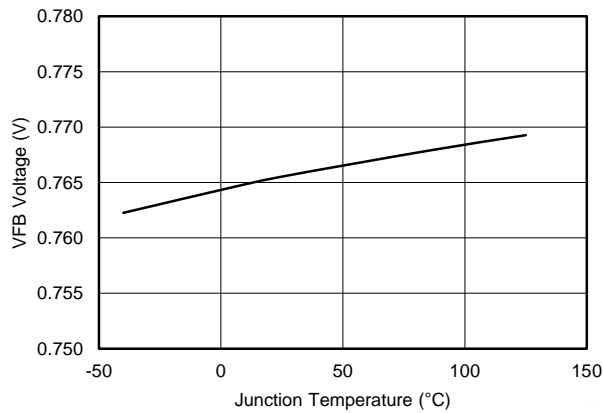

Figure 11. VFB Voltage vs Junction Temperature

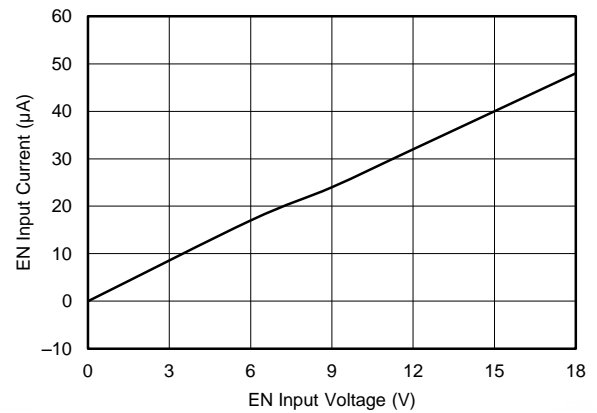

Figure 12. EN Current vs EN Voltage

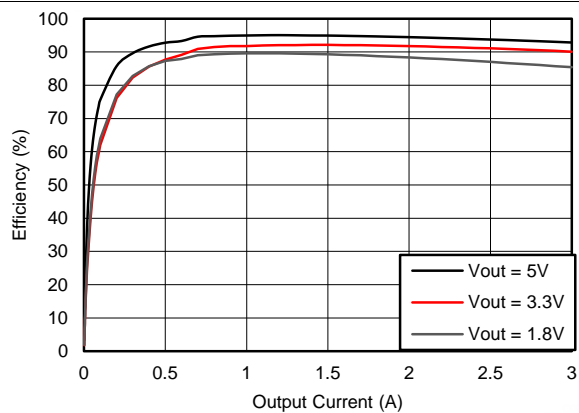

Figure 13. Efficiency vs Output Current

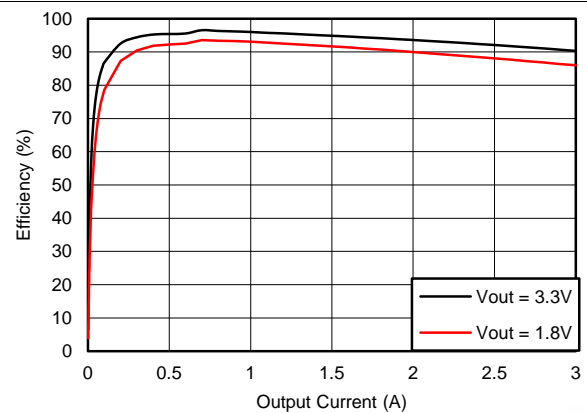

Figure 14. Efficiency vs Output Current (V_I = 5V)

TPS563219A Characteristics (continued)

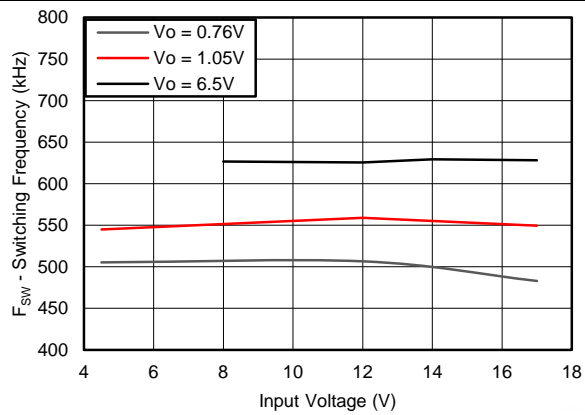

Figure 15. Switching Frequency vs Input Voltage

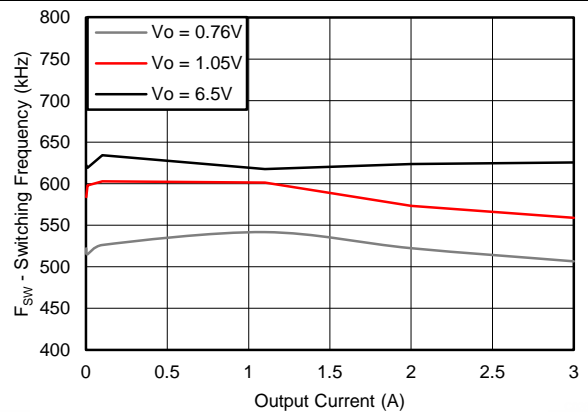

Figure 16. Switching Frequency vs Output Current

7 Detailed Description

7.1 Overview

The TPS562219A and TPS563219A are 2-A, 3-A synchronous step-down converters. The proprietary D-CAP2™ mode control supports low ESR output capacitors such as specialty polymer capacitors and multi-layer ceramic capacitors without complex external compensation circuits. The fast transient response of D-CAP2™ mode control can reduce the output capacitance required to meet a specific level of performance.

7.2 Functional Block Diagram

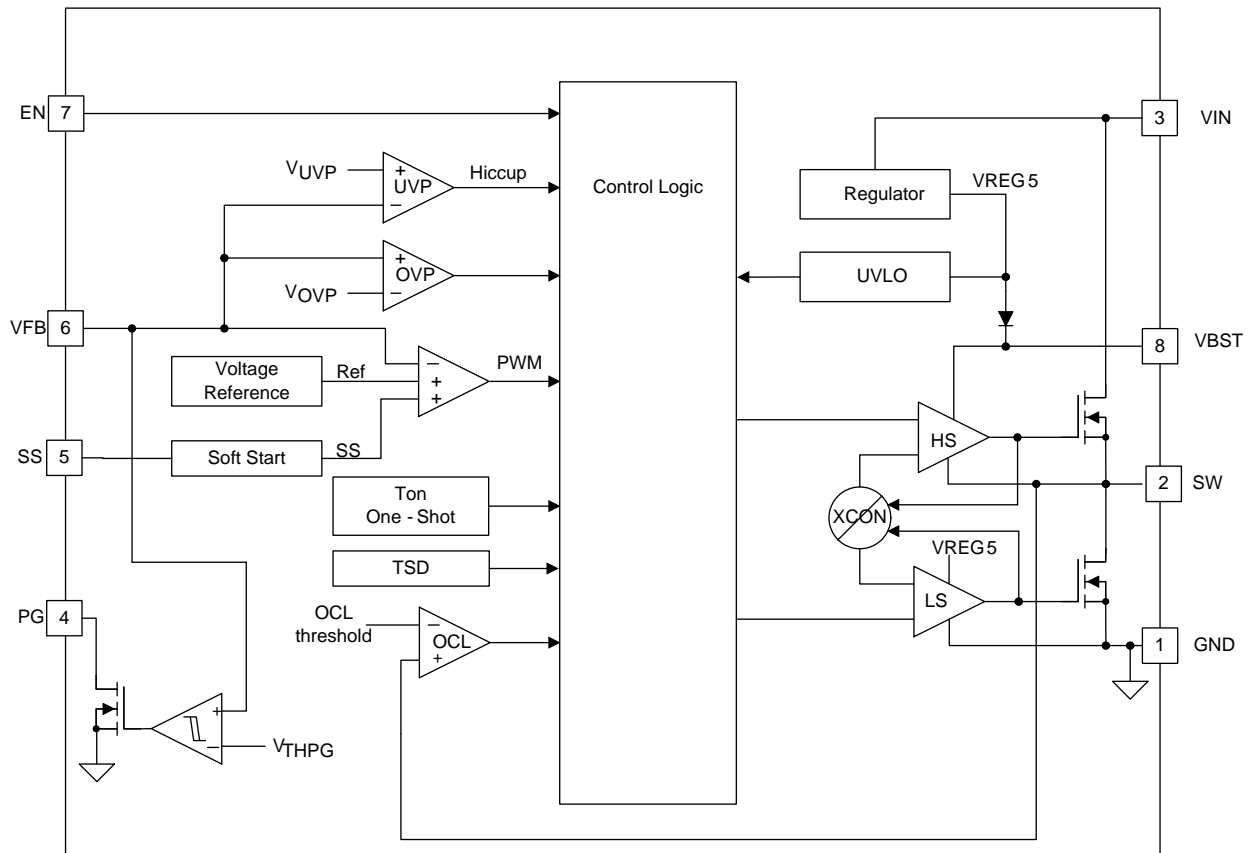

Copyright © 2016, Texas Instruments Incorporated

7.3 Feature Description

7.3.1 The Adaptive On-Time Control and PWM Operation

The main control loop of the TPS562219A and TPS563219A are adaptive on-time pulse width modulation (PWM) controller that supports a proprietary D-CAP2™ mode control. The D-CAP2™ mode control combines adaptive on-time control with an internal compensation circuit for pseudo-fixed frequency and low external component count configuration with both low ESR and ceramic output capacitors. It is stable even with virtually no ripple at the output.

At the beginning of each cycle, the high-side MOSFET is turned on. This MOSFET is turned off after internal one shot timer expires. This one shot duration is set proportional to the converter input voltage, V_{IN} , and inversely proportional to the output voltage, V_O , to maintain a pseudo-fixed frequency over the input voltage range, hence it is called adaptive on-time control. The one-shot timer is reset and the high-side MOSFET is turned on again when the feedback voltage falls below the reference voltage. An internal ramp is added to reference voltage to simulate output ripple, eliminating the need for ESR induced output ripple from D-CAP2™ mode control.

Feature Description (continued)

7.3.2 Soft Start and Pre-Biased Soft Start

The TPS562219A and TPS563219A have adjustable soft-start. When the EN pin becomes high, the SS charge current (I_{SS}) begins charging the capacitor which is connected from the SS pin to GND (C_{SS}). Smooth control of the output voltage is maintained during start up. The equation for the soft start time, T_{SS} is shown in [Equation 1](#).

$$T_{SS}(\text{ms}) = \frac{C_{SS} \times V_{FBTH} \times 0.86}{I_{SS}} \quad (1)$$

where V_{FBTH} is 0.765 V and I_{SS} is 6 μA .

If the output capacitor is pre-biased at startup, the devices initiate switching and start ramping up only after the internal reference voltage becomes greater than the feedback voltage V_{FB} . This scheme ensures that the converters ramp up smoothly into regulation point.

7.3.3 Power Good

The power good output, PG is an open drain output. The power good function becomes active after 1.7 times soft-start time. When the output voltage becomes within -10% of the target value, internal comparators detect power good state and the power good signal becomes high. If the feedback voltage goes under 15% of the target value, the power good signal becomes low.

7.3.4 Current Protection

The output over-current limit (OCL) is implemented using a cycle-by-cycle valley detect control circuit. The switch current is monitored during the OFF state by measuring the low-side FET drain to source voltage. This voltage is proportional to the switch current. To improve accuracy, the voltage sensing is temperature compensated.

During the on time of the high-side FET switch, the switch current increases at a linear rate determined by V_{IN} , V_{OUT} , the on-time and the output inductor value. During the on time of the low-side FET switch, this current decreases linearly. The average value of the switch current is the load current I_{OUT} . If the monitored current is above the OCL level, the converter maintains low-side FET on and delays the creation of a new set pulse, even the voltage feedback loop requires one, until the current level becomes OCL level or lower. In subsequent switching cycles, the on-time is set to a fixed value and the current is monitored in the same manner. If the over current condition exists consecutive switching cycles, the internal OCL threshold is set to a lower level, reducing the available output current. When a switching cycle occurs where the switch current is not above the lower OCL threshold, the counter is reset and the OCL threshold is returned to the higher value.

There are some important considerations for this type of over-current protection. The load current is higher than the over-current threshold by one half of the peak-to-peak inductor ripple current. Also, when the current is being limited, the output voltage tends to fall as the demanded load current may be higher than the current available from the converter. This may cause the output voltage to fall. When the VFB voltage falls below the UVP threshold voltage, the UVP comparator detects it. And then, the device will shut down after the UVP delay time (typically 14 μs) and re-start after the hiccup time.

When the over current condition is removed, the output voltage returns to the regulated value.

7.3.5 Over Voltage Protection

TPS562219A and TPS563219A detect over voltage condition by monitoring the feedback voltage (VFB). When the feedback voltage becomes higher than 125% of the target voltage, the OVP comparator output goes high and the high-side MOSFET turns off. This function is non-latch operation.

7.3.6 UVLO Protection

Under voltage lock out protection (UVLO) monitors the internal regulator voltage. When the voltage is lower than UVLO threshold voltage, the device is shut off. This protection is non-latching.

7.3.7 Thermal Shutdown

The device monitors the temperature of itself. If the temperature exceeds the threshold value (typically 155°C), the device is shut off. This is a non-latch protection.

7.4 Device Functional Modes

7.4.1 Normal Operation

When the input voltage is above the UVLO threshold and the EN voltage is above the enable threshold, the TPS562219A and TPS563219A can operate in their normal switching modes. Normal continuous conduction mode (CCM) occurs when the minimum switch current is above 0 A. In CCM, the TPS562219A and TPS563219A operate at a quasi-fixed frequency of 650 kHz.

7.4.2 Forced CCM Operation

When the TPS562209 and TPS563209 are in the normal CCM operating mode and the switch current falls below 0 A, the TPS562219A and TPS563219A begin operating in forced CCM.

7.4.3 Standby Operation

When the TPS562219A and TPS563219A are operating in either normal CCM or forced CCM, they may be placed in standby by asserting the EN pin low.

8 Application and Implementation

NOTE

Information in the following applications sections is not part of the TI component specification, and TI does not warrant its accuracy or completeness. TI's customers are responsible for determining suitability of components for their purposes. Customers should validate and test their design implementation to confirm system functionality.

8.1 Application Information

The TPS562219A and TPS563219A are typically used as step down converters, which convert a voltage from 4.5 V - 17 V to a lower voltage. Webench software is available to aid in the design and analysis of circuits.

8.2 Typical Application

8.2.1 Typical Application, TPS562219A

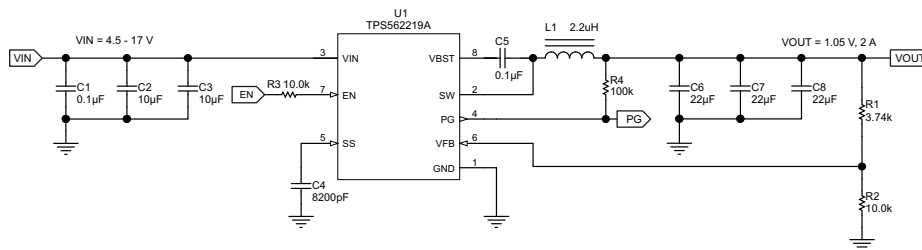

Copyright © 2016, Texas Instruments Incorporated

Figure 17. TPS562219A 1.05V/2A Reference Design

8.2.1.1 Design Requirements

For this design example, use the parameters shown in Table 1.

Table 1. Design Parameters

PARAMETER	VALUES
Input voltage range	4.5 V to 17 V
Output voltage	1.05 V
Output current	2 A
Output voltage ripple	20 mVpp

8.2.1.2 Detailed Design Procedure

8.2.1.2.1 Output Voltage Resistors Selection

The output voltage is set with a resistor divider from the output node to the VFB pin. It is recommended to use 1% tolerance or better divider resistors. Start by using Equation 2 to calculate V_{OUT} .

To improve efficiency at light loads consider using larger value resistors, too high of resistance are more susceptible to noise and voltage errors from the VFB input current are more noticeable.

$$V_{OUT} = 0.765 \times \left(1 + \frac{R1}{R2} \right) \quad (2)$$

8.2.1.2.2 Output Filter Selection

The LC filter used as the output filter has double pole at:

$$F_P = \frac{1}{2\pi\sqrt{L_{OUT} \times C_{OUT}}} \quad (3)$$

At low frequencies, the overall loop gain is set by the output set-point resistor divider network and the internal gain of the device. The low frequency phase is 180 degrees. At the output filter pole frequency, the gain rolls off at a –40 dB per decade rate and the phase drops rapidly. D-CAP2™ introduces a high frequency zero that reduces the gain roll off to –20 dB per decade and increases the phase to 90 degrees one decade above the zero frequency. The inductor and capacitor for the output filter must be selected so that the double pole of Equation 3 is located below the high frequency zero but close enough that the phase boost provided by the high frequency zero provides adequate phase margin for a stable circuit. To meet this requirement use the values recommended in Table 2.

Table 2. TPS562219A Recommended Component Values

Output Voltage (V)	R2 (kΩ)	R3 (kΩ)	L1(μH)			C6 + C7 + C8(μF)
			MIN	TYP	MAX	
1	3.09	10.0	1.5	2.2	4.7	20 - 68
1.05	3.74	10.0	1.5	2.2	4.7	20 - 68
1.2	5.76	10.0	1.5	2.2	4.7	20 - 68
1.5	9.53	10.0	1.5	2.2	4.7	20 - 68
1.8	13.7	10.0	1.5	2.2	4.7	20 - 68
2.5	22.6	10.0	2.2	3.3	4.7	20 - 68
3.3	33.2	10.0	2.2	3.3	4.7	20 - 68
5	54.9	10.0	3.3	4.7	4.7	20 - 68
6.5	75	10.0	3.3	4.7	4.7	20 - 68

The inductor peak-to-peak ripple current, peak current and RMS current are calculated using Equation 4, Equation 5 and Equation 6. The inductor saturation current rating must be greater than the calculated peak current and the RMS or heating current rating must be greater than the calculated RMS current.

Use 650 kHz for f_{SW} . Make sure the chosen inductor is rated for the peak current of Equation 5 and the RMS current of Equation 6.

$$I_{P-P} = \frac{V_{OUT}}{V_{IN(MAX)}} \times \frac{V_{IN(MAX)} - V_{OUT}}{L_O \times f_{SW}} \quad (4)$$

$$I_{PEAK} = I_O + \frac{I_{P-P}}{2} \quad (5)$$

$$I_{LO(RMS)} = \sqrt{I_O^2 + \frac{1}{12} I_{P-P}^2} \quad (6)$$

For this design example, the calculated peak current is 2.34 A and the calculated RMS current is 2.01 A. The inductor used is a TDK CLF7045T-2R2N with a peak current rating of 5.5 A and an RMS current rating of 4.3 A.

The capacitor value and ESR determines the amount of output voltage ripple. The TPS562219A and TPS563219A are intended for use with ceramic or other low ESR capacitors. Recommended values range from 20 μF to 68 μF. Use Equation 7 to determine the required RMS current rating for the output capacitor.

$$I_{CO(RMS)} = \frac{V_{OUT} \times (V_{IN} - V_{OUT})}{\sqrt{12} \times V_{IN} \times L_O \times f_{SW}} \quad (7)$$

For this design two TDK C3216X5R0J226M 22μF output capacitors are used. The typical ESR is 2 mΩ each. The calculated RMS current is 0.286A and each output capacitor is rated for 4A.

8.2.1.2.3 Input Capacitor Selection

The TPS562219A and TPS563219A require an input decoupling capacitor and a bulk capacitor is needed depending on the application. A ceramic capacitor over 10 μF is recommended for the decoupling capacitor. An additional 0.1 μF capacitor (C3) from pin 3 to ground is optional to provide additional high frequency filtering. The capacitor voltage rating needs to be greater than the maximum input voltage.

8.2.1.2.4 Bootstrap capacitor Selection

A 0.1µF ceramic capacitor must be connected between the VBST to SW pin for proper operation. It is recommended to use a ceramic capacitor.

8.2.1.3 Application Curves

The following application curves were generated using the application circuit of [Figure 17](#).

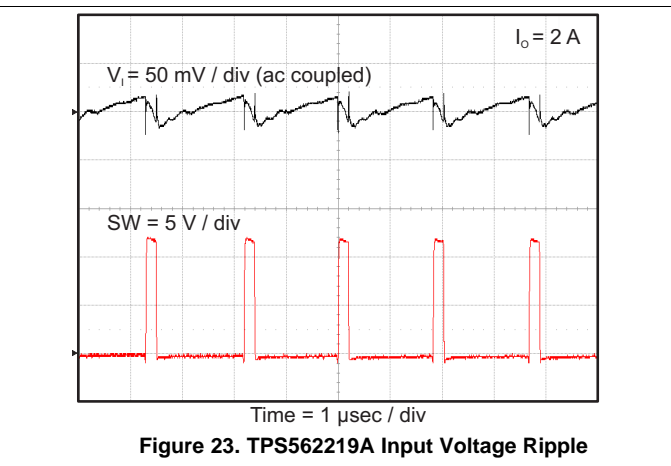
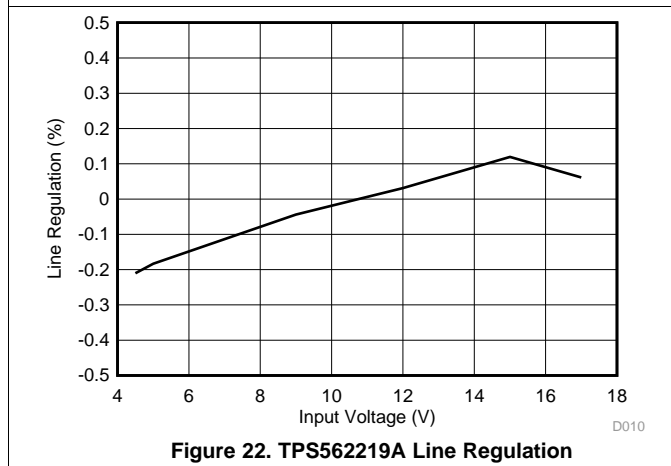
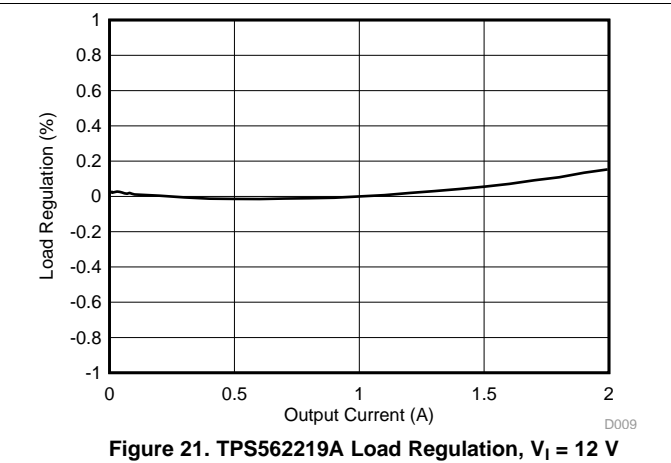
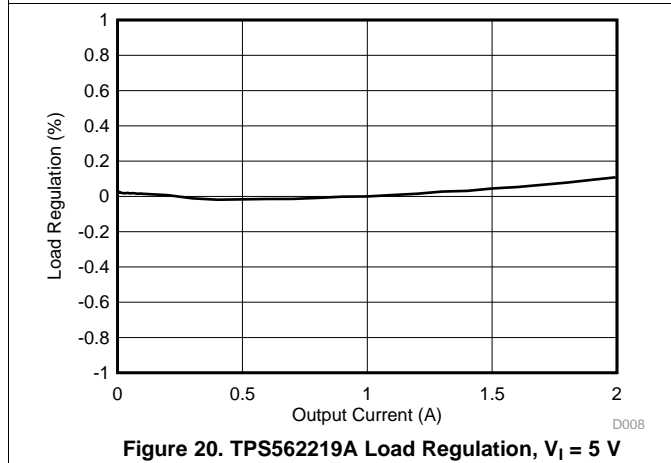
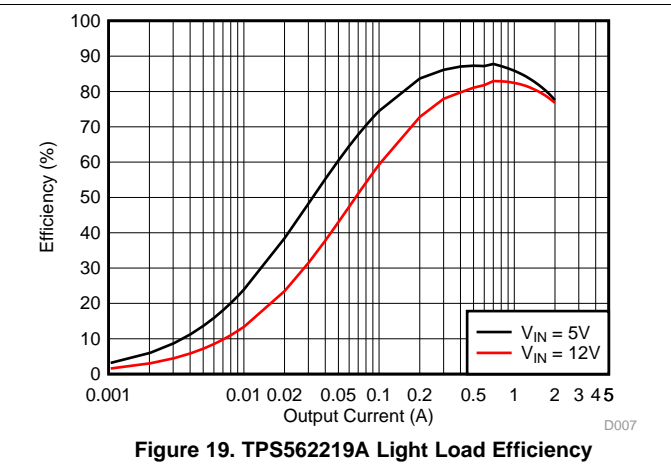
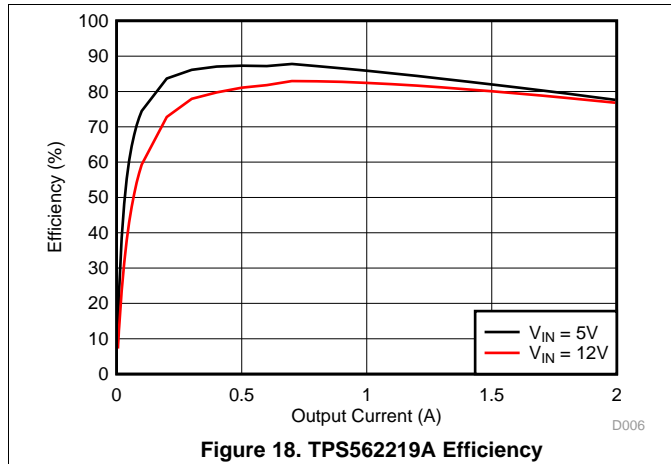

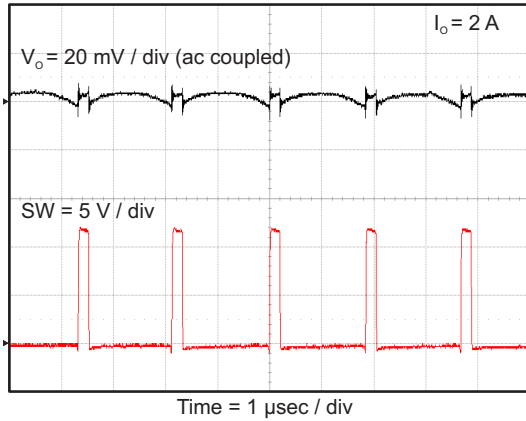

Figure 24. TPS562219A Output Voltage Ripple

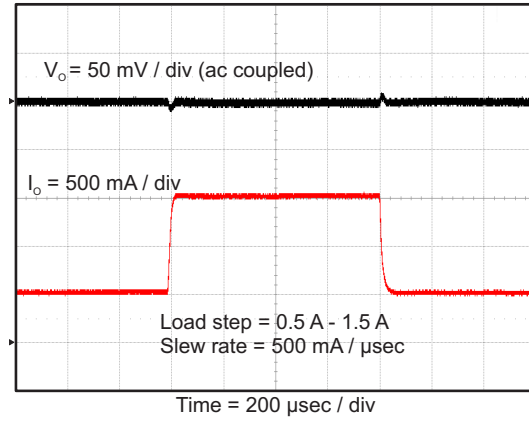

Figure 25. TPS562219A Transient Response

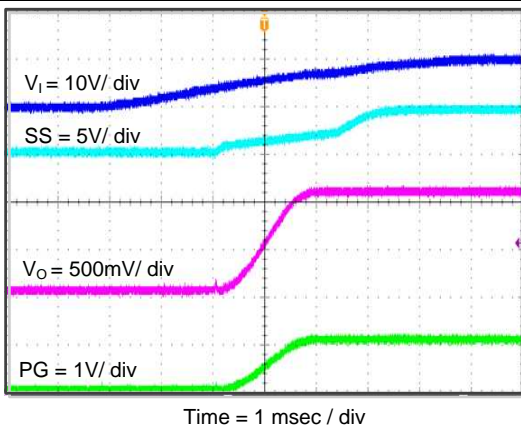

Figure 26. TPS562219A Start Up Relative To V_I

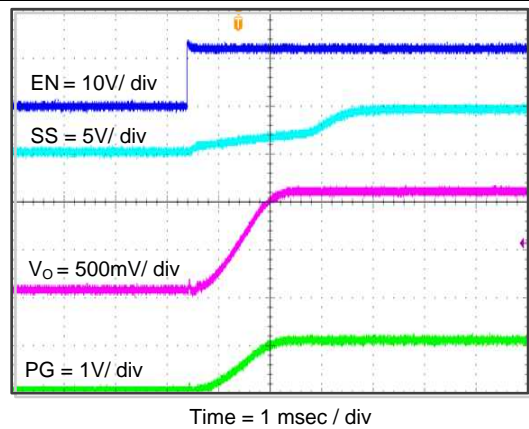

Figure 27. TPS562219A Start Up Relative To EN

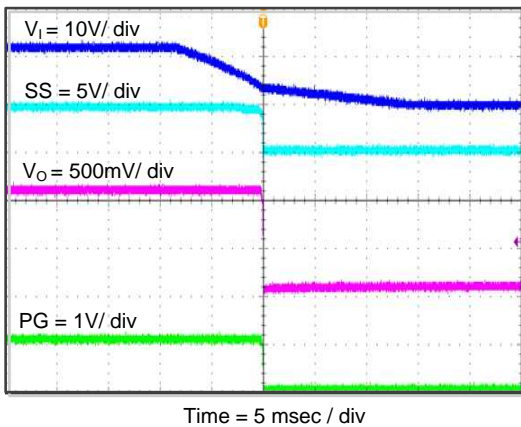

Figure 28. TPS562219A Shut Down Relative To V_I

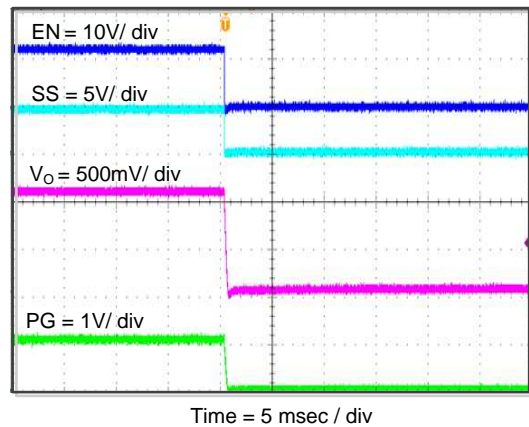
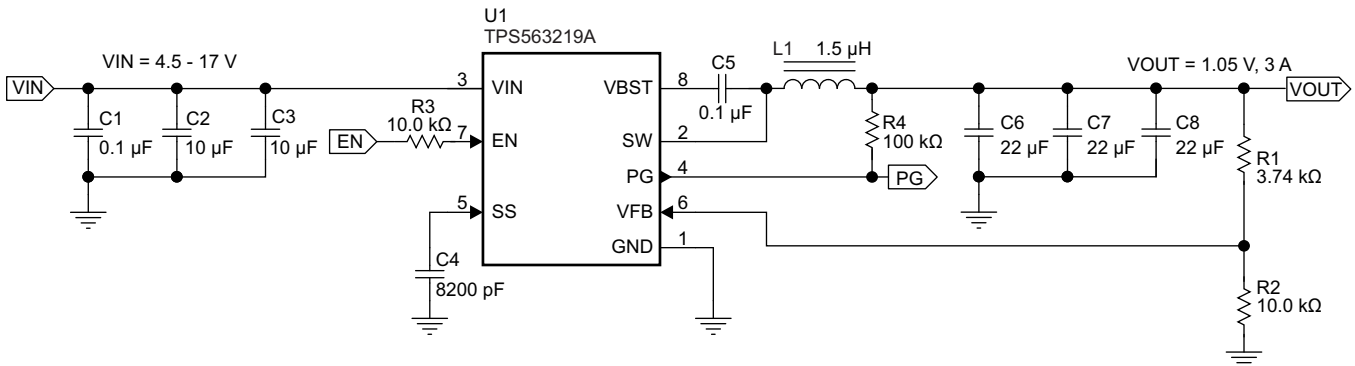

Figure 29. TPS562219A Shut Down Relative To EN

8.2.2 Typical Application, TPS563219A



Copyright © 2016, Texas Instruments Incorporated

Figure 30. TPS563219A 1.05V/3A Reference Design

8.2.2.1 Design Requirements

For this design example, use the parameters shown in Table 3.

Table 3. Design Parameters

PARAMETER	VALUE
Input voltage range	4.5 V to 17V
Output voltage	1.05V
Output current	3A
Output voltage ripple	20mVpp

8.2.2.2 Detailed Design Procedures

The detailed design procedure for TPS563219A is the same as for TPS562200 except for inductor selection.

8.2.2.2.1 Output Filter Selection

Table 4. TPS563219A Recommended Component Values

Output Voltage (V)	R2 (kΩ)	R3 (kΩ)	L1 (μH)			C6 + C7 + C8 (μF)
			MIN	TYP	MAX	
1	3.09	10.0	1.0	1.5	4.7	20 - 68
1.05	3.74	10.0	1.0	1.5	4.7	20 - 68
1.2	5.76	10.0	1.0	1.5	4.7	20 - 68
1.5	9.53	10.0	1.0	1.5	4.7	20 - 68
1.8	13.7	10.0	1.5	2.2	4.7	20 - 68
2.5	22.6	10.0	1.5	2.2	4.7	20 - 68
3.3	33.2	10.0	1.5	2.2	4.7	20 - 68
5	54.9	10.0	2.2	3.3	4.7	20 - 68
6.5	75	10.0	2.2	3.3	4.7	20 - 68

The inductor peak-to-peak ripple current, peak current and RMS current are calculated using Equation 8, Equation 9 and Equation 10. The inductor saturation current rating must be greater than the calculated peak current and the RMS or heating current rating must be greater than the calculated RMS current. Use 650 kHz for f_{SW} .

Use 650 kHz for f_{SW} . Make sure the chosen inductor is rated for the peak current of Equation 9 and the RMS current of Equation 10.

$$I_{P-P} = \frac{V_{OUT}}{V_{IN(MAX)}} \times \frac{V_{IN(MAX)} - V_{OUT}}{L_O \times f_{SW}} \tag{8}$$

$$I_{PEAK} = I_O + \frac{I_{P-P}}{2} \tag{9}$$

$$I_{LO(RMS)} = \sqrt{I_O^2 + \frac{1}{12} I_{P-P}^2} \tag{10}$$

For this design example, the calculated peak current is 3.505 A and the calculated RMS current is 3.014 A. The inductor used is a TDK CLF7045T-1R5N with a peak current rating of 7.3-A and an RMS current rating of 4.9-A.

The capacitor value and ESR determines the amount of output voltage ripple. The TPS563209 is intended for use with ceramic or other low ESR capacitors. Recommended values range from 20 μF to 68 μF. Use Equation 6 to determine the required RMS current rating for the output capacitor. For this design, three TDK C3216X5R0J226M 22 μF output capacitors are used. The typical ESR is 2 mΩ each. The calculated RMS current is 0.292 A and each output capacitor is rated for 4 A.

8.2.2.3 Application Curves

The following application curves were generated using the application circuit of Figure 30.

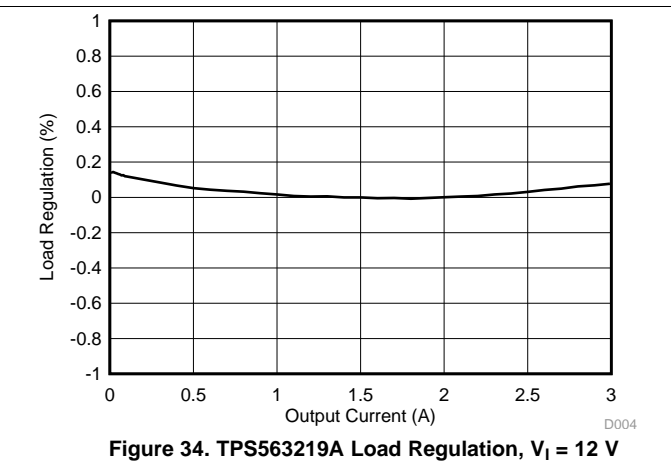
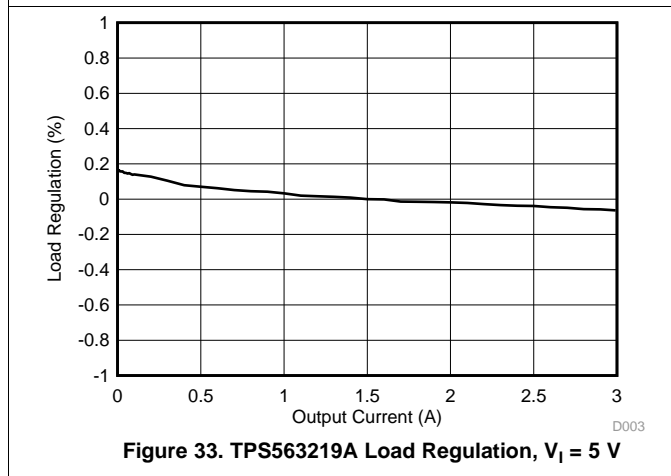
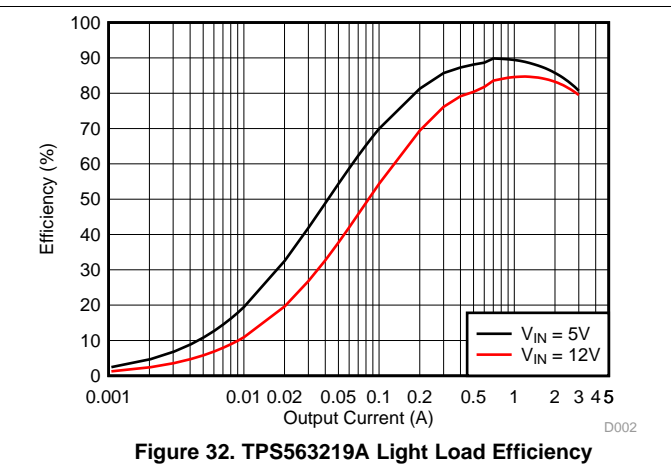
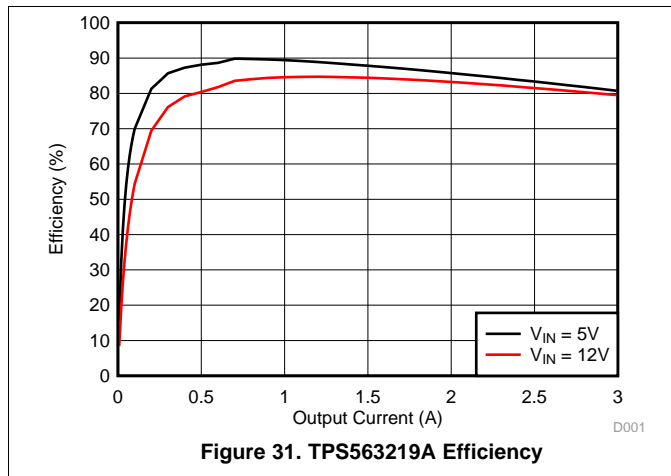

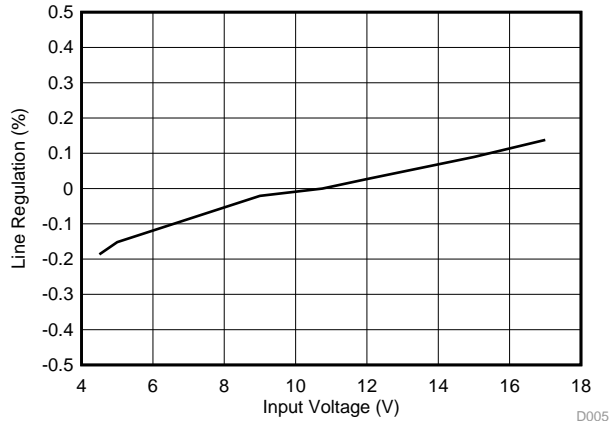

Figure 35. TPS563219A Line Regulation

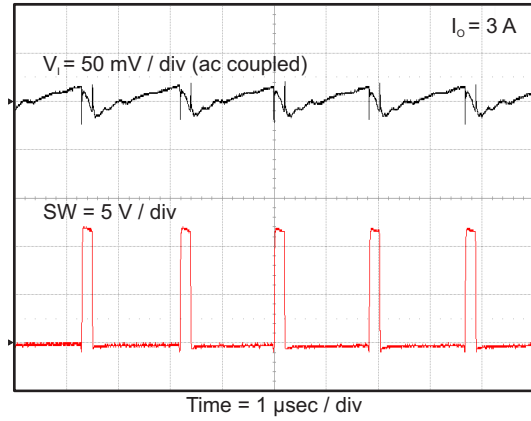

Figure 36. TPS563219A Input Voltage Ripple

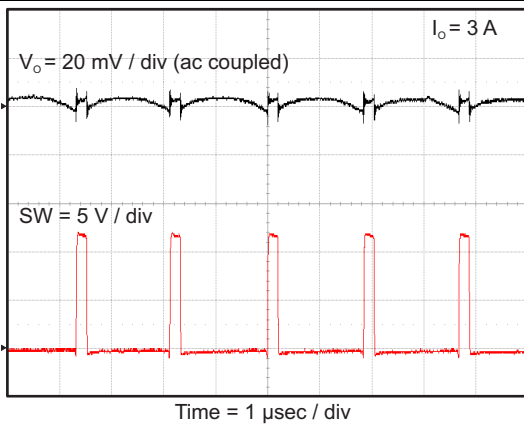

Figure 37. TPS563219A Output Voltage Ripple

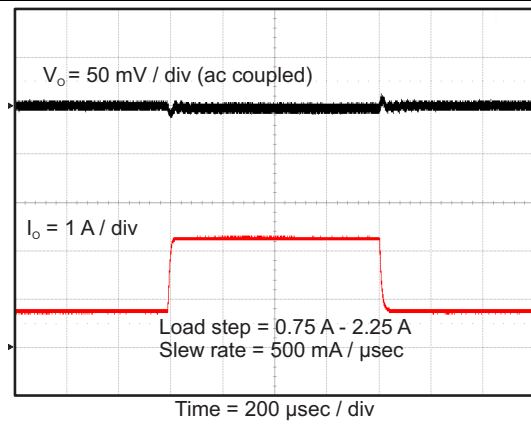

Figure 38. TPS563219A Transient Response

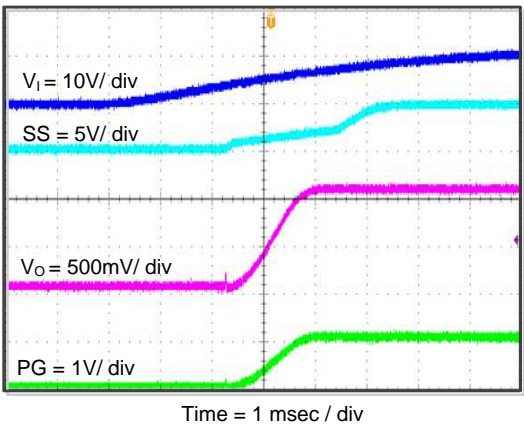

Figure 39. TPS563219A Start Up Relative To V₁

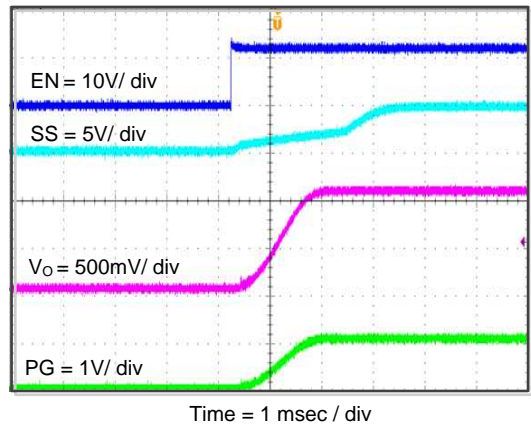
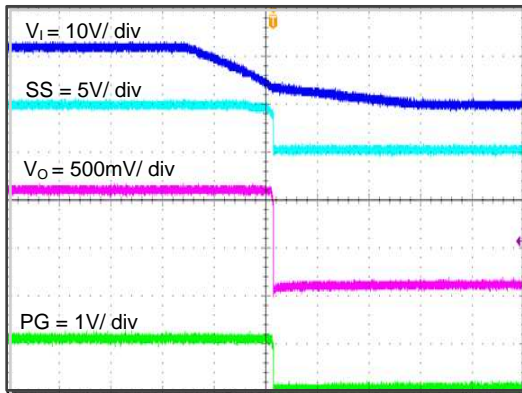
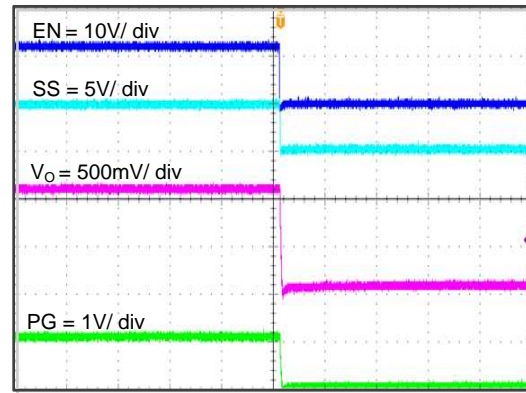

Figure 40. TPS563219A Start Up Relative To EN



Time = 5 msec / div

Figure 41. TPS563219A Shut Down Relative To V_i



Time = 5 msec / div

Figure 42. TPS563219A Shut Down Relative To EN

9 Power Supply Recommendations

The TPS562209 and TPS563209 are designed to operate from input supply voltage in the range of 4.5V to 17V. Buck converters require the input voltage to be higher than the output voltage for proper operation. The maximum recommended operating duty cycle is 65%. Using that criteria, the minimum recommended input voltage is $V_O / 0.65$.

10 Layout

10.1 Layout Guidelines

- VIN and GND traces should be as wide as possible to reduce trace impedance. The wide areas are also of advantage from the view point of heat dissipation.
- The input capacitor and output capacitor should be placed as close to the device as possible to minimize trace impedance.
- Provide sufficient vias for the input capacitor and output capacitor.
- Keep the SW trace as physically short and wide as practical to minimize radiated emissions.
- Do not allow switching current to flow under the device.
- A separate VOUT path should be connected to the upper feedback resistor.
- Make a Kelvin connection to the GND pin for the feedback path.
- Voltage feedback loop should be placed away from the high-voltage switching trace, and preferably has ground shield.
- The trace of the VFB node should be as small as possible to avoid noise coupling.
- The GND trace between the output capacitor and the GND pin should be as wide as possible to minimize its trace impedance.

10.2 Layout Example

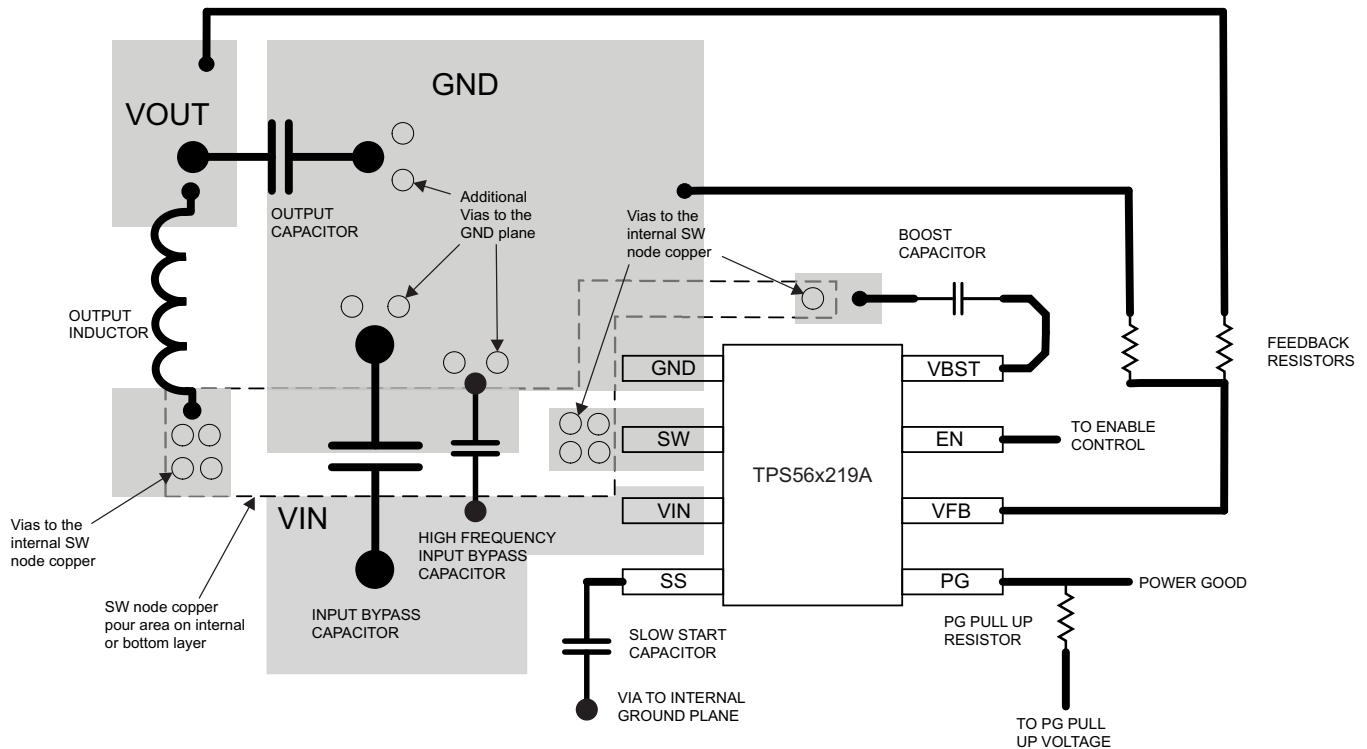

11 Device and Documentation Support

11.1 Device Support

11.2 Documentation Support

11.3 Related Links

The table below lists quick access links. Categories include technical documents, support and community resources, tools and software, and quick access to sample or buy.

Table 5. Related Links

PARTS	PRODUCT FOLDER	SAMPLE & BUY	TECHNICAL DOCUMENTS	TOOLS & SOFTWARE	SUPPORT & COMMUNITY
TPS562219A	Click here	Click here	Click here	Click here	Click here
TPS563219A	Click here	Click here	Click here	Click here	Click here

11.4 Receiving Notification of Documentation Updates

To receive notification of documentation updates, navigate to the device product folder on ti.com. In the upper right corner, click on *Alert me* to register and receive a weekly digest of any product information that has changed. For change details, review the revision history included in any revised document.

11.5 Community Resources

The following links connect to TI community resources. Linked contents are provided "AS IS" by the respective contributors. They do not constitute TI specifications and do not necessarily reflect TI's views; see TI's [Terms of Use](#).

TI E2E™ Online Community *TI's Engineer-to-Engineer (E2E) Community*. Created to foster collaboration among engineers. At e2e.ti.com, you can ask questions, share knowledge, explore ideas and help solve problems with fellow engineers.

Design Support *TI's Design Support* Quickly find helpful E2E forums along with design support tools and contact information for technical support.

11.6 Trademarks

D-CAP2, E2E are trademarks of Texas Instruments.
 Blu-ray Disc is a trademark of Blu-ray Disc Association.
 All other trademarks are the property of their respective owners.

11.7 Electrostatic Discharge Caution



This integrated circuit can be damaged by ESD. Texas Instruments recommends that all integrated circuits be handled with appropriate precautions. Failure to observe proper handling and installation procedures can cause damage.

ESD damage can range from subtle performance degradation to complete device failure. Precision integrated circuits may be more susceptible to damage because very small parametric changes could cause the device not to meet its published specifications.

11.8 Glossary

SLYZ022 — *TI Glossary*.

This glossary lists and explains terms, acronyms, and definitions.

12 Mechanical, Packaging, and Orderable Information

The following pages include mechanical, packaging, and orderable information. This information is the most current data available for the designated devices. This data is subject to change without notice and revision of this document. For browser-based versions of this data sheet, refer to the left-hand navigation.

PACKAGING INFORMATION

Orderable Device	Status (1)	Package Type	Package Drawing	Pins	Package Qty	Eco Plan (2)	Lead finish/ Ball material (6)	MSL Peak Temp (3)	Op Temp (°C)	Device Marking (4/5)	Samples
TPS562219ADDFR	ACTIVE	SOT-23-THIN	DDF	8	3000	RoHS & Green	SN	Level-1-260C-UNLIM	-40 to 85	2219A	Samples
TPS562219ADDFT	ACTIVE	SOT-23-THIN	DDF	8	250	RoHS & Green	SN	Level-1-260C-UNLIM	-40 to 85	2219A	Samples
TPS563219ADDFR	ACTIVE	SOT-23-THIN	DDF	8	3000	RoHS & Green	SN	Level-1-260C-UNLIM	-40 to 85	3219A	Samples
TPS563219ADDFT	ACTIVE	SOT-23-THIN	DDF	8	250	RoHS & Green	SN	Level-1-260C-UNLIM	-40 to 85	3219A	Samples

(1) The marketing status values are defined as follows:

ACTIVE: Product device recommended for new designs.

LIFEBUY: TI has announced that the device will be discontinued, and a lifetime-buy period is in effect.

NRND: Not recommended for new designs. Device is in production to support existing customers, but TI does not recommend using this part in a new design.

PREVIEW: Device has been announced but is not in production. Samples may or may not be available.

OBSELETE: TI has discontinued the production of the device.

(2) **RoHS:** TI defines "RoHS" to mean semiconductor products that are compliant with the current EU RoHS requirements for all 10 RoHS substances, including the requirement that RoHS substance do not exceed 0.1% by weight in homogeneous materials. Where designed to be soldered at high temperatures, "RoHS" products are suitable for use in specified lead-free processes. TI may reference these types of products as "Pb-Free".

RoHS Exempt: TI defines "RoHS Exempt" to mean products that contain lead but are compliant with EU RoHS pursuant to a specific EU RoHS exemption.

Green: TI defines "Green" to mean the content of Chlorine (Cl) and Bromine (Br) based flame retardants meet JS709B low halogen requirements of <=1000ppm threshold. Antimony trioxide based flame retardants must also meet the <=1000ppm threshold requirement.

(3) MSL, Peak Temp. - The Moisture Sensitivity Level rating according to the JEDEC industry standard classifications, and peak solder temperature.

(4) There may be additional marking, which relates to the logo, the lot trace code information, or the environmental category on the device.

(5) Multiple Device Markings will be inside parentheses. Only one Device Marking contained in parentheses and separated by a "-" will appear on a device. If a line is indented then it is a continuation of the previous line and the two combined represent the entire Device Marking for that device.

(6) Lead finish/Ball material - Orderable Devices may have multiple material finish options. Finish options are separated by a vertical ruled line. Lead finish/Ball material values may wrap to two lines if the finish value exceeds the maximum column width.

Important Information and Disclaimer:The information provided on this page represents TI's knowledge and belief as of the date that it is provided. TI bases its knowledge and belief on information provided by third parties, and makes no representation or warranty as to the accuracy of such information. Efforts are underway to better integrate information from third parties. TI has taken and

continues to take reasonable steps to provide representative and accurate information but may not have conducted destructive testing or chemical analysis on incoming materials and chemicals. TI and TI suppliers consider certain information to be proprietary, and thus CAS numbers and other limited information may not be available for release.

In no event shall TI's liability arising out of such information exceed the total purchase price of the TI part(s) at issue in this document sold by TI to Customer on an annual basis.

TAPE AND REEL INFORMATION

QUADRANT ASSIGNMENTS FOR PIN 1 ORIENTATION IN TAPE

*All dimensions are nominal

Device	Package Type	Package Drawing	Pins	SPQ	Reel Diameter (mm)	Reel Width W1 (mm)	A0 (mm)	B0 (mm)	K0 (mm)	P1 (mm)	W (mm)	Pin1 Quadrant
TPS562219ADDFR	SOT-23-THIN	DDF	8	3000	180.0	9.5	3.17	3.1	1.1	4.0	8.0	Q3
TPS562219ADDFT	SOT-23-THIN	DDF	8	250	180.0	9.5	3.17	3.1	1.1	4.0	8.0	Q3
TPS563219ADDFR	SOT-23-THIN	DDF	8	3000	180.0	9.5	3.17	3.1	1.1	4.0	8.0	Q3
TPS563219ADDFT	SOT-23-THIN	DDF	8	250	180.0	9.5	3.17	3.1	1.1	4.0	8.0	Q3

TAPE AND REEL BOX DIMENSIONS

*All dimensions are nominal

Device	Package Type	Package Drawing	Pins	SPQ	Length (mm)	Width (mm)	Height (mm)
TPS562219ADDFR	SOT-23-THIN	DDF	8	3000	184.0	184.0	19.0
TPS562219ADDFT	SOT-23-THIN	DDF	8	250	184.0	184.0	19.0
TPS563219ADDFR	SOT-23-THIN	DDF	8	3000	184.0	184.0	19.0
TPS563219ADDFT	SOT-23-THIN	DDF	8	250	184.0	184.0	19.0

DDF0008A



PACKAGE OUTLINE

SOT-23-THIN - 1.1 mm max height

PLASTIC SMALL OUTLINE



4222047/E 07/2024

NOTES:

1. All linear dimensions are in millimeters. Any dimensions in parenthesis are for reference only. Dimensioning and tolerancing per ASME Y14.5M.
2. This drawing is subject to change without notice.
3. This dimension does not include mold flash, protrusions, or gate burrs. Mold flash, protrusions, or gate burrs shall not exceed 0.15 mm per side.

EXAMPLE BOARD LAYOUT

DDF0008A

SOT-23-THIN - 1.1 mm max height

PLASTIC SMALL OUTLINE



LAND PATTERN EXAMPLE
EXPOSED METAL SHOWN
SCALE:15X



SOLDER MASK DETAILS

4222047/E 07/2024

NOTES: (continued)

- 4. Publication IPC-7351 may have alternate designs.
- 5. Solder mask tolerances between and around signal pads can vary based on board fabrication site.

EXAMPLE STENCIL DESIGN

DDF0008A

SOT-23-THIN - 1.1 mm max height

PLASTIC SMALL OUTLINE



SOLDER PASTE EXAMPLE
BASED ON 0.125 mm THICK STENCIL
SCALE:15X

4222047/E 07/2024

NOTES: (continued)

6. Laser cutting apertures with trapezoidal walls and rounded corners may offer better paste release. IPC-7525 may have alternate design recommendations.
7. Board assembly site may have different recommendations for stencil design.

IMPORTANT NOTICE AND DISCLAIMER

TI PROVIDES TECHNICAL AND RELIABILITY DATA (INCLUDING DATA SHEETS), DESIGN RESOURCES (INCLUDING REFERENCE DESIGNS), APPLICATION OR OTHER DESIGN ADVICE, WEB TOOLS, SAFETY INFORMATION, AND OTHER RESOURCES "AS IS" AND WITH ALL FAULTS, AND DISCLAIMS ALL WARRANTIES, EXPRESS AND IMPLIED, INCLUDING WITHOUT LIMITATION ANY IMPLIED WARRANTIES OF MERCHANTABILITY, FITNESS FOR A PARTICULAR PURPOSE OR NON-INFRINGEMENT OF THIRD PARTY INTELLECTUAL PROPERTY RIGHTS.

These resources are intended for skilled developers designing with TI products. You are solely responsible for (1) selecting the appropriate TI products for your application, (2) designing, validating and testing your application, and (3) ensuring your application meets applicable standards, and any other safety, security, regulatory or other requirements.

These resources are subject to change without notice. TI grants you permission to use these resources only for development of an application that uses the TI products described in the resource. Other reproduction and display of these resources is prohibited. No license is granted to any other TI intellectual property right or to any third party intellectual property right. TI disclaims responsibility for, and you will fully indemnify TI and its representatives against, any claims, damages, costs, losses, and liabilities arising out of your use of these resources.

TI's products are provided subject to [TI's Terms of Sale](#) or other applicable terms available either on [ti.com](https://www.ti.com) or provided in conjunction with such TI products. TI's provision of these resources does not expand or otherwise alter TI's applicable warranties or warranty disclaimers for TI products.

TI objects to and rejects any additional or different terms you may have proposed.

Mailing Address: Texas Instruments, Post Office Box 655303, Dallas, Texas 75265
Copyright © 2024, Texas Instruments Incorporated