

PGA460-Q1 EVM Quick Start Guide

This guide is designed to help with the initial setup of the PGA460-Q1 EVM and GUI. Use this quick start guide as a reference to connect the PGA460 device to an ultrasonic transducer, flash program the USB interface, power on the EVM, use the BOOSTXL-PGA460 GUI to configure the PGA460 ultrasonic signal conditioner IC, and read back ultrasonic echo information. For more information, go to www.ti.com/product/PGA460-Q1 and www.ti.com/tool/PGA460-Q1EVM.

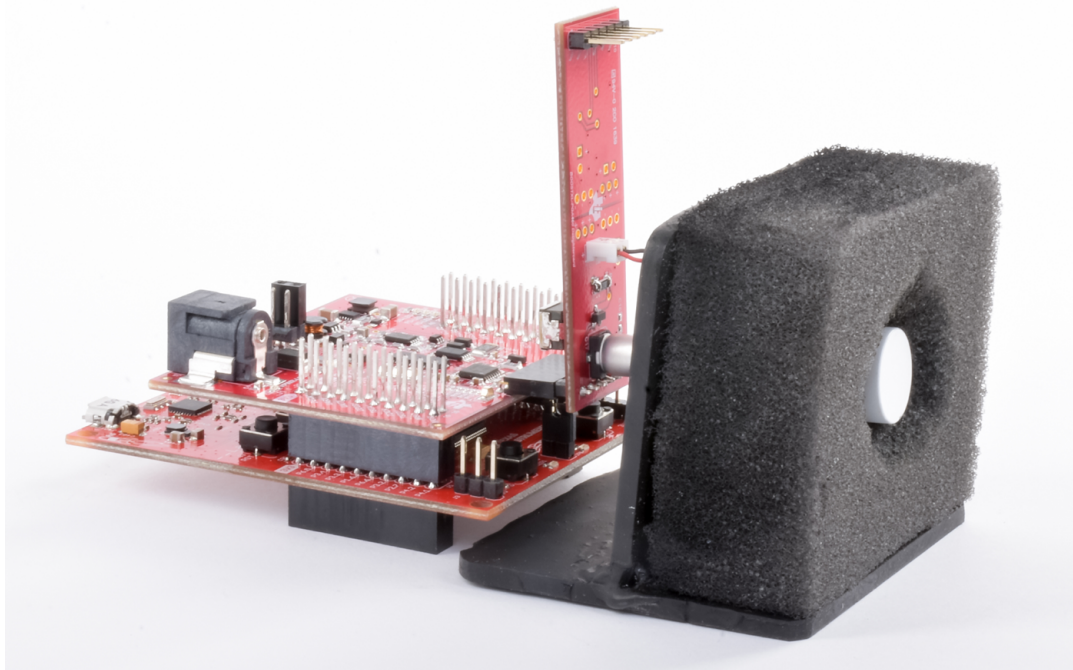

Note: Transducer stand and foam block not included.

Figure 1. BOOSTXL-PGA460 Transformer Driven Mode and Closed-Top Transducer

Contents

1	Introduction to BOOSTXL-PGA460	2
2	Hardware Setup	3
3	One-Time MSP-EXP430F5529LP Flash Programming	4
4	Software Setup	5
5	Block Diagram Optimization	6

Trademarks

All trademarks are the property of their respective owners.

1 Introduction to BOOSTXL-PGA460

This guide is designed to help with the initial setup of the PGA460-Q1 EVM and GUI. Use this quick start guide as a reference to connect the PGA460 device to an ultrasonic transducer, flash program the USB interface, power on the EVM, use the BOOSTXL-PGA460 GUI to configure the PGA460 ultrasonic signal conditioner IC, and read back ultrasonic echo information. All contents and instructions of this guide assume that the user has the MSP-EXP430F5529LP, BOOSTXL-PGA460 motherboard, BOOSTXL-PGA460 daughtercard with an attached ultrasonic sensor, and PGA460-Q1 GUI installed on a PC. To download the GUI, go to www.ti.com/product/PGA460-Q1.



The BOOSTXL-PGA460 EVM kit includes the following:

- Hardware
 - BOOSTXL-PGA460 motherboard
 - PGA460-Q1 ultrasonic sensor signal conditioner IC
 - Optional integrated-switch boost converter, TI's [LMR62421](#), to generate a 7.2 V output to power the PGA460 device when only using USB for power
 - Optional integrated-switch buck converter, TI's [TPS62175](#), to generate a 5 V output to power the MSP-EXP430F5529LP when only using a battery or external supply
 - 8-channel SPDT multiplexer or demultiplexer, TI's [TS3L501E](#), to switch between asynchronous UART, synchronous UART, TCI, or one-wire UART interface communication modes available on the PGA460 device
 - Discrete two-wire to one-wire interface (OWI) transceiver circuit using TI's [LM2903](#) device to enable TCI and one-wire UART communication
 - Onboard external 512 kB of SRAM to store synchronous output data from the PGA460 device
 - BOOSTXL-PGA460 daughtercard
 - Used for multiple test points for key analog, digital, and test signals
 - MSP-EXP430F5529LP
 - Used as the USB-to-PC GUI communication bridge, and example implementation of a master MCU to communicate with the PGA460 device through USART, IO interfaces, or both.
- Printed documents
 - *BOOSTXL-PGA460 Quick Start Guide*
- Miscellaneous
 - One micro-USB 2.0 cable, 2 ft
 - Default, out-of-box, jumper configurations

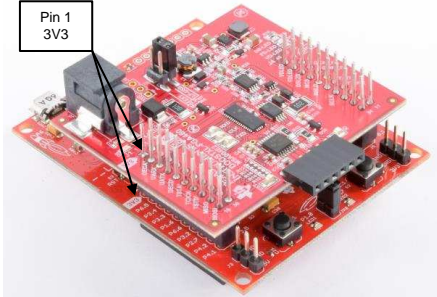
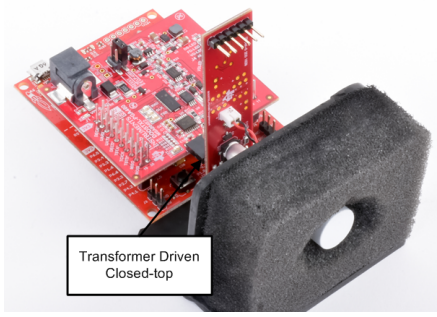
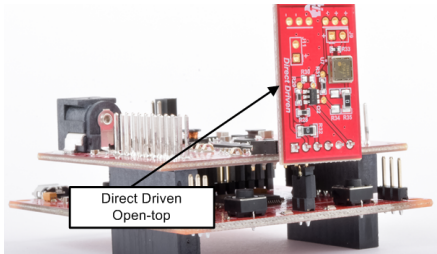
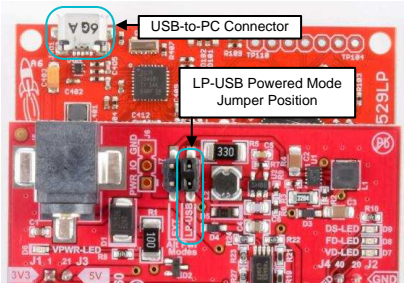
2 Hardware Setup

Description	Image
<p>The BOOSTXL-PGA460 motherboard must stack on top of the MSP-EXP430F5529LP. Ensure pin 1 of the MSP-EXP430F5529LP aligns with pin 1 of the BOOSTXL-PGA460.</p> <p>Figure 2 shows pin 1 on both the MSP-EXP430F5529LP and BOOSTXL-PGA460.</p>	 <p>Figure 2. BOOSTXL-PGA460 Motherboard Stacked on MSP-EXP430F5529LP</p>
<p>The BOOSTXL-PGA460 daughtercard connects perpendicularly to the motherboard at J8 to enable either of the available driver modes and top-type configurations. The transformer-driven closed-top configuration is accessible at J13 of the daughtercard (see Figure 3). The bridge-driven open-top configuration is accessible at J10 of the daughtercard (see Figure 4).</p> <p>If the transformer-driven closed-top configuration is selected, use a sponge-like material to hold the transducer in place (see Figure 3).</p> <p>Aim the transducer in the direction of the target, such as a wall, box, or pole.</p>	 <p>Figure 3. Transformer Driven Mode and Closed-Top Transducer</p>  <p>Figure 4. Direct Driven Mode and Open-Top Transducer</p>
<p>Position the alternative power-mode jumper for the intended use-case. For the purpose of quick startup, set the jumper to LP-USB powered mode (see Figure 5).</p> <p>Connect the micro-USB cable from the MSP-EXP430F5529LP to a PC (see Figure 5).</p> <p>If using an external power supply, turn on the supply.</p>	 <p>Figure 5. LP-USB Powered Mode Jumper Configuration</p>

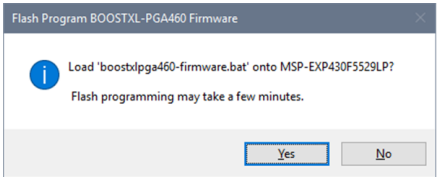
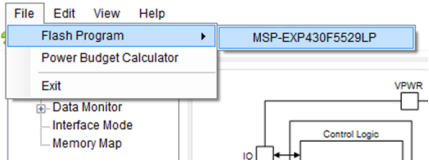
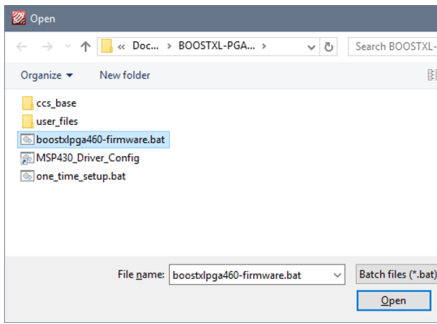
3 One-Time MSP-EXP430F5529LP Flash Programming

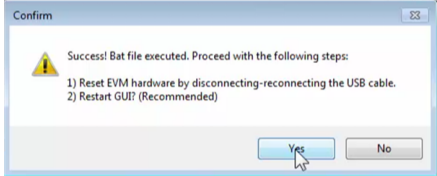
Description	Image
<p>Open the PGA460-Q1 GUI by running the executable (.exe) file. The GUI automatically prompts the user to flash program the MSP-EXP430F5529LP (see Figure 6). This procedure is only required once when the the EVM is connected to the GUI for the first time. The user will not be prompted to flash program the MSP again for future use.</p> <p>If the GUI does not automatically prompt the user to flash program the MSP, the user can manually force the flash programming routine by navigating to the <i>File</i> menu, <i>Flash Program</i>, and <i>MSP-EXP430F5529LP</i>.</p>	 <p>Figure 6. Flash-Programming Prompt for MSP-EXP430F5529LP</p>  <p>Figure 7. Manually Flash-Program MSP-EXP430F5529LP</p>
<p>The file explorer should initialize in the <i>My Documents, BOOSTXL-PGA460</i> folder. Open the batch file (.bat) named <i>boostxpga460-firmware.bat</i>. This directory and file is created during the installation procedure of the PGA460-Q1 GUI.</p>	 <p>Figure 8. Flash-Programming Batch File</p>
<p>Flash programming the MSP can occur for several minutes (see Figure 9).</p> <p>Do not interact or click on any of the GUI elements until the programming routine is complete. The LED101 and LED102 of the MSP-EXP430F5529LP will toggle red and green during the programming routine. Do not disconnect the USB during the programming routine.</p>	 <p>Figure 9. Flash-Programming Status Indicators</p>
<p>When the batch file has been successfully programmed onto the MSP, the user will be prompted to first disconnect-and-reconnect the USB cable, and then restart the GUI (see Figure 10).</p>	 <p>Figure 10. Prompt to Reset EVM Hardware and GUI</p>

4 Software Setup

Description	Image
<p>Open the BOOSTXL-PGA460 GUI by running the .exe file. Ensure the <i>EVM Status</i> block at the bottom left of the GUI reports that the USB Controller is <i>Connected</i>, and the PGA460 device is <i>Ready</i> (see Figure 11).</p>	 <p>Figure 11. EVM Status Box Showing Successful Connection</p>
<p>The GUI first loads the <i>Block Diagram</i> page by default. Depending on the selected transducer of the daughtercard, the block diagram settings will default according to the associated button at the bottom of the page (see Figure 12).</p>	 <p>Figure 12. Default PGA460 Register Settings Based on Specific Transducer</p>
<p>Navigate to the <i>Data Monitor</i> page and ensure the <i>Run Options</i> are set to Preset <i>P1</i> and Command <i>Burst & Listen</i>. Ensure the <i>Ultrasonic Echo Display Format</i> checkbox, <i>Plot Data Dump</i>, is checked.</p>	 <p>Figure 13. Run Options Required To Display Echo Data Dump</p>
<p>Click the <i>START</i> button. A <i>Threshold Status</i> warning dialog box will appear. To clear the threshold (THR) CRC error, click the <i>Yes</i> button. The device will then be loaded with the mid-code threshold level and timing values. This warning only appears during the first attempt to perform a <i>Burst & Listen</i> command. For more information on manually setting the threshold, refer to the PGA460-Q1 Ultrasonic Signal Conditioner EVM With Transducer User's Guide.</p>	 <p>Figure 14. Prompt to Write Mid-Code Threshold Values</p>
<p>After the run cycle is complete, the echo data dump is plotted against the threshold, time-varying gain, digital gain, and nonlinear scaling. To enable the <i>Ultrasonic Measurement Results</i> table, check the <i>List Measurement Results</i> checkbox in the display format options (see Figure 13), and click the <i>START</i> button again.</p>	 <p>Figure 15. Example of 2.2-m Object Detection on Echo Data Dump</p>

5 Block Diagram Optimization

To further optimize the PGA460 device settings, return to the *Block Diagram* page. The block diagram perspective offers three control groups (see [Figure 16](#)).

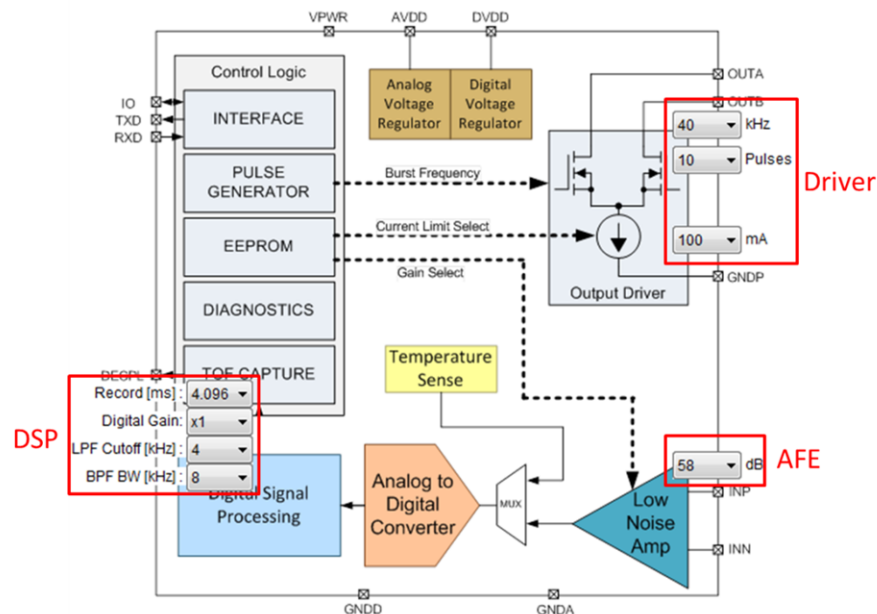

Figure 16. Block Diagram Configuration

Driver — The driving frequency, pulse count, and driving current limit are set with this group. This group is specific to the generation and transmission of an ultrasonic echo. The frequency of a single transducer is fixed, but the drive strength can be reduced or increased using the number of pulses and current limit.

Analog front-end (AFE) — The gain selected on the block diagram view sets all levels of the time-varying gain to the same gain level. This group is specific to amplifying the raw ultrasonic echo received. A small gain is favorable for short range measurements to prevent saturation of the returning ultrasonic signal. A large gain is favorable for long-range measurements.

Digital signal processing (DSP) — The bandpass filter bandwidth, low-pass filter cutoff, short and long range digital gain, and record length are able to process the digitized ultrasonic echo received from the AFE into a coherent data format. The record length time equates to the maximum distance for which the PGA460 device will process incoming information. If the object is far (up to 10 m), maximize the record length setting.

Although the PGA460 has two presets, only Preset 1 is updated when configuring the device from the block-diagram control perspective. Preset 2 must be configured using the *General* page.

IMPORTANT NOTICE FOR TI DESIGN INFORMATION AND RESOURCES

Texas Instruments Incorporated ("TI") technical, application or other design advice, services or information, including, but not limited to, reference designs and materials relating to evaluation modules, (collectively, "TI Resources") are intended to assist designers who are developing applications that incorporate TI products; by downloading, accessing or using any particular TI Resource in any way, you (individually or, if you are acting on behalf of a company, your company) agree to use it solely for this purpose and subject to the terms of this Notice.

TI's provision of TI Resources does not expand or otherwise alter TI's applicable published warranties or warranty disclaimers for TI products, and no additional obligations or liabilities arise from TI providing such TI Resources. TI reserves the right to make corrections, enhancements, improvements and other changes to its TI Resources.

You understand and agree that you remain responsible for using your independent analysis, evaluation and judgment in designing your applications and that you have full and exclusive responsibility to assure the safety of your applications and compliance of your applications (and of all TI products used in or for your applications) with all applicable regulations, laws and other applicable requirements. You represent that, with respect to your applications, you have all the necessary expertise to create and implement safeguards that (1) anticipate dangerous consequences of failures, (2) monitor failures and their consequences, and (3) lessen the likelihood of failures that might cause harm and take appropriate actions. You agree that prior to using or distributing any applications that include TI products, you will thoroughly test such applications and the functionality of such TI products as used in such applications. TI has not conducted any testing other than that specifically described in the published documentation for a particular TI Resource.

You are authorized to use, copy and modify any individual TI Resource only in connection with the development of applications that include the TI product(s) identified in such TI Resource. NO OTHER LICENSE, EXPRESS OR IMPLIED, BY ESTOPPEL OR OTHERWISE TO ANY OTHER TI INTELLECTUAL PROPERTY RIGHT, AND NO LICENSE TO ANY TECHNOLOGY OR INTELLECTUAL PROPERTY RIGHT OF TI OR ANY THIRD PARTY IS GRANTED HEREIN, including but not limited to any patent right, copyright, mask work right, or other intellectual property right relating to any combination, machine, or process in which TI products or services are used. Information regarding or referencing third-party products or services does not constitute a license to use such products or services, or a warranty or endorsement thereof. Use of TI Resources may require a license from a third party under the patents or other intellectual property of the third party, or a license from TI under the patents or other intellectual property of TI.

TI RESOURCES ARE PROVIDED "AS IS" AND WITH ALL FAULTS. TI DISCLAIMS ALL OTHER WARRANTIES OR REPRESENTATIONS, EXPRESS OR IMPLIED, REGARDING TI RESOURCES OR USE THEREOF, INCLUDING BUT NOT LIMITED TO ACCURACY OR COMPLETENESS, TITLE, ANY EPIDEMIC FAILURE WARRANTY AND ANY IMPLIED WARRANTIES OF MERCHANTABILITY, FITNESS FOR A PARTICULAR PURPOSE, AND NON-INFRINGEMENT OF ANY THIRD PARTY INTELLECTUAL PROPERTY RIGHTS.

TI SHALL NOT BE LIABLE FOR AND SHALL NOT DEFEND OR INDEMNIFY YOU AGAINST ANY CLAIM, INCLUDING BUT NOT LIMITED TO ANY INFRINGEMENT CLAIM THAT RELATES TO OR IS BASED ON ANY COMBINATION OF PRODUCTS EVEN IF DESCRIBED IN TI RESOURCES OR OTHERWISE. IN NO EVENT SHALL TI BE LIABLE FOR ANY ACTUAL, DIRECT, SPECIAL, COLLATERAL, INDIRECT, PUNITIVE, INCIDENTAL, CONSEQUENTIAL OR EXEMPLARY DAMAGES IN CONNECTION WITH OR ARISING OUT OF TI RESOURCES OR USE THEREOF, AND REGARDLESS OF WHETHER TI HAS BEEN ADVISED OF THE POSSIBILITY OF SUCH DAMAGES.

You agree to fully indemnify TI and its representatives against any damages, costs, losses, and/or liabilities arising out of your non-compliance with the terms and provisions of this Notice.

This Notice applies to TI Resources. Additional terms apply to the use and purchase of certain types of materials, TI products and services. These include; without limitation, TI's standard terms for semiconductor products (<http://www.ti.com/sc/docs/stdterms.htm>), [evaluation modules](#), and [samples](http://www.ti.com/sc/docs/sampterm.htm) (<http://www.ti.com/sc/docs/sampterm.htm>).

Mailing Address: Texas Instruments, Post Office Box 655303, Dallas, Texas 75265
Copyright © 2017, Texas Instruments Incorporated