

**ABSTRACT**

The MSP430™ bootloader (BSL) (formerly known as the bootstrap loader) allows users to communicate with embedded memory in the MSP430 microcontroller (MCU) during the prototyping phase, final production, and in service. Both the programmable memory (flash memory) and the data memory (RAM) can be modified as required. Do not confuse the bootloader with the bootstrap loader programs found in some digital signal processors (DSPs) that automatically load program code (and data) from external memory to the internal memory of the DSP.

To use the bootloader, a specific BSL entry sequence must be applied. An added sequence of commands initiates the desired function. A bootloading session can be exited by continuing operation at a defined user program address or by the reset condition.

If the device is secured by disabling JTAG, it is still possible to use the BSL. Access to the MSP430 MCU memory through the BSL is protected against misuse by the BSL password. The BSL password is equal to the content of the interrupt vector table on the device.

Table of Contents

1 Introduction	3
1.1 Supplementary Online Information.....	3
1.2 Overview of BSL Features.....	4
1.3 BSL Invocation.....	5
1.4 UART Protocol.....	7
1.5 USB Protocol.....	7
2 Bootloader Protocol – 1xx, 2xx, and 4xx Families	8
2.1 Synchronization Sequence.....	8
2.2 Commands.....	8
2.3 Programming Flow.....	8
2.4 Data Frame.....	9
2.5 Loadable BSL.....	14
2.6 Exiting the BSL.....	14
2.7 Password Protection.....	15
2.8 Code Protection Fuse.....	15
2.9 BSL Internal Settings and Resources.....	15
3 Bootloader Protocol – F5xx and F6xx Families	19
3.1 BSL Data Packet.....	19
3.2 UART Peripheral Interface (PI).....	19
3.3 I ² C Peripheral Interface.....	20
3.4 USB Peripheral Interface.....	22
3.5 BSL Core Command Structure.....	22
3.6 BSL Security.....	24
3.7 BSL Core Responses.....	25
3.8 BSL Public Functions and Z-Area.....	27
4 Bootloader Hardware	29
4.1 Hardware Description.....	29
5 Differences Between Devices and Bootloader Versions	33
5.1 1xx, 2xx, and 4xx BSL Versions.....	33
5.2 Special Consideration for ROM BSL Version 1.10.....	40
5.3 1xx, 2xx, and 4xx BSL Known Issues.....	41
5.4 Special Note on the MSP430F14x Device Family BSL.....	41
5.5 F5xx and F6xx Flash-Based BSL Versions.....	42

6 Bootloader PCB Layout Suggestion	48
7 Revision History	51

List of Figures

Figure 1-1. Standard RESET Sequence.....	5
Figure 1-2. BSL Entry Sequence at Shared JTAG Pins.....	5
Figure 1-3. BSL Entry Sequence at Dedicated JTAG Pins.....	6
Figure 3-1. Basic Protocol - Byte Level ACK.....	20
Figure 3-2. Byte Level ACK.....	21
Figure 4-1. Bootloader Interface Schematic.....	29
Figure 6-1. Universal BSL Interface PCB Layout, Top.....	48
Figure 6-2. Universal BSL Interface PCB Layout, Bottom.....	48
Figure 6-3. Universal BSL Interface Component Placement.....	49
Figure 6-4. Universal BSL Interface Component Placement.....	50

Trademarks

MSP430™ and TI E2E™ are trademarks of Texas Instruments.
 All trademarks are the property of their respective owners.

1 Introduction

The bootloader provides a method to program the flash memory during MSP430 project development and updates. It can be activated by a utility that sends commands using the UART protocol. The BSL enables the user to control the activity of the MSP430 MCU and to exchange data using a personal computer or other device.

To avoid accidental overwriting of the BSL code, this code is stored in a secure memory location, either ROM or specially protected flash. To prevent unwanted source readout, any BSL command that directly or indirectly allows data reading is password protected.

To invoke the bootloader, a BSL entry sequence must be applied to dedicated pins. After that, a synchronization character, followed by the data frame of a specific command, initiates the desired function.

1.1 Supplementary Online Information

As a compliment to this document, visit [Bootloader \(BSL\) for MSP low-power microcontrollers](#). This page contains links to additional BSL user's guides, source code, firmware images, and the BSL scripter with documentation and code examples.

Additional support is provided by the [TI E2E™ support forums](#).

1.2 Overview of BSL Features

Table 1-1 summarizes the BSL features of the MSP430 MCUs, organized by device family.

Table 1-1. BSL Overview

		MSP430									
		F20xx, G2xx0, G2xx1, G2xx2, I20xx	F1xx, F2xx, F4xx, G2xx3	F5xx, F6xx ⁽¹⁾		FR5xx, FR6xx		FR231x, FR242x,F R243x FR25xx, FR263x	FR215x, FR235x, FR247x, FR267x	FR20xx, FR21xx, FR41xx	
				Non-USB	USB	Factory	Crypto- Boot- loader ⁽⁴⁾				
General	BSL memory type	No BSL	ROM	Flash ⁽²⁾	Flash ⁽²⁾	ROM	FRAM	ROM	ROM	ROM	
	BSL memory size	N/A	1 KB	2 KB	2 KB	2 KB	4 KB	3 KB	3 KB	1 KB	
	Peripheral configured by TLV					✓	✓		✓		
	User configuration								✓		
	UART		✓	✓		✓	✓	✓	✓	✓	
	I ² C			✓		✓	✓	✓	✓		
	SPI										
	USB				✓						
Protocol	'1xx, 2xx, 4xx' protocol		✓								
	'5xx, 6xx' protocol			✓	✓	✓	✓	✓	✓	✓	
Invoke mechanism	Entry sequence on I/Os	Sequence on TEST/RST	✓	✓		✓	✓	✓	✓	✓	
		PUR pin tied to V _{USB}			✓						
		Sequence on defined I/O						✓			
	Empty reset vector invokes BSL				✓		✓	✓	✓		
	Calling BSL from software application		✓	✓	✓	✓	✓	✓	✓	✓	
	Invalid or incomplete application							✓			
Tools Support	Hardware	MSP-BSL 'Rocket'	✓	✓		✓	✓	✓	✓	✓	
		MSP-FET			✓		✓	✓	✓	✓	
		USB cable				✓					
		USB-to-Serial Converter ⁽³⁾	✓								
	Software ⁽⁴⁾	BSL Scriptor			✓	✓	✓	✓	✓	✓	✓
		BSLDEMO		✓							
		MSPBSL library		✓	UART only	✓	UART only				✓
Security	Password protection		32 byte	32 byte ⁽⁵⁾	32 byte	32 byte		32 byte	32 byte	32 byte	
	Mass erase on incorrect password ⁽⁶⁾		✓	✓	✓	✓		✓	✓	✓	
	Completely disable the BSL using signature or erasing the BSL			✓	✓	✓	✓	✓	✓	✓	
	BSL payload encryption						✓				
	Update of IP protected regions through boot code										
	Authenticated encryption							✓			
	Additional security							✓ ⁽⁷⁾			

- (1) Refer to the device-specific data sheet for the available TI BSL protocol on these devices. TI provides a specific BSL protocol for each flash device.
- (2) BSL in flash memory allows to replace the BSL with a custom version.
- (3) The USB-to-Serial Converter is compatible with BSLDEMO. The invocation signal is generated on the DTR pin for the RESET pin, and on the RTS pin for the TEST pin.
- (4) All BSL software collateral (application, examples, source code, and firmware images) is available in the [BSL tool folder](#). The [MSP430 USB developers package](#) includes additional USB BSL sample applications.
- (5) F543x (non A) has a 16-byte password.
- (6) Some devices can disable mass erase on incorrect password. See the device family user's guide.
- (7) Firmware validation through CRC.

1.3 BSL Invocation

1.3.1 Hardware BSL Invocation

1.3.1.1 MSP430 Devices With Shared JTAG Pins

Applying an appropriate entry sequence on the $\overline{\text{RST}}/\text{NMI}$ and TEST pins forces the MSP430 MCU to start program execution at the BSL RESET vector instead of at the RESET vector located at address FFFEH.

If the application interfaces with a computer UART, these two pins can be driven by the $\overline{\text{DTR}}$ and $\overline{\text{RTS}}$ signals of the serial communication port (RS232) after passing level shifters. Detailed descriptions of the hardware and related considerations can be found in [Section 4](#). The normal user reset vector at FFFEH is used if TEST is kept low while $\overline{\text{RST}}/\text{NMI}$ rises from low to high (standard method, see [Figure 1-1](#)).

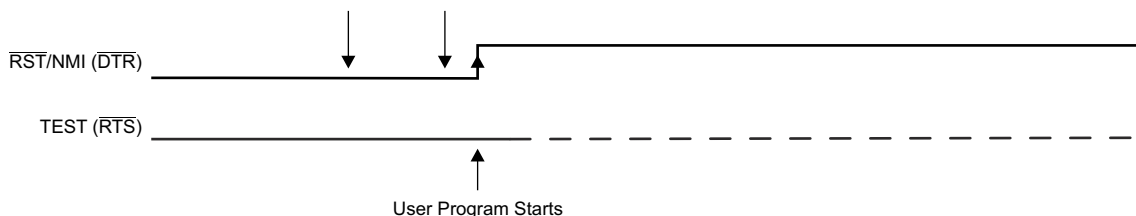

Figure 1-1. Standard RESET Sequence

The BSL program execution starts when the TEST pin has received a minimum of two rising edges (low-to-high transitions) and if $\overline{\text{RST}}/\text{NMI}$ rises from low to high (BSL entry method, see [Figure 1-2](#)). This level transition triggering improves BSL start-up reliability. The first high level of the TEST pin must be at least $t_{\text{SBW, En}}$ (see device-specific data sheet for $t_{\text{SBW, En}}$ parameter).

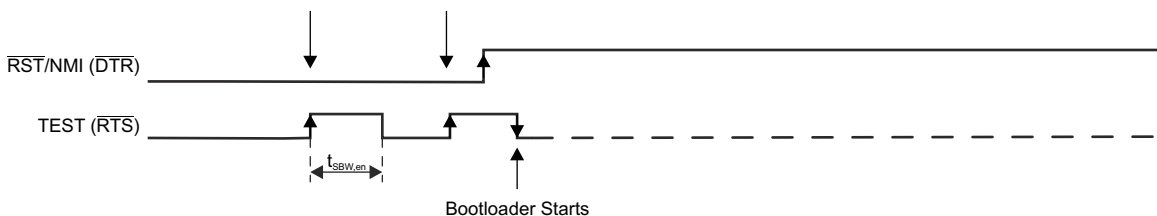

Figure 1-2. BSL Entry Sequence at Shared JTAG Pins

Note

For the MSP430F522x and MSP430F521x split-rail devices with DVIO supply, the entry sequence is applied on the $\overline{\text{RST}}/\text{NMI}$ and BSLLEN pins. For pin information, refer to the device-specific data sheet. For additional information, refer to the bootloader section in [Designing With MSP430F522x and MSP430F521x Devices](#).

Note

The recommended minimum time for pin states is 250 ns. See the device-specific errata for any differences, because some 5xx and 6xx device revisions require specific entry sequences.

The TEST signal is normally used to switch the port pins between their application function and the JTAG function. In devices with BSL functionality, the TEST and $\overline{\text{RST}}/\text{NMI}$ pins are also used to invoke the BSL. To invoke the BSL, the $\overline{\text{RST}}/\text{NMI}$ pin must be configured as $\overline{\text{RST}}$ and must be kept low while pulling the TEST pin high and while applying the next two edges (falling and rising) on the TEST pin. The BSL is started after the TEST pin is held low after the $\overline{\text{RST}}/\text{NMI}$ pin is released (see [Figure 1-2](#)).

1.3.1.1.1 Factors That Prevent BSL Invocation With Shared JTAG Pins

The BSL is not started by the BSL RESET vector if:

- There are fewer than two rising edges at the TEST pin while $\overline{\text{RST}}/\text{NMI}$ is low.
- The TEST pin does not stay high after the TEST pin second rising edge when $\overline{\text{RST}}/\text{NMI}$ rises from low to high.
- JTAG has control over the MSP430 MCU resources.
- The supply voltage, V_{CC} , drops below its threshold, and a power-on reset (POR) is executed.
- The $\overline{\text{RST}}/\text{NMI}$ pin is configured for NMI functionality (the NMI bit is set).
- If the TCK and TMS pins are left floating, the device can unintentionally enter JTAG mode. To avoid this issue, apply the recommended external termination. Add a 47-k Ω pullup resistor and a 1-nF pulldown capacitor on TCK and TMS. Stronger termination might be needed depending on noise in the system.

1.3.1.2 MSP430 Flash Devices With Dedicated JTAG Pins

Devices with dedicated JTAG pins use the TCK pin instead of the TEST pin.

The BSL program execution starts whenever the TCK pin has received a minimum of two falling edges and TCK is low while $\overline{\text{RST}}/\text{NMI}$ rises from low to high (BSL entry method, see [Figure 1-3](#)). This level transition triggering improves BSL start-up reliability.

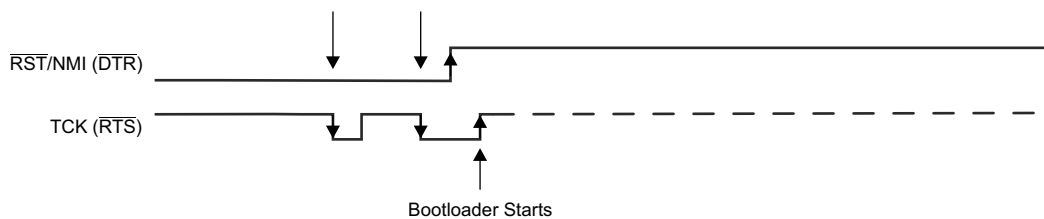

Figure 1-3. BSL Entry Sequence at Dedicated JTAG Pins

Note

The recommended minimum time for pin states is 250 ns. See the device-specific errata for any differences, because some 5xx and 6xx device revisions have specific entry sequence requirements.

1.3.1.2.1 Factors That Prevent BSL Invocation With Dedicated JTAG Pins

The BSL is not started by the BSL RESET vector if:

- There are fewer than two falling edges at the TCK pin while $\overline{\text{RST}}/\text{NMI}$ is low.
- TCK is high if $\overline{\text{RST}}/\text{NMI}$ rises from low to high.
- JTAG has control over the MSP430 MCU resources.
- The supply voltage, V_{CC} , drops below its threshold, and a power-on reset (POR) is executed.
- The $\overline{\text{RST}}/\text{NMI}$ pin is configured for NMI functionality (the NMI bit is set).

1.3.1.3 Devices With USB

Devices with USB are invoked when either of the following two conditions are met while the device is powered by VBUS:

- The device is powered up by USB and the reset vector is blank.
- The device powers up with the PUR pin tied to V_{USB} .

1.3.2 Software BSL Invocation

To invoke the BSL from a running application, set the program counter to the address where the BSL is located. For the MSP430F5xx and MSP430F6xx devices, the BSL is in memory location 0x1000. For the MSP430x1xx, MSP430x2xx, and MSP430x4xx devices, see [Section 5](#).

When the BSL runs, the stack is always reset, and RAM is cleared. Interrupts are not disabled by the BSL, so the application must disable interrupts before invoking the BSL. TI recommends clearing the configuration of any module registers that are used in the BSL application, because the configuration for the external application can interrupt the BSL application and cause unexpected behavior. One example is that in the USB-enabled MCUs with an USB BSL, the Timer_B module is used to identify the frequency of the high-frequency crystal. If Timer_B is also used in the external application and is not cleared before jumping to the BSL application, unexpected behavior can occur.

The location 0x1000 can be called as a C function, as in the following example code:

```

_disable_interrupt();    // disable interrupts
((void ( * )())0x1000)(); // jump to BSL

```

1.4 UART Protocol

The UART protocol applied here is defined as:

- Baud rate is fixed to 9600 baud in half-duplex mode (one sender at a time).
- Start bit, 8 data bits (LSB first), an even parity bit, 1 stop bit.
- Handshake is performed by an acknowledge character.
- Minimum time delay before sending new characters after characters have been received from the MSP430 BSL: 1.2 ms

Note

Applying baud rates other than 9600 baud at initialization results in communication problems or violates the flash memory write timing specification. The flash memory can be extensively stressed or can react with unreliable program or erase operations.

1.5 USB Protocol

The USB protocol applied here is defined as:

- HID protocol with one input endpoint and one output endpoint. Each endpoint has a length of 64 bytes.
- VID: 0x2047
- PID: 0x0200

2 Bootloader Protocol – 1xx, 2xx, and 4xx Families

2.1 Synchronization Sequence

Before sending any command to the BSL, a synchronization character (SYNC) with its value of 80h must be sent to the BSL. This character is necessary to calculate all the essential internal parameters, which maintain UART and flash memory program and erase timings. It provides the BSL system time reference. When this is received, an acknowledge DATA_ACK = 90h is sent back by the BSL to confirm successful reception.

This sequence must be done before every command that is sent to the BSL.

Note

The synchronization character is not part of the Data Frame described in [Section 2.4](#).

2.2 Commands

Two categories of commands are available: commands that require a password and commands that do not require a password. The password protection safeguards every command that potentially allows direct or indirect data access.

2.2.1 Unprotected Commands

- Receive password
- Mass erase (erase entire flash memory, main as well as information memory)
- Transmit BSL version (V1.50 or higher or in loadable BL_150S_14x.txt but not V2.x BSLs)
- Change baud rate (V1.60 or V1.61 or V2.00 or in loadable BL_150S_14x.tx)

2.2.2 Password Protected Commands

- Receive data block to program flash memory, RAM, or peripherals
- Transmit data block
- Erase segment
- Erase check (present in V1.60 or higher or in loadable BL_150S_14x.txt)
- Set Memory Offset (present in V2.12 or higher)
- Load program counter and start user program
- Change baud rate (BSL versions lower than V1.60 and higher than V2.00)

2.3 Programming Flow

The write access (RX data block command) to the flash memory, RAM, or peripheral modules area is executed online. That means a data byte or word is processed immediately after receipt, and the write cycle is finished before a following byte or word has completely arrived. Therefore, the entire write time is determined by the baud rate, and no buffering mechanism is necessary.

Data sections located below the flash memory area address are assumed to be loaded into the RAM or peripheral module area and, thus, no specific flash control bits are affected.

Note

If control over the UART protocol is lost, either by line faults or by violating the data frame conventions, the only way to recover is to rerun the BSL entry sequence to initiate another BSL session.

2.4 Data Frame

To ensure high data security during the data transmission, a data frame protocol called serial standard protocol (SSP) is used. The BSL is considered the receiver in [Table 2-1](#).

2.4.1 Data-Stream Structure

- The first eight bytes (HDR through LH) are mandatory (xx represents dummy data).
- Data bytes D1 to Dn are optional.
- Two bytes (CKL and CKH) for checksum are mandatory.
- Acknowledge done by the BSL is mandatory, except with the TX data block and TX BSL version commands.

Table 2-1. Data Frame of BSL Commands⁽¹⁾⁽³⁾⁽⁶⁾

Received BSL Command	HDR	CMD	L1	L2	AL	AH	LL	LH	D1	D2...Dn	CKL	CKH	ACK ⁽²⁾
RX data block	80	12	n	n	AL	AH	n-4	0	D1	D2 ... Dn-4	CKL	CKH	ACK
RX password	80	10	24	24	xx	xx	xx	xx	D1	D2 ... D20	CKL	CKH	ACK
Erase segment	80	16	04	04	AL	AH	02	A5	–	– – –	CKL	CKH	ACK
Erase main or info	80	16	04	04	AL	AH	04	A5	–	– – –	CKL	CKH	ACK
Mass erase	80	18	04	04	xx	xx	06	A5	–	– – –	CKL	CKH	ACK
Erase check ⁽⁴⁾	80	1C	04	04	AL	AH	LL	LH	–	– – –	CKL	CKH	ACK
Change baud rate ⁽⁵⁾	80	20	04	04	D1	D2	D3	xx	–	– – –	CKL	CKH	ACK
Set mem offset	80	21	04	04	xx	xx	AL	AH	–	– – –	CKL	CKH	ACK
Load PC	80	1A	04	04	AL	AH	xx	xx	–	– – –	CKL	CKH	ACK
TX data block	80	14	04	04	AL	AH	n	0	–	– – –	CKL	CKH	–
BSL responds	80	xx	n	n	D1	D2 Dn	CKL	CKH	–
TX BSL version ⁽⁴⁾	80	1E	04	04	xx	xx	xx	xx	–	– – –	CKL	CKH	–
BSL responds	80	xx	10	10	D1	D2 D10	CKL	CKH	–

- (1) All numbers are bytes in hexadecimal notation.
- (2) ACK is sent back by the BSL.
- (3) The synchronization sequence is not part of the data frame.
- (4) The erase check and TX BSL version commands are members of the standard command set in BSLs V1.50 or higher but excluding 2.x BSLs.
- (5) The change baud rate command is not a member of the standard command set (it is available in V1.60 or higher or in loadable BL_150S_14x.txt).
- (6) Abbreviations:
HDR: Header. Any value between 80h and 8Fh (normally 80h).
CMD: Command identification
L1, L2: Number of bytes consisting of AL through Dn. Restrictions: L1 = L2, L1 < 255, L1 even
AL, AH: Block start address or erase (check) address or jump address LO or HI byte
LL, LH: Number of pure data bytes (250 max) or erase information LO or HI byte or block length of erase check (FFFFh max)
D1 ... Dn: Data bytes
CKL, CKH: 16-bit checksum LO or HI byte
xx: Can be any data
–: No character (data byte) received or transmitted
ACK: The acknowledge character returned by the BSL. Can be either DATA_ACK = 90h: Frame was received correctly, command was executed successfully, or DATA_NAK = A0h: Frame not valid (for example, wrong checksum, L1 ≠ L2), command is not defined, is not allowed, or was executed unsuccessfully.
n: Number of bytes consisting of AL through Dn

2.4.2 Checksum

The 16-bit (2-byte) checksum is calculated over all received or transmitted bytes B1 to Bn in the data frame, except the checksum bytes themselves, by XORing words (two successive bytes) and inverting the result.

This means that B1 is always the HDR byte and Bn is the last data byte just before the CKL byte.

Formula

$$\text{CHECKSUM} = \text{INV} [(B1 + 256 \times B2) \text{ XOR } (B3 + 256 \times B4) \text{ XOR } \dots \text{ XOR } (B_{n-1} + 256 \times B_n)]$$

or

$$\text{CKL} = \text{INV} [B1 \text{ XOR } B3 \text{ XOR } \dots \text{ XOR } B_{n-1}]$$

CKH = INV [B2 XOR B4 XOR ... XOR Bn]

2.4.3 Example Sequence

The following example shows a request to read the memory of the MSP430 MCU from location 0x0F00. All values shown below are represented in hexadecimal format.

```

TO BSL:      80
              (Synchronization character sent to the BSL)

FROM BSL:    90
              (Acknowledge from BSL)

TO BSL:      80 14 04 04 00 0F 0E 00 75 E0
              (Send Command to read memory from 0x0F00, length 0x000E)

FROM BSL:    80 00 0E 0E F2 13 40 40 00 00 00 00 02 01 01 01 C0 A2
              (Returned values from BSL)
  
```

2.4.4 Commands – Detailed Description

See [Table 2-1](#).

2.4.4.1 General

Following the header byte HDR (80h) and the command identification CMD, the frame length bytes L1 and L2 (which must be equal) hold the number of bytes following L2, excluding the checksum bytes CKL and CKH.

Bytes AL, AH, LL, LH, D1...Dn are command-specific. However, the checksum bytes CKL (low byte) and CKH (high byte) are mandatory.

If the data frame has been received correctly and the command execution was successful, an acknowledge character DATA_ACK = 90h is sent back by the BSL. Incorrectly received data frames, unsuccessful operations, and commands that are locked or not defined are confirmed with a DATA_NAK = A0h.

Note

BSL versions lower than V1.30 support only byte-access operations. Therefore, the peripheral module addresses at 0100h to 01FFh cannot be accessed correctly, because they are word-oriented. In version V1.30 and higher, addresses 0000h to 00FFh are accessed in byte mode; all others are accessed in word mode.

2.4.4.2 RX Data Block

The receive data block command is used for any write access to the flash memory, RAM, or peripheral module control registers at 0000h to 01FFh. It is password protected.

The 16-bit even-numbered block start address is defined in AL (low byte) and AH (high byte). The 16-bit even-numbered block length is defined in LL (low byte) and LH (high byte). Because pure data bytes are limited to a maximum of 250, LH is always 0.

The following data bytes are succeeded by the checksum bytes CKL (low byte) and CKH (high byte). If the receipt and programming of the appropriate data block was successful, an acknowledge character DATA_ACK is sent back by the BSL. Otherwise, the BSL confirms with a DATA_NAK.

Note

BSL versions V1.40 and higher support online verification inside the MSP430 MCU for addresses 0200h to FFFFh, which reduces programming and verification time by 50%. Online verification means that the data is immediately verified with the data that is written into the flash without transmitting it again. In case of an error, the loadable bootloader BL_150S_14x.txt additionally stores the first incorrectly written location address+3 into the error address buffer in the RAM at address 0200h (021Eh for F14x devices).

2.4.4.3 RX Password

The receive password command is used to unlock the password-protected commands, which perform reading, writing, or segment-erasing memory access. It is not password protected.

Neither start address nor block length information is necessary, because the 32-byte password is always located at addresses FFE0h to FFFFh. Data bytes D1 to D20h hold the password information starting with D1 at address FFE0h.

The BSL responds with DATA_ACK when the package from the host is received correctly and has valid content as shown in [Table 2-1](#). The DATA_ACK does not reflect that the password is correct (that is, it matches the content of FFE0h to FFFFh) or incorrect. If an incorrect password is sent, other commands will respond with DATA_NAK, because the BSL is still locked.

After the protected commands are unlocked, they remain unlocked until another BSL entry is initiated.

2.4.4.4 Mass Erase

The mass erase command erases the entire flash memory area (main memory plus information memory, see corresponding data sheet). This command is not password protected.

All parameters shown in [Table 2-1](#) are mandatory. After erasing, an acknowledge character DATA_ACK is sent back by the BSL.

Mass erase initializes the password area to 32 times 0FFh.

Note

BSL versions 2.01 and higher support automatic clearing of the LOCKA bit, which protects information memory.

When entering the BSL by cold start (that is, by applying the BSL hardware entry sequence on the RST and TST pins), the LOCKA bit is automatically unlocked. A mass erase that is executed during BSL communication erases all parts of information memory and also main memory.

When entering the BSL by warm start (that is, by jumping to the BSL application from a software function), the LOCKA bit is not automatically unlocked. A mass erase performed in this state does not erase the information memory. Therefore, when the BSL is called by software, the user application must ensure that LOCKA is cleared before initialization of the BSL, so a mass erase command can erase the information memory.

2.4.4.5 Erase Segment

The erase segment command erases specific flash memory segments. It is password protected.

The address bytes AL (low byte) and AH (high byte) select the appropriate segment. Any even-numbered address within the segment to be erased is valid. After segment erasing, an acknowledge character DATA_ACK is sent back by the BSL (V1.40 or lower).

BSL versions V1.60 or higher perform a subsequent erase check of the corresponding segment and respond with a DATA_NAK if the erasure was not successful. In this case, the first non-erased location address + 1 is stored in the error address buffer in the RAM at address 0200h (021Eh for F14x devices). In this version, a problem occurs if only one of the information memory segments is erased. In this case, an error is reported, because an automatic erase check over the whole information memory is performed. As a solution, either erase the whole information memory or do a separate erase check after the erase, even if the erase reported an error.

Erase segment 0 clears the password area and, therefore, the remaining password is 32 times 0FFh.

When applying LL = 0x04 and LH = 0xA5, a mass erasure of only the main memory is performed. Indeed, this command must be executed a minimum of 12 times to achieve a total erasure time of >200 ms. No subsequent erase check of the entire main memory is done. Use the erase check command additionally. Check the device data sheet for more information on the cumulative (mass) erase time that must be met and the number of erase cycles required.

2.4.4.6 Erase Main or Info

The erase main or info command erases specific flash memory section. It is password protected.

The address bytes AL (low byte) and AH (high byte) select the appropriate section of flash (main or information). Any even-numbered address within the section to be erased is valid.

2.4.4.7 Erase Check

The erase check command verifies the erasure of flash memory within a certain address range. It is password protected.

The 16-bit block start address is defined in AL (low byte) and AH (high byte). The 16-bit block length is defined in LL (low byte) and LH (high byte). Both can be either even or odd numbered to allow odd boundary checking.

If the erase check of the appropriate data block was successful (all bytes contain 0FFh), an acknowledge character DATA_ACK is sent back by the BSL. Otherwise, the BSL confirms with a DATA_NAK and the first non-erased location address + 1 is stored in the error address buffer at address 0200h (021Eh for F14x devices).

Note

This command is not a member of the standard command set. It is implemented in BSL version V1.60 and higher or in the loadable bootloader BL_150S_14x.txt.

2.4.4.8 Change Baud Rate

The change baud rate command offers the capability of transmissions at higher baud rates than the default 9600 baud. With faster data transition, shorter programming cycles can be achieved, which is especially important with large flash memory devices. This command is not password protected.

Three control bytes (D1 to D3) determine the selected baud rate. D1 and D2 set the processor frequency ($f \geq f_{\min}$), D3 indirectly sets the flash timing generator frequency ($f_{\text{FTGmin}} \leq f_{\text{FTG}} \leq f_{\text{FTGmax}}$). In detail:

- D1: F1xx: Basic clock module control register DCOCTL (DCO.2 to DCO.0)
F2xx: Basic clock module control register DCOCTL (DCO.2 to DCO.0)
F4xx: FLL+ system clock control register SCFI0 (D, FN_8 to FN_2)
- D2: F1xx: basic clock module control register BCSCCTL1 (XT2Off, Rsel.2 to Rsel.0)
F2xx: basic clock module control register BCSCCTL1 (XT2Off, Rsel.2 to Rsel.0)
F4xx: FLL+ system clock control register SCFI1 (N_{DCO})
- D3 0: 9600 baud
1: 19200 baud
2: 38400 baud

After receiving the data frame, an acknowledge character DATA_ACK is sent back, and the BSL becomes prepared for the selected baud rate. TI recommends that the BSL communication program wait approximately 10 ms between baud rate alteration and the next data transmission to give the BSL clock system time to stabilize.

Note

The highest achievable baud rate depends on various system and environment parameters like supply voltage, temperature range, and minimum and maximum processor frequency. See the device-specific data sheet.

Note

This command is implemented on BSL versions V1.60 or higher or available in the loadable bootloader BL_150S_14x.txt.

Table 2-2. Recommendations for MSP430F149 [MSP430F449] (1)

T_A = 25°C, V_{CC} = 3.0 V, f_{max} = 6.7 MHz

Baud Rate (baud)	Processor Frequency, f _{min} (MHz) ⁽⁴⁾	D1 DCOCTL [SCFI0] ⁽²⁾	D2 BCCTL1 [SCFI1] ⁽²⁾	D3 ⁽²⁾	Program and Verify 60 KB (sec) ⁽³⁾
9600 (init)	1.05	0x80 [00]	0x85 [98]	00 [00]	78 + 3.7 [0.0]
19200	2.1	0xE0 [00]	0x86 [B0]	01 [01]	39 + 3.7 [2.4]
38400	4.2	0xE0 [00]	0x87 [C8]	02 [02]	20 + 3.7 [2.4]

- (1) Values in brackets [] apply to MSP430F449.
- (2) D1 to D3 are bytes in hexadecimal notation.
- (3) Additional 3.7 [2.4] seconds result from loading, verifying, and launching the loadable BSL.
- (4) The minimum processor frequency is lower than in the standard ROM BSL (see [Initialization Status](#)).

Table 2-3. Recommendations for MSP430F2131

T_A = 25°C, V_{CC} = 3.0 V, f_{max} = 6.7 MHz

Baud Rate (baud)	Processor Frequency, f _{min} (MHz) ⁽²⁾	D1 DCOCTL [SCFI0] ⁽¹⁾	D2 BCCTL1 [SCFI1] ⁽¹⁾	D3 ⁽¹⁾	Program and Verify 60 KB (sec)
9600 (init)	1.05	0x80	0x85	00	78
19200	2.1	0x00	0x8B	01	39
38400	4.2	0x80	0x8C	02	20

- (1) D1 to D3 are bytes in hexadecimal notation.
- (2) The minimum processor frequency is lower than in the standard ROM BSL (see [Initialization Status](#)).

2.4.4.9 Set Memory Offset

An offset for the memory pointer can be set for devices that have more than 64KB of memory, specifically MSP430X architecture devices. The value for the memory offset is used as the memory pointer's upper word.

Memory Address = Offset Value << 16 + Actual Address

Note

This command is implemented on BSL versions V2.12 and higher.

2.4.4.10 Load PC

The load program counter command directs the program counter (register R0) to any location within the entire address range. It is password protected.

After receiving the data frame, an acknowledge character (DATA_ACK) is sent back by the BSL. Then the selected address is moved into the program counter. The program flow continues operation there, and the BSL session is terminated.

Be aware that password protection is not active at this time. Jumping to the user application does not reset the device and, therefore, the register configuration from the BSL application is kept. This might cause unexpected behavior in the user application. One example is the blink LED application, which does not have any clock module configuration (so it uses the default 1-MHz clock) and will blink faster, because the clock module is set by the BSL application to run at 8 MHz.

2.4.4.11 TX Data Block

The transmit data block command is used for any read access to the flash memory, RAM, or peripheral module control registers at 0000h to 01FFh. It is password protected.

The 16-bit block start address is defined in AL (low byte) and AH (high byte). The 16-bit block length is defined in LL (low byte) and LH (high byte). Because pure data bytes are limited to a maximum of 250, LH is always 0. The checksum bytes CKL (low byte) and CKH (high byte) immediately follow this information.

Now the BSL responds with the requested data block. After transmitting HDR, dummy CMD, L1 and L2, The BSL sends data bytes D1 through Dn, followed by the checksum bytes CKL (low byte) and CKH (high byte). No acknowledge character is necessary.

2.4.4.12 TX BSL Version

The transmit BSL version command gives the user information about chip identification and bootloader software version. It is not password protected.

The values for AL, AH, LL, and LH can be any data, but must be transmitted to meet the protocol requirements. The checksum bytes CKL (low byte) and CKH (high byte) follow this information.

After that, the BSL responds with a 16-byte data block. After transmitting HDR, dummy CMD, L1 and L2, the BSL sends data bytes D1 through D16 (decimal), followed by the checksum bytes CKL (low byte) and CKH (high byte). No acknowledge character is necessary.

D1, D2 and D11, D12 (decimal) hold the specific information:

- D1: Device family type (high byte)
- D2: Device family type (low byte)
- D11: BSL version (high byte)
- D12: BSL version (low byte)

The remaining 12 bytes are for internal use only.

2.5 Loadable BSL

For upgrading the BSL functionality, sometimes it is suitable to load a higher version of BSL into the RAM of a device and apply the latest innovations. To do so, use the following BSL commands:

- RX password (unlock password protection for following commands)
- RX data block (code of loadable BSL, code section address \geq 220h)
- TX data block (for verification)
- RX data block (get start address from first code section address)
- Load program counter PC (with start address of loadable BSL)
- Wait at least 5 ms until the new loaded BSL has executed the initialized routine
- RX password (unlock password protection for loaded BSL)
- Perform any command (with loaded BSL)

The following loadable BSLs are available:

- **BL_150S_14x.txt** is a complete BSL for the F14x and F13x family with BSL version 1.10. All features of BSL version V1.60 are supported. Because its code size is larger than 1KB, it can be used only in F1x8 and F1x9 devices. The error address buffer address for RX Block, Erase Segment, and Erase Check commands is 021Eh. BL_150S_14x.txt could also be used as a replacement for PATCH.txt.
- **BS_150S_14x.txt** is a small BSL with reduced command set for the F14x and F13x family with BSL version 1.10. Because its code size is smaller than 512B, it can be used in F1x4 up to F1x9 devices. The following commands of BSL version V1.60 are supported: Change Baud Rate, RX Block (with online verification), Erase Check, and Load PC. If a TX Block command (redirected to ROM BSL) is needed (for example, for transmitting error address or standalone Verify), the RAM BSL must be invoked again by the Load PC command. The error address buffer address for RX Block and Erase Check commands is 021Eh. BS_150S_14x.txt could also be used as a partial replacement for PATCH.txt. No password is required, as the RX password command is removed.

For more information on downloading a different bootloader, see [Application of Bootloader in MSP430 With Flash Hardware and Software Proposal](#).

Third-party software normally uses loadable BSLs to perform most functions, like online verification, and to improve speed for appropriate devices.

2.6 Exiting the BSL

To exit the BSL mode, two possibilities are provided:

- The microcontroller continues operation at a defined program address invoked by the load program counter command. Be aware that the password protection is not active at this time. In this case, the user application should ensure that the flash is locked, as this is not done by the BSL. Leaving the BSL unlocked increases the risk of erroneously modifying the flash due to system or software errors. On 2xx devices, the correct setting of the LOCKA bit should also be checked.
- Applying the standard RESET sequence (see [Figure 1-1](#)) forces the microcontroller to start with the user reset vector at address 0FFFEh.

2.7 Password Protection

The password protection prohibits every command that potentially allows direct or indirect data access. Only the unprotected commands like mass erase and RX password (optionally, TX BSL version and change baud rate) can be performed without prior receipt of the correct password after BSL entry.

Applying the RX password command for receiving the correct password unlocks the remaining commands.

After it is unlocked, it remains unlocked until initiating another BSL entry.

The password itself consists of the 16 interrupt vectors located at addresses FFE0h to FFFFh (256 bits), starting with the first byte at address FFE0h. After mass erase and with unprogrammed devices, all password bits are logical high (1).

BSL versions 2.00 and higher have enhanced security features. These features are controlled by the flash data word located beneath the interrupt vector table addresses (for example, for the MSP430F2131, address 0xFFDE). If this word contains:

- 0x0000: The flash memory is not erased if an incorrect BSL password has been received by the target.
- 0xAA55: The BSL is disabled. This means that the BSL is not started with the default initialization sequence shown in [Section 1.3.1](#).
- All other values: If an incorrect password is transmitted, the entire flash memory address space is erased automatically.

Note

The user must take care of password update after modifying the interrupt vectors and initiating another BSL session. TI strongly recommends initializing unused interrupt vectors to increase data security.

2.8 Code Protection Fuse

After the JTAG fuse (code protection fuse) is blown, no further access to the JTAG test feature is possible. The only way to get any memory read or write access is through the bootloader by applying the correct password.

However, it is not possible for the BSL to blow the JTAG fuse. If fuse blowing is needed, use JTAG programming techniques.

2.9 BSL Internal Settings and Resources

The following paragraphs describe BSL internal settings and resources. Because the same device can have implemented different BSL versions, it is very important for the BSL communication program to know the settings and resources. Resources could be either device dependent (for example, RX or TX pins) or BSL-version dependent (for example, byte or word access). The following sections describe the possible variations.

2.9.1 Chip Identification and BSL Version

The upper 16 bytes of the boot-ROM (0FF0h to 0FFFh) hold information about the device and BSL version number in BCD representation. This is common for all devices and BSL versions:

- 0FF0h to 0FF1h: Chip identification (for example, F413h for an F41x device).
- 0FFAh to 0FFBh: BSL version number (for example, 0130h for BSL version V1.30).

See the MSP430 device to BSL version assignment in [Section 5](#).

2.9.2 Vectors to Call the BSL Externally

The entry part of the boot ROM holds the calling vectors for BSL access by program:

- 0C00h: Vector for cold start (mnemonic: BR &0C00h) (recommended)
- 0C02h: Vector for warm start (mnemonic: BR &0C02h). V1.30 or higher.
- 0C04h: Vectors for future use. This table is expandable.

Note

A warm start does not modify the stack pointer. Additionally, the status register for the BSL is not cleared, which could cause a warm started BSL to come up in an unlocked state. Warm start possibility exists only for highly specialized instances where it is absolutely mandatory that a running application be returned to after a BSL session without resetting the device. In almost all cases, it is better to start the BSL from user code by calling the cold start vector.

2.9.3 Initialization Status

When activating the BSL, the following settings take effect:

- Stop watchdog timer
- Disable all interrupts (GIE = 0)
- *V1.10*
The stack pointer is not modified, except when it points to an excluded memory area. If so, it is initialized to 021Ah.
- *V1.30 or higher*
The stack pointer is not modified if the BSL is called by the program through the warm-start vector. It is initialized to 0220h if the BSL starts by the BSL RESET sequence or is called by the program through the cold-start vector.
- *F1xx*
Determine basic clock module so that minimum frequency is 1.5 MHz:
BCSCTL1 = 85h (RSEL = 5, XT2Off = 1)
DCOCTL = 80h (DCO = 4, MOD = 0)
BCSCTL2 = 00h only at cold start
SR: SCG1 = 00h (SMCLK on) only at cold start
- *F2xx*
Determine basic clock module so that minimum frequency is 1.5 MHz:
BCSCTL1 = 88h (RSEL = 8, XT2Off = 1)
DCOCTL = 80h (DCO = 4, MOD = 0)
BCSCTL2 = 00h only at cold start
SR: SCG1 = 00h (SMCLK on) only at cold start
- *F4xx*
Determine FLL oscillator and system clock so that minimum frequency is 1.5 MHz:
SCFI0 = 00h (D = 0, FN_x = 0)
SCFI1 = 98h (N_DCO)
SCFQCTL: (M = 0)
SR: SCG0 = 1 (FLL loop control off)
FLL_CTL1 = 00h only at cold start
- SW-UART: Timer_A operates in continuous mode with MCLK source (Div = 1)
CCR0 used for compare
CCTL0 used for polling of CCIFG0
- TX pin is set to output high for RS232 idle state
- RX pin is set to input
- Password-protected commands are locked (only at cold start)

After system initialization, the BSL is ready for operation and waits for the first synchronization sequence (SS) followed by a data frame containing the first BSL command.

2.9.4 Memory Allocation and Resources

- The BSL program code is located in the boot-ROM area 0C00h to 0FEFh.
- Addresses 0FF0h to 0FFFh hold the device identification.
- The BSL variables occupy the RAM area
 - 0200h to 0213h (V1.10)
 - 0200h to 0219h (V1.30 or higher)
- The BSL stack occupies the RAM area
 - 0214h to 0219h (V1.10)
 - 021Ah to 021Fh (V1.30 or higher, only at cold start)
- The working registers used are:
 - R5 to R9 (V1.30 or lower) or
 - R5 to R10 (V1.40) or
 - R5 to R11 (V1.60) or
 - R5 to R14 (V2.00 or higher)

Their contents are not buffered.

- F1xx and F2xx:
 - The basic clock module registers used are:
 - DCOCTL at address 056h
 - BCSCTL1 at address 057h
- F4xx:
 - The FLL oscillator and system clock registers used are:
 - SCFIO at address 050h
 - SCF11 at address 051h
 - SCFQCTL at address 052h
 - The Timer_A control registers used are:
 - TACTL at address 0160h
 - CCTL0 at address 0162h
 - TAR at address 0170h
 - CCR0 at address 0172h
 - The flash control registers used are:
 - FCTL1 at address 0128h
 - FCTL2 at address 012Ah
 - FCTL3 at address 012Ch
- No interrupt service is affected.

3 Bootloader Protocol – F5xx and F6xx Families

3.1 BSL Data Packet

The BSL data packet has a layered structure. The BSL core command contains the actual command data to be processed by the BSL. In addition the standard BSL commands, there can be wrapper data before and after each core command known as the peripheral interface code (PI Code). This wrapper data is information that is specific to the peripheral and protocol being used, and it contains information that allows for correct transmission of the BSL core command. Taken together, the wrapper and core command constitute a BSL data packet.

PI Code	BSL Core Command	PI Code
---------	------------------	---------

3.2 UART Peripheral Interface (PI)

3.2.1 Wrapper

The default BSL430 programmed in each non-USB MSP430F5xx device communicates using a UART peripheral interface (PI). The UART protocol interface has the format shown in [Table 3-1](#). All numbers are in hexadecimal format.

Table 3-1. UART Protocol Interface

Header	Length	Length	BSL Core Command	CKL	CKH	ACK
0x80	NL	NH	See Table 3-5	CKL	CKH	(ACK) from BSL

3.2.2 Abbreviations

CKL, CKH

CRC checksum high and low bytes. The checksum is computed on bytes in BSL core command section only. The CRC is computed using the MSP430F5xx CRC module specification (see the CRC chapter of the [MSP430F5xx and MSP430F6xx Family User's Guide](#) for implementation details).

NL, NH

Number of bytes in BSL core data packet, broken into high and low bytes.

ACK

Sent by the BSL after the packet is received to acknowledge receiving the data correctly. This does not imply the BSL core data is a correct command or that it was executed correctly. ACK signifies only that the packet was formatted as expected and had a correct checksum.

Note

If the PI encounters an error at any stage of receiving the packet, it immediately responds with the appropriate error message.

3.2.3 Messages

The peripheral interface section of the BSL430 software parses the wrapper section of the BSL data packet. If there are errors with the data transmission, an error message is sent immediately. An ACK is sent after all data has been successfully received and does not mean that the command has been correctly executed (or even that the command was valid) but, rather, that the data packet was formatted correctly and passed on to the BSL core software for interpretation.

Table 3-2. UART Error Messages

Data	Meaning
0x00	ACK
0x51	Header incorrect. The packet did not begin with the required 0x80 value.
0x52	Checksum incorrect. The packet did not have the correct checksum value.
0x53	Packet size zero. The size for the BSL core command was given as 0.
0x54	Packet size exceeds buffer. The packet size given is too big for the RX buffer.
0x55	Unknown error
0x56	Unknown baud rate. The supplied data for baud rate change is not a known value.

3.2.4 Interface Specific Commands

The Timer UART protocol interface also accepts the following command when it is transmitted as BSL core data.

BSL Command	CMD	AL	AM	AH	Data
Change baud rate	0x52	–	–	–	D1

3.2.4.1 Change Baud Rate

This command changes the baud rate for all subsequently received data packets. The command is acknowledged with either a single ACK (sent at the current, not the newly selected, baud rate) or an error byte. No subsequent message packets can be expected.

D1: Valid values

- 0x02: 9600
- 0x03: 19200
- 0x04: 38400
- 0x05: 57600
- 0x06: 115200

3.3 I²C Peripheral Interface

3.3.1 I²C Protocol Definition

The I²C protocol used by the BSL is defined as:

- Master must request data from BSL slave.
- 7-bit addressing mode is used, and the slave listens to address 0x48.
- Handshake is performed by an acknowledge character in addition to the hardware ACK.
- Minimum time delay before sending new characters after characters have been received from the MSP430 BSL is 1.2 ms.
- Repeated starts are not required by the BSL but can be used.

3.3.2 Basic Protocol With Byte Level Acknowledge

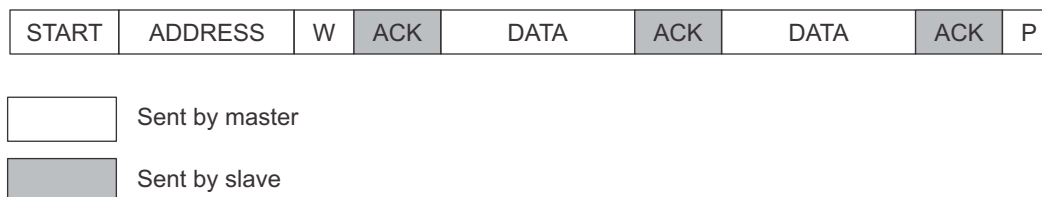
Figure 3-1. Basic Protocol - Byte Level ACK

1. Send the START bit
2. Send the slave address
3. Send the Read (R)-1 or Write (W)-0 bit.
4. Wait for or send an acknowledge bit
5. Send or receive the data byte (8 bits)
6. Expect or send acknowledge bit

7. Send the STOP bit

3.3.3 I²C Protocol for BSL - Read From Slave

1. Send a start sequence (S)
2. Send I²C address of Slave with the R/W bit low (even address) (ADDR) + W.
3. Send Data or address of internal address of slave register (NDATA)
4. Send a start sequence again (repeated start) (Res)
5. Send I²C address of slave with the R/W bit high (odd address) (ADDR)
6. Read data byte from slave (RDATA)
7. Send the stop sequence (P)

All BSL wrapper commands from the host (master) are considered as data (represented as NDATA, they can consist of n number of bytes), and all data read from the slave are also considered data and represented as RDATA.

The protocol for all communication from Master to Slave is:

From Master → S + ADDR + W + NDATA + ReS + ADDR + R

From Slave → RDATA

From Master → P

3.3.4 Acknowledge (ACK)

There are two levels of acknowledge.

- The low-level acknowledges indicating reception of each byte that is part of the I²C protocol. This is managed by the hardware if proper I²C settings are set on the slave registers.

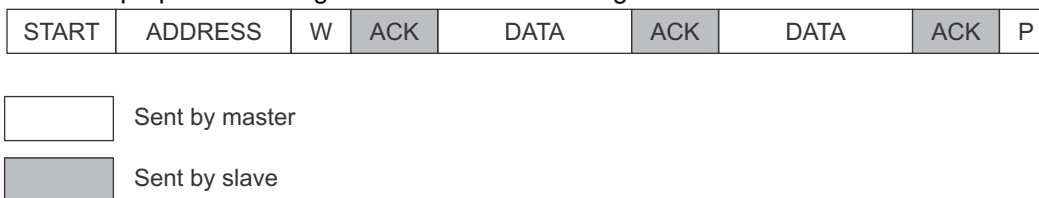

Figure 3-2. Byte Level ACK

- The high-level acknowledge indicates that the checksum of the BSL core command obtained is correct and as expected. In some cases, this ACK can indicate the command was properly executed. This is the first byte of RDATA. If this is NAK (other than 0x00), it indicates that a proper command was not received and the master should consider that command transmission as a failure. If this is ACK (0x00), it indicates that the transmission or reception of the command was correct with the right checksum and that the data which follows is the response, if any, from the slave. The slave can keep the CLK line low if it needs time to process before it responds to the command.

3.3.5 Wrapper

The wrapper for the BSL data packet integrates the common UART BSL Core Command packet, but adds Length, Checksum, and Acknowledge to be used within I²C communication (see [Table 3-3](#)).

Table 3-3. BSL Core Command Wrapper for I²C

Header	Length	Length	BSL Core Command	CKL	CKH	ACK
0x80	NL	NH	See Section 3.5	CKL	CKH	(ACK) from BSL

CKL, CKH

CRC checksum high and low bytes. The checksum is computed on bytes in BSL core command section only.

NL, NH

Number of bytes in BSL core data packet, broken into high and low bytes.

ACK

Sent by the BSL after the packet is received to acknowledge receiving the data correctly. This does not imply that the BSL core data is a correct command or that it was executed correctly. ACK signifies only that the packet was formatted as expected and had a correct checksum.

3.4 USB Peripheral Interface

3.4.1 Wrapper

The Peripheral Interface for the USB bootloader has the wrapper format shown in [Table 3-4](#). There are no interface specific commands or replies for the USB BSL. The only variable byte, NL, should describe the number of bytes contained in the BSL Core Command packet.

Table 3-4. USB Peripheral Interface

Header	Length	BSL Core Command
0x3F	NL	See Section 3.5

3.4.2 Hardware Requirements

The USB Peripheral Interface requires the use of a high-frequency oscillator on XT2. For the BSL to function properly, the oscillator can be 24 MHz, 12 MHz, 8 MHz, or 4 MHz.

3.5 BSL Core Command Structure

The BSL core command is transmitted in the format shown in [Table 3-5](#). All numbers are in hexadecimal format.

Note

See [Section 5.5](#) for using the following commands with the BSL in the MSP430F5438 (non-A version).

Table 3-5. BSL Core Commands

BSL Command	CMD	AL	AM	AH	Data
RX Data Block	0x10	(AL)	(AM)	(AH)	D1 ... Dn
RX Data Block Fast	0x1B	(AL)	(AM)	(AH)	D1 ... Dn
RX Password	0x11	–	–	–	D1 ... D33
Erase Segment	0x12	(AL)	(AM)	(AH)	–
Unlock and Lock Info	0x13	–	–	–	–
Reserved	0x14	–	–	–	–
Mass Erase	0x15	–	–	–	–
CRC Check	0x16	(AL)	(AM)	(AH)	Length (low byte), Length (high byte)
Load PC	0x17	(AL)	(AM)	(AH)	–
TX Data Block	0x18	(AL)	(AM)	(AH)	Length (low byte), Length (high byte)

Table 3-5. BSL Core Commands (continued)

BSL Command	CMD	AL	AM	AH	Data
TX BSL Version	0x19	–	–	–	–
TX Buffer Size ⁽¹⁾	0x1A	–	–	–	–

(1) The TX Buffer Size command is currently not implemented in the BSL on F5xx and F6xx MCUs.

Note

BSLs that are programmed in flash and that communicate by USB contain only a subset of the commands shown in [Table 3-5](#). These commands can be used to load in a full BSL into RAM for flash programming. The commands in this subset are RX DATA BLOCK FAST, RX PASSWORD, and LOAD PC.

The supported features can also be determined by the BSL version number as shown in [Section 3.7.3](#). Examples of how to load a full-featured BSL into RAM are given in the zip file that is associated with this document (see [Section 1.1](#)).

3.5.1 Abbreviations

–

No data required. No delay should be given, and any subsequently required data should be sent as the immediate next byte.

AL, AM, AH

Address bytes. The low, middle, and upper bytes, respectively, of an address.

D1 ... Dn

Data bytes 1 through n (Note: n must be 4 less than the BSL buffer size.)

Length

A byte containing a value from 1 to 255 describing the number of bytes to be transmitted or used in a CRC. In the case of multiple length bytes, they are combined together as described to form a larger value describing the number of required bytes.

3.5.2 Command Descriptions

RX Data Block

The BSL core writes bytes D1 through Dn starting from the location specified in the address fields.

RX Data Block Fast

This command is identical to RX Data Block, except there is no reply indicating the data was correctly programmed. It is used primarily to speed up USB programming.

RX Password

The BSL core receives the password contained in the packet and unlocks the BSL protected commands if the password matches the top 16 words in the BSL interrupt vector table (located between addresses 0xFFE0 and 0xFFFF). When an incorrect password is given, a mass erase is initiated. This means all code flash is erased, **but not Information Memory**.

Erase Segment

The flash segment containing the given address is subjected to an erase.

Unlock and Lock Info

This command causes the INFO_A lock to toggle to either protect or lock the INFO_A segment. See the [MSP430F5xx and MSP430F6xx Family User's Guide](#) for more detail on this lock. This command must be sent before an erase segment command for INFO_A but is not required before a mass erase.

Erase Block

The flash block containing the given address is subjected to an erase.

Mass Erase

All code flash in the MSP430 MCU is erased. This function **does not** erase Information Memory.

CRC Check

The MCU performs a 16-bit CRC check using the CCITT standard. The address given is the first byte of the CRC check. Two bytes are used for the length.

Load PC

Causes the BSL to begin execution at the given address using a CALLA instruction. As BSL code is immediately exited with this instruction, no core response can be expected.

TX BSL Version

BSL transmits its version information (see [Section 3.7.3](#) for more details).

TX Buffer Size

The BSL transmits a value that represents the number of bytes available in its data buffer for sending or receiving BSL core data packets.

3.6 BSL Security

3.6.1 Protected Commands

To protect data within the device, most core commands are protected. A protected command is successfully complete only after the device has been unlocked by sending the RX Password command with the correct password. In addition, commands specific to the peripheral interface are not protected.

Unprotected Commands

RX Password

Mass Erase

Password Protected Commands

RX Data Block to Address (flash or RAM)

TX BSL Version

TX Data Block

Erase Segment

Erase Bank

Set Program Counter

Toggle INFO_A Lock

Erase Main

CRC Check

3.6.2 RAM Erase

At start-up, the BSL performs a RAM erase, writing a constant word to certain RAM locations in a device. Usually these are the smallest shared RAM addresses within a family. See [Section 5](#) for device specific information.

3.7 BSL Core Responses

The BSL core responses are always wrapped in a peripheral interface wrapper with the identical format to that of received commands. The BSL core can respond in the format shown in [Table 3-6](#). All numbers are in hexadecimal format.

Table 3-6. BSL Core Responses

BSL Response	CMD	Data
Data Block	0x3A	D1 ... Dn
BSL Version	0x3A	D1 ... D4
CRC Value	0x3A	DL, DH
Buffer Size	0x3A	NL, NH
Message	0x3B	MSG

3.7.1 Abbreviations

CMD

A required field used to distinguish between a message from the BSL and a data transmission from the BSL.

MSG

A byte containing a response from the BSL core describing the result of the requested action. This can either be an error code or an acknowledgment of a successful operation. In cases where the BSL is required to respond with data (for example, memory, version, CRC, or buffer size), no successful operation reply occurs, and the BSL core immediately sends the data.

D1, Dx

Data bytes containing the requested data.

DL, DH

Data low and high bytes, respectively, of a requested 16-bit CRC value.

NL, NH

Data bytes describing the length of the buffer size in bytes. To manage sizes above 255, the size is broken up into a low byte and a high byte.

3.7.2 BSL Core Messages

Table 3-7 describes the BSL core messages.

Table 3-7. BSL Core Messages

MSG	Meaning
0x00	Operation Successful
0x01	Flash Write Check Failed. After programming, a CRC is run on the programmed data. If the CRC does not match the expected result, this error is returned.
0x02	Flash Fail Bit Set. An operation set the FAIL bit in the flash controller (see the MSP430F5xx and MSP430F6xx Family User's Guide for more details on the flash fail bit).
0x03	Voltage Change During Program. The VPE was set during the requested write operation (see the MSP430F5xx and MSP430F6xx Family User's Guide for more details on the VPE bit).
0x04	BSL Locked. The correct password has not yet been supplied to unlock the BSL.
0x05	BSL Password Error. An incorrect password was supplied to the BSL when attempting an unlock.
0x06	Byte Write Forbidden. This error is returned when a byte write is attempted in a flash area.
0x07	Unknown Command. The command given to the BSL was not recognized.
0x08	Packet Length Exceeds Buffer Size. The supplied packet length value is too large to be held in the BSL receive buffer.

3.7.3 BSL Version Number

The BSL version number is a 4-byte array.

Byte1: BSL Vendor information

TI BSL is always 0x00. Non-TI BSLs can use this area in another manner.

Byte 2: Command Interpreter Version

The version number for the section of code that interprets BSL core commands.

Byte 3: API Version

The version number for the section of code that reads and writes to MSP430 MCU memory.

Reserved bits:

0x00 indicates that this BSL API interfaces with flash.

0x30 indicates that this BSL API interfaces with FRAM.

0x80 indicates that this BSL can only execute the following commands:

RX Data Block Fast (and can only write to RAM)

RX Password

Set PC

Byte 4: Peripheral Interface Version

The version number for the section of code that manages communication.

Reserved numbers:

0x00 to 0x2F: Indicates a Timer_A-based UART

0x30 to 0x4F: Indicates USB

0x50 to 0x6F: Indicates USCI-based UART

0x70 to 0x8F: Indicates eUSCI-based UART

0x90 to 0x9F: Indicates USCI_B-based I²C

0xA0 to 0xAF: Indicates eUSCI-based I²C

0xB0 to 0xCF: Indicates eUSCI-based I²C and UART

3.7.4 Example Sequences for UART BSL

Note

All values in the example sequences are hexadecimal.

Changing baud rate to 9600

Host: 80 02 00 52 02 90 55

BSL: 00

Get buffer size

Host: 80 01 00 1A 8B 52

BSL: 00 80 03 00 3A 04 01 1D 12

Get BSL version

Host: 80 01 00 19 E8 62

BSL: 00 80 05 00 3A 00 01 01 01 6C 4F

RX password to unlock BSL

Host: 80 11 00 11 FF FF FF FF FF FF FF FF FF FF FF FF FF FF FF 00 5C 38 4F

BSL: 00 80 02 00 3B 00 60 C4

3.8 BSL Public Functions and Z-Area

The BSL Z-Area is a small section of memory that can be read and invoked from application code. It is located at memory addresses 0x1000 to 0x100F.

Memory location 0x1000 contains a jump instruction pointing to the BSL start, it can be used to invoke the BSL from a running application.

Memory location 0x1002 contains a jump to the "BSL Action" function. To invoke the action function, three parameters are needed. The first parameter is a number describing which function, the second two are simply known values to indicate that the function was called intentionally.

R12: The function number

R13: 0xDEAD

R14: 0xBEEF

3.8.1 Starting the BSL From an External Application

Setting the program counter to the memory location 0x1000 starts the BSL. The stack is always reset, and RAM is cleared. It should be noted that the GIE bit is not disabled, so this should be done by the calling application if interrupts are not desired and appropriately returned from "Return to BSL" if they are used.

Because the stack is reset, the location 0x1000 can also be called as a C function, as in the following example code:

```

_disable_interrupt();
((void (*)(void))0x1000)();

```

If a USB stack is operating before the USB BSL is invoked, this USB stack must be disconnected first. The following example shows the recommended sequence in C:

TI recommends clearing the configuration of any module registers that are used in the BSL application, because the configuration for the external application can interrupt the BSL application and cause unexpected behavior.

One example is that in the USB BSL, the Timer_B module is used in clock initialization. If Timer_B is also used in the external application, this might cause a failure in BSL initialization.

```
__disable_interrupt();  
USBKEYPID = 0x9628; // Unlock USB configuration registers  
USBCNF &= ~PUR_EN; // Set PUR pin to hi-Z, logically disconnect from host  
USBPWRCTL &= ~VBOFFIE; // Disable VUSBoff interrupt  
USBKEYPID = 0x9600; // Lock USB configuration register  
__delay_cycles(500000);  
((void (*)( ))0x1000)(); // Call BSL
```

TI recommends testing this sequence on various hosts.

3.8.2 Return to BSL Function Description

Function number: 2

Function Name: Return to BSL

Description: Any supplied function number calls the return to BSL function. This function can be used if the BSL has written a program into flash or RAM, started that program by "Set PC", and then the program needs to return to the BSL. This function executes the following code:

```
RETURN_TO_BSL POP.W RET_low ; remove first word from return addr POP.W RET_high  
; remove second word from return addr RETA  
; should now return to the BSL location
```

4 Bootloader Hardware

This chapter describes simple and low-cost hardware and software solutions to access the bootloader functions of the MSP430 flash devices through the serial port (RS-232) of a PC.

4.1 Hardware Description

The low-cost hardware presented in this document (see [Figure 4-1](#)) consists mainly of a low-dropout voltage regulator, some inverters, and operational amplifiers. There are also some resistors, capacitors, and diodes. [Table 4-4](#) lists the required parts.

The functional blocks are described in more detail in the following sections.

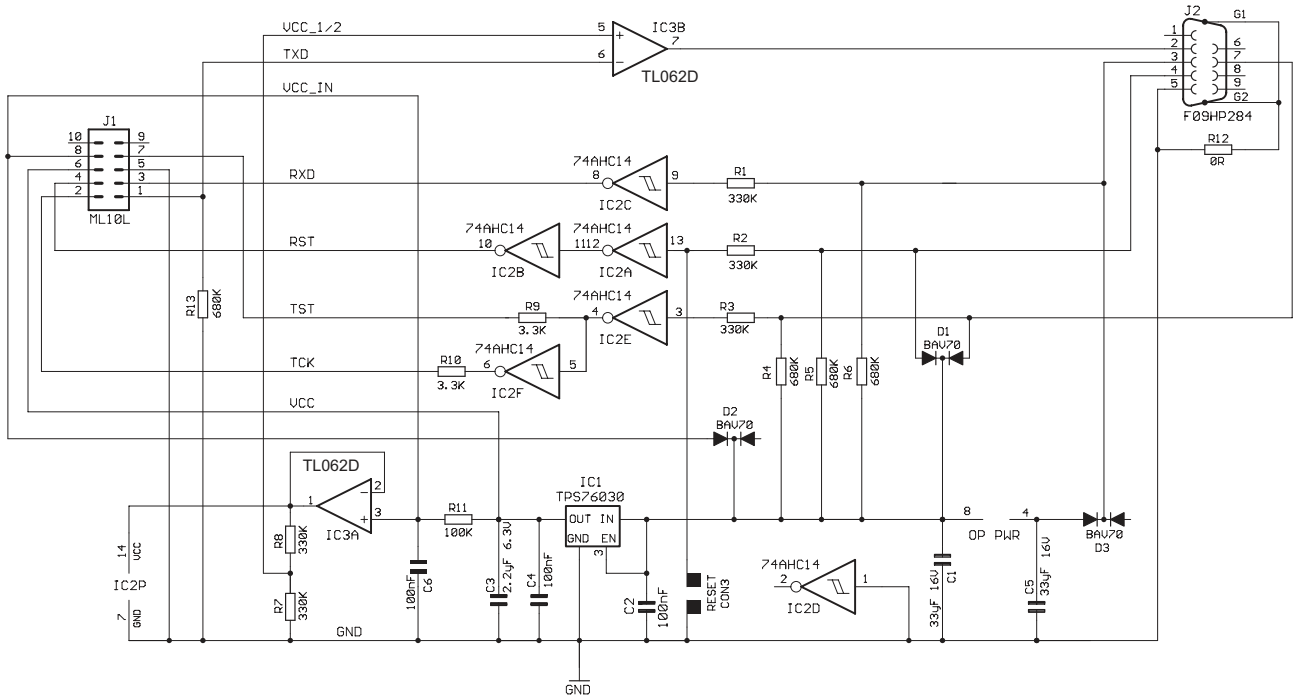

Figure 4-1. Bootloader Interface Schematic

4.1.1 Power Supply

Power for the bootloader hardware can be supplied from the RS-232 interface. RS-232 signals DTR (pin 7 of the serial connector) and RTS (pin 4 of the serial connector) normally deliver a positive voltage to load capacitor C1 and power to the low-dropout voltage regulator IC1 (TI TPS76030 or LP2980-3.0, or equivalent 3-V low-dropout regulator).

Using a fairly big capacitor, it is possible to draw a short-duration current that is higher than the driving serial port can supply. This feature is required to program the flash memory, for example.

It is also possible to connect an external supply voltage to the hardware on pin 8 of the BSL target connector (J1). Diodes are used to prevent reverse-polarity flow.

4.1.2 Serial Interface

Table 4-1 shows the signals used to communicate with the bootloader (through connector J2). The names reflect the pin function as seen from the PC. For example, the PC receives data through the RxD pin, whereas the bootloader needs to drive this signal.

Table 4-1. Serial-Port Signals and Pin Assignments

Pin Name	Full Name (PC)	9-Pin Sub-D	Function on BSL Interface
RxD	Receive data	2	Transmit data to PC
TxD	Transmit data	3	Receive data from PC (and negative supply)
DTR	Data terminal ready	4	Reset control (and positive supply)
RTS	Request to send	7	TEST or TCK control (and positive supply)
GND	Ground	5	Ground

4.1.2.1 Level Shifting

Simple CMOS inverters with Schmitt-trigger characteristics (IC2) are used to transform the RS-232 levels (see Table 4-2) to CMOS levels.

Table 4-2. RS-232 Levels

Logic Level	RS-232 Level	RS-232 Voltage Level
1	Mark	-3 V to -15 V
0	Space	3 V to 15 V

The inverters are powered by the operational amplifier IC3A. This amplifier permits adjusting the provided logic level to the requirements of the connected target application. A voltage applied to pin 8 of the BSL target connector (VCC_IN) overrides the default 3-V level provided from IC1 and the 100-k Ω series resistor R11. Thus, the output voltage of the operational amplifier is pulled to the applied voltage VCC_IN.

Depending on the overvoltage protection of the device family selected, the excess voltage is either conducted to V_{CC} (as in the TI 74HC14) or to GND (as in the TI 74AHC14). If the protection diode conducts to V_{CC}, the operational amplifier IC3A needs to compensate for the overvoltage. Therefore, TI recommends the 74AHC14 device, which conducts to ground (GND).

To avoid excessive power dissipation and damage of the protection diodes, series resistors (R1, R2, and R3) are used to limit the input current.

An operational amplifier (IC3B) is used to generate RS-232 levels out of CMOS levels. The level at the positive input is set to V_{CC}/2 (1.5 V nominal). If the level at the negative input rises above this level, the output is pulled to the negative supply of the operational amplifier (mark). If the level drops below V_{CC}/2, the output is pulled to the positive rail (space).

The positive supply of the operational amplifier is the same as the input to the voltage regulator. A separate capacitor (C5) is used to generate the negative supply voltage. This capacitor is charged by the receiving signal of the bootloader hardware (pin 3 on SUB-D connector J2).

During an asynchronous serial communication, the combination of stop bit and start bit is used to synchronize sender and receiver. After the transmission of a data byte, the stop bit forces the transmission line into a defined state, which is usually a logic 1 or, in RS-232 terms, a mark. This means that the transmission-line voltage is negative when there is no transmission and the capacitor can be charged. Diodes are used to prevent discharge of the capacitor during transmission.

In very rare circumstances, the data sent to the bootloader interface might hold too many zeros, so that the capacitor C5 required for the negative supply is discharged, causing a malfunction of the interface. (A possible workaround is to send the data in smaller chunks.) However, under normal operating conditions, even data that contains all zeros does not cause problems.

4.1.2.2 Control of $\overline{\text{RST/NMI}}$ and TEST or TCK Pins

The two pins used to invoke the bootloader software of the MSP430 MCU— $\overline{\text{RST/NMI}}$ and TEST or TCK (for devices without a dedicated TEST pin)—are controlled by the DTR and RTS signals, respectively. These signals also deliver a positive voltage to supply the bootloader hardware.

For devices with a dedicated TEST pin, the levels at $\overline{\text{RST/NMI}}$ and TEST during normal operation are logic 1 and logic 0, respectively. To achieve these levels and to use the corresponding RS-232 signals as power-supply lines, it is necessary to use two inverters (IC1A, IC2B) for the $\overline{\text{RST/NMI}}$ pin and one inverter (IC2E) for the TEST pin.

Devices without the TEST pin require the inverted TEST pin sequence on their TCK pin to invoke the bootloader. Thus, the corresponding signal is inverted (inverter IC2F).

Diodes prevent discharge of capacitor C1 to allow control of the RS-232 lines (RTS and DTR).

4.1.3 Target Connector

Table 4-3. Pin Assignment of Target Connector⁽¹⁾

Pin	Signal Name	Devices With Test Pin	Pin on MSP430F13x or MSP430F14x	Pin on MSP430F4xx
1	TXD	P1.1	P1.1	P1.0
2	TCK	Do not connect ⁽²⁾	TCK	TCK
3	RXD	P2.2	P2.2	P1.1
4	RST	$\overline{\text{RST/NMI}}$	$\overline{\text{RST/NMI}}$	$\overline{\text{RST/NMI}}$
5	GND	GND	GND	GND
6	V _{CC} (3.0 V)	V _{CC} ⁽³⁾	V _{CC} ⁽³⁾	V _{CC} ⁽³⁾
7	TST	TEST	Do not connect	Do not connect
8	VCC_IN	V _{CC} ⁽³⁾	V _{CC} ⁽³⁾	V _{CC} ⁽³⁾
9	Not connected	—	—	—
10	Not connected	—	—	—

(1) For device-specific BSL pin information, see the applicable device data sheet.

(2) Signal TCK must not be connected on devices with the TEST pin.

(3) Pin V_{CC} (3.0 V) is a voltage source that can provide a limited current, depending on the serial port driver capability. If an external power supply is used, V_{CC} (3.0 V) must not be connected to the target. In this case, the external supply voltage must be connected to pin VCC_IN. Otherwise, VCC_IN must be unconnected.

4.1.4 Parts List

Table 4-4 lists the BSL interface parts.

Table 4-4. Universal BSL Interface Parts List

Part	Value or Part Number	Package	Comment
C1	33 μ F, 16 V	SMD 7243	
C2	100 nF	SMD 0805	
C3	2.2 μ F, 6.3 V	SMD 1206	
C4	100 nF	SMD 0805	
C5	33 μ F, 16 V	SMD 7243	
C6	100 nF	SMD 0805	
D1	BAV70	SOT23	High-speed double diode
D2	BAV70	SOT23	High-speed double diode
D3	BAV70	SOT23	
IC1	TPS76030	SOT23-5	TI
IC2	74AHC14	SO14	TI
IC3	TL062D	SO8	TI
R1	330 k Ω	SMD 0805	
R2	330 k Ω	SMD 0805	
R3	330 k Ω	SMD 0805	
R4	680 k Ω	SMD 0805	
R5	680 k Ω	SMD 0805	
R6	680 k Ω	SMD 0805	
R7	330 k Ω	SMD 0805	
R8	330 k Ω	SMD 0805	
R9	3.3 k Ω	SMD 0805	
R10	3.3 k Ω	SMD 0805	
R11	100 k Ω	SMD 0805	
R12	0 k Ω	SMD 0805	
R13	680 k Ω	SMD 0805	
J1	Header 2x5	2X05	Target connector (see Table 4-3)
J2	F09HP284	9-SUB-D female	RS-232 connector
CON3	RESET	SMD0805	Pads to connect an optional reset button

5 Differences Between Devices and Bootloader Versions

5.1 1xx, 2xx, and 4xx BSL Versions

The tables in this section show the key information of MSP430 device to BSL version assignment related to their hardware and software resources.

Table 5-1. BSL Version 1.10 on F13x, F14x(1) (excluding Rev AA), F11x, and F11x1

Device		F13x F14x(1) up to Rev N	F11x (obsolete) F11x1 (obsolete)
BSL Version		1.10	
BSL vector address	Cold start	0C00h	
	Warm start	—	
Chip ID address		0FF0h	
Chip ID data		F149h	F112h
BSL version address		0FFAh	
BSL version data		0110h	
Mass erase time, nominal (ms)		17.2 ⁽¹⁾	
Read and write access at 0000h to FFFFh		Byte	
Verification during write (online)		No	
Stack pointer initialization	SP critical	021Ah	
	SP not critical	Unchanged	
Resources Used by BSL			
Transmit pin (TX), Receive pin (RX)		P1.1, P2.2	
RAM stack used		0200h to 0219h	
Working registers		R5 to R9	
System clock, affected controls		BCSCTL1, DCOCTL	
Timer_A, affected controls		TACTL, TAR, CCTLO, CCR0	
Preparation for software call		<pre> mov #00h, &CCTL0 bic.b #02h, &P1SEL bic.b #04h, &P2SEL bic.b #32h, &IE1 mov.b #00h, &BCSCTL2 mov #00h, SR br &0C00h </pre>	
Comment 1 Workaround mandatory		Load PATCH.TXT to eliminate ROM bug (see Section 5.2 and Section 2.5).	
Comment 2 Optional for F148, F149 only: Use loadable BSL (>1 KB RAM required)		Load BL_150S_14x.txt to get all features of V1.60 plus valid erase segment command (see Section 2.5).	
Comment 3 Optional for F1x4 to F1x9: Use small loadable BSL (<512B RAM required)		Load BS_150S_14x.txt to get some features of V1.60 (see Section 2.5).	

(1) To reach the required mass erase time as specified in the data sheet, the mass erase command must be executed several times.

Table 5-2. BSL Version 1.30 on F41x, F11x, and F11x1

Device		F41x	F11x (obsolete) F11x1A
BSL Version		1.30	
BSL vector address	Cold start	0C00h	
	Warm start	0C02h	
Chip ID address		0FF0h	
Chip ID data		F143h	F112h
BSL version address		0FFAh	
BSL version data		0130h	
Mass erase time, nominal (ms)		206.4	
Read and write access at	0000h to 00FFh	Byte	
	0100h to FFEh	Word	
Verification during write (online)		No	
Stack pointer initialization	Cold start	0220h	
	Warm start	Unchanged	
Resources Used by BSL			
Transmit pin (TX)		P1.0	P1.1
Receive pin (RX)		P2.1	P2.2
RAM stack used		0200h to 021Fh	
Working registers		R5 to R9	
System clock, affected controls		SCFI0, SCFI1, SCFQCTL	BCSCTL1, DCOCTL
Timer_A, affected controls		TACTL, TAR, CCTL0, CCR0	
Preparation for software call		<pre> mov #00h, &CCTL0 mov.b #00h, &FLLCTL1 br &0C00h </pre>	<pre> mov #00h, &CCTL0 mov.b #00h, &BCSCTL2 mov #00h, SR br &0C00h </pre>

Table 5-3. BSL Version 1.40 on F12x

Device		F122, F123x
BSL Version		1.40
BSL vector address	Cold start	0C00h
	Warm start	0C02h
Chip ID address		0FF0h
Chip ID data		F123h
BSL version address		0FFAh
BSL version data		0140h
Mass erase time, nominal (ms)		206.4
Read and write access at	0000h to 00FFh	Byte
	0100h to FFEh	Word
Verification during write (online)		For addresses 0200h to FFEh
Stack pointer initialization	Cold start	0220h
	Warm start	Unchanged
Resources Used by BSL		
Transmit pin (TX)		P1.1
Receive pin (RX)		P2.2
RAM stack used		0200h to 021Fh
Working registers		R5 to R10
System clock, affected controls		BCSCTL1, DCOCTL
Timer_A, affected controls		TACTL, TAR, CCTLO, CCR0
Preparation for software call		<pre> mov.b #00h, &BCSCTL2 mov #00h, SR br &0C00h </pre>

Table 5-4. BSL Version 1.60 on F11x2, F12x2, F43x, F44x, FE42x, FW42x, F43x, FG43x, F415, F417

Device		F1122, F1132	F1222, F1232	F43x, F44x	FE42x, FW42x, F415, F417	F43x, FG43x
BSL Version		1.60				
BSL vector address	Cold start	0C00h				
	Warm start	0C02h				
Chip ID address		0FF0h				
Chip ID data		1132h	1232h	F449h	F427h	F439h
BSL version address		0FFAh				
BSL version data		0160h				
Mass erase time, nominal (ms)		206.4				
Read and write access at	0000h to 00FFh	Byte				
	0100h to FFFEh	Word				
Verification during write (online)		For addresses 0200h to FFFEh				
Erase check command		Yes (error address 0200h)				
Erase segment command		With erasure verification (error address 0200h)				
TX identification command		Yes				
Change baud rate command		Yes				
Stack pointer initialization	Cold start	0220h				
	Warm start	Unchanged				
Resources Used by BSL						
Transmit pin (TX)		P1.1		P1.0		
Receive pin (RX)		P2.2		P1.1		
RAM stack used		0200h to 021Fh				
Working registers		R5 to R12				
System clock, affected controls		BCSCTL1, DCOCTL		SCFI0, SCFI1, SCFQCTL		
Timer_A, affected controls		TACTL, TAR, CCTLO, CCR0				
Preparation for software call		<pre>mov.b #00h, &BCSCTL2 mov #00h, SR br &0C00h</pre>		<pre>mov.b #00h, &FLCTL1 br &0C00h</pre>		
Comment	Erase segment command	Addresses 1000h to 11FFh are verified coherently (three segments). Also use erase check command.				

Table 5-5. BSL Version 1.61 on F16x, F161x, F42x0, F13x rev AA, F14x(1) rev AA, F47x, FG47x

Device		F16x	F161x	F149 Rev AA	F42x0	F41x2	F47197	FG47x
BSL Version		1.61						
BSL vector address	Cold start	0C00h						
	Warm start	0C02h						
Chip ID address		0FF0h						
Chip ID data		0F169h	0F16Ch	F149h	F427h	4152h	F47Fh	0F479h
BSL version address		0FFAh						
BSL version data		0161h						
Mass erase time, nominal (ms)		206.4						
Read and write access at	0000h to 00FFh	Byte						
	0100h to FFFEh	Word						
Verification during write (online)		For addresses 0200h to FFFEh						
Erase check command		Yes (error address 0200h)						
Erase segment command		With erasure verification (error address 0200h)						
TX identification command		Yes						
Change baud rate command		Yes						
Stack pointer initialization	Cold start	0220h						
	Warm start	Unchanged						
Resources Used by BSL								
Transmit pin (TX)		P1.1			P1.0			
Receive pin (RX)		P2.2			P1.1			
RAM stack used		0200h to 021Fh						
Working registers		R5 to R14						
System clock, affected controls		BCSCTL1, DCOCTL			SCFI0, SCFI1, SCFQCTL			
Timer_A, affected controls		TACTL, TAR, CCTL0, CCR0						
Preparation for software call		<pre>mov.b #00h, &BCSCTL2 mov #00h, SR br &0C00h</pre>			<pre>mov.b #00h, &FLLCTL1 br &0C00h</pre>			
Comment	Erase segment command	Addresses 1000h to 11FFh are verified coherently (three segments). Also use erase check command.						

Table 5-6. BSL Version 2.02 and 2.13 on F21xx, F22xx, F23xx, F24xx, F261x

Device		F21xx	F22xx	F23xx	F24x	F261x
BSL Version		2.02				2.13
BSL Vector Address	Cold Start	0C00h				
	Warm Start	0C02h ⁽¹⁾				
Chip ID Address		0FF0h				
Chip ID Data		F213h	F227h	F237h	F249h	F26Fh
BSL Version Address		0FFAh				
BSL Version Data		0202h				0213h
Read and Write Access at	0000h to 00FFh	Byte				
	0100h to FFFEh	Word				
Verification during write (online)		For addresses 0200h to FFFEh				
Erase Check Command		Yes (error address 0200h)				
Erase Segment Command		With erasure verification (error address 0200h)				
TX Identification command		Yes				
Change baud rate command		Yes				
Stack Pointer Initialization	Cold Start	0220h				0224h
	Warm Start	Unchanged				
Resources Used by BSL						
Transmit Pin (TX)		P1.1				
Receive Pin (RX)		P2.2				
RAM Stack Used		0200h to 021Fh				0200h to 0223h
Working Registers		R5 to R14				R4 to R15
System clock, affected controls		BCSCTL1, DCOCTL				SCFI0, SCFI1, SCFQCTL
Timer_A, Affected controls		TACTL, TAR, CCTLO, CCR0				
Preparation for software call		<pre> mov.b #00h, &BCSCTL2 mov #00h, SR br &0C00h </pre>				
Comment	Erase Segment Command	Addresses 1000h to 11FFh are verified coherently (five segments). Also use erase check command.				

- (1) The LOCK and LOCKA bits must be cleared by the user application before entering the BSL:

```

mov.w #FWKEY+LOCKA, &FCTL3

```

Table 5-7. BSL Version 2.02 and 2.03 on G2xx3, G2xx4, G2xx5, TCH5E⁽¹⁾

Device		G2xx4	G2xx5	G2xx3	TCH5E
BSL Version		2.02		2.03	
BSL Vector Address	Cold Start	0C00h			
	Warm Start	0C02h ⁽²⁾			
Chip ID Address		0FF0h			
Chip ID Data		F227h	2955h	2553h	255Ch
BSL Version Address		0FFAh			
BSL Version Data		0202h		0203h	
Read and Write Access at	0000h to 00FFh	Byte			
	0100h to FFFEh	Word			
Verification during write (online)		For addresses 0200h to FFFEh			
Erase Check Command		Yes (error address 0200h)			
Erase Segment Command		With erasure verification (error address 0200h)			
TX Identification command		Yes			
Change baud rate command		Yes			
Stack Pointer Initialization	Cold Start	0220h			
	Warm Start	Unchanged			
Resources Used by BSL					
Transmit Pin (TX)		P1.1		P1.1	
Receive Pin (RX)		P2.2		P1.5	
RAM Stack Used		0200h to 021Fh			
Working Registers		R5 to R14			
System clock, affected controls		BCSCTL1, DCOCTL			
Timer_A, Affected controls		TACTL, TAR, CCTL0, CCR0			
Preparation for software call		<pre>mov.b #00h, &BCSCTL2 mov #00h, SR br &0C00h</pre>			
Comment	Erase Segment Command	Addresses 1000h to 11FFh are verified coherently (five segments). Also use erase check command.			

- (1) Not all Value Line devices contain a BSL; see device-specific data sheet.
(2) The LOCK and LOCKA bits must be cleared by the user application before entering the BSL:

```
mov.w #FWKEY+LOCKA, &FCTL3
```

Table 5-8. BSL Version 2.12 and 2.13 on FG46xx, F471xx

Device		FG46xx	F471xx
BSL Version		2.12	2.13
BSL vector address	Cold start	0C00h	
	Warm start	0C02h ⁽¹⁾	
Chip ID address		0FF0h	
Chip ID data		F46Fh	
BSL version address		0FFAh	
BSL version data		0212h	0213h
Mass erase time, nominal (ms)		206.4	
Read and write access at	0000h to 00FFh	Byte	
	0100h to FFEh	Word	
Verification during write (online)		For addresses 0200h to FFEh	
Erase check command		Yes (error address 0200h)	
Erase segment command		Erase segment command with erasure verification (error address 0200h)	
TX identification command		Yes	
Change baud rate command		Yes	
Stack pointer initialization	Cold start	0224h	
	Warm start	Unchanged	
Resources Used by BSL			
Transmit pin (TX)		P1.0	
Receive pin (RX)		P1.1	
RAM stack used		0200h to 0223h	
Working registers		R4 to R15	
System clock, affected controls		SCF10, SCF11, SCFQCTL	
Timer_A, affected controls		TACTL, TAR, CCTL0, CCR0	
Preparation for software call		<pre>mov.b #00h, &FLLCTL1 br &0C00h</pre>	
Comment	Erase segment command	Addresses 1000h to 11FFh are verified coherently (five segments). Also use erase check command.	

(1) The LOCK and LOCKA bits must be cleared by the user application before entering the BSL:

```
mov.w #FWKEY+LOCKA, &FCTL3 .
```

5.2 Special Consideration for ROM BSL Version 1.10

The first official version V1.10 of the ROM BSL requires a small loadable patch sequence, PATCH.TXT, to reliably execute the RX block command. The same procedure must be executed if a loadable BSL is downloaded to such a device. After the BSL has been started, proceed in the following manner:

1. RX password (unlock password protection for the following command)
2. Load program counter (PC) with 0C22h (initialize stack pointer to a safe address)
3. RX password again (unlock password protection for subsequent commands)
4. RX data block (code of loadable patch, code section address is 0220h)
5. TX data block (code of loadable patch for verification)

From this time forward, the RX block and TX block commands can be used with one restriction: prior to their invocation, the program counter must be set to the start address of the patch.

1. Load program counter (PC) with start address 0220h of loadable patch
2. RX data block (code to be programmed at any location), or
3. TX data block (from any location)

5.3 1xx, 2xx, and 4xx BSL Known Issues

BSL Command	Erase Main or Info
Versions Affected	1.x
Description	Does not erase information memory when supplied with address in information memory
Workarounds	Use Erase Segment command

BSL Command	Erase Main or Info
Versions Affected	1.x
Description	Reports failure when first segment of code memory is supplied as address. However, the erase is properly performed.
Workarounds	Use any other main memory address

BSL Command	Erase Segment
Versions Affected	1.x
Description	Reports failure when used in information memory. However, the erase is properly performed.
Workarounds	None

5.4 Special Note on the MSP430F14x Device Family BSL

Revision AA of the MSP430F14x devices have a BSL that was updated to Version 1.61. The primary reasons for this change were to increase IP security, ensure correct flash programming and mass erase, and to negate the need for using any patches during programming. To ensure a smooth transition, a programming environment should be updated to take into account the following changes:

- The Mass Erase command needs to be issued only once, and execution of this command takes longer.
- Only word writes are allowed to flash memory.
- No patch or RAM loadable BSL is required.
- BSL has "online verification" to speed programming.
- Memory allocation has changed (see BSL version charts in [Section 5.3](#)).
- BSL can return a NAK if Segment Erase fails.
- Transmit BSL Version and Change Baud rate are now unprotected.

5.5 F5xx and F6xx Flash-Based BSL Versions

Table 5-9.

Devices	MSP430F5438, MSP430F5437, MSP430F5435, MSP430F5436, MSP430F5435, MSP430F5419, MSP430F5418
BSL Version	00.01.01.01
RAM Erased	None
Buffer Size for Core Commands	260 bytes
Notable Information	<ol style="list-style-type: none"> 1. UART TX and RX BSL pins are noted in the device data sheet 2. Due to the known errata SYS4 and FLASH32, BSL is not reprogrammable. 3. However, the JTAGLOCK KEY (which resided on the BSL area) can still be programmed through BSL itself. Note that this leads to the ability to lock and unlock JTAG one time. Locking JTAG is performed by writing 0x5555 to the JTAGLOCK KEY, and unlocking JTAG is performed by writing 0x0000. Once this is done, there is no chance to lock back the JTAG, as it needs the entire BSL programming. 4. The only supported baud rates are 9600 and 57600. 5. The BSL transmits on TA0.0 and receives on TA0.1. 6. The BSL does not expect a parity bit.
Known Bugs	<ol style="list-style-type: none"> 1. The password for the BSL is the bytes between addresses 0xFFFF0 and 0xFFFF. This means that this BSL version expects only 16 bytes for a password in the RX Password command. Sending 32 bytes returns an error. 2. If the address 0x20396 or 0x20397 is included in the address range of the CRC command, the returned data is incorrect. 3. The Mass Erase command also erases Info_A. 4. On incorrect password, the device erases all RAM, including its stack. Thus, proper return of an error code is not assured. 5. The total number of bytes for the CRC function is masked with 0x7FFF and is, therefore, limited to 32767.

Table 5-10.

Devices	MSP430F5438A, MSP430F5437A, MSP430F5435A, MSP430F5436A, MSP430F5435A, MSP430F5419A, MSP430F5418A
BSL Version	00.05.04.03 (Rev A to Rev E) 00.07.05.04 (Rev F and later)
RAM Erased	0x1C00 to 0x5BFF
Buffer Size for Core Commands	260 bytes
Notable Information	<ol style="list-style-type: none"> 1. UART TX and RX BSL pins are noted in the device data sheet
Known Bugs	<ol style="list-style-type: none"> 1. The baud rate of 115k cannot be ensured across all clock, voltage, and temperature variations.

Table 5-11.

Devices	CC430F6147, CC430F6145, CC430F6143, CC430F6137, CC430F6135, CC430F6127, CC430F6126, CC430F6125, CC430F5147, CC430F5145, CC430F5143, CC430F5137, CC430F5135, CC430F5133, CC430F5125, CC430F5123
BSL Version	00.05.04.52 (Rev A to Rev C) 00.07.05.53 (Rev D and later)
RAM Erased	0x1C00 to 0x23FF
Buffer Size for Core Commands	260 bytes
Notable Information	<ol style="list-style-type: none"> 1. UART TX and RX BSL pins are implemented on pin P1.6 (TXD) and P1.5 (RXD)
Known Bugs	<ol style="list-style-type: none"> 1. The baud rate of 115k cannot be ensured across all clock, voltage, and temperature variations.

Table 5-12.

Devices	MSP430F5510, MSP430F5500, MSP430F5501, MSP430F5502, MSP430F5503, MSP430F5504, MSP430F5505, MSP430F5506, MSP430F5507, MSP430F5508, MSP430F5509
BSL Version	00.03.83.33 (Rev A to Rev E) 00.07.88.38 (Rev F until May 2015) 00.08.88.39 (Rev F and later)
RAM Erased	0x2400 to 0x33FF
Buffer Size for Core Commands	62 bytes
Notable Information	<ol style="list-style-type: none"> 1. Device is programmed with the factory USB BSL. 2. Factory USB BSL is RAM write only. Full BSL must first be loaded into device RAM and started to perform flash write. Only the commands RX PASSWORD, RX DATA BLOCK FAST, and SET PC are supported. 3. When starting this BSL from an application, the application should first de-enumerate itself, then delay (approximately 500 ms) before starting the BSL. This allows proper re-enumeration with the host. 4. External crystal at XT2 is required to ensure USB operation.
Known Bugs	The USB module is not correctly locked by the BSL. For legacy reasons this behavior is kept.

Table 5-13.

Devices	MSP430F5529, MSP430F5513, MSP430F5514, MSP430F5515, MSP430F5517, MSP430F5519, MSP430F5521, MSP430F5522, MSP430F5524, MSP430F5525, MSP430F5526, MSP430F5527, MSP430F5528
BSL Version	00.03.83.33 (Rev A to Rev H) 00.07.85.36 (Rev I) 00.07.87.37 (Rev J) 00.07.88.38 (Rev K until May 2015) 00.08.88.39 (Rev K and later)
RAM Erased	0x2400 to 0x33FF
Buffer Size for Core Commands	62 bytes
Notable Information	<ol style="list-style-type: none"> 1. Device is programmed with the factory USB BSL. 2. Factory USB BSL is RAM write only. Full BSL must first be loaded into device RAM and started to perform flash write. Only the commands RX PASSWORD, RX DATA BLOCK FAST, and SET PC are supported. 3. When starting this BSL from an application, the application should first de-enumerate itself, then delay (approximately 500 ms) before starting the BSL. This allows proper re-enumeration with the host. 4. External crystal at XT2 is required to ensure USB operation.
Known Bugs	The USB module is not correctly locked by the BSL. For legacy reasons this behavior is kept.

Table 5-14.

Devices	MSP430F5172, MSP430F5152, MSP430F5132, MSP430F5171, MSP430F5151, MSP430F5131
BSL Version	00.07.05.04
RAM Erased	0x1C00 to 0x1FFF
Buffer Size for Core Commands	260 bytes
Notable Information	<ol style="list-style-type: none"> 1. UART TX and RX BSL pins are noted in the device data sheet
Known Bugs	<ol style="list-style-type: none"> 1. The baud rate of 115k cannot be ensured across all clock, voltage, and temperature variations.

Table 5-15.

Devices	MSP430F5229, MSP430F5227, MSP430F5219, MSP430F5217, MSP430F5224, MSP430F5222, MSP430F5213, MSP430F5212
BSL Version	00.07.05.04
RAM Erased	0x2400 to 0x43FF
Buffer Size for Core Commands	260 bytes
Notable Information	1. UART TX and RX BSL pins are noted in the device data sheet
Known Bugs	1. The baud rate of 115k cannot be ensured across all clock, voltage, and temperature variations.

Table 5-16.

Devices	MSP430F5249, MSP430F5247, MSP430F5244, MSP430F5242, MSP430F5239, MSP430F5237, MSP430F5234, MSP430F5232
BSL Version	00.08.08.04
RAM Erased	0x2400 to 0x43FF
Buffer Size for Core Commands	260 bytes
Notable Information	1. UART TX and RX BSL pins are noted in the device data sheet
Known Bugs	1. The baud rate of 115k cannot be ensured across all clock, voltage, and temperature variations.

Table 5-17.

Devices	MSP430F5255, MSP430F5254, MSP430F5253, MSP430F5252
BSL Version	00.08.08.04
RAM Erased	0x2400 to 0x43FF
Buffer Size for Core Commands	260 bytes
Notable Information	1. UART TX and RX BSL pins are noted in the device data sheet 2. A BSL firmware image that uses pins in the DVIO supply domain is available for download in the custom BSL package.
Known Bugs	1. The baud rate of 115k cannot be ensured across all clock, voltage, and temperature variations.

Table 5-18.

Devices	MSP430F5259, MSP430F5258, MSP430F5257, MSP430F5256
BSL Version	00.07.06.94
RAM erased	0x1C00 to 0x23FF
Buffer size for Core Commands	260 bytes
Notable Information	1. I ² C pins are noted in the device data sheet
Known Bugs	1. I ² C read commands with length greater than 260 do not return correct data.

Table 5-19.

Devices	MSP430F5310, MSP430F5309, MSP430F5308, MSP430F5304, MSP430F5340, MSP430F5341, MSP430F5342, MSP430F5329, MSP430F5324, MSP430F5325, MSP430F5326, MSP430F5327, MSP430F5328
BSL Version	00.06.04.04
RAM Erased	0x1C00 to 0x33FF
Buffer Size for Core Commands	260 bytes
Notable Information	1. UART TX and RX BSL pins are noted in the device data sheet
Known Bugs	1. The baud rate of 115k cannot be ensured across all clock, voltage, and temperature variations.

Table 5-20.

Devices	MSP430F6638, MSP430F6637, MSP430F6636, MSP430F6635, MSP430F6634, MSP430F6633, MSP430F6632, MSP430F6631, MSP430F6630, MSP430F5638, MSP430F5637, MSP430F5636, MSP430F5635, MSP430F5634, MSP430F5633, MSP430F5632, MSP430F5631, MSP430F5630
BSL Version	00.04.84.34 (Rev A to Rev D) 00.08.88.38 (Rev E until May 2015) 00.08.88.39 (Rev E and later)
RAM erased	0x2400 to 0x33FF
Buffer Size for Core Commands	62 bytes
Notable Information	<ol style="list-style-type: none"> Device is programmed with the factory USB BSL. Factory USB BSL is RAM write only. Full BSL must first be loaded into device RAM and started to perform flash write. Only the commands RX PASSWORD, RX DATA BLOCK FAST, and SET PC are supported When starting this BSL from an application, the application should first de-enumerate itself, then delay (approximately 500 ms) before starting the BSL. This allows proper re-enumeration with the host.
Known Bugs	The USB module is not correctly locked by the BSL. For legacy reasons this behavior is kept.

Table 5-21.

Devices	MSP430F6659, MSP430F6658, MSP430F5659, MSP430F5658
BSL Version	00.07.86.36 (Rev A) 00.08.88.38 (Rev B until May 2015) 00.08.88.39 (Rev B and later)
RAM Erased	0x2400 to 0x33FF
Buffer Size for Core Commands	62 bytes
Notable Information	<ol style="list-style-type: none"> Device is programmed with the factory USB BSL. Factory USB BSL is RAM write only. Full BSL must first be loaded into device RAM and started to perform flash write. Only the commands RX PASSWORD, RX DATA BLOCK FAST, and SET PC are supported When starting this BSL from an application, the application should first de-enumerate itself, then delay (approximately 500 ms) before starting the BSL. This allows proper re-enumeration with the host.
Known Bugs	

Table 5-22.

Devices	MSP430F6438, MSP430F6436, MSP430F6435, MSP430F6433, MSP430F5338, MSP430F5336, MSP430F5335, MSP430F5333, MSP430F6459, MSP430F6458, MSP430F5359, MSP430F5358
BSL Version	00.07.05.04
RAM Erased	0x1C00 to 0x43FF
Buffer Size for Core Commands	260 bytes
Notable Information	1. UART TX and RX BSL pins are noted in the device data sheet
Known Bugs	1. The baud rate of 115k cannot be ensured across all clock, voltage, and temperature variations.

Table 5-23.

Devices	MSP430F6736, MSP430F6720, MSP430F6721, MSP430F6723, MSP430F6724, MSP430F6725, MSP430F6726, MSP430F6730, MSP430F6731, MSP430F6733, MSP430F6734, MSP430F6735, MSP430F6736A, MSP430F6735A, MSP430F6734A, MSP430F6733A, MSP430F6731A, MSP430F6730A, MSP430F6726A, MSP430F6725A, MSP430F6724A, MSP430F6723A, MSP430F6721A, MSP430F6720A
BSL Version	00.07.05.04
RAM Erased	0x1C00 to 0x1FFF
Buffer Size for Core Commands	260 bytes
Notable Information	1. UART TX and RX BSL pins are noted in the device data sheet
Known Bugs	1. The baud rate of 115k cannot be ensured across all clock, voltage, and temperature variations.

Table 5-24.

Devices	MSP430F6779, MSP430F6745, MSP430F6746, MSP430F6747, MSP430F6748, MSP430F6749, MSP430F6765, MSP430F6776, MSP430F6767, MSP430F6768, MSP430F6769, MSP430F6775, MSP430F6776, MSP430F6777, MSP430F6778, MSP430F6779, MSP430F6745, MSP430F6746, MSP430F6747, MSP430F6748, MSP430F6749, MSP430F6765, MSP430F6766, MSP430F6767, MSP430F6768, MSP430F6769, MSP430F6775, MSP430F6776, MSP430F6777, MSP430F6778, MSP430F6779, MSP430F6745, MSP430F6746, MSP430F6747, MSP430F6748, MSP430F6749, MSP430F6765, MSP430F6766, MSP430F6767, MSP430F6768, MSP430F6769, MSP430F6775, MSP430F6776, MSP430F6777, MSP430F6778, MSP430F6779
BSL Version	00.07.05.04
RAM Erased	0x1C00 to 0x5BFF
Buffer Size for Core Commands	260 bytes
Notable Information	1. UART TX and RX BSL pins are noted in the device data sheet
Known Bugs	1. The baud rate of 115k cannot be ensured across all clock, voltage, and temperature variations.

Table 5-25.

Devices	MSP430F6779A, MSP430F6778A, MSP430F6777A, MSP430F6776A, MSP430F6775A, MSP430F6769A, MSP430F6768A, MSP430F6767A, MSP430F6766A, MSP430F6765A, MSP430F6749A, MSP430F6748A, MSP430F6747A, MSP430F6746A, MSP430F6745A, MSP430F6779A, MSP430F6778A, MSP430F6777A, MSP430F6776A, MSP430F6775A, MSP430F6769A, MSP430F6768A, MSP430F6767A, MSP430F6766A, MSP430F6765A, MSP430F6749A, MSP430F6748A, MSP430F6747A, MSP430F6746A, MSP430F6745A, MSP430F6779A, MSP430F6778A, MSP430F6777A, MSP430F6776A, MSP430F6775A, MSP430F6769A, MSP430F6768A, MSP430F6767A, MSP430F6766A, MSP430F6765A, MSP430F6749A, MSP430F6748A, MSP430F6747A, MSP430F6746A, MSP430F6745A
BSL Version	00.07.05.04
RAM Erased	0x1C00 to 0x5BFF
Buffer Size for Core Commands	260 bytes
Notable Information	1. UART TX and RX BSL pins are noted in the device data sheet
Known Bugs	1. The baud rate of 115k cannot be ensured across all clock, voltage, and temperature variations.

Table 5-26.

Devices	MSP430F67641, MSP430F67621
BSL Version	00.07.05.04
RAM Erased	0x1C00 to 0x1FFF
Buffer Size for Core Commands	260 bytes
Notable Information	1. UART TX and RX BSL pins are noted in the device data sheet
Known Bugs	1. The baud rate of 115k cannot be ensured across all clock, voltage, and temperature variations.

Table 5-27.

Devices	MSP430FG6426, MSP430FG6425
BSL Version	00.08.08.04
RAM Erased	0x1C00 to 0x43FF
Buffer Size for Core Commands	260 bytes
Notable Information	1. UART TX and RX BSL pins are noted in the device data sheet
Known Bugs	1. The baud rate of 115k cannot be ensured across all clock, voltage, and temperature variations.

Table 5-28.

Devices	MSP430FG6626, MSP430FG6625
BSL Version	00.08.88.38
RAM Erased	0x1C00 to 0x43FF
Buffer Size for Core Commands	260 bytes
Notable Information	<ol style="list-style-type: none"> 1. Device is programmed with the factory USB BSL. 2. Factory USB BSL is RAM write only. Full BSL must first be loaded into device RAM and started to perform flash write. Only the commands RX PASSWORD, RX DATA BLOCK FAST, and SET PC are supported 3. When starting this BSL from an application, the application should first de-enumerate itself, then delay (approximately 500 ms) before starting the BSL. This allows proper re-enumeration with the host. 4. External crystal at XT2 is required to ensure USB operation.
Known Bugs	

6 Bootloader PCB Layout Suggestion

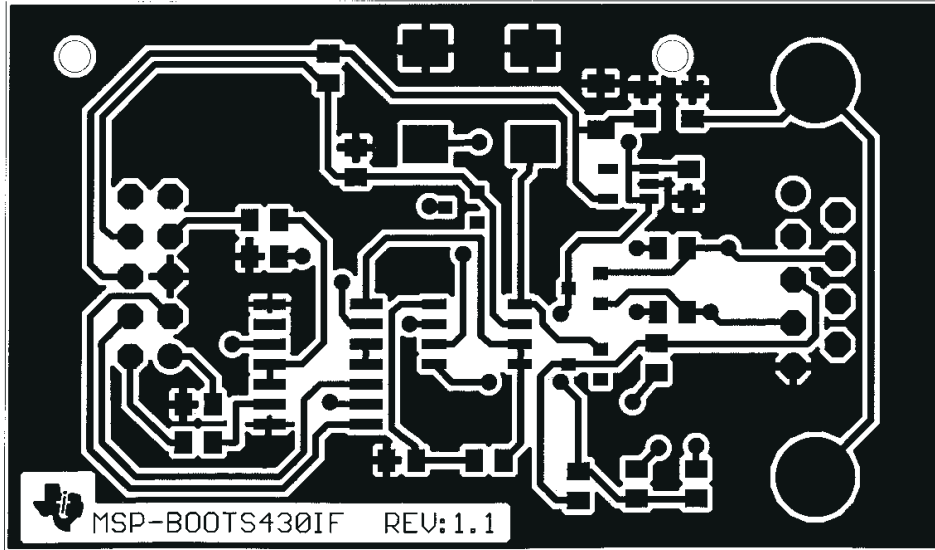

Figure 6-1. Universal BSL Interface PCB Layout, Top

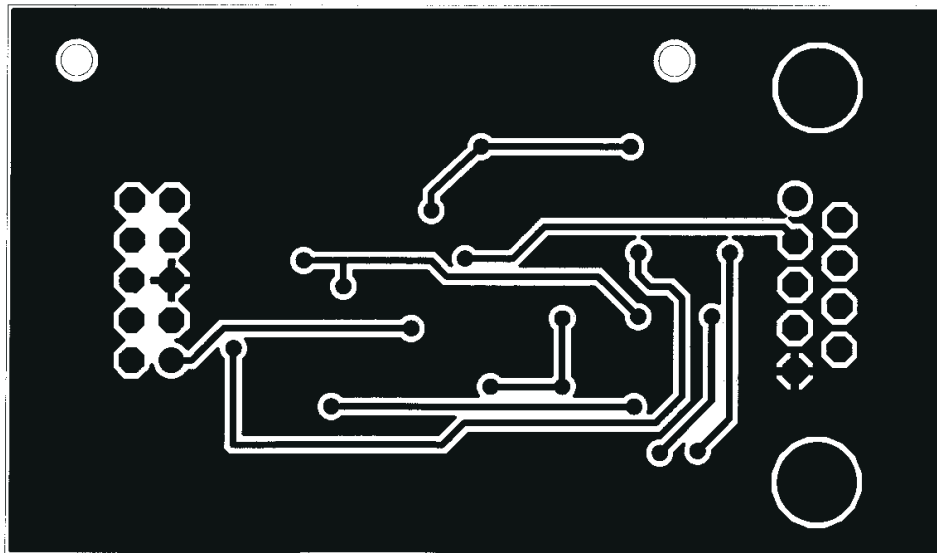

Figure 6-2. Universal BSL Interface PCB Layout, Bottom

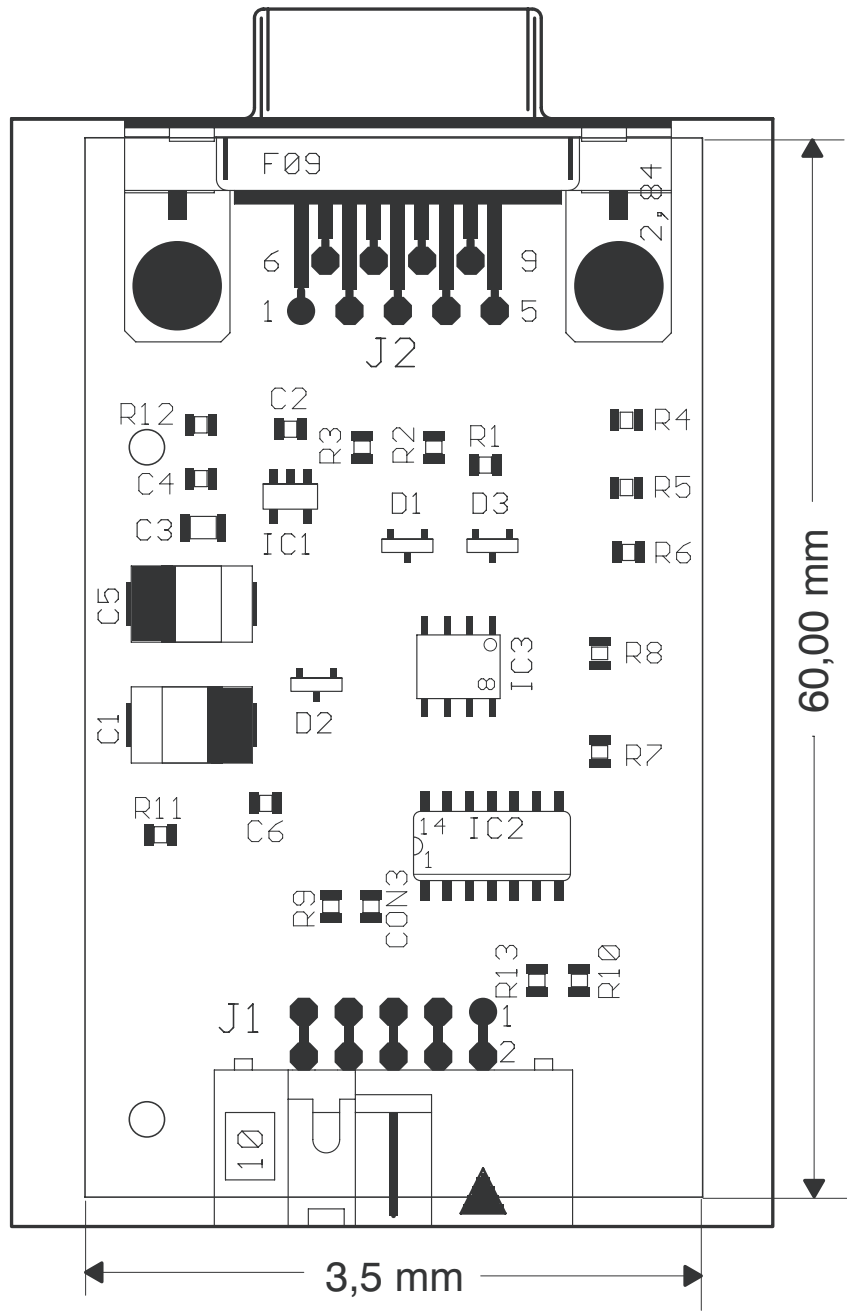

Figure 6-3. Universal BSL Interface Component Placement

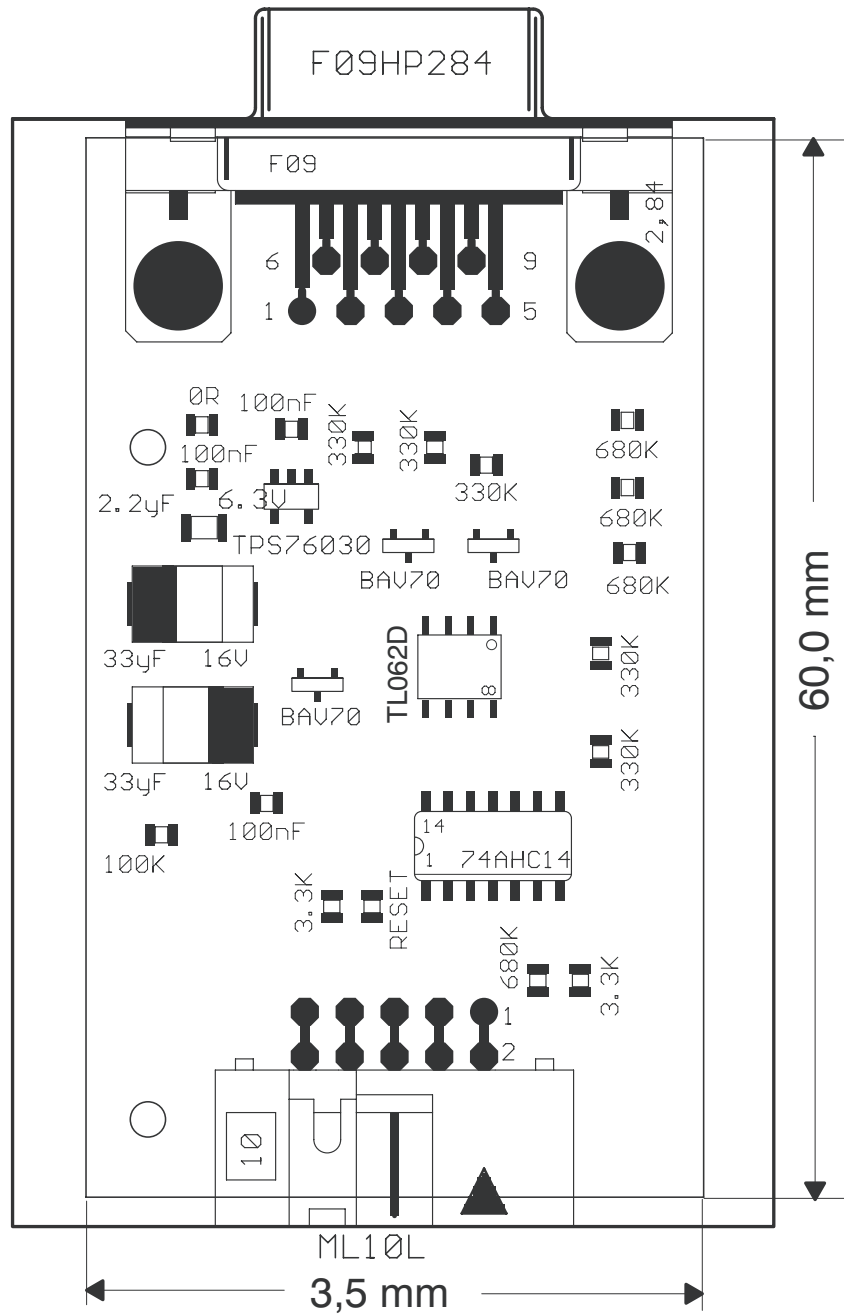

Figure 6-4. Universal BSL Interface Component Placement

7 Revision History

NOTE: Page numbers for previous revisions may differ from page numbers in the current version.

Changes from April 7, 2021 to September 22, 2022	Page
• Removed the MSP432P4xx column from Table 1-1 , <i>BSL Overview</i> (these devices are end of life).....	4

IMPORTANT NOTICE AND DISCLAIMER

TI PROVIDES TECHNICAL AND RELIABILITY DATA (INCLUDING DATA SHEETS), DESIGN RESOURCES (INCLUDING REFERENCE DESIGNS), APPLICATION OR OTHER DESIGN ADVICE, WEB TOOLS, SAFETY INFORMATION, AND OTHER RESOURCES "AS IS" AND WITH ALL FAULTS, AND DISCLAIMS ALL WARRANTIES, EXPRESS AND IMPLIED, INCLUDING WITHOUT LIMITATION ANY IMPLIED WARRANTIES OF MERCHANTABILITY, FITNESS FOR A PARTICULAR PURPOSE OR NON-INFRINGEMENT OF THIRD PARTY INTELLECTUAL PROPERTY RIGHTS.

These resources are intended for skilled developers designing with TI products. You are solely responsible for (1) selecting the appropriate TI products for your application, (2) designing, validating and testing your application, and (3) ensuring your application meets applicable standards, and any other safety, security, regulatory or other requirements.

These resources are subject to change without notice. TI grants you permission to use these resources only for development of an application that uses the TI products described in the resource. Other reproduction and display of these resources is prohibited. No license is granted to any other TI intellectual property right or to any third party intellectual property right. TI disclaims responsibility for, and you will fully indemnify TI and its representatives against, any claims, damages, costs, losses, and liabilities arising out of your use of these resources.

TI's products are provided subject to [TI's Terms of Sale](#) or other applicable terms available either on ti.com or provided in conjunction with such TI products. TI's provision of these resources does not expand or otherwise alter TI's applicable warranties or warranty disclaimers for TI products.

TI objects to and rejects any additional or different terms you may have proposed.

Mailing Address: Texas Instruments, Post Office Box 655303, Dallas, Texas 75265
Copyright © 2022, Texas Instruments Incorporated