

DLPC3430, DLPC3432, DLPC3433, DLPC3435 and DLPC3438 Software

Programmer's Guide



Literature Number: DLPU020C
July 2014–Revised May 2018

1	Trademarks	7
2	Introduction	7
	2.1 Software Programmer's Guide Overview	7
3	Interface Specification	8
	3.1 I ² C Interface and Ports for DLPC343x	8
4	System Initialization	8
	4.1 Boot ROM Concept	8
	4.2 Resident Boot Software	8
	4.3 HOST_IRQ Initialization Sequence	8
5	Software Interface	9
	5.1 I ² C Considerations	9
	Revision History	68

List of Figures

1	DLPC343x Embedded Configuration.....	7
2	HOST_IRQ Timing Diagram.....	9
3	Write Parameters.....	11
4	Return Parameters.....	15
5	Byte 1 Write Parameter.....	17
6	Byte 2 Write Parameter.....	17
7	Example of Solid Field Test Pattern (Red).....	19
8	Example of Fixed Step Horizontal Ramp Test Pattern.....	20
9	Example of Fixed Step Vertical Ramp Test Pattern.....	20
10	Example of Horizontal Lines Test Pattern.....	21
11	Example of Vertical Lines Test Pattern.....	21
12	Example of Diagonal Lines Test Pattern.....	22
13	Example of Grid Lines Test Pattern.....	23
14	Example of Checkerboard Test Pattern.....	23
15	Example of Color Bars Test Pattern.....	24
16	Return Parameters.....	24
17	Cropping Rules when Crop Size exceeds Input Size.....	28
18	Write Parameters.....	30
19	Rotation and Non-Rotation of Portrait Source.....	31
20	Long-Axis Flip.....	31
21	Short-Axis Flip.....	31
22	Return Parameters.....	32
23	Write Parameters.....	32
24	Return Parameters.....	33
25	Write Parameters.....	34
26	Return Parameters.....	35
27	Write Parameters.....	36
28	Byte 1 Return Parameters.....	37
29	Byte 2 Return Parameters.....	37
30	Bit Weight and Bit Order for Duty Cycle Data.....	38
31	Maximum Number of Sequence Vectors.....	38
32	Return Parameters.....	39
33	Write Parameters.....	42
34	Return Parameters.....	43
35	Write Parameters.....	43
36	Return Parameters.....	44
37	Byte 1 Return Parameters.....	48
38	Return Parameters.....	49
39	Byte 1 Return Parameters.....	49
40	Bit Weight Definition for LABB Gain Value.....	49
41	Byte 1 Write Parameters.....	50
42	Bit Weight Definition for the CAIC Maximum Gain Value.....	50
43	Bit Weight Definition for the CAIC Clipping Threshold Value.....	50
44	Bit Weight Definition for the CAIC RGB Intensity Gain Values.....	51
45	Byte 1 Return Parameters.....	52
46	Write Parameters.....	52
47	Return Parameters.....	53

48	Byte 1 Write Parameters	53
49	Bit Weight Definition for the Optical Throw Ratio Data	54
50	Visual Definition and Calculation for Optical Throw Ratio Data	54
51	Bit Weight Definition for the Optical DMD Offset Data	54
52	Method for Calculation for Optical DMD Offset Data	55
53	Sign Determination for Optical DMD Offset Data	55
54	Examples of Non-Inverted and Inverted Projector Orientations	56
55	Byte 1 Return Parameters	57
56	Write Parameters	57
57	Pillar-Box Border Example	58
58	Return Parameters	58
59	Bit Weight Definition for the Projection Pitch Angle Data	59
60	Examples of Projection Pitch Angle	60
61	Byte 1 Return Parameters	61
62	Byte 1 Return Parameters	62
63	Byte 2 Return Parameters	62
64	Byte 3 Return Parameters	63
65	Byte 4 Return Parameters	63
66	Byte 1 Read Parameters	64
67	Byte 5 Return Parameters	65
68	Byte 6 Return Parameters	66
69	Return Parameters	66
70	Read Parameters	67

List of Tables

1	I ² C Write and Read Transactions	9
2	Supported TI Generic Commands	10
3	Source Specific Associated Commands	13
4	Common Commands	14
5	Write Parameters	15
6	Return Parameters	16
7	Write Parameters	16
8	Foreground and Background Color Use	18
9	Descriptions and Bit Assignments for Parameters 1-4	18
10	Number of Bytes Required based on Pattern Selection	19
11	Parameter Bytes	24
12	Write Parameters	25
13	Return Parameters	26
14	Read Parameters	26
15	Return Parameters	26
16	Splash Screen Header Definitions	27
17	Write Parameters	27
18	Scaling Limits	28
19	Return Parameters	28
20	Write Parameters	29
21	Return Parameters	30
22	Partial List of Commands that May Benefit from the Use of Image Freeze	34
23	Splash Screen Example Using Image Freeze	35
24	Test Pattern Generator Example Using Image Freeze	35
25	Return Parameters	36
26	Return Parameters	37
27	Write Parameters	39
28	Write Parameters	40
29	Input Source Limits for Active Data	40
30	Return Parameters	41
31	Available Commands Based on LED Control Method	42
32	Write Parameters	44
33	Return Parameters	45
34	Return Parameters	45
35	Write Parameters	46
36	Return Parameters	46
37	Return Parameters	47
38	Write Parameters	48
39	Write Parameters	49
40	LABB and CAIC Modes	51
41	Return Parameters	51
42	Write Parameters	53
43	Return Parameters	56
44	Write Parameters	59
45	Return Parameters	60
46	Return Parameters	61
47	Return Parameters	62

48	Return Parameters	64
49	Read Parameters.....	64
50	Return Parameters	65
51	Controller Device ID Decode	66
52	DMD Device ID Reference Table	67
53	Return Parameters	67

DLPC3430, DLPC3432, DLPC3435, DLPC3433, and DLPC3438 Software Programmer's Guide

1 Trademarks

LightCrafter is a trademark of Texas Instruments.

2 Introduction

2.1 Software Programmer's Guide Overview

This guide details the software interface requirements for a DLPC343x ASIC-based system. It defines all applicable communication protocols including I²C initialization, default settings and timing. The DLPC343x system can be used in [Figure 1](#).

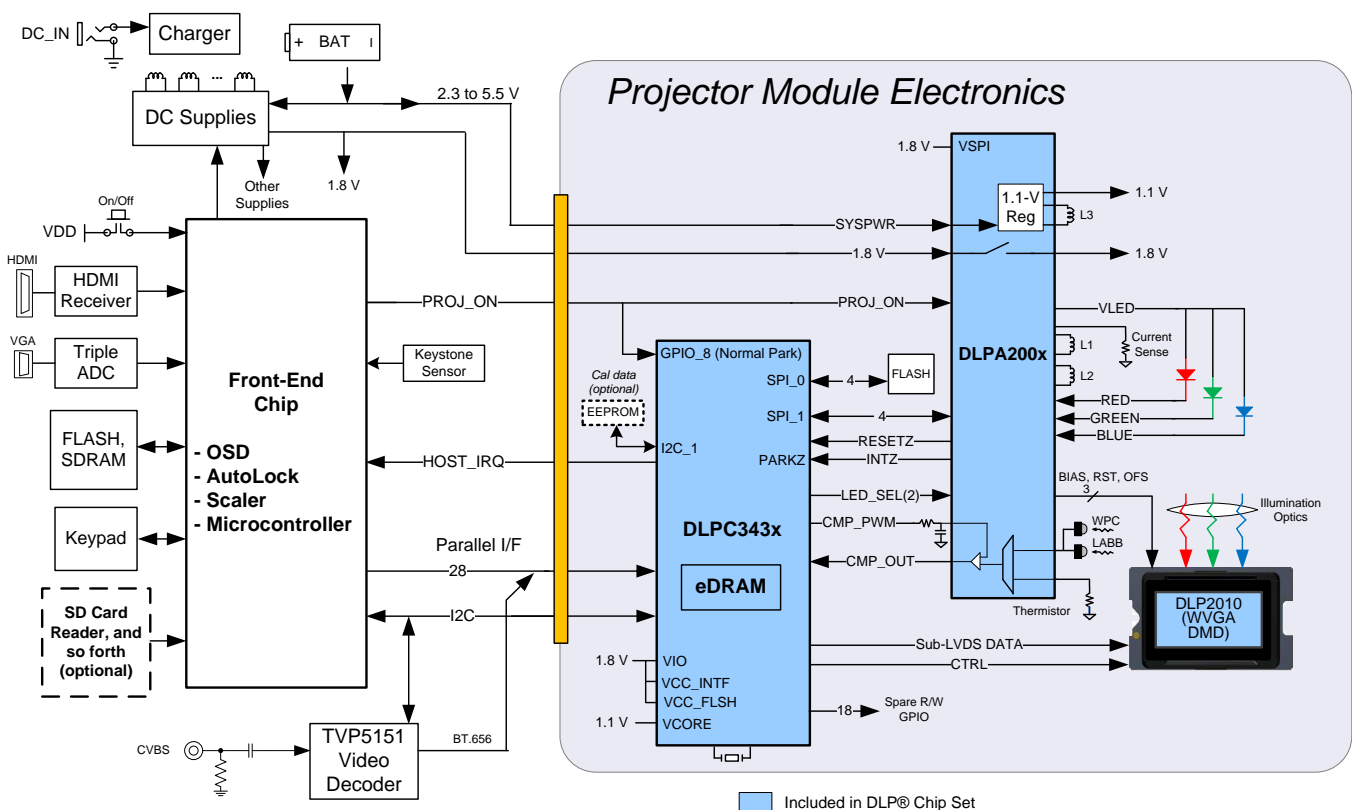

Figure 1. DLPC343x Embedded Configuration

2.1.1 I²C-Based Command Data Interface

The legacy interface configurations make use of an I²C interface for commands and a 24-bit parallel interface.

3 Interface Specification

The protocol used in communicating information to DLPC343x consist of a serial data bus conforming to the Philips I²C specification, up to 100 kHz. MIPI DSI is supported in DLPC343x, but this feature is not supported in LightCrafter™ Display EVM.

3.1 I²C Interface and Ports for DLPC343x

DLPC343x commands are executed using I²C and support two I²C ports, port-0 and port-1.

Port-0 is primarily used for command and control interface. While using this port, DLPC343x behaves as an I²C slave.

4 System Initialization

This section describes the methodology used for system initialization.

4.1 Boot ROM Concept

The DLPC343x employs a boot ROM and associated boot software. This resident boot code consists of the minimum code necessary to complete the program loading. For most DLPC343x product configurations, an external flash device can store the main application code, along with the other configuration and operational data required by the system for normal operation.

4.2 Resident Boot Software

The resident boot code consists of the minimum code necessary to load the ARM software from flash to internal RAM for execution.

4.3 HOST_IRQ Initialization Sequence

HOST_IRQ is a signal indicating the status of DLPC343x initialization. While reset is applied, HOST_IRQ resets to tri-state (an external pullup pulls the line high). HOST_IRQ remains tri-state (pulled high externally) until the microprocessor boot completes. While the signal is pulled high, the controller performs boot-up and auto-initialization.

Immediately after boot-up, the microprocessor drives HOST_IRQ to a logic high state to indicate that the controller is performing auto-initialization (no real state change occurs on the external signal). Upon completion of auto-initialization, ARM software sets HOST_IRQ to a logic low state to indicate the completion of auto-initialization. At the falling edge, the system is said to enter the INIT_DONE state.

After auto-initialization completes, HOST_IRQ generates a logic high interrupt pulse to the host through software control; this interrupt indicates that the controller detects an error condition or requires service.

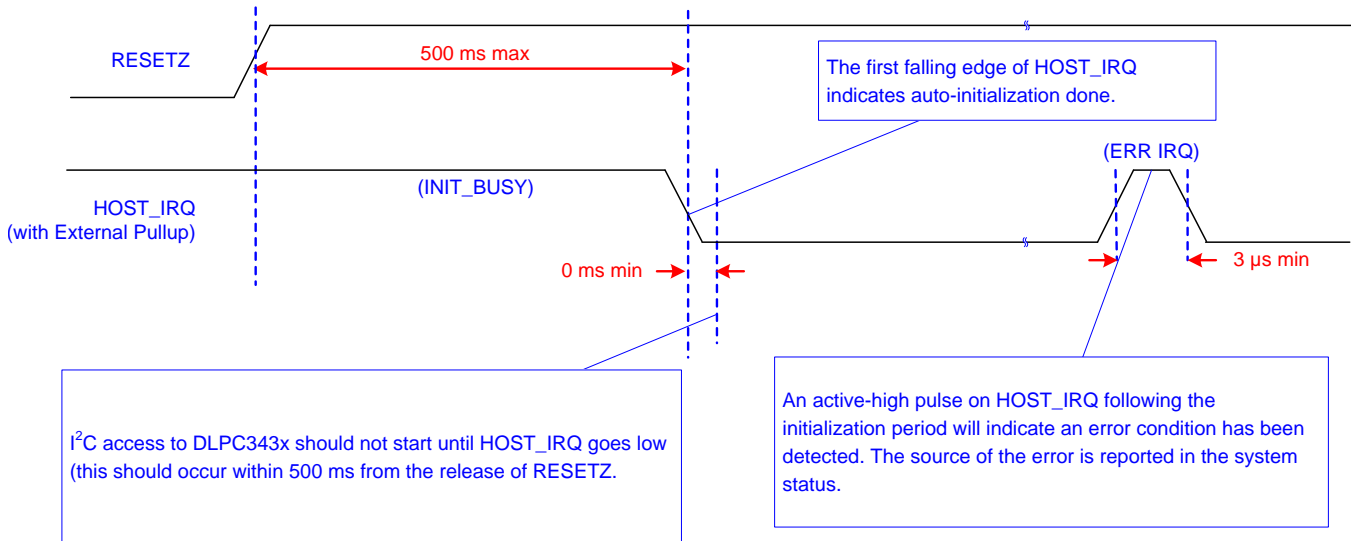

Figure 2. HOST_IRQ Timing Diagram

5 Software Interface

There is generally one set of software commands supported by the DLPC343x controller.

5.1 I²C Considerations

5.1.1 I²C Transactions

Since all I²C commands are processed by software, only one type of I²C transaction is supported. This transaction type is shown in Table 1 for both writes and reads. The I²C interface supports variably-sized transactions for example, a one byte transaction, a nine byte transaction) to match the TI commands discussed later in this document.

Table 1. I²C Write and Read Transactions

Transaction	Address ⁽¹⁾	Sub-Address ⁽²⁾	Remaining Data Bytes ⁽³⁾
Write	8-bits	8-bits	8-bit parameter bytes (0 → N)
	36h (or 3Ah)	Command value	Parameter values
Read Request	8-bits	8-bits	8-bit parameter bytes (0 → N)
	36h (or 3Ah)	Command value	Parameter values
Read Response	8-bits		8-bit parameter bytes (0 → N)
	37h (or 3Bh)		Parameter values

⁽¹⁾ The address corresponds to the chip address of the controller.

⁽²⁾ The subaddress will correspond to a TI command.

⁽³⁾ The data (if present) will correspond to any required command parameters.

5.1.1.1 Data Flow Control

While the I²C interface inherently supports flow control by holding the clock, this is not sufficient for all transactions (for example, sequence and CMT updates). In this case, the host software should use the Read Short status to determine if the system is busy.

5.1.2 List of System Write/Read Software Commands

The commands supported by the I²C interfaces are discussed in the following sections.

Table 2. Supported TI Generic Commands

Command Type	Command Description	Reset Value	OpCode (hex)	Default Action	Section
General Operation					
Write	Write Input Source Select	1	05	Test pattern	Section 5.1.3.1
Read	Read Input Source Select		06		Section 5.1.3.2
Write	Write External Video Source Format Select	43h	07	RGB888	Section 5.1.3.3
Write	Write Test Pattern Select	7000h	0B	White solid field	Section 5.1.3.5
Read	Read Test Pattern Select		0C		Section 5.1.3.6
Write	Write Splash Screen Select		0D	User-specified	Section 5.1.3.7
Read	Read Splash Screen Select		0E		Section 5.1.3.8
Read	Read Splash Screen Header		0F		Section 5.1.3.9
Write	Write Image Crop	ffffff000000 00h	10	No crop	Section 5.1.3.10
Read	Read Image Crop		11		Section 5.1.3.11
Write	Write Display Size	DMD Res	12		Section 5.1.3.12
Read	Read Display Size		13		Section 5.1.3.13
Write	Write Display Image Orientation		14	User-specified	Section 5.1.3.14
Read	Read Display Image Orientation		15		Section 5.1.3.15
Write	Write Display Image Curtain	1	16	Black	Section 5.1.3.16
Read	Read Display Image Curtain		17		Section 5.1.3.17
Write	Write Image Freeze	0	1A	No freeze	Section 5.1.3.18
Read	Read Image Freeze		1B		Section 5.1.3.19
Write	Write LOOK Select		22	User-specified	Section 5.1.3.20
Read	Read LOOK Select		23		Section 5.1.3.21
Read	Read Sequence Header Attributes		26		Section 5.1.3.22
Read	Read DMD Sequencer Sync Mode		2C		Section 5.1.3.23
Write	Write Execute Batch File	0	2D		Section 5.1.3.24
Write	Write External Input Image Size	DMD Res	2E		Section 5.1.3.25
Read	Read External Input Image Size		2F		Section 5.1.3.26
Write	Write Splash Screen Execute		35		Section 5.1.3.27
Illumination Control					
Write	Write LED Output Control Method		50	User-specified	Section 5.1.3.28
Read	Read LED Output Control Method		51		Section 5.1.3.29
Write	Write RGB LED Enable	7h	52	Enabled	Section 5.1.3.30
Read	Read RGB LED Enable		53		Section 5.1.3.31
Write	Write RGB LED Current		54	User-specified	Section 5.1.3.32
Read	Read RGB LED Current		55		Section 5.1.3.33
Read	Read CAIC LED Max Available Power		57		Section 5.1.3.34
Write	Write RGB LED Max Current		5C	User-specified	Section 5.1.3.35
Read	Read RGB LED Max Current		5D		Section 5.1.3.36
Read	Read CAIC RGB LED Current		5F		Section 5.1.3.37
Image Processing Control					
Write	Write Local Area Brightness Boost Control	1	80	Manual strength control	Section 5.1.3.38
Read	Read Local Area Brightness Boost Control		81		Section 5.1.3.39

Table 2. Supported TI Generic Commands (continued)

Command Type	Command Description	Reset Value	OpCode (hex)	Default Action	Section
Write	Write CAIC Image Processing Control		84	User-specified	Section 5.1.3.40
Read	Read CAIC Image Processing Control		85		Section 5.1.3.41
Write	Write CCA Control	1	86	Enabled	Section 5.1.3.42
Read	Read CCA Control		87		Section 5.1.3.43
Write	Write Keystone Correction Control	0	88	Disabled	Section 5.1.3.44
Read	Read Keystone Correction Control		89		Section 5.1.3.45
General Setup					
Write	Write Border Color	0	B2	Black	Section 5.1.3.46
Read	Read Border Color		B3		Section 5.1.3.47
Write	Write Keystone Projection Pitch Angle	0	BB	0 Pitch angle	Section 5.1.3.48
Read	Read Keystone Projection Pitch Angle		BC		Section 5.1.3.49
Administrative Commands					
Read	Read Short Status		D0		Section 5.1.3.50
Read	Read System Status		D1		Section 5.1.3.51
Read	Read System Software Version		D2		Section 5.1.3.52
Read	Read Communication Status		D3		Section 5.1.3.53
Read	Read Controller Device ID		D4		Section 5.1.3.54
Read	Read DMD Device ID		D5		Section 5.1.3.55
Read	Read Flash Build Version		D9		Section 5.1.3.56

5.1.3 System Write/Read Commands

5.1.3.1 Write Input Source Select (05h)

5.1.3.1.1 Write

This command selects the image input source for the display module.

5.1.3.1.2 Write Parameters

Figure 3 describes the command parameters.

Figure 3. Write Parameters

MSB	Byte 1						LSB
b7	b6	b5	b4	b3	b2	b1	b0

- b(7:2) Reserved
- b(1:0) Input Source:
- 0h: External Video Port
 - 1h: Test Pattern Generator
 - 2h: Splash Screen
 - 3h: Reserved

Default: 01h

NOTE: When selecting the external video port, there is a set of associated commands applicable only to this source selection. These associated commands are the *Write External Input image Size* and the *Write External Video Source Format Select*.

When selecting the test pattern generator, only one associated command is applicable to this source selection. This associated command is the *Write Test Pattern Select* command.

When selecting the splash screen, only two associated commands are applicable to this source selection. These associated commands are the *Write Splash Screen Select* and *Write splash Screen Execute* commands.

These associations are also shown in [Table 3](#).

Table 3. Source Specific Associated Commands

Source Specific Associated Commands	Input Source Select Options		
	External Video Port	Test Pattern Generator	Splash Screen ⁽¹⁾
Write External Video Source Format Select	Only	N/A	N/A
Write External Input Image Size	Only	N/A	N/A
Write Test Pattern Select	N/A	Only	N/A
Write Splash Screen Select	N/A	N/A	Only
Write Splash Screen Execute	N/A	N/A	Special

⁽¹⁾ The *Write Splash Screen Execute* command is special in that there is no maintained state or history. Thus this command has no settings to be stored and reused by the system.

These commands (other than *Write Splash Screen Execute*) describe the characteristics of their associated source, and once these settings are defined the system stores them. Afterwards, each time an input source selection is made (using the *Write Input Source Select* command), the system remembers the settings described by the commands associated with the selected source, and automatically applies them. The user only needs to send these associated commands when the source is first defined, or when the source characteristics for that port must be changed. The appropriate associated commands must be updated when source characteristics change.

The user can send source-associated commands every time they make an input source selection. The source associated commands should be sent prior to sending the *Write Input Source Select* command. When source-associated commands are sent when that source is not active, the controller software saves the new settings, but does not execute these commands. When that source becomes active (via the *Write Input Source Select* command), the controller applies these new settings, as in the following example:

- The user sends the following commands (active input source = test pattern generator):
 - *Write image Freeze* = freeze
 - *Write External Video Source Format Select* (settings stored, command not executed)
 - *Write External Input Image Size* (settings stored, command not executed)
 - *Write Input Source Select* = external port (see step 2 below)
 - *Write Image Freeze* = unfreeze
- When the *Write Input Source Select* command is received, the software applies the settings from these external video port-associated commands:
 - *External Video Source Format Select*
 - *External input Image Size*

If source-associated commands are sent for a source that is already active, the controller software executes these commands when received, as in the following example:

- The user sends the following commands (active input source = external video port):
 - *Write Image Freeze* = freeze
 - *Write external Video Source Format Select* (command executed)
 - *Write Image Freeze* = unfreeze

The rest of the commands that apply to image setup have settings applicable across all source selections, and typically remain the same across the three input source selections. A few examples are *Write Display Size* and *Write Display Image Orientation*. A representative list of these commands is shown in [Table 4](#).

Table 4. Common Commands

Common Commands	Input Source Select Options		
	External Video Port	Test Pattern Generator	Splash Screen
Write Image Crop	Common	Common	Common
Write Display Image Size	Common	Common	Common
Write Keystone Correction Control	Common	Common	Common
Write Display Image Orientation	Common	Common	Common
Write Display Image Curtain	Common	Common	Common
Write Look Select	Common	Common	Common
Write Local Area Brightness Boost Control	Common	Common	Common
Write CAIC Image Processing Control	Common	Common	Common

While the values for these commands may be the same across the different input source types, the hardware settings may change (for example: display image size = 1080p = DMD size – the external port input source size is WXGA, which is scaled up to the display size of 1080p. If the user changes to the TPG Input Source, the size of the test pattern must match the size of the DMD. Therefore, the scaler settings must to be changed). The controller software manages the underlying hardware settings. This also applies to those commands which specify automatic operation. While the automatic setting remains the same, the underlying algorithm might change its settings based on the characteristic of the selected source.

NOTE: The user is required to specify the active data size for all external input sources, using the *Write Input Image Size* command.

NOTE: When a test pattern is selected, it is generated at the resolution of the DMD, modified by the settings specified by the *Write Image Crop* command, and displayed at the resolution specified by the *Write Display Size* command.

NOTE: The user should see the *Write Image Freeze* command for information on hiding on-screen artifacts when selecting an input source.

5.1.3.2 Read Input Source Select (06h)

5.1.3.2.1 Read

This command reads the state of the image input source for the display module.

5.1.3.2.2 Read Parameters

This command has no command parameters.

5.1.3.2.3 Return Parameters

[Figure 4](#) describes the return parameters.

Figure 4. Return Parameters

MSB	Byte 1						LSB
b7	b6	b5	b4	b3	b2	b1	b0

- b(7:2) Reserved
- b(1:0) Input source
- 0h: External video port
 - 1h: Test Pattern generator
 - 2h: Splash screen
 - 3h: Reserved

5.1.3.3 Write External Video Source Format Select (07h)

5.1.3.3.1 Write

This command specifies the active external video port and the source data type for the display module.

5.1.3.3.2 Write Parameters

Table 5 describes the command parameters.

Table 5. Write Parameters

CMD Parameter	Port	Bits/Pixel	Data Type	Bus Width	Ckls/Pixel	Notes
40h	Parallel	16	RGB 565	16	1	Auto-select RGB CSC
41h	Parallel	18	RGB 666	18	1	Auto-select RGB CSC
42h	Parallel	24	RGB 888	8	3	Auto-select RGB CSC
43h	Parallel	24	RGB 888	24	1	Auto-select RGB CSC
50h	Parallel	18	YCbCr 666	18	1	Auto-select YCbCr CSC
51h	Parallel	24	YCbCr 888	24	1	Auto-select YCbCr CSC
60h	Parallel	16	YCbCr 4:2:2 88	8	2	Auto-select YCbCr CSC Auto-select 4:2:2 → 4:4:4
61h	Parallel	16	YCbCr 4:2:2 88	16	1	Auto-select YCbCr CSC Auto-select 4:2:2 → 4:4:4

Default: 43h

This command is used in conjunction with the *Write Input Source Select* command. This command specifies which input port displays when the *Write Input Source Select* command selects external video port as the image source. The settings for this command are retained until changed using this command. These settings are automatically applied each time the external video port is selected.

When the external video port is selected as the input source, the software automatically selects and loads the proper CSC, based on the selected parameter of this command (appropriate matrix for RGB, selected matrix for YCbCr including offset). The appropriate data path is also automatically selected for 4:2:2 versus 4:4:4 processing.

The selection of video source port is independent from the selected command port.

The user should review the notes for the *Write Input Source Select* command to understand the concept of source-associated commands. This concept determines when source-associated commands are executed by the system. This command is a source-associated command.

5.1.3.4 Read External Video Source Format Select (08h)

5.1.3.4.1 Read

This command reads the state of the active external video port and the source data type for the display module.

5.1.3.4.2 Read Parameters

This command has no read parameters.

5.1.3.4.3 Return Parameters

Table 6 describes the return parameters.

Table 6. Return Parameters

CMD Parameter	Port	Bits/Pixel	Data Type	Bus Width	Clks/Pixel	Notes
40h	Parallel	16	RGB 565	16	1	Auto-select RGB CSC
41h	Parallel	18	RGB 666	18	1	Auto-select RGB CSC
42h	Parallel	24	RGB 888	8	3	Auto-select RGB CSC
43h	Parallel	24	RGB 888	24	1	Auto-select RGB CSC
50h	Parallel	18	YCbCr 666	18	1	Auto-select YCbCr CSC
51h	Parallel	24	YCbCr 888	24	1	Auto-select YCbCr CSC
60h	Parallel	16	YCbCr 4:2:2 88	8	2	Auto-select YCbCr CSC Auto-select 4:2:2 → 4:4:4
61h	Parallel	16	YCbCr 4:2:2 88	16	1	Auto-select YCbCr CSC Auto-select 4:2:2 → 4:4:4

5.1.3.5 Write Test Pattern Select (0Bh)

5.1.3.5.1 Write

This command specifies an internal test pattern for display on the display module.

5.1.3.5.2 Write Parameters

Table 7 describes the command parameters.

Table 7. Write Parameters

Parameter Bytes	Description
Byte 1	TPG pattern select
Byte 2	Foreground and background color (see Table 8)
Byte 3	Parameter 1 (see Table 9)
Byte 4	Parameter 2 (see Table 9)
Byte 5	Parameter 3 (see Table 9)
Byte 6	Parameter 4 (see Table 9)

Figure 5. Byte 1 Write Parameter

MSB	Byte 1						LSB
b7	b6	b5	b4	b3	b2	b1	b0

- b(7) Test pattern border:
- 00h: Disabled
 - 01h: Enabled
- b(6:4) Reserved
- b(3:0) Left pattern select:
- 00h: Solid field
 - 01h: Fixed step horizontal ramp
 - 02h: Fixed step vertical ramp
 - 03h: Horizontal lines
 - 04h: Diagonal lines
 - 05h: Vertical lines
 - 06h: Horizontal and vertical grid
 - 07h: Checkerboard
 - 08h: Color bars
 - 09h-0Fh: Reserved

Byte 1 default: 00h

Figure 6. Byte 2 Write Parameter

MSB	Byte 2						LSB
b7	b6	b5	b4	b3	b2	b1	b0

- b(7) Reserved
- b(6:4) Foreground color:
- 0h: Black
 - 1h: Red
 - 2h: Green
 - 3h: Blue
 - 4h: Cyan
 - 5h: Magenta
 - 6h: Yellow
 - 7h: White
- b(3:0) Reserved
- b(2:0) Background color:
- 0h: Black
 - 1h: Red
 - 2h: Green
 - 3h: Blue
 - 4h: Cyan
 - 5h: Magenta
 - 6h: Yellow
 - 7h: White

Table 8. Foreground and Background Color Use

Pattern	Byte 2	
	Foreground Color	Background Color
Solid field	Yes	No
Fixed step horizontal ramp	Yes	No
Fixed step vertical ramp	Yes	No
Horizontal lines	Yes	Yes
Vertical lines	Yes	Yes
Diagonal lines	Yes	Yes
Grid lines	Yes	Yes
Checkerboard	Yes	Yes
Color bars	No	No

Byte 2 default: 70h

Table 9. Descriptions and Bit Assignments for Parameters 1-4

Pattern	Byte 6 (Parameter 4)		Byte 5 (Parameter 3)		Byte 4 (Parameter 2)		Byte 3 (Parameter 1)	
	Description	Bits	Description	Bits	Description	Bits	Description	Bits
Solid field	N/A		N/A		N/A		N/A	
Fixed step horizontal ramp	N/A		N/A		End value	8	Start value	8
Fixed step vertical ramp	N/A		N/A		End value	8	Start value	8
Horizontal lines	N/A		N/A		Background line width	8	Foreground line width	8
Vertical lines	N/A		N/A		Background line width	8	Foreground line width	8
Diagonal lines	N/A		N/A		Vertical spacing	8	Horizontal spacing	8
Grid lines	Vertical background line width	8	Vertical foreground line width	8	Horizontal background line width	8	Horizontal foreground line width	8
Checkerboard	Number of vertical checkers	3	Number of vertical checkers	8	Number of horizontal checkers	3	Number of horizontal checkers	8
Color bars	N/A		N/A		N/A		N/A	

This command is used in conjunction with the *Write Input Source Select* command. This command specifies which test pattern displays when the *Write Input Source Select* command selects test pattern generator as the image source. The settings for this command are retained until changed using this command. These settings automatically apply each time the test pattern generator is selected.

Batch files are created and stored in flash, and recall the settings for predefined test patterns.

Test patterns are created at the resolution of the display (DMD), are modified by the *Write Image Crop* command, and displayed at the resolution specified by the *Write Display Size* command.

Test patterns display at the default frame rate 60 Hz.

The *Test Pattern Border Selection* creates a white border, a single pixel wide and tall, around the specified test pattern.

The user must review the notes for the *Write Input Source Select* command to understand the concept of source-associated commands. This concept determines when source-associated commands are executed by the system. This command is a source-associated command.

When a foreground or background color is not used, the bit values are ignored (see [Table 8](#)). If both foreground and background color are not used, or when a parameter byte (bytes 3 thru 6) is not used, the byte should not be sent. [Table 10](#) shows the number of bytes required, based on the specified pattern.

Table 10. Number of Bytes Required based on Pattern Selection

Specified Pattern	Number of Bytes Required
Solid field	2
Fixed step horizontal ramp	4
Fixed step vertical ramp	4
Horizontal lines	4
Vertical lines	4
Diagonal lines	4
Grid lines	6
Checkerboard	7
Color bars	1

As noted in [Table 8](#), the color for the solid field pattern is specified using the foreground color. An example of a solid field pattern is shown in [Figure 7](#).

Figure 7. Example of Solid Field Test Pattern (Red)

As noted in [Table 8](#), the color for the fixed step horizontal ramp pattern is specified using the foreground color. As noted in [Table 9](#), the user specifies the start value and the stop value for the ramp. For this pattern, the system automatically determines the step size based on the start and stop values and the size of the display (DMD). The minimum start value is 0, the maximum stop value is 255, and the start value must always be smaller than the stop value. For example, if the start value = 0, the stop value = 255, and the DMD resolution is 1280 wide, the step size would be 5 ($1280 \text{ pixels} / 256 \text{ values} = 5$). Thus every gray shade value from 0 to 255 would have a step size of 5 pixels (such that each step would have 5 columns of pixels with the same gray scale value). The gray scale value always increments by 1 for each step between the start and stop values. An example of a fixed step horizontal ramp pattern is shown in [Figure 8](#).



Figure 8. Example of Fixed Step Horizontal Ramp Test Pattern

As noted in [Table 8](#), the color for the fixed step vertical ramp pattern is specified using the foreground color. As noted in [Table 9](#), the user specifies the start value and the stop value for the ramp. For this pattern, the system automatically determines the step size based on the start and stop values and the size of the display (DMD). The minimum start value = 0, the maximum stop value = 255, and the start value must always be smaller than the stop value. For example, if the start value = 0, the stop value = 255, and the DMD resolution is 768 tall, then the step size would be 3 (768 pixels / 256 values = 3). Thus every value from 0 to 255 would have a step size of 3 pixels (such that each step would have 3 rows of pixels with the same gray scale value). The gray scale value always increments by 1 for each step between the start and stop values. An example of a fixed step vertical ramp pattern is shown in [Figure 9](#).



Figure 9. Example of Fixed Step Vertical Ramp Test Pattern

As noted in [Table 8](#), the colors for the horizontal lines pattern are specified using both the foreground and background colors. The foreground color is used for the horizontal lines, and the background color is used for the space between the lines. As noted in [Table 9](#), the user specifies the foreground line width, as well as the background line width. The user must determine the line spacing for each resolution display. For example, if the foreground line width = 1, and the background line width = 9, there would be a single pixel horizontal line on every tenth line. An example of a horizontal lines pattern is shown in [Figure 10](#).

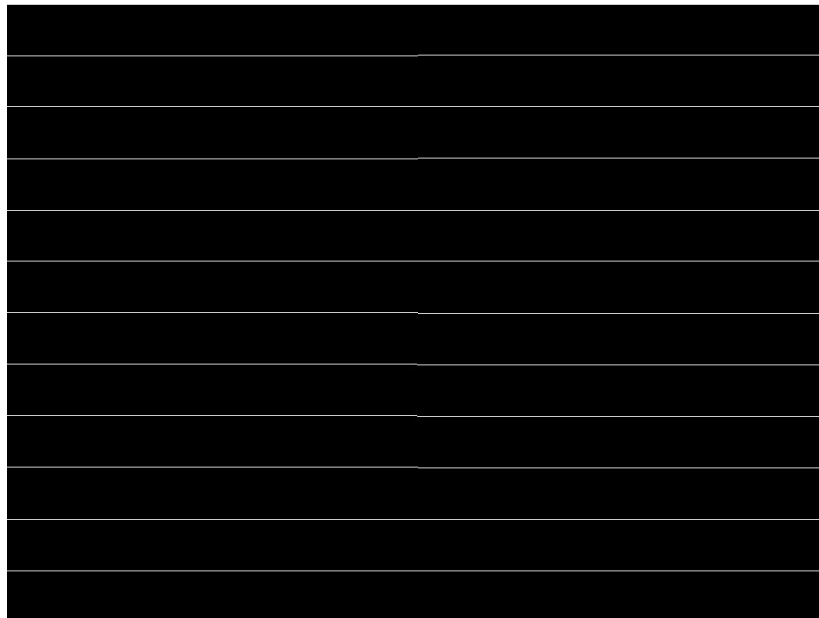

Figure 10. Example of Horizontal Lines Test Pattern

As noted in [Table 8](#), the colors for the vertical lines pattern are specified using both the foreground and background colors. The foreground color is used for the vertical lines, and the background color is used for the space between the lines. As noted in [Table 9](#), the user specifies the foreground line width, as well as the background line width. The user must determine the line spacing for each resolution display. For example, if the foreground line width = 1, and the background line width = 9, there would be a single pixel vertical line on every tenth line. An example of a vertical lines pattern is shown in [Figure 11](#).

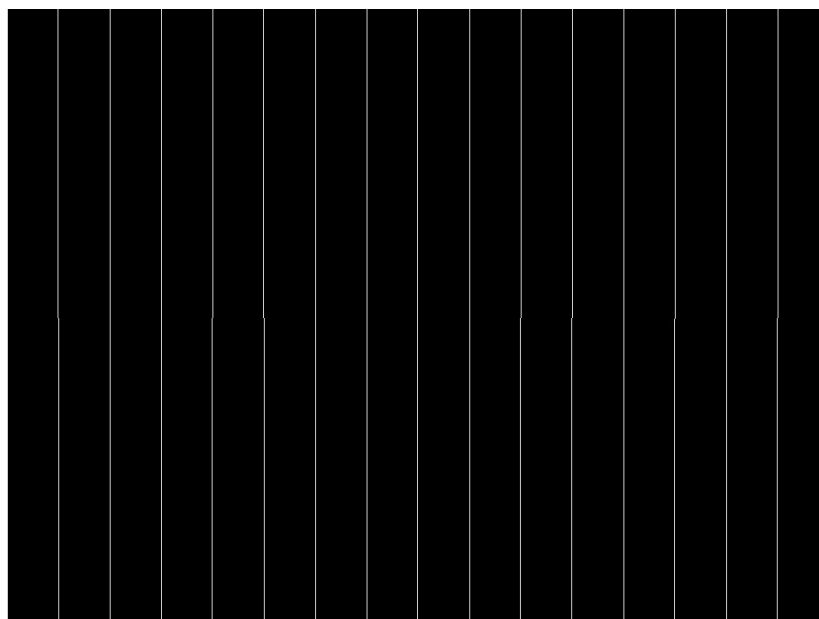

Figure 11. Example of Vertical Lines Test Pattern

As noted in [Table 8](#), the colors for the diagonal lines pattern are specified using both the foreground and background colors. The foreground color is used for the diagonal lines, and the background color is used for the space between the lines. As noted in [Table 9](#), the user specifies the horizontal and vertical line spacing. The line width is always one pixel. The user determines the line spacing for each resolution display. Both horizontal and vertical line spacing must use the same value, and are limited to values of 3, 7, 15, 31, 63, 127, and 255. Invalid values result in a communication error (invalid command parameter). An example of a diagonal lines pattern is shown in [Figure 12](#).

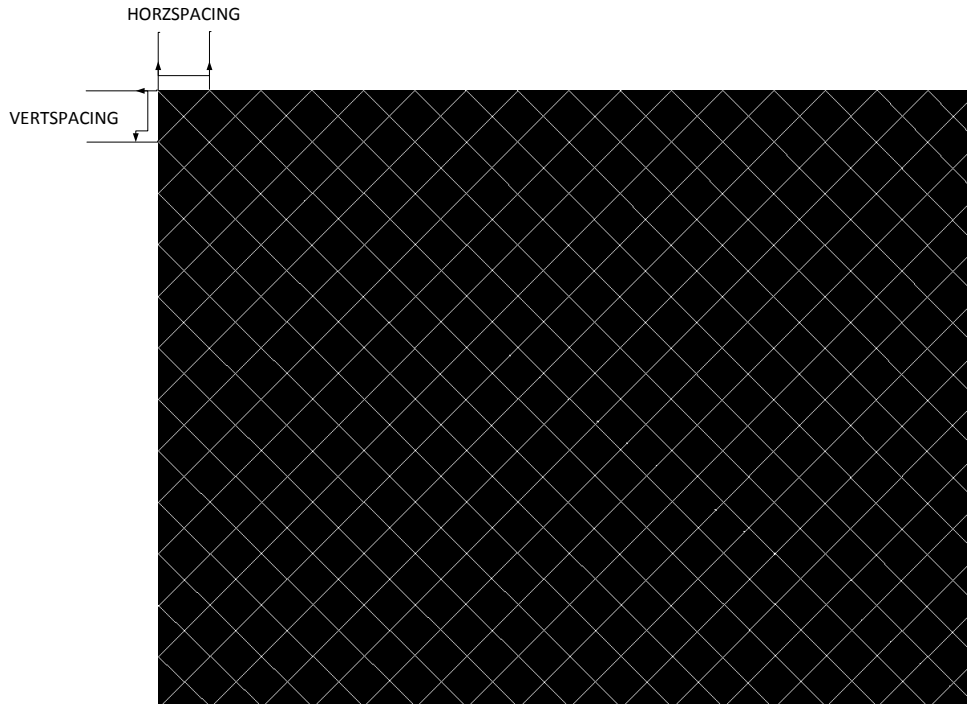

Figure 12. Example of Diagonal Lines Test Pattern

As noted in [Table 8](#), the colors for the grid lines pattern are specified using both the foreground and background colors. The foreground color is used for the grid lines, and the background color is used for the space between the lines. As noted in [Table 9](#), the user specifies the horizontal foreground and background line width, as well as the vertical foreground and background line width. The user determines the line spacing for each resolution display. For example, if the horizontal foreground line width = 1, and background line width = 9, there would be a single pixel horizontal line on every tenth line. If the vertical foreground line width = 1, and background line width = 9, there would be a single pixel vertical line on every tenth line. An example of a grid lines pattern is shown in [Figure 13](#).

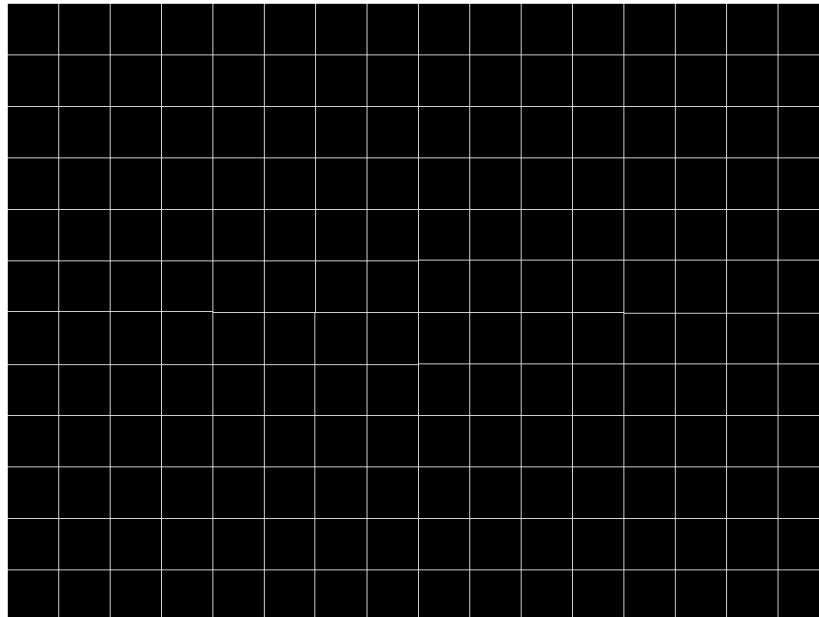

Figure 13. Example of Grid Lines Test Pattern

As noted in [Table 8](#), the colors for the checkerboard pattern are specified using both the foreground and background colors. The foreground color is used for one of the checkers, and the background color is used for the alternating checker. As noted in [Table 9](#), the user specifies the number of horizontal checkers and the number of vertical checkers. For this pattern, the system automatically determines the checker size in each direction based on the number of checkers and the size of the display (DMD). For example, if the number of horizontal checkers = 4, the number of vertical checkers = 4, and the DMD resolution is 1280x720, the size of the horizontal checkers is 320 pixels, and the size of the vertical checkers is 180 pixels (1280 pixels / 4 checkers = 320 pixels: 720 pixels / 4 checkers = 180 pixels). An example of a checkerboard pattern (16 checkers by 12 checkers) is shown in [Figure 14](#).

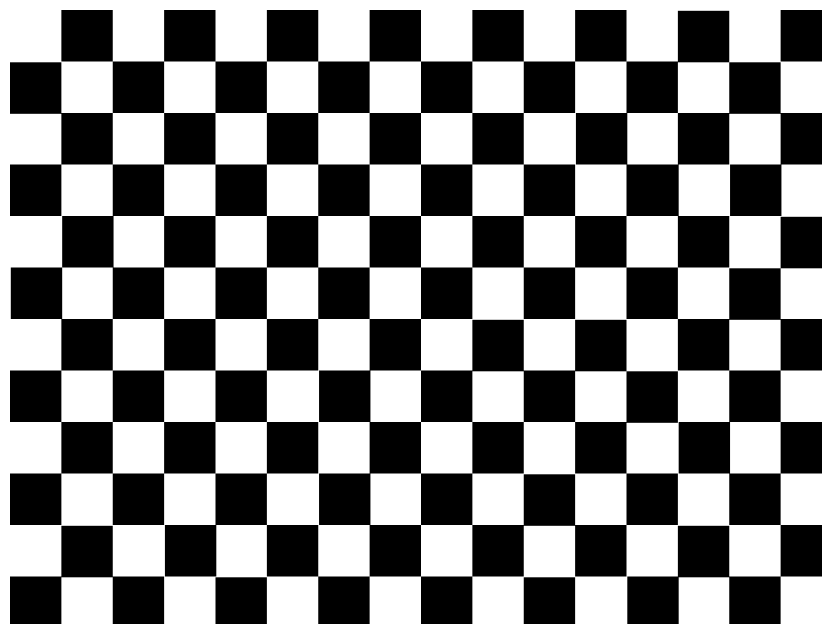

Figure 14. Example of Checkerboard Test Pattern

As noted in [Table 8](#) and [Table 9](#), there is no user programmability associated the color bars test pattern. This pattern is made up of eight vertical color bars: white, yellow, cyan, green, magenta, red, blue, and black. For this pattern, the system automatically determines the width for each color bar based on the size of the display (DMD). An example of the color bars pattern is shown in [Figure 15](#).

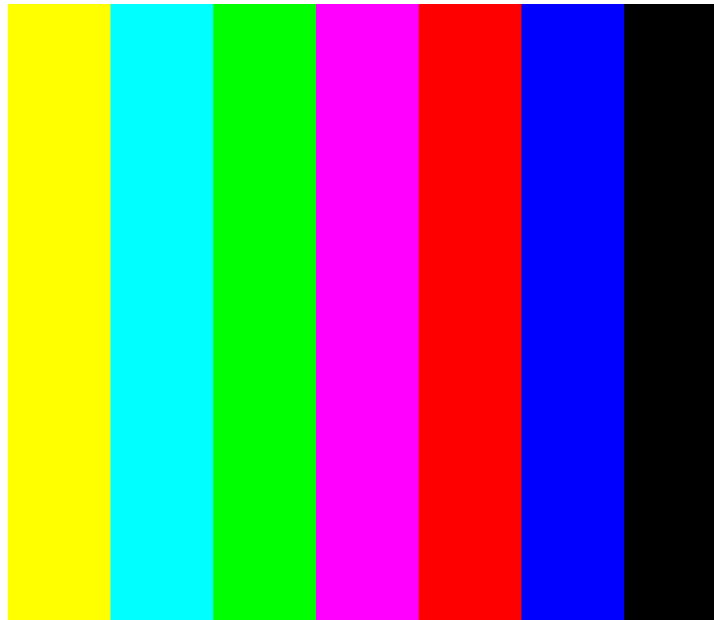

Figure 15. Example of Color Bars Test Pattern

5.1.3.6 Read Test Pattern Select (0Ch)

5.1.3.6.1 Read

This command reads the state of the test pattern select command for the display module.

5.1.3.6.2 Read Parameters

This command has no read parameters.

5.1.3.6.3 Return Parameters

[Figure 16](#) describes the return parameters.

Figure 16. Return Parameters

MSB	Byte 1						LSB
b7	b6	b5	b4	b3	b2	b1	b0

Table 11. Parameter Bytes

Parameter Bytes	Description
Byte 1	TPG pattern select
Byte 2	Foreground and background color (see Table 8)
Byte 3	Parameter 1 (see Table 9)
Byte 4	Parameter 2 (see Table 9)
Byte 5	Parameter 3 (see Table 9)
Byte 6	Parameter 4 (see Table 9)

This command always returns six bytes, since the host does not know how many bytes are valid until the pattern is selected. All unnecessary bytes (see [Table 10](#)) are set to 0.

If a batch file is used to specify the parameters of the test pattern generator, those parameters are returned by this command.

5.1.3.7 Write Splash Screen Select (0Dh)

5.1.3.7.1 Write

This command selects a stored splash screen to be displayed on the display module.

5.1.3.7.2 Write Parameters

[Table 12](#) describes the command parameters.

Table 12. Write Parameters

Parameter Bytes	Description
Byte 1	Splash screen reference number (integer)

Default: User defined

This command is used in conjunction with the *Write Input Source Select* and the *Write Splash Screen Execute* commands, and specifies which splash screen is selected by the *Input Source Select* command. The settings for this command are retained until changed using this command.

The steps required to display a splash screen are:

1. Select the desired splash screen (using this command)
2. Change the input source to splash screen (using *Write Input Source Select*)
3. Start the splash screen retrieval process (using *Write Splash Screen Execute*).

The splash screen is read from flash and sent down the processing path of the controller once, to be stored in memory for display at the end of the processing path. As such, all image processing settings (such as image crop, image orientation, display size, splash screen select, splash screen as input source, and so forth) should be set by the user before executing the *Write Splash Screen Execute* command.

The user should review the notes for the *Write Input Source Select* command to understand the concept of source-associated commands. This concept determines when source-associated commands are executed by the system. This command is a source-associated command.

The availability of the splash screen is limited by the available space in flash memory. All splash screens must be landscape oriented.

For single-controller applications which support DMD resolutions of up to 1280 x 720, the minimum splash image size allowed for flash storage is 427 x 240, with the maximum being the resolution of the product DMD. Typical splash image sizes for flash are 427 x 240 and 640 x 360. The full resolution size is typically used to support an optical test splash screen.

For dual-controller applications which support DMD resolutions up to 1980 x 1080, the minimum splash image size allowed for flash storage is 854 x 480, with the maximum being the resolution of the product DMD. Typical splash image sizes for flash are 854 x 480. The full resolution size is typically used to support an optical test splash screen.

The user must specify how the splash image is displayed on the screen. Key commands for this are *Write Image Crop* and *Write Display Size*.

When this command is received while splash screen is the active source, other than storing the specified splash screen value, the only action taken by the controller software is to obtain the header information from the selected splash screen and store this in internal memory. When the *Write Splash Screen Execute* command is received, the controller software uses this stored information to set up the processing path prior to pulling the splash data from flash.

5.1.3.8 Read Splash Screen Select (0Eh)

5.1.3.8.1 Read

This command reads the state of the *Splash Screen Select* command of the display module.

5.1.3.8.2 Read Parameters

This command has no command parameters.

5.1.3.8.3 Return Parameters

[Table 13](#) describes the return parameters.

Table 13. Return Parameters

Parameter Bytes	Description
Byte 1	Splash screen selected (integer)

5.1.3.9 Read Splash Screen Header (0Fh)

5.1.3.9.1 Read

This command reads the splash screen header information for the selected splash screen of the display module.

5.1.3.9.2 Read Parameters

The read parameter specifies the splash screen for which the header parameters are returned. If a splash screen value is provided for an unavailable splash screen, this is considered an error (invalid command parameter value – communication status) and the command is be executed.

Table 14. Read Parameters

Parameter Bytes	Description
Byte 1	Splash screen reference number (integer)

5.1.3.9.3 Return Parameters

[Table 15](#) describes the return parameters.

Table 15. Return Parameters

Parameter Bytes	Description
Byte 1	Splash image width in pixels (LSByte)
Byte 2	Splash image width in pixels (MSByte)
Byte 3	Splash image height in pixels (LSByte)
Byte 4	Splash image height in pixels (MSByte)
Byte 5	Splash image size in bytes (LSByte)
Byte 6	Splash image size in bytes
Byte 7	Splash image size in bytes
Byte 8	Splash image size in bytes (MSByte)
Byte 9	Pixel format
Byte 10	Compression type
Byte 11	Color order
Byte 12	Chroma order

Table 15. Return Parameters (continued)

Parameter Bytes	Description
Byte 13	Byte order

Parameter definitions are referenced in [Table 16](#).

Table 16. Splash Screen Header Definitions

Parameter	Values
Pixel format	0h = 24-bit RGB unpacked (not used) 1h = 24-bit RGB packed (not used) 2h = 16-bit RGB 5-6-5 3h = 16-bit YCbCr 4:2:2
Compression type	0h = Uncompressed 1h = RGB RLE compressed 2h = User-defined (not used) 3h = YUV RLE compressed
Color order	0h = 00RRGGBB 1h = 00GGRRBB
Chroma order	0h = Cr is first pixel 1h = Cb is first pixel
Byte order	0h = Little endian 1h = Big endian

5.1.3.10 Write Image Crop (10h)

5.1.3.10.1 Write

This command specifies which portion of the input image is captured and output from the cropping function of the display module.

5.1.3.10.2 Write Parameters

[Table 17](#) describes the command parameters.

Table 17. Write Parameters

Parameter Bytes	Description
Byte 1	Capture start pixel (LSByte)
Byte 2	Capture start pixel (MSByte)
Byte 3	Capture start line (LSByte)
Byte 4	Capture start line (MSByte)
Byte 5	Pixels per line (LSByte)
Byte 6	Pixels per line (MSByte)
Byte 7	Lines per frame (LSByte)
Byte 8	Lines per frame (MSByte)

Default: Bytes (8:1) = FFh FFh FFh FFh 00h 00h 00h 00h (no cropping)

The capture start parameters for this command are referenced to active data, and are 0-based (such that specifying the capture start pixel to be a value of zero indicates the first active pixel of a line). The pixel/line and lines/frame parameters are 1-based (such that specifying the pixels/line value to be a value of 640 indicates 640 pixels to be captured).

This command applies to all sources including test patterns, splash screens, and external sources. Making a change to the source or port does not impact the application of this command.

Cropping is done prior to the scaling function in the display module. As such, the size difference between the crop size and display size determines the amount of scaling needed in both dimensions. The scaling limits are listed in [Table 18](#).

Table 18. Scaling Limits

Controller Configuration	Maximum Horizontal Interpolation Scale Factor	Maximum Horizontal Decimation Scale Factor	Maximum Vertical Interpolation Scale Factor	Maximum Vertical Decimation Scale Factor
Single controller (excluding interlaced NTSC/PAL)	3.0	3.0	3.0	3.0
Single controller (interlaced NTSC/PAL only)	3.0	3.0	3.0	6.0
Dual controller	Scaling not supported except for splash screen.	Scaling not supported except for splash screen.	Scaling not supported except for splash screen.	Scaling not supported except for splash screen.

The scaling limits noted in [Table 18](#) may not be possible depending on other factors, such as keystone correction. In this case, the system does what is requested even if this results in a broken image. The OEM is responsible for providing the appropriate input settings to meet the display needs.

If a crop size parameter exceeds the size of the input image, the input image size minus the capture start pixel/line is be used (as shown in [Figure 17](#)). The crop size parameters returned by the read image crop command are always the values specified by the *Write Image Crop* command.

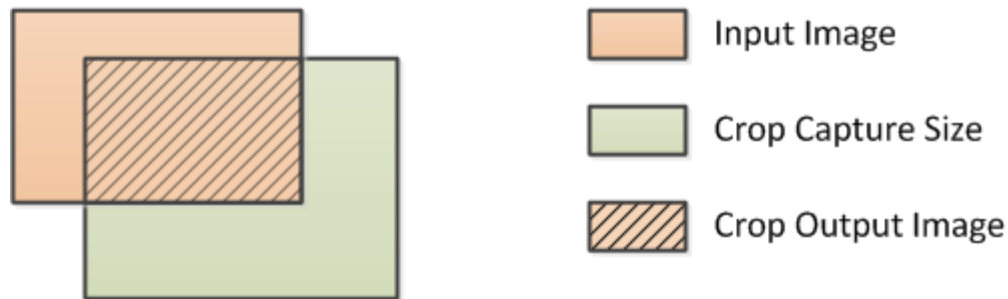

Figure 17. Cropping Rules when Crop Size exceeds Input Size

5.1.3.11 Read Image Crop (11h)

5.1.3.11.1 Read

This command reads the state of the image crop command for the display module.

5.1.3.11.2 Read Parameters

This command has no command parameters.

5.1.3.11.3 Return Parameters

[Table 19](#) describes the return parameters.

Table 19. Return Parameters

Parameter Bytes	Description
Byte 1	Capture start pixel (LSByte)
Byte 2	Capture start pixel (MSByte)

Table 19. Return Parameters (continued)

Parameter Bytes	Description
Byte 3	Capture start line (LSByte)
Byte 4	Capture start line (MSByte)
Byte 5	Pixels per line (LSByte)
Byte 6	Pixels per line (MSByte)
Byte 7	Lines per frame (LSByte)
Byte 8	Lines per frame (MSByte)

All parameters for this command are referenced to active data, and are 1-based. (such that specifying the capture start pixel to be a value of one indicates the first active pixel of a line).

5.1.3.12 Write Display Size (12h)

5.1.3.12.1 Write

This command specifies the size of the active image to be displayed on the display module.

5.1.3.12.2 Write Parameters

[Table 20](#) describes the command parameters.

Table 20. Write Parameters

Parameter Bytes	Description
Byte 1	Pixels per line (LSByte)
Byte 2	Pixels per line (MSByte)
Byte 3	Lines per frame (LSByte)
Byte 4	Lines per frame (MSByte)

Default: DMD resolution.

This command specifies the size of the non-keystone corrected image to be output from the scaler function, which is the size of the active displayed image.

The parameter values are to be 1-based. (such that a value of 1280 pixels displays 1280 pixels per line).

All sub-images (images smaller than the DMD display) are horizontally and vertically centered on the display (DMD).

If the display size exceeds the resolution of the DMD, this is considered an error (invalid command parameter value – communication status) and the command does not execute. The display size parameters are checked against the DMD resolution in both rotation image orientations (non-rotated and rotated), and if the DMD resolution is exceeded in both of these orientations, it is considered an error. The system does not check for proper image orientation setup.

DMD resolution = 854 × 480:

- Example 1: Display size parameter = 480 × 854 (not an error)
- Example 2: Display size parameter = 900 × 320 (error)
- Example 3: Display size parameter = 500 × 600 (error)

If the source, crop, and display parameter combinations exceed the capabilities of the scaler, the system implements the user request as best it can, and the displayed image may be broken. The user must provide updated parameters to fix the image.

5.1.3.13 Read Display Size (13h)

5.1.3.13.1 Read

This command reads the state of the display size command for the display module.

5.1.3.13.2 Read Parameters

This command has no read parameters.

5.1.3.13.3 Return Parameters

Table 21 describes the return parameters.

Table 21. Return Parameters

Parameter Bytes	Description
Byte 1	Pixels per line (LSByte)
Byte 2	Pixels per line (MSByte)
Byte 3	Lines per frame (LSByte)
Byte 4	Lines per frame (MSByte)

The parameter values are 1-based. (such that a value of 1280 pixels displays 1280 pixels per line).

5.1.3.14 Write Display Image Orientation (14h)

5.1.3.14.1 Write

This command specifies the image orientation of the displayed image for the display module.

5.1.3.14.2 Write Parameters

Figure 18 describes the command parameters.

Figure 18. Write Parameters

MSB	Byte 1						LSB
b7	b6	b5	b4	b3	b2	b1	b0

b(7:3)	Reserved
b(2)	Short axis image flip: <ul style="list-style-type: none"> • 0: Image not flipped. • 1: Image flipped.
b(1)	Long axis image flip: <ul style="list-style-type: none"> • 0: Image not flipped. • 1: Image flipped.
b(0)	Image rotation (for portrait source only): <ul style="list-style-type: none"> • 0: No rotation • 1: Minus 90° rotation

Default: User-defined

Figure 19 shows the result of non-rotation and rotation of a portrait source. If a portrait image is not rotated, it is centered and padded with black bars.

Portrait Source



Non-Rotated Display



-90° Rotated Display



Figure 19. Rotation and Non-Rotation of Portrait Source

Landscape images typically should not be rotated, but the system allows this as it may be appropriate for some situations or configurations. The user is responsible for determining if the result is acceptable.

Image rotation is allowed while keystone correction is enabled, though it may not be appropriate for all situations or configurations. The user is responsible for determining if the result is acceptable.



Figure 20. Long-Axis Flip

Figure 21 shows the short-axis flip.



Figure 21. Short-Axis Flip

5.1.3.15 Read Display Image Orientation (15h)

5.1.3.15.1 Read

This command reads the state of the displayed image orientation function for the display module.

5.1.3.15.2 Read Parameters

This command has no read parameters.

5.1.3.15.3 Return Parameters

Figure 22 describes the return parameters.

Figure 22. Return Parameters

MSB	Byte 1						LSB
b7	b6	b5	b4	b3	b2	b1	b0

- b(7:3) Reserved
- b(2) Short-axis image flip:
 - 0: Image not flipped.
 - 1: Image flipped.
- b(1) Long-axis image flip:
 - 0: Image not flipped.
 - 1: Image flipped.
- b(0) Image rotation (for portrait source only):
 - 0: No rotation
 - 1: Minus 90° rotation

5.1.3.16 Write Display Image Curtain (16h)

5.1.3.16.1 Write

This command controls the display image curtain for the display module.

5.1.3.16.2 Write Parameters

Figure 23 shows the command parameters.

Figure 23. Write Parameters

MSB	Byte 1						LSB
b7	b6	b5	b4	b3	b2	b1	b0

- b(7:4) Reserved
- b(3:1) Select curtain color:
 - 0h: Black
 - 1h: Red
 - 2h: Green
 - 3h: Blue
 - 4h: Cyan
 - 5h: Magenta
 - 6h: Yellow
 - 7h: White
- b(0) Curtain enable:
 - 0: Curtain disabled
 - 1: Curtain enabled

Default: 01h

The image curtain fills the entire display with a user-specified color. The curtain color specified by this command is separate from the border color defined in the *Write Border Color* command, though both are displayed using the curtain capability.

5.1.3.17 Read Display Image Curtain (17h)

5.1.3.17.1 Read

This command reads the state of the image curtain control function for the display module.

5.1.3.17.2 Read Parameters

This command has no read parameters.

5.1.3.17.3 Return Parameters

Figure 24 describes the return parameters.

Figure 24. Return Parameters

MSB	Byte 1						LSB
b7	b6	b5	b4	b3	b2	b1	b0

b(7:4)	Reserved
b(3:1)	Select curtain color: <ul style="list-style-type: none"> • 0h: Black • 1h: Red • 2h: Green • 3h: Blue • 4h: Cyan • 5h: Magenta • 6h: Yellow • 7h: White
b(0)	Curtain enable: <ul style="list-style-type: none"> • 0: Curtain disabled • 1: Curtain enabled

5.1.3.18 Write Image Freeze (1Ah)

5.1.3.18.1 Write

This command enables or disables the image freeze function for the display module.

5.1.3.18.2 Write Parameters

Figure 25 describes the command parameters.

Figure 25. Write Parameters

MSB	Byte 1						LSB
b7	b6	b5	b4	b3	b2	b1	b0

- b(7:1) Reserved
- b(0) Image freeze:
- 0: Image freeze disabled
 - 1: Image freeze enabled

Default: 00h

The image freeze capability has two main functions. The first function allows the user to freeze the current image on the screen. The second function allows the user (host system or OEM) to reduce or prevent system changes on the display as visual artifacts. In this second case, the image is frozen, system changes are made, and the image is unfrozen when complete. In all cases, when the image is unfrozen, the display shows the most resent input image. Input data between the freeze point and the unfreeze point is lost.

The controller software never automatically freezes or unfreezes the image. This applies when software is making updates to the system on its own volition, and for any operation commanded via the I²C interface. The controller software will not freeze or unfreeze the image for any reason except when explicitly commanded by the *Write Image Freeze* command.

The user must review the notes for the *Write Input Source Select* command to understand the concept of source-associated commands. This concept determines when source-associated commands are executed by the system.

If the OEM chooses not to make use of image freeze, they should change the source before changing the image parameters, to minimize transition artifacts.

5.1.3.18.3 Use of Image Freeze to Reduce On-Screen Artifacts

Commands that take a long time to process, require a lot a data to be loaded from flash, or change the frame timing of the system may create on-screen artifacts. The *Write Image Freeze* command can try and minimize, if not eliminate, these artifacts. The process is:

1. Send a *Write Image Freeze* command to enable freeze.
2. Send commands with the potential to create image artifacts.
3. Send a *Write Image Freeze* command to disable freeze.

Because commands to the controller process serially, no special timing or delay is required between these commands. The number of commands placed between the freeze and unfreeze should be small, as it is not desirable for the image to be frozen for a long period of time. A list of commands that may produce image artifacts is listed in [Table 22](#). This is not an all-inclusive list, and the user is responsible for determining the correct use of the image freeze command.

Table 22. Partial List of Commands that May Benefit from the Use of Image Freeze

Command	Command OpCode	Notes
Write Input Source Select	05h	
Write External Video Source Format Select	07h	If changed while this source is the active source
Write Test Pattern Select	0Bh	If changed while this source is the active source
Write Splash Screen Select	0Dh	If changed while this source is the active source
Write Look Select	22h	

[Table 23](#) and [Table 24](#) show a few examples of how to use the image freeze command.

Table 23. Splash Screen Example Using Image Freeze

Command	Notes
Write Display Image Curtain = enable	May want to apply curtain if already displaying an unwanted image (such as a broken source)
Write Image Freeze = freeze	
Write Image Crop, Write Display Size, Write Display Image Orientation	Potential data processing commands that may be required for proper display of splash image. These must be set prior to write splash screen execute command to affect the splash screen image.
Write Splash Screen Select Write Input Source Select = splash	These must be set prior to write splash screen execute
Write Splash Screen Execute	Retrieves the desired splash screen image for display
Write Image Freeze = unfreeze	

The new splash image displays when the *Write Splash Screen Execute* command executes, regardless of the state of the *Write Image Freeze* command (due to the one time nature of the splash image). *Write Image Freeze = unfreeze* must still be executed.

Table 24. Test Pattern Generator Example Using Image Freeze

Command	Notes
Write Image Freeze = freeze	
Write Image Crop, Write Display Size, Write Display Image Orientation, Write Test Pattern Select	Potential data processing commands that may be required for proper display of test pattern image. These should be set before the Write Input Source Select command.
Write Input Source Select = test pattern generator	
Write Image Freeze = unfreeze	

5.1.3.19 Read Image Freeze (1Bh)

5.1.3.19.1 Read

This command reads the state of the image freeze function for the display module.

5.1.3.19.2 Read Parameters

This command has no read parameters.

5.1.3.19.3 Return Parameters

Figure 26 describes the return parameters.

Figure 26. Return Parameters

MSB	Byte 1						LSB
b7	b6	b5	b4	b3	b2	b1	b0

- b(7:1) Reserved
- b(0) Image freeze:
- 0: Image freeze disabled
 - 1: Image freeze enabled

5.1.3.20 Write LOOK Select (22h)

5.1.3.20.1 Write

This command specifies the LOOK for the image on the display module.

5.1.3.20.2 Write Parameters

Figure 27 describes the command parameters.

Figure 27. Write Parameters

MSB	Byte 1						LSB
b7	b6	b5	b4	b3	b2	b1	b0

b(7:0) LOOK number

Default: User-defined

In this product, a LOOK typically specifies a target white point. The number of LOOKs available may be limited by the available space in flash memory.

This command allows the host to select a LOOK (target white point) from a number of LOOKs stored in flash. Based on the LOOK selected and measured data obtained from an appropriate light sensor, the software automatically selects and loads the most appropriate sequence or duty cycle set available in the LOOK, to get as close as possible to the target white point.

LOOKs are specified in this byte by an enumerated value (such as 0,1,2,3). There must always be at least one LOOK, with an enumerated value of 0.

There are two other items that the host should specify in addition to the LOOK. These are:

- A desired degamma curve, achieved by selecting the appropriate degamma/CMT, which has the desired degamma curve and correct bit weights for the sequence selected.
- The desired color points, achieved by selecting the appropriate CCA parameters using the CCA select command.

5.1.3.21 Read LOOK Select (23h)

5.1.3.21.1 Read

This command reads the state of the LOOK select command for the display module.

5.1.3.21.2 Read Parameters

This command has no read parameters.

5.1.3.21.3 Return Parameters

Table 25 describes the return parameters.

Table 25. Return Parameters

Parameter Bytes	Description
Byte 1	See Figure 28
Byte 2	Current red duty cycle (LSByte)
Byte 3	Current red duty cycle (MSByte)
Byte 4	Current green duty cycle (LSByte)
Byte 5	Current green duty cycle (MSByte)
Byte 6	Current blue duty cycle (LSByte)
Byte 7	Current blue duty cycle (MSByte)

Table 25. Return Parameters (continued)

Parameter Bytes	Description
Byte 8	Current sequence frame rate (LSByte)
Byte 9	Current sequence frame rate
Byte 10	Current sequence frame rate
Byte 11	Current sequence frame rate (MSByte)

Figure 28. Byte 1 Return Parameters

MSB	Byte 1						LSB
b7	b6	b5	b4	b3	b2	b1	b0

b(7:0) LOOK number

Figure 29. Byte 2 Return Parameters

MSB	Byte 1						LSB
b7	b6	b5	b4	b3	b2	b1	b0

b(7:0) Sequence number

LOOKs are specified by an enumerated value (such as 0, 1, 2, 3).

The current sequence frame rate is returned as a count specified in units of 66.67 ns (based on the internal 15-MHz clock used to time between input frame syncs), and is valid regardless of whether the controller software made the sequence or duty cycle selection. The frame rate is specified in this way to enable fast and simple compares to the frame count by the software.

5.1.3.22 Read Sequence Header Attributes (26h)

5.1.3.22.1 Read

This command reads sequence header information for the active sequence of the display module.

5.1.3.22.2 Read Parameters

This command has no read parameters.

5.1.3.22.3 Return Parameters

Table 26 describes the return parameters.

Table 26. Return Parameters

Parameter Bytes	Description
Byte 1	Red duty cycle (LSByte) (LOOK structure)
Byte 2	Red duty cycle (MSByte) (LOOK structure)
Byte 3	Green duty cycle (LSByte)(LOOK structure)
Byte 4	Green duty cycle (MSByte) (LOOK structure)
Byte 5	Blue duty cycle (LSByte) (LOOK structure)
Byte 6	Blue duty cycle (MSByte) (LOOK structure)
Byte 7	Maximum frame count (LSByte) (LOOK structure)
Byte 8	Maximum frame count (LOOK structure)
Byte 9	Maximum frame count (LOOK structure)
Byte 10	Maximum frame count (MSByte) (LOOK structure)

Table 26. Return Parameters (continued)

Parameter Bytes	Description
Byte 11	Minimum frame count (LSByte) (LOOK structure)
Byte 12	Minimum frame count (LOOK structure)
Byte 13	Minimum frame count (LOOK structure)
Byte 14	Minimum frame count (MSByte) (LOOK structure)
Byte 15	Max number of sequence vectors (LOOK structure)
Byte 16	Red duty cycle (LSByte) (Sequence structure)
Byte 17	Red duty cycle (MSByte) (Sequence structure)
Byte 18	Green duty cycle (LSByte) (Sequence structure)
Byte 19	Green duty cycle (MSByte) (Sequence structure)
Byte 20	Blue duty cycle (LSByte) (Sequence structure)
Byte 21	Blue duty cycle (MSByte) (Sequence structure)
Byte 22	Maximum frame count (LSByte) (Sequence structure)
Byte 23	Maximum frame count (Sequence structure)
Byte 24	Maximum frame count (Sequence structure)
Byte 25	Maximum frame count (MSByte) (Sequence structure)
Byte 26	Minimum frame count (LSByte) (Sequence structure)
Byte 27	Minimum frame count (Sequence structure)
Byte 28	Minimum frame count (Sequence structure)
Byte 29	Minimum frame count (MSByte) (Sequence structure)
Byte 30	Max number of sequence vectors (Sequence structure)

The sequence header data is stored in two separate flash data structures (the LOOK structure and the sequence structure), and the values from each should match.

The bit weight and bit order for the duty cycle data is shown in [Figure 30](#).

Figure 30. Bit Weight and Bit Order for Duty Cycle Data

MSB	Byte 2						LSB	MSB	Byte 1						LSB
b15 2 ⁷	b14 2 ⁶	b13 2 ⁵	b12 2 ⁴	b11 2 ³	b10 2 ²	b9 2 ¹	b8 2 ⁰	b7 2 ⁻¹	b6 2 ⁻²	b5 2 ⁻³	b4 2 ⁻⁴	b3 2 ⁻⁵	b2 2 ⁻⁶	b1 2 ⁻⁷	b0 2 ⁻⁸

The duty cycle data is specified as each colors percent of the frame time. The sum of the three duty cycles must add up to 100. (for example, R = 30.5 = 1E80h , G = 50 = 3200h, B = 19.5 = 1380h)

The sequence maximum and minimum frame counts are specified in units of 66.67 ns (based on the internal 15 MHz clock used to time between input frame syncs). These are specified in this way to enable fast and simple compares to the frame count by the software.

The maximum number of sequence vectors byte is defined in [Figure 31](#).

Figure 31. Maximum Number of Sequence Vectors

MSB	Byte 15 and 30						LSB
b7	b6	b5	b4	b3	b2	b1	b0

b(7:4) Reserved
 b(3:0) Maximum number of sequence vectors

5.1.3.23 Read DMD Sequencer Sync Mode (2Ch)

5.1.3.23.1 Read

This command reads the state of the DMD sequencer sync mode function of the display module.

5.1.3.23.2 Read Parameters

This command has no read parameters.

5.1.3.23.3 Return Parameters

Figure 32 describes the return parameters.

Figure 32. Return Parameters

MSB	Byte 1						LSB
b7	b6	b5	b4	b3	b2	b1	b0

b(7:2)	Reserved
b(1)	System auto-sync setting: <ul style="list-style-type: none"> • 0h: Lock to external VSYNC (auto-sync) • 1h: Lock to internal VSYNC (auto-sync)
b(0)	DMD sequencer sync mode: <ul style="list-style-type: none"> • 0h: Auto-sync • 1h: Force lock to internal VSYNC

The DMD sequencer sync mode response indicates the setting specified by the *Write DMD Mode* command.

System auto-sync setting response is only valid when the DMD sequencer sync mode is set to auto-sync (otherwise set to 0). The lock to the external VSYNC (auto-sync) option indicates that the system is using the externally provided VSYNC to drive the display module. The lock to the internal VSYNC option indicates that the system is using the internal VSYNC generator to drive the display module.

5.1.3.24 Write Execute Flash Batch File (2Dh)

5.1.3.24.1 Write

This command executes a flash batch file for the display module.

5.1.3.24.2 Write Parameters

Table 27 describes the command parameters.

Table 27. Write Parameters

Parameter Bytes	Description
Byte 1	Batch file number

This command executes a batch file stored in the flash of the display module. Any system write command that can be sent by itself can be grouped together with other system commands or command parameters into a flash batch file, with the exception of all read commands.

The flash batch file numbers specified in this byte are enumerated values (such as 0,1,2,3). Flash batch file 0 is a special auto-init batch file that runs automatically by the DLPC343x software immediately after system initialization is complete. The flash batch file 0 is typically not called using the *Write Execute Batch File* command (although the system allows it). This special flash batch file specifies the source to be used (such as splash screen or data port) once the system initializes.

Embedding flash batch file calls within a flash batch file is not allowed (for example, calling another batch file from within a batch file is not allowed). To execute two batch files back to back, use back to back execute batch file commands.

The system allows adding an execution delay between commands within a flash batch file. This is done using the *Write Flash Batch File Delay* command.

The order of command execution for commands within a flash batch file is the same as if the commands are received over the I²C port.

5.1.3.25 Write External Input Image Size (2Eh)

5.1.3.25.1 Write

This command specifies the active data size of the external input image to the display module.

5.1.3.25.2 Write Parameters

Table 28 describes the command parameters.

Table 28. Write Parameters

Parameter Bytes	Description
Byte 1	Pixels per line (LSByte)
Byte 2	Pixels per line (MSByte)
Byte 3	Lines per frame (LSByte)
Byte 4	Lines per frame (MSByte)

Default: DMD resolution

This command is used in conjunction with the *Write Input Source Select* command. This command specifies the active data size of the input image to the system for all external video interfaces, when the *Write Input Source Select* command selects external video port as the image source. The settings for this command are retained until changed using this command. These settings automatically apply each time the external video port is selected.

The parameter values are 1-based. (for example, a value of 1280 pixels specifies 1280 pixels per line).

The user should review the notes for the *Write Input Source Select* command to understand the concept of source-associated commands. This concept determines when source-associated commands are executed by the system. This command is a source-associated command.

The maximum and minimum input values are shown in Table 29. Values outside of these ranges are flagged as an error (invalid command parameter), and the command does not execute.

Table 29. Input Source Limits for Active Data

Parameter	Minimum Value	Maximum Value
Input source active pixels per line (single controller)	320	1280
Input source active lines per frame (single controller)	200	800
Input source active pixels per line (dual controller)	1920 ⁽¹⁾	1920 ⁽¹⁾
Input source active lines per frame (dual controller)	1080 ⁽¹⁾	1080 ⁽¹⁾

⁽¹⁾ Scaling is not supported for dual controller configurations.

5.1.3.26 Read External Input Image Size (2Fh)

5.1.3.26.1 Read

This command reads the specified data size of the external input image to the display module.

5.1.3.26.2 Read Parameters

This command has no read parameters.

5.1.3.26.3 Return Parameters

Table 30 describes the return parameters.

Table 30. Return Parameters

Parameter Bytes	Description
Byte 1	Pixels per line (LSByte)
Byte 2	Pixels per line (MSByte)
Byte 3	Lines per frame (LSByte)
Byte 4	Lines per frame (MSByte)

The parameter values are 1-based. (for example, a value of 1280 pixels specifies 1280 pixels per line).

This command returns the value specified by the *Write External Input Image Size* command.

5.1.3.27 Write Splash Screen Execute (35h)

5.1.3.27.1 Write

This command starts the process of retrieving a splash screen from flash for display on the display module.

5.1.3.27.2 Write Parameters

This command has no write parameters.

This command is used in conjunction with the *Write Input Source Select* and the *Write Splash Screen Select* commands to start the process of retrieving a splash screen from flash for display.

The splash screen is read from flash and sent down the processing path of the controller once, to be stored in memory for display at the end of the processing path. All image processing settings (such as image crop, image orientation, display size, splash screen select, and splash screen as input source) should be set by the user before executing this command. Any data path processing changed after the splash screen has been executed requires this command to be re-executed before the result is seen on the display. Thus, the splash screen retrieval process repeats each time this command is received. See the *Write Image Freeze* command for more information on hiding on-screen artifacts when selecting and retrieving a splash image.

The user should review the notes for the *Write Input Source Select* command to understand the concept of source-associated commands. This concept determines when source-associated commands are executed by the system. This command is a source-associated command; however, this command has no maintained state or history and has no settings to be stored or reused by the system.

When this command is processed, the system automatically sets up the system color processing based on the splash header information, prior to sending the splash image down the data path.

5.1.3.28 Write LED Output Control Method (50h)

5.1.3.28.1 Write

This command specifies the method for controlling the LED outputs for the display module.

5.1.3.28.2 Write Parameters

Figure 33 describes the command parameters.

Figure 33. Write Parameters

MSB	Byte 1						LSB
b7	b6	b5	b4	b3	b2	b1	b0

- b(7:2) Reserved
- b(1:0) LED control method:
- 00: Manual RGB LED currents (disables CAIC algorithm)
 - 01: CAIC (automatic) RGB LED power (enables CAIC algorithm)
 - 10: Reserved
 - 11: Reserved

Default: User-defined

This command selects the method used to control the output of the red, green, and blue LEDs. Based on the method chosen, a specific set of commands are available for controlling the LED outputs. These are shown in [Table 31](#).

The manual RGB LED currents method provides for manual control of the LED currents, and disables the CAIC algorithm. The CAIC (automatic) RGB LED current control method provides automatic control of the LED currents using the CAIC algorithm.

Table 31. Available Commands Based on LED Control Method

LED Control Method	Available Commands
Manual RGB LED current control	Write RGB LED Enable Read RGB LED Enable Write Manual RGB LED Current Read Manual RGB LED Current Write Manual RGB LED Max Current (see Section 5.1.3.35) Read Manual RGB LED Max Current (see Section 5.1.3.36)
CAIC (automatic) RGB LED current control	Write RGB LED Enable Read RGB LED Enable Read CAIC LED Max Available Power Read CAIC LED RGB Current

5.1.3.29 Read LED Output Control Method (51h)

5.1.3.29.1 Read

This command reads the state of the LED output control method for the display module.

5.1.3.29.2 Read Parameters

This command has no read parameters.

5.1.3.29.3 Return Parameters

[Figure 34](#) describes the return parameters.

Figure 34. Return Parameters

MSB	Byte 1						LSB
b7	b6	b5	b4	b3	b2	b1	b0

- b(7:2) Reserved
- b(1:0) LED control method:
- 00: Manual RGB LED currents (CAIC algorithm disabled)
 - 01: CAIC (automatic) RGB LED current control (CAIC algorithm enabled)
 - 10: Reserved
 - 11: Reserved

5.1.3.30 Write RGB LED Enable (52h)

5.1.3.30.1 Write

This command enables the LEDs for the display module.

5.1.3.30.2 Write Parameters

Figure 35 describes the command parameters.

Figure 35. Write Parameters

MSB	Byte 1						LSB
b7	b6	b5	b4	b3	b2	b1	b0

- b(7:3) Reserved
- b(2) Blue LED enable:
- 0: Blue LED disabled
 - 1: Blue LED enabled
- b(1) Green LED enable:
- 0: Green LED disabled
 - 1: Green LED enabled
- b(0) Red LED enable:
- 0: Red LED disabled
 - 1: Red LED enabled

Default: 07h

5.1.3.31 Read RGB LED Enable (53h)

5.1.3.31.1 Read

This command reads the state of the LED enables for the display module.

5.1.3.31.2 Read Parameters

This command has no read parameters.

5.1.3.31.3 Return Parameters

Figure 36 describes the return parameters.

Figure 36. Return Parameters

MSB	Byte 1						LSB
b7	b6	b5	b4	b3	b2	b1	b0

b(7:3)	Reserved
b(2)	Blue LED enable: <ul style="list-style-type: none"> • 0: Blue LED disabled • 1: Blue LED enabled
b(1)	Green LED enable: <ul style="list-style-type: none"> • 0: Green LED disabled • 1: Green LED enabled
b(0)	Red LED enable: <ul style="list-style-type: none"> • 0: Red LED disabled • 1: Red LED enabled

5.1.3.32 Write RGB LED Current (54h)

5.1.3.32.1 Write

This command sets the current for the red, green, and blue LEDs of the display module.

5.1.3.32.2 Write Parameters

[Table 32](#) describes the command parameters.

Table 32. Write Parameters

Parameter Bytes	Description
Byte 1	Red LED current parameter (LSByte)
Byte 2	Red LED current parameter (MSByte)
Byte 3	Green LED current parameter (LSByte)
Byte 4	Green LED current parameter (MSByte)
Byte 5	Blue LED current parameter (LSByte)
Byte 6	Blue LED current parameter (MSByte)

Default: User-defined

When an all-white image is displayed, this command allows the system white point to be adjusted while establishing the total LED power. This is true whether the CAIC algorithm is enabled or disabled.

The parameters specified by this command have a resolution of 10 bits, and are defined by the appropriate DLPA200x specification.

When the CAIC algorithm is disabled, this command directly sets the LED currents (the R, G, and B values provided are sent directly to the DLPA200x device) regardless of the image being displayed.

When the CAIC algorithm is enabled:

- This command directly sets the LED currents when an all-white image is displayed. If the image is changed from an all-white image, depending on the image the CAIC algorithm may alter one or more of the LED currents from those specified by this command, and the total LED power may drop. The *Read CAIC RGB LED Current* command can read the actual LED currents for the image currently displayed.
- In the case of an all-white image, the values read by the *Read CAIC RGB LED Current* command closely match, but may not exactly match, those requested using the *Write RGB LED Current* command. For an all-white image, the *Read CAIC RGB LED Current* command gives currents within +/-4 DLPA200x device current steps for each LED color relative to those requested by the *Write RGB*

LED Current command.

- When the *Write RGB LED Current* command changes the LED currents, the LED current for any color should not be changed by more than +/-25% from the nominal current used for that color when the CAIC LUTs were created. No LED current should be set to a current value beyond the maximum value supported in the CAIC intensity-to-current LUT for the corresponding color.
- The maximum total LED power for any displayed image occurs for an all-white image, since the CAIC algorithm requests the CAIC LED maximum available power. The maximum available LED power for the CAIC is controlled by the *Write RGB LED Current* command, as this command controls currents for an all-white image. After the currents are adjusted, the *Read CAIC LED Max Available Power* command is used to see the maximum power in watts derived from the CAIC.

5.1.3.33 Read RGB LED Current (55h)

5.1.3.33.1 Read

This command reads the state of the current for the red, green, and blue LEDs of the display module.

5.1.3.33.2 Read Parameters

This command has no read parameters.

5.1.3.33.3 Return Parameters

Table 33 describes the return parameters.

Table 33. Return Parameters

Parameter Bytes	Description
Byte 1	Red LED current parameter (LSByte)
Byte 2	Red LED current parameter (MSByte)
Byte 3	Green LED current parameter (LSByte)
Byte 4	Green LED current parameter (MSByte)
Byte 5	Blue LED current parameter (LSByte)
Byte 6	Blue LED current parameter (MSByte)

See [Section 5.1.3.32](#) for a detailed description of the return parameters.

Unused most significant bits are set to 0.

5.1.3.34 Read CAIC LED Max Available Power (57h)

5.1.3.34.1 Read

This command reads the specified maximum LED power allowed for the display module.

5.1.3.34.2 Read Parameters

This command has no read parameters.

5.1.3.34.3 Return Parameters

Table 34 describes the return parameters.

Table 34. Return Parameters

Parameter Bytes	Description
Byte 1	Maximum LED power (LSByte)
Byte 2	Maximum LED power (MSByte)

The value is specified in watts × 100 (for example: 25.75 W = A0Fh). This command is only applicable when CAIC is enabled.

The CAIC maximum available LED power pertains if an all-white image is displayed where LED currents are set by the *Write RGB LED Current* command. The calculation is:

$$\begin{aligned} &R \text{ duty cycle} \times R \text{ LED current} \times R \text{ LED voltage} + \\ &G \text{ duty cycle} \times G \text{ LED current} \times G \text{ LED voltage} + \\ &B \text{ duty cycle} \times B \text{ LED current} \times B \text{ LED voltage}. \end{aligned}$$

For example: $(.30 \times .49 \text{ A} \times 2.0 \text{ V}) + (.50 \times .39 \text{ A} \times 3.1 \text{ V}) + (.20 \times .39 \text{ A} \times 3.1 \text{ V}) = (.30 \times .980 \text{ W}) + (.50 \times 1.209 \text{ W}) + (.20 \times 1.209 \text{ W}) = 1.140 \text{ W}$

5.1.3.35 Write RGB LED Max Current (5Ch)

5.1.3.35.1 Write

This command specifies the maximum LED current allowed for each LED in the display module.

5.1.3.35.2 Write Parameters

[Table 35](#) describes the command parameters.

Table 35. Write Parameters

Parameter Bytes	Description
Byte 1	Maximum red LED current (LSByte)
Byte 2	Maximum red LED current (MSByte)
Byte 3	Maximum green LED current (LSByte)
Byte 4	Maximum green LED current (MSByte)
Byte 5	Maximum blue LED current (LSByte)
Byte 6	Maximum blue LED current (MSByte)

Default: User defined

This command sets the maximum LED currents that can be used when CAIC is enabled or disabled. When CAIC is enabled, the maximum LED currents may be further limited by the CAIC LUTs stored in the flash.

5.1.3.36 Read RGB LED Max Current (5Dh)

5.1.3.36.1 Read

This command reads the specified maximum LED current allowed for each LED in the display module.

5.1.3.36.2 Read Parameters

This command has no read parameters.

5.1.3.36.3 Return Parameters

[Table 36](#) describes the return parameters.

Table 36. Return Parameters

Parameter Bytes	Description
Byte 1	Maximum red LED current (LSByte)
Byte 2	Maximum red LED current (MSByte)
Byte 3	Maximum green LED current (LSByte)
Byte 4	Maximum green LED current (MSByte)

Table 36. Return Parameters (continued)

Parameter Bytes	Description
Byte 5	Maximum blue LED current (LSByte)
Byte 6	Maximum blue LED current (MSByte)

See the [Section 5.1.3.32](#) for a detailed description of the return parameters.

Unused most significant bits are set to 0.

5.1.3.37 Read CAIC RGB LED Current (5Fh)

5.1.3.37.1 Read

This command reads the state of the current for the red, green, and blue LEDs of the display module.

5.1.3.37.2 Read Parameters

This command has no read parameters.

5.1.3.37.3 Return Parameters

[Table 37](#) describes the return parameters.

Table 37. Return Parameters

Parameter Bytes	Description
Byte 1	Red LED current parameter (LSByte)
Byte 2	Red LED current parameter (MSByte)
Byte 3	Green LED current parameter (LSByte)
Byte 4	Green LED current parameter (MSByte)
Byte 5	Blue LED current parameter (LSByte)
Byte 6	Blue LED current parameter (MSByte)

The parameters returned by this command have a resolution of 10 bits, and are defined by the appropriate DLPA200x specification.

When the CAIC algorithm is enabled using the *LED Output Control Method* command:

- The *Write RGB LED Current* command directly sets the LED currents when an all-white image is displayed. If the image changes from an all-white image, depending on the image, the CAIC algorithm may alter one or more of the LED currents from those specified by the *Write RGB LED Current* command, and the total LED power may drop. The actual LED currents for the image currently displayed are read using the *Read CAIC RGB LED Current* command.
- In the case of an all-white image, the values returned by this command closely match, but may not exactly match, those specified using the *Write RGB LED Current* command. For an all-white image, this command provides values within +/- 4 DLPA200x device current steps for each LED color relative to those specified with the *Write RGB LED Current* command.

Use of this command is only appropriate when the LED output control method is set to CAIC (automatic) RGB LED current control.

Unused most significant bits are set to 0.

5.1.3.38 Write Local Area Brightness Boost Control (80h)

5.1.3.38.1 Write

This command controls the local area brightness boost image processing functionality for the display module.

5.1.3.38.2 Write Parameters

Table 38 describes the command parameters.

Table 38. Write Parameters

Parameter Bytes	Description
Byte 1	See Figure 37
Byte 2	LABB strength setting

Figure 37. Byte 1 Return Parameters

MSB	Byte 1						LSB
b7	b6	b5	b4	b3	b2	b1	b0

- b(7:4) Sharpness strength
- b(3:2) Reserved
- b(1:0) LABB control:
- 0h: Disabled
 - 1h: Enabled: Manual strength control (no light sensor)
 - 2h: Enabled: Automatic strength control (uses light sensor)
 - 3h: Reserved

Default: 0001h

The key function of the LABB is to adaptively gain up darker parts of the image to achieve an overall brighter image.

For automatic strength control, a light sensor automatically adjusts the applied image strength based on the measured black level of the screen, or the ambient lighting level of the room.

For LABB strength, 0 indicates no boost applied and 255 indicates the maximum boost viable in a product. The strength is not a direct indication of the gain, since the gain varies depending on the image content.

Sharpness strength ranges from 0 to 15, with 0 indicating sharpness disabled and 15 indicating the maximum sharpness. The LABB function must be enabled (either manual or automatic) to make use of sharpness.

LABB is supported in TPG, splash, and external input mode, but auto-disabled in curtain mode.

5.1.3.39 Read Local Area Brightness Boost Control (81h)

5.1.3.39.1 Read

This command reads the state of the local area brightness boost image processing functionality for the display module.

5.1.3.39.2 Read Parameters

This command has no read parameters.

5.1.3.39.3 Return Parameters

Figure 38 describes the return parameters.

Figure 38. Return Parameters

Parameter Bytes	Description
Byte 1	See Figure 39
Byte 2	LABB strength setting
Byte 3	LABB gain value

Figure 39. Byte 1 Return Parameters

MSB	Byte 1						LSB
b7	b6	b5	b4	b3	b2	b1	b0

- b(7:4) Sharpness strength
- b(3:2) Reserved
- b(1:0) LABB control:
- 0h: Disabled
 - 1h: Enabled: Manual strength control (no light sensor)
 - 2h: Enabled: Automatic strength control (uses light sensor)
 - 3h: Reserved

[Figure 40](#) shows the bit order and weighting for the LABB gain value, which ranges from 1 to 8 (the controller software should limit the lower value to 1).

Figure 40. Bit Weight Definition for LABB Gain Value

b7	b6	b5	b4	b3	b2	b1	b0
2^2	2^1	2^0	2^{-1}	2^{-2}	2^{-3}	2^{-4}	2^{-5}

The software equation to calculate LABB Gain as a fixed point value is shown below:

```
LABB_gain = add_8lsb(APL) / pre_LABB_APL      (//add 8 LSBs (u8.0 / u8.0 = u8.8 / u8.0 = u8.8))
```

5.1.3.40 Write CAIC Image Processing Control (84h)

5.1.3.40.1 Write

This command controls the CAIC functionality for the display module.

5.1.3.40.2 Write Parameters

[Table 39](#) describes the command parameters.

Table 39. Write Parameters

Parameter Bytes	Description
Byte 1	See Figure 41
Byte 2	CAIC maximum lumens gain
Byte 3	CAIC clipping threshold

Figure 41. Byte 1 Write Parameters

MSB	Byte 1						LSB
b7	b6	b5	b4	b3	b2	b1	b0

- b(7) CAIC gain display enable:
- 0h: Disabled
 - 1h: Enabled
- b(6) CAIC gain display scale:
- 0h: 100% = 1024 pixels
 - 1h: 100% = 512 pixels
- b(5:0) Reserved

Default: User-defined

The CAIC algorithm (Content Adaptive Illumination Control) provides adaptive control of the LED currents and the digital gain applied to the image.

The CAIC algorithm is enabled or disabled based on the method of LED current control selected by the OEM using the *Write LED Output Control Method* command. When enabled, the CAIC algorithm provides automatic control of the LED currents as specified by this command and the *Write LED Output Control Method* command.

The CAIC gain display provides a visual presentation of the instantaneous gain provided by the CAIC algorithm. This is typically used as a debug tool and to show the performance of the algorithm, and should never be used for normal operation. The display is composed of five bars, with the bottom three bars (green, red, and blue) showing the respective CAIC gain for each color. The top two bars are for TI debug use only. For the software, the CAIC gain display enable is controlled by CAIC_DEBUG_MODE (2:0), where disabled = 0h, and enabled = 3h. The display scale is set using CAIC_DEBUG_MODE(3).

Figure 42 shows the bit order and weighting for the CAIC maximum lumens gain value, which has a valid range from 1.0 to 4.0. Values outside of this range are considered an error (invalid command parameter value – communication status) and the command does not execute.

Figure 42. Bit Weight Definition for the CAIC Maximum Lumens Gain Value

b7	b6	b5	b4	b3	b2	b1	b0
2^2	2^1	2^0	2^{-1}	2^{-2}	2^{-3}	2^{-4}	2^{-5}

The CAIC maximum lumens gain parameter sets the maximum lumens gain for a pixel as a result of both digital gain and increasing LED currents. The CAIC maximum lumens gain parameter also serves to bias the CAIC algorithm towards either constant power (variable brightness) or constant lumens (variable power). Some examples are listed below:

- Maximum gain value = 1.0: This biases performance to constant lumens. In this case, LED power is reduced for those images where this is possible, but lumens do not increase or decrease.
- Maximum lumens gain value = 4.0: This biases performance to constant power. In this case, power is held constant for most images, while the lumens are gained up. For the small percent of images where the gain exceeds 4.0, lumens stop increasing and the power is reduced.

Figure 43 shows the bit order and weighting for the CAIC clipping threshold value, which has a valid range from 0.0% to 4.0%. Values outside of this range are considered an error (invalid command parameter value – communication status) and the command does not execute.

Figure 43. Bit Weight Definition for the CAIC Clipping Threshold Value

b7	b6	b5	b4	b3	b2	b1	b0
2^1	2^0	2^{-1}	2^{-2}	2^{-3}	2^{-4}	2^{-5}	2^{-6}

The CAIC clipping threshold parameter sets the percentage of pixels clipped by the CAIC algorithm over the full frame of active data, due to the digital gain applied by the CAIC algorithm.

Figure 44 shows the bit order and weighting for the CAIC RGB intensity gain values, which have a valid range from 0.0 to almost 1.0. Values outside of this range are considered an error (invalid command parameter value – communication status) and the command does not execute.

Figure 44. Bit Weight Definition for the CAIC RGB Intensity Gain Values

b15	b14	b13	b12	b11	b10	b9	b8	b7	b6	b5	b4	b3	b2	b1	b0
Res	Res	Res	Res	Res	Res	2 ⁻¹	2 ⁻²	2 ⁻³	2 ⁻⁴	2 ⁻⁵	2 ⁻⁶	2 ⁻⁷	2 ⁻⁸	2 ⁻⁹	2 ⁻¹⁰

CAIC can be enabled in TPG and external input mode, but auto-disabled in splash and curtain mode.

Table 40. LABB and CAIC Modes

Feature	TPG	Splash	Curtain	External Input
LABB	Supported	Supported	Auto-disabled	Supported
CAIC	Supported	Auto-disabled	Auto-disabled	Supported
Manual idle mode	Supported	Supported	Auto-disabled	Supported

5.1.3.41 Read CAIC Image Processing Control (85h)

5.1.3.41.1 Read

This command reads the state of the CAIC functionality within the display module.

5.1.3.41.2 Read Parameters

This command has no read parameters.

5.1.3.41.3 Return Parameters

Table 41 describes the return parameters.

Table 41. Return Parameters

Parameter Bytes	Description
Byte 1	See Figure 45
Byte 2	CAIC maximum lumens gain
Byte 3	CAIC clipping threshold

Figure 45. Byte 1 Return Parameters

MSB	Byte 1						LSB
b7	b6	b5	b4	b3	b2	b1	b0

- b(7) CAIC gain display enable:
- 0h: Disabled
 - 1h: Enabled
- b(6) CAIC gain display scale:
- 0h: 100% = 1024 pixels
 - 1h: 100% = 512 pixels
- b(5:0) Reserved

Information on these parameters can be found in [Section 5.1.3.40](#).

5.1.3.42 Write Color Coordinate Adjustment Control (86h)

5.1.3.42.1 Write

This command controls the CCA image processing functionality for the display module.

5.1.3.42.2 Write Parameters

[Figure 46](#) describes the command parameters.

Figure 46. Write Parameters

MSB	Byte 1						LSB
b7	b6	b5	b4	b3	b2	b1	b0

- b(7:1) Reserved
- b(0) CCA enable:
- 0: Disabled
 - 1: Enabled

Default: 01h

This command is for TI debug purposes only. This function should remain enabled during normal operation.

When CCA is disabled, use an identity matrix.

5.1.3.43 Read Color Coordinate Adjustment Control (87h)

5.1.3.43.1 Read

This command reads the state of the CCA image processing within the display module.

5.1.3.43.2 Read Parameters

This command has no read parameters.

5.1.3.43.3 Return Parameters

[Figure 47](#) describes the return parameters.

Figure 47. Return Parameters

MSB	Byte 1						LSB
b7	b6	b5	b4	b3	b2	b1	b0

- b(7:1) Reserved
- b(0) CCA enable:
- 0: Disabled
 - 1: Enabled

5.1.3.44 Write Keystone Correction Control (88h)

5.1.3.44.1 Write

This command controls the keystone correction image processing functionality for the display module.

5.1.3.44.2 Write Parameters

Table 42 describes the command parameters.

Table 42. Write Parameters

Parameter Bytes	Description
Byte 1	See Figure 48
Byte 2	Optical throw ratio (LSByte)
Byte 3	Optical throw ratio (MSByte)
Byte 4	Optical DMD offset (LSByte)
Byte 5	Optical DMD offset (MSByte)

Figure 48. Byte 1 Write Parameters

MSB	Byte 1						LSB
b7	b6	b5	b4	b3	b2	b1	b0

- b(7:1) Reserved
- b(0) Keystone correction enable:
- 0: Disabled
 - 1: Enabled

Default: All bytes: 00h

Keystone correction digitally compensates for distorted images when the projector is tilted up or down. Keystone correction is specified by the pitch angle (described in the *Write Keystone Projection Pitch Angle* command) and based on the throw ratio, vertical offset, and projector orientation. Each parameter is provided by this command. With this information, keystone correction corrects for both overall and local area aspect ratio distortion. For both full screen images and sub-images, the full active area of the DMD is keystone-corrected.

When keystone correction is enabled, the *Write Border Color* command sets the border color to black. Setting this parameter to any other color produces undesirable results.

Image rotation is allowed while keystone correction is enabled, but it may not be appropriate for all situations or configurations. The user is responsible for determining if the result is acceptable.

[Figure 49](#) shows the bit order and weighting for the optical throw ratio data. [Figure 50](#) defines how this data is determined.

Figure 49. Bit Weight Definition for the Optical Throw Ratio Data

b15	b14	b13	b12	b11	b10	b9	b8	b7	b6	b5	b4	b3	b2	b1	b0
2^7	2^6	2^5	2^4	2^3	2^2	2^1	2^0	2^{-1}	2^{-2}	2^{-3}	2^{-4}	2^{-5}	2^{-6}	2^{-7}	2^{-8}

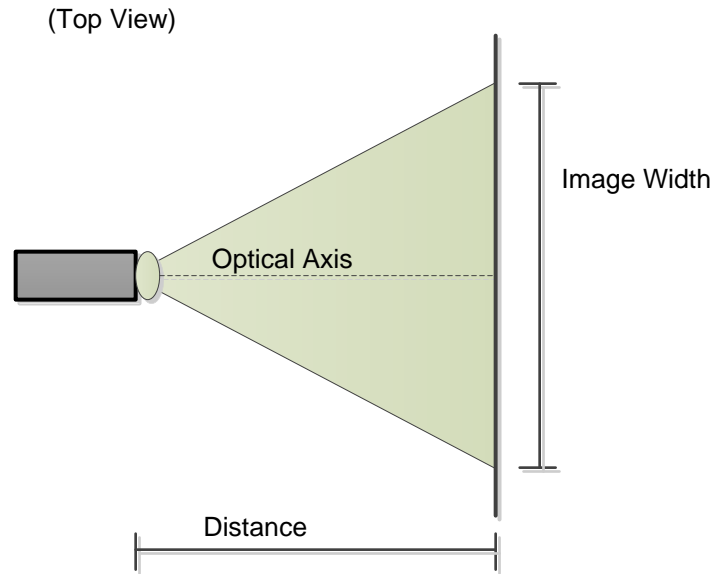

$$\text{Throw Ratio} = \text{Distance} / \text{Image Width}$$

$$\text{Throw Ratio Register Value} = 256 \times \text{Throw Ratio}$$

Figure 50. Visual Definition and Calculation for Optical Throw Ratio Data

Figure 51 shows the bit order and weighting for the 2's complement optical DMD offset data. Figure 52 shows how this data is calculated, while Figure 53 shows how the sign of the offset data is determined. The user must insure that both the value and the sign of the offset data are correctly determined.

Figure 51. Bit Weight Definition for the Optical DMD Offset Data

b15	b14	b13	b12	b11	b10	b9	b8	b7	b6	b5	b4	b3	b2	b1	b0
2^7	2^6	2^5	2^4	2^3	2^2	2^1	2^0	2^{-1}	2^{-2}	2^{-3}	2^{-4}	2^{-5}	2^{-6}	2^{-7}	2^{-8}

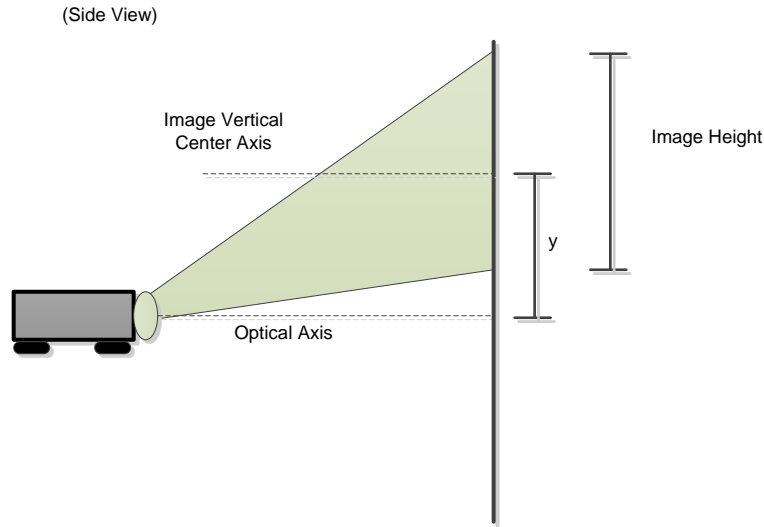

Vertical Offset = $2 \times y / \text{Image Height}$
 Vertical Offset Register Value = $256 \times \text{Vertical Offset}$
 (Image Height is always a positive value, while 'y' can be positive or negative)

Figure 52. Method for Calculation for Optical DMD Offset Data

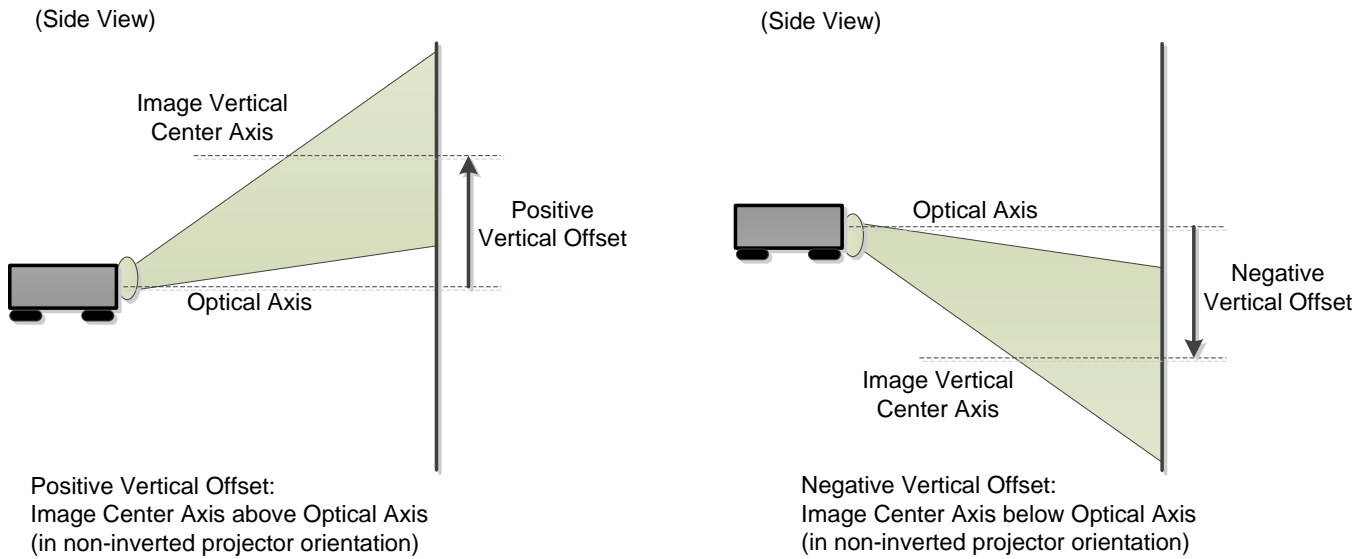

Figure 53. Sign Determination for Optical DMD Offset Data

Figure 54 shows examples of non-inverted and inverted projector orientation. This information is required for byte 1 of this command.

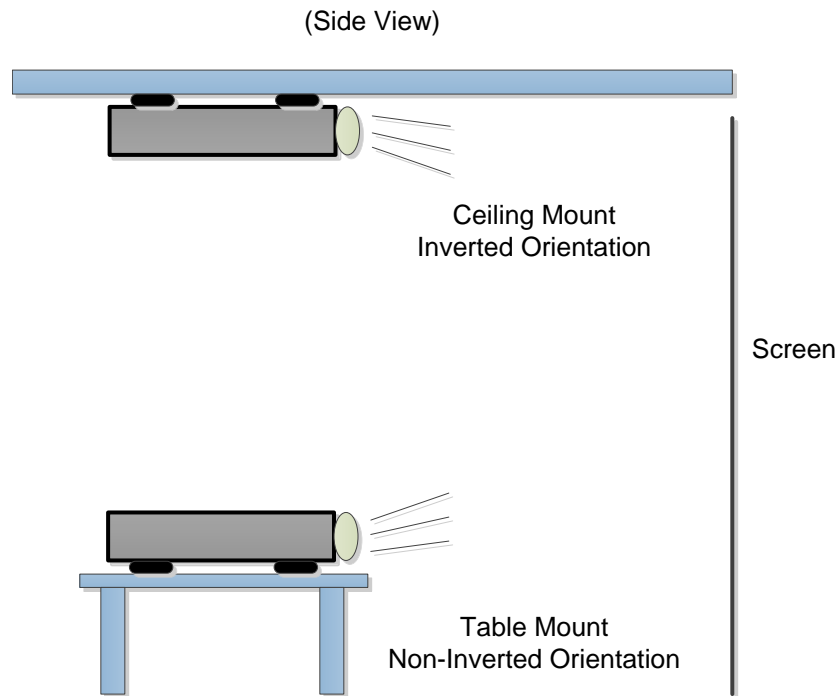

Figure 54. Examples of Non-Inverted and Inverted Projector Orientations

5.1.3.45 Read Keystone Correction Control (89h)

5.1.3.45.1 Read

This command reads the state of the keystone correction image processing within the display module.

5.1.3.45.2 Read Parameters

This command has no read parameters.

5.1.3.45.3 Return Parameters

[Table 43](#) describes the return parameters.

Table 43. Return Parameters

Parameter Bytes	Description
Byte 1	See Figure 55
Byte 2	Optical throw ratio (LSByte)
Byte 3	Optical throw ratio (MSByte)
Byte 4	Optical DMD offset (LSByte)
Byte 5	Optical DMD offset (MSByte)

Figure 55. Byte 1 Return Parameters

MSB	Byte 1						LSB
b7	b6	b5	b4	b3	b2	b1	b0

- b(7:1) Reserved
- b(0) Keystone correction enable:
- 0: Disabled
 - 1: Enabled

5.1.3.46 Write Border Color (B2h)

5.1.3.46.1 Write

This command specifies the onscreen border color for the display module.

5.1.3.46.2 Write Parameters

[Figure 56](#) describes the command parameters.

Figure 56. Write Parameters

MSB	Byte 1						LSB
b7	b6	b5	b4	b3	b2	b1	b0

- b(7:3) Reserved
- b(2:0) Display border color:
- 0h: Black
 - 1h: Red
 - 2h: Green
 - 3h: Blue
 - 4h: Cyan
 - 5h: Magenta
 - 6h: Yellow
 - 7h: White

Default: 00h

Whenever the display image size is smaller than the active area of the DMD, the border color is used for all non-image pixels. Some examples using a border include a window box, pillar box, or letterbox image.

To display a pillar box image (see [Figure 57](#)), the OEM can use the border color defined by this command.

The border color specified by this command is separate from the curtain color defined in the *Display Image Curtain* command, though both display using the curtain capability.

Whenever the keystone capability is used, the OEM should set the border color to black. Setting this parameter to any other color when keystone is enabled produces undesirable results.

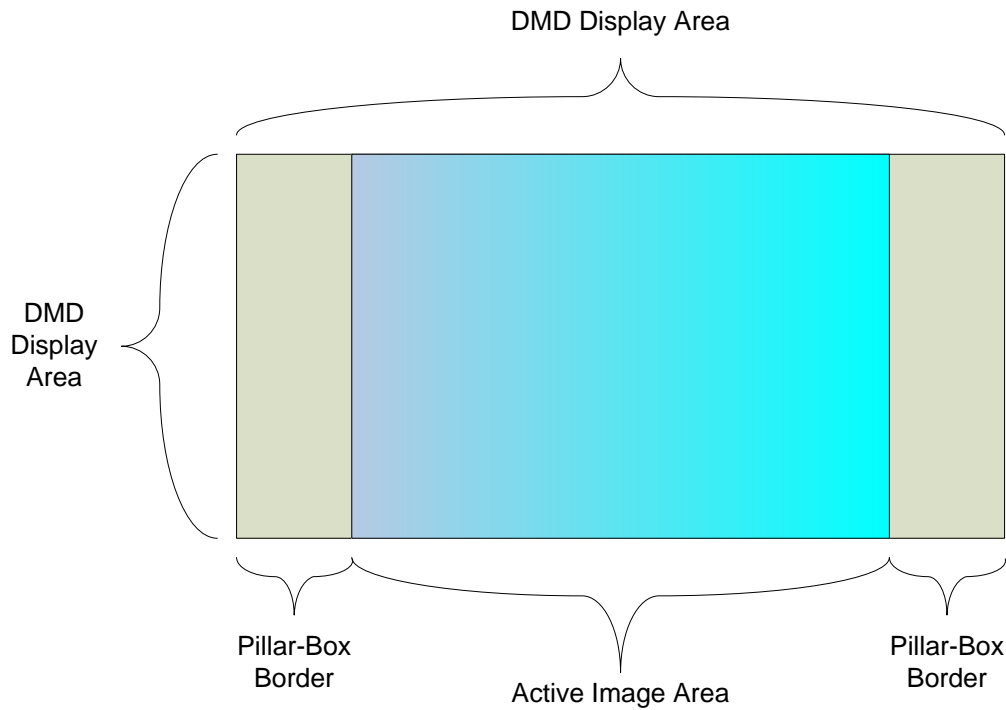

Figure 57. Pillar-Box Border Example

5.1.3.47 Read Border Color (B3h)

5.1.3.47.1 Read

This command reads the state of the onscreen border color for the display module.

5.1.3.47.2 Read Parameters

This command has no read parameters.

5.1.3.47.3 Return Parameters

Figure 58 describes the return parameters.

Figure 58. Return Parameters

MSB	Byte 1						LSB
b7	b6	b5	b4	b3	b2	b1	b0

- b(7) Pillar-box border color source:
 - 0h: Defined by this command
 - 1h: Flash defined 24-bit color
- b(6:3) Reserved

- b(2:0) Display border color:
- 0h: Black
 - 1h: Red
 - 2h: Green
 - 3h: Blue
 - 4h: Cyan
 - 5h: Magenta
 - 6h: Yellow
 - 7h: White

For the special case of a pillar box image (see [Figure 57](#)), the OEM can use the border color defined by the *Write Border Color* command.

5.1.3.48 Write Keystone Projection Pitch Angle (BBh)

5.1.3.48.1 Write

This command specifies the projection pitch angle for the display module.

5.1.3.48.2 Write Parameters

[Table 44](#) describes the command parameters.

Table 44. Write Parameters

Parameter Bytes	Description
Byte 1	Projection pitch angle (LSByte)
Byte 2	Projection pitch angle (MSByte)

Default: 0000h

[Figure 59](#) shows the bit order and weighting for the 2's complement projection pitch angle data.

Figure 59. Bit Weight Definition for the Projection Pitch Angle Data

b15	b14	b13	b12	b11	b10	b9	b8	b7	b6	b5	b4	b3	b2	b1	b0
2 ⁷	2 ⁶	2 ⁵	2 ⁴	2 ³	2 ²	2 ¹	2 ⁰	2 ⁻¹	2 ⁻²	2 ⁻³	2 ⁻⁴	2 ⁻⁵	2 ⁻⁶	2 ⁻⁷	2 ⁻⁸

This command is used in conjunction with the *Write Keystone Correction Control* command.

The projection pitch angle is limited to the range of -40 to 40 degrees. [Figure 60](#) shows examples of the projection pitch angle.

(Side View)

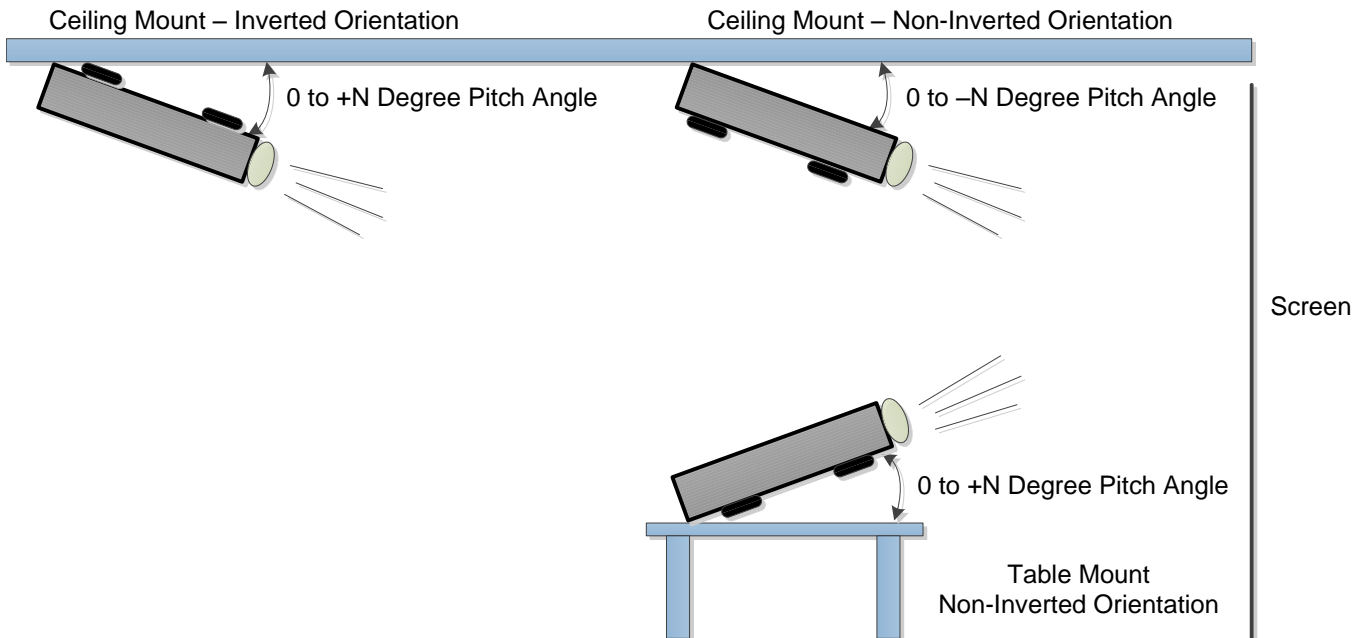

Figure 60. Examples of Projection Pitch Angle

5.1.3.49 Read Keystone Projection Pitch Angle (BCh)

5.1.3.49.1 Read

This command reads the specified projection pitch angle for the display module.

5.1.3.49.2 Read Parameters

This command has no read parameters.

5.1.3.49.3 Return Parameters

[Table 45](#) describes the return parameters.

Table 45. Return Parameters

Parameter Bytes	Description
Byte 1	Projection pitch angle (LSByte)
Byte 2	Projection pitch angle (MSByte)

5.1.3.50 Read Short Status (D0h)

5.1.3.50.1 Read

This command provides a short system status for the display module.

5.1.3.50.2 Read Parameters

This command has no read parameters.

5.1.3.50.3 Return Parameters

Table 46 describes the return parameters.

Table 46. Return Parameters

Parameter Bytes	Description
Byte 1	Short System Status

Figure 61. Byte 1 Return Parameters

MSB	Byte 1 – General Status						LSB
b7	b6	b5	b4	b3	b2	b1	b0

b(7)	Boot/main application:
	<ul style="list-style-type: none"> • 0: Boot • 1: Main
b(6:4)	Reserved
b(3)	System error:
	<ul style="list-style-type: none"> • 0: No error • 1: Error
b(2)	Reserved
b(1)	Communication error:
	<ul style="list-style-type: none"> • 0: No error • 1: Error
b(0)	System initialization:
	<ul style="list-style-type: none"> • 0: Not complete • 1: Complete

The communication error bit indicates any error on the I²C command interfaces. Specific details about communication errors are available using the *Read Communication Status* command. Any errors other than a communication error are indicated by the system error bit. Specific details about system errors are available using the *Read System Status* command.

The communication error, and system error bits are cleared when the *Read Short Status* is read. The *Read Short Status* command should only be checked periodically, not continuously. Continuous access may severely impact system performance.

5.1.3.51 Read System Status (D1h)

5.1.3.51.1 Read

This command reads system status information for the display module.

5.1.3.51.2 Read Parameters

This command has no read parameters.

5.1.3.51.3 Return Parameters

Table 47 describes the return parameters.

Table 47. Return Parameters

Parameter Bytes	Description
Byte 1	DMD interface status
Byte 2	LED status
Byte 3	Internal interrupt status
Byte 4	Misc. status

All system status error bits are cleared when the read system status is read.

Figure 62. Byte 1 Return Parameters

MSB	Byte 1 – DMD Interface Status						LSB
b7	b6	b5	b4	b3	b2	b1	b0

b(7:3)	Reserved
b(2)	DMD training error: <ul style="list-style-type: none"> • 0: No error • 1: Error
b(1)	DMD interface error: <ul style="list-style-type: none"> • 0: No error • 1: Error
b(0)	DMD device error: <ul style="list-style-type: none"> • 0: No error • 1: Error

The system sets the DMD device error for the following conditions:

- The system cannot read the DMD device ID from the DMD.
- The system-specified DMD device ID does not match the actual DMD device ID.

The system sets the DMD interface error when there are power management setup conflicts on this interface. The system sets the DMD training error when the training algorithm can not find a data eye that meets the specified requirements.

Figure 63. Byte 2 Return Parameters

MSB	Byte 1 – LED Status						LSB
b7	b6	b5	b4	b3	b2	b1	b0

b(7:6)	Reserved
b(5)	Blue LED error: <ul style="list-style-type: none"> • 0: No error • 1: Error
b(4)	Green LED error: <ul style="list-style-type: none"> • 0: No error • 1: Error
b(3)	Red LED error: <ul style="list-style-type: none"> • 0: No error • 1: Error
b(2)	Blue LED state: <ul style="list-style-type: none"> • 0: Off • 1: On

- b(1) Green LED state:
- 0: Off
 - 1: On
- b(0) Red LED state:
- 0: Off
 - 1: On

Figure 64. Byte 3 Return Parameters

MSB	Byte 1 – Internal Interrupt Status						LSB
b7	b6	b5	b4	b3	b2	b1	b0

- b(7:2) Reserved
- b(1) Sequence error:
- 0: No error
 - 1: Error
- b(0) Sequence abort error:
- 0: No error
 - 1: Error

Figure 65. Byte 4 Return Parameters

MSB	Byte 1 – Misc. Status						LSB
b7	b6	b5	b4	b3	b2	b1	b0

- b(7:6) Reserved
- b(5) Watchdog timer timeout:
- 0: No timeout
 - 1: Timeout
- b(4) Product configuration error:
- 0: No error
 - 1: Error
- b(3) Master versus slave operation:
- 0: Master
 - 1: Slave
- b(2) Single versus dual controller configuration:
- 0: Single
 - 1: Dual
- b(1:0) Reserved

The system sets the product configuration error bit if it determines that some piece of the product configuration is not correct. Some examples are:

- Invalid controller or DMD combination
- Invalid controller or DLPA200x combination
- Invalid flash build for the current controller, DMD, or DLPA200x configuration

The system sets the watchdog timer timeout bit if the system has been reset due to a watchdog timer timeout.

5.1.3.52 Read System Software Version (D2h)

5.1.3.52.1 Read

This command reads the main application software version information for the display module.

5.1.3.52.2 Read Parameters

This command has no read parameters.

5.1.3.52.3 Return Parameters

Table 48 describes the return parameters.

Table 48. Return Parameters

Parameter Bytes	Description
Byte 1	Controller main application software version – patch LSByte
Byte 2	Controller main application software version – patch MSByte
Byte 3	Controller main application software version – Minor
Byte 4	Controller main application software version – Major

5.1.3.53 Read Communication Status (D3h)

5.1.3.53.1 Read

This command reads system status information for the display module.

5.1.3.53.2 Read Parameters

The read parameters are described in Table 49.

Table 49. Read Parameters

Parameter Bytes	Description
Byte 1	Command bus status selection

Figure 66. Byte 1 Read Parameters

MSB	Byte 1 – Command Bus Status Selection						LSB
b7	b6	b5	b4	b3	b2	b1	b0

- b(7:2) Reserved
- b(1:0) Command bus status selection:
- 00: Reserved
 - 01: Reserved
 - 10: I²C only
 - 11: Reserved

This command returns the communication status for the specified command bus. For I²C only: This selection returns status bytes 5 through 6.

5.1.3.53.3 Return Parameters

Table 50 describes the return parameters.

Table 50. Return Parameters

Parameter Bytes	Description
Byte 5	Communication status
Byte 6	Aborted op-code

All communication status error bits are cleared when the *Read Communication Status* is read.

Figure 67. Byte 5 Return Parameters

MSB	Byte 5 – Communication Status						LSB
b7	b6	b5	b4	b3	b2	b1	b0

b(7)	Reserved
b(6)	Bus timeout by display error: <ul style="list-style-type: none"> • 0: No error • 1: Error
b(5)	Invalid number of command parameters: <ul style="list-style-type: none"> • 0: No error • 1: Error
b(4)	Read command error: <ul style="list-style-type: none"> • 0: No error • 1: Error
b(3)	Flash batch file error: <ul style="list-style-type: none"> • 0: No error • 1: Error
b(2)	Command processing error: <ul style="list-style-type: none"> • 0: No error • 1: Error
b(1)	Invalid command parameter value: <ul style="list-style-type: none"> • 0: No error • 1: Error
b(0)	Invalid command error: <ul style="list-style-type: none"> • 0: No error • 1: Error

The system sets the invalid command error bit when it does not recognize the command op-code. The invalid command op-code is reported in the I²C CMD error op-code byte of this status.

The system sets the invalid command parameter error bit when it detects that the value of a command parameter is not valid (for example, out of the allowed range).

The system sets the command processing error bit when a fault is detected when processing a command. In this case, the command aborts and the system moves on to the next command. The op-code for the aborted command is reported in the I²C CMD error op-code byte of this status.

The system sets the flash batch file error bit when an error occurs during the processing of a flash batch file. When this bit is set, typically another bit is set to indicate what kind of error was detected (for example, an invalid command error).

The system sets the read command error bit when the host terminates the read operation before all of the requested data has been provided, or if the host continues to request read data after all of the requested data has been provided.

The system sets the invalid number of command parameters error bit when too many or too few command parameters are received. In this case, the command aborts and the system moves on to the next command. The op-code for the aborted command is reported in the I²C CMD error op-code byte of this status.

The system sets the bus timeout by display error bit when the display releases control of the bus after the bus timeout value is exceeded.

Figure 68. Byte 6 Return Parameters

MSB	Byte 6 – CMD Error Op-Code						LSB
b7	b6	b5	b4	b3	b2	b1	b0

b(7:0) I²C CMD error op-code

The CMD error op-code is associated with various I²C communication status bits, and reports the op-code for an I²C command as noted.

5.1.3.54 Read Controller Device ID (D4h)

5.1.3.54.1 Read

This command reads the controller device ID for the display module.

5.1.3.54.2 Read Parameters

This command has no read parameters.

5.1.3.54.3 Return Parameters

[Figure 69](#) describes the return parameters.

Figure 69. Return Parameters

MSB	Byte 1						LSB
b7	b6	b5	b4	b3	b2	b1	b0

b(7:4) Reserved

b(3:0) Controller device ID

The controller device ID can be decoded using [Table 51](#).

Table 51. Controller Device ID Decode

Controller Device ID	Device Number	Application
00h	DLPC3430	Embedded (SD)
01h	DLPC3433	Embedded (SD)
02h	DLPC3432	Embedded (SD)
04h	DLPC3435	Standalone (SD)
05h	DLPC3438	Standalone (SD)

Unused controller device ID values are reserved.

5.1.3.55 Read DMD Device ID (D5h)

5.1.3.55.1 Read

This command reads the DMD device ID for the display module.

5.1.3.55.2 Read Parameters

The read parameters are described in [Figure 70](#).

Figure 70. Read Parameters

MSB	Byte 1 – DMD Register Selection						LSB
b7	b6	b5	b4	b3	b2	b1	b0

- b(7:3) Reserved
- b(2:0) DMD data selection:
- 0h: DMD device ID
 - 1h – 7h: Reserved

5.1.3.55.3 Return Parameters

[Table 52](#) describes the return parameters.

Table 52. DMD Device ID Reference Table

DMD Device ID				Device Description
Byte 1 (Identifier)	Byte 2 (Byte Count)	Byte 3 (ID-msbyte)	Byte 4 (ID-lsbyte)	Resolution and Type
60h	0Dh	00h	64h	0.2 WVGA (854x480, Sub-LVDS)
60h	0Dh	00h	89h	0.23 qHD (960x540, Sub-LVDS)
60h	0Dh	00h	68h	0.3 720p (1280x720, Sub-LVDS)

5.1.3.56 Read Flash Build Version (D9h)

5.1.3.56.1 Write

This command reads the controller flash version for the display module.

5.1.3.56.2 Read Parameters

The command has no read parameters.

5.1.3.56.3 Return Parameters

[Table 53](#) describes the return parameters.

Table 53. Return Parameters

Parameter Bytes	Description
Byte 1	Flash build version – patch LSByte
Byte 2	Flash build version – patch MSByte
Byte 3	Flash build version – Minor
Byte 4	Flash build version – Major

The OEM specifies a version number for the controller flash build in the format specified by this command. This command allows the OEM to read back this version information.

Revision History

Changes from B Revision (March 2018) to C Revision	Page
• Added DLPC3432 as a supported device.....	7
• Removed the section 'Write System Reset' and its reference from Table 2 , this command is no longer supported.....	10
• Removed references to WPC enable bit from Section 5.1.3.40 (Write CAIC Image Processing Control (84h)) and Section 5.1.3.41 (Read CAIC Image Processing Control (85h)), command not supported.....	50
• Added controller device IDs for DLPC3433, DLPC3432, and DLPC3438 to Table 51	66
• Added device with 0.23 qHD (960x540, Sub-LVDS) to Table 52	67

Changes from A Revision (September 2014) to B Revision**Page**

- Changed range of CAIC clipping threshold from "0.0% to 2.0%" : to "0.0% to 4.0%" **50**
-

	Page
Changes from Original (July 2014) to A Revision	
• Added device types DLPC3433 and DLPC3438	7
• Replaced DisplayCrafter with LightCrafter Display	8
• Removed Port-1 information.	8
• Removed Software Command Philosophy section	9
• Removed Write Batch File Delay information from Table 2	11
• Removed Write Flash Batch File Delay (DBh) section	67

IMPORTANT NOTICE FOR TI DESIGN INFORMATION AND RESOURCES

Texas Instruments Incorporated ("TI") technical, application or other design advice, services or information, including, but not limited to, reference designs and materials relating to evaluation modules, (collectively, "TI Resources") are intended to assist designers who are developing applications that incorporate TI products; by downloading, accessing or using any particular TI Resource in any way, you (individually or, if you are acting on behalf of a company, your company) agree to use it solely for this purpose and subject to the terms of this Notice.

TI's provision of TI Resources does not expand or otherwise alter TI's applicable published warranties or warranty disclaimers for TI products, and no additional obligations or liabilities arise from TI providing such TI Resources. TI reserves the right to make corrections, enhancements, improvements and other changes to its TI Resources.

You understand and agree that you remain responsible for using your independent analysis, evaluation and judgment in designing your applications and that you have full and exclusive responsibility to assure the safety of your applications and compliance of your applications (and of all TI products used in or for your applications) with all applicable regulations, laws and other applicable requirements. You represent that, with respect to your applications, you have all the necessary expertise to create and implement safeguards that (1) anticipate dangerous consequences of failures, (2) monitor failures and their consequences, and (3) lessen the likelihood of failures that might cause harm and take appropriate actions. You agree that prior to using or distributing any applications that include TI products, you will thoroughly test such applications and the functionality of such TI products as used in such applications. TI has not conducted any testing other than that specifically described in the published documentation for a particular TI Resource.

You are authorized to use, copy and modify any individual TI Resource only in connection with the development of applications that include the TI product(s) identified in such TI Resource. NO OTHER LICENSE, EXPRESS OR IMPLIED, BY ESTOPPEL OR OTHERWISE TO ANY OTHER TI INTELLECTUAL PROPERTY RIGHT, AND NO LICENSE TO ANY TECHNOLOGY OR INTELLECTUAL PROPERTY RIGHT OF TI OR ANY THIRD PARTY IS GRANTED HEREIN, including but not limited to any patent right, copyright, mask work right, or other intellectual property right relating to any combination, machine, or process in which TI products or services are used. Information regarding or referencing third-party products or services does not constitute a license to use such products or services, or a warranty or endorsement thereof. Use of TI Resources may require a license from a third party under the patents or other intellectual property of the third party, or a license from TI under the patents or other intellectual property of TI.

TI RESOURCES ARE PROVIDED "AS IS" AND WITH ALL FAULTS. TI DISCLAIMS ALL OTHER WARRANTIES OR REPRESENTATIONS, EXPRESS OR IMPLIED, REGARDING TI RESOURCES OR USE THEREOF, INCLUDING BUT NOT LIMITED TO ACCURACY OR COMPLETENESS, TITLE, ANY EPIDEMIC FAILURE WARRANTY AND ANY IMPLIED WARRANTIES OF MERCHANTABILITY, FITNESS FOR A PARTICULAR PURPOSE, AND NON-INFRINGEMENT OF ANY THIRD PARTY INTELLECTUAL PROPERTY RIGHTS.

TI SHALL NOT BE LIABLE FOR AND SHALL NOT DEFEND OR INDEMNIFY YOU AGAINST ANY CLAIM, INCLUDING BUT NOT LIMITED TO ANY INFRINGEMENT CLAIM THAT RELATES TO OR IS BASED ON ANY COMBINATION OF PRODUCTS EVEN IF DESCRIBED IN TI RESOURCES OR OTHERWISE. IN NO EVENT SHALL TI BE LIABLE FOR ANY ACTUAL, DIRECT, SPECIAL, COLLATERAL, INDIRECT, PUNITIVE, INCIDENTAL, CONSEQUENTIAL OR EXEMPLARY DAMAGES IN CONNECTION WITH OR ARISING OUT OF TI RESOURCES OR USE THEREOF, AND REGARDLESS OF WHETHER TI HAS BEEN ADVISED OF THE POSSIBILITY OF SUCH DAMAGES.

You agree to fully indemnify TI and its representatives against any damages, costs, losses, and/or liabilities arising out of your non-compliance with the terms and provisions of this Notice.

This Notice applies to TI Resources. Additional terms apply to the use and purchase of certain types of materials, TI products and services. These include; without limitation, TI's standard terms for semiconductor products (<http://www.ti.com/sc/docs/stdterms.htm>), [evaluation modules](#), and [samples](http://www.ti.com/sc/docs/sampterm.htm) (<http://www.ti.com/sc/docs/sampterm.htm>).

Mailing Address: Texas Instruments, Post Office Box 655303, Dallas, Texas 75265
Copyright © 2018, Texas Instruments Incorporated