

## **LM5180-Q1 Dual-Output EVM User's Guide**

---

---

---

The [LM5180EVM-DUAL](#) evaluation module (EVM) is a flyback DC/DC converter that employs primary-side regulation (PSR) based on sampling of the transformer's primary winding voltage to achieve high conversion efficiency in a small footprint. It operates over a wide input voltage range of 10 V to 65 V and delivers dual isolated outputs of 15 V and –7.7 V at 200-mA rated load current. Operating without an optocoupler or transformer auxiliary winding, the converter provides an output voltage with better than  $\pm 2\%$  load regulation. The flyback transformer has a turns ratio of 1 : 1 : 0.52 (PRI : SEC1 : SEC2) and provides 1500 VRMS primary-to-secondary isolation.

The EVM design uses the [LM5180-Q1](#) PSR flyback converter with wide input voltage (wide  $V_{IN}$ ) range. An integrated 100-V, 1.5-A power MOSFET provides ample margin for line transients and switch (SW) node voltage spikes related to transformer parasitic leakage inductance. Load regulation errors related to transformer secondary winding resistance are avoided by virtue of the quasi-resonant boundary conduction mode (BCM) control scheme.

Additional features includes current-mode control with internal compensation, hiccup-mode fault protection, low input quiescent current, programmable soft-start, and optional output voltage temperature compensation. UVLO protects the converter at low input voltage conditions, and the EN/UVLO pin supports adjustable input UVLO with user-defined hysteresis for application specific power-up and power-down requirements.

The LM5180 and LM5180-Q1 are available in a 8-pin WSON package with 4-mm × 4-mm footprint and 0.8-mm pin pitch to enable isolated DC/DC solutions with high density and low component count. Wettable flank pins provide a visual indicator of solderability, which reduces the inspection time and manufacturing costs in high-reliability industrial and automotive applications. See the [LM5180](#) and [LM5180-Q1](#) device data sheets for more information.

Use the LM5180-Q1 with [WEBENCH® Power Designer](#) to create a custom regulator design. Furthermore, the user can download the [LM5180 Quickstart Calculator](#) to optimize component selection and examine predicted efficiency performance across line and load ranges.

## Contents

1	High Density EVM Description .....	3
2	EVM Performance Characteristics.....	4
3	Application Circuit Diagram.....	5
4	EVM Photo.....	5
5	Test Setup and Procedure.....	6
6	Test Data and Performance Curves.....	8
7	EVM Documentation .....	15
8	Device and Documentation Support .....	19

## List of Figures

1	LM5180 PSR Flyback Dual-Output Schematic .....	5
2	LM5180-Q1 Dual-Output EVM Photo .....	5
3	EVM Test Setup .....	6
4	Conversion Efficiency (Linear Scale), Outputs Loaded Symmetrically .....	8
5	Conversion Efficiency (Log Scale), Outputs Loaded Symmetrically .....	8
6	Load Regulation (Linear Scale), Sum of $V_{OUT1}$ and $V_{OUT2}$ Measured, Outputs Loaded Symmetrically .....	9
7	Load Regulation (Log Scale), Sum of $V_{OUT1}$ and $V_{OUT2}$ Measured, Outputs Loaded Symmetrically .....	9
8	SW Node Voltage, $I_{OUT1} = -I_{OUT2} = 200$ mA, $V_{IN} = 24$ V .....	10
9	SW Node Voltage, $I_{OUT1} = -I_{OUT2} = 200$ mA, $V_{IN} = 48$ V .....	10
10	Flyback Diode Voltages, $I_{OUT1} = -I_{OUT2} = 200$ mA, $V_{IN} = 24$ V .....	11
11	Flyback Diode Voltages, $I_{OUT1} = -I_{OUT2} = 200$ mA, $V_{IN} = 48$ V .....	11
12	Output 1 Load Transient, 50 mA to 200 mA at 100mA/ $\mu$ s, $I_{OUT2} = -200$ mA, $V_{IN} = 24$ V.....	12
13	Output 2 Load Transient, 50 mA to 200 mA at 100mA/ $\mu$ s, $I_{OUT1} = 200$ mA, $V_{IN} = 24$ V .....	12
14	Start-Up, $V_{IN} = 24$ V, $I_{OUT1} = -I_{OUT2} = 200$ mA Resistive .....	13
15	Enable On, $V_{IN} = 24$ V, $I_{OUT1} = -I_{OUT2} = 200$ mA Resistive .....	13
16	Short Circuit Recovery, $V_{IN} = 24$ V, $I_{OUT1} = -I_{OUT2} = 200$ mA Resistive .....	14
17	EVM Schematic .....	15
18	Top Copper (Top View) .....	17
19	Bottom Copper (Top View).....	17
20	Top Assembly.....	18
21	Bottom Assembly.....	18

## List of Tables

1	Electrical Performance Characteristics .....	4
2	EVM Connections.....	6
3	Bill of Materials .....	16

## Trademarks

WEBENCH is a registered trademark of Texas Instruments.  
All other trademarks are the property of their respective owners.

## 1 High Density EVM Description

The [LM5180EVM-DUAL](#) EVM is designed to use a regulated or non-regulated high-voltage input rail ranging from 10 V to 65 V to produce a tightly-regulated, isolated output voltages of 15 V and  $-7.7$  V at load currents up to 200 mA. This wide  $V_{IN}$  range isolated DC/DC solution offers outsized voltage rating and operating margin to withstand supply rail voltage transients.

The power-train passive components selected for this EVM, including flyback transformer, flyback rectifying diodes, and ceramic input and output capacitors, are available from multiple component vendors. Transformers with functional or basic grade isolation are available with isolation voltages of 1.5 kV and greater.

### 1.1 Typical Applications

- Isolated bias power rails
- IGBT gate drive supplies for BDC and BLDC motor drives
- Industrial and commercial vehicles
- Automotive body and powertrain

### 1.2 Features and Electrical Performance

- Tightly-regulated, isolated output voltages of 15 V and  $-7.7$  V with better than  $\pm 2\%$  load regulation from 1% to 100% load
- Wide input voltage operating range of 10 V to 65 V
- Full load current of 200 mA, both outputs
- Maximum switching frequency of 350 kHz remains below the AM band for automotive applications
- High efficiency across wide load current range
  - Full load efficiency of 88% and 87.5% at  $V_{IN} = 24$  V and 48 V, respectively
  - 88.5% efficiency at half-rated load,  $V_{IN} = 24$  V
- 1.4-mA and 1.1-mA no-load supply current at  $V_{IN} = 24$  V and 48 V, respectively
- Input  $\pi$ -stage EMI filter with damping from electrolytic capacitor ESR
  - Meets EN 55025 / CISPR 25 Class 5 EMI specification
- Boundary conduction mode (BCM) control architecture provides fast line and load transient response
  - Peak current-mode control
  - Quasi-resonant switching for reduced power loss
  - Internal loop compensation
- Integrated 100-V flyback power MOSFET
  - Provides large headroom for input voltage transients
- Cycle-by-cycle overcurrent protection (OCP)
- Monotonic prebias output voltage start-up
- User-adjustable soft-start time set to 10 ms by 47-nF capacitor connected between SS/BIAS and GND
  - Option for external bias using transformer auxiliary winding connected to SS/BIAS
- Resistor-programmable input voltage UVLO with customizable hysteresis for applications with wide turn-on and turn-off voltage difference
  - Input UVLO set to turn on and off at  $V_{IN}$  of 9 V and 7 V, respectively
- Low transformer primary-to-secondary (interwinding) capacitance to accommodate high dv/dt secondary-side common-mode swings
- Fully assembled, tested, and proven PCB layout with 55-mm  $\times$  38-mm total footprint

## 2 EVM Performance Characteristics

**Table 1. Electrical Performance Characteristics**

PARAMETER	TEST CONDITIONS	MIN	TYP	MAX	UNIT		
<b>INPUT CHARACTERISTICS</b>							
Input voltage range, $V_{IN}$	Operating	10	48	65	V		
Input voltage turnon, $V_{IN(ON)}$	Adjusted using EN/UVLO divider resistors	9					
Input voltage turnoff, $V_{IN(OFF)}$		7					
Input voltage hysteresis, $V_{IN(HYS)}$		2					
Input current, no load, $I_{IN(NL)}$	$I_{OUT1} = I_{OUT2} = 0$ mA	$V_{IN} = 24$ V	1.4		mA		
		$V_{IN} = 48$ V	1.1				
		$V_{IN} = 65$ V	1				
Input current, disabled, $I_{IN(OFF)}$	$V_{EN} = 0$ V	$V_{IN} = 24$ V	10		$\mu$ A		
<b>OUTPUT CHARACTERISTICS</b>							
Output voltage, $V_{OUT1}$	$I_{OUT1/2} = 5$ mA to 200 mA	14.7	15.0	15.3	V		
Output voltage, $V_{OUT2}$		-7.5	-7.7	-7.9	V		
Output current, $I_{OUT1}$ , $-I_{OUT2}$ <sup>(1)</sup>	$V_{IN} = 12$ V	0	180		mA		
	$V_{IN} = 24$ V	0	220				
	$V_{IN} = 48$ V	0	300				
	$V_{IN} = 70$ V	0	350				
Output voltage regulation, $\Delta V_{OUT}$	Load regulation, $V_{IN} = 24$ V	$I_{OUT} = 5$ mA to 200 mA		1%			
	Line regulation, $I_{OUT} = 100$ mA	$V_{IN} = 10$ V to 65 V		1%			
Output voltage ripple, $V_{OUT(AC)}$	$V_{IN} = 24$ V, $I_{OUT1} = I_{OUT2} = 200$ mA			100		mVrms	
Output overcurrent protection, $I_{OCP}$	$V_{IN} = 24$ V			250		mA	
Soft-start time, $t_{SS}$	$C_{SS} = 47$ nF			8		ms	
<b>SYSTEM CHARACTERISTICS</b>							
Switching frequency, $F_{SW(nom)}$	$V_{IN} = 24$ V, $I_{OUT1} = I_{OUT2} = 100$ mA			350		kHz	
Half-load efficiency, $\eta_{HALF}$ <sup>(2)</sup>	$I_{OUT1} = I_{OUT2} = 100$ mA	$V_{IN} = 12$ V		88.5%			
		$V_{IN} = 24$ V		88.5%			
		$V_{IN} = 48$ V		86%			
		$V_{IN} = 65$ V		85%			
Full load efficiency, $\eta_{FULL}$	$I_{OUT1} = I_{OUT2} = 200$ mA	$V_{IN} = 24$ V		88%			
		$V_{IN} = 48$ V		87.5%			
		$V_{IN} = 65$ V		87%			
Isolation rating <sup>(3)</sup>	Functional insulation			1500		V	
LM5180 junction temperature, $T_J$				-40		150	$^{\circ}$ C

<sup>(1)</sup> The output power delivered by the LM5180-Q1 PSR flyback converter increases with input voltage.

<sup>(2)</sup> The default output voltages of this EVM are 15 V and -7.7 V. Efficiency and other performance metrics can change based on operating input voltage, load currents, externally-connected output capacitance(s), and other parameters.

<sup>(3)</sup> The selected transformer provides functional isolation.

### 3 Application Circuit Diagram

Figure 1 shows the schematic of an LM5180-based flyback converter (EMI filter stage not shown). Soft start (SS), temperature compensation (TC), and UVLO (EN/UVLO) components are shown that are configurable as required by the specific application. The transformer turns ratio is 1 : 1 : 0.52 and the primary-referred magnetizing inductance is 30  $\mu$ H.

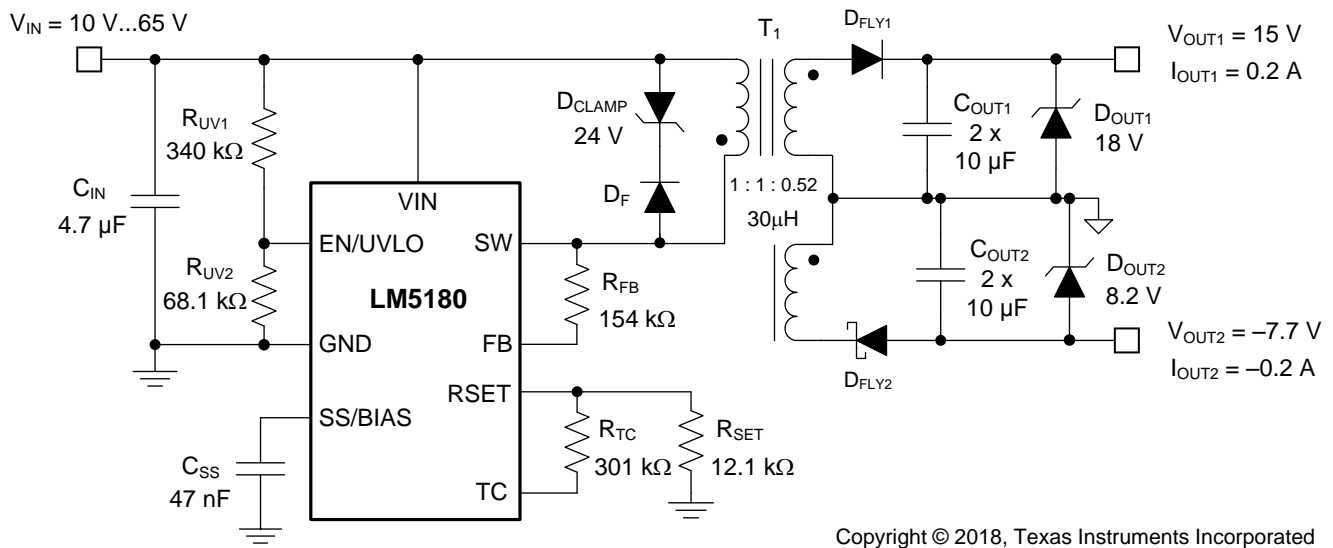

Figure 1. LM5180 PSR Flyback Dual-Output Schematic

### 4 EVM Photo

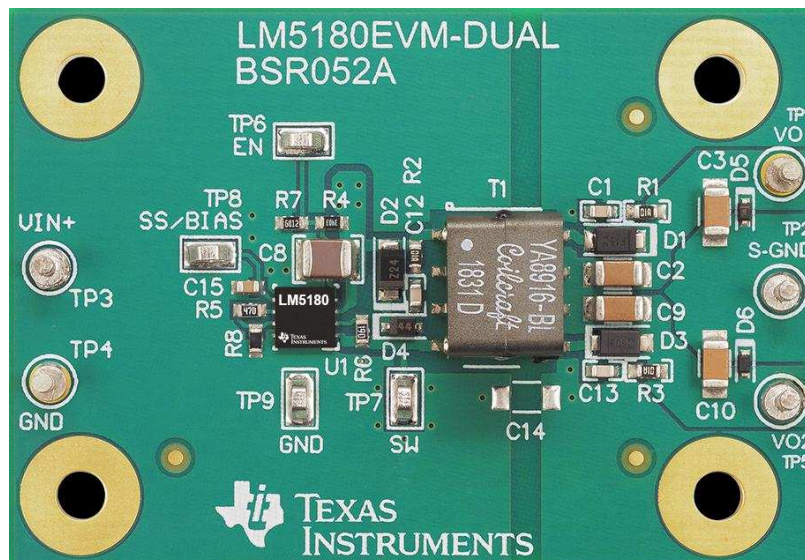

Figure 2. LM5180-Q1 Dual-Output EVM Photo

## 5 Test Setup and Procedure

### 5.1 Test Setup

**Table 2. EVM Connections**

LABEL	DESCRIPTION
VIN+	Positive input voltage power and sense connection
VIN-	Negative input voltage power and sense connection
VOUT1	Output #1 power and sense connection
VOUT2	Output #2 power and sense connection
S-GND	Output return and sense connection
EN	ENABLE input – tie to GND to disable converter
SS/BIAS	External BIAS input
SW	SW node connection

Referencing the EVM connections described in [Table 2](#), the recommended test setup to evaluate the LM5180EVM-DUAL is shown in [Figure 3](#). Working at an ESD-protected workstation, make sure that any wrist straps, boot straps, or mats are connected and referencing the user to earth ground before power is applied to the EVM.

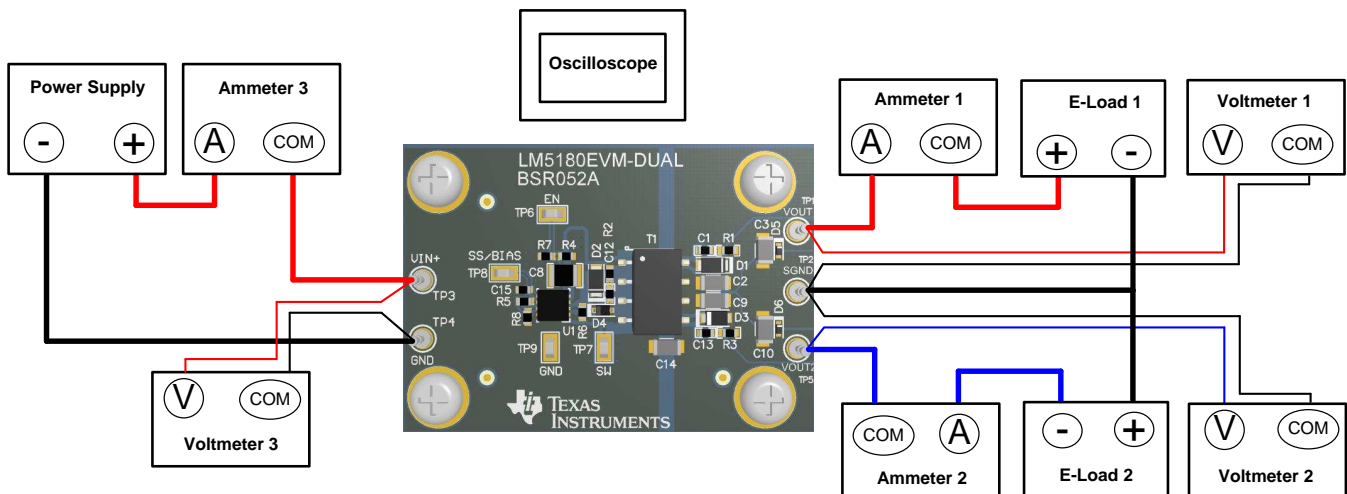

**Figure 3. EVM Test Setup**

#### CAUTION

Refer to the [LM5180](#) and [LM5180-Q1](#) data sheets, [LM5180 Quickstart Calculator](#) and [WEBENCH® Power Designer](#) for additional guidance pertaining to component selection and converter operation.

## 5.2 Test Equipment

**Voltage Source:** The input voltage source  $V_{IN}$  should be a 0–65-V variable DC source.

**Multimeters:**

- **Voltmeter 1:** Input voltage at VIN+ to VIN–. Set voltmeter to an input impedance of 100 M $\Omega$ .
- **Voltmeter 2:** Output voltage at VOUT1 to SGND. Set voltmeter to an input impedance of 100 M $\Omega$ .
- **Voltmeter 3:** Output voltage at VOUT2 to SGND. Set voltmeter to an input impedance of 100 M $\Omega$ .
- **Ammeter 1:** Input current. Set ammeter to 1-second aperture time.
- **Ammeter 2:** Load current, output #1. Set ammeter to 1-second aperture time
- **Ammeter 3:** Load current, output #2. Set ammeter to 1-second aperture time

**Electronic Loads:** The loads should be electronic constant-resistance (CR) or constant-current (CC) mode load capable of 0 Adc to 300 mAdc up to 15 V. For a no-load input current measurement, disconnect the electronic load as it may draw a small residual current.

**Oscilloscope:** With the scope set to 20-MHz bandwidth and AC coupling, measure the output voltage ripple directly across an output capacitor with a short ground lead normally provided with the scope probe. Place the oscilloscope probe tip on the positive terminal of the output capacitor, holding the probe's ground barrel through the ground lead to the capacitor's negative terminal. TI does not recommend using a long-leaded ground connection because this may induce additional noise given a large ground loop. To measure other waveforms, adjust the oscilloscope as needed.

**Safety:** Always use caution when touching any circuits that may be live or energized.

## 5.3 Recommended Test Setup

### 5.3.1 Input Connections

- Prior to connecting the DC input source, set the current limit of the input supply to 100 mA maximum. Ensure the input source is initially set to 0 V and connected to the VIN+ and VIN– connection points as shown in [Figure 3](#). An additional input bulk capacitor is recommended to provide damping if long input lines are used.
- Connect voltmeter 3 at VIN+ and VIN– connection points to measure the input voltage.
- Connect ammeter 3 to measure the input current and set to at least 1-second aperture time.

### 5.3.2 Output Connections

- Connect electronic loads to VOUT1, VOUT2 and SGND connections as shown in [Figure 3](#). Set the load to constant-resistance mode or constant-current mode at 0 A before applying input voltage.
- Connect voltmeters 1 and 2 at VOUT1, VOUT2 and SGND connection points to measure the output voltages.
- Connect ammeters 1 and 2 to measure the output currents.

## 5.4 Test Procedure

### 5.4.1 Line and Load Regulation, Efficiency

- Set up the EVM as described above.
- Set load to constant resistance or constant current mode and to sink 10 mA.
- Increase input source from 0 V to 24 V; use voltmeter 3 to measure the input voltage.
- Increase the current limit of the input supply to 500 mA.
- Using voltmeters to measure the respective output voltages, vary both loads from 10 mA to 200 mA DC;  $V_{OUT1}$  and  $V_{OUT2}$  should remain within the load regulation specification.
- Set the load currents to 100 mA (50% rated load) and vary the input source voltage from 10 V to 65 V;  $V_{OUT1}$  and  $V_{OUT2}$  should remain within the line regulation specification.
- Decrease loads to 10 mA. Decrease input source voltage to 0 V.

## 6 Test Data and Performance Curves

Figure 4 through Figure 16 present typical performance curves for the LM5180EVM-DUAL. Because actual performance data may be affected by measurement techniques and environmental variables, these curves are presented for reference and may differ from actual field measurements.

### 6.1 Efficiency and Regulation

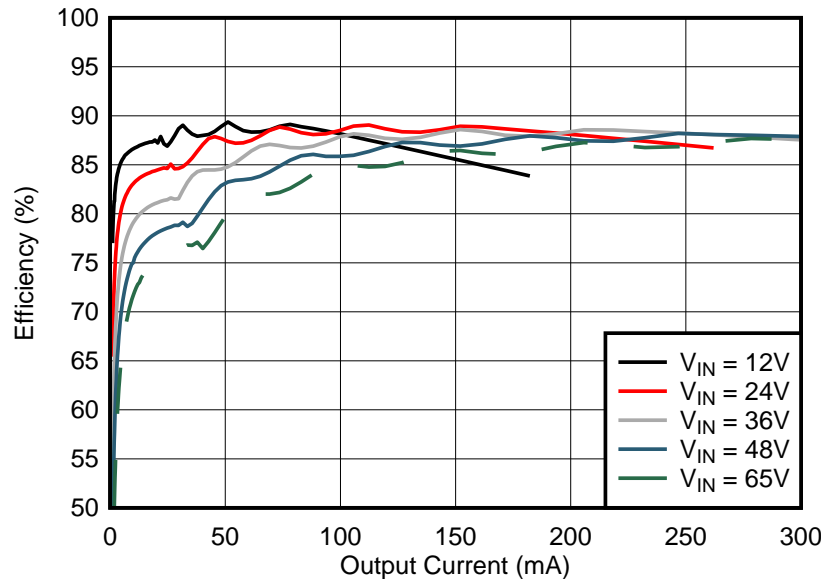

Figure 4. Conversion Efficiency (Linear Scale), Outputs Loaded Symmetrically

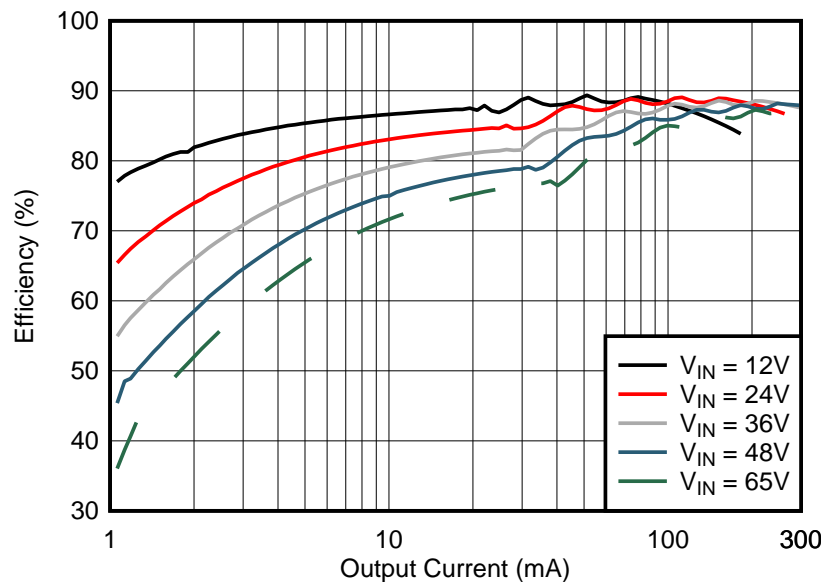

Figure 5. Conversion Efficiency (Log Scale), Outputs Loaded Symmetrically



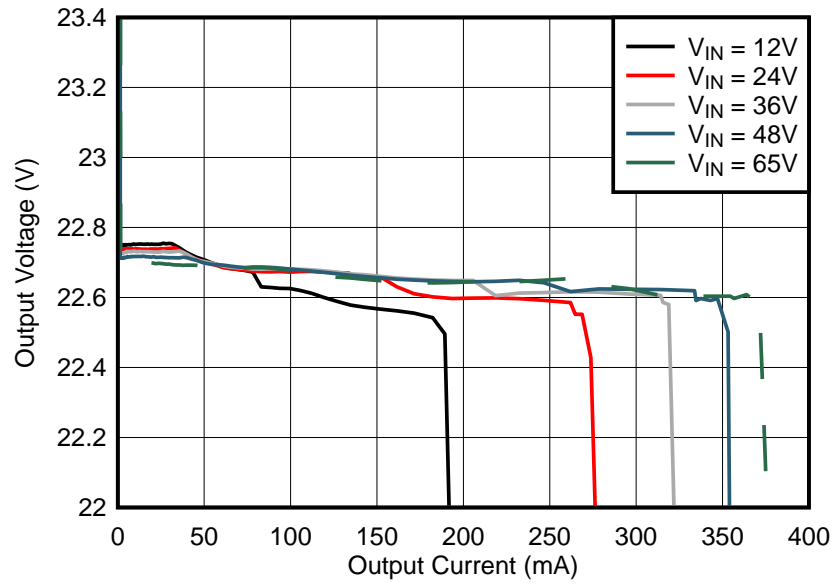

Figure 6. Load Regulation (Linear Scale), Sum of  $V_{OUT1}$  and  $V_{OUT2}$  Measured, Outputs Loaded Symmetrically

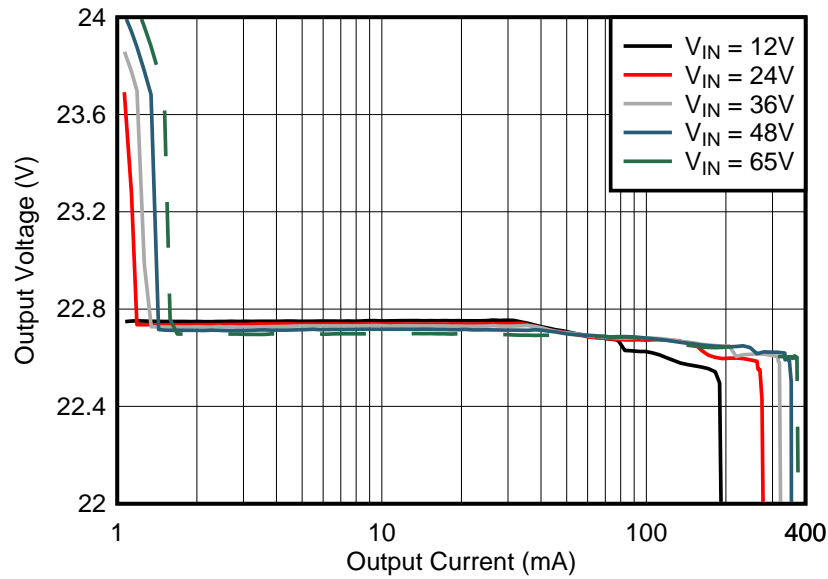

Figure 7. Load Regulation (Log Scale), Sum of  $V_{OUT1}$  and  $V_{OUT2}$  Measured, Outputs Loaded Symmetrically

## 6.2 Operating Waveforms

### 6.2.1 Switching

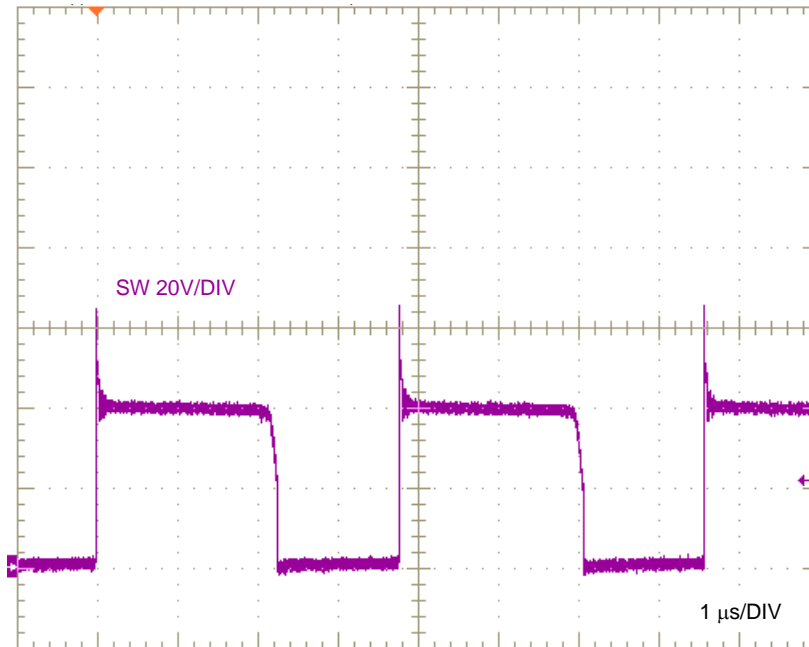

Figure 8. SW Node Voltage,  $I_{OUT1} = -I_{OUT2} = 200 \text{ mA}$ ,  $V_{IN} = 24 \text{ V}$

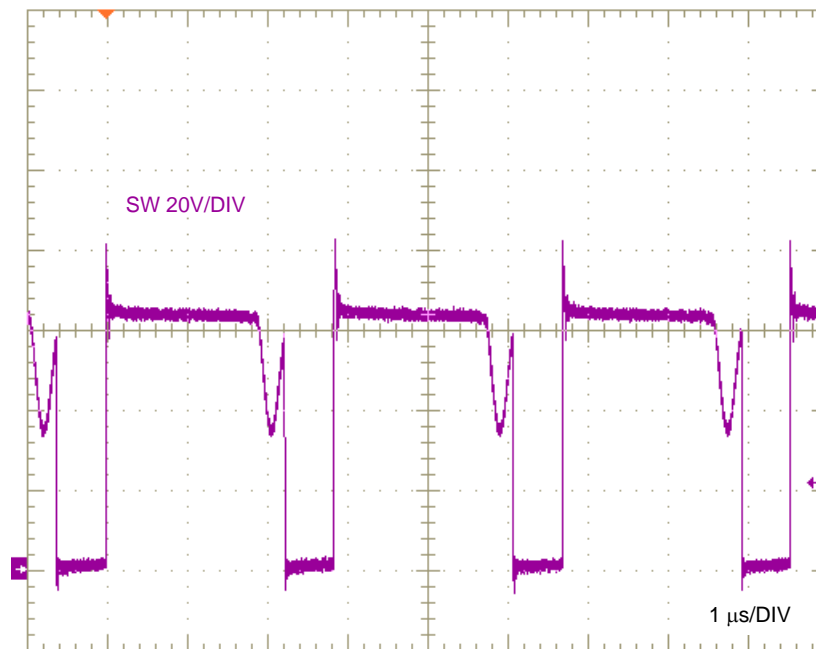

Figure 9. SW Node Voltage,  $I_{OUT1} = -I_{OUT2} = 200 \text{ mA}$ ,  $V_{IN} = 48 \text{ V}$

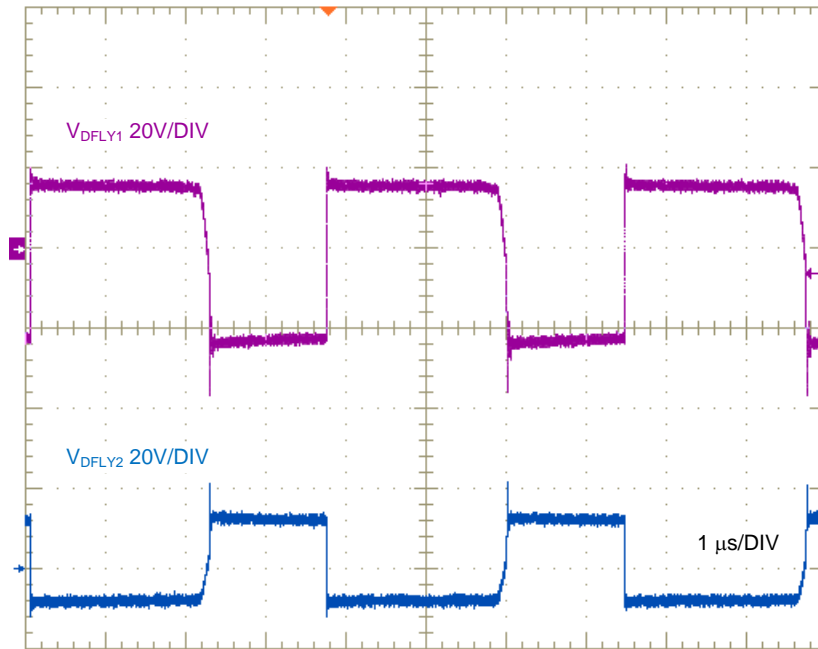

Figure 10. Flyback Diode Voltages,  $I_{OUT1} = -I_{OUT2} = 200 \text{ mA}$ ,  $V_{IN} = 24 \text{ V}$

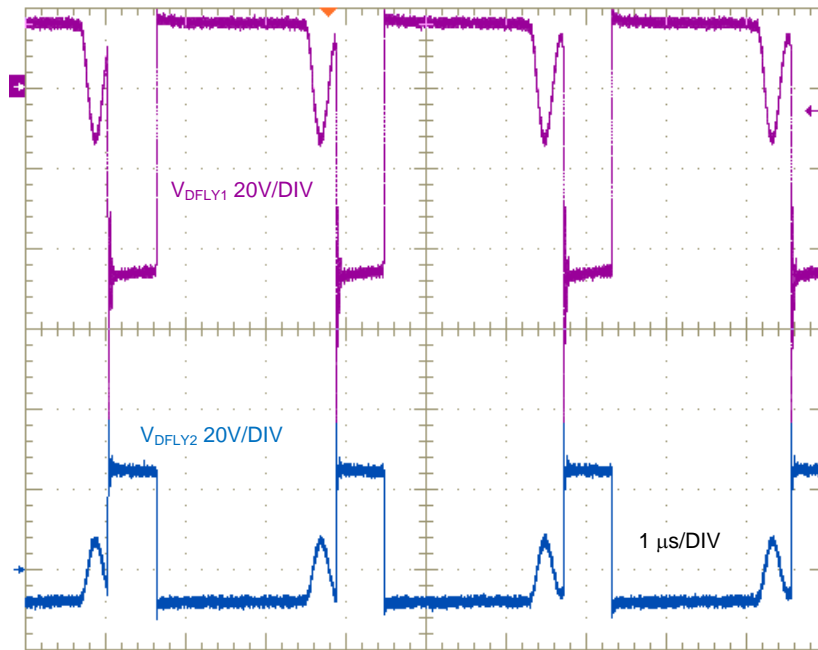

Figure 11. Flyback Diode Voltages,  $I_{OUT1} = -I_{OUT2} = 200 \text{ mA}$ ,  $V_{IN} = 48 \text{ V}$

### 6.2.2 Load Transient Response

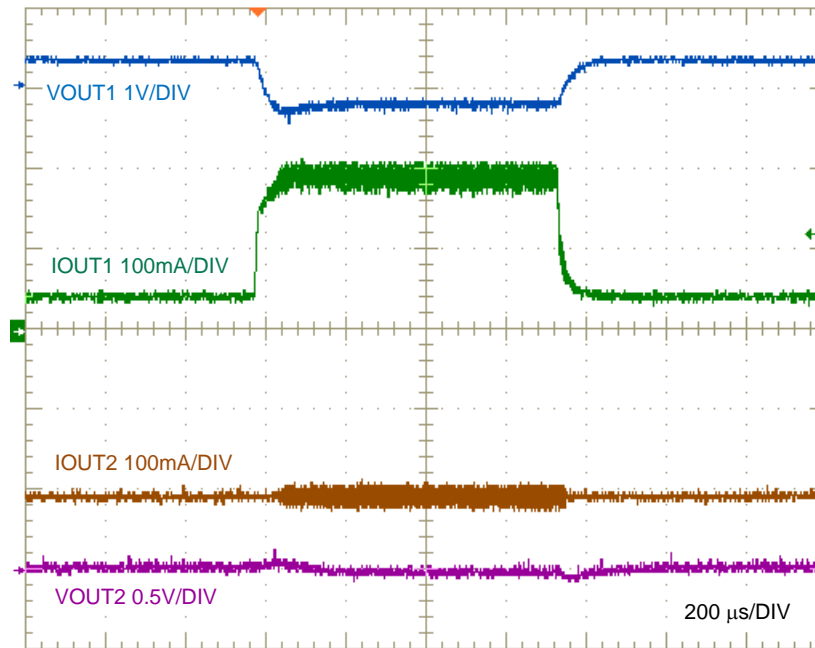

Figure 12. Output 1 Load Transient, 50 mA to 200 mA at 100mA/μs,  $I_{OUT2} = -200$  mA,  $V_{IN} = 24$  V

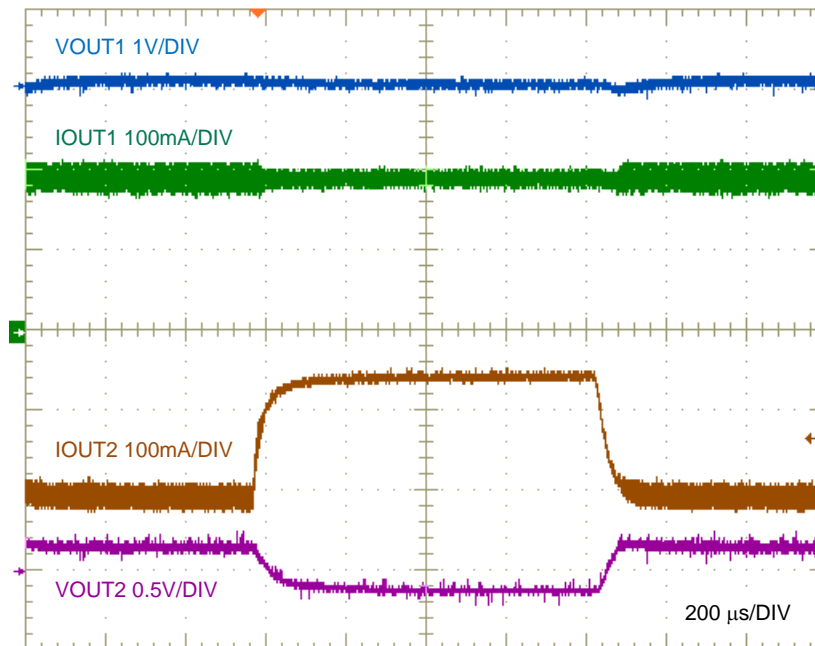

Figure 13. Output 2 Load Transient, 50 mA to 200 mA at 100mA/μs,  $I_{OUT1} = 200$  mA,  $V_{IN} = 24$  V

6.2.3 Start-Up, Enable and Short Circuit Recovery <sup>(1)</sup>

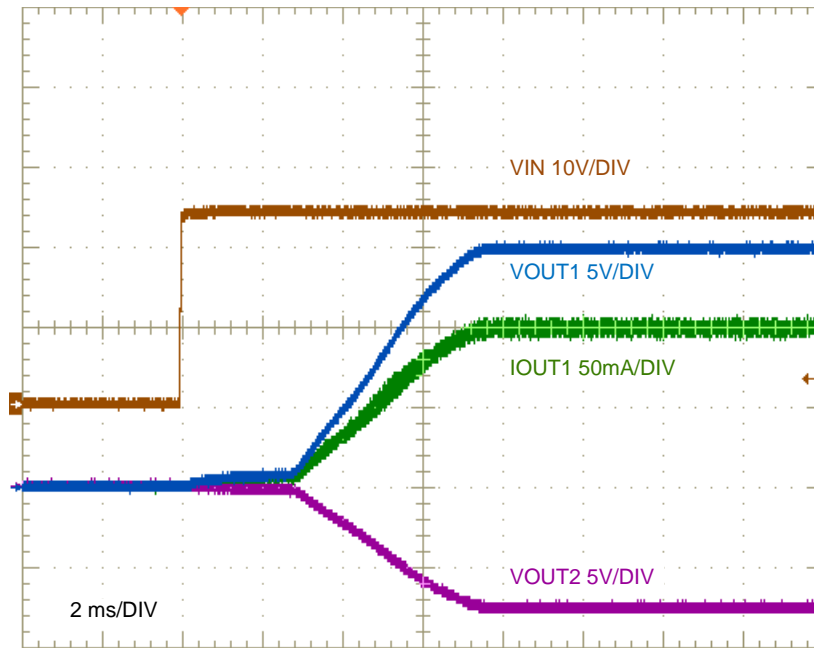

Figure 14. Start-Up,  $V_{IN} = 24\text{ V}$ ,  $I_{OUT1} = -I_{OUT2} = 200\text{ mA}$  Resistive

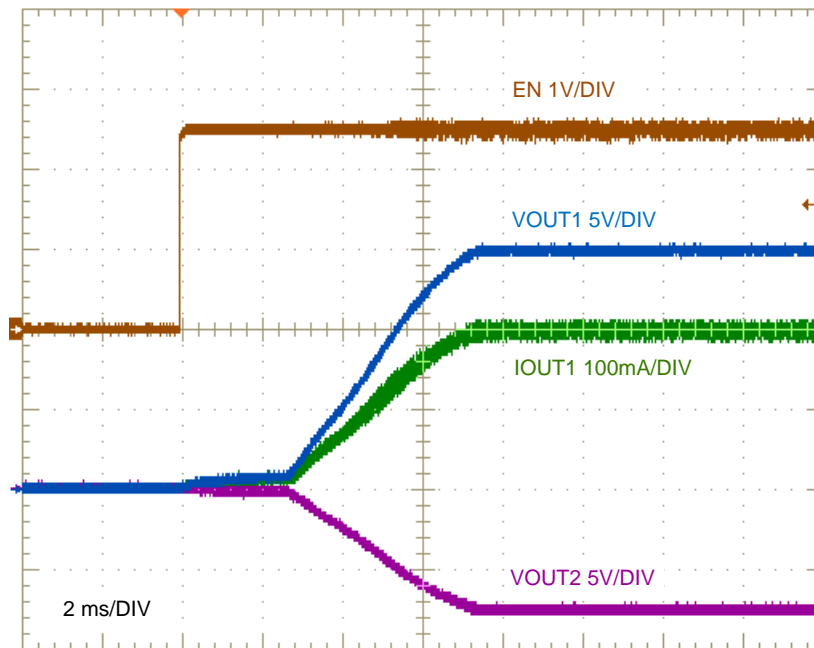

Figure 15. Enable On,  $V_{IN} = 24\text{ V}$ ,  $I_{OUT1} = -I_{OUT2} = 200\text{ mA}$  Resistive

<sup>(1)</sup> The internal soft-start timer is applicable here as the SS cap was not installed during these startup tests.

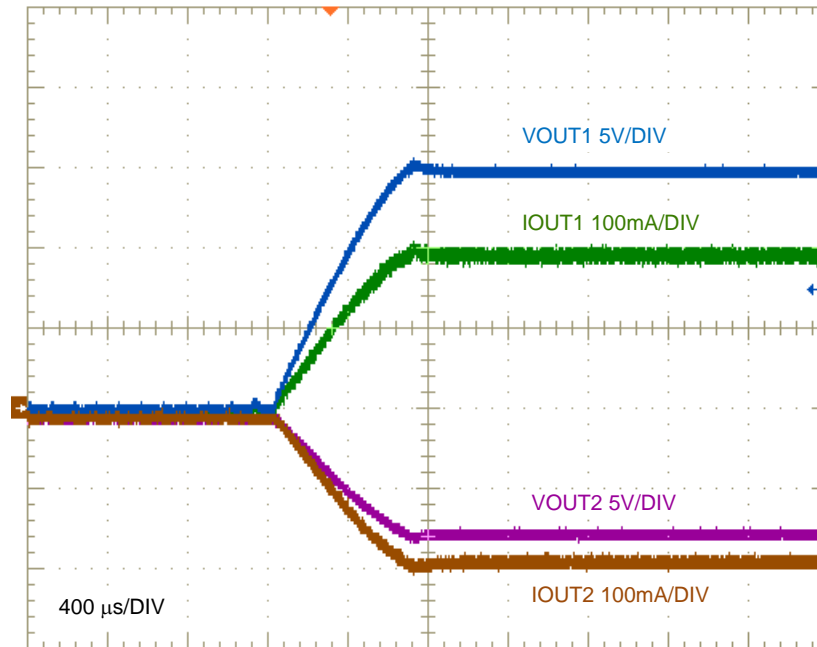
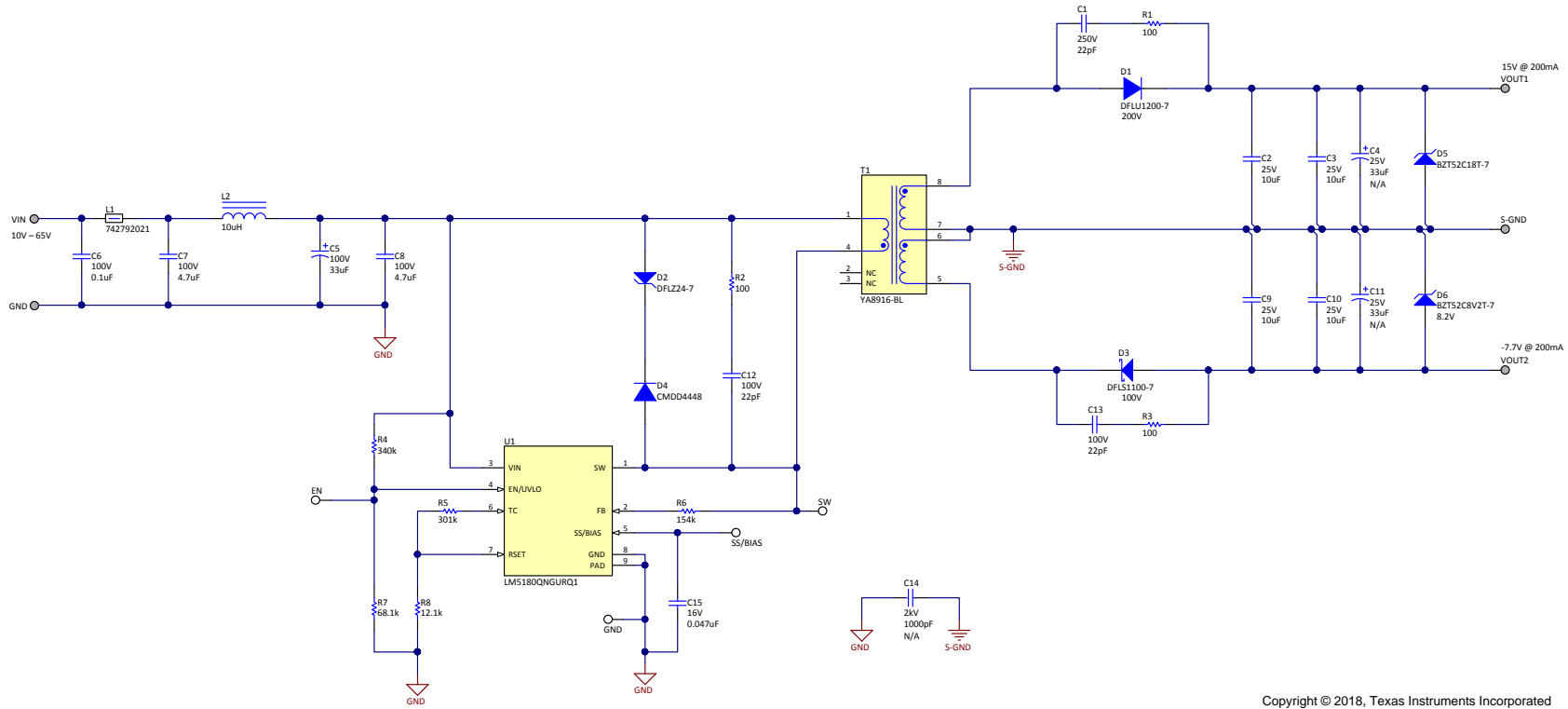

Figure 16. Short Circuit Recovery,  $V_{IN} = 24\text{ V}$ ,  $I_{OUT1} = -I_{OUT2} = 200\text{ mA}$  Resistive

## 7 EVM Documentation

### 7.1 Schematic



Copyright © 2018, Texas Instruments Incorporated

Figure 17. EVM Schematic

## 7.2 Bill of Materials

**Table 3. Bill of Materials**

COUNT	REF DES	DESCRIPTION	PART NUMBER	MFR
1	C1	Capacitor, Ceramic, 22pF, 250V, X7R, 0603	Std	Std
2	C2, C3	Capacitor, Ceramic, 10 $\mu$ F, 25V, X7R, 1206	GRM32ER60J107ME20	Murata
			885012109004	Würth Elektronik
			12106D107KAT2A	AVX
1	C5	Aluminum Electrolytic, 10 $\mu$ F, 100V, $\pm$ 20%	865060845002	Würth Elektronik
		Aluminum Electrolytic, 33 $\mu$ F, 100V, $\pm$ 20%, AEC-Q200 grade 2	EEE-FK2A330P	Panasonic
1	C6	Capacitor, Ceramic, 0.1 $\mu$ F, 100V, X7R, 0603	C1608X7R1A105K080AC	TDK
2	C7, C8	Capacitor, Ceramic, 4.7 $\mu$ F, 100V, X7S, 1210	C3225X7S2A475M200AB	TDK
			GRJ32DC72A475KE11L	Murata
2	C9, C10	Capacitor, Ceramic, 22 $\mu$ F, 16V, X6S, 1206	C3216X6S1C226M160AC	TDK
		Capacitor, Ceramic, 22 $\mu$ F, 16V, X7S, 1206	GRM31CC71C226ME11L	Murata
2	C12, C13	Capacitor, Ceramic, 22pF, 100V, X7R, 0603	Std	Std
1	C14	Capacitor, Ceramic, 1nF, 2kV, X7R, 1206	Std	Std
1	C15	Capacitor, Ceramic, 47nF, 16V, X7R, 0603	Std	Std
1	D1	Switching Diode, 200V, 1A, SOD-123	DFLU1200-7	Diodes Inc.
1	D2	Zener, 24V, 1W, PowerDI-123, AEC-Q101	DFLZ24-7	Diodes Inc.
		Zener, 24V, 1W, SOD-123	DFLZ24-TP	Micro Commercial
1	D3	Schottky Diode, 100V, 1A, SOD-123	DFLS1100-7	Diodes Inc.
1	D4	Switching Diode, 100V, 1A, SOD-323	CMDD4448	Central Semi
1	D5	Zener, 18V, SOD-523	BZT52C18VT-7	Diodes Inc.
1	D6	Zener, 8.2V, SOD-523	BZT52C8V2T-7	Diodes Inc.
1	L1	Ferrite bead, 22 $\Omega$ at 100MHz, 8m $\Omega$ max, 6A	742792021	Würth Elektronik
1	L2	Inductor, 10 $\mu$ H $\pm$ 20%, 150m $\Omega$ max, 1.3A	744042100	Würth Elektronik
1	T1	Flyback transformer, 30 $\mu$ H, 2A, 1 : 1 : 0.52 turns ratio, 9 x 10mm	YA8916-BL	Coilcraft
			750317595	Würth Elektronik
3	R1, R2, R3	Resistor, Chip, 100 $\Omega$ , 1/8W, 5%, 0805	Std	Std
1	R4	Resistor, Chip, 340k $\Omega$ , 1/16W, 1%, 0603	Std	Std
1	R5	Resistor, Chip, 200k $\Omega$ , 1/16W, 1%, 0603	Std	Std
1	R6	Resistor, Chip, 154k $\Omega$ , 1/16W, 1%, 0603	Std	Std
1	R7	Resistor, Chip, 68.1k $\Omega$ , 1/16W, 1%, 0603	Std	Std
1	R8	Resistor, Chip, 12.1k $\Omega$ , 1/16W, 1%, 0603	Std	Std
1	U1	IC, <a href="#">LM5180-Q1</a> , wide $V_{IN}$ PSR flyback converter, WSON-8	LM5180QNGURQ1	TI
1	PCB1	PCB, FR4, 2 layer, 1 oz, 55 mm x 38 mm	PCB	–
5	J1, J2, J3, J4, J5	Turret, PTH, 4.72mm, VIN+, VIN-, VOUT+, VOUT-, SGND	1573-2	Keystone Electronics
4	TP1, TP2, TP3, TP4	Test point for EN, SW, SS/BIAS, GND	5015	Keystone Electronics



### 7.3 PCB Layout

Figure 18 through Figure 21 show the design of the LM5180 2-layer PCB with 1-oz copper thickness. The EVM is a two-sided design with post connections for VIN+, VIN-, VOUT1+, VOUT2+ and SGND.

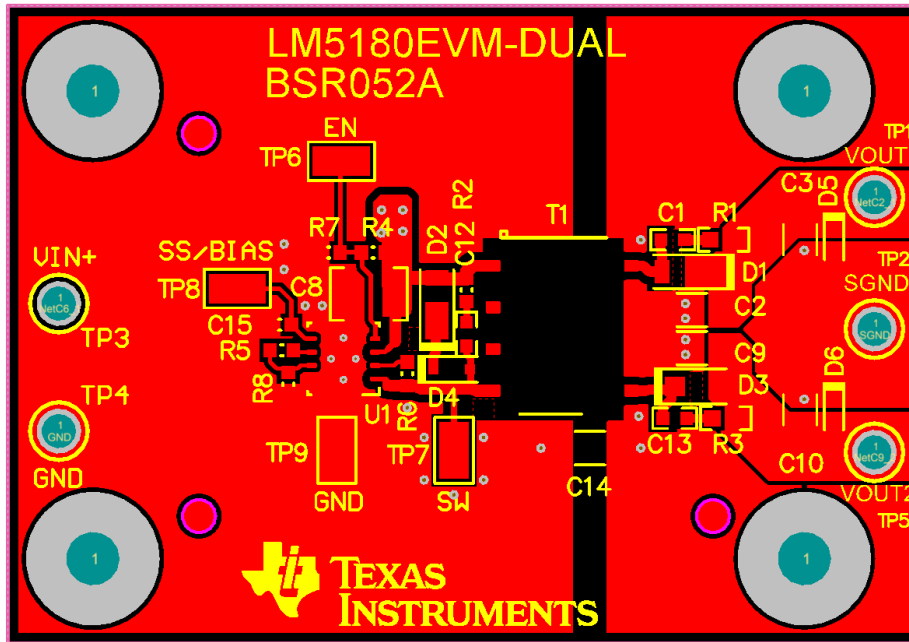

Figure 18. Top Copper (Top View)

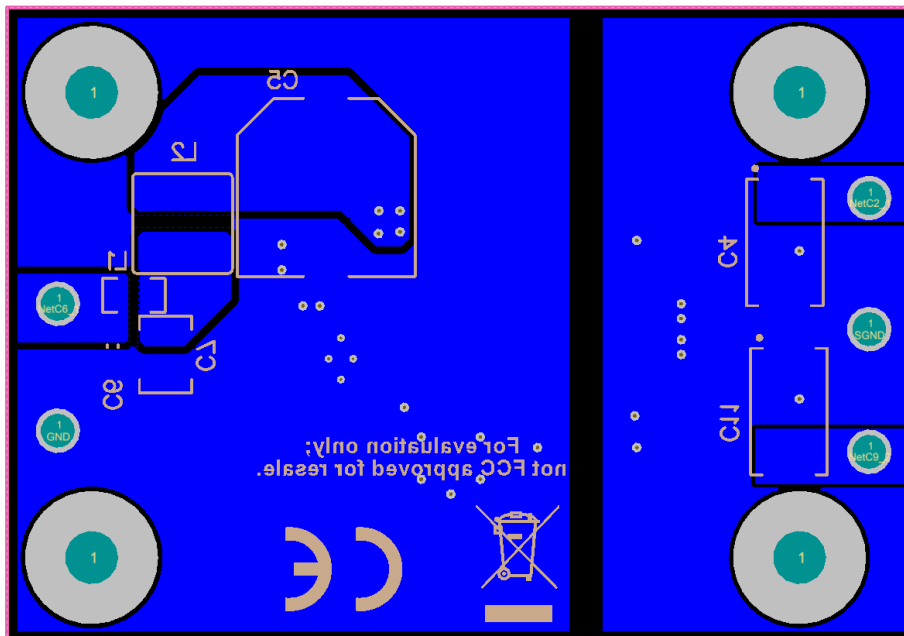

Figure 19. Bottom Copper (Top View)

7.4 Assembly Drawings

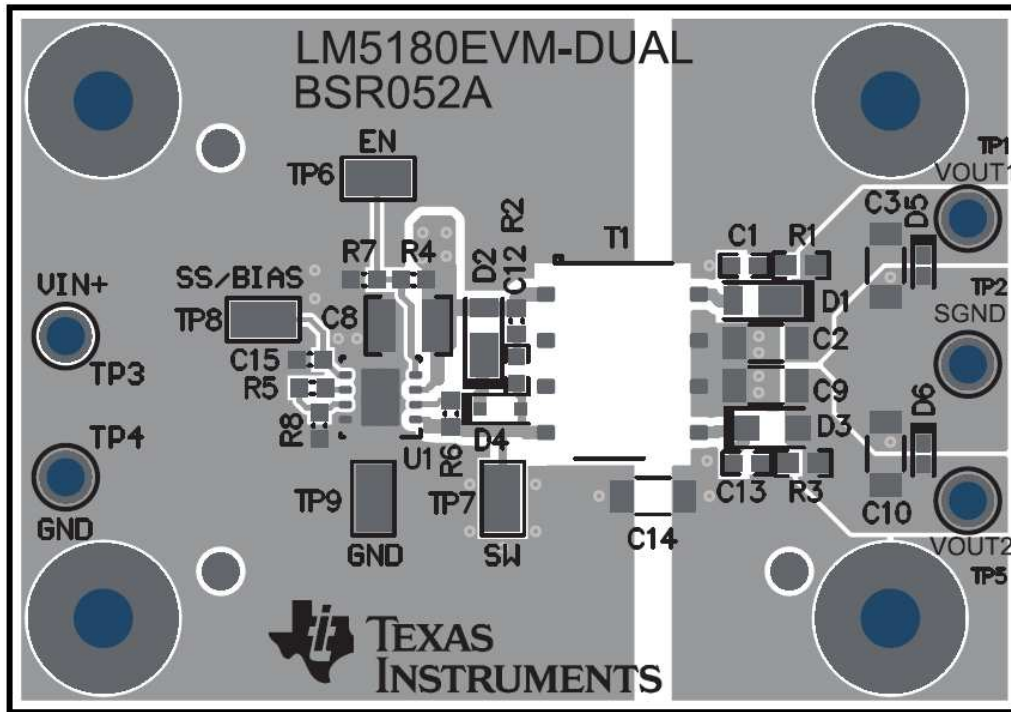

Figure 20. Top Assembly

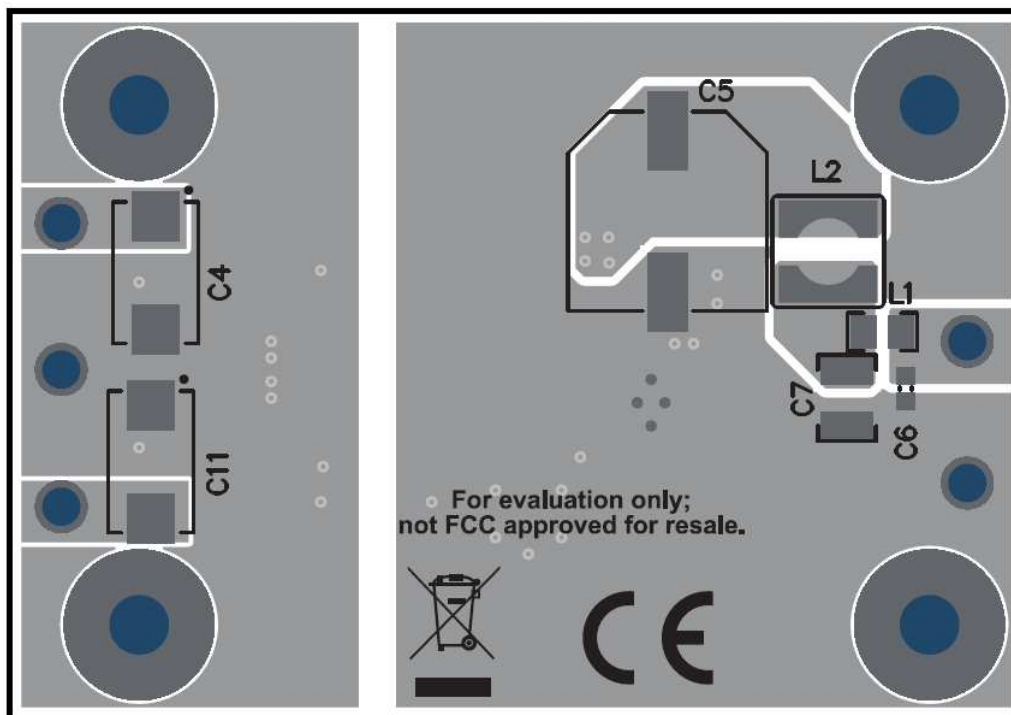

Figure 21. Bottom Assembly

## 8 Device and Documentation Support

### 8.1 Device Support

#### 8.1.1 Development Support

For development support see the following:

- For TI's reference design library, visit [TI Designs](#)
- For TI's WEBENCH Design Environments, visit the [WEBENCH® Design Center](#)
- LM5180 PSR Flyback Converter [Quickstart Calculator](#) and [PSPICE](#) simulation model

### 8.2 Documentation Support

#### 8.2.1 Related Documentation

For related documentation see the following:

- [LM5180EVM-S05 EVM User's Guide](#) (SNVU592)
- [Reduce Buck Converter EMI and Voltage Stress by Minimizing Inductive Parasitics](#) (SLYT682)
- [AN-2162 Simple Success with Conducted EMI from DC-DC Converters](#) (SNVA489)
- White Papers:
  - [Valuing Wide VIN, Low EMI Synchronous Buck Circuits for Cost-driven, Demanding Applications](#) (SLYY104)
  - [An Overview of Conducted EMI Specifications for Power Supplies](#) (SLYY136)
  - [An Overview of Radiated EMI Specifications for Power Supplies](#) (SLYY142)
- [Flyback Transformer Design Considerations for Efficiency and EMI](#) (SLUP338)

##### 8.2.1.1 PCB Layout Resources

- [AN-1149 Layout Guidelines for Switching Power Supplies](#) (SNVA021)
- [AN-1229 Simple Switcher PCB Layout Guidelines](#) (SNVA054)
- [Constructing Your Power Supply – Layout Considerations](#) (SLUP230)
- [Low Radiated EMI Layout Made SIMPLE with LM4360x and LM4600x](#) (SNVA721)
- Power House Blogs:
  - [High-Density PCB Layout of DC-DC Converters](#)

##### 8.2.1.2 Thermal Design Resources

- [AN-2020 Thermal Design by Insight, Not Hindsight](#) (SNVA419)
- [AN-1520 A Guide to Board Layout for Best Thermal Resistance for Exposed Pad Packages](#) (SNVA183)
- [Semiconductor and IC Package Thermal Metrics](#) (SPRA953)
- [Thermal Design Made Simple with LM43603 and LM43602](#) (SNVA719)
- [PowerPAD Thermally Enhanced Package](#) (SLMA002)
- [PowerPAD Made Easy](#) (SLMA004)
- [Using New Thermal Metrics](#) (SBVA025)

## Revision History

NOTE: Page numbers for previous revisions may differ from page numbers in the current version.

Changes from Original (October 2018) to A Revision	Page
• Changed Soft-start time, $t_{ss}$ from "4 ms" to "8 ms" .....	4
• Changed part number for T1 (Würth Elektronik) from "TBD" to "750317595" .....	16

## IMPORTANT NOTICE AND DISCLAIMER

TI PROVIDES TECHNICAL AND RELIABILITY DATA (INCLUDING DATASHEETS), DESIGN RESOURCES (INCLUDING REFERENCE DESIGNS), APPLICATION OR OTHER DESIGN ADVICE, WEB TOOLS, SAFETY INFORMATION, AND OTHER RESOURCES "AS IS" AND WITH ALL FAULTS, AND DISCLAIMS ALL WARRANTIES, EXPRESS AND IMPLIED, INCLUDING WITHOUT LIMITATION ANY IMPLIED WARRANTIES OF MERCHANTABILITY, FITNESS FOR A PARTICULAR PURPOSE OR NON-INFRINGEMENT OF THIRD PARTY INTELLECTUAL PROPERTY RIGHTS.

These resources are intended for skilled developers designing with TI products. You are solely responsible for (1) selecting the appropriate TI products for your application, (2) designing, validating and testing your application, and (3) ensuring your application meets applicable standards, and any other safety, security, or other requirements. These resources are subject to change without notice. TI grants you permission to use these resources only for development of an application that uses the TI products described in the resource. Other reproduction and display of these resources is prohibited. No license is granted to any other TI intellectual property right or to any third party intellectual property right. TI disclaims responsibility for, and you will fully indemnify TI and its representatives against, any claims, damages, costs, losses, and liabilities arising out of your use of these resources.

TI's products are provided subject to TI's Terms of Sale ([www.ti.com/legal/termsofsale.html](http://www.ti.com/legal/termsofsale.html)) or other applicable terms available either on [ti.com](http://ti.com) or provided in conjunction with such TI products. TI's provision of these resources does not expand or otherwise alter TI's applicable warranties or warranty disclaimers for TI products.

Mailing Address: Texas Instruments, Post Office Box 655303, Dallas, Texas 75265  
Copyright © 2019, Texas Instruments Incorporated